

Roof Tutorial

The majority of Roof Tutorial describes some common roof styles that can be created using settings in the **Wall Specification** dialog and can be completed independent of the other tutorials. It also explains how to add gables over doors and windows, how to create dormers automatically and manually, and how to create skylights.

The Adding a Roof to the Stucco Beach House section continues where the House Design Tutorial left off and explains how to add a roof to that plan.

For more information about Roof Tools, see “Roofs” on page 251 of the Reference Manual.

In this tutorial you’ll learn about:

- Getting Started with Automatic Roof Styles
- Hip Roofs
- Gable Roofs
- Dutch Gable Roofs
- Shed Roofs
- Offset Gable Roofs
- Gambrel Roofs
- Gull Wing Roofs
- Half Hip Roofs
- Mansard Roofs
- Roof Style Quick Reference
- Roof Returns
- Adding Gables over Doors and Windows
- Automatic Dormers
- Manually Drawn Dormers
- Skylights
- Using the Break Edit Tool to Modify Roofs
- Adding a Roof to the Stucco Beach House
- Troubleshooting Roof Issues

Getting Started with Automatic Roof Styles

This tutorial uses a simple, rectangular structure to explain how to create common roof styles using roof style directives assigned to the exterior walls.

To begin a new plan

1. If any plans are open, select **File> Close All** from the menu.
2. Select **File> New Plan**  to open a new plan. In the **Create New Plan** dialog, select the Default Style template.

3. Select **Build> Wall> Straight Exterior Wall**  and draw a rectangular floor plan, measuring about 34 feet by 24 feet (approximately 10.4 m by 7.3 m), in a clockwise direction. See “Creating Walls” on page 113 of the Reference Manual.

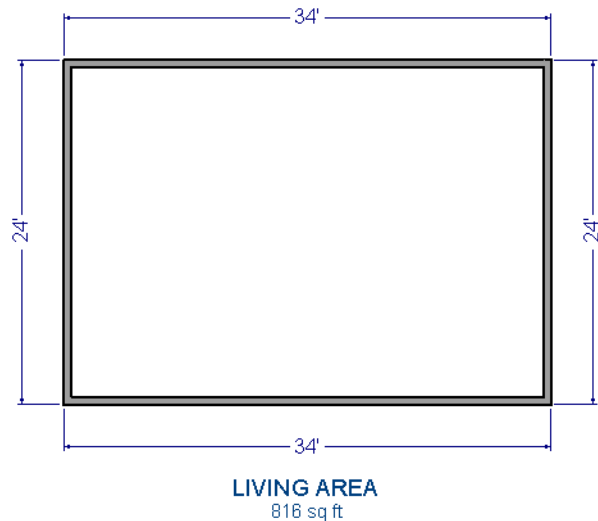

4. Select **3D> Create Camera View> Perspective Full Overview**  to create a 3D overview of the house.
 - If you wish, you can select **3D> Toggle Textures**  from the menu to turn off the display of material textures and represent all materials using solid colors.
5. Select **Window> Tile Vertically**  to see both views at the same time.

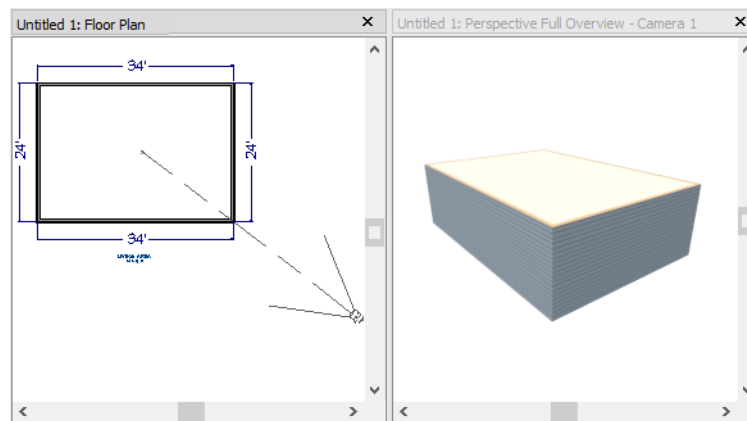

Roof Style Directives in Walls

By default, the program will generate a roof plane bearing on each exterior wall that does not have a room-defining wall directly above it, and will use the pitch specified in the **Build Roof** dialog. The result is a hip style roof; however, if you need a different condition over a particular wall to produce another roof style, you can define it in that wall’s specification dialog.

Individual walls can be selected and edited in both 2D and 3D views. When multiple walls are to be edited, however, it is usually quicker and easier to work in plan view. See “Editing Walls” on page 117 of the Reference Manual.

To set a wall’s roof directives

1. Click the **Select Objects**  button, then click on a wall to select it.

2. Click the **Open Object**  button to open the **Wall Specification** dialog.
3. On the ROOF panel:
 - The **Roof Options** control how the roof builds over the selected wall.
 - The **Pitch Options** control how steep the roof that bears on the selected wall is.

To reset all roof directives

1. Select **Edit> Reset to Defaults**.
2. In the **Reset to Defaults** dialog, set the Reset Scope to **All Floors**, check **Roof Directives in Walls**, and click **OK**.

Attic Walls

When a roof is generated, attic walls may also be generated. An Attic wall fills the space between the walls that define a room and the roof above. The triangular-shaped wall of a gable, for example, is created using an Attic wall.



If you do not want to see attic walls in plan view, you can turn off their display.

To turn off the display of attic walls

1. In plan view, select **Tools> Display Options**  (or press the ~ key) to open the **Display Options** dialog.
2. Find "Walls, Attic" in the Name column, remove the check from the Display column for this item, and click **OK**. For more information, see "Display Options Dialog" on page 72 of the Reference Manual.

Deleting Roofs

Roof planes can be easily deleted in either of two ways:

- Select **Build> Roof> Delete Roof** .
- Select **Edit> Delete Objects**  and in the **Delete Objects** dialog, select either **All Rooms On This Floor** or **All Floors**; place a check beside **Roof**; and click **OK** to delete all roof planes either on the current floor or in the plan.

If a warning message states that roofs cannot be deleted while **Auto Rebuild Roof** is on, click the **Yes** button to turn off **Auto Rebuild Roof** and delete the roof.

Auto Rebuild Roofs

Auto Rebuild Roofs is a convenient feature in Home Designer Suite that automatically rebuilds the roof in a plan whenever the exterior walls or floor/ceiling heights are changed. Auto Rebuild Roofs is turned on by default, but this tutorial is presented with this feature disabled; however the information presented here also applies when it is enabled.

To turn on/off Auto Rebuild Roofs

1. Select **Build> Roof> Build Roof**  from the menu.
2. In the **Build Roof** dialog, check or uncheck **Auto Rebuild Roofs** and click **OK**.

Hip Roofs

When roofs are automatically generated, a roof plane is built over every exterior wall in the plan that does not have another wall drawn above it. The result is referred to as a hip roof.

To create a hip roof



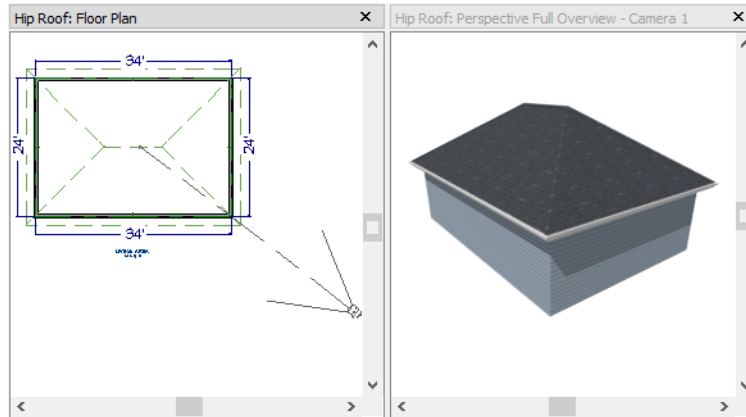

1. Begin with the basic rectangular structure described in “Getting Started with Automatic Roof Styles” on page 1.
2. Select **Build> Roof> Build Roof**  from the menu to open the **Build Roof** dialog.
3. Click **OK** to generate a hip roof.



Gable Roofs

If you would like a gable over a particular wall rather than a roof plane bearing on it, you can specify it as a **Full Gable Wall** in the **Wall Specification** dialog. To create basic gable roof, two walls should be specified as **Full Gable Wall**.

To create a gable roof

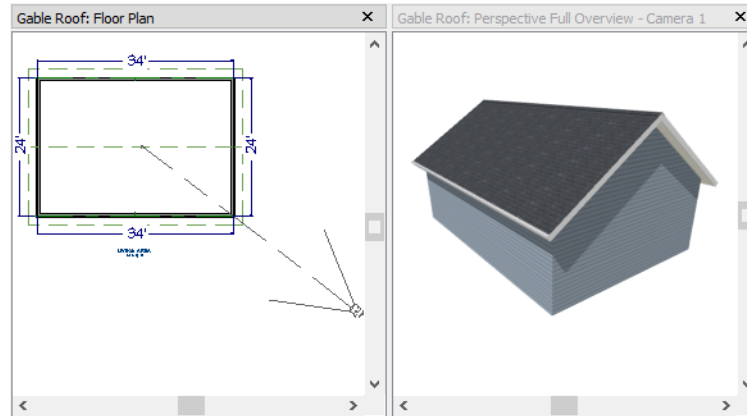

1. Begin with the basic rectangular structure described in “Getting Started with Automatic Roof Styles” on page 1.
2. Use the **Select Objects**  tool to select one of the walls drawn vertically on screen.
3. Open the **Wall Specification** dialog and on the **ROOF** panel, check **Full Gable Wall** and click **OK**. See “To set a wall’s roof directives” on page 2.
 - Alternatively, you can click the **Change to Gable Wall(s)**  edit button.
 - To remove the Full Gable Wall attribute from a selected wall, click the **Change to Hip Wall(s)**  edit button.
4. Make the same changes to the other vertically-drawn wall.
5. Select **Build> Roof> Build Roof**  to open the **Build Roof** dialog and click **OK**.



Dutch Gable Roofs

A Dutch gable, sometimes called a Dutch hip, is a combination of hip and gable roof styles in which a gable is located at the end of the ridge, at the top of a hip roof plane.

To create a Dutch gable roof

1. Begin with the basic rectangular structure described in “To begin a new plan” on page 1.
2. Use the **Select Objects**  tool to select one of the walls drawn vertically on screen.
3. Open the **Wall Specification** dialog and on the **ROOF** panel, change the following settings:
 - Check the box beside **Dutch Gable Roof**.
 - Specify the **Starts at Height** as 180".
4. Click **OK** to close the **Wall Specification** dialog. See “To set a wall’s roof directives” on page 2.
5. Make the same changes to the other vertically-drawn wall.
6. Select **Build > Roof > Build Roof**  to open the **Build Roof** dialog and click **OK**.

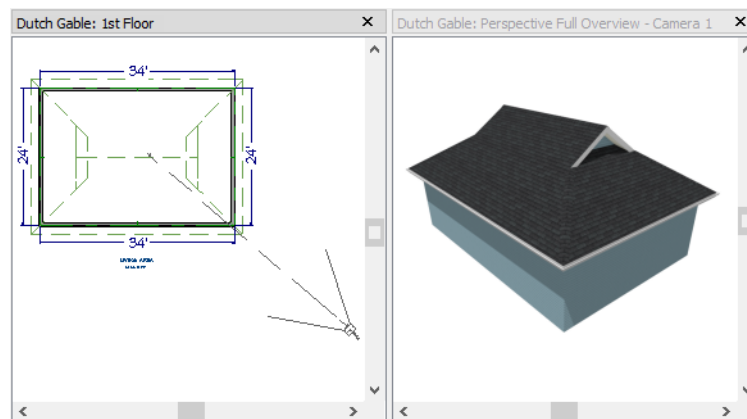

Shed Roofs

To create a single, sloping roof plane, or shed roof, two walls must be specified as **Full Gable Walls**, and one must be a **High Shed/Gable Wall**.

To create a shed roof

1. Begin with the basic rectangular structure described in “Getting Started with Automatic Roof Styles” on page 1.
2. As in the Gable Roofs example, specify the left and right vertical walls as **Full Gable Walls**.
3. Select the lower horizontal wall and open its **Wall Specification** dialog. On the ROOF panel, check **High Shed/Gable Wall** and click **OK**. See “To set a wall’s roof directives” on page 2.
4. Select **Build> Roof> Build Roof**  to open the **Build Roof** dialog, specify a **Pitch** of 2 in 12, and click **OK**.

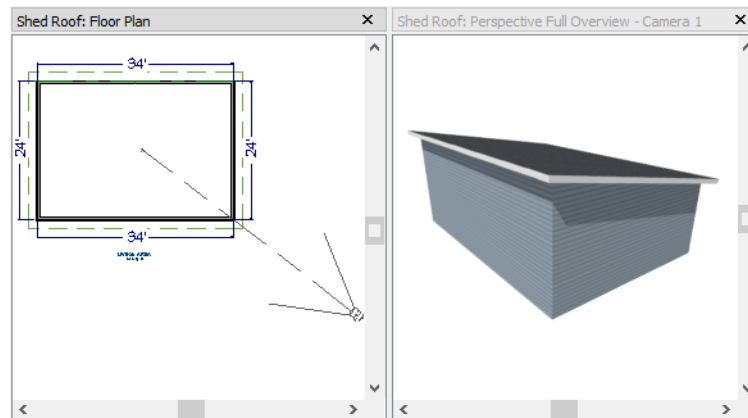

Offset Gable Roofs

An offset gable is a type of gable roof with different pitches on each of the two roof planes and a ridge that is offset from the building’s center line. Assign a different pitch to the two roof planes in the **Wall Specification** dialog for the wall supporting each one.

To create an offset gable roof

1. Begin with the basic rectangular structure described in “To begin a new plan” on page 1.
2. As in the Gable Roofs example, specify the left and right vertical walls as **Full Gable Walls**.
3. Select the lower horizontal wall and open its **Wall Specification** dialog. On the ROOF panel, leave the **Roof Options** unchecked and change the **Pitch** to 12 in 12. See “To set a wall’s roof directives” on page 2.
4. Select **Build> Roof> Build Roof**  to open the **Build Roof** dialog, specify the **Pitch** as 2 in 12, and click **OK**.

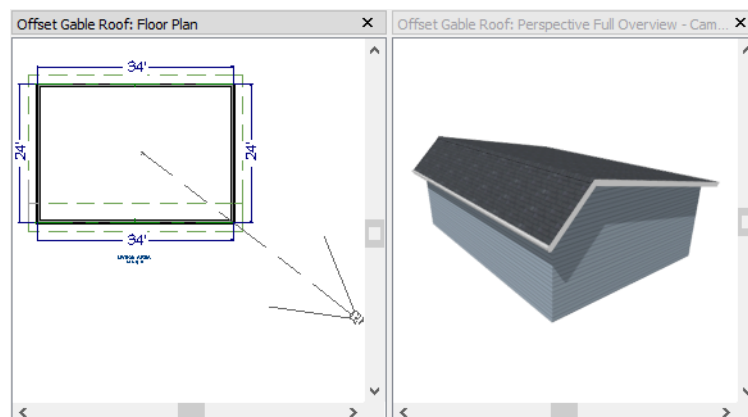

Gambrel Roofs

A gambrel or barn style roof has two pitches on each side of the ridge. The first (lower) pitch on either side is steeper than the pitch near the ridge.

To create a gambrel roof

1. Begin with the basic rectangular structure described in “Getting Started with Automatic Roof Styles” on page 1.
2. As in the Gable Roofs example, specify the left and right vertical walls as **Full Gable Walls**.
3. Use the **Select Objects**  tool to select one of the walls drawn horizontally on screen.
4. Open the **Wall Specification** dialog and on the ROOF panel, change the following settings:
 - Make sure that the **Pitch** value is followed by (D), which means that is set to use the default.
 - Check the box beside **Upper Pitch**.
 - Specify the **Upper Pitch** as 6 in 12 and the **Start Height** as 156".
5. Click **OK** to close the **Wall Specification** dialog. See “To set a wall’s roof directives” on page 2.
6. Make the same changes to the other horizontally-drawn wall.
7. Open the **Build Roof** dialog, specify the **Pitch** as 12 in 12, and click **OK**.

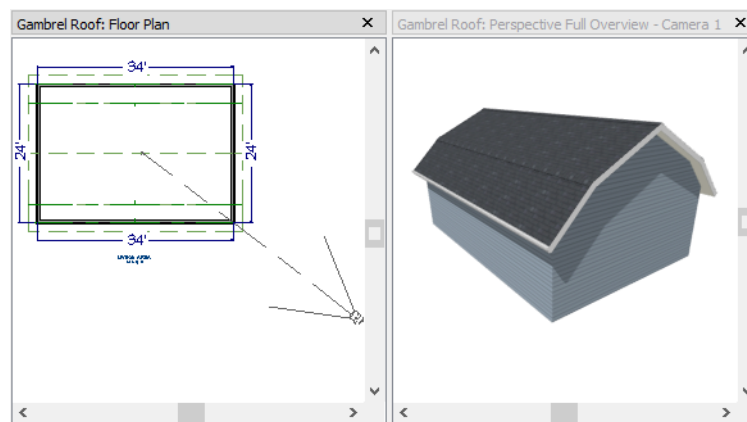



Experiment with alternate pitches and overhangs. Also, try varying the height at which the second pitch begins so that you can see the effect it has on the gambrel roof design.

Gull Wing Roofs

A gull wing roof has two pitches on either side of the ridge, as a gambrel does; but the first pitch of a gull wing is shallower than the steeper upper pitch.

To create a gull wing roof

1. Begin with the basic rectangular structure described in “Getting Started with Automatic Roof Styles” on page 1.
2. As in the Gable Roofs example, specify the left and right vertical walls as **Full Gable Walls**.
3. Use the **Select Objects**  tool to select one of the walls drawn horizontally on screen.
4. Open the **Wall Specification** dialog and on the ROOF panel, and change the following settings:
 - Make sure that the **Pitch** value is followed by (D), which means that is set to use the default.
 - Place a check in the box beside **Upper Pitch**.
 - Keep the **Upper Pitch** as 12 in 12 and change the **Start Height** to 125".

5. Click **OK** to close the dialog. See “To set a wall’s roof directives” on page 2.
6. Make the same changes to the other horizontally-drawn wall.
7. Click the **Build Roof**  tool, specify a **Pitch** of 3 in 12, and click **OK** in the **Build Roof** dialog.

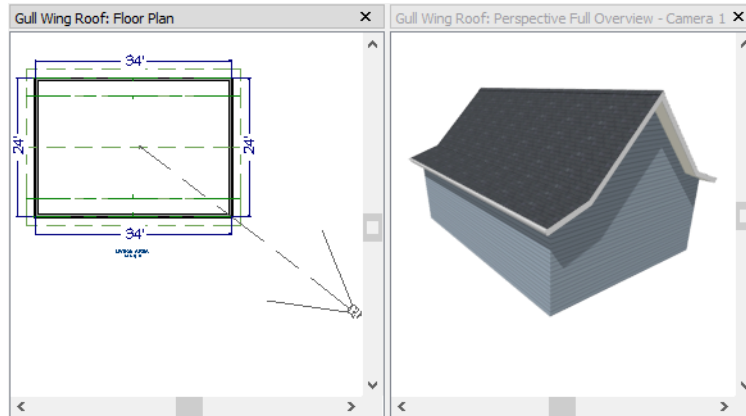

Experiment with the height at which the second pitch begins so that you can see the effect it has on the gull wing roof design.

Half Hip Roofs

A half hip roof has two gable ends. At the top of each gable is a small hip that extends to the ridge.

To create a half hip roof

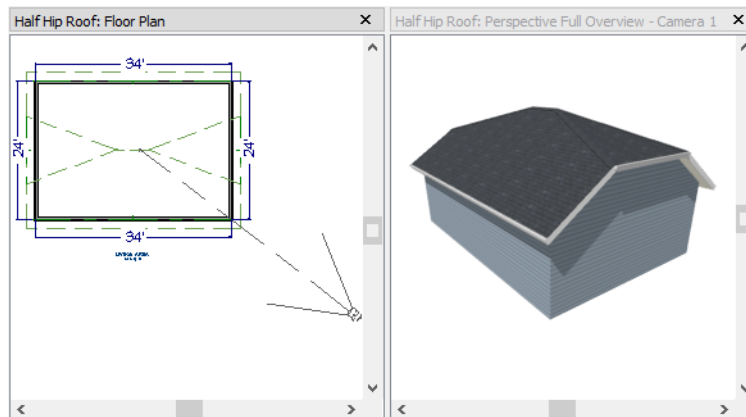

1. Begin with the basic rectangular structure described in “Getting Started with Automatic Roof Styles” on page 1.
2. As in the Gable Roofs example, specify the left and right vertical walls as **Full Gable Walls**. In addition, change the following **Pitch Option** settings:
 - Check the box beside **Upper Pitch**.
 - Specify the **Upper Pitch** as 3 in 12 and set the **Start Height** at 170”.
3. Click the **Build Roof**  tool and click **OK** in the **Build Roof** dialog.



Mansard Roofs

A mansard roof is a hip roof with two pitches on the roof sections above each exterior walls: an extremely steep lower pitch and a gently sloping upper pitch.

To create a mansard roof

1. Begin with the basic rectangular structure described in “Getting Started with Automatic Roof Styles” on page 1.
2. Use the **Select Objects**  tool to select one of the walls.
3. Open the **Wall Specification** dialog and on the ROOF panel, and change the following settings:
 - Check the box beside **Upper Pitch**.
 - Specify the **Upper Pitch** as 1.5 in 12 and the **Start Height** as 132”.
4. Click **OK** to close the dialog. See “To set a wall’s roof directives” on page 2.
5. Make the same changes to each of the exterior walls.
6. Click the **Build Roof**  tool, specify a **Pitch** of 24 in 12, and click **OK** in the **Build Roof** dialog.

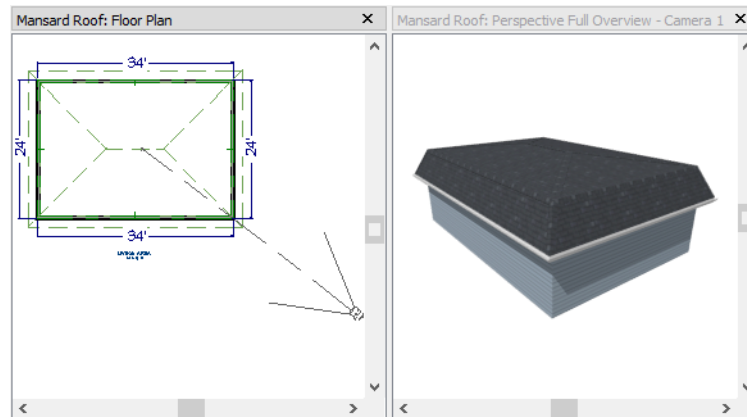

Roof Style Quick Reference

The following chart provides a quick reference for building the roof styles described in this tutorial. The chart shows which walls to change and what to change on the ROOF panel of the **Wall Specification** dialog for each wall. These parameters are based on a 34x24-foot model. For different size plans, adjust these numbers.

Roof Type	Wall to Change	Set as Full Gable	Set as High Shed Gable	Lower Pitch	Upper Pitch	Start Height
Gable Roof	Vertical Wall 1					
	Vertical Wall 2					
	Horizontal Wall 1	X				
	Horizontal Wall 2	X				
Shed Roof	Vertical Wall 1	X				
	Vertical Wall 2	X				
	Horizontal Wall 1		X			
	Horizontal Wall 2					
Offset Gable Roof	Vertical Wall 1	X				
	Vertical Wall 2	X				
	Horizontal Wall 1			12 in 12		
	Horizontal Wall 2			3 in 12		
Gambrel Roof	Vertical Wall 1	X				
	Vertical Wall 2	X				
	Horizontal Wall 1			12 in 12	6 in 12	156
	Horizontal Wall 2			12 in 12	6 in 12	156
Gull Wing Roof	Vertical Wall 1	X				
	Vertical Wall 2	X				
	Horizontal Wall 1			3 in 12	12 in 12	125
	Horizontal Wall 2			3 in 12	12 in 12	125
Half Hip Roof	Vertical Wall 1	X			3 in 12	170
	Vertical Wall 2	X			3 in 12	170
	Horizontal Wall 1			6 in 12		
	Horizontal Wall 2			6 in 12		
Mansard Roof	Vertical Wall 1			12 in 12	1.5 in 12	132
	Vertical Wall 2			12 in 12	1.5 in 12	132
	Horizontal Wall 1			12 in 12	1.5 in 12	132
	Horizontal Wall 2			12 in 12	1.5 in 12	132

Roof Returns

A roof return is a small decorative roof plane that connects to the low side of a gable roof overhang and extends below the upper triangular portion of the gable wall. While you can build these manually, the following pictures illustrate the three styles of roof returns that can be produced automatically in Home Designer Suite.

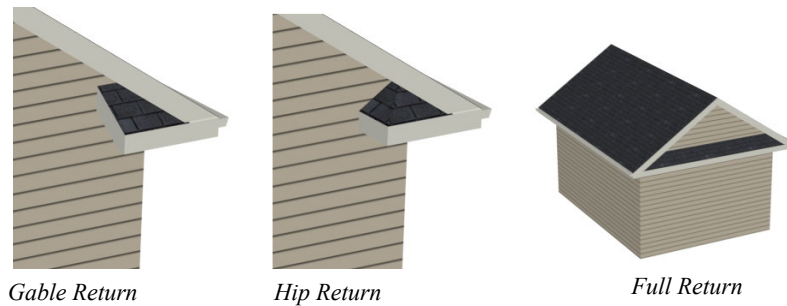

The first two are called **Gable** and **Hip** returns, since the returns themselves end in either a gable or a hip. The third is called a **Full** return because it extends under the entire gable, connecting both sides. Full roof returns are sometimes referred to as water tables.

The Auto Roof Return settings are found on the ROOF panel of the **Wall Specification** dialog. Roof returns can be specified for any wall, but they will only generate on **Full Gable Walls**.

Auto Roof Return

Length:

Extend:

Roof Type: Gable Hip Full



Slope: Sloping Flat

Specify the horizontal **Length** of the returns in inches; the distance to **Extend** the returns past the main roof overhang; the style of roof return; and whether the returns are sloping or flat. As long as your model has a roof, the specified roof returns will be generated when you click **OK**. For more information, see “Roof Returns” on page 260 of the Reference Manual.



Adding Gables over Doors and Windows

You can add a gable roof over a door or window.



To create a gable roof over a door or window

1. Select a door or window, then click the **Gable Over Door/Window**  edit button.
2. Click the **Build Roof**  tool and click **OK** in the **Build Roof** dialog.
3. A gable is created with an overhang of one foot on each side of the door or window.

To remove a gable roof over a door or window

1. Select the door or window and click the **Delete Gable Over Opening**  edit button.
2. Click the **Build Roof**  tool and click **OK** in the **Build Roof** dialog.
3. When you rebuild the roof, the gable will be removed.

To create a gable over several doors and/or windows

1. Select a door, window, or mullied unit.
2. Hold down the Shift key and click on additional doors and/or windows to add them to your selection set.
3. Click the **Gable Over Door/Window**  edit button.
4. Click the **Build Roof**  tool and click **OK** in the **Build Roof** dialog to create a gable over the selected wall openings.



Automatic Dormers

The **Dormer**  tool offers a quick and convenient alternative to drawing dormers manually. With just a few clicks an entire dormer is placed, complete with roof, roof hole, walls, and window.

There is a limit to how low the roof pitch can be set when creating dormers. Generally, 9 in 12 is the lowest pitch that will provide enough elevation to contain a dormer.

A **Dormer**  can be placed anywhere within a roof plane, as long as there is enough space to contain it.

Select **Build> Roof> Dormer**  and click within an existing roof plane to place a floating dormer at that location. Once a dormer is created, it can be moved, resized and opened for specification. For more information, see “Editing Auto Dormers” on page 258 of the Reference Manual.







A Dormer cannot initially be placed so that its walls align with an exterior wall. Once it is created, its front wall can often be aligned with an exterior wall below; however, its side walls must remain inside the exterior walls.

Manually Drawn Dormers



To create dormers in an upper floor, create a new floor for your plan and modify this floor with knee walls and windows to form gables. This example starts with a new 40 x 30 foot plan.

As with automatic dormers, roof pitches of 9 in 12 or greater generally work better than shallow pitches when creating dormers because they provide enough vertical space to build the dormer within.

To create a new plan

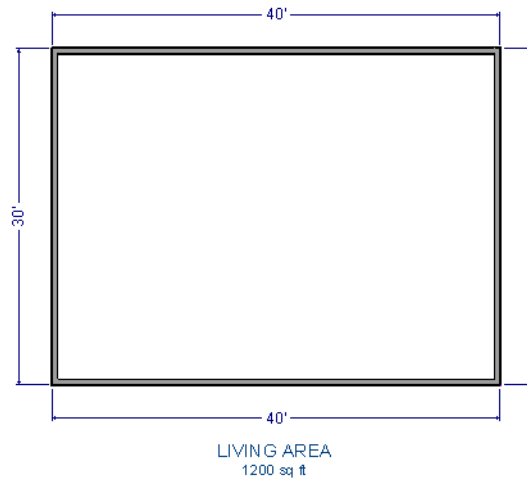
1. Select **File> Close All** from the menu to close any open plans.
2. Select **File> New Plan**  to open a new plan. In the **Create New Plan** dialog, select the Default Style template.
3. Select **File> Save**  from the menu, save the file to an easy to find location, such as Documents, and give the plan a short, descriptive name like Dormer Tutorial.
4. Select **Build> Wall> Straight Exterior Wall**  and draw a rectangular floor plan, 40 feet by 30 feet, in a clockwise direction.
5. Click the **Fill Window Building Only**  button to zoom in on the house.





6. As in the Gable Roofs example, specify the left and right vertical walls as **Full Gable Walls**. See “To set a wall’s roof directives” on page 2.
7. Select **Build> Floor> Build New Floor** .
8. Choose the **Derive new 2nd floor plan from 1st floor plan** option in the **New Floor** dialog and click **OK**. In the Floor 2 Defaults dialog, which opens next, click **OK** without making any changes.
9. Select **Build> Roof> Build Roof**  to open the **Build Roof** dialog. On the **ROOF** panel, change the **Pitch** to 12 in 12, and click **OK**.

To create two knee walls

A knee wall is a short wall on an upper floor that is cut off by a roof plane rather than building up to full ceiling height. They are often used to separate loft areas from attic space.

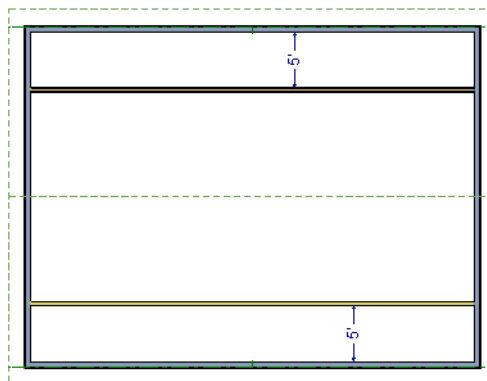
1. Select **Build> Wall> Straight Interior Wall**  and draw a horizontal interior wall from left to right. Position this knee wall so that it is 5 feet from the top exterior wall.
2. Draw another horizontal interior wall and position it 5 feet from the bottom exterior wall. You can reposition the knee walls using dimensions. For more information, see “Moving Objects Using Dimensions” on page 152 of the Reference Manual.



3. Select each of the interior walls one at a time and click the **Open Object**  edit button. Check the box beside **Knee Wall** on the **ROOF** panel of the **Wall Specification** dialog and click **OK**.

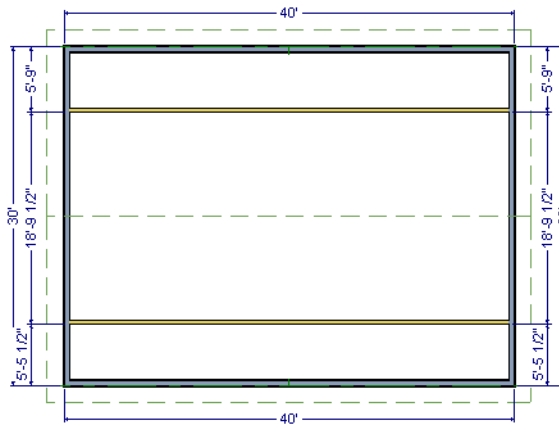

4. Select **CAD> Dimensions> Automatic Exterior Dimensions**  to create exterior dimension lines for your plan, which should now look like this:



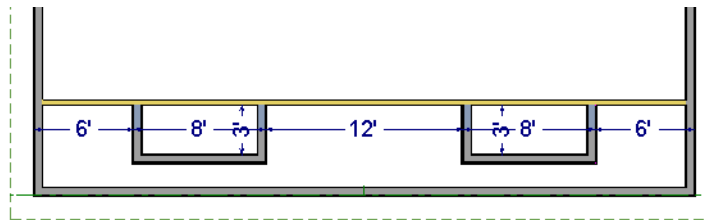

To draw the dormer walls and windows

1. Select **Build> Wall> Straight Exterior Wall**  and draw two rectangular boxes on the outside of the lower knee wall, as shown in the following image.



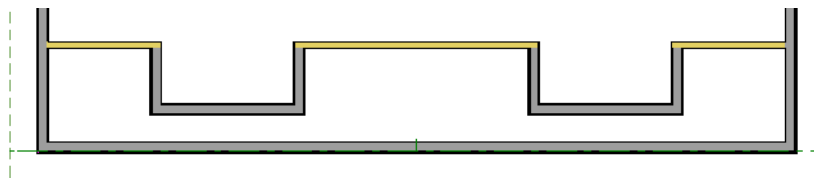

2. Position the front walls of each dormer box 2 feet from the bottom exterior wall. The front dormer walls are those parallel to the bottom wall.
3. Use dimension lines to position the dormer side walls so that the dormers are 6 feet from each vertical exterior wall and 8 feet wide.
4. Click on the lower knee wall to select it, then:
 - Click the **Break**  edit button.
 - Click the **Sticky Mode**  edit button.
 - Click on the lower knee wall at the point where it intersects each of the dormer side walls to divide the wall into separate segments at those points.
5. Click the **Select Objects**  button, then select and delete the segments of the knee wall located behind the dormers, as in the following image:





6. Select **Build> Window> Window**  and click on each dormer front wall to place a window.

- When **Object Snaps** are enabled, a "sticky point" will exist at the midpoint of the dormer front wall when you move your mouse along the front wall. For more information, see "Object Snaps" on page 66 of the Reference Manual.
- You can also use the **Center Object**  edit button to center each window along the wall after it has been placed. See "Using Center Object" on page 92 of the Reference Manual.

To build the roof

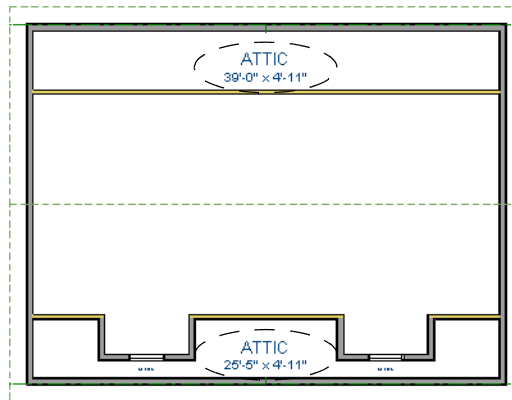
1. Select the two dormer front walls with windows and open their **Wall Specification** dialog. On the **ROOF** panel, check **Full Gable Wall** and click **OK**.
2. Select the four dormer side walls and open their **Wall Specification** dialog. On the **ROOF** panel, confirm that **Pitch** is 12 in 12, and click **OK**.
 - Earlier, a pitch of 12 in 12 was specified in the **Build Roof** dialog; that pitch will be in use here by default and will work well for these dormers.
1. Click the **Select Objects**  button, then click in the narrow room between the top knee wall and the top exterior wall to select it.
2. Click the **Open Object**  edit button to open the **Room Specification** dialog. On the **GENERAL** panel, select "Attic" as the **Room Type** and click **OK**.
3. Do the same for the lower attic room.



4. Select **Build> Roof> Build Roof**  from the menu.
5. In the **Build Roof** dialog, click **OK** to rebuild the roof.
6. Select **3D> Create Camera View> Perspective Full Overview**  to create a 3D overview of the house and see the results.

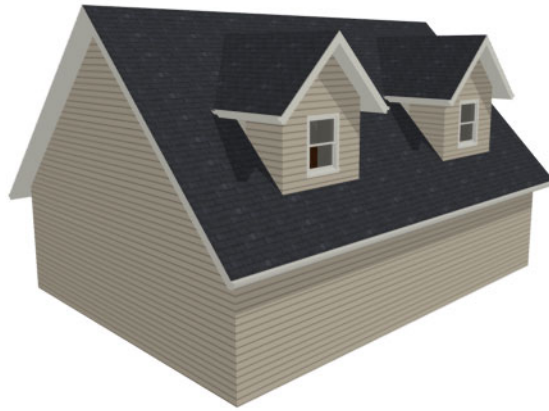

7. Notice that there are small gaps in the dormer side walls. This gap is caused by the difference between the position of the knee walls and the point at which the ceiling intersects the roof plane. This location is marked by the black dotted Ceiling Break Line in plan view.

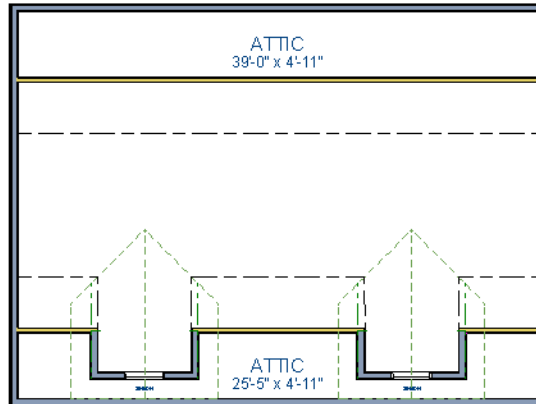

8. Select each of the knee walls and move them back so that they are in alignment with the ceiling plane. When **Object Snaps** are enabled, the walls will snap into position when they are close to the Ceiling Break Lines.

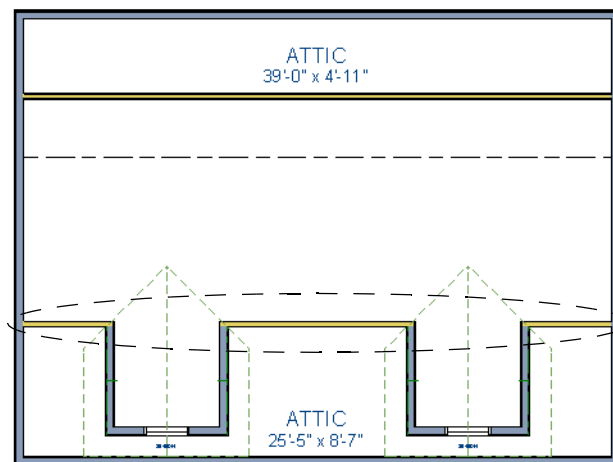

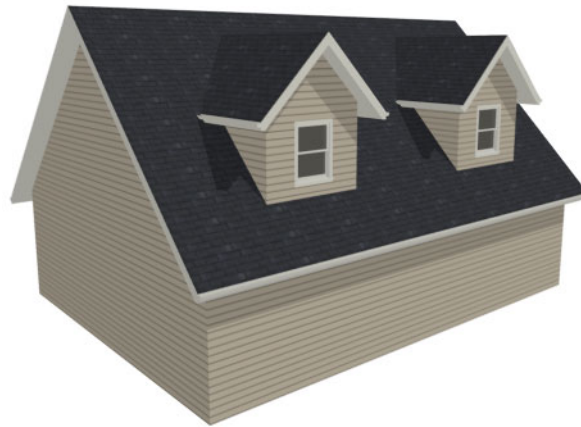

9. Create a 3D view to see how the roof and dormers look now.



You can move the interior walls closer to or further from the outside walls to change the dormers' elevation, or change the pitch for the roof to make the dormers longer. You can create dormers in more complex plans the same way, but you may want to experiment with wall placement and pitch to achieve the desired effect.

Skylights

Skylights can easily be added using the **Skylight**  tool. In plan view, select **Build> Roof> Skylight**  then click and drag a rectangular shape within an existing roof plane. When you release the mouse button, a skylight is created and can be repositioned and resized using its edit handles. For more information, see “Skylights” on page 255 of the Reference Manual.

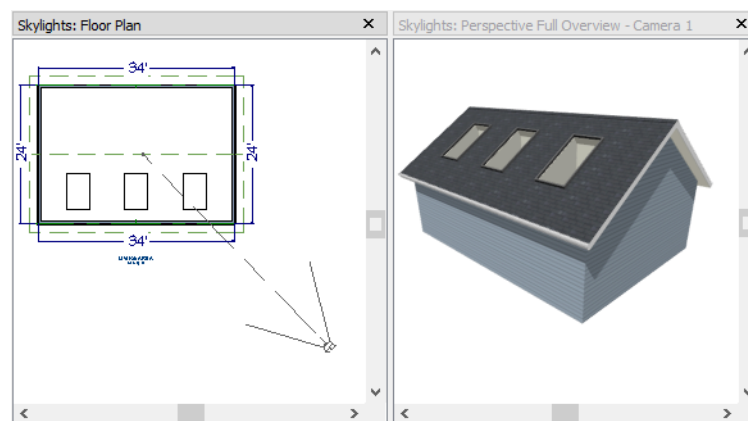

Using the Break Edit Tool to Modify Roofs

Many homes have more than one roof type built above a single exterior wall. One common example is a reverse gable roof, created when a house has gable walls that are perpendicular to one another, as in an L-shaped home.

We can create a reverse gable roof on an L-shaped home using the **Break**  edit tool.

To create an L-shaped home

1. Select **File> Close All** from the menu.

2. Select **File > New Plan**  to open a new plan. In the **Create New Plan** dialog, select the Default Style template.
3. Draw an L-shaped house with the following dimensions:
 - Left wall - 30 feet long
 - Upper wall - 45 feet long.
 - Right wall 18 feet long.
 - Lower wall extending left from the right wall - 25 feet long.
 - Vertical wall connecting two lower walls - 12 feet long.
 - Lower wall extending right from the left wall - 20 feet long.
4. If desired, turn off **Auto Rebuild Roof** and delete the roof.

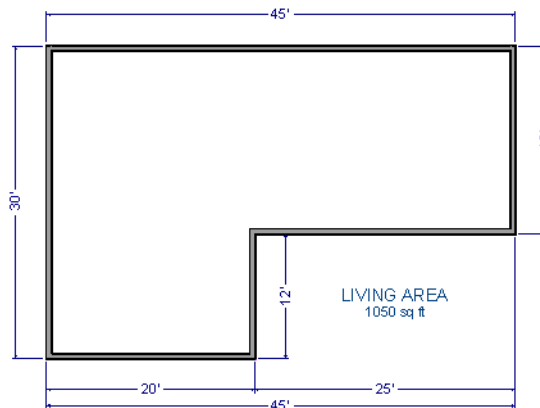

To create a reverse gable in this plan, three gable walls are required: two running vertically and one horizontally.

To add a gable roof to the plan

1. Check **Full Gable Wall** on the ROOF panel of the **Wall Specification** dialog for these three walls:
 - The far left vertical wall
 - The far right vertical wall
 - The bottom left horizontal wall
2. Click the **Build Roof**  button to open the **Build Roof** dialog and click **OK** to build the roof. The roof will look like this:

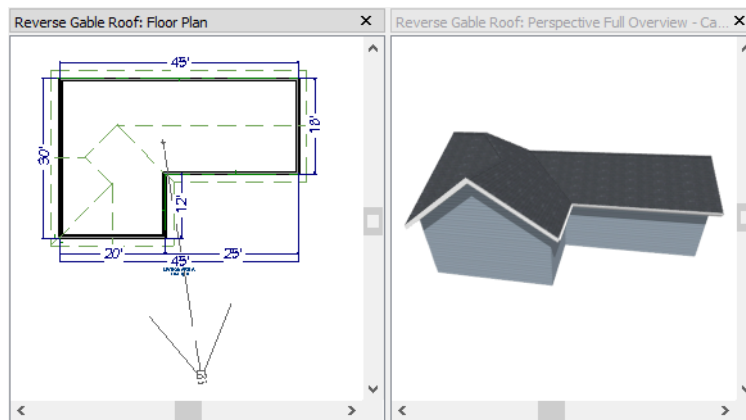

The gable wall on the left produces roof planes that extend too high and interfere with the roof over the front extension of the house. To avoid this, use the Break edit tool to divide the left wall into two different sections. The upper section can then be specified as a Full Gable without affecting the lower section.

To use the Break edit tool

1. Select the vertical wall on the left side of the building, then click the **Break**  edit button and click on this wall at a point even with the lower right wall.
 - An easy way to do this is to temporarily stretch the lower right wall across to the left wall;
 - Place a wall break where the walls meet;
 - Then return the lower right wall to its correct position.

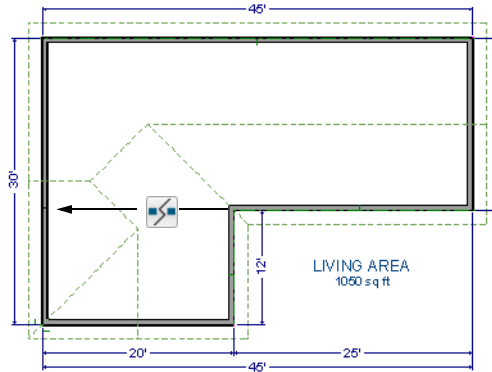

2. Open the lower portion of the wall for specification and on the **ROOF** panel of the **Wall Specification** dialog, clear the **Full Gable Wall** checkbox and click **OK**.
3. Click the **Build Roof**  button and click **OK** to build a roof based on the new wall specifications.

You now have two full gable roof sections meeting to form your L-shaped roof. Your plan should look like the following image:

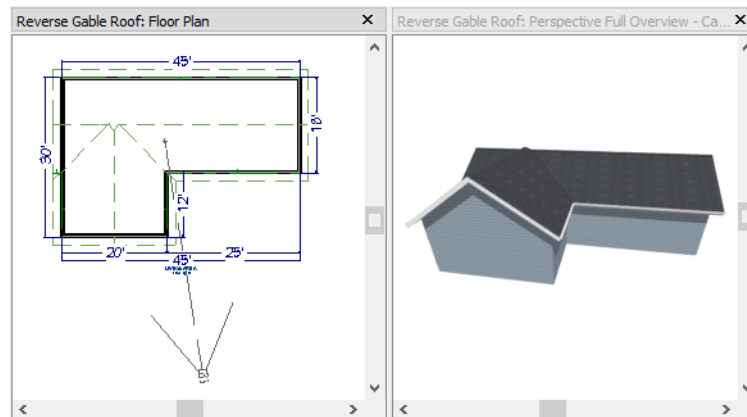

Notice the step in the ridge line. This can be corrected by resizing the lower gable wall. Select the vertical wall to the right of the bottom gable wall and move it to the left 2 feet, reducing the length of the gable wall from 20 to 18 feet. When you are finished, rebuild the roof.

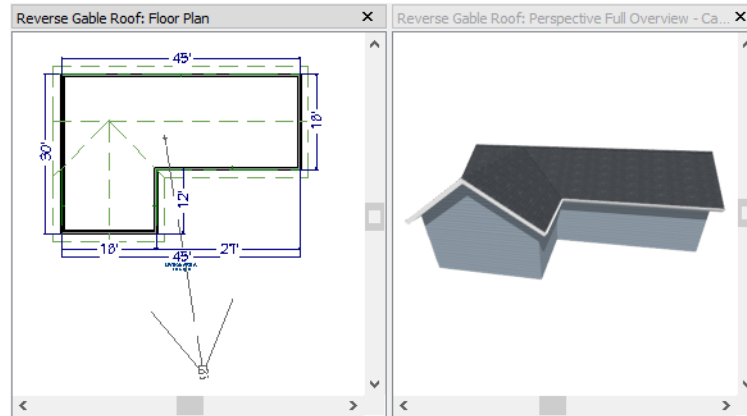

This completes this Roof Tutorial. You can use any combination of the techniques described here to create a wide variety of roof designs.

Adding a Roof to the Stucco Beach House





With a basic understanding of how automatically generated roofs work, you can return to the Stucco Beach House plan and add a roof. Select **File > Save As**  and give this plan a new name, such as "Beach House Roof Tutorial" before continuing.

Individual walls can be selected and edited in both 2D and 3D views; however, when multiple walls must be edited, it is usually quicker and easier to work in plan view. See “Editing Walls” on page 117 of the Reference Manual.

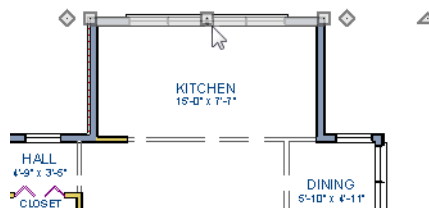
To edit the default roof

1. Close any 3D views that you may have open and work in plan view.
2. Starting on Floor 1, use the **Select Objects**  tool to select the top horizontal exterior Kitchen wall:



3. Click the **Open Object**  edit button and specify this wall as a **Full Gable Wall**. See “Gable Roofs” on page 4.
4. Click **Up One Floor**  to go to the second floor.
5. Using the **Select Objects**  tool, select the Balcony room, then click the **Open Object**  edit button. On the **STRUCTURE** panel of the **Room Specification** dialog, uncheck **Roof Over This Room**, then click **OK**.

- Assign the **Full Gable Wall** and **Extend Slope Downward** settings to the exterior walls, as shown in the following image. See “To set a wall’s roof directives” on page 2.

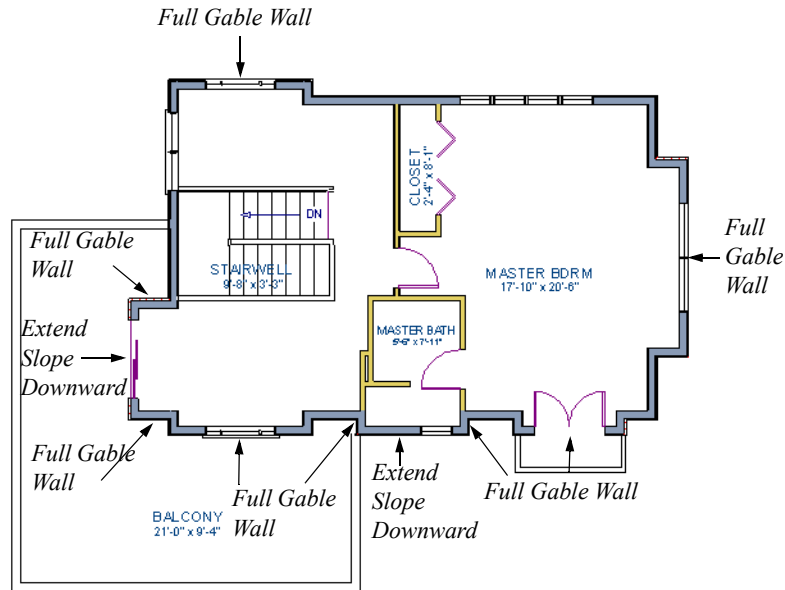

- Once these roof directives have been assigned, the roof can be generated.

To turn on automatic roof generation

- Select **Build> Roof> Build Roof**  to open the **Build Roof** dialog.
- On the **ROOF** panel, check **Auto Rebuild Roofs**. See “Build Roof Dialog” on page 253 of the Reference Manual for more information.
- Set the **Pitch** to 3 in 12.
- You can go to the **MATERIALS** panel to change the material of your roof. Here, an Earth Roof Tile material.
- Click **OK** to close the dialog and generate a roof.

The additional walls that are created are attic walls. See “Attic Walls” on page 3.

- Select **3D> Create Camera View> Perspective Full Overview**  to create an exterior view of your plan.

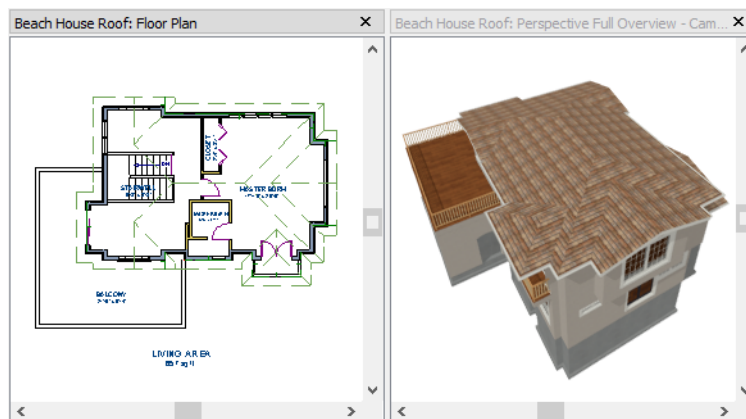

- Remember to **Save**  your plan as you work.

When you are ready, you can continue working on this plan in the Interior Design Tutorial.

Troubleshooting Roof Issues

Creating a roof can require experimentation and practice. Here are some suggestions for troubleshooting a problematic roof design.

Roof Directives in Walls

As discussed in this chapter and in the Roofs chapter of the Home Designer Suite 2021 Reference Manual, the program will automatically generate a roof plane bearing over each exterior wall in a plan to produce a hip roof. If you require a different condition over a particular wall, such as a triangular gable or side wall of a shed roof, you can specify that condition on the ROOF panel of the **Wall Specification** dialog. See “Roof Panel” on page 124 of the Reference Manual.

Specifying roof directives that do not reflect what you require directly above a selected wall, however, can often result in drastic and unwanted changes to your roof. For example, when two parallel walls are specified as Full Gable Walls, a single ridge will be created between them.

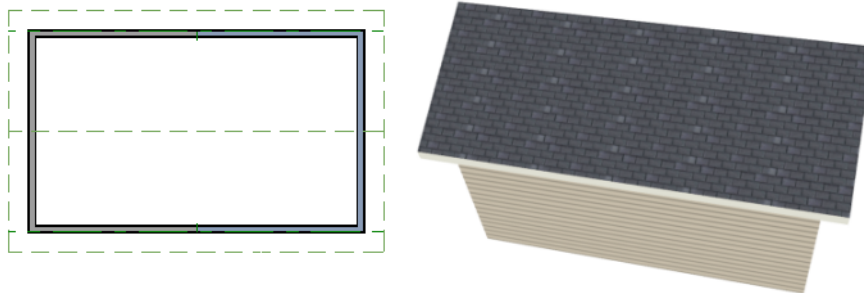

If a wall that is perpendicular to these walls is also specified as a Full Gable Wall, the roof becomes more complex with an additional ridge, two valleys, and two hips.

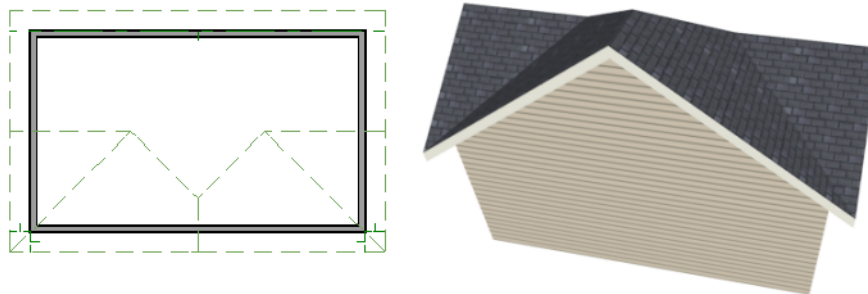

If you are seeing hips or valleys in your roof where you do not expect them, revisit the ROOF panel of the walls supporting the affected roof planes.

To review how to restore wall directives back to their default state, see “To reset all roof directives” on page 3.

Roof Heights

The heights of all roof planes are based on the heights of the walls that they bear on. Wall heights, in turn, are determined by the ceiling heights of the rooms that they define. See “Floor and Ceiling Heights” on page 137 of the Reference Manual.

For example, the hip roof over a simple rectangular structure with a consistent ceiling heights (in this case, 109 1/8") has four roof planes.

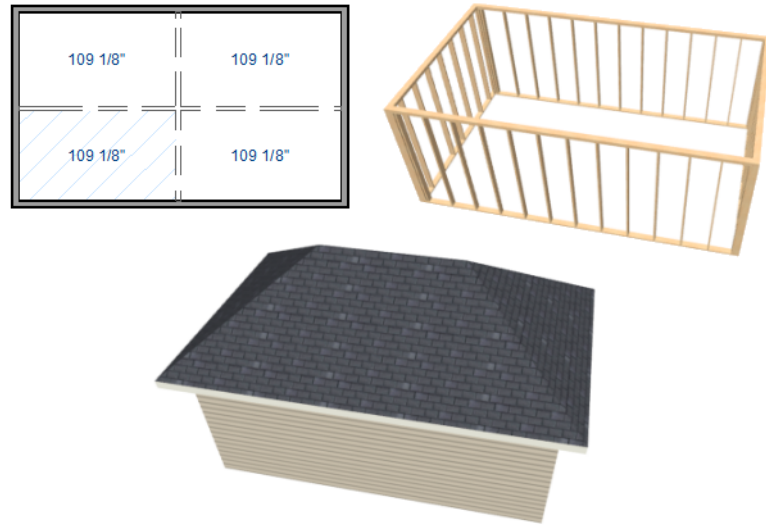

This roof will become considerably more complex if one room inside is given a lowered ceiling height (in this case, 97 1/8").

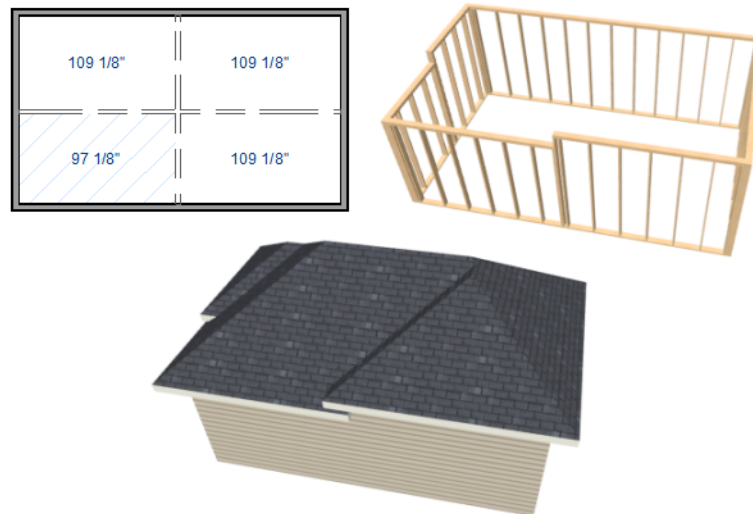

If you generate a roof and it seems to be more complicated and has more roof planes than it should, take a look at the ceiling heights of the rooms in the plan. Often, the correct way to create a lowered ceiling condition will be to set the ceiling at the default height create a lowered Ceiling Finish. See “Lowered Ceilings” on page 138 of the Reference Manual.

Controlling Roof Ridges

A single roof ridge will generate for as long as the bearing walls that support the roofs on either side of the ridge are the same distance apart. When alcoves or bump outs are introduced along either bearing wall, the ridge is likely to become broken.

For example, a simple rectangular structure with Full Gable Walls at each end generates a roof with a ridge that runs from Full Gable Wall to Full Gable Wall.

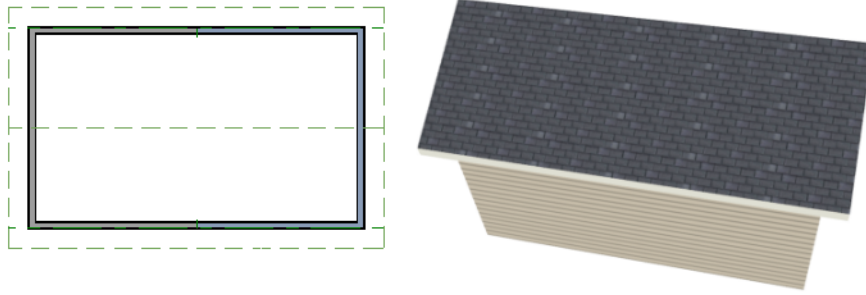

If a bump out is added that affects the length of either Full Gable Wall, or if an alcove is added anywhere along the length of the structure, the ridge will no longer follow a straight line.

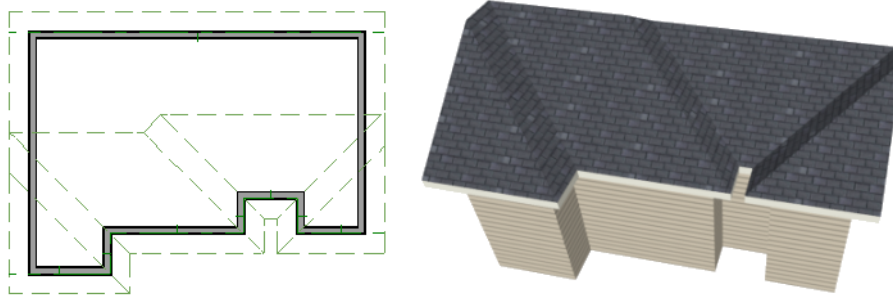

There are a number of ways to maintain a single ridge line in the presence of alcoves or bump outs:

- Use the **Break**  edit tool to control the length of a Full Gable Wall section. See “Using the Break Edit Tool to Modify Roofs” on page 17.

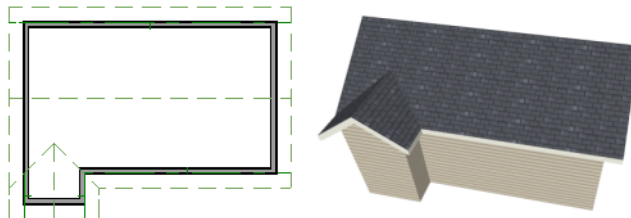

- Increase the **Minimum Alcove Size** to specify what size alcoves are roofed. See “Roof Panel” on page 253 of the Reference Manual.

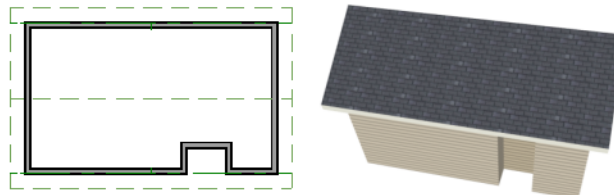

- Use the **Extend Slope Downward** roof directive to allow the roof over a bump out to extend lower than the ceiling height in that area. See “Roof Directives in Walls” on page 121 of the Reference Manual.

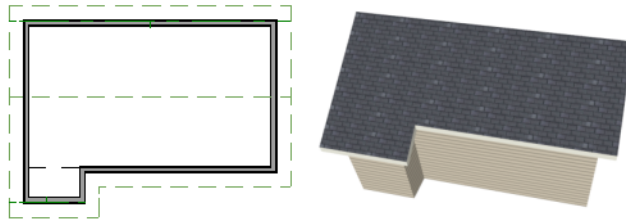

- Specify the area inside of an alcove as an "Open Below" room with a roof but no ceiling, and **Use Soffit Surface for Ceiling** specified. See "Room Types" on page 131 and "Structure Panel" on page 142 of the Reference Manual.

