

Chief Architect®
Home Designer Suite® 2021
3D Home Design Software

Reference Manual

*A description of the software interface,
including drawing tools and settings.*

Chief Architect, Inc.
6500 N. Mineral Dr.
Coeur d'Alene, Idaho 83815
HomeDesignerSoftware.com

© 1990–2020 by Chief Architect, Inc. All rights reserved.

No part of this documentation or the accompanying software may be reproduced or transmitted in any form or by any means, electronic or mechanical, including photocopying, recording, or by any information storage and retrieval system, without permission in writing from Chief Architect, Inc.

Chief Architect® and Home Designer® are registered trademarks of Chief Architect, Inc.

This software uses Open CASCADE Technology. See www.opencascade.com for details. Open CASCADE is used under the GLPL version 2.1 license.

This software uses the FreeImage open source image library. FreeImage is used under the FIPL license, version 1.0. See <http://freeimage.sourceforge.net> for details.

This application incorporates Teigha® software pursuant to a license agreement with Open Design Alliance. Teigha® Copyright © 2003-2018 by Open Design Alliance. All rights reserved.

This software uses the Ruby open source library. See <http://www.ruby-lang.org/> for details.

3D input device development tools and related technology are provided under license from 3Dconnexion. © 3Dconnexion 1992 - 2018. All rights reserved.

This software uses Intel's Embree library, which is licensed under the Apache License version 2.0. See <https://github.com/embree/> for details.

This software uses the OpenCOLLADA SDK. Copyright © 2008-2012 NetAllied Systems GmbH, Ravensburg, Germany.

This software uses the OpenCV open source computer vision library. OpenCV is used under the 3-clause BSD License. See <https://www.opencv.org/> for details.

All other trademarks and copyrights are the property of Chief Architect, Inc. or their respective owners.

Created in the United States of America.

Contents

Chapter 1: Program Overview

Startup Options	17
The Home Designer Suite Environment.....	19
Using Input Devices.....	20
View and Side Windows.....	22
Toolbars and Hotkeys	22
Menus.....	23
Dialogs	24
The Status Bar	26
Message Boxes.....	26
Preferences and Default Settings	26
Drawing a Plan	27
Viewing Your Plan	28
Getting Help	29
About Home Designer	29
Product Upgrade Options.....	29
Home Designer Trial Software.....	29

Chapter 2: File Management

Compatibility with Other Programs.....	31
Organizing Your Files.....	32
Home Designer Suite Data.....	32
Creating a New Plan.....	33
Saving, Exporting, and Backing Up Files.....	34
Thumbnail Images.....	36
Auto Archive	36
Undo Files.....	37
Opening and Importing Files	37
Referenced Files.....	39
Backup Entire Plan	40
Exiting Home Designer Suite.....	40

Chapter 3: Project Planning

Space Planning.....	41
Room Box Specification Dialog	43
Plan Check	43
Loan Calculator	44

Chapter 4: Preferences and Default Settings

Default Settings vs Preferences	47
Dynamic Defaults.....	48
Reset to Defaults	49
General Plan Defaults Dialog	49
Preferences Dialog.....	50
Angle Style Dialog.....	55

Chapter 5: Toolbars and Hotkeys

Toolbar Arrangement	57
Hotkeys	58
Gamepad Settings Dialog.....	59

Chapter 6: Window and View Tools

View Windows	61
Working in Multiple Views.....	61
View Tools	63
Zoom Tools.....	63
Undo Zoom.....	64
Fill Window	64
Panning the Display.....	64
Closing Views and Files.....	65

Chapter 7: Creating Objects

Architectural vs CAD Objects.....	67
Snap Behaviors	67
Object Snaps	68
Angle Snaps.....	68
Grid Snaps.....	68
Creating Objects.....	69

Copying and Pasting Objects	70
-----------------------------------	----

Chapter 8: Displaying Objects

Displaying Objects.....	73
Layers	74
Layer Attributes	74
Display Options Dialog.....	74
Layer Sets	75
Drawing Groups	75
Display Toggles	76
Fill Styles	76
Select Color Dialog	77

Chapter 9: Editing Objects

Selecting Objects.....	79
Selecting Multiple Objects	80
Editing Line-Based Objects	82
Editing Arc-Based Objects	83
Editing Open Polyline-Based Objects.....	85
Editing Closed Polyline-Based Objects	87
Editing Box-Based Objects	89
Editing Spline-Based Objects	90
Editing Circles, Ovals and Ellipses	91
Moving Objects.....	92
Aligning Objects	93
Resizing Objects.....	94
Reshaping Objects	95
Rotating Objects	96
Eyedropper and Painter Tools	97
Object Eyedropper	98
Deleting Objects.....	98
Delete Objects Dialog	99
Undo and Redo	100

Chapter 10: CAD Objects

The CAD Drawing Tools.....	101
Line Specification Dialog	102
Arc Specification Dialog.....	104

Circle/Oval/Ellipse Specification Dialog	105
Polylines	105
Polyline Specification Dialog	106
Box Specification Dialog	107
Splines	107
Displaying CAD Objects	108

Chapter 11: Walls, Railings, and Fencing

Wall Defaults	109
Wall Tools	110
Railing and Deck Tools	111
Fencing Tools	112
Exterior and Interior Walls	112
Foundation Walls	112
Room Dividers and Invisible Walls	113
Polygon Shaped Decks	114
Hatch Wall	114
Creating Walls	114
Connecting Walls	116
Displaying Walls	117
Measuring Walls	118
Editing Walls	119
Editing Straight/Curved Wall Combinations	121
Aligning Walls	121
Roof Directives in Walls	122
Attic Walls	123
Wall Type Definitions	124
Wall Specification Dialog	124
Railing and Fencing Specification Dialogs	127
Wall Hatch Specification Dialog	130

Chapter 12: Rooms

Room Definition	131
Floor and Room Defaults	132
Room Types	132
Displaying Rooms	134
Selecting Rooms	134
Editing Rooms	135
Room Labels	136

Room Label Specification Dialog.....	137
Decks.....	138
Floor and Ceiling Heights.....	138
Stepped Floor and Ceiling Platforms	139
Special Ceilings.....	139
Room Moldings.....	141
Room Specification Dialog.....	141

Chapter 13: Dimensions

Dimension Unit Defaults	147
Dimension Defaults Dialog.....	147
The Dimension Tools.....	149
Displaying Dimension Lines	151
Editing Dimension Lines.....	151
Editing Extension Lines	152
Moving Objects Using Dimensions	154
Dimension Line Specification Dialog.....	154

Chapter 14: Text

Text Defaults	157
Fonts and Alphabets.....	158
The Text Tools	158
Creating Text	159
Displaying Text.....	159
Rich Text Specification Dialog	159
Editing Text	161
Copying and Pasting Text.....	162
Find/Replace Text.....	163
Text Arrows	164
Text Styles	165
Object Labels	166

Chapter 15: Doors

Door Defaults	169
Door Tools.....	169
Displaying Doors.....	171
Editing Doors	172
Changing Door Swings.....	173

Special Doors	175
Door Specification Dialog	176

Chapter 16: Windows

Window Defaults	183
Window Tools	183
Special Windows	185
Grouped Windows	186
Displaying Windows	186
Editing Windows	187
Window Specification Dialog	188
Bay, Box, and Bow Windows	194
Bay, Box, Bow Windows and Roofs	195
Bay/Box and Bow Window Specification Dialogs	196

Chapter 17: Cabinets

Cabinet Defaults	199
The Cabinet Tools	200
Cabinet Fillers	201
Placing Cabinets	201
Displaying Cabinets	202
Editing Cabinets	203
Editing Cabinet Styles	204
Special Cabinets	204
Cabinet Specification Dialog	206
Shelf/Partition Specification Dialog	210

Chapter 18: Electrical

The Electrical Tools	213
Placing Electrical Objects	214
Auto Place Outlets	215
Creating Wiring Schematics	215
Electrical Library Content	216
Displaying Electrical Objects	216
Editing Electrical Objects	217
Electrical Service Specification Dialog	217

Chapter 19: Foundations

Foundation Defaults	221
Building a Foundation.....	222
Displaying Foundations.....	222
Editing Foundations	223
Deleting Foundations.....	224
Foundations and Rooms.....	224
Foundations and the Terrain.....	225
Library Fireplaces	226
Chimneys	226

Chapter 20: Multiple Floors

Floor Defaults Dialog	227
Floor Tools	228
Adding Floors.....	228
Displaying Floors	229
Exchanging Floors	229
Deleting Floors	229
Split Levels	229
The Current Floor	230
The Attic Floor.....	231
The Reference Floor	231

Chapter 21: Stairs, Ramps, and Landings

Stair Defaults	233
The Stair Tools.....	233
Anatomy of a Staircase	234
Drawing Stairs and Ramps.....	235
L- and U-Shaped Stairs.....	236
Displaying Stairs, Ramps, and Landings	237
Editing Stairs and Ramps	237
Stair and Ramp Sections and Subsections	238
Landings	240
Maintaining Tread Depth	241
Starter Treads.....	241
Wrapped Stairs.....	242
Other Special Railings and Stairs	243
Creating a Stairwell.....	243

Rooms Below Staircases	244
Staircase Specification Dialog	245
Ramp Specification Dialog	251
Stair Landing Specification Dialog	252

Chapter 22: Roofs

Roof Defaults	255
The Roof Tools	256
Automatic Roofs	256
Build Roof Dialog	256
Editing Roofs	258
Gable Over Door/Window	258
Gable Line Specification Dialog	259
Skylights	259
Skylight Specification Dialog	260
Dormers	261
Editing Auto Dormers	262
Dormer Specification Dialog	262
Roof Returns and Other Details	263

Chapter 23: Trim Tools

Trim and Molding Defaults	265
Corner Boards	265
Corner Board Specification Dialog	266
Quoins	266
Quoin Specification Dialog	266
Editing Corner Boards and Quoins	267
Millwork	267
Applying Moldings	268

Chapter 24: The Library

The Library Browser	271
Searching the Library	274
Find in Library	275
Library Content	276
Downloading Library Content	277
Importing Library Catalogs	278
Adding Library Content	279

Organizing the Library	279
Exporting Library Catalogs	281
Placing Library Objects.....	281
Select Library Object Dialog.....	283
Replace From Library	283
Displaying Library Objects	283
Editing Library Objects.....	284
Symbol Object Specification Dialogs.....	285

Chapter 25: Architectural Blocks

Displaying Architectural Blocks	287
Editing Architectural Blocks.....	287
Architectural Blocks and Sub-Objects	288

Chapter 26: Other Objects

General Shapes	289
Soffits	289
Special Applications for Soffits	290
Soffit Specification Dialog.....	291

Chapter 27: Materials

About Materials	294
Material Defaults	294
Material Painter Tools	295
Materials Panel	296
Select Material Dialog	297
Editing Materials.....	298
Creating Materials.....	299
Define Material Dialog.....	300

Chapter 28: 3D Views

OpenGL and Hardware.....	303
Camera Defaults Dialogs	303
3D View Tools	304
Creating Camera Views.....	305
Creating Overviews	305
Elevation Views.....	306

Displaying 3D Views.....	307
Repositioning Cameras	308
Editing 3D Views	311
Cross Section Slider.....	313
Working in 3D.....	313
Saving and Printing 3D Views.....	314
Camera Specification Dialog	315
Elevation Camera Specification Dialog.....	318

Chapter 29: 3D Rendering

Rendering Tips.....	319
Lighting	320
Displaying Lights	321
Lighting Modes	322
Adjust Sunlight Dialog.....	322
Rendering Techniques.....	323
Rendering Technique Options.....	323

Chapter 30: Pictures, Images, and Walkthroughs

Picture Files vs Pictures and Image Objects.....	326
Images.....	326
Displaying Images.....	327
Editing Images	327
Image Specification Dialog	328
Pictures	329
Picture File Box Specification Dialog	330
Metafiles	330
Metafile Box Specification Dialog	331
PDF Files	331
PDF Box Specification Dialog.....	332
Displaying Pictures, Metafiles, and PDF Boxes.....	332
Editing Pictures, Metafiles, and PDF Boxes	333
3D Backdrops.....	333
Backdrop Specification Dialog.....	334
Walkthrough Paths	335
Recording a Walkthrough	337
Walkthrough Path Specification Dialog.....	339

Chapter 31: Importing and Exporting

Chief Architect Account Login.....	341
Export Chief Architect 3D Viewer File	342
Import Room Planner File.....	343
DXF vs DWG File Formats	343
Exporting 2D DXF/DWG Files.....	343
Additional 2D Export Information	344
3D Data Import Requirements.....	345
Importing 3D Symbols	345
Symbol Specification Dialog	346
3D Symbols and Materials.....	347
Export 360 Panorama	348

Chapter 32: Terrain

Terrain Perimeter.....	349
Elevation Data Tools	350
Terrain Modifier Tools	352
Terrain Feature Tools	353
Garden Bed Tools.....	354
Water Feature Tools.....	354
Stepping Stone Tools	355
Terrain Wall and Curb Tools.....	355
Terrain Objects in the Library	356
Displaying Terrain.....	356
Editing Terrain Objects	356
Terrain Specification Dialog.....	357
Elevation Point Specification Dialog.....	358
Elevation Line/Region Specification Dialog.....	359
Hill / Valley Specification Dialog.....	359
Raised / Lowered Region Specification Dialog	360
Terrain Feature Specification Dialog	360
Garden Bed Specification Dialog	362
Terrain Path Specification Dialog.....	362
Importing Elevation Data	363
Import Terrain Assistant.....	364
Import GPS Data Assistant	365

Chapter 33: Roads, Driveways and Sidewalks

Road, Driveway and Sidewalk Tools	367
Displaying Road Objects.....	368
Editing Road Objects	368
Road Specification Dialog.....	369

Chapter 34: Plants

Plant Tools.....	371
Plant Chooser Dialog.....	372
Hardiness Zones.....	373
Plant Image Specification Dialog	373

Chapter 35: Materials Lists

The Materials List Tools	377
Creating an Accurate Materials List	378
Structural Member Reporting	378
Organizing Materials Lists	379
Materials List Specification Dialog.....	380
Editing Materials Lists.....	381
Printing and Exporting the Materials List.....	381
Conditioned Area Totals.....	382

Chapter 36: Printing

Introduction to Printing.....	383
The Printing Tools.....	384
Drawing Sheet Setup Dialog.....	384
Print Preview	385
Printing to Scale.....	386
Printing Across Multiple Pages.....	386
Printing to a PDF File	387
Print View Dialog	387
Print Image Dialog	389

Appendix A: Resources and Support

Learning and Inspiration.....	391
Contacting Technical Support.....	392

Error Messages	392
Program Paths Dialog	393

Program Overview

Home Designer Suite is designed to help home enthusiasts visualize, develop and share their design ideas. Home Designer Suite uses parametric design technology, which means that as you draw, a 3D model is created and is updated as you make changes. You can tile a floor plan view next to a 3D view and watch one update automatically as you draw in the other.

Chapter Contents

- Startup Options
- The Home Designer Suite Environment
- Using Input Devices
- View and Side Windows
- Toolbars and Hotkeys
- Menus
- Dialogs
- The Status Bar
- Message Boxes
- Preferences and Default Settings
- Drawing a Plan
- Viewing Your Plan
- Getting Help
- About Home Designer
- Home Designer Trial Software



Startup Options

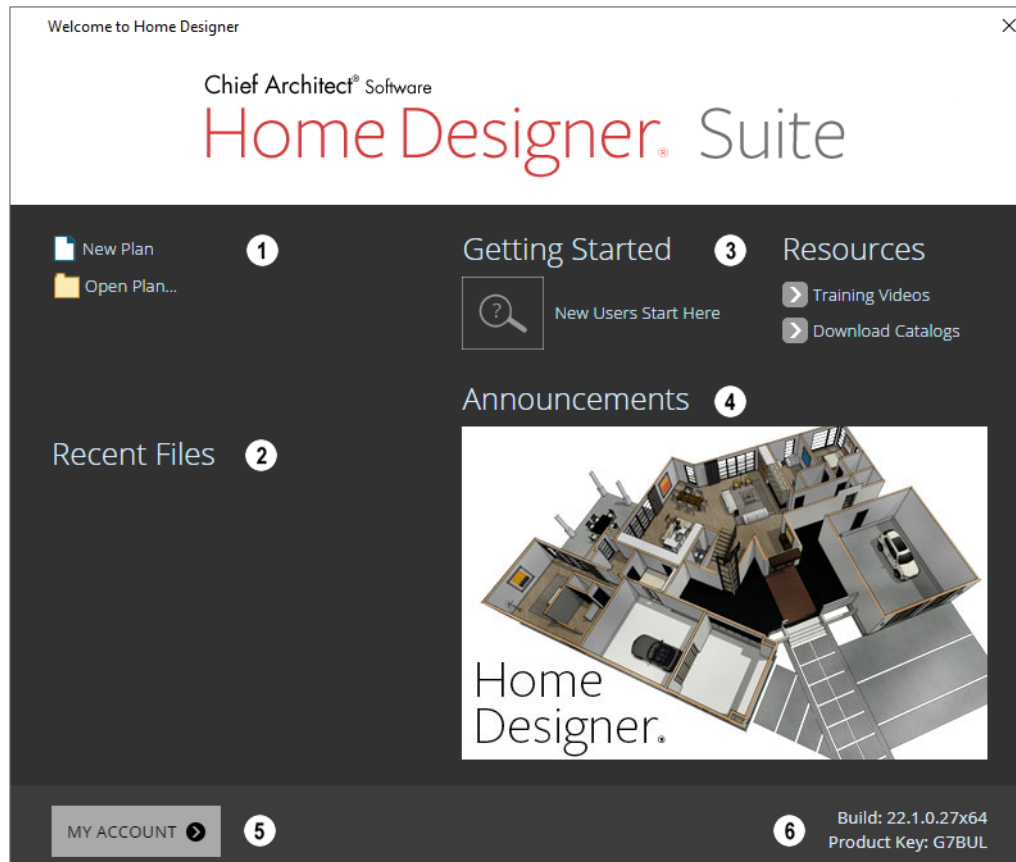

When Home Designer Suite opens, the **Startup Options** dialog displays, allowing you to choose how you want to begin working in the program or access useful resources.

The **Startup Options** dialog can be opened at any time by selecting **File> Startup Options** .



- 1 Select a **File** command to open a .plan file.
 - Click **New Plan**  to open a new, blank file. See “Creating a New Plan” on page 33.
 - Choose **Open Plan**  to work on an existing plan file. See “Opening and Importing Files” on page 37.
- 2 **Recent Files** lists the full pathnames of the most recently opened files. Click on a name to open the file.

 Move your mouse pointer over a name to see the file’s full pathname.
- 3 A selection of useful online **Getting Started** options and **Resources** are available here. Click on an option to launch your default internet browser to HomeDesignerSoftware.com.
 - Click **Getting Started** to visit the Getting Started page on our web site with links to a variety of resources to help you begin using the program.
 - Click **Training Videos** to access a searchable collection of videos focused on specific topics.
 - Click **Download Catalogs** to visit our 3D Library of downloadable bonus and manufacturer library catalogs. See “Library Content” on page 276.
- 4 When an internet connection is available, the **Announcements** section displays updated messages and news from Chief Architect.
- 5 Click **My Account** to launch your default internet browser to the Log In page on our web site.
- 6 Your software version’s **Build** number and the first five characters of your **Product Key** display here for reference.

To prevent the **Startup Options** dialog from displaying when you launch Home Designer Suite, uncheck **Show Options on Startup** in the **Preferences** dialog. See “General Panel” on page 52.

The Home Designer Suite Environment

Home Designer Suite is designed to be intuitive and efficient.

3D Drafting

In Home Designer Suite, the drawing area is laid out on a Cartesian grid, a three dimensional coordinate system described using the X, Y, and Z axes. The current position of your mouse pointer displays in the Status Bar at the bottom of the program window.

Architectural objects take up space in all three dimensions and their height, width and depth can be specified in Imperial or metric units. In addition, the location of objects can be precisely defined using coordinates, again specified in Imperial or metric units.

CAD objects such as lines and arcs take up space in two dimensions in the current view. Their dimensions can also be specified in Imperial or metric units and their locations precisely defined using coordinates.

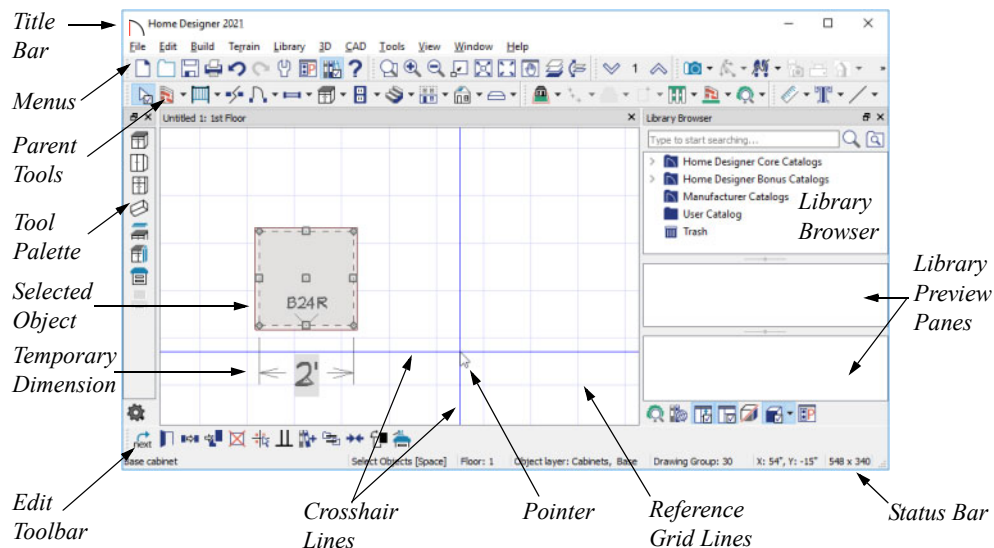

Easy Access to Tools

You can access Home Designer Suite's features in various ways using the mouse and keyboard.

- Convenient toolbar buttons allow fast access to frequently-used tools and let you customize the interface.
- Menus provide access to most tools and settings.
- Keyboard shortcuts are available for most tools.
- Contextual menus display with a right-click of the mouse.
- The Status Bar at the bottom of the screen provides tool descriptions and other information about the current task.

Object-Based Design

Home Designer Suite's parametric, object-based design technology means you place and edit objects,

rather than work with the many individual lines or surfaces used to represent them.

You can quickly select and edit the location, size, shape, style and other properties of objects as well as change the materials applied to their surfaces.

Use Home Designer Suite's editing capabilities to make the objects you place in a plan match the objects they represent in real life. For example, you can set up your windows and doors to match those available from your supplier.

Interface Toggles

A number of useful drawing and editing behaviors, as well as the display of important elements in the interface, can be easily enabled and disabled using the menus. For example:

- Object Snaps, Angle Snaps, and Grid Snaps can be toggled on or off as needed. See "Snap Behaviors" on page 67.

- Display Elements like Print Preview, Show Line Weights, and the Reference Display can be turned on when needed and then toggled off.

When a setting is turned on, its icon in the menu will display a small checkmark at its lower right corner and have a border around it in.

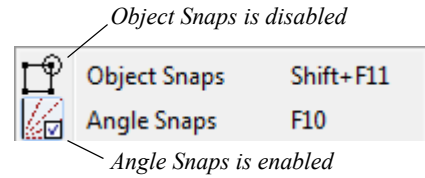

Many of these interface elements are global Preferences while others are file-specific default settings. See “Default Settings vs Preferences” on page 47.

Using Input Devices

You can interact with Home Designer Suite using a variety of input devices.

Keyboard

A keyboard is necessary for entering text and size values. See “Dialogs” on page 24.

Your keyboard can also be used to navigate the dialog panels, as well as navigate the program menus. Many commands can also be invoked using keyboard hotkeys. See “Menus” on page 23 and “Hotkeys” on page 23.

In addition to the keyboard, a mouse or other device that can move a pointer is necessary in order to draw, select, and edit objects in your drawings.

Three Button Mice



The **left button** is the primary button used in Home Designer Suite. Unless specified otherwise, Home Designer Suite documentation refers to the left mouse button.

Many objects, such as doors and cabinets, are created by clicking the left mouse button. Others, such as walls, stairs and dimension lines, are created by dragging the pointer from one end of the object to the other.

Note: If you are left-handed and have re-programmed your mouse, reverse the instructions for left and right buttons in this manual.



The **Right button** has several uses.

Right-click to select any object. If, for example, the **Straight Exterior Wall**  tool is active, the left mouse button only allows you to select walls. You can, however, select other types of objects such as cabinets with the right mouse button.

You can also use the right mouse button to open a context sensitive menu with additional editing commands. See “Contextual Menus” on page 23.



The **Middle button** can be used to pan in most view types. To close a tabbed view window, click on its tab using the middle mouse button. You can also program it to work as a double-click.

If your mouse does not have a middle mouse button, in the Mac version of Home Designer Suite you can use the left button and the Command key to achieve the same results.



The **Mouse Wheel** can be used to zoom in and out in most view types. See “Zoom Tools” on page 63.

3D Mice

3Dconnexion®’s 3D mice can be used to navigate in Home Designer Suite. For information about navigating in camera views and overviews, see “3Dconnexion® 3D Mice” on page 308.

Trackpads

In addition to the standard trackpad gestures on your system, in Home Designer Suite you can pinch to zoom.

In macOS™, you can Command + click to pan. Panning with a trackpad is not supported in the Windows version of the software, however.

Touch Screens

Standard one-finger touch screen gestures are supported in both the Windows and Mac versions of the software. In the Windows version, touching with a second finger to cancel an action is also supported, as are two-finger pan and two-finger pinch to zoom.

Gamepads

In the Windows version of Home Designer Suite, gamepads can be used to navigate in camera views, overviews, as well as elevation views. See “Gamepads” on page 309.

Crosshairs

 Crosshairs help you position the pointer relative to objects in a view while drawing and editing. They can be set to display in Plan and Elevation views. Select **View > Crosshairs** to toggle crosshairs on or off.

You can customize the Crosshairs’ appearance in the **Preferences** dialog. See “Edit Panel” on page 54.

Edit Handles

A selected object has edit handles that can be used to modify its size, position, and orientation. When you move the pointer over an edit handle, information about what it does displays in the Status Bar and the pointer changes to suggest how you can use it.

- A two-headed arrow indicates that the object, corner or edge can be moved in the direction of the arrows.
- A four-headed arrow indicates that the selected object or edge may be moved in multiple directions.
- A circular arrow indicates that the selected object can be rotated.

Resize handles display along the edges of the object are used to change the size. See “Resizing Objects” on page 94.



The Move handle at the object’s center lets you move the object. Depending on the type of object(s) selected and how far you are zoomed in or out, the position of the Move handle may shift so that it remains on-screen. See “Moving Objects” on page 92.

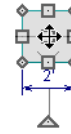

The triangular Rotate handle lets you rotate the object. See “Rotating Objects” on page 96.





You can cancel any edit handle operation before it is completed by pressing the Esc key on your keyboard or by pressing any two mouse buttons at the same time.

The edit handles that display depend on the type of object selected, the current view, and how far you are zoomed out. Edit handles do not resize as you zoom in or out. If you are zoomed out far enough, some edit handles may be hidden so that they do not stack over one another. As you zoom in, these handles become visible again.



Pointer Icons

The appearance of the pointer in Home Designer Suite will vary, depending on which tool is active.

For example, when the **Select Objects**  tool is active, it will look like a white arrow, and when a

Cabinet Tool  is active, it will look like a base cabinet with a small cross.

In addition, one or more additional icons may follow the mouse pointer if Angle Snaps is not in use or if a problematic condition exists in the file:

Icon	Setting
	Angle Snaps
	Fix Wall Connections
	Irregular Wall Angles

View and Side Windows

Home Designer Suite's main program window has a number of important features that let you interact with the program, such as toolbars and menus. It also features two different kinds of windows: view windows and side windows.

View Windows

View windows are sometimes referred to as “the drawing area” because most of them are windows in which you can draw or place architectural and/or CAD objects. There are a number of different types of view windows in Home Designer Suite:

- Plan views
- Camera views and overviews
- Elevation views
- Materials Lists

View windows can be navigated by panning and zooming. You can also enable scroll bars on their right side and bottom. Select **View > Scrollbars** to toggle their display. See “View Tools” on page 63.

Although only one view window can be active at any given time, there is no limit to the number of view windows that can be open. View windows can be tiled or tabbed, and you can navigate between them in a number of different ways. See “Window and View Tools” on page 61.

You can also tear a view window out of the main program window. This creates a second, separate program window complete with toolbars and menus. Individual view windows can be torn out and transferred between program windows.

Side Windows

Side windows provide access to a variety of tools and content that helps you add detail your drawings.

Side windows are so-named because they are typically docked to either the left or right side of the program window - although, they can also be docked

to the top or bottom, or undocked entirely. There are several different types of side window:

- Child Tool Palette
- The Library Browser

Each of these side windows can be opened via the **View** menu or by clicking the toolbar button associated with it. Similarly, each can be closed by clicking the **Close** button in its title bar or tab, via the **View** menu, or by clicking its toolbar button. See “View Tools” on page 63.

To undock a side window, either drag its title bar out into the drawing area or click the Undock button on its title bar. To dock a side window, drag its title bar to any side of the program window. You can also double-click on its title bar to return it to its last docked location.

Two or more side windows can be docked together to form a shared side window, and can be tiled and/or tabbed within that shared window. To create a shared side window, begin by docking a side window to a side of the main program window, then:

- To create tabbed side windows, drag a second side window over the first. When the docked window becomes highlighted, release the mouse button.
- To create tiled side windows, drag a second side window over the first. When the docked window becomes highlighted, slowly drag the mouse towards one of its sides. When a highlighted space is created along that side, release the mouse button.

You can choose to disable **Side Window Drag Docking** in the **Preferences** dialog, and you can also enable **Top/Bottom Docking**. See “Appearance Panel” on page 50.

Side windows can also be set to their initial states in the **Preferences** dialog. See “Reset Options Panel” on page 55.

Toolbars and Hotkeys

Using the toolbar buttons is the fastest, easiest way to access many program features. If a tool is active, a small checkmark will display at the lower left of its button icon. When you pass the pointer over a toolbar button, a “tool tip” displays the name of the tool and a more detailed description displays in the

Status Bar at the bottom of the program window. When you see one of these tool tips, press the F1 key to get more information about that item. See “Getting Help” on page 29.

Home Designer Suite's tools are organized into families of related tools which can be accessed using

either of two styles of toolbar interface: the Child Tool Palette or Drop Down tools. You can select the interface that you prefer in the **Preferences** dialog. See “Appearance Panel” on page 50.

The Edit Toolbar

When you select an object, the edit toolbar appears. By default, it is located at the bottom of the program window, just above the Status Bar. The buttons on the edit toolbar can be used to edit the selected object(s). Which buttons display depends on the type of object selected, the current view, and how you selected the object.



Menus

Home Designer Suite uses a standard Windows menu format. The menus are located below the title bar in the program window and can be used to access nearly all tools in the program. Click on a menu name to expand it, then click on a menu item to either activate that tool or access the item’s submenu. Items with a submenu have an arrow to the right of the name.

Menu items with an icon to their left have a toolbar button associated with them.

The menus can be accessed using the keyboard. Press the ALT key once to enable this functionality - one letter in each menu will become underlined. Press the key associated with one of these underlined letters to expand its menu - one letter in each menu item’s name will be underlined. Press the key associated with one of these letters to activate that tool or access the item’s submenu. Press the Esc key to undo your last selection, or click with the mouse to exit out of this functionality.

Many tools in Home Designer Suite also have hotkeys associated with them. If a menu item has a hotkey, it will display to the right of the item’s name. See “Hotkeys” on page 58.

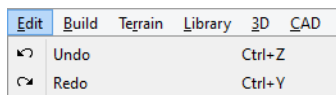

Edit menu items with button icons to the left and hotkeys to the right

The edit toolbar buttons are the same as the options in the contextual menu when you right-click on an object. See “Contextual Menus” on page 23.

Hotkeys

Many commands can be invoked from the keyboard. Press ALT on your keyboard and press the underlined letter in a menu name to access that menu, as well as items in the menus and submenus.

Other keys or key combinations will invoke a variety of program commands. If a Home Designer Suite menu item has a keyboard shortcut, or hotkey, associated with it, that hotkey will display to the right of its name in the menu.

In the Home Designer Suite documentation, menu paths are written in this format: **Build> Window>**

Box Window

Contextual Menus

Contextual menus are context-sensitive menus that display tools relevant to a selected object or view. To open a contextual menu, right-click on an object, in an empty space in a view window, or in a text field in a dialog box.

The options in an object’s contextual menu are usually the same as those on an object’s Edit toolbar. See “The Edit Toolbar” on page 23.

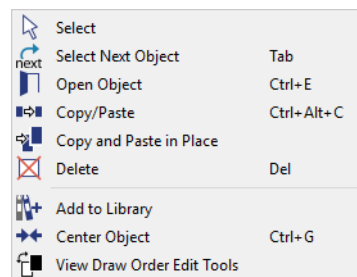

Contextual menus can be enabled or disabled in the **Preferences** dialog. When contextual menus are disabled, right-clicks perform generic object selection, much like when the **Select Objects** tool is active. See “Appearance Panel” on page 50.

Dialogs

Default and preference settings, object specifications, display settings, and many other functions are accessed through dialog boxes.

Many dialogs have multiple panels, which are listed in a tree list on the left side of the dialog. Click on a panel name in the list to make it active. In Windows, panels can also be navigated using the keyboard.

Press:

- Ctrl + Tab or Ctrl + F6 to navigate forward;
- Ctrl + Shift + Tab or Ctrl + Shift + F6 to navigate backward.

When a panel name is active, you can also navigate the tree list using the Up and Down arrow keys.



By default, dialogs always open to the first panel in the list; if you prefer, you can choose to **Open Dialogs to the Last Panel Visited**. See “General Panel” on page 52,

Keyboard Navigation

Dialog panels and settings can be accessed using the mouse. You can also navigate the settings on a given dialog panel using the keyboard. For example:

- Line items in tree lists can be browsed using the arrow keys. Up and Down navigate the list, while Left and Right expand and contract categories.
- Press the Tab key to shift focus from the tree list to the first setting on the selected panel.
- Press the Tab key to shift focus from one setting to the next, or Shift + Tab to go in the reverse direction.
- A check box can be checked or cleared by pressing the Spacebar or the + or - keys, respectively, while it is in focus.
- Columns of radio buttons can be navigated using the Up and Down arrow keys; rows can be navigated using the Left and Right arrows. Select a radio button by pressing the Spacebar while it is in focus.
- Settings in list boxes can be navigated using the Up and Down arrow keys. When a check box is in focus, it can be checked or cleared by pressing the Spacebar.
- Drop-down lists can be browsed using the Up and Down arrow keys. When the mouse pointer is directly over the drop-down, the mouse scroll wheel can also be used; on a Mac, the list must also be expanded. In Windows only, you can

press Tab to select the highlighted item in the list and proceed to the next setting.

- Settings with spin control arrows  can be adjusted by typing in the text field or using the Up and Down arrow keys. When the mouse pointer is directly over the setting, the mouse scroll wheel can also be used.
- Slider bars  can be adjusted by typing in the text field or using the Left and Right arrow keys. When the mouse pointer is directly over the slider bar, the mouse scroll wheel can also be used.
- Line items in tables can be group selected using the Ctrl or Shift keys, or by pressing Ctrl+A.
- Press Enter on your keyboard to close most dialogs and apply your changes.
- In the Mac version, Command + . closes dialogs.

Note: Keyboard navigation in dialogs may vary somewhat depending on your computer platform.

In the Mac version of the software, Dictation is supported in dialogs. Select **Edit> Start Dictation**, then open a dialog. Say the word “Numeral” before a number to enter it as a numeric value or immediately follow a number with a unit such as “foot” to enter it as a measurement.

The units of measurement used in dialogs are determined by your choice of template files. See “Creating a New Plan” on page 33.

The number format used in dialogs are set based on your operating system’s defaults.

Math Operations in Dialogs

Basic addition, subtraction, multiplication, and division can be performed in the text boxes where numeric values are entered.

Note that settings for angle, pitch, or bearing do not support math, nor do those with spin controls or slider bars.

- To add, type the + character followed by the amount that you wish to add. Spaces are ignored and including a unit of measurement is optional.
- To subtract, type the - character followed by the amount you wish to subtract. As with adding, spaces are ignored and a unit of measurement is optional.

- To multiply, type the * character followed by the amount you wish to multiply by. Spaces are ignored, and only one of the values being multiplied can have a unit of measurement.
- To divide, type the / character followed by the amount you wish to divide by. To divide, there must be a space before the / - if there is not, the input may be treated as a fraction. The denominator, or value typed after the /, cannot have a unit of measurement.

Math expressions support a single operation only: more than one operation character (+, -, *, /) at a time is not allowed.

Basic math operations can also be used to move objects using dimensions. See “Moving Objects Using Dimensions” on page 154.

Dialog Size and Position

Dialog boxes can be both moved and resized to suit your needs. By default, the program will remember both the position and size that you specify for a dialog and use it the next time you open it. The size of dialog preview panes can also be changed, and are remembered as well. You can specify whether the program does this always, per session, or never in the **Preferences** dialog. See “General Panel” on page 52.

- To move a dialog, position your mouse pointer within its title bar and then simply click and drag.
- To resize a dialog, position your mouse pointer on any edge or corner and then click and drag outward or inward. If you drag an edge, only that edge will move; if you drag a corner, the two adjacent edges will move.
- To resize a preview pane, click and drag the vertical grab handle to its left. See “Dialog Panel Splitters” on page 25.

When a dialog is resized, some elements such as list boxes and text fields within it may resize in response.

All dialogs have a minimum size limitation but no maximum size. If a dialog opens on a monitor with resolution too low to display its full extents, it will have vertical and/or horizontal scroll bars.

You can reset the default sizes and positions of all dialogs in the **Preferences** dialog. See “Reset Options Panel” on page 55.

Note: Some of the dialog box images in the software documentation have been resized smaller than their actual minimum size.

Specification Dialogs

 Each object in Home Designer Suite has a unique specification dialog where you can enter size, style and other information specific to the selected object. To access it, select the object and click the **Open Object** edit button. You can also double-click on an object with the **Select Objects**

 tool active to open its specification dialog. See “Selecting Objects” on page 79.

Most objects also have a defaults dialog that lets you specify the initial values in the specification dialog.

Dialog Preview Panes

Many specification dialogs have a preview pane that shows how changes to settings affect the selected object. This preview updates when you click in a different field or press the **Tab** key on your keyboard.

When you click in the preview pane, your mouse pointer changes to a four-headed arrow and you can rotate around the object as well as zoom in and out using the mouse scroll wheel. Some objects, notably walls, doors, and windows, have Interior and Exterior labels to indicate which side is visible in the preview. Click the **Fill Window**  button above the preview pane to zoom in or out so that the object fills the extents of the pane, maintaining the current rotation.

In most dialogs, the Standard and Glass House Rendering Techniques can be applied to the preview. See “Rendering Techniques” on page 323.

Click the **Color**  button to turn color in the preview off or on. Some objects have additional tools that affect object previews. For example, the **Cabinet Specification** dialogs have a **Select Cabinet Face**

Item  button. Object specific tools like this are discussed in the documentation for that object type.

Dialog Panel Splitters

Many dialog panels are divided into up to three sections: a list of panels on the left, an object preview on the right, and a central area where settings are

located. The vertical splitters separating these sections each have a pale grey, vertical grab handle.

To resize the panel list or preview, as well as the area in the middle, move your mouse pointer over the

vertical grab handle: when the splitter cursor  can be seen, click and drag to the left or right.

The Status Bar

The Status Bar at the bottom of the main program window displays information about the current state of the program.

This information depends on a variety of conditions such as the type of object selected, and the current position of the pointer. The information may include the following:

- The type of object currently selected or the total number of group-selected objects.
- A description of the edit handle that the pointer is over.

- A brief description of the toolbar button or menu item highlighted by the mouse.
- The name of the active tool, a brief description of that tool, and its hotkey, if it has one.
- The length and/or angle of an object as it is being drawn.
- Basic information about a selected library object, folder, or catalog.
- The current floor.
- The layer that the selected object is on.
- The size of the active window in pixels.

Message Boxes

As you work in Home Designer Suite, the program will occasionally prompt you to examine your settings, alert you if you command it to do something that could potentially cause a problem, or notify you if it encounters a problem that needs your attention.

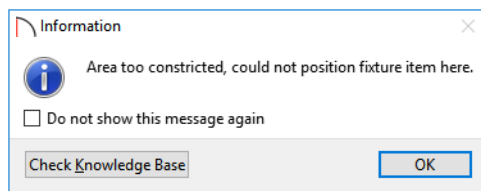

Situations where such message boxes may display include:

- Closing a file without saving;
- Modifying an object that is set to rebuild automatically;
- A file referenced outside the program, such as an image or texture, is missing;

- Creating an object in a space too small to contain it.

As with dialog boxes, you can access the options in a message box using the mouse or navigate them using the keyboard.

A few messages have a **Send Report** button. Click this button to send details regarding the issue that prompted the message to Chief Architect via the internet.

Some message boxes include a “Remember my choice” or a “Do not show this again” checkbox. Check this box to prevent messages of this specific type from displaying in the future. When this box is checked, some options in the message box may become inactive.

To allow all message boxes to display again, click the **Reset Message Boxes** button in the **Preferences** dialog. See “Reset Options Panel” on page 55.

Preferences and Default Settings

Preferences and default settings control many aspects of the user interface and tool behavior in Home Designer Suite. You can use these settings to customize the program to suit your personal work style.

For more information about defaults and preferences, see “Preferences and Default Settings” on page 47.

Preferences



Preference settings let you change program behavior to suit your workflow. For example, you can:

- Turn certain display elements on or off.
- Choose background and editing feedback colors.
- Set rendering specifications to maximize efficiency and quality.

Preference settings are global, affecting all plan files.

Defaults

Most objects in Home Designer Suite derive their initial properties from their respective default dialogs.

For example, a newly placed **Window**  gets its initial values from the **Window Defaults** dialog and a newly placed **Hinged Door**  gets its initial values from the **Door Defaults** dialog.

Drawing a Plan

When you draw a plan in Home Designer Suite, you are placing 3D objects that represent building components. Home Designer Suite comes with predefined default settings so you can start drawing plans immediately. You should review these default settings to be sure they match your drawing and building methods. See “Preferences and Default Settings” on page 47.

Set the Defaults

1. Specify the defaults for walls.
2. Set material defaults for roof, walls, and rooms.
3. Set style defaults for doors, windows, cabinets and other objects.

Draw the Floors

1. While the size of the drawing area in Home Designer Suite is limited only by the resources on your computer, it is best to begin your drawing near the origin, 0,0,0. See “3D Drafting” on page 19.
2. Draw the exterior walls on Floor 1. See “Creating Walls” on page 114.
3. Adjust the perimeter shape and size as required. See “Using the Edit Handles” on page 119.
4. Place any first floor bearing walls.
5. Define types for special rooms such as garages and decks in the plan. See “Room Types” on page 132.

Once an object is placed in a plan, its initial properties can be overridden, but setting up your defaults before you begin drawing can save you considerable time as you build a model in the program.

Default settings, unlike Preferences, are file specific.

Dynamic Defaults

Most default settings are static: if you change one, any objects of that type in the current file will not be affected. A few defaults, however, are dynamic: they are tied to existing objects in the drawing and if you change the default, those objects may be affected. See “Dynamic Defaults” on page 48.

6. Place perimeter doors and windows. See “Doors” on page 169 and “Windows” on page 183.
7. Build additional floors. See “Adding Floors” on page 228.
8. Specify the default ceiling height for each floor as soon as it is created. See “Floor Defaults Dialog” on page 227.
9. Adjust the perimeter shape of additional floors as needed. See “Editing Walls” on page 119.
10. Align edited or moved walls with those above or below where appropriate. See “Aligning Walls” on page 121.

Entering Dimensions

When using Imperial units, enter distances as inches or feet and inches, in fractional or decimal form. Millimeters are the default unit for all metric distances. See “Dimensions” on page 147.

- To enter feet, include the (') marker or the program assumes inches.
- In most cases, the program allows precision to 1/16th of an inch. Fractions with denominators 2, 4, 8 and 16 are allowed.
- The program usually converts decimals to fractions.

Build the Foundation

1. Derive the foundation plan from the first floor. See “Building a Foundation” on page 222.

2. Adjust the foundation perimeter shape as needed.
3. Place interior foundation walls as needed for the first floor bearing walls.
4. Place any other foundation walls required.
5. **Align with Above** as needed. See “Aligning Walls” on page 121.

Add Structure and Details

1. Build non-structural interior walls. Begin on floor one and work up in multiple story structures.

2. Add walls where needed to create features such as chimney chases, plumbing walls, or Open Below areas.
3. Finish the relevant interior structure including interior doors, doorways, cabinets, fixtures, and fireplaces.
4. Build the terrain and landscaping. See “Terrain” on page 349.

Viewing Your Plan

You can see your model in a variety of different 2D and 3D views. You can display more than one view at a time; and in any view, you can pan or zoom in or out. See “Window and View Tools” on page 61.

Floor plan view is a 2D view of the model most commonly used for drawing and editing. Each floor displays separately; however, you have extensive control over which objects display at any given time, can easily switch between floors, and can also display items on a second floor for reference. See “Multiple Floors” on page 227.

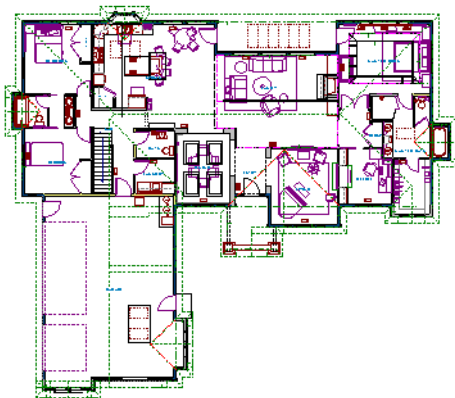

You can create interior and exterior 3D views of your model from any perspective. As in floor plan view, you can select and edit many objects in 3D views and control which objects are visible. See “3D Views” on page 303.

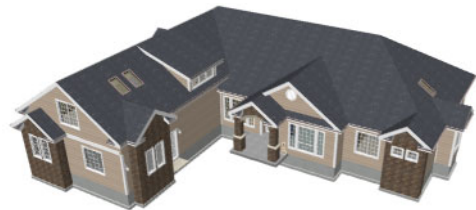

You can also create **Doll House Views** that show only the current floor plus any floors beneath it. Ceilings on the current floor are omitted so you can see the interior, visualize the relationships between spaces, and plan traffic flow.



Framing Overviews display framing in 3D. You can customize 3D views to serve special purposes such as this.



All views can be exported as a graphic image. See “To export a picture” on page 329.

Getting Help

 There are many forms of help available in Home Designer Suite including: Tool Tips, the Status Bar, and the online Help menu.

All these forms of help assume you have a basic working knowledge of your operating system, including how to use a mouse, open, close and save files, copy, paste, and right-click to access contextual menus. Help also assumes you are familiar with basic computer terminology.

More information is available in the product documentation in electronic format and on Home Designer's official web site, HomeDesignerSoftware.com.

See "Resources and Support" on page 391.

Tool Tips

When you move the pointer over a toolbar button or menu item, a **Tool Tip** displays, offering a brief description of the tool. More information displays in the Status Bar at the bottom of the window.

Contextual Help

 Online **Help** is a searchable menu that provides information about all of the tools in

Home Designer Suite. Select **Help> Launch Help** to open the program's Help and explore the table of contents, browse the Index, or Search for keywords.

The Help can also be used to provide instant information about toolbar buttons, menu items, and objects in your plan.

- When you move the cursor over a toolbar button or menu item, a brief summary of that tool displays in the Status Bar. Press the F1 key to open online Help to a page with more information about the tool.
- When an object is selected, edit handles display. Place the cursor over an edit handle and press F1 to open online Help to a page with information about that handle.
- Press the **Help** button in any dialog box to open online Help to a page describing the options in that dialog.

Chief Architect strives to make our documentation as helpful as possible for all of our customers. Please send any suggestions to: documentation@chiefarchitect.com.

About Home Designer

Select **Help> About Home Designer Suite** in Windows® or **Home Designer> About Home Designer** in macOS™ to view information about

your software license, the program's version number, and its release date.

Contact information for Chief Architect, Inc. is available on the MORE INFORMATION panel.

Product Upgrade Options

Select **Help> Product Upgrade Options** to launch your default web browser and learn about options for

upgrading your software license at www.homedesignersoftware.com.

Home Designer Trial Software

Free Trial versions of some Home Designer programs are available for download at HomeDesignerSoftware.com.

The Trial software offers the same functionality as a purchased license with a few limitations:

- File Saving
- Printing
- File Exporting

- Recording of Walkthroughs
- Printing or Exporting of Materials Lists
- Library Browser restrictions

Converting the Trial Version

An installation of the Home Designer Suite Trial software can be converted into a full working version of the program at any time by purchasing a software

license. There are several ways to begin this process in the Trial:

- Click the **Purchase Full Version Now** button in any Trial Restriction message box.
- Select **Help> Purchase Home Designer Suite** .
- Select **File> Startup Options**  and then click the **Purchase Full Version Now** button.

Once you have purchased a license, you can activate it while the Trial software is running.

To activate the full version

1. Select **Help> Activate Full Version**.
2. In the **Product Activation** dialog, type or paste the **Product Key** associated with your software license.
3. Click the **Activate Full Version** button.

File Management

Home Designer Suite saves the complete 3D model of a structure and surrounding terrain as well as any CAD data associated with the model in **.plan** files.

All commands related to opening, saving and closing plans are located in the File menu. You can also open plans from the **Startup Options** dialog. See “Startup Options” on page 17.

Just as with files created in other software applications, you should back up your plan files externally on a regular basis to avoid accidental loss of work.

Compatibility with Other Programs

Plans produced in the following programs can all be read by Home Designer Suite 2021.

- Chief Architect® X1 through X12 (limited editability if enabled)
- Chief Architect® 10.0 through 11.3 (read only)
- All Better Homes and Gardens Home Designer® products, Interior Designer, and Landscaping and Deck Designer, Versions 7 and 8.
- All Chief Architect Home Designer® products, Interior Designer, and Landscaping and Deck Designer, Versions 9 through 2020.

Files that have been opened and saved in Home Designer Suite 2021 cannot be read by any of the program versions listed above. To continue to read files in the program in which they were created, be

Chapter Contents

- Compatibility with Other Programs
- Organizing Your Files
- Home Designer Suite Data
- Creating a New Plan
- Saving, Exporting, and Backing Up Files
- Thumbnail Images
- Auto Archive
- Undo Files
- Opening and Importing Files
- Referenced Files
- Backup Entire Plan
- Exiting Home Designer Suite

sure to create copies of your files before opening them in Home Designer Suite 2021.

Plans produced in the Windows® version of Home Designer Suite 2021 can be read in the Mac® version, and vice versa.

File Association

Although multiple versions of Home Designer can be installed on a computer, the operating system will only associate **.plan**, **.calib**, and **.calibz** files with one of them. If they are not associated with Home Designer Suite 2021, click the **Associate Files with this Program** button in the **Preferences** dialog. See “File Management Panel” on page 53.

Opening Chief Architect Plans in Home Designer Programs

Plans created in Chief Architect Versions 10 through X12 and Home Designer Pro Versions 7 through 2021 can be opened in the latest Home Designer programs for viewing and annotating, but not for general editing or drawing of architectural objects.

Plans created in build 11.4 or later of Chief Architect X1 or Home Designer Pro 8, or in later program versions, can be set to allow limited editability in other Home Designer programs. When this permission is enabled, a Home Designer user can use all of their program's drawing tools and can edit

objects in the plan that those tools can create. If an object cannot be created in the Home Designer program, however, it will not be editable.

Please note, too, that if a plan has more floors than the Home Designer program supports, the entire plan can be viewed and annotated only.

In addition, Chief Architect and Home Designer Pro have the ability to lock layers. Objects cannot be drawn on locked layers; objects on locked layers cannot be selected; and locked layers cannot be unlocked in the other Home Designer programs. See "Layers" on page 74.

Organizing Your Files

You should keep your plan files separate from the support files needed to run Home Designer Suite. To keep files organized, you may find it helpful to create a new folder for each project.

Home Designer Suite files may use imported images, textures and other custom content saved in their own external data files. Consider storing copies of all external files in the same folder as the plan files that use them so that they are easily found.

Here is one way to organize your files:

- Create a folder in your Documents directory called "Home Designer Suite Plans" or another name you prefer. See your operating system's Help to learn how to create folders.

- Inside this folder, make a new folder for each project. Save all the files for that project inside this folder, including plan files and referenced external files. See "Saving, Exporting, and Backing Up Files" on page 34.

Bear in mind, though, that path names exceeding 260 characters cannot be opened by Home Designer Suite. As a result, it is a good idea to limit the number of embedded folders you use in your file organization method.

Once you understand the file management of Home Designer Suite, you can decide on a naming convention that suits your needs.

Home Designer Suite Data

When Home Designer Suite 2021 is installed, the program automatically creates a folder in the user Documents directory called **Home Designer Suite 2021 Data**. This folder contains important user-specific information saved in the following folders and files and should not be moved, renamed or deleted:

- **Archives** - A folder of automatically archived plan files. See "Auto Archive" on page 36.
- **Backdrops** - A folder of custom backdrop images. See "3D Backdrops" on page 307.
- **Images** - A folder of custom images. See "Using the Contextual Menu" on page 279.
- **Database Libraries** - A folder of user library data. See "Library Content" on page 276.

- **Scripts** - A folder for custom Ruby scripts associated with Chief Architect plans.
- **Templates** - A folder of plan template files. See "Creating a New Plan" on page 33.
- **Textures** - A folder where you can save image files used to create custom material textures. See "Creating Materials" on page 299.
- **Toolbars** - A folder of toolbar files. See "Toolbar Arrangement" on page 57.
- **_MigrateBackup** - If you migrated legacy settings into version 2021, additional folders with names appended with **_MigrateBackup** may also be present. See "Migrating Content and Settings" on page 13.

 If the Home Designer Suite 2021 Data folder is renamed, moved or deleted, the program will automatically replace it using default information from the Home Designer Suite installation folder. When this occurs, customized user settings and custom user library content will not be available.

Data Folder Name and Location

The name of the Home Designer Suite 2021 Data folder cannot be changed, but you can specify its

location on your system in the **Preferences**  dialog. See “Folders Panel” on page 53.

If you specify a new location for this folder, the program will not migrate any custom user settings that you might have. Instead, it will automatically create a new folder at that location containing default information from the Home Designer Suite installation folder. If you would like to copy custom settings to the new location, you can do this yourself in an operating system window.

When specifying a location for the Data folder, bear these considerations in mind:

- If you move the Home Designer Suite 2021 Data folder on your computer without specifying its location in Preferences, the program will automatically replace the folder in its default location using default information from the Home Designer Suite installation folder.
- The same will result if you specify a location on a network or removable device and that location becomes inaccessible. For this reason, it is best to use a location on your local hard drive.
- The User Database Libraries in particular may contain a large amount of data. Whatever location you choose to use must be located on a hard drive with sufficient space to hold these files.

Because the Home Designer Suite 2021 Data contains custom user data, it is not deleted when the program is uninstalled. See “Uninstalling Home Designer Suite” on page 15 of the User’s Guide.

Creating a New Plan

 To open the **Create New Plan** dialog, select **File> New Plan**.

You can also choose **New Plan** in the **Startup Options** dialog. See “Startup Options” on page 17.

Template Plans

 When you select **File> New Plan** in Home Designer Suite, the **Create New Plan** dialog opens, letting you select a template for your new plan. The resulting new plan uses either metric or U.S. units of measurement and predefined default settings for objects like walls, doors, windows, and cabinets. See “Default Settings” on page 47.

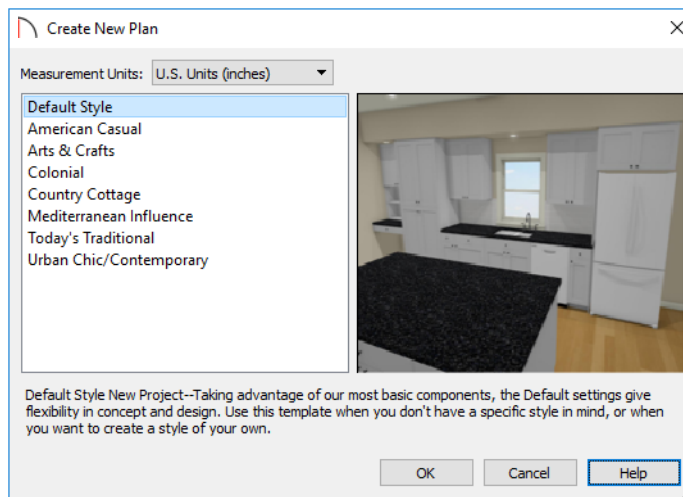

- Select either **U.S. Units** or **Metric Units** of measurement. Once a new plan has been created, its

Measurement Units cannot be changed.

- Select a style template from the list. If you are uncertain as to the right style for your plan, choose Default, as you cannot change the plan style template once a plan has been created.

When you click **OK**, a new floor plan view window opens, ready for you to begin drawing.

New, blank plans are called **Untitled.plan**. Unless these files are named and saved, they will be lost when closed.

When Home Designer Suite opens a new, blank plan file, the new file is actually a copy of a template using either metric or U.S. units of measurement and predefined default settings. See “Creating a New Plan” on page 33.

Select Template Dialog

When a new, blank plan file is opened in Home Designer Suite, the new file is actually a copy of a template using either metric or U.S. units of measurement and predefined default settings.

Creating a new plan without referencing a template file is not recommended. If you try to create a new plan using a template file that is not available, the

Select Template dialog will prompt you to specify a template for the new file you are creating.

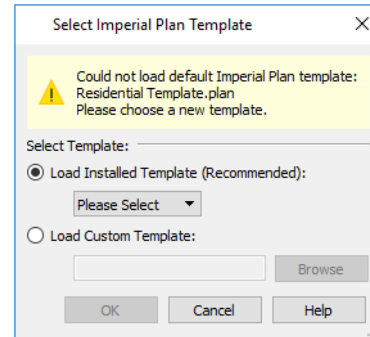

- Select **Load Installed Template (Recommended)**, then select a template file from the drop-down list.
- Select **Load Custom Template**, then click the **Browse** button and browse to a plan file saved on your computer.
- You can also type or paste the full path name of a file in the text field.

If you encounter this dialog, make sure that the program Data folder is at a location that can be accessed by the program. See “Home Designer Suite Data” on page 32.

Saving, Exporting, and Backing Up Files

Saving, exporting, and backing up your files are three separate tasks that accomplish different things:

- Saving a plan file retains your work so that it can be later opened in Home Designer Suite.
- Exporting a file allows you to save certain kinds of data in a format that can be used by a program other than Home Designer Suite.
- Backing up your files involves taking steps to make sure that your valuable data is protected and available when needed.

Whether you are saving, exporting, or backing up your data, it is important that you select a location on your computer for the files you create, and also specify a short, meaningful name that you will be able to identify in the future.

To save an untitled plan file

1. Select **File> Save**  to open the **Save File** dialog.



2. Specify a location on your computer where you would like to save the file. See “Organizing Your Files” on page 32.
3. In the **File name** text field, type a name for the file.
4. Home Designer Suite automatically assigns the **File of type** and file extension **.plan**.
5. When both the Save in location and File name are correct, click **Save**.



 Although the program warns you if you try to exit without saving, you should get in the habit of saving plan files before exiting the program.





Saving Plan Files



When you first save a new, untitled file, you must select a location for it on your computer and give it a name. There are two options for saving plan files: **File> Save** and **File> Save As**.

Both **Save**  and **Save As**  can be used to save your plan files; however, they accomplish this in two different ways.

- **File> Save**  saves the current state of your plan file without changing its name and should normally be used for saving your work.
- **File> Save As**  opens the **Save File** dialog, allowing you to save the plan file using a different name or location on your computer.

Initially, all **Open**  and **Save As**  operations go to your Documents directory. After that, the location last visited is remembered and subsequent **Open**  or **Save As**  commands default to the directory last used for that operation. This path is saved when the program exits. The next time Home Designer Suite is launched, these defaults are used.

Save File Dialog

The **Save File** dialog uses the operating system's save dialog format, and is also used when exporting files. The dialog name may vary, depending on the type of file being saved or exported.

A similar **Select Folder** dialog allows you to select a folder to which files can be exported.

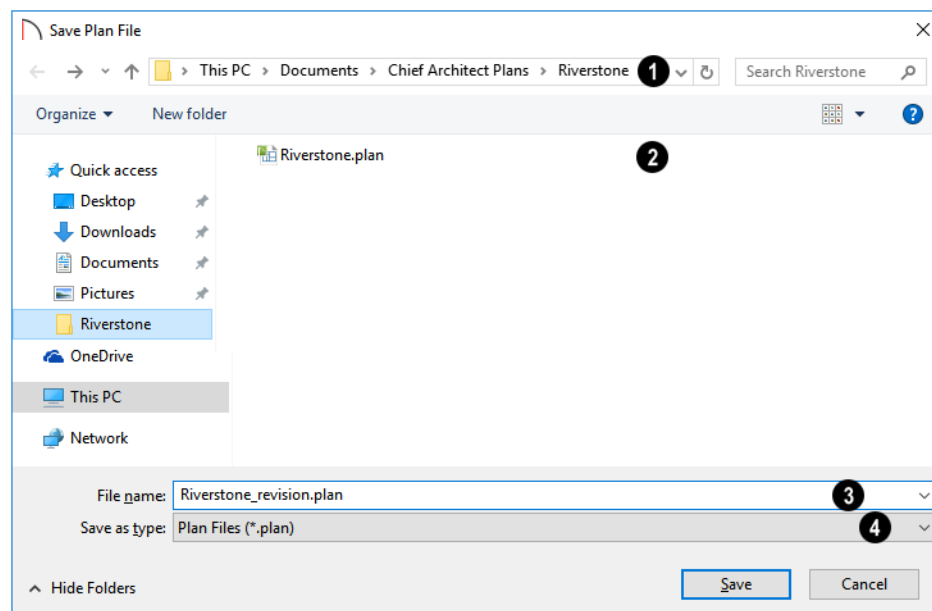

- 1 Choose a location on your local computer for the file you are saving.
- 2 Any existing folders and/or files in the current location display here.
- 3 In the **File Name** field, type a name for the file. If you select an existing file from the space above, its name will display here automatically.
- 4 When saving a file, the program will choose the appropriate file type from the **Save as type** drop-down list. When exporting, you may need to choose a specific file type.

Saving Revision Files

Revisions are a common aspect of any design project. There are a number of possible strategies for organizing revision files:

- Prepending the file name;
- Appending the file name;
- Saving revisions in separate folders.

To avoid confusion and potential mistakes, it is recommended that you always give files unique names - including revision files. If you choose to organize your revisions by saving them in separate folders, you should also give each file a unique name

that makes it impossible to confuse it with another file saved in a different folder.



Exporting Files

Home Designer Suite has a number of options for exporting and importing information out of and your drawings. See “Pictures, Images, and Walkthroughs” on page 325.

Often, file export dialogs are simply versions of the **Save File** dialog.

Similarly, file import dialogs are often similar to the **Open File** dialog. See “Importing Files” on page 38.

Backup Entire Plan

File> Save As  is a simple way to transfer a plan to a different location on your computer. Bear in mind, though, that plan files often reference external data files such as imported textures, images, and backdrops. These external files are not affected when **Save As**  is used.

If you transfer a plan file from one computer to another, the program will warn you of missing files if the external data files used by the plan cannot be found when you open it.

When transferring plans to another computer that does not have these external files, use the **Backup**

Entire Plan  tool. See “Backup Entire Plan” on page 40.

Backing Up Your Files

It is always a good idea to create backup copies of all your important files on your computer.

It is strongly recommended, however, that you never save directly onto removable media such as a USB thumb drive. Instead, copy your files to such locations only after you have saved them on your computer’s hard drive and exited the program.

Archive folders are used by Home Designer Suite to manage prior versions of your files. You should not view these files as a substitute for your own backup routine, and should never save a file in an archive folder. See “Auto Archive” on page 36.

When backing up your Home Designer Suite files, consider backing up not only your **.plan** files, but your custom user data, as well - including library content, toolbar configurations, and textures. This custom data is all located in the Home Designer Suite Data folder, so it can be easily backed up. See “Home Designer Suite Data” on page 32.

You can, if you wish, create a folder inside the Data folder for your **.plan** files, as well. See “Organizing Your Files” on page 32.

Thumbnail Images

A thumbnail is a miniature image that helps identify a file in the **Open Plan File** dialog in Windows. Any view of a plan can be saved as the thumbnail.

The program automatically creates a thumbnail image when you first save a new plan. You can choose to generate small or large thumbnails.

To create a custom thumbnail image

1. You must save the file and give it a name before you can save a thumbnail.

Auto Archive

The first time a plan is saved, Home Designer Suite creates an Archive folder in the Home Designer Suite Data folder. The Archive folder contains Auto Save and Archive files.

The program does not create Auto Save and Archive files for untitled plans. In order for these to be

2. Create the 2D or 3D view that you want to use as a thumbnail for the current file.
3. With the desired view active, select **File> Save Thumbnail Image** .

Thumbnail images are saved in the plan file that they are associated with.

created, a file must have been previously saved and given a name and save location on your computer. Further, Archive files are only updated when you save your work.

Auto Save and Archive files should not be viewed as a substitute for regularly saving your work by

selecting **File> Save**  or pressing Ctrl + S on the keyboard, nor should they be considered an alternative to your own file backup routine.

Archive Files

Every time a drawing is saved, Archive files that keep a historical archive of your plan are automatically created or updated.



 If you do not save your work regularly, your archive files will not be updated.

Plan files from previous versions of the program are automatically moved to the archive folder when the plan is opened and saved in Home Designer Suite.

Archive files are meant to be for emergency use only. If you must access an archive file, open it as you would any other file. See “Creating a New Plan” on page 33. As soon as the file is open, use **Save As**  to save this file to another location.

Legacy Archive Files



Plan files saved in the current program version are not backwards-compatible: that is, they cannot be opened in older versions of the software.

If you open a Home Designer plan file from a previous program version and immediately **Save**  it (not **Save As** ) , the Auto Archive utility will create an additional archive file using the original program version format. This archive file is a copy of the original and can still be opened in the original program version.

Auto Save Files

As you work, Home Designer Suite automatically creates Auto Save files at regular intervals when

Undo Files

Home Designer Suite stores a set number of copies of all open plan file changes, known as undo files. Undo files are referenced whenever you select **Edit> Undo**  or **Edit> Redo** . See “Undo and Redo” on page 100.

Opening and Importing Files

Opening and importing files are often similar tasks,

changes are made to a file but not saved by selecting **File> Save** .

These Auto Save files are appended **_auto_save.plan** and are saved in the Archive folder.

When you close a file normally, its Auto Save file is retained until the next time the file is opened - at which time the Auto Save file is overwritten.

 JonesResidence_auto_save.plan

Auto Save file after normal shut-down

Auto save files created as a result of an improper program shutdown are appended **_auto_save_bak.plan**.

 JonesResidence_auto_save_bak.plan



Auto Save file after abnormal shut-down

If your computer shuts down accidentally, you can recover some of your work by opening the **_auto_save_bak** file.

 A file is auto saved only if you have saved it previously. Auto Save does not work for unnamed files.

When you reopen a file after a computer shut down or system crash, the program will notify you if an Auto Save file newer than the original file is found and give you the option to one that file.

Even with Auto Save, you should save your work manually on a regular basis using any of the following methods:

- Click the **Save**  button.
- Select **File> Save** .
- Press Ctrl + S on the keyboard.

Undo files are stored in your operating system’s Temp directory. When Home Designer Suite is closed normally, any current Undo files are deleted.

but accomplish two very different things:

- Opening a file refers to opening it in the program in which it was created. Only plan files can be opened in Home Designer Suite. See “Compatibility with Other Programs” on page 31.
- Importing a file brings data that was created in a different program into Home Designer Suite. A number of different file types can be imported into Home Designer Suite.



Select **File> Open Plan** to open an existing **.plan** file located on your computer. Home Designer Suite automatically browses to the directory last used.



Before opening a file located on a removable storage device, server, or other computer on a network, copy it to your local machine's hard drive first.

Open File Dialog

The **Open File** dialog uses the operating system's open dialog format, and is also used when importing files. The dialog name may vary, depending on your

operating system and the type of file being opened or imported.

A similar **Select Folder** dialog allows you to select an entire folder of files to import.

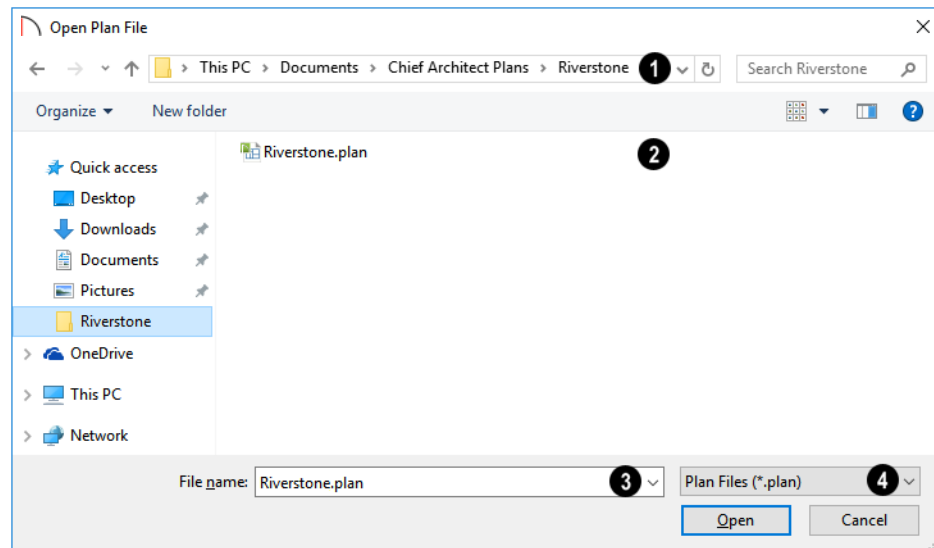

- 1 Choose the location on your local computer for the file you are opening.
- 2 Any existing folders and/or files in the current location display here.
- 3 In the **File Name** field, type the file's name. If you select the file in the space above, its name will automatically display here. When importing some types of files, multiple files may be selected.
- 4 When opening or importing a file, the program will usually choose the appropriate file type from the **Save as type** drop-down list. When importing, you may need to choose a specific file type.

Plan files open to the floor that was active when the file was last saved and closed.

Importing Files

Home Designer Suite has a number of options for exporting and importing information out of and into your drawings. Often, file import dialogs are simply versions of the **Open File** dialog. See “Pictures, Images, and Walkthroughs” on page 325.

Similarly, file export dialogs are often similar to the **Save File** dialog. See “Exporting Files” on page 36.

Recently Opened Files

A list of recently opened and saved plan files can be accessed by selecting **File> Open Recent Files**. Select one of these files to open it without using the **Open File** dialog.

The names of recent files also display in the **Startup Options** dialog. Click on the name of a file to open it. See “Startup Options” on page 17.

Referenced Files

Home Designer Suite plan files often reference a variety of external files for added detail, including:

- Material Textures
- Images
- Plant Images
- 3D Backdrops
- Picture Files
- PDF Files

Whenever any view in a plan is opened, the program checks for referenced files used in that view and will notify you if any of those files cannot be found by opening the **Missing Files** dialog.

You can also open this dialog at any time by selecting **Tools > Checks > Missing Files**. When accessed this way, all missing files associated with the current file are listed: not just those used in the current view.

Missing Files Dialog

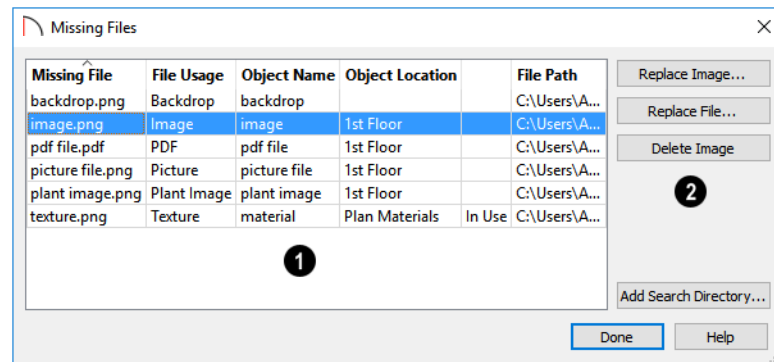

- 1** The table lists any Missing Files as well as useful information about each:
- **Missing File** reports the name and file extension of the missing file.
 - **File Usage** indicates how the missing file is used in the program.
 - **Object Name** states the name of the object in Home Designer Suite that references the file.
 - **Object Location** indicates where in the file the object can be found.
 - The next column indicates whether a missing texture is in use in the plan.
 - **File Path** states the last known location of the missing file on your computer system.

Click on a line item in the table to select it and resolve it using the options on the right. Multiple line items can be selected; however, the selections on the right may be limited. See “Shift and Ctrl Select” on page 81.

- 2** The buttons on the right offer options for resolving a selected missing file. The names of these buttons will vary somewhat, depending on the type of file(s) selected in the list on the left.

- Click the top **Replace Object** button to replace any instances of an object or material referencing the selected missing file with a different object or material from the library. Not available for PDF files or picture files.
- Click the **Replace File** button to open the **Browse for Missing File** dialog and select a file saved on your system to replace the missing one. See “Opening and Importing Files” on page 37.
- Click the **Delete Object** button to remove the object or material referencing the missing file from the plan. Not available for material textures that are In Use.
- Click the **Add Search Directory** button to direct the program to a particular folder to search for missing files in. The list of Search folders can be

reset in the **Preferences**  dialog. See “Reset Options Panel” on page 55.

You can prevent this dialog from opening automatically by checking **Do not display missing**

Backup Entire Plan



Because Home Designer Suite plans contain many references to external files such as material textures and images, it is a good idea to make copies all the associated files when a plan is moved to a new location. You can easily do this by selecting **File> Backup Entire Plan**.

Backing up an entire plan is important when:

- Migrating legacy files created in older program versions.
- Transferring files to another computer or sending them to another user.
- Archiving or backing up your work.

To back up a plan

1. To copy all associated plan files to a new directory, select **File> Backup Entire Plan** .
2. The **Backup Entire Plan** dialog opens.

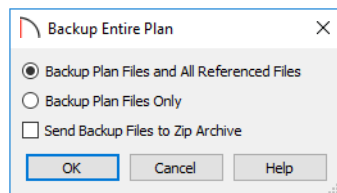

- Choose **Backup Plan Files and All Referenced Files** to copy the plan file and all exter-

files again during this session at the bottom of the dialog. This option is not available when the dialog is opened manually.

nally referenced files such as inserted picture files, metafiles, and texture, image, and back-drop graphics files.

- Choose **Backup Plan Files Only** to copy any externally linked files and inserted picture files, but no graphics or texture files. This is best used only when transferring a file to a computer that already has the graphics files installed.
 - Check **Send Backup Files to Zip Archive** to save the files in a zipped folder instead of a regular folder.
 - Click **OK**.
3. The **Select the Plan Backup Folder** or **Choose Zip Archive to Backup** dialog opens next. This is a typical Save File dialog. See “Saving, Exporting, and Backing Up Files” on page 34.
 - Navigate to a folder on your system and select it.
 - With the destination folder for the backup selected, click **OK**.
 4. If the destination folder already contains files, the program will confirm whether you want to overwrite them.

The resulting folder contains a copy of the plan or layout file and all referenced files, and can be moved to a new computer

Exiting Home Designer Suite

Select **File> Exit** to exit the program. If you have not saved any open files, you will be reminded to do so. It is better to save your work before exiting than to save on exit. See “Closing Views and Files” on page 65.

When you exit from the program using **File> Exit**, all Autosave files and Undo files are automatically deleted.

On a Mac, if you click the program window’s red **Close** button, the window will close but the program itself will continue to run. To close it down completely, right-click on its icon on the Dock and select **Quit** from the contextual menu.

Project Planning

The tools described in this chapter allow you to conduct preliminary budget and space planning, and to run checks on plans so you can be more confident that they are free of common drawing errors.

Chapter Contents

- Space Planning
- Room Box Specification Dialog
- Plan Check
- Loan Calculator

Space Planning

 The **Space Planning Tools** are a time-saving way to create a preliminary room-by-room design of a home without getting caught up in the details. When the room boxes are laid out, the **Build House** tool converts them into a working plan that can be edited and detailed to completion.

Room boxes can now be arranged into a floor plan.

Note: Each Bedroom called for in the Space Planning Assistant also produces a Closet.

Space Planning Assistant

 In plan view, select **Tools> Space Planning> Space Planning**. The **Space Planning Assistant** gathers information about the rooms you want to include in your house. When you click **Finish**, the selected room boxes display.

Placing Room Boxes

In addition to or as an alternative to the room boxes created for you by the **Space Planning Assistant**, you can create your own room boxes. In plan view, select **Tools> Space Planning** , choose the desired room type from the submenu, then click to place a room box of that type.





Displaying Room Boxes

Room boxes and their labels are located on the “Space Planning Boxes” layer. Space Planning Box labels use the Text Style assigned to that layer, as well. See “Displaying Objects” on page 73.

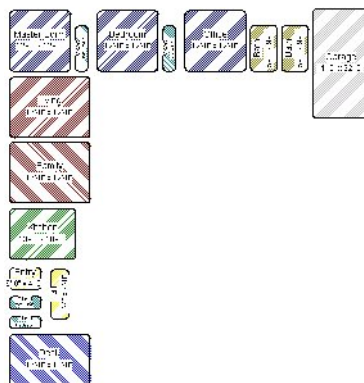
Editing Room Boxes

Once created, room boxes can be edited in a variety of ways.



- Select room boxes using the **Select Objects**  tool just like other objects in Home Designer Suite. See “Selecting Objects” on page 79.
- Room boxes can be resized, rotated, and rearranged. See “Editing Box-Based Objects” on page 89.
- Try to line up the rooms so that they are just touching. Excessive overlaps may cause your rooms to form incorrectly. Closets are the exception. You can overlap a room with a closet, or place in inside another room box.
- Rooms can be copied and pasted using the **Copy/Paste**  edit button and deleted using the **Delete**  edit button.
- Select **Tools> Space Planning**  to access the room box tools and place additional room boxes in your plan. Select a tool and click in the plan to place a room box of that type.
- Select **Tools> Space Planning> Toggle Room Boxes**  to hide or show the room boxes.

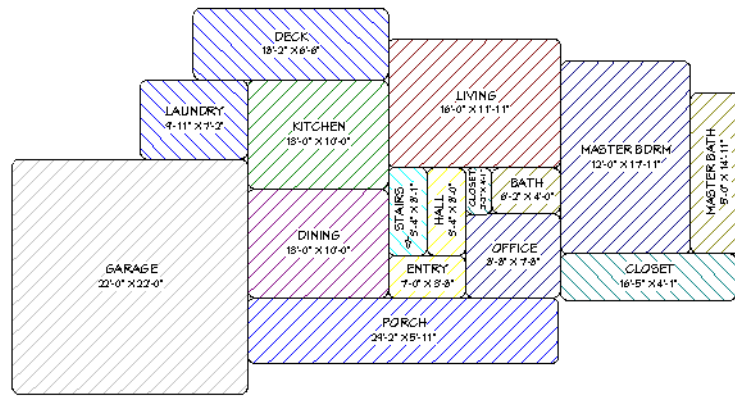

Build House



When the room boxes are in place, select **Tools> Space Planning> Build House** to convert them into a building composed of

walls and railings. Doors are inserted between the rooms, as well.

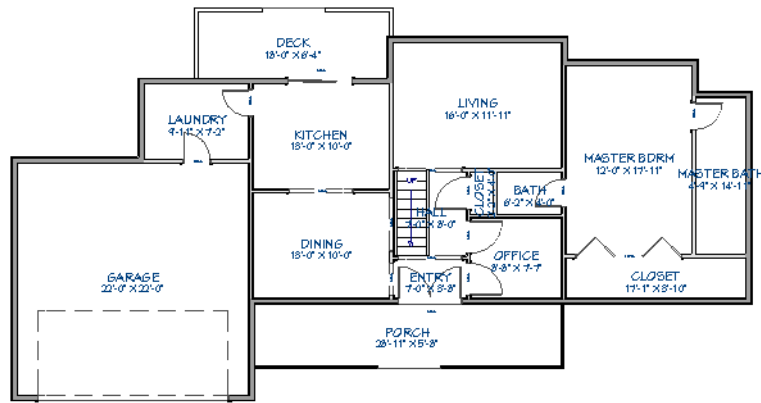



When you Build House, the “Space Planning Boxes” layer is automatically turned off. The room boxes that you created are not deleted, however.

1. Edit and arrange the room boxes on Floor 1 as desired.
2. Select **Tools> Space Planning> Build House**  tool to create the walls on the first floor.

Multiple Floors

If you specified a two-story house in the **Space Planning Assistant**:

3. Go **Up One Floor**  and notice that the positions of the walls on Floor 1 display in red as a reference.
4. Arrange the rooms on Floor 2 as desired using the red polylines as a guide.
5. On the second floor, select **Tools> Space Planning> Build House**  to complete the second floor.

Room Box Specification Dialog

 Select one or more room boxes and click the **Open Object** edit button to open the **Room Box Specification** dialog.

General Panel

Most of the settings on the GENERAL panel are used when the selected room box is converted to a room using the **Build House**  tool.

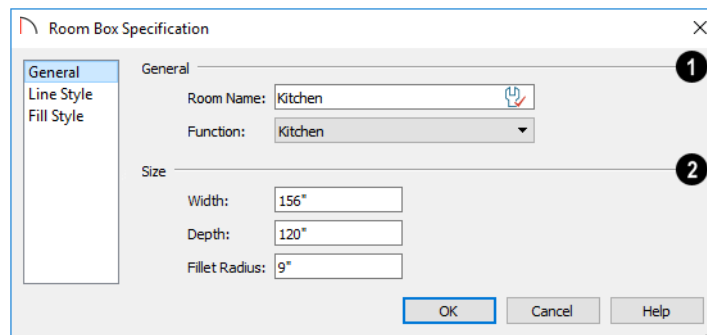

- 1 Specify the selected room box's **Room Type and Name**.
 - Specify a **Room Name** for the selected room box. When the default is specified, the Function selected below is used as the name.
 - Select a **Function** from the drop-down list. See "Room Types" on page 132.
- 2 Specify the **Size** of the selected room box.
 - Specify the room box's **Width** and **Height**.
 - Specify the **Fillet Radius**, which is the radius of the curve on each of the room box's corners. Unlike the other settings on this panel, this value

does not affect the shape of the room created using **Build House** .

Line Style Panel

The LINE STYLE panel is available for a variety of other objects in the program. For more information, see "Line Style Panel" on page 103.

Fill Style Panel

The FILL STYLE panel is available for a variety of other objects in the program. See "Fill Style Panel" on page 76.

Plan Check

 **Plan Check** examines the current floor of a plan, checking for anything that appears to violate common building practices. Plan Check may not find all the problems in a plan, but does it point out areas that may need improvement.

 **Disclaimer:** The Plan Check feature in Home Designer Suite does not claim to detect all building code and design requirements. It merely compares your plan with common building practices.

To run Plan Check, select **Tools> Plan Check** .

Potential plan errors found are usually highlighted in plan view. To ensure the highlighted item is on-screen, make sure the entire plan is shown in the window before you run **Plan Check** .

Plan Check Dialog

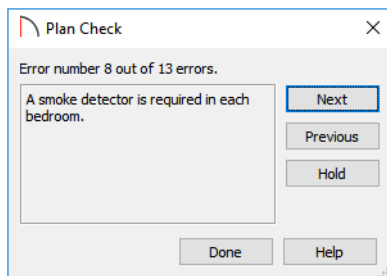

The current error number, along with the total number of errors found, is stated at the top of the dialog.

A description of the current error displays in the field on the left.

Options for navigating Plan Check are found on the right side.

- Click **Next** to ignore the current error and proceed to the next.

Loan Calculator





Select **Tools> Loan Calculator** to open the **Loan Calculator** dialog. This dialog lets you calculate different aspects of a loan for the current plan based on a variety of parameters.

- Click **Previous** to return to the previous error.
- Click **Hold** to suspend Plan Check so you can fix the current error. Select **Tools> Checks> Plan Check** again and the check starts where it left off.
- Click **Done** to terminate Plan Check.

If this dialog obscures the plan view, drag its title bar to move it. It remembers its new position and displays there the next time **Plan Check**  is run.

Room Types

Plan Check  can do a much better job of checking for problems if it knows what the rooms in your plan are to be used for, so you should assign a Room Type to each room in your plan. See “Room Types” on page 132.

The first time **Plan Check**  runs in a plan, it automatically assigns a room type to as many undesignated rooms as it can. Some rooms are determined by their size and shape, and others by their contents. For example, a shelf in a small room indicates a closet; a stove or refrigerator indicates a kitchen; or a bed, a bedroom. If the program cannot assign a room type, **Plan Check**  highlights it and suggests that you do so manually.

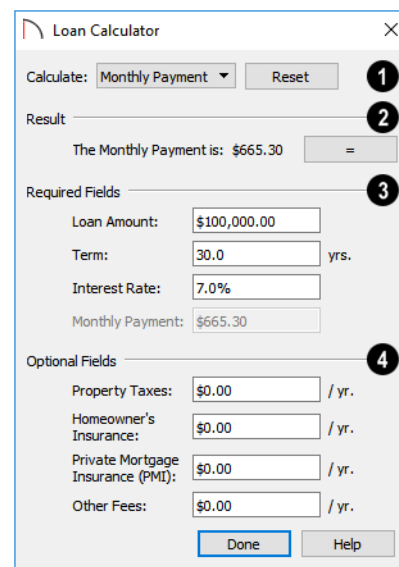

- 1 Specify what aspect of the loan you would like to calculate from the **Calculate** drop-down list:

- Monthly Payment
- Loan Amount
- Term
- Interest Rate

② The calculation **Result**, based on the information you provide, displays here.

If you make changes to any of the fields in the dialog, click the = button to refresh the **Result**.

③ The **Required Fields** are the same as the options in the **Calculate** drop-down list. The option selected under **Calculate** will be inactive under **Required Fields**.

- Specify the desired **Loan Amount**.
- Specify the desired **Term**, in years.
- Specify the desired **Interest Rate**.
- Specify the desired **Monthly Payment**.

④ The **Optional Fields** allow you to include additional information in your loan calculation.

- Specify the expected **Property Taxes** per year.
- Specify the expected **Homeowner's Insurance** cost per year.
- Specify the expected **Private Mortgage Insurance (PMI)** cost per year.
- Specify the cost of any expected **Other Fees**.

When Monthly Payment is calculated, each Optional value is divided by twelve (months) and then added to the total payment.

When a Calculate option other than Monthly Payment is selected, these values are divided by twelve (months) and then subtracted from the specified Monthly Payment value. The result, which does not display, is then used to determine the Loan Amount, Term or Interest Rate.

Preferences and Default Settings

Preferences are global settings that affect the functionality and appearance of the Home Designer Suite environment, while default settings control what objects look like when they are initially created. You can save time by becoming familiar with these settings and customizing them before you begin a new drawing.

Chapter Contents

- Default Settings vs Preferences
- Dynamic Defaults
- Reset to Defaults
- General Plan Defaults Dialog
- Preferences Dialog
- Angle Style Dialog

Default Settings vs Preferences

Default and preference settings have important effects on how the tools in Home Designer Suite function. Default settings are file specific, while Preferences are global, taking effect regardless of what file is open.

Defaults and Preferences can be customized to suit your needs, so it is recommended that you become familiar with them and learn how you can use them to your advantage.

You can access a complete list of the various default settings in the current plan file by selecting **Edit>**

Default Settings  from the menu.

Default Settings



Default settings determine the initial characteristics of objects when they are first drawn. For example, when you place a base cabinet in a plan, its size, materials, front items, and hardware are determined by settings in the **Base Cabinet Defaults** dialog.

Defaults are file-specific, which means that any changes that you make to the default settings in one plan file will have no effect on other plans.

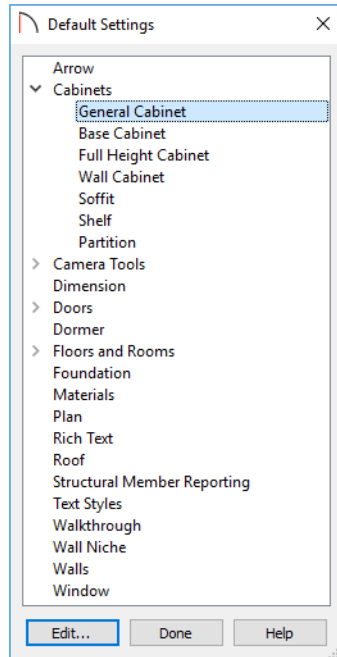

- Click the + beside a category to expand it and access the defaults for items related to that category.
- To open the defaults dialog associated with an item in the list, double-click on the line item, or click on the item and then click the **Edit** button.

Dynamic Defaults

Dynamic defaults are values that can be changed globally throughout the current plan file. They are available for a variety of objects, including dimension lines, walls, doors, cabinets and rooms.

- If you change a dynamic default value in a defaults dialog, all objects of that type that are set to use the default will update automatically to use the new value.
- Any objects of that type that are not using the default value because of editing will not be affected if you change the default.

Dynamic defaults are presented in several different ways in specification dialogs. Some settings have a **Use Default** radio button, or a “Use Default” option in a drop-down list.

Dynamic default check boxes have a **Default** checkbox. Uncheck this box to make the setting not dynamic, or check it again to restore the dynamic behavior.

Preferences

 Preference settings influence the overall environment of the program, such as what the interface looks like and how the tools are accessed. See “Preferences Dialog” on page 50.



Unlike default settings, Preferences are global, which means that any changes that you make to them will take effect in all plan files.

To access the **Preferences** dialog, select **Edit**>

Preferences  from the menu.

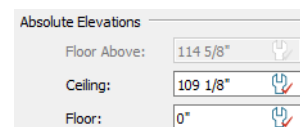
Dynamic default text fields have an Active Defaults  icon in the value field.



- Click on the Active Defaults  icon to remove the red check mark and prevent the value from being dynamic.
- Type a value into the text field. The red check mark is removed from the Active Defaults icon and the setting is no longer dynamic.
- Click on the Defaults  icon to restore the red check mark and make the setting dynamic again.

Materials are another example of an attribute that uses Dynamic Defaults. See “Material Defaults” on page 294.

Reset to Defaults

Select **Edit > Reset to Defaults** to open the **Reset to Defaults** dialog.

This dialog allows you to reset critical structural settings in the current plan to the default values.

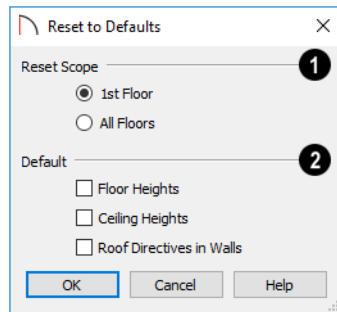

- 1 The settings can be cleared for the **current floor** or for **All Floors**.
 - 2 Specify which settings you want to reset to **Default**.
- Check **Floor and Ceiling Heights** to reset the default values as specified in the **Floor Defaults** dialog. Floor and ceiling heights for any room can be changed in the **Room Specification** dialog. See “Floor Defaults Dialog” on page 227.
 - When **Roof Directives** are reset, all items on the **ROOF** panel of the Wall Specification dialog are reset to the default. See “Roof Directives in Walls” on page 256.

General Plan Defaults Dialog

The settings in the **General Plan Defaults** dialog control basic features of the Home Designer Suite environment in plan files. Just as with other default settings, they are file specific, which means that they

can be set differently in individual plan files. To open this dialog, select **Edit > Default Settings** , select **Plan**, and click the **Edit** button.

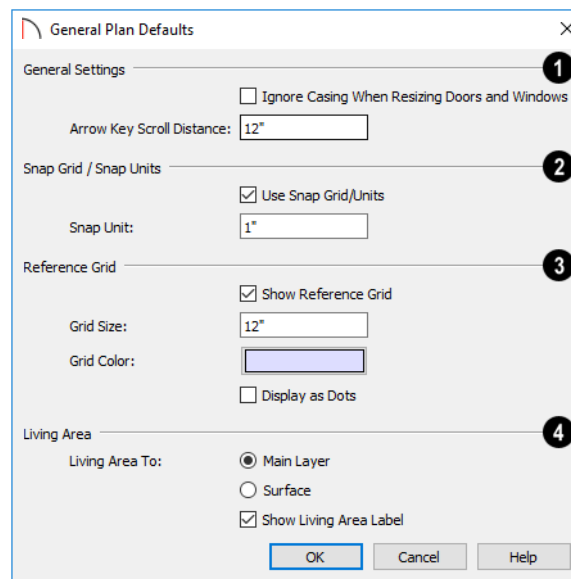

- 1 **General Settings** - Specify the default functionality for a variety of general behaviors in the program.
- Casing is the trim that surrounds a door or window. When you resize a door or window, its sides are kept away from intersecting walls by the width of the casing. Check **Ignore Casing for Opening Resize** to allow wall openings to be

positioned against an intersecting interior wall. Clear this box retain sufficient space for the opening's specified interior trim width.

- The **Arrow Key Scroll Distance** setting determines how far to scroll in plan view when you press an arrow key. The initial default is 12 inches (300 mm). See “Using the Arrow Keys” on page 64.

- 2 The **Snap Grid** allows you to snap objects to specific points on-screen as they are moved or resized. See “Grid Snaps” on page 68.
 - Check **Use Snap Grid/Units** to enable Grid Snaps.
 - Specify the **Snap Unit** you wish to use. The initial default is 1 inch (10 mm).
- 3 Specify the display of the **Reference Grid**.
 - Check **Show Reference Grid** to display the Reference Grid, the virtual graph paper used to create a sense of scale in plan view.
 - Specify the **Reference Grid Size**.

- Check **Display as Dots** to display the Reference Grid using dots rather than lines.
- 4 Specify how the **Living Area** label is calculated and whether it displays in plan view. See “Living Area” on page 137.
 - Select **Main Layer** to have the Living Area calculation measure from the walls’ Main Layer.
 - Select **Surface** to have the Living Area calculation measure from the walls’ exterior surface.
 - Uncheck **Show “Living Area”** to disable the display of the Living Area label.

Preferences Dialog

 The settings in the **Preferences** dialog are global: they apply to all plan files and are preserved between sessions. To access this dialog, select **Edit> Preferences** in Windows® or **Chief Architect> Preferences** in macOS™. Unlike most dialogs in the program, it is not necessary to have a plan file open to access the **Preferences** dialog.

The **Preferences** dialog’s list of panels is organized in a tree structure with categories and subcategories. A white arrow next to a category indicates that it has

subcategories. Click the arrow to make the subcategories visible or to hide them.

Preferences dialog panels:

- Appearance Panel
- Colors Panel
- Library Browser Panel
- General Panel
- Folders Panel
- Edit Panel
- Render Panel
- Video Card Status Panel
- Reset Options Panel

Appearance Panel

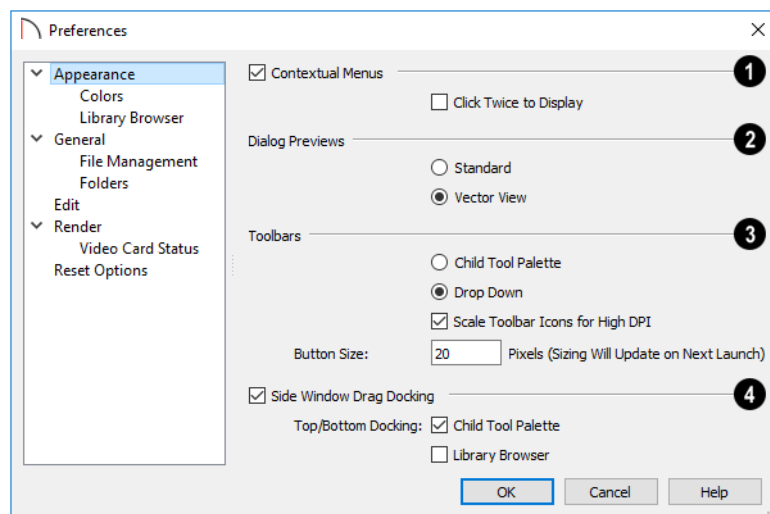

- 1 Check **Contextual Menus** to activate contextual menus that display when you right-click. See “Contextual Menus” on page 23.

- Check **Click Twice to Display** to require two right-clicks on an object before the contextual menu displays. This allows the first right-click to be used for object selection. See “Selecting Objects” on page 79.

In 3D views, the two clicks must be on the same object surface in order for the contextual menu to display: Clicking on two different surfaces of the same object is treated like two single-clicks.

- 2 Specify how **Toolbars** present child tools when a parent button is clicked.
 - Choose **Parent-Child** to display child tools as buttons at the end of the toolbar where the parent button resides.
 - Choose **Drop Down** to display child tools when the drop-down arrow to the right of the parent button is clicked.
 - Uncheck **Scale Toolbar Icons for High DPI** to prevent toolbar icons from becoming larger on systems running Windows 7 or 8 and using high DPI resolution. When checked, toolbar buttons

will increase in size when high DPI is used. Not available in the Mac version of the software.

- Specify the desired toolbar **Button Size**, in pixels. Increasing this value will proportionally resize the text in the drop-down toolbars, as well. See “Toolbar Button Size” on page 58.
- 3 Uncheck **Side Window Drag Docking** to prevent undocked side windows from docking when moved using the mouse. A side window can still be docked to its last docked location by double-clicking its title bar. See “View and Side Windows” on page 22.
 - **Top/Bottom Docking** - Check the box beside a side window’s name to allow it to dock on the top and bottom edges of the program window. Does not affect docking to the left and right sides.

Colors Panel

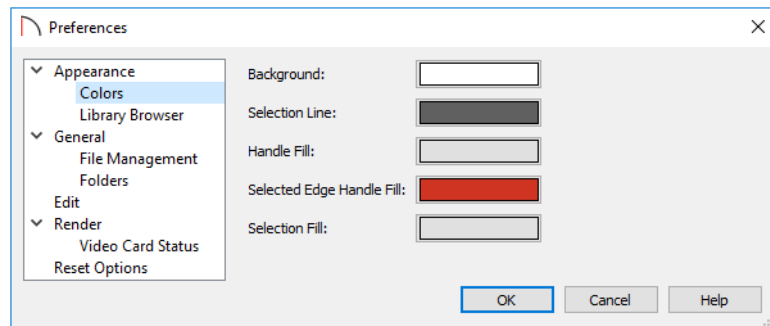

Specify the **View Colors** for a variety of different elements in the software’s interface by clicking a color bar to open the **Select Color** dialog. See “Select Color Dialog” on page 77.

- Specify the **Background Color** for plan view. The background colors for 3D views can be set in their defaults and specification dialogs. See “3D Backdrop Panel” on page 317.
- Specify the **Selection Line** color, which is the color of the lines that represent object(s) and their edit handles when they are selected.
- Specify the **Handle Fill** color, which is the fill color of the edit handles for selected objects.
- Specify the **Selected Edge Handle Fill** color, which is the fill color of the edit handle on a selected object’s Selected Edge. See “Selected Edge” on page 80.

- Specify the **Selection Fill** color, which is the fill color for selected objects. Note that depending on the fill assigned to a selected object, its Selection Fill color may vary.

Note: If the Selection Line and Handle Fill Colors are similar, it may be difficult to distinguish between active and inactive CAD Points.

In the Mac version of the software, specify the **Interface Colors** that you want to use in Home Designer Suite by selecting an option from the drop-down list:

- Select “System” to use your operating system’s color settings.
- Select “Force Light” to use Light Mode in Home Designer Suite regardless of the system settings, or “Force Dark” to use Dark Mode in Home Designer Suite regardless of the system settings.

Library Browser Panel

The LIBRARY BROWSER panel controls the appearance of the Library Browser window. See “The Library Browser” on page 271.

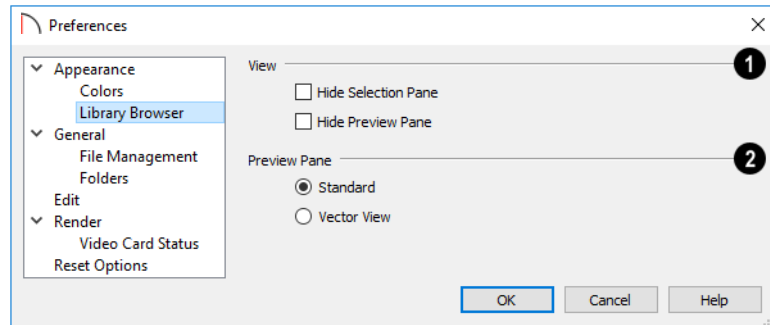

- 1 The **View** options control the display of the main sections of the Library Browser.
 - Check **Hide Selection Pane** to hide the pane that displays objects in a selected catalog or folder.
 - Check **Hide Preview Pane** to hide the pane that shows a preview of a selected object.
- 2 Specify whether selected library items in the **Preview Pane** are displayed using the

Standard Rendering Technique or in a line-based **Vector View**. See “Rendering Techniques” on page 323.

To restore the original size and position of the Library Browser and other side windows, click the **Restore Side Windows** button on the Reset Options Panel.

General Panel

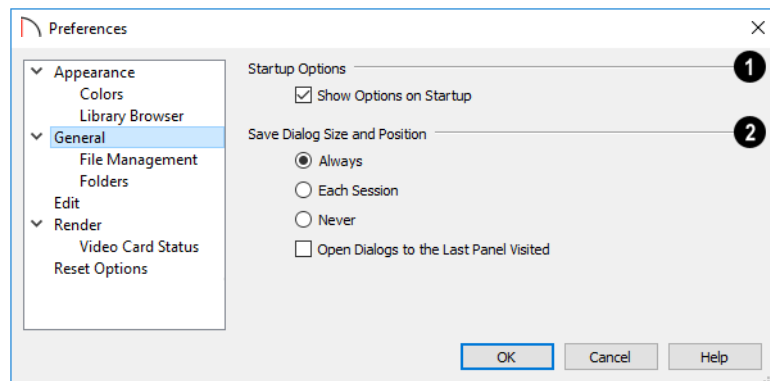

- 1 When **Show Options at Startup** is checked, the **Startup Options** dialog opens when Home Designer Suite is launched. See “Startup Options” on page 17.
- 2 Specify when the program should **Save Dialog Size and Position: Always, Per Session, or Never**. See “Dialog Size and Position” on page 25.
 - Check **Open Dialogs to the Last Panel Visited** to open paneled dialogs to the last panel that you accessed during the current program session.

When unchecked, dialogs always open to the first panel. See “Dialogs” on page 24.

- 3 **Troubleshooting** in the Mac version only -
 - When **Mouse Movement Optimizations** is checked, zooming using the mouse scroll wheel is optimized for Mac systems. This box is checked by default and should only be unchecked when troubleshooting issues with the mouse scroll wheel in the Mac version of the software only.

File Management Panel

The settings on the FILE MANAGEMENT panel let you modify functions related to the program’s plan and layout file management.

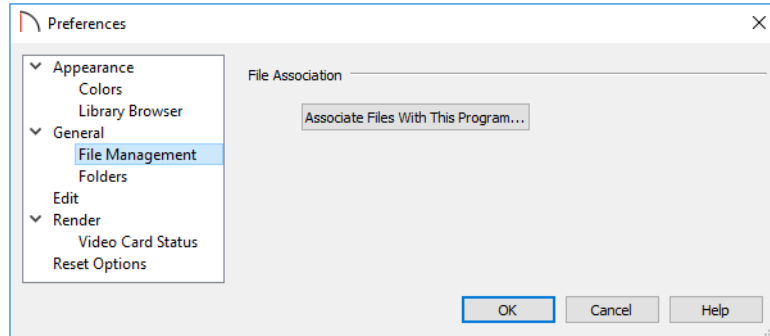

Click the **Associate Files With This Program** button to direct your computer’s operating system to associate all **.plan**, **.calib**, and **.calibz** files with Home Designer Suite 2021. This button will not be

active if plan and library files are already associated with this program and version. See “File Association” on page 31.

Folders Panel

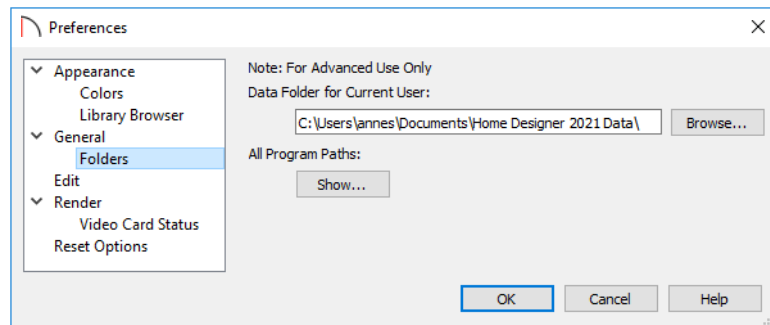

- Important user-specific information is stored in the **Home Designer Suite 2021 Data** folder, which is located in your Documents directory by default. See “Home Designer Suite Data” on page 32. If you specify a new location, any custom toolbars or other settings that you may have will not be copied to the new location: you can do this yourself if you wish.

 Make sure that the location you specify is accessible and has adequate space for the files in this folder. See “Data Folder Name and Location” on page 33.

Folder. This folder is created in the directory intended for shared application data in your operating system (C:\ProgramData in Windows;/Library/Application Support in macOS). If you specify a new location, the program will automatically copy your library content to that location. See “Library Content” on page 276.

 If you choose to use a different folder, you must specify a directory on a hard drive with sufficient space to hold these files.

- **All Program Paths** - Click the **Show** button to open the **Program Paths** dialog, where you can find the location of files that may be needed for troubleshooting purposes. See “Program Paths Dialog” on page 393.

Edit Panel

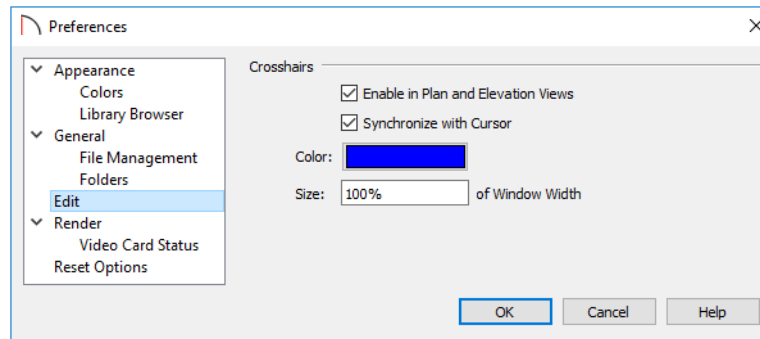

You can use a cursor with **Crosshairs** and control its appearance. See “Crosshairs” on page 21.

- Check **Enable in Plan and Elevation Views** to use a cursor with crosshairs in plan and elevation views. This option is checked by default.
- When **Synchronize with Cursor** is checked, the mouse pointer and crosshairs always move together on screen. If you feel that they do not

keep up with your mouse movements, try unchecking this option.

- Click the **Color** bar to open the **Select Color** dialog and specify the color of the crosshairs.
- **Crosshair Size** is specified as a percentage of the view **Window Width**. Specify the **Size** as 100% to extend the crosshairs across the entire screen.

Render Panel

The settings on the **RENDER** panel control how 3D views are generated and navigated.

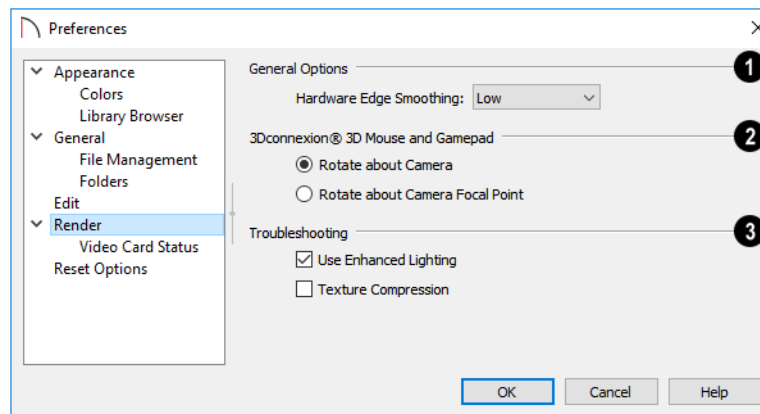

1 **Hardware Edge Smoothing** uses the video card to reduce the jagged appearance of angled surface edges, producing cleaner lines. The higher the smoothing effect, the longer the rendering time. See “Edge Smoothing” on page 320.

2 The **3Dconnexion® 3D Mouse and Gamepad** settings affect how 3D mice and gamepads function in Perspective 3D views. See “3Dconnexion® 3D Mice” on page 308.

- Select **Navigate about Camera** to center mouse movement about the location of the camera.

- Select **Navigate about Camera Focal Point** to center mouse movement about the location of the camera’s focal point. See “To create a camera view” on page 305.

3 The **Troubleshooting** settings can be used to troubleshoot performance in 3D views.

- Uncheck **Use Enhanced Lighting** to disable most lighting effects in Rendering Techniques that support lighting. This box is checked by default and should only be unchecked for troubleshooting purposes. It may become unchecked automatically if the program detects a problem with your

video card. See “OpenGL and Hardware” on page 303.

- When **Texture Compression** is checked, material textures are compressed so that less video mem-

ory is required when a 3D view is generated. Texture Compression takes time, however, so view generation will typically be slower.

Video Card Status Panel

The VIDEO CARD STATUS panel displays information about your video card, including the vendor and whether the minimum required OpenGL version is

supported. See “OpenGL and Hardware” on page 303.

This information may be important if you are having problems generating 3D views.

Reset Options Panel

In order for some of the Reset Options to take effect, you will need to restart Home Designer Suite.

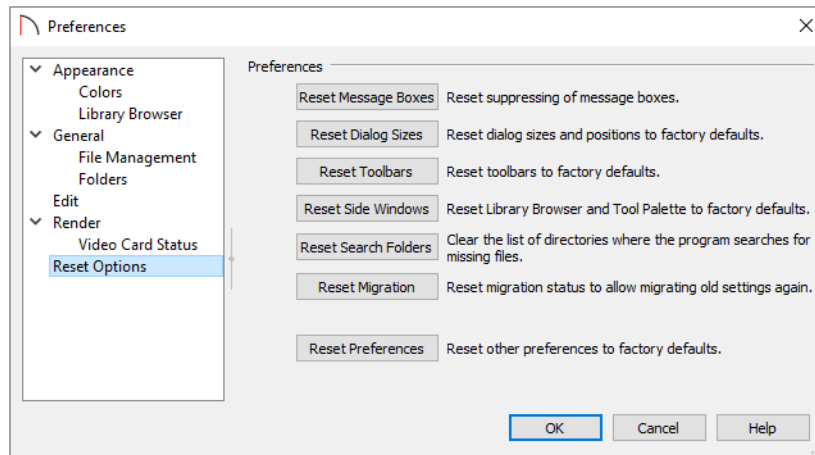

- If message boxes have been suppressed, you can make them display again by clicking **Reset Message Boxes**. See “Message Boxes” on page 26.
- Click the **Reset Dialog Sizes** button to restore all dialog boxes to their original sizes and positions. See “Dialogs” on page 24.
- Click the **Reset Toolbars** button to reset all toolbars to their original states. If you are encountering warning messages regarding toolbars, this option may resolve the issue. See “Toolbars and Hotkeys” on page 57.
- Click the **Reset Side Windows** button to restore all side windows to their original sizes and positions. Tool Palette Settings  are also reset, as are the panes in the Library Browser. See “Side Windows” on page 22.
- Home Designer Suite retains a list of locations where you have located missing files in the past. If you find that the program takes a long time searching before informing you that files are missing, you can click the **Reset Search Folders** button to clear this list. See “Referenced Files” on page 39.
- Click the **Reset Migration** button to be prompted to migrate your content and settings from an older program version the next time you launch the software. See “Migrating Content and Settings” on page 13.
- Click the **Reset Preferences** button to restore all preferences to those originally installed with the program.

Angle Style Dialog

At the bottom of the **Terrain Specification** dialog, you can click the **Angle Style** button to open the

Angle Style dialog. See “Terrain Specification Dialog” on page 357.

The selection in this dialog is global, affecting all plans during the current program session, and controls the format of angles in dialog boxes as well as in the Status Bar. See “The Status Bar” on page 26.

Although this setting controls the format of values used in dialogs, it does not limit how you can enter these values. For example, if you set your Number Style to use Inches, values will display using fractional inches. You can, however, enter values using decimal inches, inches and feet, or even decimal feet. When the dialog you’re typing in updates, the value will be converted to fractional inches.

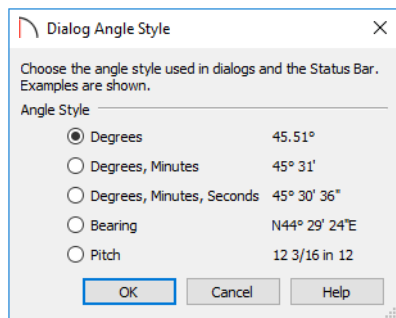

Angles can be displayed using one of five methods:

- **Degrees/Minutes/Seconds** - Measured counter-clockwise from a line drawn horizontally to the right of the angle’s vertex. Useful for most drawing tasks. Select the level of accuracy that you require.
- **Bearings** - Measured from a vertical line representing North/ South, Quadrant Bearings use directional bearings in their measurements. Useful for site drawings.
- **Pitch** - Defined as a ratio of vertical rise to horizontal run. In Imperial units, the run is always 12”; in metric units it is 1000 mm.

Toolbars and Hotkeys

Two of the most efficient ways to access Home Designer Suite's tools and settings are the toolbars and keyboard shortcuts, also referred to as hotkeys.

Toolbar Arrangement

Home Designer Suite's toolbars provide fast access to the program's most commonly used tools and settings, and are organized so that related tools are grouped together and easy to find.



If a tool or setting is active, a small check mark will display at the lower right corner of its button icon.

The toolbars that display in a given view depend on the view type. For example, the toolbars that are available in floor plan and 3D views are not available in Materials Lists.

Some toolbars are available in more than one type of view. If a tool cannot be used in that view, its icon will appear pale grey in color.

Many of Home Designer Suite's tools are organized into families of related tools which can be accessed using either of two styles of toolbar interface: the **Child Tool Palette** or **Drop Down** tools. You can select the interface that you prefer in the **Preferences** dialog. See "Appearance Panel" on page 50.

Drop-Down Tools

Click on the arrow to the right of a button to display a drop-down list of related tools. For example, click

Chapter Contents

- Toolbar Arrangement
- Hotkeys
- Gamepad Settings Dialog

the arrow to the right of the **Window**  button to display a drop-down list of the other Window Tools.

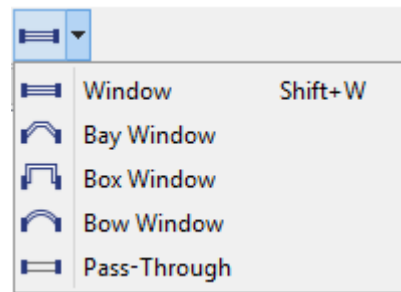

The most recently selected tool displays in the toolbar.

Child Tool Palette

An alternative to Drop-Down toolbars is the Parent button and Child Tool Palette interface. Parent toolbar buttons have a blue triangle in the lower right corner. When you select a Parent button, its Child tools display in the Child Tool Palette. If the Child Tool Palette has been closed, it will open.

By default, the Child Tool Palette is docked on the left side of the program window; but it can be undocked and moved, as well as resized and closed,



just like other side windows. See “Side Windows” on page 22.

As long as it is open, the Child Tool Palette will also display the members of a selected tool’s family when the Drop Down interface is active. If you select a tool that does not belong to a family, the previously selected tool’s family will continue to display in the Tool Palette.

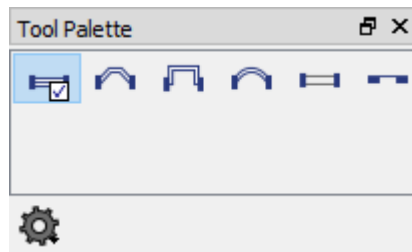
When you click the **Window Tools**  Parent button, for example, its Child buttons display in the Child Tool Palette.



Click the **Settings**  button at the bottom of the palette to select how the tools within it are presented:

- Select **Fit Palette**  to resize the palette so that it is one row wide.
- Select **Grid View**  to display only the button icons of the child tools in a grid that may have multiple rows, depending on the width of the palette side window.
- Select **List View**  to display child tools in a vertical list with each tool’s button icon and name in a row.

You can open the Tool Palette at any time, even when Drop Down tools are enabled, by selecting **View> Tool Palette**. See “View Tools” on page 63.

The Edit Toolbar

When you select an object, its edit toolbar opens. By default, it is located at the bottom of the program window, just above the Status Bar. The buttons on the edit toolbar can be used to edit the selected

object. Which buttons display depends on the type of object selected, the current view, and how you selected the object.

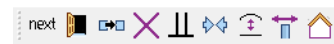

Toolbar Button Size

By default, toolbar buttons are sized at 20 pixels, which works well on most computer monitors running default system settings. If you wish, you can increase or decrease this size in the **Preferences** dialog. See “Appearance Panel” on page 50.

Toggling Toolbars

There are several ways to toggle individual toolbars on or off:

- Right-click in an empty space on any toolbar and mouse over **Toolbars** in the contextual menu. In the submenu, toolbars with a check mark next to their name are on in the current view. Click on a toolbar name to turn it off if it is on, or vice versa.
- If a toolbar is undocked, click the **Close** button at its top right corner.

You can turn off the display of toolbars entirely or turn them on again by selecting **View> Toolbars** .

Moving Toolbars

You can move any toolbar to a different location by clicking and dragging its dotted grab bar. Toolbars can be docked to any side of the program window, or they can be undocked and left floating.

Undocked toolbars can be moved outside of the program window, and they can be closed completely. They can also be reshaped; however, they cannot be resized in such a manner that any buttons become hidden.

The location of moved toolbars is not saved between program sessions. The next time you use Home Designer Suite, the toolbars will be back in their original locations.

Hotkeys

Many Home Designer Suite tools have a keyboard shortcut, or hotkey, associated with them. If such a

hotkey exists, it will display to the right of the tool’s name in the menu.

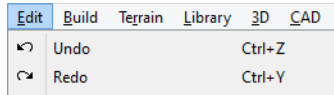

Edit menu items with button icons to the left and hotkeys to the right

To use a hotkey, simply press the appropriate key or combination of keys on your keyboard instead of selecting the menu item or clicking the toolbar button. For example, press the Ctrl and Z keys at the same time to perform an **Undo** .

Note: If a key or key combination is in use as a system hotkey, it cannot be used as a program hotkey.

Create Hotkey List

A list of the hotkeys available to the current program user can be saved in **.html** or **.xhtml** format.

Select **Tools> Create Hotkey List** to open the **Save Hotkey List File** dialog, a standard Save dialog, and create a hotkey list that can then be opened in a web browser window and printed, if you wish.

Gamepad Settings Dialog



The **Gamepad Settings** dialog allows you to specify thumbstick behavior in Home Designer Suite. Select **Tools> Customize Gamepad** to open this dialog.

You can also specify whether navigation is centered about the location of the camera or its focal point in the **Preferences** dialog. See “Render Panel” on page 54.

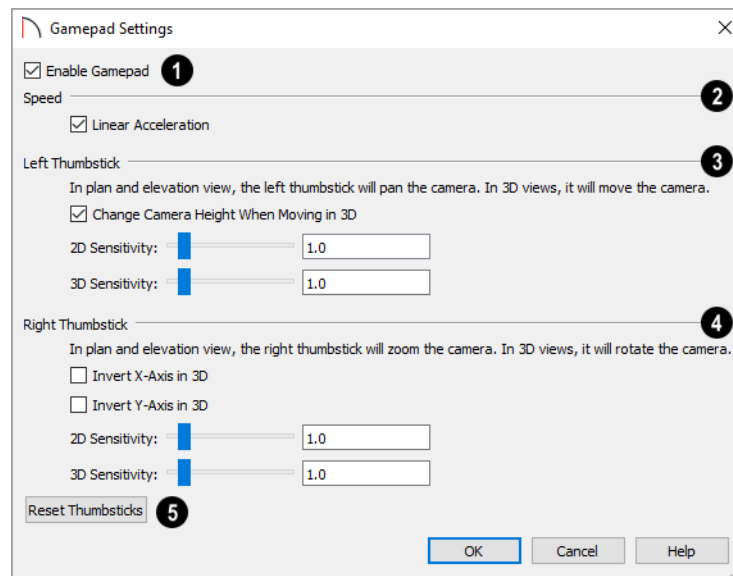

- 1 Check **Enable Gamepad** to allow Home Designer Suite to recognize a gamepad on your system and enable the other settings in this dialog.
- 2 **Speed** - When **Linear Acceleration** is checked, camera acceleration is always directly proportional to the amount the thumbstick is pushed. When unchecked, acceleration is increased on a curve, allowing more precision on the low end, and more speed on the high end.
- 3 Specify the behavior of the **Left Thumbstick** in 2D and 3D views.
 - When **Change Camera Height When Moving in 3D**, the left thumbstick can be used to change

- the camera height in 3D. Uncheck this to maintain a consistent camera height instead.
- Use the slider bar or text field to specify the **2D Sensitivity**, which controls how quickly the view pans in plan and elevation views.
- Use the slider bar or text field to specify the **3D Sensitivity**, which controls how quickly the camera moves in 3D views.
- 4 Specify the behavior of the **Right Thumbstick** in 2D and 3D views.
 - When **Invert X-Axis in 3D** is unchecked, pushing the right thumbstick to the left rotates the camera to the left. When checked, pushing this

thumbstick to the left rotates the camera to the right.

- When **Invert Y-Axis in 3D** is unchecked, pushing the right thumbstick to the up rotates the camera upward. When checked, pushing the thumbstick up rotates the camera downward.
- Use the slider bar or text field to specify the **2D Sensitivity**, which controls how quickly the view zooms in plan and elevation views.
- Use the slider bar or text field to specify the **3D Sensitivity**, which controls how quickly the camera rotates in 3D views.

5 Click the **Reset Thumbsticks** button to restore the default Left and Right Thumbsticks settings on this panel.

Window and View Tools

The View and Window Tools let you control how views of your drawing are shown on screen, as well as toggle useful drawing aides on and off.

By default, Home Designer Suite uses a tabbed document interface. The name of the file and the type of view displays at the top of each view window in its title bar.

View Windows

In Home Designer Suite, there are two different types of views: plan views and 3D views. Each view displays in a view window and can show the model from a different perspective. While multiple views can be open and display on screen, only one view window can be active at any given time. See “3D Views” on page 303 and “Working in Multiple Views” on page 61.

Plan Views

Plan view is where most drawing and editing is done, and when you open a new plan file, a plan view is active. When an existing plan file is opened, the floor

Working in Multiple Views

There is no limit to the number of plan files that can be open, nor is there a limit to the number of view windows that can be open. The name of the file and the type of view is stated at the top of each view window in its title bar as well as in its tab.

Chapter Contents

- View Windows
- Working in Multiple Views
- View Tools
- Zoom Tools
- Undo Zoom
- Fill Window
- Panning the Display
- Closing Views and Files

level, view extents, and Color toggle setting that were in use in the active plan view the last time the plan was saved will all be used.

You can create additional plan views for use during the current program session: select **Tools> New Plan View** . Each plan view that you create can show a different floor and have different view extents and Color setting.

Closing View Windows

There are a number of ways to close view windows. See “Closing Views and Files” on page 65.

By default, Home Designer Suite uses a tabbed document interface, which means that when more than one view window is open in the program window, each open window will have a tab that displays in a row above the currently active view.

- Each tab states the name of the file, the view type, and the view's name.
- Each tab features an icon indicating its type of view.
- Click on a tab to make it the active view.
- If there is not enough room in the program window to display all tabs, left and right arrow buttons allow you to scroll through the tabs.

- Tabs can be reordered by clicking and dragging.

There is no limit to the number of 3D view windows that you can have open at a given time; bear in mind, though, that each window demands use of your computer's resources and that you may see poor performance if too many views are open. See "3D Views" on page 303.

There are several ways to close a view window. See "Closing Views and Files" on page 65.

Tiling Views



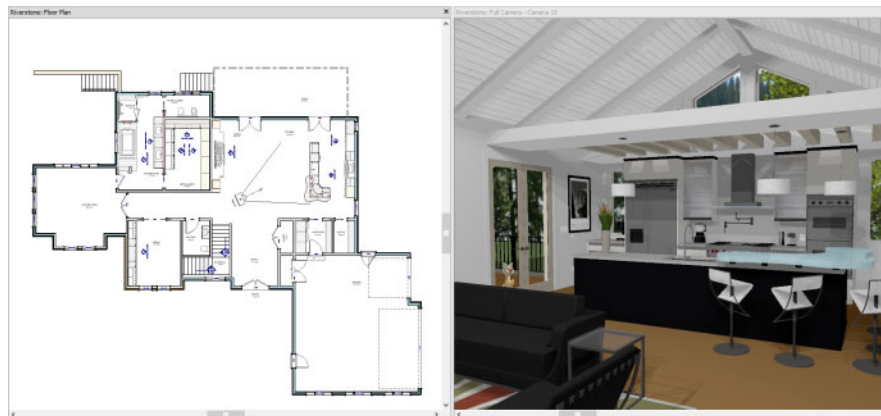

As an alternative to tabbed views, windows can instead be tiled. Tiling allows you to display multiple views in a single Home Designer Suite window so you can see the

results of changes in plan view in 3D or vice versa. It can also be useful for copying objects from one plan to another.



Plan view and a camera view Tiled Vertically

There are several ways to create tiled views:

- Click and drag a view window's title bar or tab into the part of the drawing area that you would like it to be. When a highlighted space is created, release the mouse button.
- Select **Window > Tile Horizontally**  to display views in a horizontal orientation, one above the other.
- Select **Window > Tile Vertically**  or press Shift + F6 on the keyboard to display views in a vertical, side by side, orientation.

Views are tiled left to right or top to bottom in the order in which they were last active: the most recent view is on the left or at the top, while least recent is on the right or on the bottom.

- To activate a view, click on its title bar or anywhere in the view window. Note that any changes

you make in the active window are reflected in other views as well.

- To end window tiling, select **Window > Tab Windows**. You can also end tiling by double-clicking on the title bar of the program window.



Multiple Program Windows

To create a second program window, click and drag the title bar or tab of a view window completely out of the current program window: for example, onto a second monitor. A second Home Designer Suite program window will be created with its own menu and toolbars.

Swapping Views

There are a number of ways to switch between open view windows:

- Click on a view window's tab.

- Select **Window> Select Next Tab**  or **Window> Select Previous Tab**  to cycle through all open views in the order you prefer.
- In Windows, press the Ctrl + Tab (Next Window) or Ctrl + Shift + Tab (Previous Window) keys to cycle through all open views.
- On a Mac, press the Ctrl + } (Next Window) or Ctrl + Shift + { (Previous Window) keys to cycle through all open views.

- A list of all the views currently open is located at the bottom of the Window menu. Each view is identified by its name and what type of view it is. A check mark is beside the view that is currently active. Select one to go directly to that view.

If more than eight view windows are open, **More Windows** will be the last item in the Window menu. Select this option to open the **Select Window** dialog: Select the name of a view in the list and click **OK** to make it the active view.

View Tools

The **View Tools** allow you to open and close the program's side windows, as well as toggle a variety of references and drawing aides. Select the **View** menu to access these tools.



Refresh Display redraws the current window to clean up extra lines, show missing items, and correct random on-screen effects caused by changes to the model. See “Refresh Display” on page 76.



Library Browser opens and closes the Library Browser side window. See “The Library” on page 271.

Tool Palette opens and closes the Tool Palette, which will display related tools. See “Child Tool Palette” on page 57.



Scrollbars displays and suppresses scrollbars on view windows. See “View Windows” on page 22.



Color toggles the display of color in the current view. See “Color On/Off” on page 76.





Reference Grid toggles the display of the Reference Grid in all views in the current plan file. See “Grid Snaps” on page 68.

Zoom Tools



Zoom is used to magnify any given area on the plan or 3D view. Select **Window> Zoom**, then click and drag a marquee around an area on screen. When you release the mouse, the selected area expands to fill the screen.

Note that in 3D views, using **Zoom**  does not reposition the camera. This can lead to inconsistencies between a camera's position and what is actually shown in the view if other methods of zooming are used later. See “Repositioning Cameras” on page 308.

When the zoom is complete, whatever tool was active prior to selecting the **Zoom**  tool automatically becomes active again. If another zoom is needed, click the **Zoom**  tool again.



Zoom In - Click to zoom in towards the screen center by a factor of two.



Zoom Out - Click to zoom out from the screen center by a factor of two.



Undo Zoom - Reverse the last zoom operation.



Fill Window - Fits all visible items on screen.



Fill Window Building Only - Fits all walls and railings on the current floor on screen.

Zooming With the Mouse Wheel



Use the mouse wheel to zoom in and out in all view windows. Scrolling the mouse wheel one click up or down zooms in or out, centering on the location of your pointer and changing the zoom by about 10%.



By default, zooming in 3D views changes the camera's position. See “**Mouse Scroll Wheel and Trackpad**” on page 308.

Note: Depending on the configuration of your mouse, it may be necessary to hold down the Ctrl key while turning the mouse wheel.

Undo Zoom

 Select **Window> Undo Zoom** to reverse the last zoom operation.



Note: Undo and Redo do not affect zoom.

Zoom  and **Undo Zoom**  are also available through the contextual menu. See “Contextual Menus” on page 23.

Fill Window

 In plan view or an Elevation view, select **Window> Fill Window** or press the **F6** key to view nearly everything on screen that is visible, including the Reference Display. CAD Points are the only objects that are not included when Fill Window is used.

If you are zoomed in so that only a portion of the drawing displays on screen, selecting **Fill Window**



 zooms out so that the entire view fits on the screen. If you are zoomed out so that the entire drawing is smaller than the screen, selecting **Fill Window**  zooms in until the drawing fills the screen.

When the drawing sheet is shown, **Fill Window**  zooms to the sheet borders.

Fill Window Building Only

 **Window> Fill Window Building Only** is similar to **Fill Window**, but zooms in or out so that all walls, railings, and roof planes in the view fill the current window. These objects are included in the extents of the view even if their layers are turned off. Other objects are ignored.

In 3D Views

In 3D views, **Fill Window**  and **Fill Window Building Only**  adjust the camera’s Field of View is adjusted so that all surfaces in the 3D view are included.

Panning the Display

There are four ways to pan the display without changing the zoom factor.

Using the Scroll Bars

One method is to use the scroll bars on the right and bottom edges of the window.

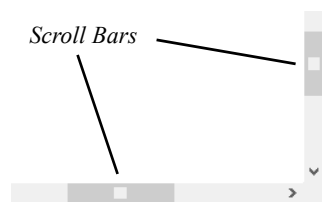

- Drag the square button in the bar itself in order to pan a larger distance.
- Click the end arrow keys on the scroll bars to shift the display in 12" increments.
- The 12" increment is defined in the **Plan Defaults** dialog under **Inches Scrolled by Arrow Key**. See “General Plan Defaults Dialog” on page 49.

Using the Arrow Keys

In plan view, the arrow keys on the keyboard work exactly like clicking the arrow buttons on the scroll bar. They shift the display according to the number of inches defined in the **Plan Defaults** dialog.

Using the Mouse

If you have a wheel mouse, you can pan the display by pressing the middle mouse button, or wheel, and moving the mouse in the direction you would like to pan. When the middle mouse button is held down, the pointer changes to a hand  icon.

In the Mac version of Home Designer Suite, you can pan using the left mouse button and Option key.

Mouse drivers sometimes have other functions assigned to the wheel and buttons. These override the Home Designer Suite setting.



Using a Mac Trackpad

In the Mac version of Home Designer Suite, you can two finger drag to pan the display. See “Trackpads” on page 20.

Using the Pan Window Tool



The **Pan Window** tool works much like the mouse wheel method.

Select **Window > Pan Window** . The pointer changes to a hand  icon. Click and drag to pan the window. The program reverts to the previously active tool when you release the mouse button.

Closing Views and Files

If a view is still needed, you can swap to a different view without closing it. If, however, a view is no longer needed, it can be closed. There are several ways to close a view window:

- Select **File > Close View** to close the active window.
- Press **Ctrl + W** or **Ctrl + F4** on the keyboard to close the active window.
- Click the **Close** button in the active view’s title bar or in any view’s tab.
- A tabbed view can be closed by clicking on its tab using the middle mouse button.
- Select **File > Close All 3D Views**  to close all currently open camera view windows instead of just the active window.
- Select **File > Close All Views** to close all currently open view windows instead of just the active window.

If a plan has only one view window open and you try to close it, the program will prompt you to save before closing if there are any unsaved changes. See “Saving, Exporting, and Backing Up Files” on page 34.



Although the program warns you if you try to exit without saving, you should get in the habit of saving plan files before exiting.

Even if all view windows are closed, the program can still be open. See “Exiting Home Designer Suite” on page 40.

Creating Objects

There are a wide variety of objects in Home Designer Suite that you can use to create 3D models and plan drawings. Although these objects are sometimes very different from one another, the methods used to create them are similar.

Once an object is created, it can be selected and edited to meet the requirements of your project. The editing characteristics common to most objects are described elsewhere. See “Editing Objects” on page

79.

Chapter Contents

- Architectural vs CAD Objects
- Snap Behaviors
- Object Snaps
- Angle Snaps
- Grid Snaps
- Creating Objects

Architectural vs CAD Objects

There are two broad categories of objects in Home Designer Suite: architectural objects and CAD objects.



CAD objects such as lines, arcs, text, and dimensions are 2D objects that can be created and edited in plan view and but do not display in 3D camera views and overviews. See “The CAD Drawing Tools” on page 101.

In contrast, architectural objects such as walls, cabinets, doors, windows, and stairs display in 2D and 3D views.

Some architectural objects, such as terrain features, have some behaviors in common with CAD objects and are referred to as CAD-based.

Snap Behaviors

There are three categories of snap behavior in Home Designer Suite that affect how objects are created and how they can be edited:

- **Object Snaps** , which snap CAD and architectural objects to other objects.
- **Angle Snaps** , which snap objects at specific angles.
- **Grid Snaps** , which snap objects to points on a grid.

You can select **Edit> Snap Settings** to quickly turn Object, Angle and Grid Snaps on or off.

To temporarily disable Snap Behaviors and other move restrictions, press the Ctrl key while dragging an edit handle. See “Moving Objects” on page 92.

Object Snaps



Object Snaps allow you to position objects precisely relative to each other; for example, to position lines so that their endpoints meet.

Object Snaps can be turned on or off by selecting **Edit> Snap Settings> Object Snaps**.

There are many locations on an object that other objects can snap to.

- Object endpoints and corners
- The midpoints of object edges
- Object center points
- Intersection points where an object drawn at an allowed angle meets another object.

Angle Snaps



It is often important that objects be drawn at exact angles. This can be accomplished using **Angle Snaps**. Angle Snaps allow you to draw walls, lines, and other objects at angles in 15° increments. Angle Snaps also affect the way objects rotate, the radius of arcs, and a variety of other operations.

Grid Snaps



Grid Snaps allow you to snap objects to points on an on-screen grid. This grid cannot be seen directly, but as you draw, move or resize an object, you can sometimes see it snapping at regular increments. See “Moving Objects” on page 92 and “Resizing Objects” on page 94.

It is recommended that you draw and position the exterior walls of your plan with **Grid Snaps**  enabled. Once these walls are in place, you may choose to turn Grid Snaps off to finish the rest of the drawing.

Grid Snaps are turned on and off by selecting **Edit> Snap Settings>Grid Snaps**  or in the **Plan Defaults** dialog.

Reference Grid

In addition to the Snap Grid, the **Reference Grid** is provided to give you a visual sense of scale. The Reference Grid is composed of 12” x 12” squares

In addition, **On Object** snapping occurs anywhere on an object’s edges and is most noticeable when Angle and Grid Snaps are turned off.



When multiple objects are selected, the selection set’s only snap point is its midpoint.

Extension Snaps

Extension snaps allow you to snap to a point that is not actually on an object. Instead, these snaps locate points that are either collinear to the end of a wall or orthogonal (at a 90° angle) to it.

Extension snaps function when you are drawing or editing walls and create a “sticky point” where the wall being drawn reaches a point that is either collinear or orthogonal to another wall’s end point. See “Creating Walls” on page 114.

Angle Snaps can be turned on or off by selecting

Edit> Snap Settings> Angle Snaps . When Angle Snaps are disabled, the Angle Snaps  icon will display near the mouse pointer.

and is useful for zooming in and out, or for general layout guidelines, but is not used for snapping.

The Reference Grid can be toggled on and off by selecting **View> Reference Grid** . See “View Tools” on page 63.

The appearance and size of the Snap and Reference Grids can be controlled in the **Plan Defaults** dialogs. See “General Plan Defaults Dialog” on page 49.

Grid Snaps and Angle Snaps

Of the three snap behaviors, Grid Snaps have the lowest priority and are overridden by Angle Snaps and Object Snaps.

When Grid snaps and Angle Snaps are both enabled, objects are drawn and edited using Polar Coordinates. For example, if the grid **Snap Unit** is set to 12" (1 foot), drawing a new wall at an Allowed Angle snaps the wall length to 0", 12", 24", and so on.



To draw a line or wall at an Allowed Angle but with unrestricted length, disable Grid Snaps and leave Angle Snaps on.

Creating Objects

In Home Designer Suite, there are three ways to add new objects to your drawing: by clicking to place an object, by clicking and dragging to draw an object, or by importing custom symbols, pictures or metafiles.

If you create an object using any of these methods and the layer it will go on is turned off, the program will ask you if you want to display the layer. See “Object Creation and Layers” on page 69.

While the size of the drawing area in Home Designer Suite is limited only by the resources on your computer, it is best to begin your drawing near the origin, 0,0,0. The current position of your mouse pointer displays in the Status Bar at the bottom of the program window. See “3D Drafting” on page 19.

Click-to-Create

Many objects, including doors and windows, cabinets, library symbols, text, pictures, and images are created by clicking. Select a library object or one of the drawing tools mentioned above, then click in the drawing area to place the object at that location.

Continue clicking to place the selected object until another tool is selected.

If you click at a location where there is not enough room for the object to be placed, one of two things may happen:

- Some objects, notably cabinets, doors, and windows, will resize smaller to fit into the space.
- Most objects cannot resize in this manner, so the program will present a warning message indicating that there is not sufficient space at the current location.

When most drawing tools are active or library symbols selected for placement, a preview outline follows your mouse pointer, indicating the size and shape of the object to be created. If your pointer is positioned at a location where the object cannot be placed, this preview outline will not display.

As you move the mouse pointer, the center point of the object’s back edge will snap to active snap points when **Grid Snaps**  or **Object Snaps** are enabled. See “Snap Behaviors” on page 67.

Many architectural objects can be created in plan view or any 3D view. In order to place a stand-alone, click-to-create object in 3D, it is necessary to click near a wall or within the Terrain Perimeter as these objects help orient the new object within the 3D space.

Clicking and Dragging

Other objects, including walls and railings, straight stairs, and CAD and CAD-based objects are created by clicking and dragging to define either a path or an enclosed area. Select a tool, then click and drag in the drawing area to draw an object between your start and end points.

Continue drawing the selected object until another tool is selected.

You can temporarily slow the movement of the mouse as you drag by holding down the Shift key on your keyboard.

You can cancel any click-and-drag drawing operation before it is completed by pressing the Esc key on your keyboard, or by pressing any two mouse buttons at the same time.

Importing Objects

Custom symbols, pictures and metafiles can be imported into the program and placed in the drawing area with a click. See “Importing and Exporting” on page 341 and “Pictures, Images, and Walkthroughs” on page 325.

Object Creation and Layers

When it is created, every object is placed on a layer which controls whether and how it displays. See “Layers” on page 74.

If you try to create an object on a layer that is not set to display in the current view, the program will ask if you want to turn that layer on. See “Message Boxes” on page 26.

- Click **Yes** to create the object and turn on its layer in the current view.
- Click **No** to create the object but leave its layer turned off in the current view.

- Click **Cancel** to not create the object and leave the layer turned off.

Copying and Pasting Objects

New objects can also be created by cutting, copying, and pasting existing objects, either individually or in groups. Objects can be copied from one floor to another, one view window to another, and one file to another. Because copying uses your system's clipboard, some objects can be pasted into other applications, as well.

 Objects created in an Imperial plan should not be pasted into a metric file, or vice versa. See "Template Plans" on page 33.

Objects cannot be pasted into any views that they cannot be created in normally. For example, CAD objects cannot be pasted into a 3D camera view or overview.

A few objects, such as Terrain Perimeters and camera symbols, cannot be copied.

Cut



Select **Edit> Cut** or press **Ctrl + X** to remove the selected object(s) from the file and save them in the system clipboard. To paste the selection in Home Designer Suite or another application, select **Edit> Paste** or press **Ctrl + V** while in that application to enable the Paste function.

Copy



Select **Edit> Copy** or press **Ctrl + C** to copy the selected object(s) to the system clipboard. To paste the selection in Home Designer Suite or another application, select **Edit> Paste** or press **Ctrl + V** while in that application to enable the Paste function.

Paste



Select **Edit> Paste** or press **Ctrl + V** to enable Paste mode, then left- or right-click in the current view to paste the selected object(s) previously copied to the system clipboard at that location. If pasting from another application, click in the destination view in Home Designer Suite first to make sure it is active.

Once pasted, these object(s) are selected. Objects pasted in 3D views are selected on their top surfaces.

If the selection being pasted consists of text, it is placed in a Text object.

If the selection being pasted is an image, the **Paste Image** dialog opens.

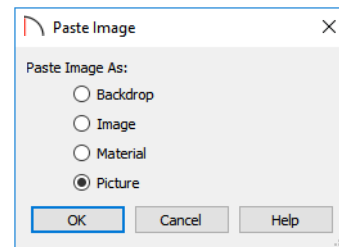



Specify how you would like to paste the selected image:



- Select **Backdrop** to add the image to a new 3D backdrop in the User Catalog in the library, where it will be selected. See "3D Backdrops" on page 333.
- Select **Image** to add the image to an Image object in the User Catalog in the library, where it will be selected. See "Images" on page 326.
- Select **Material** to add the image to a new material in the User Catalog in the library, where it will be selected. See "Creating Materials" on page 299.
- Select **Picture** to display the picture in the current plan view. See "Pictures" on page 329.

Copy/Paste



Click the **Copy/Paste** edit button to copy the selected object(s) to the system clipboard and immediately enable the **Paste**  function in Home Designer Suite.

The **Copy/Paste**  edit button activates Paste mode in which each available edit tool and handle makes a copy in addition to its primary function and two new edit buttons display on the edit toolbar.

- Click the **Sticky Mode**  edit button to remain in the current mode and place multiple copies of the selected object(s).
- Click the **Paste Hold Position**  edit button create a copy of the selection at the same location



as the original. See “Paste Hold Position” on page 71.

- Click the **Main Edit Mode**  edit button or press the Esc key to return to the selected object’s main edit toolbar.



If you paste a selection in a file other than its original source file, when you return to the original, Paste mode is still enabled.

The **Copy/Paste**  edit button can be used with the edit handles in either of two ways: by clicking or by dragging an edit handle.

To Copy/Paste by clicking

1. Select an object or objects to copy.
2. Click the **Copy/Paste**  edit button, select **Edit> Copy**  from the menu or press **Ctrl + C** to copy and then **Ctrl + V** to activate the Paste functionality. The cursor displays the Copy/Paste icon.
3. If you wish to paste the copy in a different view or program window, open that window.
4. If your cursor does not display the Copy/Paste icon, select **Edit> Paste** from the menu or press **Ctrl + V**.
5. Left- or right-click once to paste a copy of the object at that location.

To Copy/Paste by dragging



1. Select an object or objects to copy.
2. Click the **Copy/Paste**  edit button, select **Edit> Copy**  from the menu or press **Ctrl + C**. The cursor displays the Copy/Paste icon.
3. Drag an edit handle:
 - Drag the Move edit handle to position the copy at a new location.
4. You can position the copy accurately with respect to the original by watching the moved distance in the Status Bar at the bottom of the screen.

Sticky Mode

 Normally, after an action is performed using the edit tools or handles while in an edit mode such as Paste mode, you return to the Main Edit Mode. Click the **Sticky Mode** edit button to remain

in Paste mode and continue pasting copies of the selected object(s).

To exit Paste mode and return to the main edit toolbar for the selected object, click the **Main Edit**

Mode  edit button or press the Esc key on your keyboard. If you have not pasted a copy of the selected object and immediately click **Copy/Paste**  after returning to the Main Edit Mode, **Sticky Mode**  is still enabled.



Paste Hold Position

 Click the **Paste Hold Position** edit button to create a copy of the selected object(s) at the same location as the original. The copy remains selected so you can perform additional operations.

Because multiple walls, railing and fencing cannot share the same space, the **Paste Hold Position**  edit button is not available for these objects.

When copying between different floors or view windows, you can paste a copy at the same absolute position as the original selection using the **Paste Hold Position** command.

To use Paste Hold Position

1. Select the object(s) to be copied.
2. Click the **Copy/Paste**  edit button.
3. Switch to the desired floor or plan file and select **Edit> Paste> Paste Hold Position** .
4. A copy is placed at the same X, Y coordinates on the new floor or in the new plan as the original’s position.

Copy and Paste in Place

Select **Edit> Copy and Paste in Place** to create a copy of the selected object(s) at the same location as the original. The copy remains selected so you can perform additional operations.

Because multiple walls, railings, and fencing cannot share the same space, the **Copy and Paste in Place** command is not available for these objects.

Paste Special

 The **Paste Special** tool allows you to choose a representation for the selection to be pasted.

Selections can be pasted as:

- Enhanced Windows Metafiles (EMF). See “Metafiles” on page 330.
- Device Independent Bitmaps (BMP). See “Importing Pictures” on page 330.
- Unformatted non-unicode text (TXT).
- File Name (a path to a file). Depending on the file type, it will be either opened or imported (if supported).
- Unformatted text (HTML). Pastes as text.
- Model Objects - Home Designer Suite format, not compatible with other programs.

To use Paste Special

1. Select an object, image, text or file on your computer and copy it.
2. Switch to the desired Home Designer Suite view window and select **Edit> Paste> Paste Special** .
3. In the **Paste Special** dialog, select the desired representation for the selection and click OK.
4. Click in the drawing area to place the copy at that location.

Displaying Objects

The way that objects display is an important in all stages of the design process. There are two primary ways that the display of objects is controlled: Drawing Groups and Layers.

Displaying Objects

There are two broad categories of objects in Home Designer Suite: architectural objects and CAD objects. See “Architectural vs CAD Objects” on page 67.

CAD objects are two-dimensional and display only in the view in which they were drawn. Architectural objects, on the other hand, are 3D and are represented in 2D and 3D views in different ways

Layer Settings

By default, CAD and CAD-based objects use the color assigned to their layer. They can also be assigned custom line attributes in their specification dialogs. See “Line Style Panel” on page 103.

In plan view, architectural objects are represented much like CAD objects, using the color assigned to their layer.

In addition, layers can be used to turn the display of objects on and off in different views.

Chapter Contents

- Displaying Objects
- Layers
- Layer Attributes
- Display Options Dialog
- Layer Sets
- Drawing Groups
- Display Toggles
- Fill Styles
- Select Color Dialog

Fill Styles

Closed CAD objects can also be assigned a fill style for their interior areas. Fill styles may be a solid color or a pattern, and can be specified as transparent. See “Fill Styles” on page 76.

A few architectural objects such as rooms and stairs can also be assigned a fill style; however, it is only used in plan view. In 3D views, architectural objects are represented using surfaces that have materials assigned to them.

Material Textures

The appearance of architectural objects in 3D views is determined by the materials applied to the objects’ surfaces. See “Materials” on page 293.

In Standard rendered views, you can turn on or off the display of textures by selecting **3D> Camera**

View Options> Toggle Textures .

Layers

Layers are used to organize and manage the display of all objects in all views. A layer can be thought of as a transparency sheet with objects placed on it for viewing. Nearly all views use multiple layers, like a stack of transparencies put together to show different types of objects.

You can find out which layer an object is on by selecting the object and looking at the Status Bar. And, you can customize how each layer displays in a particular view in the **Display Options** dialog.

Multiple layers are organized into Layer Sets, which allow you to control which objects display in different views.

Layer Attributes

The display of objects in different views is controlled by layer sets and layers in the **Display Options** dialog. See “Display Options Dialog” on page 74.

Primary and Secondary Layers

Every object is placed on a layer which controls whether it displays in a given view. This layer is referred to as the object’s primary layer, and you can see its name in the Status Bar when the object is selected. See “The Status Bar” on page 26.

In addition, some objects have secondary layers which may alter the appearance of objects on the primary layer, but do not control whether the objects display or not.

For example, the primary layer for base cabinets is “Cabinets, Base”. In addition, base cabinets have a number of secondary layers that control the display of the countertop, face indicators, door opening indicators, module lines and labels.

Note: If an object’s primary layer is turned off, information on its secondary layers will not display - even if those layers are turned on.

All layers with a check in the “Disp.” column display when the current layer set is active. Objects that are not displayed cannot be seen or selected. If you try to

place or draw an object on a layer that is hidden, the program asks if you want to turn the layer on.

Name	Disp
Architectural Blocks	✓
Architectural Blocks, Labels	
Audio/Video	✓
Auto Dormers	✓
Cabinets, Base	✓

Some objects are designed to be inserted into another object rather than standing alone. If the display of an object that contains an inserted object is turned off, the inserted object’s display will be turned off, as well. For example, if the display of a wall is turned off, any doors and windows in that wall will not display either. See “Inserted Objects” on page 282.

Only displayed objects are included when DXF/DWG and EMF files are exported, and only displayed objects print.

The **Color** attribute assigned to a layer determines how the lines representing objects on that layer appear in floor plan views.

Some objects, notably CAD and text, allow you to override their line color without changing the layer’s color attribute. A custom line style can also be assigned to these objects. See “Line Style Panel” on page 103.

Display Options Dialog



The display of objects in all views is controlled in the **Display Options** dialog. To make changes to the display settings for a particular type of view, open a view of that type and select **Tools> Display Options**.

If the display of a particular layer is turned off and an object assigned to that layer is placed in the plan, the program will automatically ask you if the layer should be turned on so that the new object will be visible. After you make your choice, the object will be created - even if you select “No.”

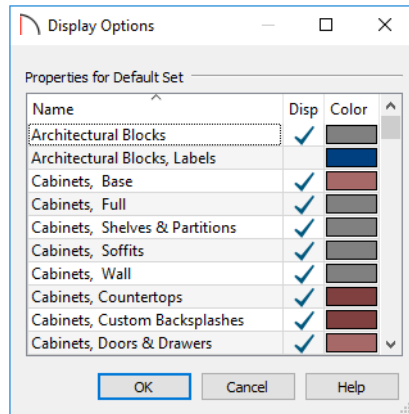

The **Properties** for the layer set that is active in the current view are presented in a table of layers and their attributes. See “Layer Sets” on page 75.

Layer Sets

Layer Sets are used to control the layer settings for different views in a plan file.

A layer set consists of a complete list of the layers in the current plan along with the display settings for each layer as set for a particular type of view. These display settings can be modified, and can be different for each type of view. See “Display Options Dialog” on page 74.

Layer sets are file specific, which means that changes made in one plan file have no effect on the settings in other files.

Home Designer Suite uses a different layer set for each type of view of your plan:

- Plan views. See “Plan Views” on page 61.
- Camera views and Overviews. See “3D View Tools” on page 304.

Drawing Groups

Each object in a plan file belongs to a Drawing Group, which influences whether it displays in front of or behind other objects. Drawing Groups control the display of objects in plan view but in camera views and overviews.

Most categories of objects have their own Drawing Group; however, a few objects are instead placed in the Front or Back Group. Imported pictures, which are placed in the Back Group, are a notable example.

- Click on a column header to sort all layers by that column. Click again to sort in reverse order.
- Remove the check from the “Disp.” column to turn off the display of a category of objects.
- Click a color bar to open the **Select Color** dialog and set the display color for objects on that layer in floor plan and Elevation views. See “Select Color Dialog” on page 77.
- Click the size grip at the lower right corner and drag to resize the dialog box.

Note: Not all objects display in all views. For instance, invisible walls do not appear in camera views or materials lists.

- Elevation views. See “Elevation Views” on page 306.
- Framing Overviews. See “Framing Overview” on page 306.
- Reference Floor. See “The Reference Floor” on page 231.

While any view is active, select **Tools > Display**

Options to make changes to the layer set used for that view type.

Any changes made to settings in the **Display Options** dialog for one particular view will affect all views using that same layer set. For example, if you make changes for a camera view, all camera views and overviews in the current plan will be affected. See “Display Options Dialog” on page 74.

A selected object’s Drawing Group is reported in the Status Bar. See “The Status Bar” on page 26.

Within a given Drawing Group, drawing order is determined by the order in which objects are placed. By default, an object will display in front of any objects that were created before it was. For example, if you place a chair and then a table, the table will display in front of the chair; if you instead place a table and then the chair, the chair will display in front.

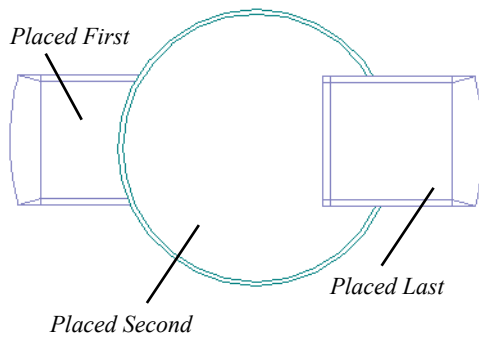

Drawing order also affects how objects are selected. If two objects are positioned so that they overlap one another, and you click at a point that they both share, the frontmost object will become selected first. See “Select Next Object” on page 80.

Display Toggles

There are a number of toggles and tools that can be used to affect the appearance of the on-screen display.

Print Preview



Print Preview and its related display toggles allow you to get a sense of what the current view will look like when it is printed. See “Print Preview” on page 385.

Refresh Display

Refresh Display redraws the current window to clean up extra lines, show missing items, and correct random on-screen effects caused by changes to a model. Select **View > Refresh Display** or press the F5 key to refresh the on-screen display.

Drawing Group Edit Tools



Once an object has been placed, its position in the drawing order can be modified. To do this, select one or more objects and click the **View Drawing Group Edit Tools** edit button.



Click the **Send Backward** edit button to move the selected object(s) to the back of its current Drawing Group. If it is already at the back of its current group, it will be moved to the next group down in the drawing order.



Click the **Bring Forward** edit button to move the selected object(s) to the front of its current Drawing Group. If it is already at the front of its current group, it will be moved to the next group up in the drawing order.

Color On/Off



The display of color on-screen can be toggled on and off in any view by selecting **View > Color**.

- If **Color** is toggled off in any 3D view, the view will be displayed in grayscale.
- If **Color** is toggled off in floor plan view, the view will be displayed in black and white.

You can also print in color or gray scale. See “Print View Dialog” on page 387.

Delete Surface



In any 3D view, select **3D > Delete Surface**, then click a surface in the view to temporarily remove the surface from the current view. See “Delete 3D Surface” on page 307.

Fill Styles

Fill styles are CAD-based patterns that can be used to fill the interiors of closed CAD shapes. In plan view,

fill styles can also be applied to a variety of architectural objects.

Fill Style Panel

The **FILL STYLE** panel is found in the specification dialogs for a variety of objects in the program. This

panel is not available for Electrical Connections as this tool cannot be used to form closed shapes.

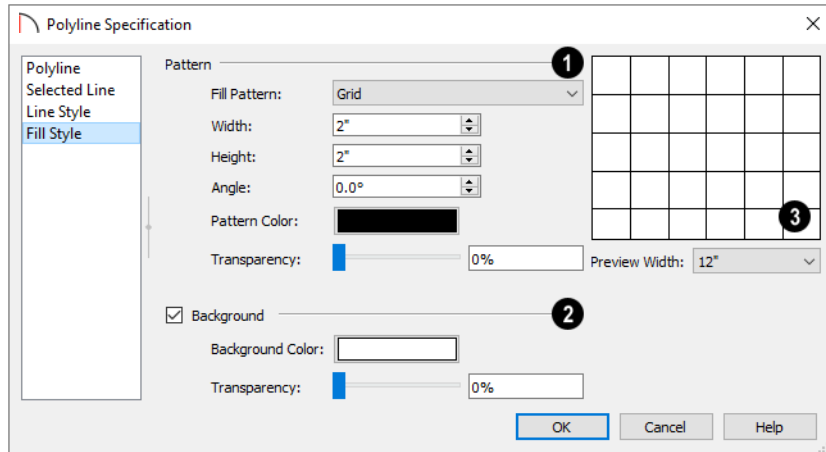

- 1 Specify the style, size, and other attributes of the Pattern
 - Select a **Fill Pattern** from the drop-down list and specify its characteristics.
 - When “No Pattern” is selected as the Type, the settings that follow are disabled.
 - Specify the **Width** of the selected fill pattern. Not available for Solid fill.
 - Specify the **Height** of the selected fill pattern.
 - Specify the **Angle** of the selected fill pattern. Not available for Solid fill.
 - Specify a custom **Color** for the lines that make up the fill pattern or Solid fill by clicking the color bar. The color assigned to the selected object’s layer is used by default.
 - Use the **Transparency** slider bar or text field to control how transparent the fill pattern lines are. This setting also affects the transparency of Solid fill colors.
- 2 Check **Background** to add a solid background color to the fill pattern and enable the settings below. When unchecked, the fill pattern has a transparent background. Not available when “Solid” is the selected Pattern Type.
 - Specify a custom background **Color** by clicking the color bar. The Background Color set in the **Preferences** dialog is used by default. See “Colors Panel” on page 51.
 - Use the **Transparency** slider bar or text field to control how transparent the background color is.
- 3 A preview of the selected pattern displays to the right. As changes are made to the settings on this panel, the preview will update.
 - Choose a **Preview Width** from the drop-down list. This value controls how large an area the preview represents. The selected value indicates the horizontal width of the preview pane in actual plan inches (mm).

Select Color Dialog

The **Select Color** dialog can be opened by clicking on the Color bar that can be found in many dialogs throughout the Windows version of the program.

 Mouse over a Color bar to display a tool tip reporting the selected color’s RGB values.

In the Mac version, the standard **Colors** dialog, or Color Picker, is used instead.

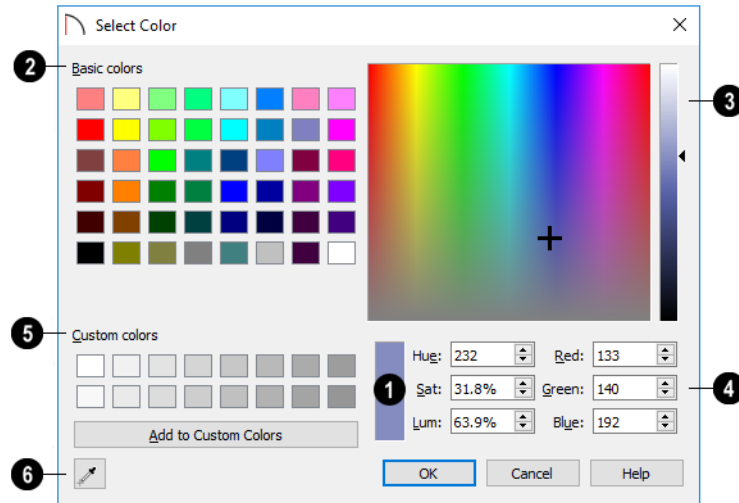

- 1 The currently selected color displays in the rectangle at the lower center of the dialog. There are a number of ways to select a color in this dialog:
- 2 Click in any one of the **Basic colors** boxes to select it.
- 3 Click anywhere in the color spectrum area to select a color.
 - The location of the selected color is identified by crosshairs.
 - Click anywhere in the vertical bar or drag the arrow to adjust the selected color's Luminosity and RGB values.
- 4 Define the color by specifying its **Hue**, **Saturation**, and **Luminosity** (HSL) or its **Red**, **Green**, and **Blue** (RGB) values.

- 5 Click in one of the **Custom colors** boxes to either select it or to specify it as the box for a new custom color to be defined.
 - Click the **Add to Custom Colors** button to add the selected color to the Custom Colors group.
- 6 Click the **Color Chooser Eyedropper**, then click anywhere on your monitor to select the color displaying at that location.

 You can select a color from any program window. Before opening the Color Chooser dialog, make sure the desired color can be seen on screen.

Click OK to apply the currently selected color to the object's line or fill style, or to the material's pattern color.

Editing Objects

Just as the methods used to create different objects in Home Designer Suite are similar, the options for moving, rotating, resizing, and otherwise editing them are also alike.

Edit handles allow objects to be resized, relocated, or rotated using the mouse. Edit toolbar buttons and the contextual menus access edit tools relevant to the selected object(s). Most objects have a specification dialog that allows you to edit it in ways that are specific to that type of object.

The editing characteristics common to most objects are described in this chapter. Unique, object-specific editing behaviors and the specification dialogs are covered in their respective chapters.

Chapter Contents

- Selecting Objects
- Selecting Multiple Objects
- Editing Line-Based Objects
- Editing Arc-Based Objects
- Editing Open Polyline-Based Objects
- Editing Closed Polyline-Based Objects
- Editing Box-Based Objects
- Editing Spline-Based Objects
- Editing Circles, Ovals and Ellipses
- Moving Objects
- Aligning Objects
- Resizing Objects
- Reshaping Objects
- Rotating Objects
- Eyedropper and Painter Tools
- Object Eyedropper
- Deleting Objects
- Delete Objects Dialog
- Undo and Redo

Selecting Objects

“Select” refers to selecting an object for editing. An object must be selected before it can be edited.

In order for an object to be selected, it must be visible in the current view. See “Layers” on page 74.

When an object is selected, it displays edit handles and a grey selection fill color. In 3D views, a selected object will also display lines representing the selected edge or surface. The size of the edit handles does not change as you zoom in or out. To prevent them from stacking on one another, some edit

handles may not display as you zoom away from the selected object.

When an object is selected, its edit toolbar also displays, typically on the upper left side of the Home Designer Suite program window. See “The Edit Toolbar” on page 23.

Information about the selected object or objects may also display in the Status Bar. See “The Status Bar” on page 26.

A selected object remains selected until another object is selected, a different tool is activated, the Esc

key on the keyboard is pressed, or any two mouse buttons are pressed at the same time.

Select Objects

 Any object created using Home Designer Suite can be selected using the **Select Objects** tool. Select **Edit> Select Objects**, click the toolbar button or press the **Space** bar on your keyboard to activate this tool, then click on an object to select it.

You can also select objects or open context sensitive menus using the right mouse button when any tool is active.

Selecting Similar Objects

If a tool other than **Select Objects**  is active, you can only select objects of that type using the left mouse button. For example, if the **Straight Exterior**

Wall  tool is active, you can only select walls using the left mouse button.

This can be useful for selecting an object when many objects of a different type occupy the same space in plan view.

Objects can be selected using the right mouse button, regardless of which tool is active.

Right-Clicking

Regardless of which tool is active, you can select an eligible object by right-clicking on it once. When you right-click to select an object a contextual menu also appears, displaying the object's edit tools. See "Contextual Menus" on page 23.

If a drawing tool is active and you right-click to select an object, you can unselect it by left-clicking in an empty space in the drawing area. Although a drawing tool is active, it is not used. If you then left-click a second time, the active tool will be used.

Selecting Multiple Objects

Multiple objects can be selected and edited in groups. The options available for editing them will vary depending on the type or types of objects selected.

Selected Edge

When you click on a polyline- or box-based object, the edge that you click nearest becomes the selected edge and displays an edit handle larger and of a different color than those on other edges. The handle on this edge may also display at the point where you clicked to select it. You can specify the **Selected Edge Handle Fill** color in the **Preferences** dialog. See "Colors Panel" on page 51.

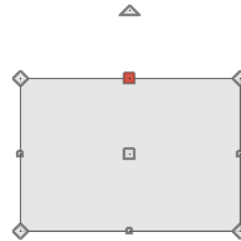

This edge can be edited on the **SELECTED LINE** or **SELECTED ARC** panel of the object's specification dialog. See "Moving Objects Using Dimensions" on page 154, "Line Panel" on page 103 and "Arc Panel" on page 104.

Selected Side

Most architectural objects can be selected in 3D views. When selected, the outline of their bounding box displays, and edit handles are located on the side where you clicked to select the object. The edit handles can be used to move, resize, or rotate the object in different directions, depending on which side is selected.

Select Next Object

 If there is more than one object in a particular space, it may be difficult to select the desired object. When a nearby object is selected, click the **Select Next Object** edit button or press the **Tab** key until the desired object becomes selected. This function cannot be applied to groups of selected objects.

Marquee Select

Groups of objects can be selected by holding down either the **Shift** or **Ctrl** key when the **Select Objects**  tool is active and then dragging a marquee around the objects to be selected. An object does not need to be completely enclosed by the marquee to be

selected: it will be selected if the marquee includes only a small portion of it.

When using the marquee-select method, both CAD and architectural objects included in the marquee are selected. To remove an object from the selection set, hold down the Ctrl key and click on it.

If an object is selected and a selection marquee is drawn around it using the Ctrl key, that object becomes deselected. If the Shift key is used instead, the original object remains selected and the other objects are added to the selection set.

The Shift key can be used to marquee-select objects of a similar type when the drawing tool used to create those objects is active.

To marquee-select objects by type



1. Select a drawing tool used to create the type of object you wish to select: for example, the **Hinged Door**  tool.
2. Hold down the Shift key, then click and drag a rectangular selection marquee in the drawing area.
3. When you release the mouse button, objects of the selected drawing tool's type - here, door objects - located in the marquee will be selected.



 To make marquee selection easier, you can turn off the display of objects you do not want to include in your selection set. See "Layers" on page 74.

Marquee Select Similar

 The **Marquee Select Similar** edit tool lets you group-select objects in the current plan view that are similar to the selected object(s).

To use Marquee Select Similar

1. In plan view, select one or more objects, then click the **Marquee Select Similar**  edit button.
2. The **Restrictive Selection**  toggle controls whether objects are selected by similar type(s) only, or if additional attributes are taken into account.
 - **Restrictive Selection**  is disabled by default, so objects of the same type will be selected.

- Click the **Restrictive Selection**  edit button to toggle it on and select only objects with additional attributes like materials in common.
3. Click and drag a rectangular selection marquee in the drawing area to select similar objects within its area.
 4. Alternatively, click the **Select All Similar**  edit button to select all similar objects in the current view.

Shift and Ctrl Select

You can select a group of objects by adding them to the selection set one by one. Select an object, hold down either the Shift or Ctrl key, and click additional objects to select them.

More than one type of object can be selected using this method, but the ability to edit the group-selected items is limited to attributes that all selected objects have in common.

To remove an object from a selection set, click on it once more with the Ctrl key pressed.

The Shift and Ctrl keys can be used to select multiple items in a variety of contexts, such as: the Library and Project Browsers, lists in dialog boxes, and files to be imported. They can also be used to marquee-select objects in plan view. See Marquee Select, above.

Edit Area

 The **Edit Area** tool allows you to quickly define an area of your plan and select the objects in that area. Once selected, they can then be repositioned, rotated, or deleted. Select **Edit > Edit Area**, then click and drag a rectangular marquee around the area that you would like to move.

Unlike other selection methods, the **Edit Area** tool cuts walls, railings and fencing where the selection marquee intersects them, allowing you to edit only the selected portion of these objects.

Some objects, such as cabinets, are included in the selection only if more than half of the object is contained within the marquee.

Editing Line-Based Objects

Objects are considered line-based when they can be edited similar to CAD lines using their edit handles.

CAD lines, straight walls and railings, straight stairs, and straight roads are examples of line-based objects.

Most line-based objects can be connected to other like objects to form polylines or polyline-based objects. See “Editing Open Polyline-Based Objects” on page 85 and “Editing Closed Polyline-Based Objects” on page 87.

Some objects, notably walls, have line-based editing behavior only when selected on certain surfaces. See “Editing Walls” on page 119.

Wall openings such as doors and windows have line-based editing behavior in plan view only but cannot be rotated, reversed or converted to an arc. See “Editing Doors” on page 172 and “Editing Windows” on page 187.

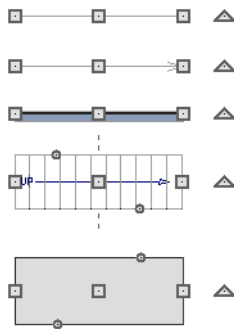

Other objects, such as stairs and roads, have additional edit handles that allow you to concentrically adjust the object’s width.

Using the Edit Handles

When selected, a typical line-based object displays four edit handles: a Move handle, two Extend/Change Angle handles, and a Rotate handle.

Any action performed using the edit handles can be cancelled by pressing the Esc key or any two mouse buttons at the same time.

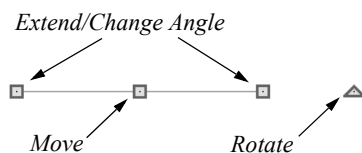

Move

- Movement may be limited or stopped by other objects or Snap Behaviors. Move restrictions can be overridden by holding down the Ctrl key while dragging. See “Unrestricted Movement” on page 93.

Rotate

- The **Rotate** handle is used to rotate the object about its center. See “Rotating Objects” on page 96.

Extend/Change Angle

- Drag a square end handle parallel to the selected line to change its length.
- Drag a square end handle at an angle to the selected line to change its angle. When **Angle**

Snaps  are on, the line snaps to Allowed Angles. See “Angle Snaps” on page 68.

Adjust Width

Some line-based objects, such as stairs and roads, have additional handles that allow the width of the object to be adjusted.

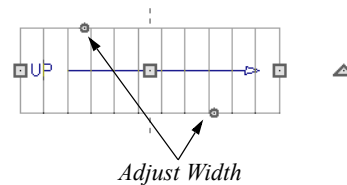

- Click and drag a small, round **Expand** handle to increase or decrease the object’s width. By default, objects are resized in 1" increments. This Snap Unit is defined in the **Plan Defaults** dialog. See “General Plan Defaults Dialog” on page 49.

Using Dimensions



Dimensions can be used to position line-based objects relative to other objects. See “Moving Objects Using Dimensions” on page 154.

Dimensions cannot, however, be used to adjust the length of line-based objects, or the width of line-based objects such as stairs.

Using the Specification Dialog











Line-based objects can be edited using their specification dialogs. See “Line Specification Dialog” on page 102.

Using the Edit Toolbar

A selected line-based object can be edited in a variety of ways using the buttons on the edit toolbar.

The following toolbar buttons may display on the edit toolbar for a selected line-based object:

- Click the **Select Next Object**  edit button to select nearby objects instead of the selected object. See “Selecting Objects” on page 79.
- Click the **Open Object**  edit button to open the specification dialog for the selected object. See “Specification Dialogs” on page 25.
- Click the **Copy/Paste**  edit button to copy the selected object(s) to the system clipboard so they can be pasted elsewhere. See “Copying and Pasting Objects” on page 70.
- Click the **Delete**  edit button to delete the selected object(s). See “Deleting Objects” on page 98.

- Click the **Center Object**  edit button to center an object along a wall within a room or relative to a cabinet fixture. See “Using Center Object” on page 94.
- Click the **View Drawing Group Edit Tools**  edit button to modify the selected object’s place in the drawing order. See “Drawing Group Edit Tools” on page 76.
- Click the **Break**  edit button to add a new corner or pivot point to the selected object. See “Break” on page 95.
- Click the **Complete Break**  edit button to break the selected object into two separate objects. See “Break” on page 95.
- Click the **Change Line/Arc**  edit button to change a line-based object to an arc, or vice versa. See “Change Line/Arc” on page 96.

Editing Arc-Based Objects

Objects are considered arc-based when they can be edited similar to CAD arcs using their edit handles.

CAD arcs, curved walls and railings, curved stairs, and curved roads are examples of arc-based objects.

Most arc-based objects can be connected to other like objects to form polylines or polyline-based objects. See “Editing Open Polyline-Based Objects” on page 85 and “Editing Closed Polyline-Based Objects” on page 87.

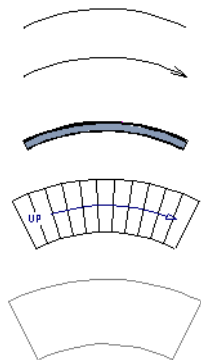

Some objects, notably curved walls, have arc-based editing behavior only when selected on certain surfaces. See “Editing Walls” on page 119.

Other objects, such as curved stairs and roads, have additional edit handles that allow you to concentrically adjust the object’s width.

Using the Edit Handles

When selected, a typical arc-based object displays seven edit handles.

Any action performed using the edit handles can be cancelled by pressing the Esc key or any two mouse buttons at the same time.

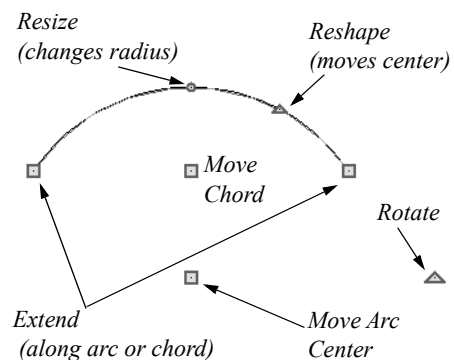

Move

- Two Move edit handles allow the arc to be relocated without changing its shape. One is located

at the center of the chord and the other, at the arc center.

- Movement may be limited or stopped by other objects or Snap Behaviors. Move restrictions can be overridden by holding down the Ctrl key while dragging. See “Unrestricted Movement” on page 93.

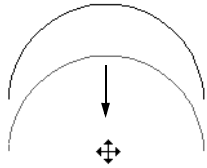

Move edit handle

Rotate

- The **Rotate** handle is used to rotate the arc about its center. See “Rotating Objects” on page 96.

Extend

- The end edit handles expand or contract the arc when moved along the arc radius or chord.
- If you follow the path of the arc, the end edit handles allow you to adjust the arc length.
- The angle formed by the center point of the arc and its two endpoints is referred to as the Included Angle. If **Angle Snaps**  are on, the Included Angle of the arc can be rotated at Allowed Angles. See “Angle Snaps” on page 68.

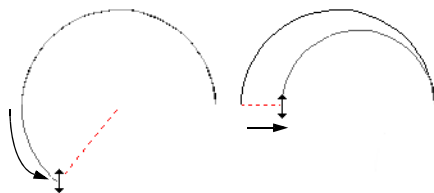

Extend edit handles

Resize

- Drag the small, round **Resize** edit handle to change the radius and included angle of the arc while maintaining its center.

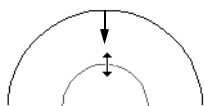

Resize edit handle

Reshape

- Drag the small triangular **Reshape** handle to change the length and location of the center without moving the endpoints.

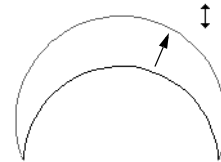

Reshape edit handle

Adjust Width

Some arc-based objects, such as stairs, have additional handles that allow the width of the object to be adjusted.

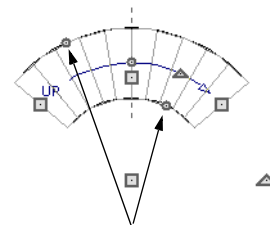

Adjust Width

- Click and drag a small, round edit handle to increase or decrease the object’s width. By default, objects are resized according to the Snap Unit defined in the **Plan Defaults** dialog. See “General Plan Defaults Dialog” on page 49.

Using Dimensions

 Dimensions can be used to position arc-based objects. Dimension lines typically locate tangent extension lines and any extension lines that may be parallel to those lines rather than the arc itself. See “Moving Objects Using Dimensions” on page 154.





Using the Specification Dialog

 Arc-based objects can be edited using their specification dialogs. See “Arc Specification Dialog” on page 104.





Using the Edit Toolbar

A selected arc-based object can be edited in a variety of ways using the buttons on the edit toolbar.

The following toolbar buttons may display on the edit toolbar for a selected arc-based object:

- Click the **Select Next Object**  edit button to select nearby objects instead of the selected object. See “Selecting Objects” on page 79.
- Click the **Open Object**  edit button to open the specification dialog for the selected object. See “Specification Dialogs” on page 25.
- Click the **Copy/Paste**  edit button to copy the selected object(s) to the system clipboard so they can be pasted elsewhere. See “Copying and Pasting Objects” on page 70.
- Click the **Delete**  edit button to delete the selected object(s). See “Deleting Objects” on page 98.
- Click the **Center Object**  edit button to center an object along a wall within a room or relative to

a cabinet fixture. See “Using Center Object” on page 94.

- Click the **View Drawing Group Edit Tools**  edit button to modify the selected object’s place in the drawing order. See “Drawing Group Edit Tools” on page 76.
- Click the **Break**  edit button to add a new corner or pivot point to the selected object. See “Break” on page 95.
- Click the **Complete Break**  edit button to break the selected object into two separate objects. See “Break” on page 95.
- Click the **Change Line/Arc**  edit button to change an arc-based object to a line, or vice versa. See “Change Line/Arc” on page 96.

Editing Open Polyline-Based Objects

Open polyline-based objects are composed of individual line- and arc-based objects that are connected at their end points but do not form an enclosed area. See “Polylines” on page 105.

Objects are considered open polyline-based when they can be edited similar to open CAD polylines using their edit handles.

Open CAD polylines, connected walls, stairs, and connected roads are examples of open polyline-based objects.

For information about editing closed polyline-based objects, see “Editing Closed Polyline-Based Objects” on page 87.

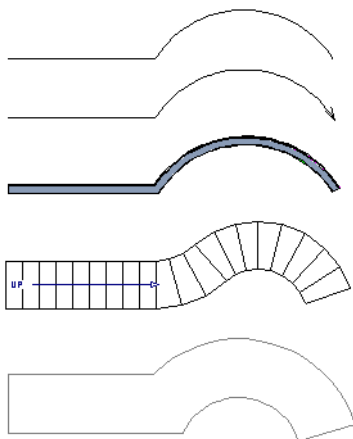

Other objects, such as connected stair and road segments, have additional edit handles that allow you

to concentrically adjust the width of all segments of the object.

Using the Edit Handles

A polyline can be composed of many segments. See “Polylines” on page 105.

When selected, an open polyline-based object displays a Move handle, a Rotate handle, a Reshape handle at the intersection of each segment, and an Extend handle at each end.

Each straight, line-based segment also has a Move edit handle along its length.

Each curved, arc-based segment has its own Move handle at the center of its chord, a Resize handle and, if it has an unlocked center, a Reshape handle. See “Editing Arc-Based Objects” on page 83.

When a polyline is selected, the edge that you click nearest is called the selected edge, and certain operations affect only this edge. The Move handle of the selected edge is larger than that of other edges. It displays along the length of a line segment, or at the center of the chord on an arc segment. See “Selected Edge” on page 80.

Any action performed using the edit handles can be cancelled by pressing the Esc key or any two mouse buttons at the same time.

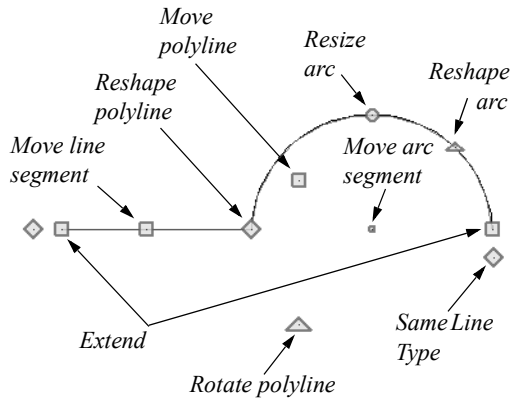

Move

- Click and drag the Move handle to move the object.
- Movement may be limited or stopped by other objects or Snap Behaviors. Move restrictions can be overridden by holding down the Ctrl key while dragging. See “Unrestricted Movement” on page 93.

Rotate

- The **Rotate** handle is used to rotate the object about its center. Its position varies depending on which edge is currently selected. See “Rotating Objects” on page 96.

Extend

- Click and drag an Extend handle to lengthen or shorten the unconnected end of the selected line or arc segment, or to change the radius of the selected arc. See “Editing Arc-Based Objects” on page 83.

Reshape

- Click and drag a Reshape edit handle to change the angle and/or length of the segments on either side of it, or the size of the object.

Move Line Segment

- The **Move Line Segment** edit handle is found on straight segments of open polylines and moves the straight section perpendicular to itself. Adjacent segments may extend or contract in their original directions to maintain their connections.

Move Arc

- Click and drag the Move Arc edit handle to change the radius and/or chord length or position. Adjacent segments may extend, contract, or change angle to maintain their connections.

Resize Arc

- Click and drag the Resize Arc edit handle to change the radius, chord length and chord position of the arc segment. Adjacent segments may extend, contract, or change angle to maintain their connections.

Reshape Arc

- Click and drag the Reshape Arc edit handle to change the radius of the arc without moving its end points.

Adjust Width

Some open polyline-based objects, such as stairs and roads, have additional handles that allow the width of the object to be adjusted.

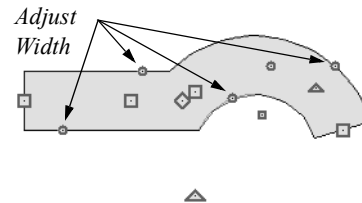

- Click and drag a small, round edit handle to increase or decrease the object’s width. By default, objects are resized in 1" increments. This Snap Unit is defined in the **Plan Defaults** dialog. See “General Plan Defaults Dialog” on page 49.

Using Dimensions

 Dimensions can be used to move or reshape polyline-based objects. See “Moving Objects Using Dimensions” on page 154.

Using the Specification Dialog





 Open polyline-based objects can be edited using their specification dialogs. See “Polyline Specification Dialog” on page 106.

Using the Edit Toolbar





A selected open polyline-based object can be edited in a variety of ways using the buttons on the edit toolbar.

The following toolbar buttons may display on the edit toolbar for a selected open polyline-based object:

- Click the **Select Next Object**  edit button to select nearby objects instead of the selected object. See “Selecting Objects” on page 79.

- Click the **Open Object**  edit button to open the specification dialog for the selected object. See “Specification Dialogs” on page 25.
- Click the **Copy/Paste**  edit button to copy the selected object(s) to the system clipboard so they can be pasted elsewhere. See “Copying and Pasting Objects” on page 70.
- Click the **Delete**  edit button to delete the selected object(s). See “Deleting Objects” on page 98.
- Click the **Center Object**  edit button to center an object along a wall within a room or relative to a cabinet fixture. See “Using Center Object” on page 94.
- Click the **View Drawing Group Edit Tools**  edit button to modify the selected object’s place

in the drawing order. See “Drawing Group Edit Tools” on page 76.

- Click the **Break**  edit button to add a new corner or pivot point to the selected object. See “Break” on page 95.
- Click the **Complete Break**  edit button to break the selected object into two separate objects. See “Break” on page 95.
- Click the **Change Line/Arc**  edit button to change a line-based polyline edge to an arc, or vice versa. See “Change Line/Arc” on page 96.
- Click the **Record Walkthrough Along Path**  edit button to record a walkthrough video of your model along the path defined by the selected polyline. See “Walkthrough Paths” on page 335.

Editing Closed Polyline-Based Objects

Closed polyline-based objects are composed of individual line- and arc-based objects joined end-to-end and forming an enclosed area. See “Polylines” on page 105.

Objects are considered closed polyline-based when they can be edited similar to closed CAD polylines using their edit handles.

Closed CAD polylines and terrain features are examples of closed polyline-based objects.

For information about editing open polyline-based objects, see “Editing Open Polyline-Based Objects” on page 85.

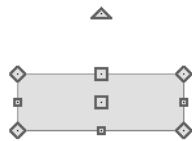

Some objects, such as connected road segments, have additional edit handles that allow you to concentrically adjust the width of all segments of the object.

Using the Edit Handles

A polyline can be composed of many segments. See “Polylines” on page 105.

When selected, a closed polyline-based object displays a Move handle, a Rotate handle, and a Reshape handle at the intersection of each segment.

Each straight, line-based segment has a Move edit handle along its length.

Each curved, arc-based segment has its own Move handle at the center of its chord, a Resize handle and a Reshape handle. See “Editing Arc-Based Objects” on page 83.

When a polyline is selected, the edge that you click nearest is called the selected edge, and certain operations affect only this edge. The Move handle of the selected edge is larger than that of other edges. It displays along the length of a line segment, or at the center of the chord on an arc segment. See “Selected Edge” on page 80.

Any action performed using the edit handles can be cancelled by pressing the Esc key or any two mouse buttons at the same time.

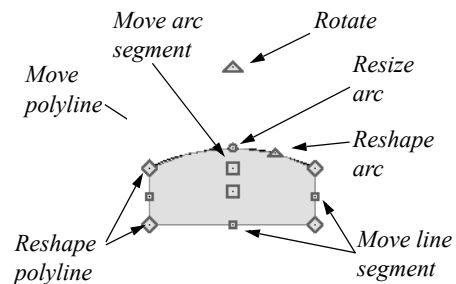

Move

- Click and drag the Move handle to move the object.

- Movement may be limited or stopped by other objects or Snap Behaviors. Move restrictions can be overridden by holding down the Ctrl key while dragging. See “Unrestricted Movement” on page 93.

Rotate

- The **Rotate** handle is used to rotate the object about its center. Its position varies depending on which edge is currently selected. See “Rotating Objects” on page 96.

Reshape

- Click and drag a Reshape edit handle to change the angle and/or length of the segments on either side of it, or the size of the object.

Move Line Segment

- The **Move Line Segment** edit handle is found on straight segments of closed polylines and moves the straight section perpendicular to itself. Adjacent segments may extend or contract in their original directions to maintain their connections.

Move Arc

- Click and drag the Move Arc edit handle to change the radius and/or chord length or position. Adjacent segments may extend, contract, or change angle to maintain their connections.

Resize Arc

- Click and drag the Resize Arc edit handle to change the radius, chord length and chord position of the arc segment. Adjacent segments may extend, contract, or change angle to maintain their connections.

Reshape Arc

- Click and drag the Reshape Arc edit handle to change the radius of the arc without moving its end points.

Using Dimensions



Dimensions can be used to move or reshape closed polyline-based objects. See “Moving Objects Using Dimensions” on page 154.

Using the Specification Dialog













Closed polyline-based objects can be edited using their specification dialogs. See “Polyline Specification Dialog” on page 106.

Using the Edit Toolbar

A selected closed polyline-based object can be edited in a variety of ways using the buttons on the edit toolbar.

The following toolbar buttons may display on the edit toolbar for a selected closed polyline-based object:

- Click the **Select Next Object**  edit button to select nearby objects instead of the selected object. See “Selecting Objects” on page 79.
- Click the **Open Object**  edit button to open the specification dialog for the selected object. See “Specification Dialogs” on page 25.
- Click the **Copy/Paste**  edit button to copy the selected object(s) to the system clipboard so they can be pasted elsewhere. See “Copying and Pasting Objects” on page 70.
- Click the **Delete**  edit button to delete the selected object(s). See “Deleting Objects” on page 98.
- Click the **Center Object**  edit button to center an object along a wall within a room or relative to a cabinet fixture. See “Using Center Object” on page 94.
- Click the **View Drawing Group Edit Tools**  edit button to modify the selected object’s place in the drawing order. See “Drawing Group Edit Tools” on page 76.
- Click the **Break**  edit button to add a new corner or pivot point to the selected object. See “Break” on page 95.
- Click the **Complete Break**  edit button to break an edge of the selected object into two separate objects. See “Break” on page 95.
- Click the **Change Line/Arc**  edit button to change a line-based polyline edge to an arc, or vice versa. See “Change Line/Arc” on page 96.
- Click the **Record Walkthrough Along Path**  edit button to record a walkthrough video of your model along the path defined by the selected polyline. See “Walkthrough Paths” on page 335.

Editing Box-Based Objects

Objects are considered box-based when they can be edited similar to CAD boxes using their edit handles.

Box-based objects are similar to closed polyline-based objects, but must always have four sides with right-angled corners.

In addition to the CAD Box tools, Text objects, many library symbols, pictures and images are examples of box-based objects.

Using the Edit Handles

When selected, a box-based object displays ten edit handles. Unlike polylines, boxes must always have four sides with right-angled corners.

Any action performed using the edit handles can be cancelled by pressing the Esc key or any two mouse buttons at the same time.

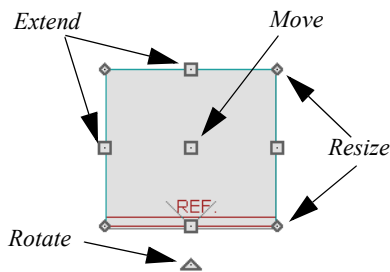

- Click and drag the Move handle to move the object.
- Movement may be limited or stopped by other objects or Snap Behaviors. Move restrictions can be overridden by holding down the Ctrl key while dragging. See “Unrestricted Movement” on page 93.

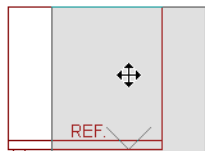

- The four **Resize** handles located at each corner are used to increase or decrease the size of the object.

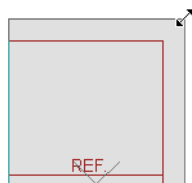

- The four **Extend** handles display along each edge. If you select an object on an edge, the Extend handle displays at the point where you clicked; otherwise, it displays at the center of the edge.



- The triangular **Rotate** handle located near the selected edge of the object is used to rotate it about its center. The pointer changes to a circular arrow  when moved over this handle. See “Rotating Objects” on page 96.

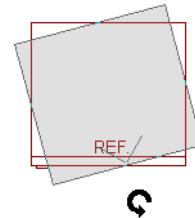

Using Dimensions



Dimensions can be used to move or reshape box-based objects. See “Moving Objects Using Dimensions” on page 154.

Using the Specification Dialog









Box-based objects can be edited using their specification dialogs. See “Box Specification Dialog” on page 107.

Using the Edit Toolbar

A selected box-based object can be edited in a variety of ways using the buttons on the edit toolbar.

The following toolbar buttons may display on the edit toolbar for a selected box-based object:

- Click the **Select Next Object**  edit button to select nearby objects instead of the selected object. See “Selecting Objects” on page 79.
- Click the **Open Object**  edit button to open the specification dialog for the selected object. See “Specification Dialogs” on page 25.

- Click the **Copy/Paste**  edit button to copy the selected object(s) to the system clipboard so they can be pasted elsewhere. See “Copying and Pasting Objects” on page 70.
- Click the **Delete**  edit button to delete the selected object(s). See “Deleting Objects” on page 98.
- Click the **Center Object**  edit button to center an object along a wall within a room or relative to a cabinet fixture. See “Using Center Object” on page 94.
- Click the **View Drawing Group Edit Tools**  edit button to modify the selected object’s place in the drawing order. See “Drawing Group Edit Tools” on page 76.

Editing Spline-Based Objects

A Spline is a curve that passes smoothly through a set of points, or vertices. Splines are typically used in situations where an irregular, free-flowing curve is needed.

Objects are considered spline-based when they can be edited similar to CAD splines using their edit handles. See “Draw Spline” on page 102.

Sprinkler lines, spline terrain curbs, spline terrain walls and both round and kidney-shaped terrain features are spline-based objects. See “Terrain” on page 349.

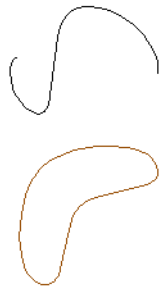

Using the Edit Handles

When a spline is selected, several different types of handles display.

Any action performed using the edit handles can be cancelled by pressing the Esc key or any two mouse buttons at the same time.

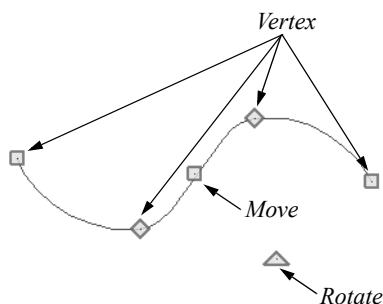

Move

- Click and drag the Move handle to move the object.
- Movement may be limited or stopped by other objects or Snap Behaviors. Move restrictions can be overridden by holding down the Ctrl key while dragging. See “Unrestricted Movement” on page 93.

Rotate

- Click and drag the Rotate edit handle to rotate the entire spline.

Vertex

- The Vertex edit handles display along the spline at each vertex. Click and drag a Vertex edit handle to change the length, angle and curve of adjacent segments without affecting other vertices.



Using the Specification Dialog









-  Spline-based objects can be edited using their specification dialogs. See “Polyline Specification Dialog” on page 106.

Using the Edit Toolbar

A selected spline-based object can be edited in a variety of ways using the buttons on the edit toolbar.

The following toolbar buttons may display on the edit toolbar for a selected spline-based object:

- Click the **Select Next Object**  edit button to select nearby objects instead of the selected object. See “Selecting Objects” on page 79.



- Click the **Open Object**  edit button to open the specification dialog for the selected object. See “Specification Dialogs” on page 25.
- Click the **Copy/Paste**  edit button to copy the selected object(s) to the system clipboard so they can be pasted elsewhere. See “Copying and Pasting Objects” on page 70.
- Click the **Delete**  edit button to delete the selected object(s). See “Deleting Objects” on page 98.
- Click the **Center Object**  edit button to center an object along a wall within a room or relative to a cabinet fixture. See “Using Center Object” on page 94.
- Click the **View Drawing Group Edit Tools**  edit button to modify the selected object’s place in the drawing order. See “Drawing Group Edit Tools” on page 76.
- Click the **Break**  edit button to add a new corner or pivot point to the selected object. See “Break” on page 95.
- Click the **Complete Break**  edit button to break an edge of the selected object into two separate objects. See “Break” on page 95.
- Click the **Record Walkthrough Along Path**  edit button to record a walkthrough video of your model along the path defined by the selected polyline. See “Walkthrough Paths” on page 335.

Editing Circles, Ovals and Ellipses

Objects created using the **Circle, Oval, and Ellipse Tools** are unusual in that no architectural objects share their functionalities.

Using the Edit Handles

When selected, circles, ovals and ellipses display eleven edit handles.

Unlike **Ovals**  and **Ellipses** , a **Circle**  cannot be edited into any other shapes; it can only be a circle.

Any action performed using the edit handles can be cancelled by pressing the Esc key or any two mouse buttons at the same time.

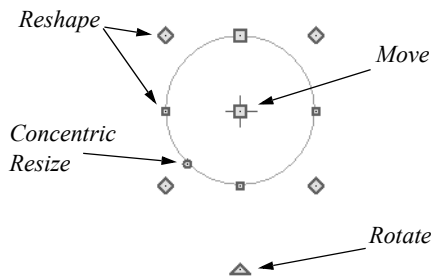

Move

- Click and drag the Move handle to move the object. .
- Movement may be limited or stopped by other objects or Snap Behaviors. Move restrictions can be overridden by holding down the Ctrl key while dragging. See “Unrestricted Movement” on page 93.

Rotate

- Click and drag the Rotate handle of an oval or ellipse to change its orientation.

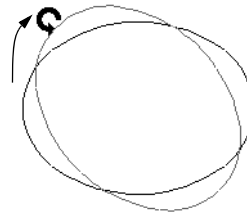

Reshape

- The eight edit handles beyond the perimeter are Reshape edit handles. Move them in or out to resize and reshape an oval or ellipse.

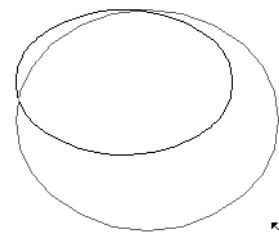

- Unlike ovals and ellipses, circles cannot be reshaped. When a Reshape handle is dragged on a circle, it is only resized.

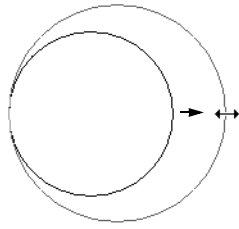

Concentric Resize

- The Concentric Resize edit handle displays on the perimeter of a circle between a corner Reshape handle and the center. Click and drag this handle to resize the circle without moving its center point.

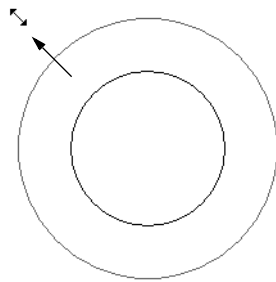

Using Dimensions

 Dimensions can be used to move or resize circle-based objects. See “Moving Objects Using Dimensions” on page 154.

Using the Specification Dialog

 Circles, ovals and ellipses can be edited using their specification dialogs. See “Circle/Oval/Ellipse Specification Dialog” on page 105.

Moving Objects

Objects can be moved using the edit handles as well as a variety of edit tools. Multiple selected objects can also be moved as a group. See “Selecting Objects” on page 79.

Using the Edit Handles



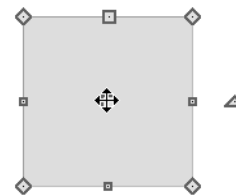



Select an object, then click the **Move** edit handle and drag it to a new location. When your pointer is over the Move handle, it displays a four-headed arrow.



Using the Edit Toolbar

A selected circle, oval or ellipse can be edited in a variety of ways using the buttons on the edit toolbar.

The following toolbar buttons may display on the edit toolbar for a selected circle, oval or ellipse:

- Click the **Select Next Object**  edit button to select nearby objects instead of the selected object. See “Selecting Objects” on page 79.
- Click the **Open Object**  edit button to open the specification dialog for the selected object. See “Specification Dialogs” on page 25.
- Click the **Copy/Paste**  edit button to copy the selected object(s) to the system clipboard so they can be pasted elsewhere. See “Copying and Pasting Objects” on page 70.
- Click the **Delete**  edit button to delete the selected object(s). See “Deleting Objects” on page 98.
- Click the **Center Object**  edit button to center an object along a wall within a room or relative to a cabinet fixture. See “Using Center Object” on page 94.
- Click the **View Drawing Group Edit Tools**  edit button to modify the selected object’s place in the drawing order. See “Drawing Group Edit Tools” on page 76.

When moved, the selected object moves orthogonal, or at a right angle to, any of its edges.

As an object is moved, it jumps at set increments when **Grid Snaps**  are enabled. See “Grid Snaps” on page 68.

If a selected object passes over its original location as it is being moved, it will snap to that location.

You can temporarily slow the movement of your mouse as you drag an edit handle by holding down the Shift key on your keyboard.

Bumping/Pushing

When an object bumps into another object while it is being moved, it stops. If you do not release the mouse button and continue to drag, however, the selected object resumes movement and continues past the obstructing object.

Instead of dragging through and past obstructing objects, you can instead push them. To do this, bump an object into an obstructing object and release the mouse button. Then, click and drag the Move edit handle a second time in the same direction.

Walls, wall openings, cabinets, furnishings and fixtures, and CAD and CAD-based objects are examples of objects that can bump into as well as push other objects.

Bumping/Pushing does not affect objects moved using dimensions. See “Moving Objects Using Dimensions” on page 154.

Unrestricted Movement

Many objects have restrictions placed on their movement by their own properties or specification settings. Architectural objects, for example, bump into other 3D objects as they are being moved.

Other move restrictions are activated by the **Snap Settings**. See “Snap Behaviors” on page 67.

These restrictions can be overridden when necessary by holding down the Ctrl key while dragging to move an object.

To move an object freely

1. Select the object.
2. Hold down the Ctrl key.
3. Click the Move edit handle and drag it to the new location.

Aligning Objects

It is often important to align objects such as text boxes or walls, or to align objects on different floors. There are several methods to choose from.

You can also press the Ctrl key while dragging an object’s Move handle to override move restrictions.

Nudging

You can use the arrow keys on your keyboard to move a selected object or objects by single **Snap Grid** increments in 2D and 3D views. This is referred to as nudging. See “Grid Snaps” on page 68.

In Plan View

To nudge an object in plan view, select it and press any of the four arrow keys: Up, Down, Left, or Right.

In 3D Views

In 3D views, nudging is relative to the selected surface. If, for example, you select the front of a cabinet in 3D and nudge it to the left, it will move to the left in plan view. If you instead select the back of a cabinet in 3D and nudge it to the left, it will move to the right in plan view.

When multiple objects are selected, the surface that was clicked on last is considered the selected surface. When nudged, all selected objects will move relative to that surface. See “Shift and Ctrl Select” on page 81.

If an object is rotated, the directions that it can be nudged in 2D are not affected; however, in 3D, they are. If, for example, a cabinet is rotated 45°, it will nudge to the left in plan view. When nudged in 3D, however, it will move at a 45° angle: or parallel to the selected surface.

Center Object



The **Center Object** edit button allows you to move walls, cabinets and other objects so that they are centered along a wall within a room or relative to a window or cabinet.

Using Dimensions



Objects or the selected edges of some objects can be moved using dimensions. See “Moving Objects Using Dimensions” on page 154.

Using the Mouse Pointer Crosshairs



Objects can be aligned by eye using the mouse pointer crosshairs as a reference. This method can



help you draw, place and edit objects quickly, easily, and with reasonable accuracy, but is not necessarily as accurate as some of the other approaches described here. See “Crosshairs” on page 21.

The mouse pointer crosshairs can be turned on and off in the **Preferences** dialog. See “Edit Panel” on page 54.

Using Snap Settings

With **Object Snaps**, you can snap the edge of a selected object to that of another. Select an edge of an object. Drag it to the edge of another object, then release the mouse.

With **Grid Snaps**  on and **Angle Snaps**  off, select the left side of the object, and drag from the center move handle. This snaps the selected side to the grid.

When both **Grid Snaps**  and **Angle Snaps**  on, objects snap at increments equal to the **Snap unit** specified in the **Plan Defaults** dialog rather than onto the grid itself. This does not align objects to the grid unless they were already snapped to the grid. See “Snap Behaviors” on page 67.

Using Dimensions

 Create a temporary or manual dimension relative to an object such as a wall or line, and relocate the objects to the same dimension. See “Moving Objects Using Dimensions” on page 154.

 Text objects can be aligned using settings in the Text Specification dialog. See “Aligning Text” on page 162.

Using Center Object

 The **Center Object** edit button can be used to center a variety of objects either relative to another object. Center Object can be used in floor plan, elevation, and 3D views.

Resizing Objects

Objects can be resized using the edit handles and specification dialogs.

Using the Edit Handles

The end, corner and/or side edit handles can be used to resize a selected object.

To center an object

1. Select an object.
2. Click the **Center Object**  edit button.
3. Move the mouse pointer over the object you would like to center the selected object relative to.
 - As the pointer passes over an eligible object, it becomes highlighted and a dashed centering axis line displays.
4. When the desired centering axis displays, click once to center the selected object along that axis line.

To center an object in a room

1. Select an object such as a cabinet.
2. Click the **Center Object**  edit button.
3. Move the mouse pointer in the room that you would like to center the selected object relative to.
 - As you move the pointer, a centering axis will display along the wall it is closest to.
 - The selected object does not have to be inside a room in order to be centered relative to that room.
4. When a centering axis displays along the correct wall, click once.
5. The object is moved perpendicular to the centering axis.

If you click outside an exterior wall instead of clicking inside, the selected object is centered along the edge of the Exterior Room. See “The Exterior Room” on page 134.

Aligning Objects on Different Floors

Objects on different floors can be aligned with one another using the **Reference Display** . See “The Reference Floor” on page 231.

To override any movement restrictions caused by snap settings or the presence of other objects, press the Ctrl key while dragging an edit handle.

As an object is resized, any dimensions indicating its size will update to reflect your changes. You can use dimensions as references to help you achieve the correct size for most objects.

You can temporarily slow the movement of your mouse as you drag an edit handle by holding down the Shift key on your keyboard.

Using the Specification Dialog

 Most objects can be accurately resized in their specification dialogs. See “Specification Dialogs” on page 25.

Reshaping Objects

There is a variety of ways to reshape objects using the edit handles, specification dialogs and edit toolbar buttons.

Some objects, notably circles and box-based objects, cannot be reshaped - only resized. See “Resizing Objects” on page 94.

Using the Edit Handles

Depending on the type of object selected, the end, corner and/or side edit handles can be used to reshape a selected object.

To override any movement restrictions caused by snap settings or the presence of other objects, press the Ctrl key while dragging an edit handle.

You can temporarily slow the movement of your mouse as you drag an edit handle by holding down the Shift key on your keyboard.

Using the Specification Dialog

 A variety of CAD and CAD-based objects can be reshaped by editing values on either the SELECTED LINE or SELECTED ARC panel of their specification dialogs. See “Polyline Specification Dialog” on page 106.

Using Dimensions

 Both temporary and manually drawn dimensions can be used to increase or decrease the distance between the edge a line- or polyline-based object and another, parallel edge or line.

7. Click the **Main Edit Mode**  edit button or press the Esc key to return to the selected

Using Dimensions

 Many objects can be resized by selecting an edge and then moving that edge using dimensions. See “Moving Objects Using Dimensions” on page 154.

Walls can also be resized using dimensions; however, it is important to understand that the selected edges of other objects cannot be resized using dimensions - they can only be moved. To resize an edge, select an adjacent edge and move that edge instead.





Break

 The **Break** edit tool can be used to break an individual line-, arc-, or spline-based object into two segments. The edges of a polyline-based object can also be broken.

Note: The Break edit button is not available for box-based objects, objects created with the Circle Tools, or some architectural objects such as stairs.

There are two types of breaks: partial and complete. Partial breaks create a new corner, or pivot point, while complete breaks actually sever an edge into two segments.







To create a partial break

1. Click the object, object edge, or object center-line that you want to break into two segments.
 2. Click the **Break**  edit button once or press the 3 key.
 3. If you would like to create more than one break, click the **Sticky Mode**  edit button.
 4. If you want, you can click the **Corner Edit Handles**  edit button to toggle off their display.
 5. Click the edge to create a new corner edit handle at that location and two separate edges on either side of that handle.
 6. If you enabled **Sticky Mode** , continue clicking to place additional breaks.
- object's main edit toolbar.

If you click and drag one of the edit handles on either side of the partial break, the edge moves at a right angle to itself and another edge forms, connecting the moved edge with the one on the other side that does not move.

You can remove an edge from a polyline-based object by clicking and dragging a corner handle until it snaps to an adjacent corner handle.

To create a complete break

1. Click the object, object edge, or object center-line that you want to break into two segments.
2. Click the **Break**  edit button.
3. Click the **Complete Break**  edit button.
4. If you would like to create more than one complete break, click the **Sticky Mode**  edit button.
5. If you want, you can click the **Corner Edit Handles**  edit button to toggle off their display.
6. Click on an edge to create a complete break at that location.
7. If you enabled **Sticky Mode** , continue clicking to place additional breaks.
8. Click the **Main Edit Mode**  edit button or press the Esc key to return to the selected object's main edit toolbar.

The edge that you clicked on will be divided into two separate sections, one of which will be selected. You can now move or edit the selected edge completely

independent of the object or edge on the other side of the break. Click on the other edge to select it instead.

To remove a break from an edge

1. Make sure that **Object Snaps** are enabled. See “Object Snaps” on page 68.
2. Select the object that has a break that you want to remove.
3. Click on the corner edit handle associated with the break that you want to remove and drag it to an adjacent corner handle.
4. Release the mouse button and the handle that you selected will be removed.

Change Line/Arc

 Select an individual line-based or arc-based object or a segment of a polyline-based object and click the **Change Line/Arc** edit button to convert the selected segment from a line to an arc or vice versa.

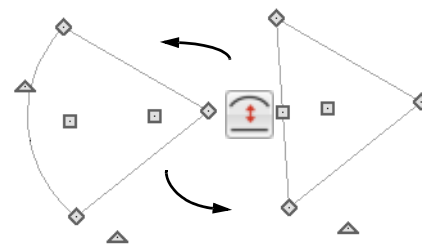

Simplify Polyline

 The **Simplify Polyline** edit button is available for an open or closed polyline or polyline-based object with a segment that is unusually short and can cause problems when editing the polyline's shape. Click this edit button to remove the segment.

Rotating Objects

Objects can be rotated using the edit handles as well as a variety of edit tools. Multiple selected objects can also be rotated as a group. See “Selecting Objects” on page 79.

By default, an object or group of objects rotate about the center point of the selection set.

Using the Edit Handles

Select an object, then click the triangular **Rotate** edit handle and drag it in any direction. When your pointer is over the Rotate handle, it displays a curved arrow.

The angles of line-based objects can also be changed by dragging an end handle in a direction other than parallel to the object. The object rotates about the opposite end point. See “Editing Line-Based Objects” on page 82.

Objects snap to Allowed Angles as they are rotated. See “Angle Snaps” on page 68.

To override any movement restrictions caused by snap settings or the presence of other objects, press the Ctrl key while dragging an edit handle.

You can temporarily slow the movement of your mouse as you drag an edit handle by holding down the Shift key on your keyboard.

Using the Specification Dialog

 The exact angle of some objects such as lines, arcs, walls and the selected edges of polylines can be specified on either the GENERAL panel, SELECTED LINE panel, or SELECTED ARC panel of that object's specification dialog. See "Polyline Specification Dialog" on page 106.

Eyedropper and Painter Tools

There are a number of tools in Home Designer Suite that allow you to apply attributes to objects by clicking on them.

- The Eyedropper tools allow you to load attributes from one object and apply them to other objects.
- The Painter tools allow you to apply attributes to one or more objects. Depending on the tool, attributes may be loaded from another object using an Eyedropper tool or selected from a dialog.
- Some object attributes can also be replaced directly from the library. See "To replace an inserted object" on page 283.

Eyedropper Tools

The Eyedropper tools allow you to select attributes from one object and apply them to other objects. There are two Eyedropper tools in the program:

- **Material Eyedropper** .
- **Object Eyedropper** .

To use an eyedropper tool

1. Select the Eyedropper tool that you want to use and notice that the mouse pointer displays an eyedropper  icon.
2. Move the mouse pointer over an object in the current view. If the object is eligible for use with the selected Eyedropper:
 - It will become highlighted in the view.
 - The left side of the Status bar will report information about that object or the attribute that the Eyedropper can load from it.
3. Click once to load the object's attributes so they can be applied to other, similar objects.

Reverse Plan

 The **Reverse Plan** tool is a quick way to mirror a plan so that everything on all floors of the entire plan is swapped left to right.

Select **Tools> Reverse Plan**  to reflect an entire plan right to left, as though it were reflected about a vertical line.

4. Notice that your mouse pointer now displays a spray can  icon. This means that the Painter tool associated with the selected Eyedropper is now active.
5. Depending on the tool in use, additional buttons may now display on the edit toolbar. Select the option or options that you need:
 - The **Painter Mode** buttons. See "Painter Modes" on page 98, below.
 - **Blend Colors with Materials**. See "Material Painter Tools" on page 295.
6. Move your mouse pointer over an object that is similar to the one selected in step 2. If it is eligible to receive the loaded attribute(s):
 - It will become highlighted in the view.
 - The left side of the Status bar will report information about the attribute to be painted or loaded.
7. Click on an eligible object to apply attributes to it as well as to any other identical objects, depending on which Painter Mode is active.
8. Continue clicking to apply attributes until the Esc key is pressed or another tool is activated.

Painter Tools

The Painter Tools let you apply attributes to a wide variety of objects by clicking on them. When a Painter tool is active, the mouse pointer will display a spray can  icon. There are a number of ways to load attributes into a Painter tool.

- Click on an object using any Eyedropper tool to load its attribute(s). The associated Painter tool will become active, ready to paint the loaded attributes.

- Select a material in the Library Browser and move the mouse pointer into the current view window. If that item can be applied in the current view type, the associated Painter will be active and you can apply the selection to eligible objects in that view.
- When you select the **Material Painter**  tool, the **Select Material** dialog will open, allowing you to choose a material from the library. See “Select Material Dialog” on page 297.

Once a Painter tool is loaded, simply click on an object to apply the selected attributes. See “To use the Material Painter tool” on page 295.

Painter Modes





There are five Painter Modes that control how broadly or narrowly a selected Painter tool will apply an attribute or attributes to objects in the current plan. These modes are listed in the same submenu as the associated Eyedropper and/or Painter tool. When a Painter tool is active, they are also found on the edit toolbar. In both locations, a small check mark will display at the lower left of the active Mode’s button icon.



Rather than modify instances of an object type, the Material Painter Modes replace instances of a material based on the selected scope.

- **Object Mode**  applies attributes to or replaces a material on individual target objects, one at a time. All instances of the original material on a

target object are replaced by the one being painted.

- **Marquee Mode**  is available in plan view for the Fill Style Painter and Object Painter tools. To use this mode, click and drag a marquee around the objects you would like to paint instead of clicking on them.
- **Room Mode**  applies attributes to a target object as well as to all instances of that object type in the same room with a single click. All instances of the original material throughout the room are replaced by the one being painted.
- **Floor Mode**  applies attributes to a target object as well as all instances of that object type on the same floor with a single click. All instances of the original material on the current floor are replaced by the one being painted.
- **Plan Mode**  applies attributes to a target object as well as all instances of that object type in the entire plan with a single click. All instances of the original material throughout the plan are replaced by the one being painted.
- An additional mode, the **Material Painter Component Mode** , is available for the Material Painter only. See “Material Painter Modes” on page 295.

Home Designer Suite will remember your Painter Mode selection until you quit the program. The next time you launch the program, Object Mode will be active.

Object Eyedropper





Select **Tools> Object Painter> Object Eyedropper** to apply the attributes of one object to other, similar objects. The Object Eyedropper

functions like other Eyedropper tools. See “To use an eyedropper tool” on page 97.

Deleting Objects

Objects can be deleted in a variety of ways:

- Select an object or group of objects, then click the **Delete**  edit button, select **Edit> Delete**  from the menu, or press either the Delete or Backspace key on your keyboard.
- Entire categories of objects can be deleted using the **Delete Objects** dialog.

- Objects are deleted if the floor they are placed on is deleted. See “Deleting Floors” on page 229.

If an object has a line with arrow attached to it, the line with arrow is deleted if the object is deleted. To prevent the arrow from being deleted, drag the attached end away from the object before deleting it.

Objects such as roofs and Auto Exterior Dimensions that are set to automatically rebuild or refresh cannot

be deleted while that behavior is enabled. Automatically generated objects cannot be deleted unless the automatic creation option is disabled.

Deleting Polyline Edges

To remove an edge from a polyline, drag a corner handle until it overlaps an adjacent corner handle to remove the edge between them and merge them into

a single handle. See “Reshaping Objects” on page 95.

Delete Surface



In any 3D view, select **3D> Delete Surface**, then click a surface in the view to temporarily remove the surface from the current view without permanently affecting the object. See “Delete 3D Surface” on page 307.

Delete Objects Dialog



Select **Edit> Delete Objects** to use the **Delete Objects** dialog to delete all objects of one or

more specified types in one room, on the current floor, or on all floors in the plan.

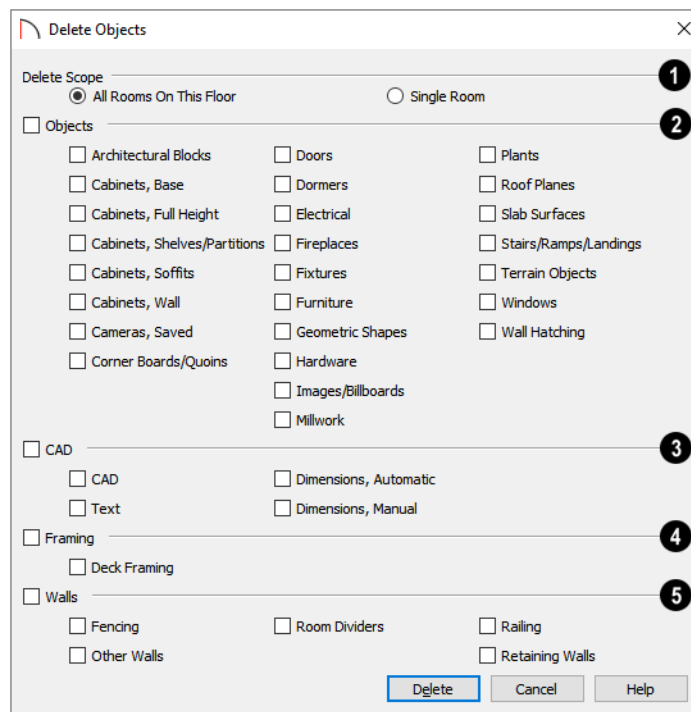

1 Select a **Delete Scope**:

- Choose **All Rooms on This Floor** to delete objects in all rooms on the current floor.
- Choose **Single Room** to delete objects only in rooms on the current floor that you specify.

2 Specify which types of architectural **Objects** you want to delete.

3 Specify which types of **CAD** objects you want to delete. See “CAD Objects” on page 101.

4 Specify whether or not to delete **Deck Framing**. See “Deck Framing and Planking” on page 138.

5 Specify which kinds of **Walls** you want to delete. See “Walls, Railings, and Fencing” on page 109.

To use the *Delete Objects* dialog

1. Specify the **Delete Scope** as **Single Room** or **All Rooms On This Floor**.
 2. Click **Select All** to check all the boxes or **Clear All** to uncheck all boxes.
- Check the box for each category of objects you want to delete. Check the box beside any heading to select all of the categories within it; clear the box beside a heading to deselect all of its categories.



3. Check the box for each subcategory of objects that you want to delete.
4. When the scope is set to **Single Room**:
 - Move your cursor into the drawing area and click in a room of the plan to delete objects of the selected type within that room without closing the dialog.
 - Only objects with their center point located in the room are deleted.
- Continue clicking on rooms or choose a different Delete Scope.
- Click **Done** when all selections have been deleted.
5. If you select **All Rooms On This Floor**, you do not need to click in plan view. The **Delete** button becomes available, and clicking it closes the dialog and deletes the specified objects.



Undo and Redo





The **Undo** and **Redo** commands allow you to both undo the last action performed, as well as redo actions that were recently Undone.

The 50 most recent actions can be Undone or Redone. Actions that can be Undone and Redone include creating, editing, and deleting objects.

To Undo an action, select **Edit> Undo** , click the **Undo**  button, or press Ctrl + Z on your keyboard.

The Redo command is only available after Undo has been used. To Redo an Undone action, select **Edit> Redo** , click the **Redo**  button or press Ctrl + Y on your keyboard.

It is important to note that **Undo**  and **Redo**  do not affect all actions in the program, including:

- Save and Save As. See “Saving, Exporting, and Backing Up Files” on page 34.
- Changes made in the Library Browser. See “The Library Browser” on page 271.
- Changes made in a dialog while the dialog box is open. See “Dialogs” on page 24.
- Changes made to the display by panning the display or zooming in or out. See “Undo Zoom” on page 64.
- Changes made to the position of a camera, or its Rendering Technique. See “Editing 3D Views” on page 311.

CAD Objects



The CAD Tools are used to add information to 2D views of your model. CAD objects do not affect 3D objects or display in camera views or overviews, but they can be used to add details to plan views.

CAD objects are edited much like other objects in Home Designer Suite. See “Editing Objects” on page 79.



The CAD Drawing Tools

 The CAD drawing tools can be accessed by selecting the CAD menu or by clicking the CAD Tools button.

Draw Lines

  Select **CAD > Draw Line** or **CAD > Draw Line With Arrow** to draw lines with or without arrows.

To draw a line or line with arrow

1. Select **CAD > Draw Line**  or **Draw Line With Arrow** .
2. Click and drag in the drawing area to draw a line.
3. Continue drawing lines as needed, then select another tool when you are finished.

Once a line is created, it can be edited. You can snap the ends of lines together to form polylines. See

Chapter Contents

- The CAD Drawing Tools
- Line Specification Dialog
- Arc Specification Dialog
- Circle/Oval/Ellipse Specification Dialog
- Polylines
- Polyline Specification Dialog
- Box Specification Dialog
- Splines
- Displaying CAD Objects

“Editing Line-Based Objects” on page 82 and “Line Specification Dialog” on page 102.



If either end of a Line with Arrow is snapped to an object, it maintains its connection if that object is moved. See “Text Arrows” on page 164.

Draw Arc

 Select **CAD > Draw Arc** to draw an arc.

To draw an arc

1. Select **CAD > Arcs > Draw Arc** , then click at the arc’s start point.
2. Move the pointer along the desired curve while dragging to curve the arc.
3. Release the mouse button at the end point to complete the arc.

Once an arc is created, it can be edited. See “Editing Arc-Based Objects” on page 83 and “Arc Specification Dialog” on page 104.

You can snap the ends of arcs together with other arcs or with lines to form polylines. See “Polylines” on page 105.

Draw Polyline



Select **CAD > Draw Polyline** to draw a rectangular polyline in either of two ways:

- Click in the drawing area to place a 24” x 24” square polyline at that location.
- Click and drag to draw a rectangle of any size.

Once drawn, a rectangular polyline can be edited into any shape. See “Editing Closed Polyline-Based Objects” on page 87 and “Polyline Specification Dialog” on page 106.

Draw Box



Select **CAD > Draw Box** to draw a box.

CAD boxes are drawn from corner to corner, forming a rectangle that can then be edited. Unlike a polyline, a box always has four 90° corners. See “Editing Box-Based Objects” on page 89 and “Box Specification Dialog” on page 107.

Draw Circle



Select **CAD > Draw Circle** to draw a circle.

Draw a **Circle**  by dragging across the diameter, in any direction.

If a small circle is needed, draw a larger circle and then resize it. See “Editing Circles, Ovals and Ellipses” on page 91 and “Circle/Oval/Ellipse Specification Dialog” on page 105.

Draw Oval



Select **CAD > Draw Oval** to draw an oval, which is a four-arc approximation of an ellipse.

ellipse.

Line Specification Dialog



Select a CAD Line, Line With Arrow, or Text Line With Arrow and click the **Open Object** edit button to open the **Line Specification** dialog.

Draw an oval, by clicking and dragging at an angle to define its maximum height and width.

Once an oval is created, it can be edited. See “Editing Circles, Ovals and Ellipses” on page 91 and “Circle/Oval/Ellipse Specification Dialog” on page 105.

Draw Ellipse



An **Ellipse** is a set of points with a constant combined distance from two points called foci. An ellipse looks like a stretched circle, or a circular surface viewed at an angle.

To draw an ellipse, select **CAD> Draw Ellipse**  and drag at an angle to define its maximum height and width.

Once an ellipse is created, it can be edited. See “Editing Circles, Ovals and Ellipses” on page 91 and “Circle/Oval/Ellipse Specification Dialog” on page 105.

Draw Spline



A Spline is a curve that passes smoothly through a set of points. Select **CAD> Draw Spline** to draw connected line segments that form a spline. See “Splines” on page 107.

Once created, a spline can be selected and edited. See “Editing Spline-Based Objects” on page 90 and “Polyline Specification Dialog” on page 106.

Dimension Tools



Select **CAD> Dimensions** to access the Dimension Tools. The **Dimension Tools** can be used with CAD and architectural objects and are discussed in their own chapter. See “Dimensions” on page 147.

Text Tools



Select **CAD> Text** to access the Text Tools. The Text Tools are discussed in their own chapter. See “Text” on page 157.

The settings on the panels in this dialog are found in the specification and defaults dialogs for a variety of different objects in the program.

Line Panel

The information on the **LINE** panel of the **Line Specification** dialog is similar to that found on the

SELECTED LINE panels of various specification dialogs in the program.

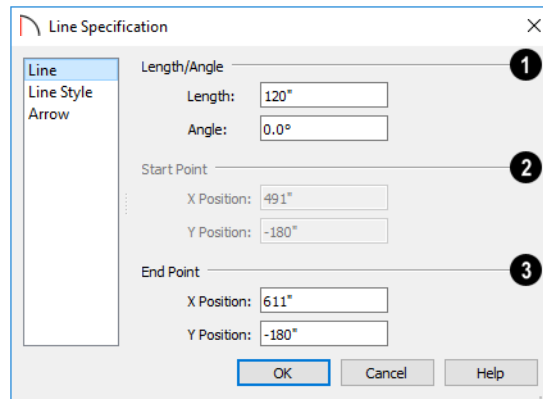

- 1 Specify the **Length** and **Angle** of the selected line.
- 2 The **X** and **Y Position** coordinates of the selected line's **Start Point** display for reference but cannot be changed here. The Start Point can be

changed using the line's edit handles, however. See "Editing Line-Based Objects" on page 82.

- 3 Specify the **X** and **Y Position** of the selected line's **End Point**.

Line Style Panel

The **LINE STYLE** panel is found in the specification dialogs for many different objects. The settings here control the appearance of the lines and/or arcs that

make up an object. Depending on the type of object selected, some settings may not be available.

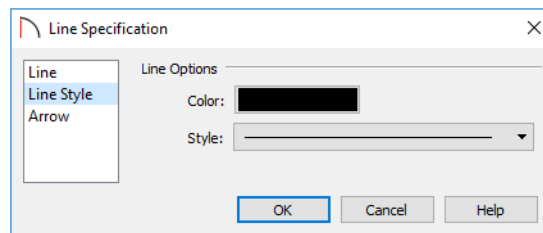

- Click the **Line Color** box to specify a new line color. See "Select Color Dialog" on page 77.

 Mouse over the Color bar to display a tool tip reporting the selected color's RGB values.

- Click the **Line Style** drop-down list to select from a variety of available line styles.

An additional **Display Options** setting is available in the **Picture File**, **Metafile**, and **PDF File Box Specification** dialogs. See "Pictures, Images, and Walkthroughs" on page 325.

- Check **Show Outline** to display the selected object's border polyline.

Arrow Panel

The **ARROW** panel is available for any line, arc, open polyline, or spline that can have an arrow: including dimension lines. The defaults for arrows are set in the **Arrow Defaults** dialog. See "Dimension Defaults Dialog" on page 147.

A line, polyline, or spline with an arrow can be attached to other objects. It attaches to a closed polyline-based object along its edges, but can attach to an architectural object anywhere within its 2D symbol in plan view. If an arrow is attached to

another object, deleting that object will also delete the arrow.

Some objects, notably Joist Direction Lines, do not have the Attach or Auto Position settings. Other

objects, including closed polylines and Electrical connections are examples of objects that cannot have arrows at all.

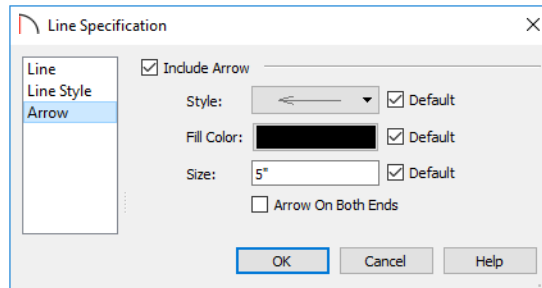

- Check **Include Arrow** to create an arrowhead at the end of the selected line, arc, or open polyline.
- Select an arrowhead **Style** from the drop-down list.
- Click the **Fill Color** box to select a color for the arrowhead to be used if a solid Style is selected. See “Select Color Dialog” on page 77.
- Specify the arrowhead’s **Size**.
- Check the box beside **Arrow On Both Ends** to create a two-headed arrow.
- Place a check in any of the **Default** boxes to restore that setting to the default.

Arc Specification Dialog



Select an arc and click the **Open Object** edit button to open the **Arc Specification** dialog.

The settings on the **ARC** panel are also found on the **SELECTED ARC** panels for many objects.

Arc Panel

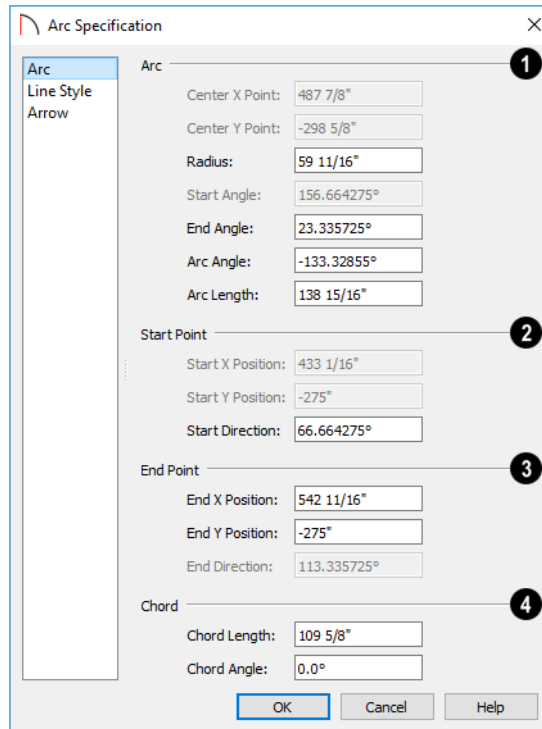

- 1 These settings define the **Arc**. Some values are listed for reference only and cannot be directly changed here. They can, however, be changed using the edit handles and edit tools. See “Editing Arc-Based Objects” on page 83.
 - The **Center X and Center Y Points** are the X and Y coordinates of the center of the arc and display for reference. They may update as changes are made to other settings in this dialog.
 - **Radius** - Specify the distance between the center of the arc and the arc surface.
 - **Start Angle** - The angle of a line drawn from the arc center to the arc start points. This displays for reference only but may update as changes are made to other settings in this dialog.
 - **End Angle** - Specify the angle of a line drawn from the arc center to the arc end.
 - **Arc Angle** - Specify the angle between the center of the arc and each end.
 - **Arc Length** - Specify the length of the arc along its curve.
- 2 **Start Point** - Specify information about the starting point of the selected arc.
 - The **Start X and Start Y Position** coordinates display for reference. They may update as changes are made to other settings in this dialog.

- **Start Direction** - Specify the angle of a tangent line at the start of the arc.
- 3 **End Point** - Specify information about the end point of the selected arc.
 - **End X** - Specify the X coordinate for the end of the arc.
 - **End Y** - Specify the Y coordinate for the end of the arc.
 - **End Direction** - The the angle of a tangent line at the end of the arc displays for reference. This displays for reference only but may update as changes are made to other settings in this dialog.
- 4 Define the selected arc’s **Chord**, which is the straight line between its start and end points.
 - **Chord Length** - The straight line distance between the two ends of the arc.
 - **Chord Angle** - Specify the angle of the chord.

Line Style Panel

For information about the LINE STYLE panel, see “Line Style Panel” on page 103.

Arrow Panel

For information about the ARROW panel, see “Arrow Panel” on page 103.

Circle/Oval/Ellipse Specification Dialog

 Select a circle, oval or ellipse and click the **Open Object** edit button to open the **CAD Circle, Oval or Ellipse Specification** dialog.

Line Style Panel

For information about the LINE STYLE panel, see “Line Style Panel” on page 103.

Fill Style Panel

For information about settings on this panel, see “Fill Style Panel” on page 76.

Polylines

 A polyline consists of two or more line and/or arc segments that are attached at their endpoints. Select **CAD>CAD> Rectangular Polyline**, then click and drag from corner to corner to create a rectangular-shaped, closed polyline. A closed polyline measuring 2’x 2’ (600 mm x 600 mm) can also be created by clicking once while the **Rectangular Polyline** tool is active.

You can also create a polyline by drawing lines and/or arcs end-to-end, allowing the end of each new object to snap to the end of the previous one.

Line- and arc-based objects will only snap together to form a polyline if they are on the same layer and share identical attributes such as color, line style, and arrow specifications. If one end of the polyline is connected to the other, it becomes a closed polyline.

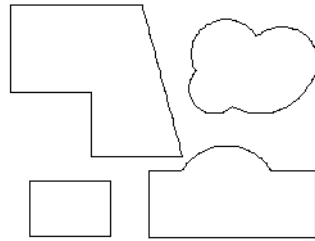

Closed Polylines

Polylines can be copied, moved, reshaped, or resized as a single unit.

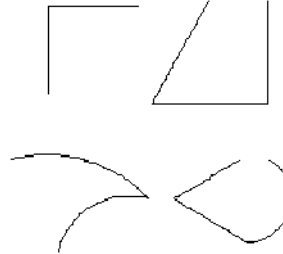

Open Polylines

Once created, polylines can be edited in a variety of ways. See “Editing Open Polyline-Based Objects” on page 85 and “Editing Closed Polyline-Based Objects” on page 87.

Polyline Specification Dialog



Select an open polyline, closed polyline, spline or Electrical connection and click the **Open Object** edit button to open the **Polyline Specification** dialog.

Polyline Panel

The POLYLINE panel is found in the specification dialogs for a variety of objects throughout the program. It states:

- The **Length** of an open polyline;
- The **Perimeter** of a closed polyline;
- The **Area** of a closed polyline;
- The **Volume** of a closed polyline;
- The **Number of Lines** that form an open polyline or the perimeter of a closed polyline or polyline hole;
- The **Number of Holes** located inside of a closed polyline;
- The **Hole Perimeter** is the total length of the perimeter(s) of any holes inside of a closed polyline;
- The **Hole Area** is the total area of the holes inside of a closed polyline.

If the polyline is not closed, the Area and Volume are described as “Not closed”. The Volume of a 2D polyline will always be 0, even if it is closed.

Selected Line Panel

The SELECTED LINE panel is available when the selected edge of the polyline is a line as opposed to an arc and is not available if the selected object is a

spline. See “Editing Line-Based Objects” on page 82.

Moving the End of a line segment moves the start of the next connected line, if there is one.

This panel is similar to the LINE panel of the **Line Specification** dialog. See “Line Panel” on page 103.

Selected Arc Panel

The SELECTED ARC panel is available when the selected segment of the polyline is an arc as opposed to a line. It is not available if the selected object is a spline.

This panel is similar to the ARC panel of the **Arc Specification** dialog. See “Arc Panel” on page 104.

Line Style Panel

This panel is similar to the LINE STYLE panel in the **Line Specification** dialog. See “Line Style Panel” on page 103.

Fill Style Panel

The FILL STYLE panel is found in the specification dialogs for a variety of objects in the program. See “Fill Style Panel” on page 76.

Arrow Panel

The ARROW panel is available for most open polylines and splines and is similar to the ARROW panel of the **Line Specification** dialog. See “Arrow Panel” on page 103.

The ARROW panel is not available for closed polylines or Electrical Connections.

Box Specification Dialog

 Select a CAD box and click the **Open Object** edit button to open the **Box Specification** dialog. See “Draw Box” on page 102.

Line Style Panel



For information about the LINE STYLE panel, see “Line Panel” on page 103.

Splines

 A Spline is a curve that passes smoothly through a set of points. Splines are typically used in situations where there is an irregular curve. A contour line is a typical example. Splines are useful wherever a free-flowing curve is needed.

Once created, splines are selected and edited. See “Editing Spline-Based Objects” on page 90 and “Polyline Specification Dialog” on page 106.

To use the Spline tool

1. Select **CAD> Draw Spline** .
2. Click and drag to draw the first spline segment just as you would a line. A single spline segment looks identical to a line, in fact. You may need to turn off **Angle Snaps**  to draw freely.

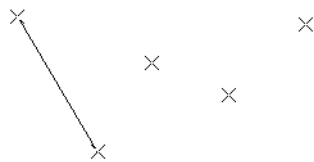

3. Draw the second segment from the end of the first at a different angle. **Object Snaps**  should be on to assure that new segments attach correctly to the ends of previous segments.

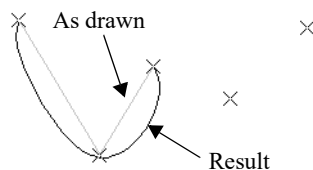

4. As soon as two straight spline segments connect end-to-end, the straight segments become a curve that passes through the endpoints defined by the original segments. Each point is called a vertex.
5. Draw a few more segments, connecting each to the free end of a previously drawn segment.

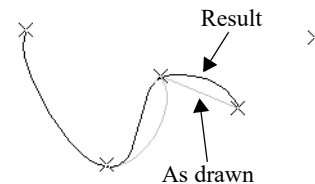

6. Notice as additional segments are drawn that the spline changes the curvature of the previous segment to create a continuous curve between the last three points.

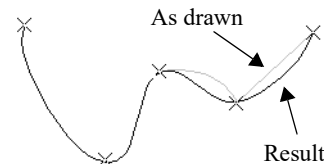

7. Form a closed spline by drawing a segment between its two free ends.

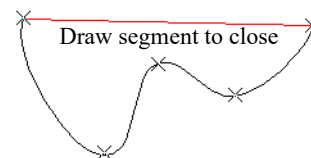

8. The result is an irregular curve that flows smoothly through each vertex.

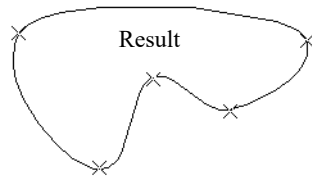

Spline-based objects will only snap together to form a single spline if they share identical attributes such as color, line style, and arrow specifications.

Displaying CAD Objects

As with architectural objects, the display of CAD objects is controlled in the **Display Options** dialog. See “Display Options Dialog” on page 74.

CAD objects can be drawn in plan views. They are 2D objects only, though, so they cannot be seen in any view other than the one they are drawn in and are never visible in camera views or overviews. See “Architectural vs CAD Objects” on page 67.

Drawing Groups

Each object in a plan file is included in a Drawing Group, which influences whether it displays in front of or behind other objects. By default, all CAD objects are placed in the same Drawing Group. Their drawing order relative to one another is based on the order in which they were placed: an object will

display in front of any objects that were created before it was.

Once created, however, the drawing order of CAD objects can be customized. See “Drawing Groups” on page 75.

Line Styles

A selection of line styles is available for you to apply to CAD and terrain objects. See “Line Style Panel” on page 103.

Fill Styles

A selection of fill styles can be applied to closed CAD and CAD-based architectural objects.

Walls, Railings, and Fencing

To draw a wall, select one of the Wall Tools, then click and drag in a line to the approximate length that you want. When you enclose an area with walls, a room is created, complete with floor and ceiling. The Door Tools and Window Tools can be used to add openings, while Dimensions are used to position walls and openings with accuracy.

Walls are the single most important structural component in Home Designer Suite. They define Rooms, are used to create Foundations, and even influence how Roofs are built. It is helpful to understand how Wall Type Definitions, wall connections, and wall alignment all affect your design.

Chapter Contents

- Wall Defaults
- Wall Tools
- Railing and Deck Tools
- Fencing Tools
- Exterior and Interior Walls
- Foundation Walls
- Railing and Deck Tools
- Room Dividers and Invisible Walls
- Polygon Shaped Decks
- Hatch Wall
- Creating Walls
- Connecting Walls
- Displaying Walls
- Measuring Walls
- Editing Walls
- Aligning Walls
- Roof Directives in Walls
- Attic Walls
- Wall Type Definitions
- Wall Specification Dialog
- Railing and Fencing Specification Dialogs
- Wall Hatch Specification Dialog

Wall Defaults





Default Settings can be accessed by selecting **Edit > Default Settings**. Click on “Walls” and click the **Edit** button to open the **Wall Defaults** dialog.



The settings in the wall defaults dialog determines what wall types are drawn when the different wall

tools are used. It is a good idea to be familiar with these settings and how they relate to your style of building.

Exterior and Interior Wall Defaults Dialogs

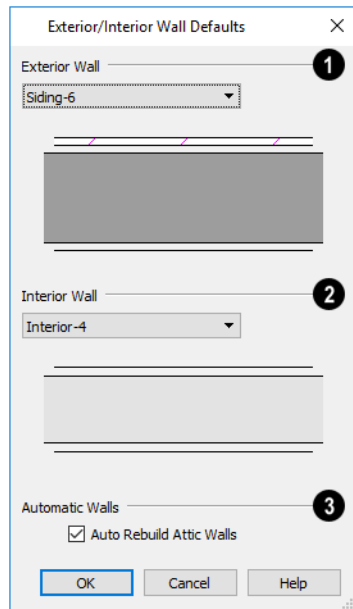
Specify the initial attributes of walls drawn using the **Exterior Wall**  and **Interior Wall**  tools in the **Exterior** and **Interior Wall Defaults** dialogs. See “Wall Tools” on page 110.



- 1 Select the wall type drawn using the **Exterior Wall**  tool.
- 2 Select the wall type drawn using the **Interior Wall**  tool.
- 3 Uncheck **Auto Rebuild Attic Walls** to prevent Attic walls from automatically generating when the model changes. When checked, Attic Walls are automatically generated. See “Attic Walls” on page 123.

Wall Tools

Select **Build> Wall** to access the Wall Tools. The type of wall drawn by each wall tool is specified in its corresponding defaults dialog.

The **Curved Wall** tools are similar to their corresponding **Straight Wall Tools**. Select **Build> Wall** to access these tools as well.

Exterior Walls



The **Exterior Wall** and **Curved Exterior Wall** tools draw walls using the default wall type specified for exterior walls in the **Exterior/Interior Wall Defaults** dialog. See “Exterior and Interior Walls” on page 112.

Interior Walls



The **Interior Wall** and **Curved Interior Wall** tools draw walls using the wall type specified for interior walls. The interior wall type is defined in the **Exterior/Interior Wall Defaults** dialog.

Note: Whether a wall is recognized as an exterior or interior wall by the program is determined by its position in the model, not by the tool used to draw it. See “Exterior and Interior Walls” on page 112.

Glass Walls and Half-Walls



The **Straight Glass Wall** tool creates single-layer glass walls that do not cut the surfaces of the floor, ceiling, or adjacent walls.



The **Half-Wall** and **Curved Half-Wall** tools create solid railings: walls that are 36” (900 mm) high topped with a handrail.

Room Dividers



Room Dividers are Invisible walls with a thickness of 0” (mm) that are used to define separate room areas in a plan. They can display in plan view but not in 3D views. See “Room Dividers and Invisible Walls” on page 113.

Hatch Wall

 The **Hatch Wall** tool applies a hatch pattern to a wall that displays in plan views. You must click the wall that you want to apply the hatch pattern

to. You can then select the hatch and resize it if you want to only hatch a portion of a wall. See “Hatch Wall” on page 114.

Railing and Deck Tools

Railings are a special type of wall that have a specified height rather than building all the way to a room’s ceiling height.

 Select **Build> Railing and Deck** to access the Railing and Deck Tools. Railings are typically used to define interior spaces, while the various Deck tools are used to define exterior Deck rooms.

With the exception of the Polygon Shaped Deck tool, each of the tools in this family have both Straight and Curved versions, and are created and edited just like walls. See “Creating Walls” on page 114.

To create a break in a railing for a stairway or other access, use a **Doorway** . This keeps the railing continuous and maintains room definition. See “Room Definition” on page 131.

When first drawn, railings are specified as **No Locate**, which prevents **Auto Exterior Dimensions**  from locating them. This attribute may also be helpful if you do not want a railing to divide an area into two separate rooms. See “General Panel” on page 125.

Railings

 The **Railing** and **Curved Railing** tools create railings that are primarily used to define interior spaces.

Railings are ideal for a number of tasks:

- Creating changes in floor and/or ceiling height. See “Floor and Ceiling Heights” on page 138.
- Creating stairwells. See “Creating a Stairwell” on page 243.



Deck Railing

 The **Straight Deck Railing** and **Curved Deck Railing** tools draw decks, complete with framing and bounded by a railing. If a foundation level exists, supports for the deck are also created. See “Decks” on page 138.

When a room is defined using deck railing, its **Room Type** is automatically set to “Deck”. See “Decks” on page 138.

Deck Edges

 The **Straight Deck Edge** and **Curved Deck Edge** draw decks complete with framing, but without a railing. No deck supports are created.

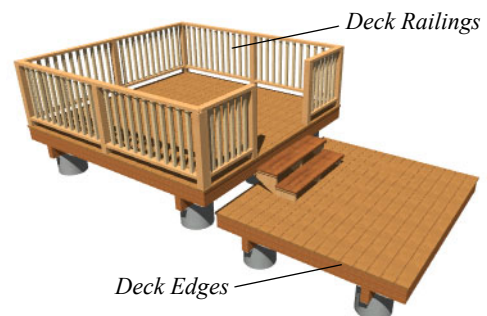

Polygon Shaped Deck

 The **Polygon Shaped Deck** tool opens the **New Polygon Shaped Deck** dialog, where you can specify the exact size and number of sides of a new polygonal deck room and then click in plan

view to create that deck room. See “Polygon Shaped Decks” on page 114.

Railing Types

A variety of railing types can be specified in the **Railing** and **Deck Railing Specification** dialogs. See “Rail Style Panel” on page 127. Available types include:

- **Baluster** creates railings composed of newel posts, balusters, a railing, and an optional bottom rail.
- **Solid** produces a framed railing wall, or Half Wall. See “Glass Walls and Half-Walls” on page 110.
- If **Panels** is selected, you can choose a panel style such as glass or ironwork from the library. See “Newels/Balusters Panel” on page 129.

Newels and balusters do not display in plan view.

Fencing Tools

Fencing is a special type of wall that is designed to follow the terrain rather than define a room with a flat floor platform.

 Select **Build> Fencing** or click the **Fencing Tools** to access the fencing tools. Fencing automatically follows the shape of the terrain.

 The **Fencing** and **Curved Fencing** tools are used to draw fences, which are similar to railings but by default do not define room areas. Fencing is created and edited much like walls and railings, and normally used outside of a building

and follows the shape of the terrain. See “Terrain” on page 349.

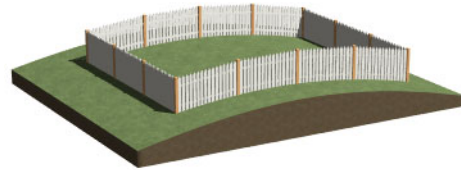

You can specify a fence panel style in the **Fencing Specification** dialog. See “Railing and Fencing Specification Dialogs” on page 127.

Exterior and Interior Walls

 Most walls are drawn using either the **Straight Exterior Wall** and **Straight Interior Wall** tools.

 Exterior and interior walls can also be drawn using the **Curved Exterior Wall** and **Curved Interior Wall** tools.

The only difference between the Exterior and Interior Wall Tools is the wall type used: Exterior Walls use a wall type set up to model a wall with siding, while Interior Walls model interior walls with sheetrock. See “Wall Type Definitions” on page 124.

You can specify the default wall type for each tool in the **Exterior/Interior Wall Defaults** dialog. See “Exterior and Interior Wall Defaults Dialogs” on page 110.

To draw a wall using a different wall type, you can change the default wall type for either tool in the **Exterior** and **Interior Wall Defaults** dialogs. You can also draw a wall using the default type and then change the wall type in the **Wall Specification** dialog. See “General Panel” on page 125.

Whether a wall is recognized by the program as an actual exterior or interior wall is based on its position in the model, not by which tool you used to draw the wall.

- Any wall or wall segment that is entirely surrounded by interior room areas is considered to be an interior wall.
- Any wall or wall segment that defines an exterior room or is exposed to the outside of the building is considered to be an exterior wall. See “Room Types” on page 132.

Foundation Walls

Foundation walls are similar to the interior and exterior walls but also have a footing. Foundation walls are created automatically when a foundation

floor is created. See “Building a Foundation” on page 222.

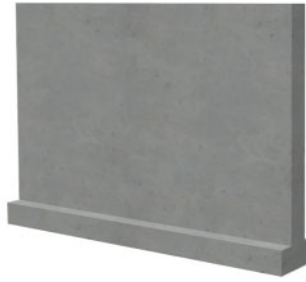

Brick Ledges

Brick ledges can be produced in monolithic slab and stem wall foundations. They do not extend under door openings in monolithic slab foundations.

Brick ledges are represented in plan view:

- In stem wall foundations, brick ledge lines are on the “Slabs” layer.
- In monolithic slab foundations, they are on the “Walls, Foundation” layer.

See “In Plan View” on page 117.

In order for a brick ledge to be produced, the foundation wall material directly under the brick ledge must be a concrete material and the wall material that drops into the brick ledge must be a masonry material such as brick.

Room Dividers and Invisible Walls

 The **Room Divider** tool is used to define separate room areas in a plan; typically, by dividing a large room area into two or more smaller areas. See “Room Definition” on page 131.

Common uses for Room Dividers  include dividing areas of an open floor plan into areas with different purposes.

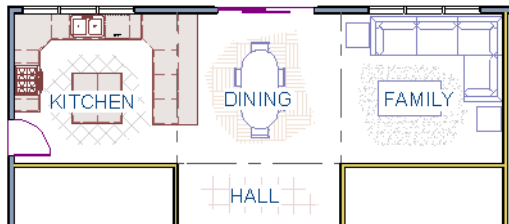

Room Dividers separate this dining area from adjacent rooms



Room Dividers can also be used to define areas with different floor or ceiling materials or heights.

Room Dividers  are simply walls that are specified as Invisible and have a single layer of an “Air Gap” material with a thickness of 0” (mm).

If a zero-thickness **Room Divider**  separates two rooms with different floor and/or ceiling heights, its wall type will be changed to the current plan’s default Interior Wall so that the platform step created by the height difference can be enclosed.

Invisible Walls

Any wall, regardless of its wall type or thickness, can also be specified as Invisible - or vice versa - in the **Wall Specification** dialog or by clicking the **Make**

Wall(s) Invisible  or **Make Wall(s) Visible**  edit button. See “General Panel” on page 125.

Room Dividers are placed on the “Walls, Invisible” layer by default, as are walls that are specified as Invisible.

Walls specified as Invisible can display in plan view but not in 3D views or the Materials List. See “Displaying Walls” on page 117.

It is not possible to place doors or windows into an Invisible wall; however, if a wall with openings in it is specified as Invisible, any openings in it will remain.

Important Notes on Invisible Walls

- Floor, wall and ceiling areas are calculated separately for rooms divided by Invisible walls.
- Invisible walls are ignored by the **Auto Place Outlets**  tool; it functions as though they were not present.
- Cabinets, fixtures and furniture can be moved freely through Invisible walls.
- Invisible walls can be drawn through a cabinet to attach to the wall behind.
- Room Dividers are automatically generated to connect “island” rooms to the larger structure around them. See “Room Definition” on page 131.

Polygon Shaped Decks

 Select **Build > Railing and Deck > Polygon Shaped Deck** to open the **New Polygon Shaped Deck** dialog and create a polygon shaped deck with regular sides.

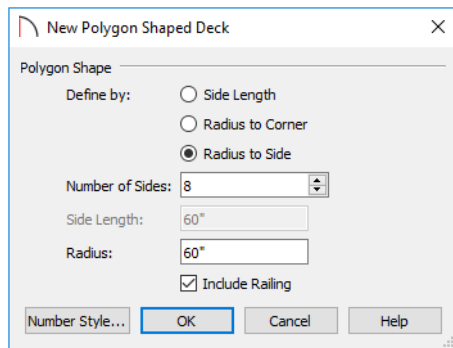

The settings in this dialog are saved between program sessions.

Hatch Wall

 The **Hatch Wall** tool can be used to fill wall segments with a single hatch pattern in plan view.

To apply wall hatching, select **Build > Wall > Hatch Wall**, then click on a wall. The hatch pattern covers the entire length and width of the wall segment.

Note: The Hatch Wall tool cannot be used to apply a hatch pattern to Invisible Walls. See “Room Dividers and Invisible Walls” on page 113.

Hatch Wall places a hatch pattern across all layers of the selected wall layers, covering any fill styles specified for that wall type.

Once created, wall hatching can be selected, edited and deleted much like other line-based objects. See “Editing Line-Based Objects” on page 82.

Creating Walls

Walls, railings, and fencing are drawn similar to the way CAD lines are drawn: select a Wall Tool and then click and drag from end to end in the drawing area. Walls can be drawn in plan view, camera views, and overviews. See “Draw Lines” on page 101.

There are several other ways that walls can be created in Home Designer Suite:

To create a polygon shaped deck

1. Click the radio button beside an option to specify whether you want to **Define Polygon by Side Length, Radius to Corner** or **Radius to Side**.
2. Specify the desired **Number of Sides**.
3. Specify the desired **Side Length** or,
4. Specify the desired **Radius**.
5. Uncheck **Include Railing** to produce a deck platform defined by Deck Edges. This option is not available in the **New Polygon Shaped Room** dialog.
6. Click **OK**, then click once in plan view to create the specified polygon shaped deck.

If you use the **Hatch Wall** tool to apply a hatch pattern to a wall that has been divided into multiple segments using the **Break** edit tool, the pattern is only applied to the segment that you clicked on. See “Break” on page 95.

Like doors and windows, wall hatching cannot extend across multiple wall segments. Unlike these objects, hatching cannot be located by dimension lines.

The wall hatch pattern can be specified in the **Wall Hatch Specification** dialog. See “Wall Hatch Specification Dialog” on page 130.



When editing or deleting wall hatching, make sure that it is selected rather than the wall by noting that “Wall Hatching” displays in the Status Bar. See “The Status Bar” on page 26.

- Exterior walls can be generated automatically when a new floor is built by using another floor as a model. See “Adding Floors” on page 228.
- Foundation walls are created when a foundation is automatically generated on Floor 0. See “Foundations” on page 221.

- Attic walls are generated automatically when the program perceives a gap between a wall that defines a room and the roof above. See “Attic Walls” on page 123.
- The **Space Planning Assistant** creates room boxes which can be arranged and then converted into walls. See “Space Planning” on page 41.



Drawing Walls

Drawing walls to create a floor plan is simple if you keep a few things in mind:

- Draw exterior walls first to define the building’s footprint, then draw the interior walls after the perimeter is in place.
- It is easiest to draw walls at the approximate location and length needed and then move or resize them precisely using dimensions later. See “Moving Objects Using Dimensions” on page 154.
- When drawing and positioning exterior walls, make sure **Grid Snaps**  are enabled. Once these walls are in place, you may prefer to turn Grid Snaps off to draw and position interior walls and other objects. See “Grid Snaps” on page 68.
- As walls are drawn, “sticky” points identify points that are either collinear or orthogonal to the end points of other walls, making alignment easier. See “Extension Snaps” on page 68.
- When walls enclose an area to form a room, the program will orient all exterior walls so that the siding material faces outward.
- To flip the layers of a wall after it is drawn, select it and click the **Reverse Layers**  edit button. See “Editing Walls” on page 119.
- Initial wall heights are determined by the default floor and ceiling heights of the current floor.

Wall Angles

With very few exceptions, walls should be drawn and edited with **Angle Snaps**  enabled. Walls that are drawn at irregular angles can result in wall connection, alignment, and room definition problems.

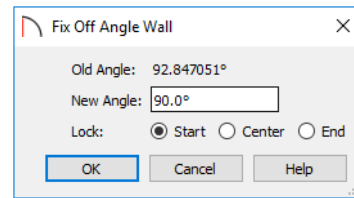

If a wall is drawn at an off angle, the **Off Angle Wall**  icon will follow the mouse pointer and a Caution  symbol will display over the problem wall in plan view.

To correct the wall’s angle, click on the Caution  symbol that displays over the wall and select **Fix Off Angle Wall** from the contextual menu. In the **Fix Off Angle Wall** dialog:



- The **Old Angle** is stated for reference.
- Enter a **New Angle** in the text field.
- Specify whether to **Lock** the **Start**, **Center**, or **End** point of the wall when its angle is changed.

There are several other ways to fix a selected wall if it has been drawn at an off angle:

- Click the **Open Object**  edit button and specify the correct angle. See “General Panel” on page 125.
- Click and drag an end edit handle until the wall snaps to an Allowed Angle. See “Angle Snaps” on page 68.
- If the wall in question should be aligned with a wall directly above or below it, click the **Align with Wall Above**  or **Align with Wall Below**  edit button. See “Aligning Walls” on page 121.

You can also suppress the Caution symbol by specifying the needed angle in the wall’s specification dialog.

Although not recommended unless the walls in question are Fencing, Terrain Walls, and/or Retaining Walls, you can choose to **Ignore Off Angle Wall** or **Ignore All Off Angle Walls** by clicking on the Caution  symbol that displays over an off angle wall. See “Fencing Tools” on page 112 and “Terrain Wall and Curb Tools” on page 355.

Wall Positioning

The recommended method of drawing walls is to draw them at their approximate location and length, then move them into position with accuracy using dimensions. To make this task quick and efficient:

- Notice the temporary wall that displays as you draw. Its length and angle display in the Status Bar at the bottom of the window and adjust as you

move the mouse. Release the mouse button to draw the wall at the displayed length and angle. See “The Status Bar” on page 26.

- Use Snaps to help ensure proper wall alignment and orientation. See “Snap Behaviors” on page 67.

Once walls are drawn, they can be accurately dimensioned and moved as needed. See “Measuring Walls” on page 118.

Wall Openings

To create a door or doorway, do not draw wall sections with a gap between them. Walls should be drawn to completely enclose rooms, and then door and window objects should be placed in the walls to create openings later. See “Doors” on page 169 and “Windows” on page 183.

Temporary Dimensions

Temporary dimensions will display along the length of a wall as it is drawn, helping you draw walls to the desired length. Although dimensions display as you

Connecting Walls

When walls are drawn sufficiently close to one another, they will snap together to form an intersection. This snapping occurs when the walls’ center lines are within a distance defined by the larger of the two walls’ widths and will occur even when **Object Snaps** are turned off. See “Object Snaps” on page 68.

If the two walls in question have identical specifications and are collinear, they will merge to become a single wall. See “Aligning Collinear Walls” on page 121.

When three or more walls connect to form a completely enclosed area, that area defines a room. See “Rooms” on page 131.

When walls snap together to form an intersection and **Object Snaps** are enabled, the program joins them at their Main Layers. See “Aligning Walls” on page 121.

- The wall that is being drawn or edited will move, lengthen, or shorten slightly to meet the other wall.
- The other wall will not move; however, its length may be affected.

are drawing, you do not need to position walls precisely when you first draw them: they can be easily moved into place at any time. See “Editing Walls” on page 119.

Drawing Curved Walls

Drawing a curved wall, curved railing, or curved fence is similar to drawing a CAD arc. See “Draw Arc” on page 101.



A straight wall can also be converted into a curved wall and vice versa using the **Change Line/Arc**  edit button. See “Change Line/Arc” on page 96.

 To create a room in the shape of a circle, you must draw two curved walls.

Space Planning Assistant

 The **Space Planning Assistant Tools** allow you to place and arrange room boxes that can then be converted into a fully editable house plan, including walls. See “Space Planning” on page 41.

Fix Wall Connections

Occasionally, intersecting walls may not properly connect. When this is the case and the connection in question is on the current floor, a Caution  symbol will display at the problem location in plan view and the Connect Walls  icon will follow your mouse pointer.

Click on the Caution  symbol that displays over the wall to open a contextual menu:

- Select **Delete** to delete the wall.
- Select **Ignore Unconnected Wall** to leave the wall unchanged and suppress the Caution symbol.

Removing Wall Breaks

The **Break**  edit tool allows you to break a wall into two or more separate wall segments. See “Break” on page 95.

To merge two collinear walls separated by a break, select one of the segments, then click on the end edit handle located at the break and drag it a few plan inches (mm) away from the break.

If the two walls do not merge, either one or both walls have been moved and they are no longer collinear, or one or both has been edited in some way and they are no longer identical. Open the **Wall**

Specification dialog for each wall and determine how they differ. See “Wall Hatch Specification Dialog” on page 130.

Displaying Walls

 The display of walls in all views is controlled in the **Display Options** dialog. See “Layer Attributes” on page 74.

If a “Walls” layer is turned off in plan view, any doors and windows placed in walls on that layer will not display, either. See “Displaying Doors” on page 171 and “Displaying Windows” on page 186.

In Plan View

There are several options for controlling how walls are displayed in plan view. In the **Display Options** dialog, you can specify whether or not various types of walls display. Walls are placed on layers with “Walls” at the beginning of the layer name, such as “Walls, Normal”.



Note: In plan view, railings not specified as Solid display their Main Layer regardless of whether “Walls, Layers” or “Walls, Main Layer Only” is turned on.

Foundation Walls have footings that display in plan view as long as the “Footings” layer is turned on. Brick ledge lines can also display. See “Displaying Foundations” on page 222.

It is sometimes helpful to display the walls from a floor other than the current floor. To do this, select and display a reference floor. See “The Reference Floor” on page 231.

Notification Icons

Occasionally, the program may detect a problem with one or more walls in a plan. When this is the case, notification icons will display on the floor where the problem has occurred:

- If a wall is drawn at an off angle, the **Off Angle Wall**  icon will follow the mouse pointer and a Caution  symbol will display over the problem wall in plan view.
- If there is a problem with a wall connection, the **Connect Walls**  icon will follow the mouse

pointer and a Caution  symbol will display at the problem location.

The recommended response to either situation is to fix the problem, although you can choose to ignore it if you prefer. See “Wall Angles” on page 115 and “Fix Wall Connections” on page 116.

If an issue has been ignored, notification icons for it will not display. Select **Tools> Checks> Reset Notification Icons** to display any suppressed notifications so that any wall angle or connection problems can be corrected.

In 3D Views

As in plan view, the display of walls can be controlled by layer in the **Display Options** dialog.

When a camera is located on the exterior of a structure, you can select **3D> Camera View Options> Hide Camera-Facing Exterior Walls**

, allowing the interior to be seen as you rotate around the model. Interior walls set as Attic walls are also hidden when this setting is active.

While most architectural objects in the program can display in both floor plan and 3D views, a few cannot. Invisible walls and Wall Hatching are examples of objects that do not display in 3D.

Unlike in plan view, doors and windows placed in a wall can display in 3D views even if the wall’s layer is turned off..

Wall Materials

There are several ways that materials can be assigned to walls. See “Rooms” on page 131.

When you draw a wall, it uses the materials specified in its wall type definition. See “Wall Type Definitions” on page 124.

You can change the surface material of an individual wall in the **Wall Specification** dialog. If you select “Use Default” as the material and the wall is used to define a room, the program refers to the material specified in the **Room Specification** dialog. See “Wall Specification Dialog” on page 124.

You can also change a room's wall material in the **Room Specification** dialog. See "Materials Panel" on page 296. To restore the default Wall Type material, select **Use Default** in the **Select Material** dialog. See "Select Material Dialog" on page 297.

Wall materials can also be changed using the **Material Painter**  tool, but bear in mind that depending on which Material Painter Mode is in use, only a portion of the wall may be painted and that the entire room may be affected rather than the individual wall. See "Material Painter and Walls" on page 296.

Note: Wall materials that are specified on the Materials panel of either the Wall or Room Specification dialog are not calculated in the Materials List.

In the Materials List

The materials that make up wall assemblies are listed under different Categories in the Materials List:

- **Siding** - Lists all materials located outside of each wall's Main Layer, such as siding, sheathing, and housewrap.
- **Framing** - Lists the Main Layer material for all walls as well as railings specified as Solid. Non-framed walls' Main Layer materials are also listed

Measuring Walls

Accurate wall measurements are an essential aspect of any drawing, and can be achieved by following two basic rules:

- Be aware of what part of a wall assembly dimensions are locating;
- Position walls using dimensions rather than edit handles or edit tools.

These rules can easily be met when you keep the following recommendations in mind.

For information about changing the value reported in a dimension line label, see "Using Dimensions" on page 120.

Use Dimension Defaults

Dimensions can be set to locate walls at their Dimension Layers or at their surfaces. Before drawing dimensions - and particularly, before using them to move your walls into position - make sure

here when those walls are not specified as Foundation.

- **Insulation** - Insulation is calculated for all exterior walls that are not defined as Railings, and have one Framing layers. Insulation thickness is equal to that of the framing layer. See "Exterior and Interior Walls" on page 112.
 - **Wallboard** - Lists all materials located inside of each wall's Main Layer, such as drywall. Includes all materials aside from framing, concrete, and rebar in walls that do not define rooms.
- Does not include materials specified in either the **Room** or **Wall Specification** dialog. See "Materials Panel" on page 127.
- **Interior Trim** - Lists base, crown and chair rail moldings
 - **Foundation** - Lists the concrete for all walls specified as Foundation as well as their footings. See "Foundation Walls" on page 112.

With the exception of wallboard, windows and doors are taken into account in the calculation of these totals.

Additional wall-related information is listed in the **General** category, including the total linear feet of each wall type per floor and the thermal envelope wall area per floor. See "Conditioned Area" on page 382.

that your Dimension Defaults are set up to meet your needs. See "Dimension Defaults Dialog" on page 147.

If a wall is specified as Invisible, dimensions will locate it at its centerline regardless of your Dimension Defaults settings. If the Invisible wall divides rooms with different floor heights, dimensions will locate the edge of the wall facing the room where the floor is lower.

Edit Dimension Lines

Once a dimension line has been drawn, its extension lines can be edited to locate a number of locations on a wall assembly:

- The exterior surface
- The Main Layer's exterior
- The center line of the wall assembly
- The Main Layer's center line

- The Main Layer's interior
- The interior surface

See “Editing Extension Lines” on page 152.

Moving Walls Using Dimensions

By far, the most precise method of positioning walls is using dimension lines. To produce accurate measurements, remember to:

- Be aware of what part of your walls is being located by dimensions.
- Avoid specifying dimension values with greater accuracy than your dimensions are set to display. See “Format Panel” on page 148.

See “Using Dimensions” on page 120.

Use Object, Angle and Grid Snaps

Object Snaps, Angle Snaps, and Grid Snaps make it easier to align walls when they are being drawn as well as when they are edited. See “Snap Behaviors” on page 67.

Object Snaps help to ensure consistent wall connections and are particularly helpful when aligning collinear walls.

When **Grid Snaps** are enabled, walls are drawn on a regularly spaced grid, which helps avoid inaccurate wall placement. This can become particularly

important if you forego positioning walls using dimensions in favor of using edit handles to move them.



Using Grid Snaps is recommended when you are laying out exterior shell walls, but may be inconvenient when positioning interior walls or other objects.

Angle Snaps make it easy to accurately draw walls at regular angles, ensuring walls that are truly parallel or perpendicular to one another and separated by consistent distances.

No Locate

If a wall is specified as **No Locate** in the **Wall Specification** dialog, it will be ignored by **Auto**

Exterior Dimensions  in plan view, as will any doors or windows placed in it. See “Dimensions” on page 147.

By default, **Railings**, **Deck Railings**, and **Room Dividers** are specified as No Locate. See “General Panel” on page 125.

Once a dimension line has been created, it can be edited so that it locates a No Locate wall or railing that is perpendicular to it. See [Editing Dimension Lines](#).



Editing Walls

Walls can be selected in all views. When a wall is selected, it displays edit handles and an edit toolbar that can be used to modify it in various ways. When a wall is selected, temporary dimensions will also display.

The ways in which a wall can be edited depend on the current view and which edge is selected. See “Selecting Objects” on page 79.

Selecting Walls

Like other objects, walls can be selected in a variety of ways. See “Selecting Objects” on page 79.

In plan view, if wall hatching has been applied to a wall using the **Hatch Wall**  tool, the hatching may be selected first. Click **Select Next Object**  to select the wall itself. See “Hatch Wall” on page 114.

Using the Edit Handles

A selected wall can be modified in a variety of ways using its edit handles in any view. The handles that are available will depend on the current view type.

- In plan view, straight and curved walls can be edited like other line- and arc-based objects. See “Editing Line-Based Objects” on page 82 and “Editing Arc-Based Objects” on page 83.
- In a camera view or overview, click on the top surface of a wall to display the same edit handles as in plan view, allowing you to rotate, move, and extend or shorten the length of the wall.
- Moving a wall in any view will move any cabinets attached to that wall, as well.
- In an Elevation view, the side edges of straight walls can be moved to shorten or lengthen the segment. Curved walls can be shortened in this manner, but not lengthened.

- In a camera view or overview, click on an interior or exterior surface to display an edit handle at the center of each side edge, allowing you to shorten or lengthen the wall. Curved walls can be shortened in this manner, but not lengthened.
- When a wall is connected to other walls, it can only be moved perpendicular to itself or, in the case of curved walls, perpendicular to its chord, using the Move edit handle.

In the Specification Dialog



The appearance and structure of walls can be customized in the **Wall Specification** dialog. See “Wall Specification Dialog” on page 124.

The characteristics of the roof directly above a selected wall can also be specified in the **Wall Specification** dialog. See “Roof Panel” on page 126.

Using the Edit Tools







A selected wall or walls can be edited in a variety of ways using the buttons on the edit toolbar. See “The Edit Toolbar” on page 23.

Using Dimensions



Automatic, manually-drawn, and temporary dimension lines can be used to both resize and move walls with accuracy. Select a wall, then click on a dimension line that locates it and type in the value that you need. See “Moving Objects Using Dimensions” on page 154.

When a wall is resized using dimensions, the inline text field used to edit the dimension will have three unique buttons:

- Horizontal walls have **Move Left End** , **Move Both Ends** , and **Move Right End** .
- Vertical walls have **Move Top End** , **Move Both Ends** , and **Move Bottom End** .

Choose the option that you want to use before pressing the Enter key.

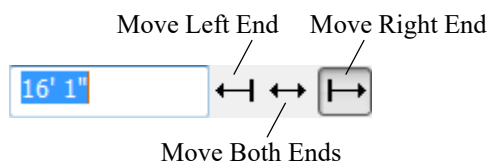

If both ends of the selected wall intersect walls that are not parallel to one another, a fourth option will be

available: **Move Along Rails** . When this option is used, the selected wall both resizes and changes position so that it remains connected to the other walls when you press the Enter key.

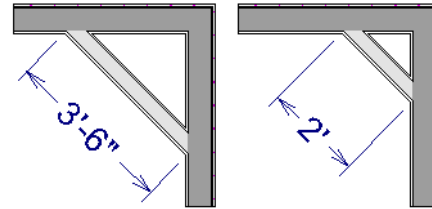

Move Along Rails resizes and moves a selected wall.

Depending on your **Dimension Defaults** settings, dimension lines may locate wall surfaces or Main Layers. See “Dimension Defaults Dialog” on page 147.

Wall Thickness

The initial thickness of a wall is determined by its wall type.

You can specify a selected wall’s thickness in its **Wall Specification** dialog. See “General Panel” on page 125.

If a selected wall’s thickness is changed:

- A copy of the wall’s wall type is created with the same name but appended with a number equal to the thickness of the structural layer, and that new type is assigned to the wall.
- The change in thickness will be applied to new wall type’s structural layer.
- The structural layer must be at least 1/16” thick, and the wall’s thickness cannot be less than the original wall type’s total thickness minus the thickness of its structural layer.

If a wall type’s thickness is modified, the wall will resize about the outside edge of its structural Layer. In some instances, the wall may appear to move as a result of changes made to the thicknesses of its layers.

Wall Heights

The height of a wall is controlled by the ceiling height of the room(s) it defines. If the ceiling or floor height of a room is changed, the height of the walls that define it also change.

- The initial ceiling height for all rooms on a floor is set in the **Floor Defaults** dialog for that floor.

See “Floor Level Defaults” on page 132. Whenever possible, it is best to set all ceiling heights using the default.

- The ceiling height of a single room can be set in its **Room Specification** dialog. See “General Panel” on page 142.

Wall Length

Wall length can be modified in several different ways:

- Using dimensions. See “Measuring Walls” on page 118.
- In the **Wall Specification** dialog. See “General Panel” on page 125.
- Using the **Break**  edit tool to divide a selected wall into two segments. See “Break” on page 95.

- By dragging the end edit handles. See “Editing Line-Based Objects” on page 82 and “Editing Arc-Based Objects” on page 83.

Bear in mind that if you try to resize a wall by a small amount using one of its edit handles and that wall is connected to another wall at that end, its length will not change because its end will snap back to the existing intersection. See “Connecting Walls” on page 116.

The most accurate way to specify wall length is using dimensions. By default, wall length is measured at the outside edge of the Main Layer. You can instead specify that dimension lines locate surfaces in the **Dimension Defaults** dialog. See “Dimension Defaults Dialog” on page 147.

Editing Straight/Curved Wall Combinations

If you move a straight wall connected to a curved wall with a locked center, the curved wall extends along its curve and the straight wall will either lengthen or shorten as needed to stay connected to the curved wall.

If the connection between the straight and curved wall cannot be maintained because of the curved wall’s radius, it will be broken.

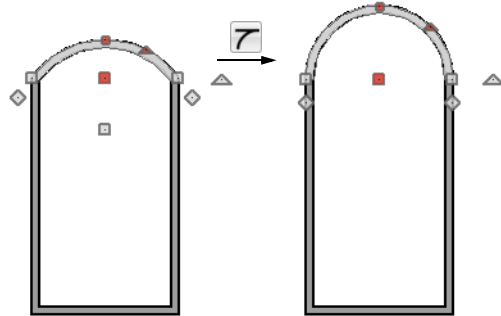
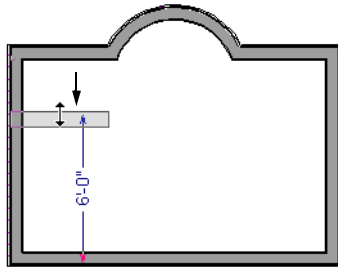

Aligning Walls

Wall alignment refers to the way wall segments line up with one another, either on the same floor or on the floor above or below. Walls may need to be aligned in a variety of situations.

To make alignment easier when drawing or resizing walls, “sticky” points identify points that are either collinear or orthogonal to the end points of other walls. See “Extension Snaps” on page 68.

Aligning Collinear Walls

Collinear walls are parallel walls connected end to end and drawn on the same floor. When collinear walls join end-to-end, the walls snap together. If these walls have the same wall type and identical specifications, and if **Object Snaps** are enabled, they will merge to become a single wall segment.

Creating a Nook

Walls can be aligned across an opening such as a nook, so that they are collinear, using the **Break**  edit tool.

To align walls across a gap

1. Select a wall to build a nook into and click the **Break**  edit button.
2. Click at a point on the wall close to one side of the nook area. Do not worry about exact placement right now.
3. Click again near the other side of the nook. Two short lines at each location where you clicked indicate Breaks in the walls.

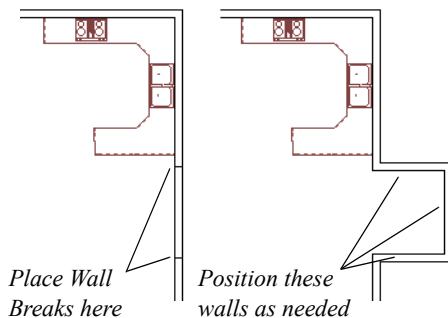

4. Right-click the middle section of the wall to select the wall section.
5. Click the middle Move handle and drag the wall outward.
6. Draw side walls to connect the wall back to the rest of the house.
7. Move these short walls using dimensions to accurately size the nook.



Roof Directives in Walls

To automatically generate a roof plane using values other than the defaults or to not generate a roof plane bearing on a particular wall (as for a gable or the sides of a shed roof), you can change the settings in the **Wall Specification** dialog. See “Roof Panel” on page 126.

Hip, Gable, and Shed Roofs

By default, the program will produce a roof plane over each exterior wall to create a hip roof. You can



Aligning Walls Between Floors

Walls can be aligned between floors by clicking the **Align With Wall Above**  and **Align With Wall Below**  edit buttons.





In order for these edit tools to be available, the areas of the walls in question must be partially aligned, or overlapping.



To align walls between floors

1. Select a wall that you want to align with another wall either above or below it.
2. If the wall is above or below the other wall along only part of its length, you must click on it along that part. Select **Tools> Floor/Reference Display> Reference Display On**  to help make sure you click on the correct part of the wall.
3. When you have selected the wall at the desired location, click either the **Align With Wall Above**  or **Align With Wall Below**  edit button.

Aligning Curved Walls Between Floors

Curved walls are aligned between floors using the same technique to align straight walls. If the centers and radii of the walls are within a few inches of each other, the **Align With Wall Above**  and **Align With Wall Below**  edit buttons are enabled for the selected wall. The selected curved wall will take on the radius and center of the referenced wall when the walls are aligned.

instead specify a gable or shed roof above the selected wall.

- Check **Full Gable Wall** to create a gable with a ridge centered above the selected wall(s).
- Check **High Shed/Gable Wall** for the side walls or the wall under the high side of a shed roof.
- You can also select a wall and click the **Change to Gable Wall(s)**  edit button, or change it back by clicking the **Change to Hip Wall(s)**  edit button.

Pitch

The default pitch for roof planes is set in the **Build Roof** dialog. However, any exterior wall can define the pitch of the roof plane built above it.

You can also specify a second, upper pitch above a given wall. Mansard, gambrel, gull wing and half-hip are examples of roof styles that use two pitches. See “Roof Tutorial” on page 43 of the User’s Guide.

Roof Returns

Check **Auto Roof Return** to generate roof returns on the selected wall. In most cases, roof returns only

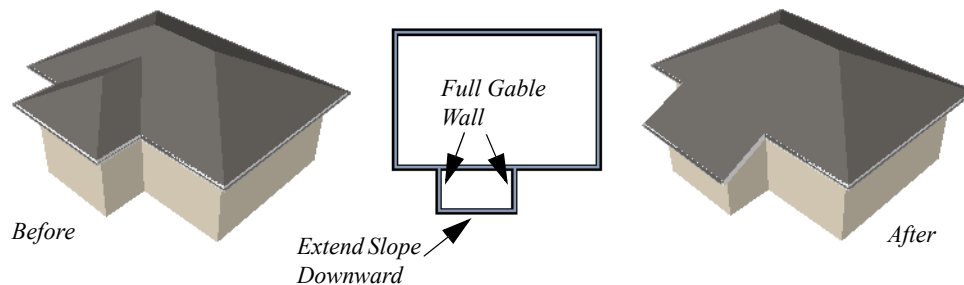

generate on Full Gable Walls. See “Roof Returns” on page 263.

Extend Slope Downward

Check **Extend Slope Downward** to extend the roof plane downward over a bump out, instead of creating additional roof planes. The two connecting walls that create the bump out must be Full Gable walls.

In the following image, the bearing wall of the bump out has **Extend Slope Downward** checked. The two short side walls are **Full Gable Walls**.

Attic Walls

In Home Designer Suite, walls are built between the floor and ceiling platforms of the current floor. See “Floor and Ceiling Heights” on page 138. When the program detects an open space between a wall and the roof plane above it, it automatically creates an Attic Wall on the floor above that wall to fill in the gap.

Attic Walls are typically found above Full Gable Walls, forming a gable or closing the top portion of a side wall of a shed roof. Attic Walls are often found on the Attic floor, but can be generated on other floors, as well. See “The Attic Floor” on page 231.



If you do not want to keep a particular Attic Wall in your plan, specify it as Invisible. See “Room Dividers and Invisible Walls” on page 113.

Removing Attic Walls

Occasionally, the program will generate an Attic Wall where one is not wanted. There are several ways to address this:

- Turn off the display of the “Walls, Attic” layer.
- Specify the Attic Wall as **Invisible**. See “Room Dividers and Invisible Walls” on page 113.

- Some interior Attic Walls can be suppressed by specifying space they enclose as a **Shelf Ceiling**. See “Shelf Ceilings” on page 139.
- Select the Attic Wall and **Delete** it. The program will specify the wall as Invisible automatically. If you delete this Invisible wall, a new Attic Wall will be created.

Knee Walls

Knee Walls are a bit like Attic Walls in that they are not meant to generate to full ceiling height. Instead, they build upward until they encounter a roof plane. Unlike Attic Walls, however, Knee Walls are used in the interior of a structure, typically to separate unused areas from rooms on the upper floor of a story-and-a-half structure. See “Room Types” on page 132.

Home Designer Suite does not specify walls as Knee Walls automatically. If an interior wall is drawn in a location where the roof is lower than the ceiling height, you should specify it as a Knee Wall in the **Wall Specification** dialog. See “Roof Panel” on page 126.

For best results, Knee Walls should be drawn perpendicular to the pitch of the roof and should intersect with Full Gable Walls on each end.

Wall Type Definitions

Every wall drawn in a plan is assigned a wall type, and its Wall Type Definition determines its structure, its appearance in plan view, and its default materials.

You can specify the default wall type that is drawn by the Exterior and Interior Wall tools and can specify the wall type of any wall after it is drawn in the **Wall Specification** dialog. See “Wall Defaults” on page 109 and “General Panel” on page 125.

The structural layer of a wall type is its Main Layer, which controls a number of things:

- At intersections, walls join at the interior surfaces of their Main Layers. See “Connecting Walls” on page 116.
- Windows are placed relative to the outer surface of the Main Layer.
- Exterior walls on different floors are aligned by the exterior edges of their Main Layer.
- Roof baselines are placed at the outer edge of the Main Layer.
- Walls resize about the exterior surface of their Main Layer when their thickness or wall type is changed.

Wall Specification Dialog



To open the **Wall Specification** dialog, select a wall or group of walls and click the **Open Object** edit button.

- Object Snaps locate the interior and exterior edges of a wall’s Main Layer. See “Object Snaps” on page 68.
- By default, dimension lines locate walls at their Main Layer. See “Dimension Defaults Dialog” on page 147.

Interior and Exterior Surfaces

Every wall has an interior and exterior surface - including walls in a plan that are recognized by the program as being interior walls. See “Exterior and Interior Walls” on page 112.

Having separate designations for a wall’s two sides serves a couple of purposes:

- It allows the program to orient each wall’s exterior side toward the outside of a structure. See “Creating Walls” on page 114.
- It allows you to specify different materials for each side’s surface in the **Wall Specification** dialog. See “Materials Panel” on page 127.

In plan view, you can identify a selected wall’s exterior surface by the location of its edit handles, which display on the exterior of the Main Layer.

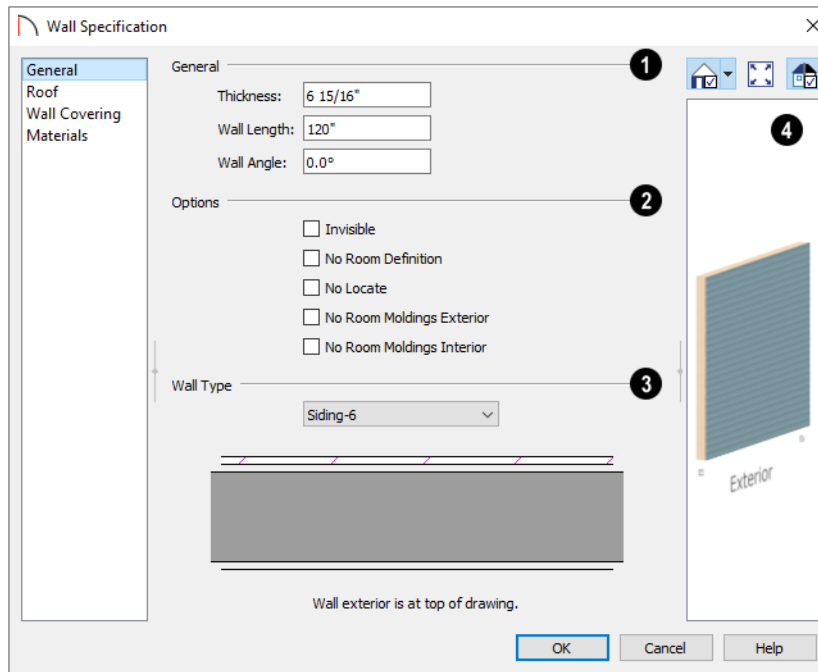

The panels of the **Wall Specification** dialog are also found in the **Railing**, **Deck Railing**, and **Fencing Specification** dialogs. See “Railing and Fencing Specification Dialogs” on page 127.

General Panel



- 1** Specify **General** properties of the selected wall or railing.

 - The **Thickness** of the selected wall displays and can be changed here. If the wall is a Post to Overhead Beam railing, this setting also affects the width of the beam. See “Wall Thickness” on page 120.
 - **Wall Angle** - The current absolute angle of the wall in plan view is shown. If you type in a new angle, any walls attached to it will not move. If the selected wall is curved, this value describes the angle of the chord and cannot be modified.
 - **Wall Length** - The current length is shown. If you type a new length, any walls attached to the selected wall will not move. If the selected wall is curved, this value cannot be modified.
- 2** Check any of the **Options** to modify the selected wall accordingly. In most cases, multiple options can be selected. Not available for fencing.

 - Check **Invisible** to specify the wall as invisible. Invisible walls can display in plan view but not in 3D views or the Materials List. **Room Dividers**  are invisible by default. See “Room Dividers and Invisible Walls” on page 113.
 - Check **No Room Definition** to display the wall in floor plan and/or 3D views but not create room definition. See “Room Definition” on page 131.
 - Check **No Locate** to prevent **Auto Exterior Dimensions**  from locating the wall in plan view. See “No Locate” on page 119.
 - Check **No Room Moldings Exterior** to prevent any room moldings from generating along the Exterior side of the selected wall. See “Room Moldings” on page 141.
 - Check **No Room Moldings Interior** to prevent any room moldings from generating along the Interior side of the selected wall.
- 3** Select the **Wall Type** assigned to the selected wall from the drop-down list. A preview diagram of the selected wall type’s layers, as seen in plan view, displays below.
- 4** A preview of the selected wall, including any doors or windows inserted into it, displays on the right. If the selected wall is specified as Invisible, its plan view will display here by default. See “Dialog Preview Panes” on page 25.

Roof Panel

Any automatically generated roof style other than a hip requires roof information to be defined in the exterior walls. On the ROOF panel, you can specify how the selected wall interacts with the roof plan, defining the portion of the roof plan that bears on it..

The ROOF panel is not available for Foundation Walls or Fencing. See “Foundation Walls” on page 112 and “Fencing Tools” on page 112.

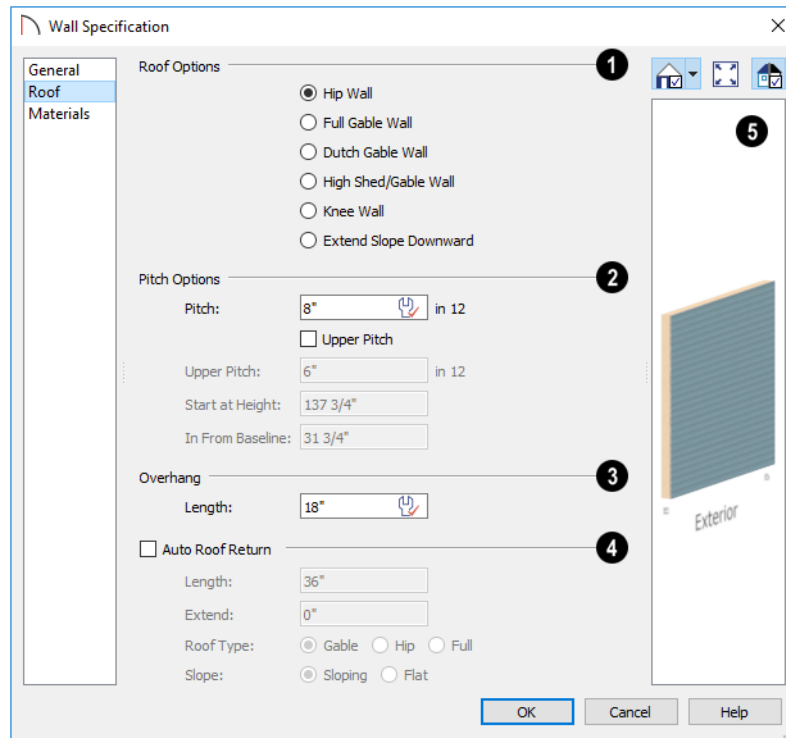

- 1 **Roof Options** - Specify the shape of the wall relative to the roof.
 - Check **Full Gable Wall** to create a gable end over the selected wall.
 - Check **Dutch Gable Wall** to create a small gable part way up a hip roof. Use the Pitch Options below to specify the location of the gable.
 - Check **High Shed/Gable Wall** to specify the selected wall as the high end of a shed roof.
 - Check **Knee Wall** to define the selected interior wall as a knee wall. Only an interior wall can be defined as a knee wall. A knee wall’s height is defined by the roof above, not the ceiling height. See “Knee Walls” on page 123.
 - Check **Extend Slope Downward** to continue a roof down over a bump out in an exterior wall. See “Extend Slope Downward” on page 123.
- 2 **Pitch Options** - Specify the pitch or pitches of the roof plane(s) above the selected wall.
 - Enter a value to define the **Pitch** of the roof plane bearing on the selected wall.
 - Check **Upper Pitch** to create a roof with two pitches or, if the selected wall is a Full Gable Wall, a half hip condition.
 - Enter the **Pitch** of the second, upper roof.
 - Specify the **Height** that the Upper Pitch **Starts at**, or define the distance **In from Baseline** that the second pitch begins. The two values are dynamic. Press the Tab key to update the relative numbers. These settings are also used to position a Dutch Gable Wall.
- 3 Specify the **Overhang Length**, which is the horizontal distance from the outside of the wall’s Main Layer to the eave. See “Wall Type Definitions” on page 124.
- 4 Check **Auto Roof Return** to generate roof returns on the selected wall. In most cases, roof returns only work for Full Gable Walls. See “Roof Returns” on page 263.

- Specify the horizontal **Length** of the roof return in inches (mm).
 - Enter a value in inches (mm) to **Extend** the roof returns past the overhang.
 - Specify a **Gable**, **Hip**, or **Full** roof return.
 - Specify a **Sloping** or **Flat** roof return.
- 5** A preview of the selected wall, including any doors or windows inserted into it, displays on the right. See “Dialog Preview Panes” on page 25.

 Additional information about using the settings on this panel can be found in the “Roof Tutorial” on page 43 of the Reference Manual.

Rail Style Panel

The RAIL STYLE panel is only available for Railings, Half Walls, Deck Railings, and Fencing. See “Rail Style Panel” on page 127.

Newels/Balusters Panel

The NEWELS/BALUSTERS panel is only available for Railings, Half Walls, Deck Railings, and Fencing. See “Newels/Balusters Panel” on page 129.

Rails Panel

The settings on the RAILS panel are used to specify the style and size of the horizontal components of a selected Railing, Deck Railing, or Fence. See “Railing and Deck Tools” on page 111.

A similar panel is also found in the **Staircase** and **Ramp Specification** dialogs and has additional settings for handrails at walls. See “Rails Panel” on page 250.

The settings on this panel are like those on the MOLDINGS panel found in a variety of dialogs in the program. See “Moldings Panel” on page 268.

Materials Panel

All walls - including interior walls, railings and fencing - have an “Exterior Wall Surface” and an “Interior Wall Surface”. See “Interior and Exterior Surfaces” on page 124.

The materials specified on the MATERIALS panel affect the appearance of walls and Solid Railings in 3D views but are not calculated in the Materials List. See “Materials Lists” on page 377.

For most railing types, the “Exterior Wall Surface” component only affects the appearance of the floor platform under the railing, and “Interior Wall Surface” component is not used. For fencing, neither material component is used.

Railing and Fencing Specification Dialogs



To open the **Railing** or **Fencing Specification** dialog, select a railing or fencing, or a group of railings or fencing, and click the **Open Object** edit button.

The **Railing** and **Fencing Specification** dialogs are the same as the **Wall Specification** dialog, but have three panels that apply only to Railings, Half Walls,

Deck Railings, and Fencing. See “Wall Specification Dialog” on page 124.

The RAILS panel is similar to the HANDRAIL panel found in the **Staircase** and **Ramp Specification** dialogs. See “Stairs, Ramps, and Landings” on page 233.

Rail Style Panel

The RAIL STYLE panel is only available for Railings, Deck Railings, and Fencing. See “Railing and Deck

Tools” on page 111, “Fencing Tools” on page 112, and “Fencing Tools” on page 112.

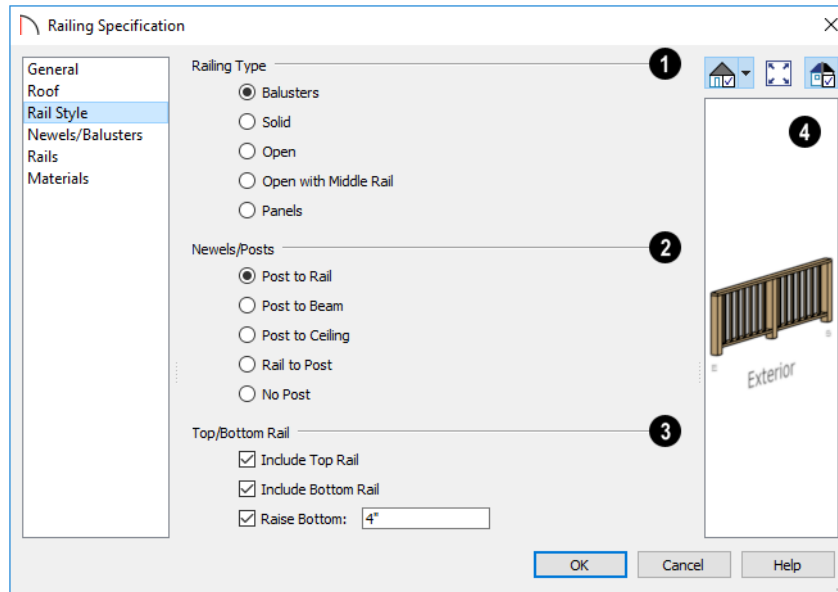

- 1 Railing Type** - Select the radio button for the desired railing type:

 - Select **Balusters** to create regularly spaced balusters between larger newel posts.
 - Select **Solid** to create a solid railing or Half Wall.
 - Select **Open** to create a railing with only newel posts and top and bottom rails.
 - Select **Open with Middle Rail** to create a railing with newel posts and top, bottom, and middle rails.
 - Select **Panels** to create a railing composed of panels.
- 2** Check **Newels/Posts** to assign these to the selected railing, then specify their properties.

 - Select **Post to Rail** to create newel posts from the floor to the top rail. This option is selected by default.
 - Select **Post to Beam** to create newel posts from floor to a beam placed just under the ceiling height. The beam's width is based on the Thickness of the selected railing wall.
 - Select **Post to Ceiling** to extend the newel posts to the ceiling.
 - Select **Rail to Post** to produce newel posts of the Height specified on the NEWELS/BALUSTERS panel, with rails that build to the sides of the newels.
- 3** The **Top/Bottom Rail** options control the placement of the top and bottom rail, or shoe.

 - Uncheck **Include Top Rail** to eliminate the top rail.
 - Uncheck **Include Bottom Rail** to eliminate the bottom rail and extend the balusters to the floor. Not available for Solid railings.
 - Check **Raise Bottom**, then specify the **Floor to Bottom** distance, measured up from the floor platform to the bottom rail or panel.
- 4** A preview of the selected railing or fence, including any doorways or gates inserted into it, displays on the right. See "Dialog Preview Panes" on page 25.

Newels/Balusters Panel

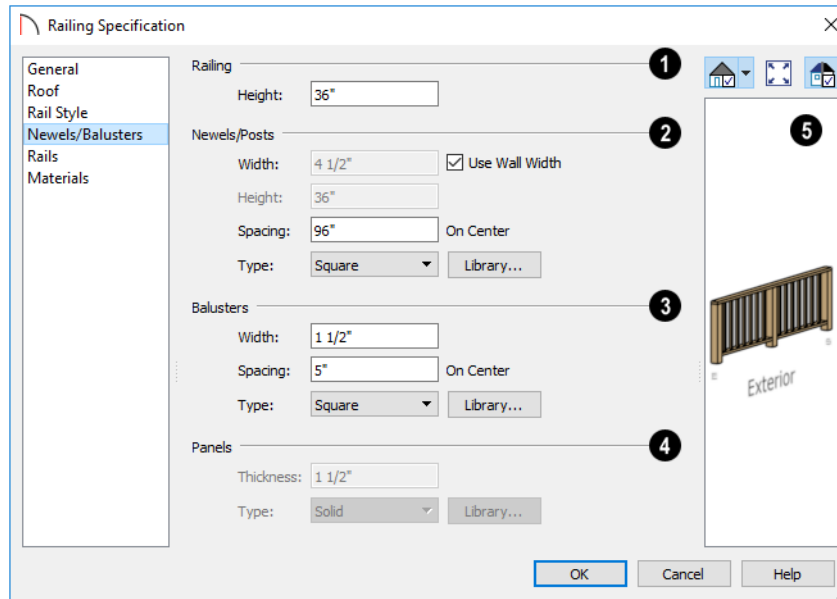

- 1 Specify the height of the **Railing**.
 - Specify the **Railing Height**. For interior railings, this is measured from the height of the floor finish.
- 2 Specify the characteristics of the selected railing's **Newels/Posts**.
 - When **Use Wall Width** is checked, the newels will be the same width as the wall type assigned to the selected railing. Uncheck this box to specify the **Width** of each newel at its widest point.
 - Specify the **Height**, which is the height from the floor or ground to the top of the newel. Not available if Post to Rail, Post to Overhead Beam or Post to Ceiling is selected on the RAIL STYLE panel.

- Specify the on-center **Spacing** of the newel posts.
- **Type** - Select Square, Round, or Library newels.

Note: Selecting Library from the drop-down list is the same as clicking the Library button to the immediate right and allows you to select a symbol from the library. See "Select Library Object Dialog" on page 283.

- 3 Specify the characteristics of the selected railing's **Balusters**. These settings are only available when the railing type is "Balusters".
 - Specify the **Width** or diameter of each baluster at its widest point.
 - Specify the on-center **Spacing** of the balusters.

- **Type** - Select Square, Round, or Library balusters.
- **4** Specify the characteristics of the selected railing's **Panels**. These settings are only available when the railing type is specified as Panels on the RAIL STYLE panel.
- Specify the panel's **Thickness**.
- Select "Solid" or "Library" from the **Panel Type** drop-down list.

 You can also apply newels, balusters, and panels onto a railing directly from the Library Browser. See "Inserted Objects" on page 282.

Wall Hatch Specification Dialog

 To open the **Wall Hatch Specification** dialog, select a Wall Hatch and click the **Open Object** edit button. See "Hatch Wall" on page 114.

The settings in the **Wall Hatch Specification** dialog are found on the FILL STYLE panel of the

- **5** A preview of the selected railing or fence, including any doorways or gates inserted into it, displays on the right. See "Dialog Preview Panes" on page 25.

Rails Panel

The settings on the RAILS panel are used to specify the style and size of the horizontal components of a selected Railing, Deck Railing, or Fence. See "Railing and Deck Tools" on page 111.

A similar panel is also found in the **Staircase** and **Ramp Specification** dialogs and has additional settings for handrails at walls. See "Rails Panel" on page 250.

The settings on this panel are like those on the MOLDINGS panel found in a variety of dialogs in the program. See "Moldings Panel" on page 268.

specification dialogs for many different objects. See "Fill Style Panel" on page 76.

Rooms

Rooms are created when walls are drawn to enclose an area. When a room is defined in this way, it automatically receives both a floor and ceiling as well as features like moldings and finish materials that can be seen in 3D Views.

Rooms can be selected and edited. Each room can be assigned a Room Type with predefined characteristics. For example, a room defined as a Deck is assigned certain attributes that are different than a Kitchen.

Room Definition

A room is a totally enclosed area defined by any combination of joined walls or railings, visible or invisible. To be recognized as a room by Home Designer Suite, a room must have an unbroken perimeter.

Unless otherwise specified, rooms generate floor and ceiling platforms automatically. Most rooms are also automatically covered by the roof when one is built. There are exceptions to this, such as rooms defined as Decks. See “Room Types” on page 132.

If a room is drawn within a larger structure and none of its walls connect to the exterior walls, either directly or indirectly by connecting to walls that do, it is referred to as an “island” room. The program will connect such a room to the larger structure with

Chapter Contents

- Room Definition
- Floor and Room Defaults
- Room Types
- Displaying Rooms
- Selecting Rooms
- Editing Rooms
- Room Types
- Room Labels
- Room Label Specification Dialog
- Decks
- Floor and Ceiling Heights
- Stepped Floor and Ceiling Platforms
- Special Ceilings
- Room Moldings
- Room Specification Dialog

an Invisible Wall. See “Room Dividers and Invisible Walls” on page 113.

Room definition disappears if part or all of a surrounding wall is deleted. It is a good idea to finalize the position of walls before specifying Room Types or defining room attributes such as floor or ceiling height.

Subdividing Rooms

When a room area is first defined, it inherits its characteristics from the **Floor Defaults** dialog for that floor. If the room is then specified as a particular type, it may inherit properties from the **Room Defaults** dialog associated with its type.

If a new room is created by subdividing a larger room, it inherits its characteristics from that larger room - including any non-default settings.

If two rooms are separated by an Invisible wall, their interior areas will be measured from the wall's centerline and characteristics like the floor finish materials and moldings will break along that line.

- If the two rooms have different floor heights, the break will occur at the wall edge that faces the room where the floor is lower.
- If the two rooms have different ceiling heights, the break will occur at the wall edge that faces the room where the ceiling is higher.

Floor and Room Defaults



Select **Edit > Default Settings** to open the **Default Settings** dialog, then click the arrow to the left of “Floors and Rooms” to expand the category. Here, you can access several defaults dialogs which directly affect rooms. Select a line item and click the **Edit** button to open the defaults dialog associated with it.

Floor Level Defaults

Many important default values that affect rooms are specified in the **Floor Defaults** dialog for each floor in a plan. This dialog controls important information that the program uses to create a 3D model - particularly floor and ceiling heights and materials. Moldings can also be specified in the **Floor Defaults** dialog.

Only the defaults for Floor 1 can be set ahead of time. The program uses the settings from Floor 1 to create subsequent floors. Once a new floor is created, its floor defaults can be changed. See “Floor Defaults Dialog” on page 227.

Floor 1 Default Height

Home Designer Suite always defines the default height of Floor 1 at 0'-0". This height value is measured from the top of the subfloor and is the constant by which the heights of structural elements

Room Types

Room Types are used to quickly apply useful structural, functional, and appearance properties to different kinds of rooms. For example, a room assigned the “Garage” Room Type will receive concrete curbs under its walls when the Foundation

Copying and Pasting Rooms

A room can be copied into the same or a different plan by copying and pasting the walls that define it. Rooms copied in this manner retain their size and shape, as well as any finish materials assigned to the walls. See “Copying and Pasting Objects” on page 70.

If you want to retain the room's Type and other specifications, copy and paste it and the walls that define it using the **Edit Area**  tools. See “Edit Area” on page 81.

in the program like walls, floors, and ceilings are measured. The heights of architectural objects can be measured relative to this absolute height, as well. As such, this default cannot be changed.

Room Type Defaults

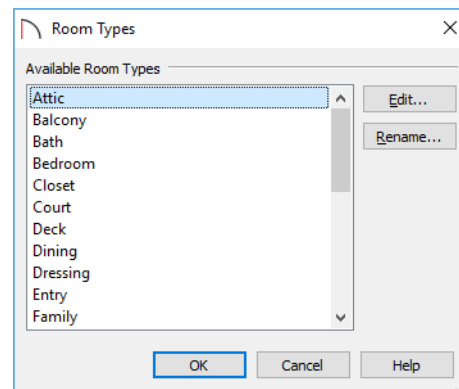

Select an **Available Room Type** from the list, then:

- Click the **Edit** button to modify the selected Room Type in the **Room Type Defaults** dialog.
- Click the **Rename** button to specify a new Name for the selected Room Type.

The settings in the **Room Type Defaults** dialogs allow you to specify the floor and ceiling finish materials for each Room Type.

is built, while a “Kitchen” will get GFCI Outlets when the Auto Place Outlet tool is used.

When a room is first created by enclosing an area with walls, it is assigned a generic room type of

“Unspecified.” Once a room is created, though, it can be assigned a **Room Type** in the **Room Specification** dialog. See “General Panel” on page 142.

Available Room Types

There are three broad categories of room Types: Interior, Exterior and Hybrid.

Interior - Living, Dining, Family, Kitchen, Nook, Bath, Master Bath, Master Bedrm, Bedroom, Study, Office, Entry, Hall, Closet, Dressing, Storage, Laundry, Utility and Unspecified.

Exterior - Court, Deck, Balcony.

Hybrid - Open Below, Garage, Slab, Porch, Attic.

Effects of Room Types

Home Designer Suite applies specific properties to rooms depending on the assigned Room Type.

Living and Conditioned Areas

- All interior type rooms are included in Living Area calculations by default; exterior and hybrid type rooms are not.
- With the exception of Unspecified rooms, all interior type rooms are included in Conditioned Area calculations. Open Below rooms are also included; however, exterior and other hybrid type rooms are not. See “Conditioned Area Totals” on page 382.

Ceilings and Roofs

- Interior rooms have a ceiling and roof above them.
- Exterior rooms are assumed to be open to the outside and do not generate a roof above them.
- Attic rooms do not receive a ceiling and are ignored by the program’s automatic roof generator.
- Garage, Slabs, and Porches are treated like exterior rooms in all cases except that they generate a ceiling and a roof above them by default.

Floors and Foundations









- A room’s default floor structure and finish definitions are determined by its Room Type. See “Room Type Defaults” on page 132.
- Open Below is a unique type of interior room that has no floor platform. Open Below rooms can be used for defining stairwell openings.

- Garages have a foundation under them with a concrete slab at the top of stem wall or grade beam.
- The floor in Garage and Slab rooms display in 3D on Floor 0, not the first floor. See “Garages” on page 224.
- Deck rooms do not generate foundations. See “Decks” on page 138.

Doors and Windows

- A window placed in a wall between an exterior room and an interior room always faces out toward the exterior.
- Doors placed between interior and exterior type rooms inherit their settings from the Exterior Defaults for the door tool, if available; they display threshold lines and are considered Exterior. See “Interior vs Exterior Doors” on page 169.
- Doors placed between interior type rooms do not display thresholds and are considered Interior.
- Open Below rooms are treated as interior rooms for window and door placement.

Electrical

- An electrical object placed on the wall of an exterior room using the **Light** , **Switch** , **110V Outlet**  or **220V Outlet**  tool will automatically be a waterproof or outdoor type fixture.
- The **Auto Place Outlets**  tool adds outlets automatically to all interior rooms. In Bath rooms, only one outlet over each sink is added. See “Auto Place Outlets” on page 215.
- **Auto Place Outlets**  places GFCI outlets in Kitchens and Baths.
- **Auto Place Outlets**  places fewer outlets in hybrid type rooms.
- **Auto Place Outlets**  does not place outlets in exterior type rooms, Porches or Open Below rooms.

Plan Check

- **Plan Check**  uses Room Types and their characteristics for basic plan checking. For example, a closet does not need a smoke detector but a bedroom does. See “Plan Check” on page 43.

Displaying Rooms

Unlike most things in Home Designer Suite, a room is not an individual object. Rather, a room is a space defined by the walls that enclose it.

In Plan Views

Rooms typically display a transparent fill in plan view. You can, however, specify a solid color or fill pattern for individual rooms in the **Room Specification** dialog. See “Fill Style Panel” on page 144.

In order for room fill styles to display, the “Rooms” layer must be turned on. See “Layer Attributes” on page 74.

Selecting Rooms

Room definition is established when a room is completely enclosed by walls. You can confirm that a room has room definition by using the **Select**

Objects  tool to select it. When a fully-enclosed room is selected, its interior space becomes highlighted. See “Selecting Objects” on page 79.

Rooms can be group-selected using the Shift or Ctrl key. They can also be marquee-selected using the

Marquee Select Similar  edit tool. To select rooms of a particular type, use the **Restrictive**

Selection  option. See “Selecting Multiple Objects” on page 80.



The room at left is selected

The Exterior Room

Each floor level of a plan has an Exterior Room, which allows you to control its exterior wall coverings and materials in the **Exterior Room Specification** dialog. See “Room Specification Dialog” on page 141.

Room labels that include the room’s name as well as its size and other information can be set to display in plan view. See “Room Labels” on page 136.

In 3D Views

Rooms can be viewed in views created by any of the 3D view tools. The **Dollhouse View** tool can be used to see all rooms on the current floor without their ceilings. See “Creating Overviews” on page 305.

In the Materials List



The contents of a room, including furnishings and floor and ceiling materials can be calculated using the **Calculate in Room** tool. See “Calculate Materials in Room” on page 378.

To select the Exterior Room in plan view, click just outside an exterior wall using the **Select Objects**  tool. If a wall or other object becomes selected

instead, click the **Select Next Object**  edit button or press the Tab key until the Exterior Room becomes selected. The Status Bar indicates which object is currently selected. See “The Status Bar” on page 26.



The Exterior Room is selected

When it is selected, a highlighted band around the plan’s exterior displays.

In 3D Views

A room can be selected in a 3D view by clicking on an empty space on its floor or a wall surface while the **Select Objects**  tool is active.

If you select a wall or other object instead of the room, click **Select Next Object**  edit button or press the Tab key until the room becomes selected.

In exterior camera views and overviews, the Exterior Room for each floor can be selected by clicking on

Editing Rooms

A room's structure and appearance can be modified using its edit tools and specification dialog. Rooms can be selected in all views, and the ways in which they can be edited depend somewhat on the current view. See "Selecting Rooms" on page 134.



In 3D Views

The floor and ceiling heights of individual rooms and entire floor levels can be edited using edit handles in 3D views. Lowered ceilings cannot be edited in 3D. See "3D Views" on page 303.

The default floor and ceiling heights for an entire floor level can be edited by selecting the Exterior Room. See "Floor and Room Defaults" on page 132.

To change default ceiling heights in 3D

1. Create a 3D view of the exterior of your plan.
2. Click on the exterior surface of a wall, then click the **Select Next Object**  edit button.
3. When the Exterior Room is selected in 3D:
 - The wall that you clicked on remains highlighted and an edit handle displays along its top edge.
 - When the wall is on any floor other than Floor 1, an edit handle also displays along its bottom edge.
 - A bounding box displays around each wall of the selected floor level.
 - The Status Bar says "Exterior Room". See "The Status Bar" on page 26.
 - A temporary dimension will display, measuring from the floor's default rough floor to default rough ceiling. See "Temporary Dimensions" on page 150.
4. Click and drag the edit handle on the top wall edge to adjust the default ceiling height, or the edit handle on the bottom edge to adjust the default floor height.
5. As you drag a handle, notice that the entire floor level is affected.

the exterior surface of an exterior wall using the **Select Objects**  tool and then clicking the **Select Next Object**  edit button.

Note: Any rooms that do not update when the default floor or ceiling height is changed are not using the default values. To use the default values for a specific room, check Default for any of the room height values in its specification dialog. See "General Panel" on page 142.

To adjust room heights in 3D

1. Create a 3D view of your plan.
2. Click on the surface of a wall that faces a room to select it, then click the **Select Next Object**  edit button.
3. When a room is selected in 3D:
 - The wall that you clicked on remains highlighted and an edit handle displays along its top and bottom edges.
 - The Status Bar says "Room".
 - A temporary dimension will display in elevation views, and measure from the room's rough floor to rough ceiling.
4. Click and drag the edit handle on the top wall edge to adjust the room ceiling height, or the handle on the bottom edge to adjust its floor height. Temporary dimensions display.
5. As you drag a handle, notice that all walls defining that room are affected.



Room materials such as floor, ceiling, and wall materials can be changed in 3D views using the

Material Painter . See "Material Painter Tools" on page 295.

Room moldings can be replaced directly from the library in 3D views, as well. See "Replace From Library" on page 283.

In the Specification Dialog

 Floor and ceiling heights, moldings, and materials can all be specified in the **Room Specification** dialog. See "Room Specification Dialog" on page 141.

- Click the **Calculate Materials for Room**  edit button to create a materials list of the contents of the selected room, not including walls. See “Calculate Materials in Room” on page 378.
- Click the **Auto Interior Dimensions**  edit button to generate interior dimensions that measure each wall defining the selected room(s). See “Auto Interior Dimensions” on page 150.

Room Labels

A label can display in plan view for any area defined as a room. There are two parts to each room label:

- The Room Name, which is similar to a **Text**  object and can be selected and edited. See “The Text Tools” on page 158.
- The room area, which is not a standard text entry and cannot be directly edited.



Room labels can move or even disappear when room entries are revalidated.

Custom Room Names

The Room Names that display in room labels are based on the Room Types assigned in the **Room Specification** dialog. See “Room Types” on page 132.

You can, however create a custom name for a selected room, also in the **Room Specification** dialog. See “General Panel” on page 142.

Before creating a custom Room Name, assign the Room Type most similar to the room’s actual use. For example, if you wish to name a room “Guest Room”, begin by specifying it as a “Bedroom” since these rooms have similar uses.

You can assign a custom Room Name, move a room label or even delete it without affecting the Room Type.

Displaying Room Labels

The display of room labels is controlled in the **Display Options** dialog. Room labels are placed on the “Rooms, Labels” layer and use the Text Style assigned to that layer. See “Display Options Dialog” on page 74.

You can specify how the area of rooms is reported by the program by turning on the display of one or more of these layers:

- **Rooms, Standard Area** is measured from the center of interior walls that define the room and from either the outside surface or outside of the Main Layer of exterior walls, depending on the

Living Area to setting in the **General Plan Defaults** dialog. It is rounded to the nearest square foot or mm and does not include the area within bay, box and bow windows. See “Exterior and Interior Walls” on page 112 and “General Plan Defaults Dialog” on page 49.

- **Rooms, Interior Area** is measured from the inner surfaces of all the room's walls.
- **Rooms, Interior Dimensions** is also measured from the inner surfaces of the room walls.

The display of room labels can also be controlled on a room by room basis in the Room Specification dialog. See “General Panel” on page 142.

Editing Room Labels

Room labels are similar to simple **Text**  objects and can be moved and resized much like any other text object. You can also modify a room label’s Text Style and other attributes in the **Room Label Specification** dialog. See “Room Label Specification Dialog” on page 137.

The text of a room label cannot be modified in its specification dialog, however. The Room Name can only be specified in the **Room Specification** dialog.

If you delete a room label, the Room Type and Room Name remain unchanged in the **Room Specification** dialog. To restore the label, check the **Show Room Label** checkbox on the GENERAL panel of that dialog.

If you wish to further customize a room’s label by adding text, uncheck **Show Room Label** in the **Room Specification** dialog and create your own label using a Text object.

Room Area

Unlike the rest of a room label, the room area and dimensions are not standard text entries and cannot be edited or changed. The room area moves, resizes and rotates with the rest of the room label, but you can turn the area and dimensions on or off separately in the **Display Options** dialog. See “Displaying Rooms” on page 134.

The **Interior Area** room area calculation includes the areas within bay, box or bow windows, while the Standard Area and Interior Dimensions calculations do not.

Living Area

The Living Area label is an automatically generated Text object that reports the area of the current floor specified as living space. By default, Interior Rooms are defined as part of the Living Area, while Exterior and Hybrid Rooms are not. See “Available Room Types” on page 133.

Regardless of its Room Type, you can specify whether any room is included in the Living Area Calculation in the **Room Specification** dialog. See “General Panel” on page 142.

A Living Area label is created as soon as a room area is defined by walls and/or railings and is recalculated every time you add, remove, resize, or redefine a room. If multiple buildings are created, each will have its own Living Area label. If none of a structure’s rooms are included in the Living Area Calculation, however, no Living Area label will display for it.

Each Living Area label can be edited in its specification dialog. If a new floor is added, however, any existing Living Area labels will be deleted and replaced. See “Room Label Specification Dialog” on page 137.

To turn off the display of all Living Area labels in a plan, uncheck **Show Living Area Label** in the **General Plan Defaults** dialog or turn off the “Room Labels” layer in the **Display Options** dialog. See “General Plan Defaults Dialog” on page 49.

The Living Area label can be moved or deleted. To restore a deleted Living Area label, select **Tools>**

Plan Check . You can click the **Done** button immediately, without actually completing Plan Check. See “Plan Check” on page 43.

Living Area vs. Footprint

The Living Area should not be mistaken for the footprint of a house. Only true livable areas are included in the Living Area calculation. By default, exterior and hybrid room types such as Garage, Deck, and Porch are not included. Neither is any room labeled Open Below or Attic. See “Available Room Types” on page 133.

Regardless of its room type, you can specify whether a room is included in the Living Area calculation in the **Room Specification** dialog. See “General Panel” on page 142.

Living Area is measured from either the outside surface or the outer surface of the structural layer of exterior walls.

Room Label Specification Dialog

 The **Room Label Specification** dialog opens if you select a Room Label or Living Area Label and click the **Open Object** edit button. See “Room Labels” on page 136.

A similar **Text Specification** dialog is available for simple **Text** objects in legacy plan files created in Version 8 or prior. See “Compatibility with Other Programs” on page 31.

Text Panel

The settings on the **TEXT** panel allow you to add information to the Living Area Label. The text of a

selected Room Label cannot be edited, however. See “Room Labels” on page 136.

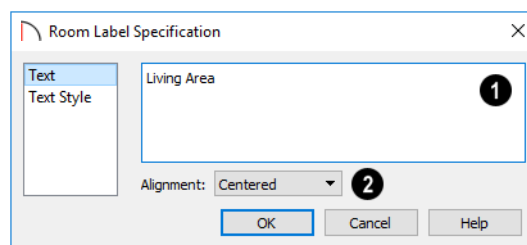

1 In the text field, type any information that you would like added to the Living Area Label. The

text of a selected Room Label displays here but cannot be edited.

- 2 Select an **Alignment** option from the drop-down list to apply to the text.

For legacy Text objects only, a preview of the text displays in a panel on the right.

Decks

A Deck room is an exterior-type room that uses deck planking and framing to create a floor platform rather than using a single floor surface that spans the entire room area.

To draw a deck, select **Build > Railing and Deck > Straight Deck Railing** , then click and drag to draw a railing.

- To create a deck without a railing, use one of the **Deck Edge** tools. See “Fencing Tools” on page 112.
- You can also create a regular, polygon-shaped deck using the **Polygon Shaped Deck**  tool. See “Polygon Shaped Deck” on page 111.

A room does not have to be defined by Deck Railing to be specified as a “Deck.” See “Room Types” on page 132. You can also define a room as a “Deck” in the **Room Specification** dialog. See “General Panel” on page 142.

By default, decks do not have roofs. If you want a roof over a deck, check **Roof Over This Room** in the **Room Specification** dialog. See “Structure Panel” on page 143.

Floor and Ceiling Heights

Default floor and ceiling heights are defined in the **Floor Defaults** dialog for each floor, including the foundation. Use the **Floor Defaults** dialog to change these values on a floor-by-floor basis. See “Floor and Room Defaults” on page 132.

Use the **Room Specification** dialog to set floor heights on a room-by-room basis. See “Room Specification Dialog” on page 141.

Different rooms on the same floor can have unique floor and ceiling heights, allowing you to create:

- Split levels and bi-levels
- Sunken living rooms and garages
- Cathedral and coffered ceilings.

The **TEXT STYLE** panel is available for a variety of objects in the program and control the appearance of the selected object’s text. See “Text Style Panel” on page 165.

To give the roof a visible means of support, you can select the **Post to Beam** option in the **Wall Specification** dialog. See “Rail Style Panel” on page 127.

Openings in deck railings can be created using **Doorways** . See “Openings in Railings” on page 175.

Deck Framing and Planking

When a Deck room is created, the floor platform is modeled using joists, beams, posts, and planking.

Deck framing, planking, posts, and beams are placed on their own layers with names that begin with “Framing, Deck”: for example, “Framing, Deck Posts”. These layers cannot be turned on in plan view but are shown in 3D views.

The structural materials for a selected deck can be calculated in a Materials List by clicking the

Calculate Structural Materials for Deck  edit button. See “Materials Lists” on page 377.



In 3D views, you can adjust the default floor and ceiling height for the entire floor or the floor and ceiling height for an individual room. See “In 3D Views” on page 135.

In order to raise or lower an area’s floor or ceiling height, you must give it a room definition. To create

room definition without enclosing an area with solid walls, use **Railings** .

Ceiling and floor heights are interrelated. Changing the floor height in one room can affect ceiling heights of the rooms below.

- If a room’s floor is lowered, its ceiling height is increased while the ceiling below that room drops.
- If the floor is raised, the ceiling height decreases while the ceiling below that room is raised.

If the rooms above a particular room have more than one floor height, the room’s ceiling is stepped.

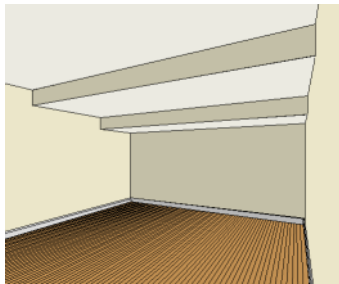

In a situation like this, a Lowered Ceiling can be used to cover “steps” made by different floor heights on the floor above. See “General Panel” on page 142.

To ensure that steps in floor and ceiling platforms have solid sides, define their room areas using Invisible Railings.

Shelf Ceilings

In rooms with high or vaulted ceilings, it is possible to have a smaller room such as a closet that has a flat,

Stepped Floor and Ceiling Platforms

Each floor has default floor and ceiling heights. You can, however, use the **Room Specification** dialog to specify floor and ceiling heights on a room by room basis to create stepped floors and ceilings. See “Structure Panel” on page 143.

Special Ceilings

By default, the program builds a flat ceiling platform on top the wall plates of a room. More varied and

lower ceiling. By default, the area above the flat ceiling will be enclosed by automatically-generated Attic walls. See “Attic Walls” on page 123.

If you prefer, you can specify that these Attic walls be suppressed and an open space be created instead. This condition is referred to as a **Shelf Ceiling**, or plant shelf, and can be specified in the **Room Specification** dialog of the room with the lower flat ceiling. See “Structure Panel” on page 143.

Split Levels

A split level can be created by raising or lowering the floor and ceiling heights of various areas of the plan.

In the following example, the lowest floor height is 0, the next is 24, and the next is 48 inches. The ceiling height in each room is set at 109 inches. See “Split Levels” on page 229.

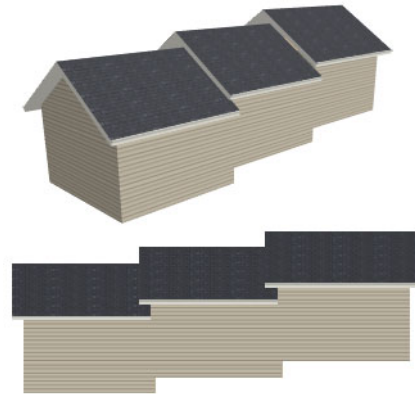

If you require a single floor platform with a uniform height and thickness but different ceiling heights for the rooms below, specify a lowered ceiling using the **Ceiling Finish Specification** dialog. See “Lowered Ceilings” on page 139.

complex ceilings are made using settings in the **Room Specification** dialog.

Lowered Ceilings

You can define a lowered or dropped ceiling in a room without affecting the top height of the walls by increasing the thickness of the Ceiling Finish.

In the following illustration, the default ceiling height for the entire first floor is 120", and the room on the right has a ceiling finish lowered to 96".

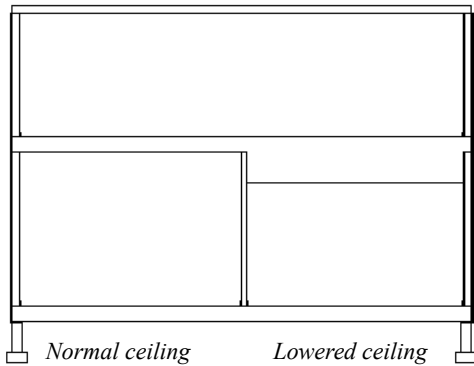

To create a lowered ceiling

1. Select the room in which you would like to specify a lowered ceiling.

2. Click the **Open Object**  edit button to open the **Room Specification** dialog.
3. On the **STRUCTURE** panel, increase the **Ceiling Finish** value by the amount that you would like to lower the ceiling.
4. Notice that the preview diagram represents the Finished Ceiling height (F).

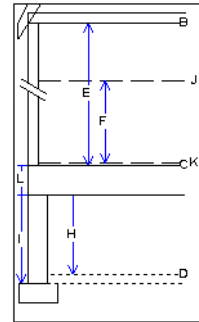

Cathedral Ceilings

A cathedral ceiling has the same pitch as the roof and is created using the underside of the roof above the room.

To create a cathedral ceiling

1. Build a roof for your plan. See “Roofs” on page 255.

2. Select the room and open the **Room Specification** dialog. See “Room Specification Dialog” on page 141.
3. On the **STRUCTURE** panel, uncheck **Flat Ceiling Over This Room**.

Trey Ceilings

A trey ceiling is an area within a ceiling that is raised and has either vertical or sloping sides. A standard trey ceiling can be easily created by placing Soffits around the perimeter of the room. An angled trey ceiling can be created using the underside of roof planes above.

To create an automatic angled trey ceiling

1. In the **Room Specification** dialog, make sure that **Flat Ceiling Over this Room** is checked, then specify the desired height of the walls as the **Ceiling Height**. See “Structure Panel” on page 143.
2. Make sure that **Auto Rebuild Roofs** is unchecked, then build the roof. See “Build Roof Dialog” on page 256.

3. Change the **Ceiling Height** of the room to the desired height of the flat ceiling surface in its center.

In plan view, dashed lines indicate where the ceiling changes from sloped to flat. These lines are located on the “Ceiling Break Lines” layer in the **Display Options** dialog. See “Display Options Dialog” on page 74.

If the roof is rebuilt after the ceiling height is adjusted upward, the new roof will be raised to match the new ceiling height and a trey ceiling will not be created.

In the following example, a hip roof is built on 8’ (2400 mm) ceilings. After the roof is built, the Ceiling Height is raised to 10’ (3000 mm). The resulting ceiling follows the roof pitch for 2’ (600 mm), then becomes a flat ceiling.

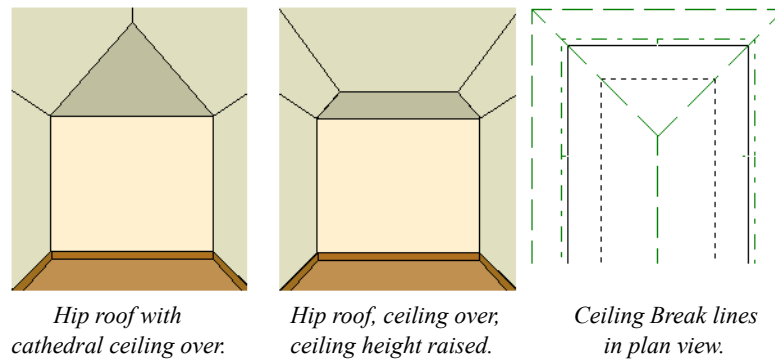

Cantilever Undersides

Occasionally, a room will cantilever out past an exterior wall. You can specify the surface material of the underside of a cantilever on the **MATERIALS**

panel of the **Room Specification** dialog. See “Room Specification Dialog” on page 141.

Room Moldings

Base molding, chair rail, and crown moldings can be applied to rooms on a floor by floor basis in the **Floor Defaults** dialogs, to different room types in the **Room Type Defaults** dialogs, and to individual rooms in the **Room Specification** dialog. See “Floor and Room Defaults” on page 132 and “Room Specification Dialog” on page 141.

By default, Home Designer Suite does not automatically add room moldings to exterior or

hybrid room types. Baseboards and chair rails are not automatically added to Open Below rooms, either; however, crown molding is if it is specified in the defaults for the room’s floor. See “Room Types” on page 132.

Base molding and chair rail heights are both offset from the floor, while crown molding is offset from the ceiling. For additional information, see “Applying Moldings” on page 268.

Room Specification Dialog



The **Room Specification** dialog controls the structural characteristics and appearance of a selected room. To open the **Room Specification** dialog, select a room and click the **Open Object** edit button. See “Selecting Rooms” on page 134.

Some of the panels in this dialog are also found in the **Exterior Room Specification** dialog as well as in the **Floor** and **Room Type Defaults** dialogs. See “Floor and Room Defaults” on page 132.

Some values in this dialog are dynamic. A value with Default specified references the **Floor Defaults** dialog. To return a value to the default, replace the check mark. See “Dynamic Defaults” on page 48.

The settings in this dialog are similar to those in the **Floor Defaults** dialog, but affect only the selected room. See “Floor Defaults Dialog” on page 227.

General Panel

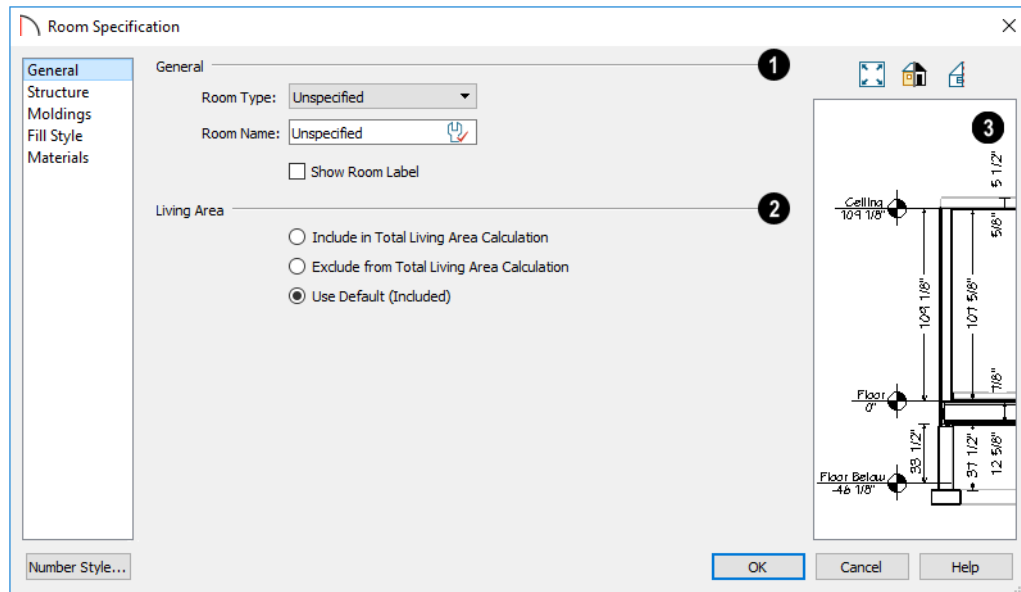

- 1** The settings here control the Room Type and the appearance of the Room Label

 - Select the **Room Type** from the drop-down list. Changing the Room Type can affect settings throughout the dialog. See “Room Types” on page 132.
 - Click the **Define** button to open the **Room Types** dialog where you can customize the settings of the selected Room Type.
 - In the **Room Type Defaults** dialog only, the **Function** of the selected room type displays for reference. See “Available Room Types” on page 133.
 - If you wish to use a custom name in the room’s label, type the desired **Room Name** in the text field.
 - Check **Show Room Label** to display the room label in plan view. See “Room Labels” on page 136.
This option is unchecked automatically if you select “Unspecified” as the Room Type, and checked automatically if you select any other Room Type
- 2** Specify whether the selected room is included in the **Living Area** calculation. See “Living Area” on page 137.

 - Select **Include in Total Living Area Calculation** to include the room in the Living Area regardless of its Room Type.
 - Select **Exclude from Total Living Area Calculation** to exclude the room from the Living Area regardless of its Room Type.
 - Select **Use Default for Room Type (Included/ Excluded)** to base the selected room’s inclusion in the Living Area on its Room Type. The default for the selected Room Type is stated in parentheses.
- 3** The preview on the right side of this dialog features a cross section diagram showing the relationships between the room’s heights and platform thicknesses.

If present, the floors above and below the selected room are also shown. The left side of the floor above is offset for clarity.

The height and thickness values shown in this diagram are set on the Structure Panel.

Structure Panel

Some settings on the STRUCTURE panel are also found in the **Floor** and **Room Type Defaults** dialogs.

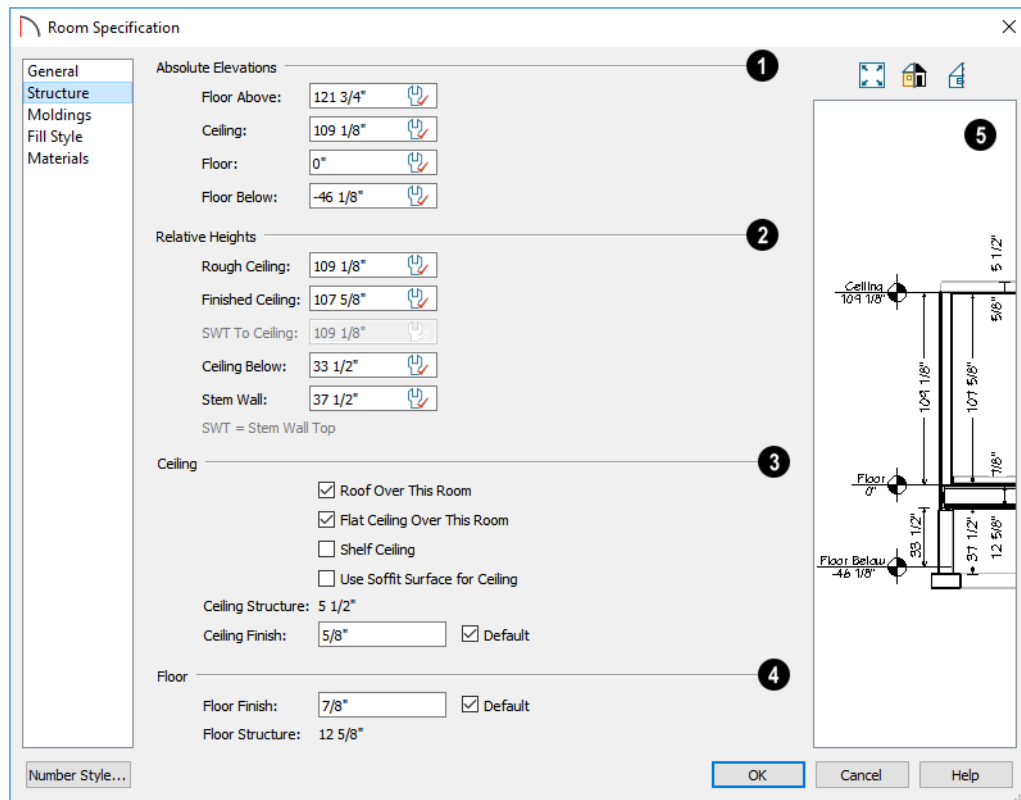

Active Defaults  icons in the Elevation and Height fields, as well as Default check boxes next to the Finish fields indicate that these settings are Dynamic Defaults.

Note: Many of the settings on this panel are interdependent. For example, if the Ceiling Finish thickness is modified, the Finished Ceiling height will change in response.

1 Absolute Elevations - These height values are measured from zero, which is the default top height of the subflooring on Floor 1. See “Floor and Ceiling Heights” on page 138.

- The **Floor Above** height displays here for reference. If multiple rooms with differing floor heights exist directly above, “No Change” will display.
- Specify the **Ceiling** height of the selected room, as measured from zero to the bottom of the ceiling framing. Not available in the **Floor Defaults** dia-

log on Floor 0, or if multiple floor heights are specified above the selected room.

- Specify the **Floor** height, as measured from zero to the top of the subfloor.

Note: The default floor height for Floor 1 is 0. It can be modified in the Room Specification dialog, but not in the Floor 1 Defaults dialog. See “Floor and Room Defaults” on page 132.

If a room is defined directly beneath the selected room on the floor below, additional settings may be available.

- Specify the **Floor Below** height, which is the sub-floor height of the room directly below where you clicked to select the currently selected room. If there are multiple rooms with differing floor heights located below, this value may change depending on where you click.
- If the selected room is directly above a Garage and there is a foundation present, you can specify the **SWT Below** height, which is the top height of

the concrete stem walls around the perimeter of the garage.

- 2 **Relative Heights** - These height values are measured from surfaces within the selected room or the room below.
 - Specify the **Rough Ceiling** height, as measured from the subfloor surface to the bottom of the ceiling framing. Not available if multiple floor heights are specified directly above the selected room.
 - Specify the **Finished Ceiling** height, as measured from the finished floor surface to the finished ceiling surface. Not available if multiple floor heights are specified directly above the selected room.
 - Specify the distance from the **Stem Wall Top to Ceiling**. Only available when **Floor for this Room is Supplied by the Foundation 'Room' from the Floor Below** has been checked.
 - Specify the **Ceiling Below** height, which is the height of the ceiling of the room below, as measured from that room's subfloor to rough ceiling surfaces. Not available when Auto Rebuild Foundation is enabled or if there is no room below the selected room. See "Rebuilding Foundations" on page 223.
 - Specify the **Stem Wall** height, which is measured from the top of the foundation wall footing to the top of the treated sill plate, if one is specified. Only available if the selected room or the room below it is defined by foundation walls.
- 3 Specify the characteristics of the room's **Ceiling**.
 - If **Roof Over This Room** is checked, a roof automatically generates over the room. If unchecked, no roof generates.
 - If **Flat Ceiling Over This Room** is checked, the room has a flat ceiling. If unchecked, the ceiling follows the underside of the roof.
 - Check **Shelf Ceiling** to prevent Attic Walls from generating over the interior walls that define the selected room. When unchecked, interior Attic Walls will generate if surrounding rooms have higher ceilings than the selected room. See "Shelf Ceilings" on page 139.
 - Check **Use Soffit Surface for Ceiling** to improve the 3D appearance of the transition between ceiling and eaves of exterior rooms with Flat Ceiling Over This Room unchecked.

- The thickness of the **Ceiling Structure** displays here for reference but cannot be changed.
- Specify the thickness of the **Ceiling Finish** layer.
- 4 Specify the thickness of the **Floor Finish** layer.
 - The thickness of the **Floor Structure** displays here for reference but cannot be changed.
- 5 The preview on the right side of this dialog features a cross section diagram showing the relationships between the room's heights and platform thicknesses.
 - If present, the floors above and below the selected room are also shown. The left side of the floor above is offset for clarity.
 - The callout or dimension line associated with selected height or thickness value will be highlighted in the preview, as will any height or thickness value that you move your mouse point over.

What appears in both the diagram and in the settings on the STRUCTURE panel may be affected by the location where you clicked to select the room. For example:

- If the selected room is located above two rooms with different structural settings, the position of the pointer relative to these two lower rooms determines which of them displays as the floor below.
- If the selected room is located below two rooms with different floor heights, its absolute and relative ceiling height settings will be disabled.

Moldings Panel

Chair rail, crown and base moldings can be assigned to one or more selected rooms on the MOLDINGS panel. Moldings are placed on a room's wall surfaces and continue around the surface of any soffit that is attached to the wall at the molding height.

The settings on this panel are also similar to those found in the **Floor Defaults** dialog, but affect only the selected room instead of all rooms on the current floor.

The settings on this panel are similar to those found in other specification dialogs throughout the program. See "Moldings Panel" on page 268.

Fill Style Panel

The settings on the FILL STYLE panel affect the appearance of the room in plan view. This panel is

also found in the **Floor Defaults** dialog. For more information, see “Fill Style Panel” on page 76.

Materials Panel

The settings on this panel affect the appearance of a selected room’s walls, floor, ceiling, and moldings in 3D views. See “Materials Panel” on page 296.

Default molding and ceiling and floor covering materials can be set on this panel in the **Floor Defaults** and **Room Defaults** dialogs.

Dimensions

Home Designer Suite provides a variety of dimensioning tools for measuring walls, doors, windows, and many other objects.

Dimensions can be used to accurately position objects relative to other objects. In addition, dimension lines and extensions can be selected and customized.

Chapter Contents

- Dimension Unit Defaults
- Dimension Defaults Dialog
- The Dimension Tools
- Displaying Dimension Lines
- Editing Dimension Lines
- Editing Extension Lines
- Moving Objects Using Dimensions
- Dimension Line Specification Dialog

Dimension Unit Defaults

All plan files save measurements in either Imperial or metric units. The type of unit used is determined

when the file is first created and cannot be changed later. See “Creating a New Plan” on page 33.

Dimension Defaults Dialog



Select **Edit> Default Settings**, select “Dimension”, and click the **Edit** button to open the **Dimension Defaults** dialog.

The settings in this dialog are dynamic defaults, which means that any changes made here may affect existing dimension lines in the drawing that are using default values. See “Dynamic Defaults” on page 48.

Setup Panel

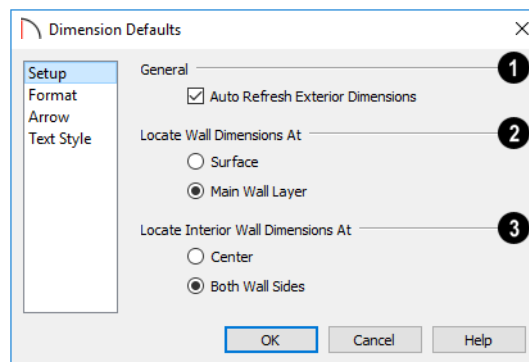

1 Uncheck **Auto Refresh Exterior Dimensions** to prevent Auto Exterior Dimensions from being regenerated as changes are made to the plan. When checked, Auto Exterior Dimensions will be created when walls enclose a room area and will refresh whenever walls, doors, or windows are added or moved. See “Auto Exterior Dimensions” on page 150.

2 Specify how Manual and Auto Exterior Dimension lines locate both interior and exterior walls.

- Select **Surfaces** to have dimensions locate the outer surfaces of walls.

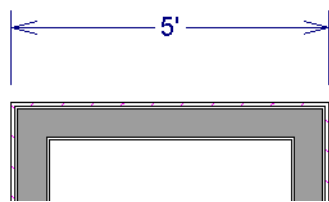

Dimensions locating wall Surfaces

- Select **Main Wall Layer** to have dimensions locate the structural layer of exterior walls.

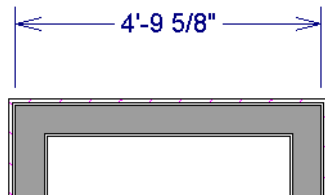

Dimensions locating walls' Main Wall Layers

3 Specify how Manual and Auto Exterior Dimension lines locate interior walls.

- Select **Centers** to have exterior dimensions locate the centers of interior walls.

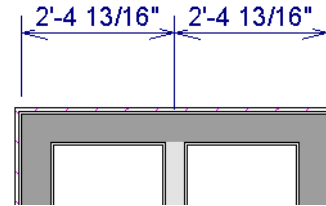

Dimensions locating an intersecting wall's center

- Select **Both Wall Sides** to have dimensions locate both sides of interior walls. Either the wall Surfaces or both sides of the Main Wall Layers will be located, depending on your selection above.

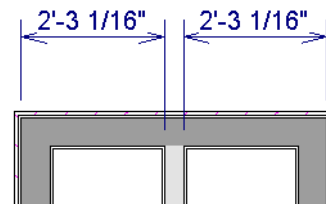

Dimensions locating an interior wall's Main Wall Layer

You can always change the object or surface that a dimension locates after it has been created. See “Editing Extension Lines” on page 152.

Format Panel

The settings on the **FORMAT** panel allow you to specify the units, position, and degree of accuracy of dimension numbers. The settings on this panel also

control the format of object length numbers in the Status Bar. See “The Status Bar” on page 26.

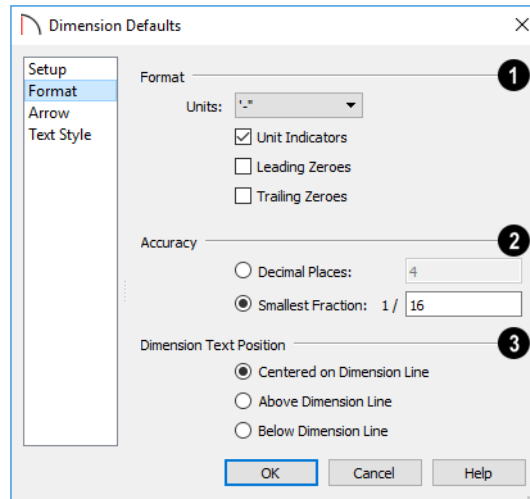

- 1 Specify the numbering **Format** for dimension numbers.
- Select the **Units** of measurement to be used by dimensions from the drop-down list.
 - Check **Unit Indicators** to display the unit of measurement along with the dimension number.
 - Check **Leading Zeros** to include the zero before a decimal less than 1 or to display 0' or 0" when the ft-in or '-'" unit formats is used.
 - Check **Trailing Zeros** to display trailing zeros at the end of decimal values. When the ft-in or '-'" unit format is used and fractional inches are specified, 0" will be included.

- 2 Specify the degree of **Accuracy** used by dimension numbers.
- Select the **Decimal Places** radio button for dimension numbers in decimal format. In the text field, specify the number of decimal places to use, from 0 to 20. If 0 is used, no decimal places are used.
 - Select the **Smallest Fraction** radio button for dimension numbers using whole numbers and fractions. In the text field, specify the largest denominator to use, from 1 to 16. If 1 is entered, whole numbers are used.

- 3 Specify the **Dimension Text Position**, which is the location of dimension numbers relative to the dimension line.

- **Center** primary dimension numbers on the dimension line. If two formats are used, the primary format is placed above the line and the secondary format, beneath it.
- Position dimension numbers **Above Line**.
- Position dimension numbers **Below Line**.

Arrow Panel

For information about the ARROW panel, see "Arrow Panel" on page 103.

Text Style Panel

The settings on the TEXT STYLE panel control the size, font and other attributes of automatic, manually drawn, and temporary dimension line labels. See "Dimension Labels" on page 151.

For information about the settings on this panel, see "Text Style Panel" on page 165.

Temporary dimension labels always use the color assigned to their layer - not the color specified in the **Dimension Defaults** dialog.

The Dimension Tools



Select **CAD> Dimensions** to access the Dimension Tools. Manually drawn dimensions are created by clicking and dragging like other line-based objects and can be drawn in plan view.

The zoom factor of the current view affects whether objects drawn close together are dimensioned or not. If you try to dimension an array of objects but the dimension line locates only the first and last objects along its path, **Zoom**  in on the objects and try

again. Similarly, if you want to dimension between two objects but the dimension locates unwanted objects between them, **Zoom**  out. See “Zoom Tools” on page 63.

Once created, both manually drawn and automatically generated dimension lines can be selected and edited. See “Editing Dimension Lines” on page 151.

Manual Dimensions



To display the distance between two objects, select **CAD> Dimensions> Manual Dimension** and drag a dimension line near or through the objects.

Manual Dimensions locate walls as specified in the **Dimension Defaults** dialog. See “Dimension Defaults Dialog” on page 147.

End-to-End Dimensions



Use the **End-to-End Dimension** tool to dimension between any two defined objects in plan view.

Select **CAD> Dimensions> End-to-End Dimension**



, then click and drag the dimension from the first object to the second object. The dimension line snaps to each object, ignoring any other objects located between either end.

Interior Dimensions



Draw **Interior Dimension** lines parallel to walls in plan view to create interior dimensions.

The **Interior Dimension**  tool locates interior wall surfaces only. It does not dimension between layer surfaces in the same wall, and it does not locate walls unless it actually intersects them.

Auto Exterior Dimensions



The **Auto Exterior Dimension** tool generates dimensions around a plan’s exterior in plan view. These dimension lines locate walls as specified in the **Dimension Defaults** dialog. See “Dimension Defaults Dialog” on page 147.



Auto Exterior Dimensions do not generate properly if there is a gap in the exterior walls or if they do not connect properly.

If you edit an **Auto Exterior Dimension**  line, it will be converted to a manual dimension, so if Auto Exterior Dimensions are later regenerated, your changes will not be lost.

Up to three rows of automatically generated dimensions may be created per exterior wall. The innermost dimension line locates exterior walls, interior walls, and all openings in exterior walls. The second dimension line locates exterior and interior walls. The outermost dimension line is the overall exterior dimension.

Auto Interior Dimensions



Select one or more rooms and click the **Auto Interior Dimensions** edit button to generate interior dimensions that measure each wall defining the selected room(s).

Auto Interior Dimensions  lines are generated inside of the rooms they measure and do not recognize the **No Locate** setting for walls. If a wall is specified as No Locate, Auto Interior Dimensions will locate it anyway. See “No Locate” on page 119.

Temporary Dimensions



Temporary Dimensions display when an object is selected and show the distance between the object’s selected edge and other objects. Select **View> Temporary Dimensions** to turn on or off the display of temporary dimensions. This toggle affects all views and is saved between launches of Home Designer Suite.

As with other dimension lines, Temporary Dimensions only locate objects that are parallel or nearly parallel to one another. They will also locate the endpoints of CAD lines and the corners of objects located past the end of the selected edge, within 4 feet (1200 mm) of the point where you click to select the object.

A temporary dimension will not display when an object is selected if a dimension line is already present that shows the same information.

Tape Measure



Use the **Tape Measure** tool to draw a temporary dimension line between any two points in the drawing area. The tool will place temporary markers at the start and end points of the dimension line. These points and the line both disappear when you release the mouse button. If an

object is located by the temporary line, you can snap to it.

The **Tape Measure**  tool can be used in Elevation views as well as in plan view. See “Elevation Views” on page 306.

Displaying Dimension Lines

The display of dimension lines is controlled in the **Display Options** dialog. See “Displaying Objects” on page 73.

Dimension lines created by any of the dimension tools share the same components.

- **Dimension Lines** run parallel with the distance being measured.
- **Extension Lines** are perpendicular to dimension lines, indicating what they locate. If a dimension line locates more than two objects, extension lines divide the dimension line into segments.
- **Arrowheads** display at the intersections of dimension and extension lines.
- **Dimension Labels** display at the midpoint of dimension line segments and indicate the distance that each segment measures.

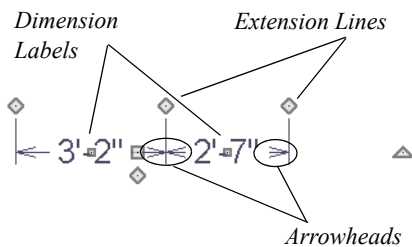

If a manual dimension line is on a layer that is turned off and you select an object located by that

dimension line, it will display for reference using the Selection Line color specified in the **Preferences** dialog. See “Colors Panel” on page 51. This will happen only if **Temporary Dimensions**  are turned on. See “Temporary Dimensions” on page 150.

Dimension Labels

Manually drawn, automatic, and temporary dimension labels use the Text Style specified in the **Dimension Defaults** dialog. Unlike many objects that use Text Styles, by default dimensions use a Text Style specified in the defaults dialog rather than the Text Style assigned to their layer. See “Text Style Panel” on page 149.

Dimension Arrowheads

You can specify the style, color and size of dimension arrows in the **Dimension Defaults** and **Dimension Line Specification** dialogs. See “Arrow Panel” on page 103.

The arrow at the end of a dimension line will not display if it is close enough to another dimension arrow that the two will overlap. A typical example of this is where two sections of an Interior Dimension locate two sides of an interior wall.

Editing Dimension Lines

For information about changing the value reported in a dimension line label, see “Moving Objects Using Dimensions” on page 154.

With the exception of Temporary Dimensions, dimension lines can be selected and edited using the mouse and the edit toolbar buttons.

If an Auto Exterior Dimension line is edited, it will no longer be considered an automatic dimension line and will not be deleted and replaced the next time the **Auto Exterior Dimensions**  tool is used.

Using the Mouse

When a dimension line is selected, its edit handles can be seen. There are four types of dimension line edit handles. The total number of edit handles a dimension line has depends on how many extension lines it has.

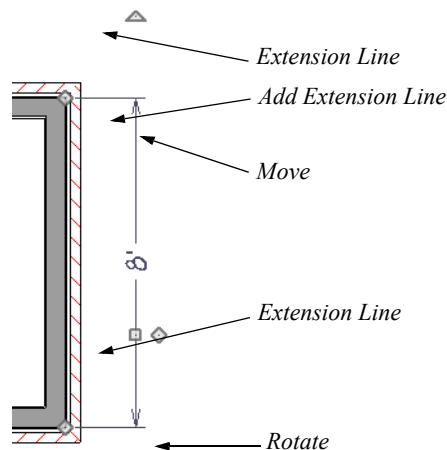

- The **Extension Line** handles are positioned at the point that each extension line locates and are used to move or delete extension lines. See “Moving an Extension Line” on page 153.
- The **Add Extension Line** handle displays to the side of the Move handle and is used to add extension lines to the dimension line. Extension lines added in this manner are able to locate marks that the dimension line might not locate as it was being drawn. See “Adding an Extension Line” on page 152.
- The **Move** handle is located where you clicked to select the dimension line and is used to move the entire dimension line, including any subsections, perpendicular to itself. Extension lines are resized as appropriate. The pointer changes to a two-headed arrow ↔ when moved over this handle.
- The **Rotate** handle is located past the end of the dimension line and can be used to rotate the dimension line.

Using the Edit Tools

Dimension lines can be repositioned, copied, and deleted using the edit toolbar buttons just like other objects in the program can. See “The Edit Toolbar” on page 23.

Editing Extension Lines

Extension lines can be added, edited, and deleted using the edit handles when their dimension line is selected.

Dimension Number Size

The initial size of dimension numbers is specified in the **Dimension Defaults** dialog. See “Dimension Defaults Dialog” on page 147.

You can specify number height for individual dimension lines in the **Dimension Line Specification** dialog. See “Dimension Panel” on page 155.

As with text and other objects, dimension number size is subject to scaling when or printed.

Copying and Pasting Dimension Lines

Dimension lines can be copied and pasted into any view type that supports dimensions. If a dimension line is copied independent of the objects it originally locates, the pasted dimension line will locate Point Markers.

Deleting Dimension Lines

There are several ways to delete dimension lines.

You can select any manual or automatic dimension line or group of dimension lines, then press the

Delete key or click the **Delete**  edit button. See “Deleting Objects” on page 98.

The **Delete Objects** dialog allows you to delete all manually drawn and/or automatic dimension lines at once. See “Delete Objects Dialog” on page 99.

Individual dimension line segments located between extension lines can also be deleted. If a segment is located between two other segments along the same dimension line, that dimension will be broken in two.

To delete a portion of a dimension line

1. Select any **Dimension Tool** aside from Auto Exterior Dimensions.
2. Manually draw a dimension line over the segment that you wish to remove, dragging from extension line to extension line.

Adding an Extension Line

The Add Extension Line edit handle allows you to locate marks that the dimension line might not have been able to locate as it was being drawn. Interior Dimensions, for example, do not locate cabinets as

they are drawn; however, you can add an extension line that locates a cabinet.

To add an extension line

1. Select the dimension line anywhere along its length.
2. Click the diamond-shaped Add Extension Line edit handle which displays near the Move edit handle. The pointer changes to a two-headed arrow ↔.
3. Drag the handle to the object that you want to locate with a new extension handle. This example adds an extension line to the window edge.

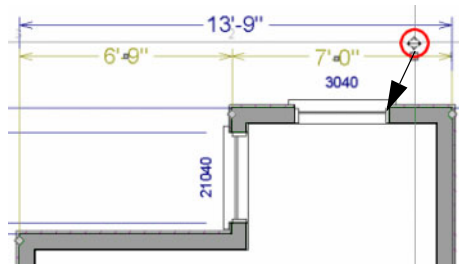

4. Release the mouse button to add an extension line.

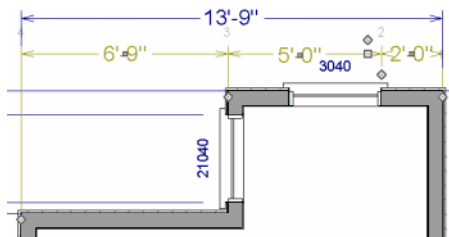

Moving an Extension Line

Extension lines can be moved to locate the centers, sides, or surfaces of most objects. Here, an extension line is moved from the windows edge to the center.

To move an extension line

1. Select the dimension line anywhere along its length: do not click on the extension line itself.
2. Click the Extension Line edit handle. The pointer changes to a two-headed arrow ↔.

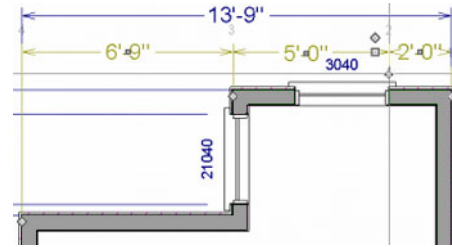

3. Drag the handle to a new location. The extension line snaps to possible marks as the handle is moved.
4. Release the mouse button at the new location.

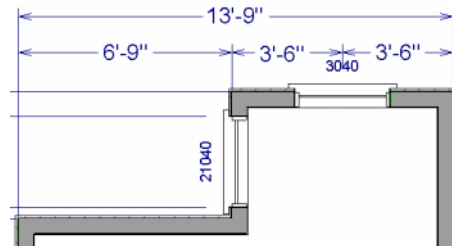

Not all library symbols can be located by a dimension line as it is drawn. Once a dimension is drawn, however, you can move or add an extension line to locate the library object.

Deleting an Extension Line

When an extension line is deleted, the remaining dimensions update. If a dimension line has only two extension lines, they cannot be deleted.

To remove an extension line

1. Select the dimension line anywhere along its length: do not click on the extension line itself.
2. Click the Extension Line edit handle.

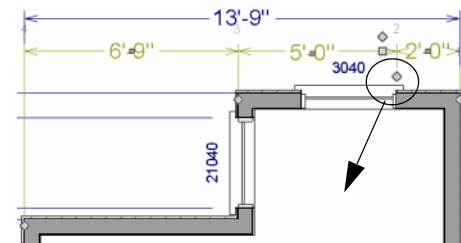

3. Drag it perpendicular to the direction of the arrows, away from any dimensionable object, and release the button when the extension line disappears.

Moving Objects Using Dimensions

Most objects can be moved by changing an automatic, manual, or temporary dimension value that locates it. This technique can be applied in nearly any situation where dimensions are present. See “Moving Objects” on page 92.

In addition, some objects can be resized using dimensions. See “Resizing Objects” on page 94.

Your pointer indicates which dimensions can be used to relocate the selected object by changing to a pointing hand icon.

Another way to tell is to select an object and drag it in the desired direction. As you drag, note which dimensions update. These dimensions are the dimensions that can be used to move that object.

To move an object using dimensions

1. Select the object and click on a dimension line that locates it. An inline text field opens at the location where you clicked.
 - The actual distance displays in the text field.
 - If the dimension is locating two different objects and the selected object is polyline-based, the **Move Edge** and **Move Entire Object** buttons display to the right of the text field.

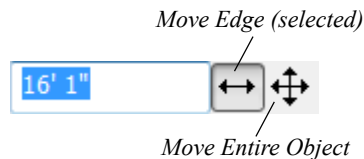

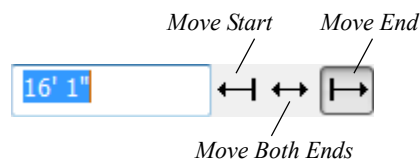

- If the dimension describes a selected wall's length, additional buttons display to the right. See “Using Dimensions” on page 120.



2. Click the **Move** button of your choice.

Dimension Line Specification Dialog

To open the **Dimension Line Specification** dialog, double-click a dimension line using the **Select Objects**  or **Manual Dimension** 

3. Enter a new value in text field.
 - To use a unit other than inches (or mm), include its indicator after the value.
 - To move the selected object past a second object, to its opposite side, enter a negative value.
 - Basic math operations can also be performed in the inline text box, just as they can in dialogs. See “Math Operations in Dialogs” on page 24.
4. The selected object moves or resizes when you press the Enter key or click outside of the text field.

A variety of polyline- and box-based objects can also be resized using dimensions.

To resize an object using dimensions

1. Select the object along the edge that you would like to move. See “Selected Edge” on page 80.
2. Click on a dimension line that indicates its distance from the object's opposite side.
3. In the inline text field, enter a value.
4. Click **Move edge** to move the selected edge only.
5. The selected edge moves, resizing the object, when you press the Enter key.



You can cancel a move or resize operation using dimensions at any time by pressing the Esc key.

Resizing Walls Using Exterior Dimensions

When resizing a structure using dimensions, it is important to work your way around it in one direction. Relocate one wall at a time in succession so that you do not redefine the same dimension more than once.

For more information, see “Measuring Walls” on page 118.

tool, or select a dimension line and click the **Open Object** edit button.

The settings in this dialog are dynamic defaults. See “Dimension Defaults Dialog” on page 147.

Dimension Panel

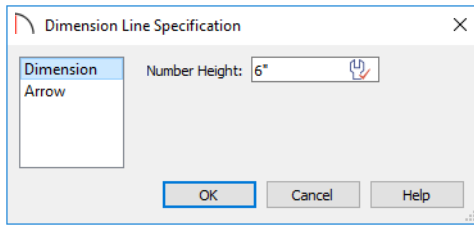

Specify the **Number Height** for the selected dimension. See “Dynamic Defaults” on page 48.

Arrow Panel

For information about the settings on this panel, see “Arrow Panel” on page 103.

The Text Tools help you draw attention to special details of your drawings in plan view.

Text lines with arrow can be attached to text objects, allowing you to direct attention to specific plan details.

Text Defaults



Text Defaults can be accessed by selecting **Edit> Default Settings** in any view in which text can be created. See “Default Settings vs Preferences” on page 47.

The default settings for Rich Text determine what these objects look like when they are first created. Text Style Defaults determine the appearance of text associated with things like dimensions and object labels.

Text Style Defaults

Select “Text Style” from the list in the **Default Settings** dialog and click the **Edit** button to open the **Saved Text Style Defaults** dialog.

The **Text Style Defaults** dialog allows you to specify the attributes of the various Text Styles in use in the current file. See “Text Styles” on page 165.

Chapter Contents

- Text Defaults
- Fonts and Alphabets
- The Text Tools
- Creating Text
- Displaying Text
- Rich Text Specification Dialog
- Editing Text
- Copying and Pasting Text
- Find/Replace Text
- Text Arrows
- Text Styles
- Object Labels



Rich Text Defaults

The **Rich Text Defaults** dialog is similar to the **Rich Text Specification** dialog. See “Rich Text Specification Dialog” on page 159.

Text Lines with Arrows  use the same default layer as Rich Text, so by default they have the same color, line weight and line style. See “Layers” on page 74.

Arrow Defaults

The settings in the **Arrow Defaults** dialog determine the initial settings for arrows drawn using the **Text**

Line with Arrow  and **Line With Arrow**  tools. These settings also determine the initial appearance of arrows when they are added to CAD lines, arcs, and polylines.

The **Arrow Defaults** dialog looks almost the same as the ARROW panel of the **Line Specification** dialog. See “Arrow Panel” on page 103.

 Avoid typing any text in the Rich Text Defaults dialog unless you want it to be present in all text objects you create.

Fonts and Alphabets

Home Designer Suite allows you to use any font found in your computer’s Fonts directory.

Chief Blueprint Font

The Chief Blueprint font is installed in the Windows Fonts directory when Home Designer Suite is installed.

On Mac systems, this font is embedded with the Home Designer Suite installation but not installed on the system. As such, it is available for use in Home Designer Suite but not in other programs.

International Alphabets

The **Rich Text**  tool supports unicode alphabets and characters. In order to use a unicode alphabet or characters, the appropriate language support must be installed on your computer.

Special characters can be added to any **Rich Text**  object by:

- Copying and pasting the character from another application;
- Copying and pasting the character from the Windows Character Map;
- Using the Mac Character Viewer;
- Typing the keystroke associated with the character.

See “Copying and Pasting Text” on page 162.

The Text Tools

 Select **CAD> Text** to access the **Text Tools**. These tools are available in plan view only.

 The **Rich Text** tool is used to create text objects.

Missing Fonts

If you open a plan file that uses a font that is not installed on the current computer, the program will give you an opportunity to replace it in the **Replace Fonts** dialog.

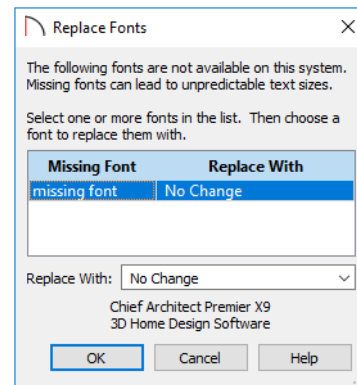

The table lists all missing fonts and how they will be replaced.

- Click on a font name in the list to select it. Use the Shift or Ctrl key to select multiple fonts. See “Shift and Ctrl Select” on page 81.
- Select a replacement font from the **Replace With** drop-down list, or leave “No Change” as the selection to maintain the file’s association with the missing fonts.
- A preview of the selected font displays below the **Replace Width** list.

If you do not plan to return the file to the computer where it was created, you may want to replace missing fonts with the fonts you normally use. On the other hand, if you do intend to return the file, you may prefer to not replace any missing fonts.

 The **Text Line with Arrow** tool is used to connect text and another object with an arrow. See “Text Arrows” on page 164.

 The **Text with Arrow** tool places a Rich Text object with an arrow attached.

Creating Text

Text can be created in plan view only. See “View Windows” on page 61.

Once created, text can be selected and edited in a variety of ways. See “Editing Text” on page 161.

To create Text

1. Select CAD> Text> Rich Text .
2. Click in the drawing area, and the **Rich Text Specification** dialog will open. See “Rich Text Specification Dialog” on page 159.

3. Type or paste the desired text into the Text Field.
4. Use the options to change the font, style and size of any portion of the text.

Note: If you do not type anything in the Text Field, a text object will not be created when you click outside of it.

You can also create lines with arrows connecting the text that you create to items in the drawing. See “Text Arrows” on page 164.

Displaying Text

As with other types of objects, the display of Text objects is controlled in the **Display Options** dialog. All Text objects, including Text Lines with Arrows, are located on the “Text” layer. See “Display Options Dialog” on page 74.

Text objects can only be displayed in plan view.

The display attributes of each individual text object can be controlled independent of the layer it is placed on. See “Rich Text Specification Dialog” on page 159.

Rich Text Specification Dialog



The **Rich Text Specification** dialog opens if you select one or more Text objects, then click the **Open Object** edit button.

This dialog also opens when you select the **Rich Text**  tool and then click once in the drawing area.

When **Text** objects are group-selected, the text content, zoom factor, and Paragraph Options cannot be changed, but everything else can be.

The **Rich Text Specification** dialog is similar to the **Rich Text Defaults** dialog but affects the selected text rather than all subsequently created text objects. See “Text Defaults” on page 157.

Text Panel

The settings on the **TEXT** panel allow you to type the selected Text object’s content and control many aspects of its appearance, including its font, size, color and style.





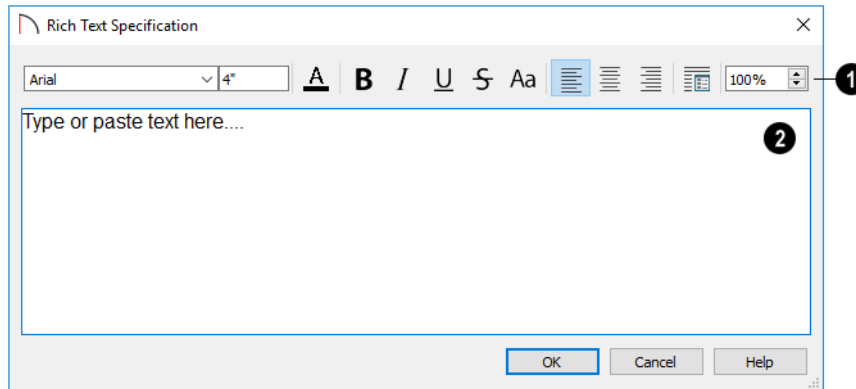

You can specify the appearance of the text before typing, and can also select and change the attributes of all or portions of the text content after it is typed. To change text that already exists, simply highlight it using the mouse and/or the Shift + arrow keys and then make any needed changes to its attributes.





Note: If you do not type anything in the text field on this panel when creating a new object, no object will be created when you click OK. On the other hand, if you remove the text from an existing object and click OK, an empty text box will result.



1 Use the options on the Edit Bar, which displays above the Text Entry field, to change the font, size, and style of the text.

Select the desired options before typing to affect the text as it is typed, or select some or all of the text and then specify which options to apply to it.

- Select a **Font** from the drop-down list.
- Specify the **Text Size** in drawing units.
- Click the **Color**  button to specify the color of the selected or subsequently typed text. See “Select Color Dialog” on page 77.
- Click the **Bold**  button to specify the selected text as bold. The Ctrl+B hotkey can also be used.
- Click the **Italic**  button to specify the selected text as italic. The Ctrl+I hotkey can also be used.
- Click the **Underline**  button to specify the selected text as underlined. The Ctrl + U hotkey can also be used.
- Click the **Strikethrough**  button to specify the selected text as stricken-through.
- Click the **Uppercase**  button to display the selected text in all capital letters.

- Click the **Align Left** , **Align Center** , or **Align Right**  button to specify how the selected text is aligned.
- Click the **Paragraph Options**  button to specify the selected paragraph’s alignment, spacing and bullets or numbering in the **Paragraph Options** dialog.
- Specify the **Zoom** factor of the selected text by typing a percentage value in the text field or clicking the up/down arrows. This setting only affects the text as it appears in this dialog.

Note: Some fonts cannot be drawn at certain zoom factors. When this is the case, the appearance of the text will not change.

- 2** Type or paste text in the Text Entry field. See “Copy, Cut and Paste” on page 162.
- Right-click in the Text Entry field to access a contextual menu from which you can select Undo, Redo, Cut, Copy, Paste and Select All. See “Contextual Menus” on page 23.
- To edit text in the entry field, click and drag to highlight any portion of it and then use the tools on the Edit Bar as needed.

Paragraph Options Dialog

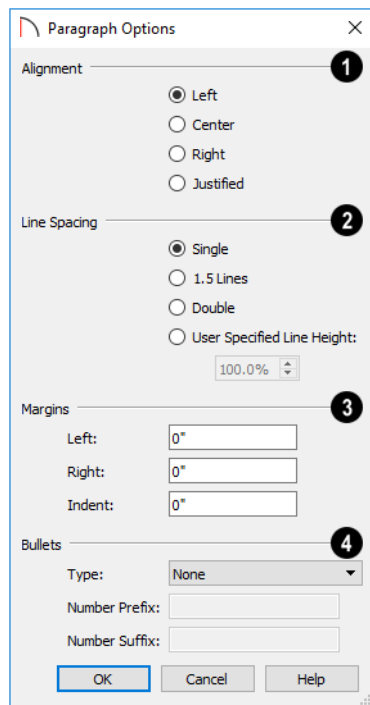

- 1 Specify the **Alignment** of the selected paragraph(s). See “Aligning Text” on page 162.
- 2 Specify the **Line Spacing** of the selected paragraph(s).

- Click the radio button beside **Single**, **1.5 Lines**, **Double** or **User Specified**.
- If you select **User Specified Line Height**, type the desired height in the text field. For best results, this value should be at least as much as the largest text size used in the selection.
- 3 Specify the appearance of the selection’s side **Margins**, as measured in from edges of the text box. Only positive Margin values can be used.
- Specify the **Indent**, which is measured from the left side margin. A negative value can be used if a left Margin has been specified.
- 4 Specify the appearance of **Bullets** and numbering in the selection.
- Select the desired bullet, numbered, or lettered **Type** from the drop-down list.
- Specify the **Number Prefix**, which are any characters that you would like to display before the number or letter. Does not affect paragraphs using circle or square bullets.
- Specify the **Number Suffix**, which are any characters that you would like to display after the number or letter and before its actual text. Does not affect paragraphs using circle or square bullets.

Editing Text

Once created, **Rich Text**  objects can be selected individually or as a group and edited using the edit handles and the edit toolbar buttons. Individual text objects can also be edited in the **Rich Text Specification** dialog. See “Rich Text Specification Dialog” on page 159.

Editing Text Attributes

Most text attributes, including the font, size, style, and the content itself, are edited in the **Rich Text Specification** dialog.

In order to edit the attributes of an existing **Rich Text**  object, you must select some or all of the text before making changes. See “Text Panel” on page 159.

To edit Text attributes

1. Select a **Rich Text**  object and click the **Open Object**  edit button.

2. On the **TEXT** panel of the **Rich Text Specification** dialog, click and drag to select some or all of the text typed into the Text field.

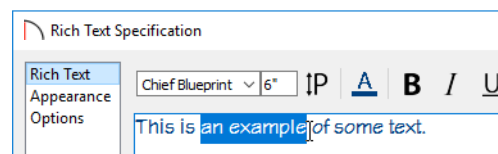

3. With some or all of the text selected, change any of the attributes available along the top of the panel, including the font, size, color, and style.

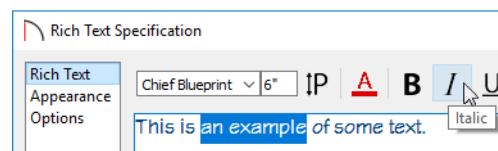

4. As changes are made, the selected text updates. Only the selected text is modified.

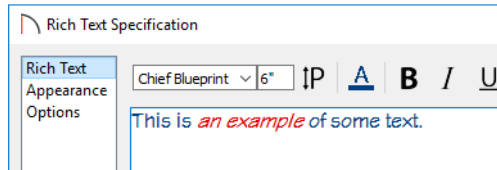

Using the Mouse

A selected **Rich Text**  object has the same edit handles as other box-based objects. See “Editing Box-Based Objects” on page 89.

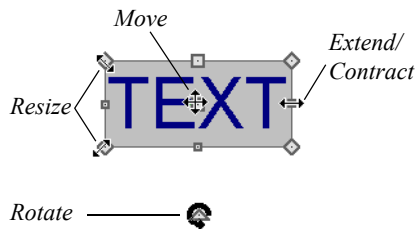

As a text box’s width is made narrower or wider using an edit handle, its height may increase or decrease so that none of the text becomes hidden. The opposite is not true, however: a text box’s height cannot be resized smaller than the height of the rows of text it currently contains.

Using the Edit Tools

A selected **Rich Text**  object can be edited in a variety of ways using the buttons on the edit toolbar. See “The Edit Toolbar” on page 23.

Resizing Text

The default character height of **Rich Text**  objects can be specified as can the character height for individual objects, in their specification dialogs. See “Text Defaults” on page 157.

Copying and Pasting Text

The Copy, Cut and Paste commands use the system clipboard, making it possible to transfer text between text objects, between Home Designer Suite files, from a plan into another application such as a text editor or spreadsheet program, or vice versa. See “Copying and Pasting Objects” on page 70.





All or selected portions of the Materials List can also be copied and pasted into a text object, as well as into a word processing or spreadsheet program. See “Materials Lists” on page 377.

Scaling Text

As with the size of other objects, text size is subject to the current drawing scale specified in the **Page Setup** dialog. See “Drawing Sheet Setup Dialog” on page 384.

Aligning Text

Text can be aligned in a couple of ways.

- The text content of a text object can be aligned to the left, right, center or justified in the **Rich Text Specification** dialog. See “Text Panel” on page 159.
- The text content of a text object can be also be aligned by clicking the **Align Left** , **Align Right** , **Center** , or **Justify**  edit button.

Copy, Cut and Paste

Copy, Cut and Paste of text into and out of the **Rich Text Specification** dialog can be accomplished using keyboard hotkeys:

- Press Ctrl + X to Cut the selected text and save it to the system clipboard.
- Press Ctrl + C to Copy the selected text and copy it to the system clipboard.
- Press Ctrl + V to paste your last cut or copied selection in a new text object.

For more, see “Copying and Pasting Objects” on page 70.

Copy, Cut and Paste use the system clipboard, making it possible to transfer text between text objects, between Home Designer Suite files, from a plan into another application, or vice versa.

Cut, Copy, and Paste can also be accessed from the Edit menu of many applications, including Home Designer Suite. These menu commands are not available when the text specification dialogs are open, but you can use the associated hotkeys.

To Copy, Cut and Paste text

1. On the **TEXT** panel of either text specification dialog or in another program altogether, highlight the text you wish to cut, copy or paste.

2. Press Ctrl + X to **Cut** the selected text out of its original location and save it to the system clipboard.
3. Press Ctrl + C to **Copy** the selected text to the system clipboard without removing it from its original location.
4. Open the text object or a file in another application and click to place your cursor in the Text field, writing area, or spreadsheet cell.
5. Press Ctrl + V to **Paste** the copied text at the location of your cursor.

Bear in mind that when text is copied and pasted, its formatting is not always retained. The results depend on the program or type of text object in which the content was created as well as the type of text object into which it is pasted.

Find/Replace Text

The **Find/Replace Text** tools help you make sure that the text in your files is current and correct.

Find/Replace Text locates text in Rich Text schedule titles and headings, and custom labels for objects and rooms. It does not locate text in automatic object labels, default room labels, suppressed labels or the Materials List, however.

Find/Replace Text



Select **Edit> Find/Replace Text** to find a particular word or string of text in your plan file and replace it if you wish.

Pasting into Rich Text



Text pasted into a **Rich Text** object from another source will retain most - but not necessarily all - of its custom formatting. If a line of text is sufficiently long, however, it may be wrapped automatically when pasted into Rich Text.

Text pasted into a **RichText** object from a spreadsheet program retains basic column and row information. Column width cannot be adjusted; however, as you add or remove text from a cell, row height will increase or decrease to accommodate your changes.

Pasting into a View

Text can also be pasted directly into a plan or elevation view. When you use the Paste command, a new Rich Text object is created, the text is pasted into that object, and it is selected. In order to see the new object, you may need to Fill Window.

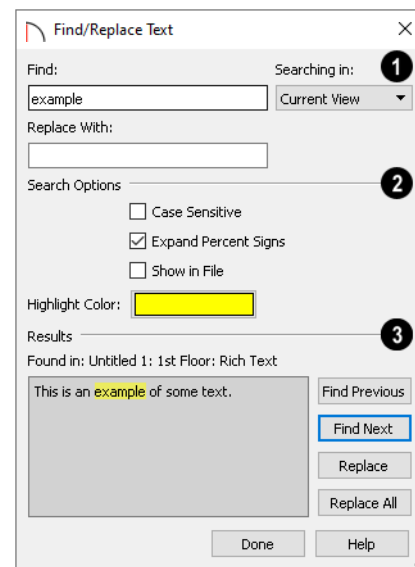

1 Find and Replace -

- Type the string of text that you want to **Find** in the text field.
- Type the string of text that you want the text you find to be **Replaced With**.
- Select the scope of your search from the **Searching In** drop-down list. Choose “Current View”,

“Current File”, “All Open Files” or “Selected Objects”.

- 2 The **Search Options** allow you to refine your search.
 - Check **Case Sensitive** to distinguish between capitalized and lowercase letters when searching. When unchecked, capitalization is ignored while searching. The Replace function is always case sensitive.
 - When **Expand Percent Signs** is checked, the program will ignore strings of one or two % signs in a row, which may be used to mark up imported text with style commands. Uncheck this to find individual % signs in the search results.
 - Check **Show in File** to open a new view window or go to a new layout page and highlight the object associated with the current search Result. When unchecked, the current search Result will only be highlighted if it is located in the current view window. See “Working in Multiple Views” on page 61.
 - Click the **Highlight Color** button to specify the color used to highlight the object associated with

the current search Result. See “Select Color Dialog” on page 77.

- 3 The current search **Results** are shown for reference in the field on the left. The location of the associated object, including file name, view name, and its object type is stated above the Results field as well. Click a button to perform the associated action:
 - Click **Find Previous** to find the previous search Results.
 - Click **Find Next** to search for additional Results.
 - Click to **Replace** the current search Results with the replacement specified above.
 - Click to **Replace All** instances of the current search Results found throughout the Searching In scope, selected above.

 Although the Find options do not locate text in suppressed labels, Replace All will replace that text. See “Displaying Labels” on page 166.

Text Arrows

Text arrows, which are simply CAD lines with arrows drawn on the “Text” layer, can be used to connect text objects to details of interest in your drawing. See “Draw Lines” on page 101.

When a selected Text Line with Arrow is snapped to an object on either end, its end edit handle will display the Selected Edge Handle Fill color. See “Colors Panel” on page 51.

Text arrows can be snapped together to form open or closed polylines. If two lines with arrows meet within the bounding box of a text object, however, they will not join. This allows you to attach multiple, separate text arrows to a single text object. See “Editing Line-Based Objects” on page 82.

Lines with arrows can be independent or attached to other objects. If an attached object is moved, the end of the Line with Arrow will move, as well. Arrows attach to closed polyline-based objects along their edges, but can attach to Text or an architectural object anywhere within its bounding box in plan view.

If an arrow is attached to text or another object, deleting either the text or the object will also delete the arrow.



Text with Arrow

 The **Text with Arrow** tool places a text object with an arrow already attached. This arrow can be selected and edited like any other arrow.

Text Line with Arrow

 **Text Lines with Arrow** can be attached to text, CAD and architectural objects by selecting **CAD> Text> Text Line with Arrow** and then clicking and dragging to draw a line. There is no limit to the number of text lines with arrows that can be attached to an object.

The endpoints of **Text Lines with Arrows**  can be joined to form polylines with corners that can be adjusted using the edit handles. See “Polylines” on page 105.

A **Text Line with Arrow**  behaves like a **Line With Arrow**  with one exception: Text Lines with Arrow are initially placed on the “Text” layer, not the “CAD, Default”. See “Layers” on page 74.

Auto Position Arrows

Auto Positioning helps prevent a **Text Line with Arrow**  from crossing over the text object it is attached to by snapping the end of the line to the midpoint of the text box's nearest edge. If the text object or the line's arrowhead is moved, the location of the tail end will update as needed so that it snaps to the nearest edge's midpoint. This behavior only occurs when the end of a line with arrow is snapped an Auto Position location: if it is snapped to a different point on the text, the tail end will not move.

The following image illustrates the behavior of Auto Positioning. When the head of the line with arrow is

moved, the tail of the arrow snaps to different Auto Position locations on the text object, maintaining its connection.

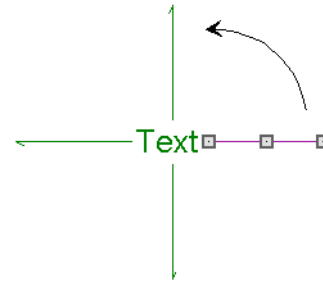

Text Styles

In Home Designer Suite, a Text Style is a set of attributes assigned to any object that displays text, such as Dimensions and object labels.

Note: Because of its ability to use multiple attributes in the same object, Rich Text does not use Text Styles. See "Rich Text Specification Dialog" on page 159.

There are three Text Styles in Home Designer Suite. You can edit these Text Styles to suit your needs in the **Text Style Defaults** dialog

- The Default Label Style affects the appearance of labels for objects such as doors and windows;
- The Default Text Style controls the appearance of legacy Text objects, and dimension line labels, unless specified otherwise.
- The Default Room Style controls the appearance of room labels.

Text Style Defaults



Select **Edit > Default Settings**, click on "Text Styles" and click **Edit** to open the **Text Style Defaults** dialog. The **Saved Text Style Defaults** dia-

log will open, allowing you to select which Saved Text Style Defaults you would like to edit.

Saved Text Style Dialog

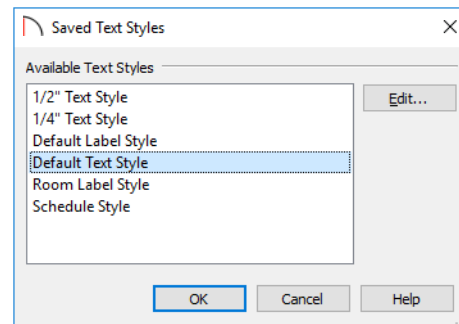

- Select the **Name** of a Text Style from the list.
- Click the **Edit** button to open the defaults dialog for the selected Text Style so that you can edit it.
- Click **OK** to close the **Saved Text Style Defaults** dialog and save any changes you made in the defaults dialog(s). Any changes made to a given Text Style will be applied to all objects in the current plan that are set to use that Text Style.
- Click **Cancel** to close the **Saved Text Style Defaults** dialog without saving any changes that you may have made in the defaults dialog.

Text Style Panel

The **TEXT STYLE** panel is found in various specification and defaults dialogs in the program.

The settings on this panel are also found in the **Text Style Defaults** dialog, where they affect all objects using that style rather than a single selected object.

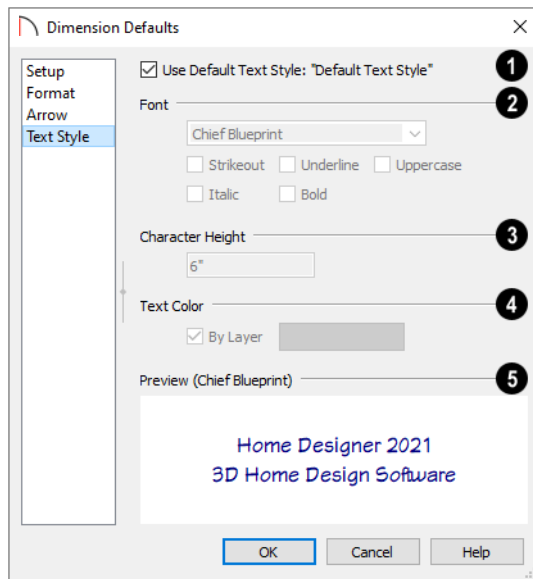

- 1 Check **Use Default Text Style** to use the default style for the selected object type, or uncheck this box to enable the settings below and define a custom style.

The settings that follow are only editable when **Use Default Text Style** is unchecked. When it is checked, information about the Text Style that is assigned to the selected object displays for reference.

Object Labels

Object labels can display in plan view for a variety of different object types.

- Automatic Labels provide basic information about the object, such as its type, size, or name.
- You can create a custom label for an object in its specification dialog using text. See “Label Panel” on page 166.

Automatic Labels

Most objects that can display labels have an Automatic Label created by the program that states basic information about it. When **Automatic Labels** is selected in the object’s specification dialog, this is usually the label that will be used; however:

- If a user-defined label is specified in the object’s defaults dialog, that label will be used instead of the Automatic Label.

Label Panel

The LABEL panel is found in the specification and

- 2 Specify the attributes of the selected Text Style’s **Font**.

- Select a font from the drop-down list.
- The text styles **Bold**, **Underline**, **Italic**, **Strike-out**, and **Uppercase** are available. Check any of the boxes to apply that style.

- 3 Specify the **Character Height** of text using the selected Text Style.

- Enter the **Character Height** in drawing units. This height is subject to the current drawing scale.

- 4 Specify the selected Text Style’s **Text Color**. When Use Custom Text Style is not selected above, a Text Color does not display here for reference.

- When **By Layer** is checked, text uses the line color assigned to the layer that the object it is assigned to is located on. See “Layer Attributes” on page 74.

- Uncheck **By Layer**, then click the **Color** bar to select a different color. See “Select Color Dialog” on page 77.

- 5 A preview of the Text Style currently assigned to the selected object displays here.

- Fixtures and appliances inserted into cabinets do not have labels of their own.

Displaying Labels

-  The display of object labels can be controlled by layer in the **Layer Display Options** dialog. Label layer names begin with the object type, followed by the word Label: for example, cabinet labels are located on the “Cabinets, Labels” layer. See “Display Options Dialog” on page 74.

You can choose to suppress the label for an individual object on the LABEL panel of its specification dialog.

Object labels use the “Default Label Style” Text Style. See “Text Styles” on page 165.

defaults dialogs for a variety of different objects.

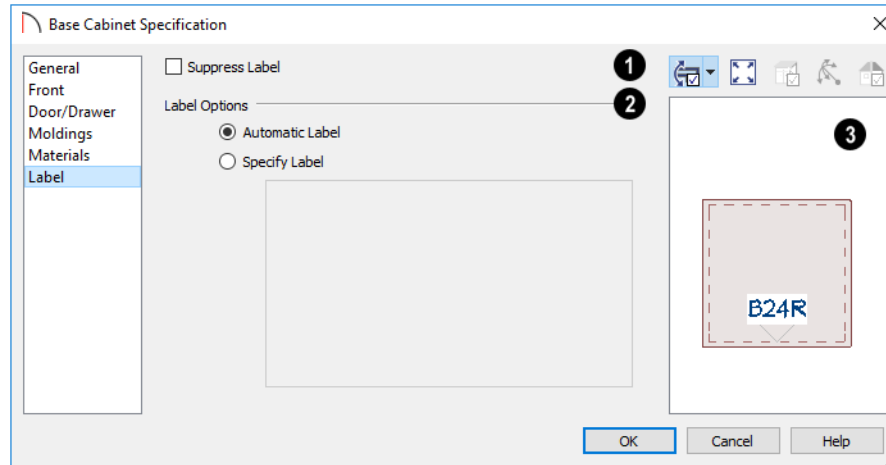

- 1 Most objects have a **Suppress Label** option. Check this box to prevent the selected object's label from displaying in plan view.

Bay, Box and Bow Windows and Mullied Window units have several settings for controlling **Multiple Component** labels. See "Window Labels" on page 187.

- Select **Suppress All Labels** to display no label in plan view. Individual components are counted in the Materials List.
- Select **Show Component Labels** to produce labels for each component in plan view. Individual components are counted in the Materials List.
- Select **Show Single Label for Entire Unit** to produce one label for the unit and suppress component labels. When this option is selected, the settings that follow become enabled.

These settings also affect how Bay, Box and Bow Windows and Mullied Window units are counted in

the Materials List. See "Window Labels" on page 187 and "Displaying Mullied Units" on page 186.

- 2 The **Label Options** control what information is contained in the label. See "Displaying 3D Views" on page 307.

- Select **Automatic Labels** to use the default label for the selected object. See "Automatic Labels" on page 166.
- Select **Specify Label** to replace the selected object's Automatic Label with whatever you type in the text field below. When Specify Label is chosen, the selected object's Automatic Label initially populates the text field.

- 3 In most specification dialogs, a preview of the selected object displays here. Labels can be seen in Plan View only. See "Dialog Preview Panes" on page 25.

Doors

Home Designer Suite comes with tools for creating a wide variety of interior and exterior doors. In addition, the library offers a large selection of specialty doors and doorways including hinged, sliding, pocket, bifold, and garage doors. Additional name-brand door catalogs are also available for download from our web site, HomeDesignerSoftware.com.

Door Defaults



There are several defaults dialogs for doors. Default Settings are accessed by selecting **Edit> Default Settings**. Click the arrow next to “Doors” to expand the category. Select a subheading and click the **Edit** button to open the defaults dialog associated with your selection.

The **Door Defaults** dialogs look nearly the same as the **Door Specification** dialog. See “Door Specification Dialog” on page 176. There are only a couple of differences:

- Since default settings are specified here, “Use Default” is not an option for some settings as it is in the **Door Specification** dialog.
- The **Door Type** cannot be changed in the Defaults dialogs.

Door Tools



To place a door, select the type you want from the **Build> Door** submenu. Move your mouse

- ### Chapter Contents
- Door Defaults
 - Door Tools
 - Displaying Doors
 - Editing Doors
 - Changing Door Swings
 - Special Doors
 - Door Specification Dialog

Because Hinged and Sliding Doors are often used in both interior and exterior applications, they have both Interior and Exterior Door Defaults.

Interior vs Exterior Doors

Regardless of its **Door Type** or the tool used to create it, a door will be:

- An Interior Door if it is placed into a wall that separates two interior rooms;
- An Exterior Door if it is placed into a wall that separates an interior room from either an exterior room or the building’s exterior. See “Room Types” on page 132.

This rule applies to doors copied and pasted from one location to another just as it does to those created using the Door Tools.

pointer over a wall section. When a preview outline can be seen, click to place a door at that location.

The minimum initial size for doors varies by Door Type. For example, If there is room enough along the wall to fit a 12” (300 mm) wide Hinged Door, a preview outline will display and a door can be placed. Garage doors, in contrast, must initially be at least 6’ (1800 mm) wide.

Doors can be placed in both straight and curved walls, as well as span across straight, collinear wall segments.

A newly created door inherits the settings in the **Door Defaults** dialog for its door type. Once created, doors can be edited in a variety of ways. See “Door Defaults” on page 169.

Doors cannot be placed in a wall specified as Invisible. See “Room Dividers and Invisible Walls” on page 113.

Once placed, any door may be changed into any other type of door in the **Door Specification** dialog. See “General Panel” on page 177.

Hinged Doors



Select **Build> Door> Hinged Door** and click on a wall to place a hinged door at that location. Hinged doors have separate defaults for interior and exterior doors. By default, a hinged door becomes a double door when its width is four feet (1200 mm) or greater.

The initial swing direction of a hinged door depends on the location of the mouse pointer relative to the wall when you click. The door will swing towards the side of the wall that you click nearest.

The initial hinge side of a hinged door can be set by clicking to place the door and then holding the mouse button down rather than releasing it. Move the mouse toward the end of the door that you would like the hinges to be on: as the mouse pointer nears either end, the door preview’s hinge side will move to that end. You can also adjust the door’s swing direction in this manner. When the swing direction and hinge side are correct, release the mouse button.

Doorways



Select **Build> Door> Doorway** and click on a wall to place a doorway. Doorways are simply openings without a door and can be placed in interior and exterior walls, railings, and fences. You can assign a door from the library to a doorway if you wish.

Sliding Doors



Select **Build> Door> Sliding Door** and click on a wall to place a sliding door. Sliding doors have separate defaults for interior and exterior doors: interior sliding doors are typically solid while exterior sliding doors are Glass Panel doors.

The initial opening side of a sliding door can be specified by moving the mouse pointer along the wall while the mouse button is still pressed.

Pocket Doors



Select **Build> Door> Pocket Door** and click on a wall where you want to place a pocket door.

As with sliding doors, the initial opening side of a pocket door can be specified by moving the mouse pointer along the wall while the mouse button is still pressed.

By default, a pocket door becomes a double pocket door if its width is four feet (1200 mm) or greater.

Bifold Doors



Select **Build> Door> Bifold Door** and click on a wall where you want to place a bifold door.

Like a hinged door, the initial opening side of a bifold door depends on the location of the mouse pointer relative to the wall when you click. The door will open towards the side of the wall that you click nearest.

Similarly, the initial hinge side of a bifold door can be specified by moving the mouse pointer along the wall while the mouse button is still pressed.

By default, a bifold door becomes a double bifold if its width is greater than three feet (900 mm).

Garage Doors



Select **Build> Door> Garage Door** and click on a wall to place a garage door.

In plan view, dashed lines show the size and location of the garage door when open.

Garage doors will build into a garage stem wall provided the room is designated as a garage before the door is inserted. See “Room Types” on page 132.

Fixed Door



Select **Build> Door> Fixed Door** and click on a wall to place a fixed door.

Barn Door



Select **Build> Door> Barn Door** and click on a wall to place a surface mounted sliding door, sometimes referred to as a barn style door.

Shower Door



Select **Build> Door> Shower Door** and click on a wall to place a hinged glass slab shower door.



Place a Shower Door in a Straight Glass Wall. See “Wall Tools” on page 110.

The Doors & Doorways Library Catalog



The Doors & Doorways library catalog can be accessed by selecting **View> Library Browser** and browsing to Home Designer Core Catalogs> Architectural> Doors and Doorways. This catalog contains a variety of interior and exterior doors, as well as special entryways and wrapped openings.

Entryways and wrapped openings are examples of Doorways, which are wall openings that do not have doors within them.



To add a door to the Doorway, select a **Door Type** other than “Doorway” from the drop-down list in the **Door Specification** dialog. See “General Panel” on page 177.

You can also select a door from the library and place it into a doorway in plan view or any 3D view.

To place a library door in a doorway

1. Go to plan view or any 3D view.
2. Open the Library Browser.
3. Browse or search to find a door style that suits your needs.
4. Select the door in the Library Browser, then click on the doorway to place the selected door within it. If a door already exists, it is replaced.
5. Continue clicking other doorways as needed.

Displaying Doors



The display of doors and door labels is controlled in the **Display Options** dialog. See “Display Options Dialog” on page 74.

Doors can only be placed in walls, so if a wall’s layer is turned off in plan view, any doors placed in that wall will not display, either. Doors can display independent of their containing walls in 3D views, however. See “Displaying Walls” on page 117.

If the “Doors” layer is turned off, doors and their casing do not display but openings in the walls where they are located are visible.

In Plan Views

A door’s jamb, and swing are all represented in plan view. A threshold line will display across a door opening in plan view when the door:

- Is located in an exterior wall. See “Exterior and Interior Walls” on page 112.

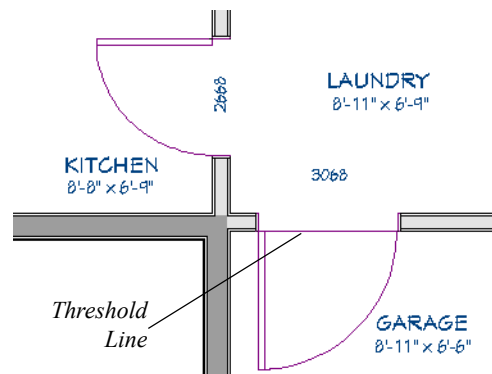

- Opens to an exterior room such as a Garage or Deck. See “Room Types” on page 132.
- Is located between rooms with different floor heights. See “Stepped Floor and Ceiling Platforms” on page 139.



If an exterior door to a Garage room on Floor 1 extends into a Garage stem wall or curb on Floor 0,



its location will be indicated on Floor 0. See “Garages” on page 224.

In 3D Views

You can specify whether a selected door is shown open or closed in 3D views by clicking the **Show Door Open in 3D**  and **Show Door Closed in 3D**  edit buttons as well as in the **Door Specification** dialog. See “General Panel” on page 177.

If a door is set to display open in 3D, the angle of the open door can be changed using the edit handles in plan view. See “Using the Mouse” on page 172.

Editing Doors

Before a door can be edited, it must be selected. To select a door, click it when the **Select Objects**  tool or any of the **Door Tools**  are active. Doors and/or windows can also be group selected and edited. See “Selecting Objects” on page 79

Blocked units are made up of individual doors and windows that have been grouped together to act as one object. You can create what is essentially a blocked door unit by assigning a library door to a doorway from the library.

Select a blocked unit by clicking on it in any view. To select a door that is a component of a blocked unit, click at the location of the component in question, then click the **Select Next Object**  edit button. See “Selecting Objects” on page 79.

In the Specification Dialog

 The most precise method of editing a door or group of doors is to use the **Door Specification** dialog. Door type, size, casing, materials, and more can all be specified in this dialog. See “Door Specification Dialog” on page 176.

Using the Mouse

In plan view, click either of the two end handles and drag along the wall to change the width. The label showing the size updates as the handles are dragged. Click and drag the Move handle at the center to move

You can specify whether an exterior door has a threshold in the **Door Specification** dialog. See “Casing Panel” on page 179.

Door Labels

Door labels display in floor plan view, centered on the doors they represent, when the “Doors, Labels” layer is turned on and use the “Default Label Style” Text Style. See “Object Labels” on page 166.

Door labels indicate Width and Height. For example:

- In Imperial plans, the label for a 3’-0” wide, 6’-8” high double hung window will read 3068.
- In metric plans, the label for a 900 mm wide, 2100 mm high double hung window will read 900x2100.

the door along the wall it is placed in. Use the triangular Rotate handle to adjust the door’s swing.

In 3D views, a selected door has five edit handles: the Move handle at the center and a Resize handle on each edge. Click and drag an edge handle to resize the door.

A door or window moved against an intersecting wall temporarily stops when the casing meets the intersecting wall. You can continue to drag and it resumes movement past the intersecting wall.



Using Dimensions



 Like various other objects, doors can be moved using dimensions. See “Moving Objects Using Dimensions” on page 154.

By default, dimensions locate the sides of doors. Once a dimension line has been drawn, you can move or add its extension lines to locate the center of a door. See “Editing Extension Lines” on page 152.

Using the Edit Tools

A selected door or doors can be edited in a variety of ways using the buttons on the edit toolbar. See “The Edit Toolbar” on page 23.

- Click the **Change Opening/Hinge Side**  edit button to change the side of the door that its hinges are on. See “Changing Door Swings” on page 173.
- Click the **Change Swing Side**  edit button to change which direction the selected door swings.

- Click the **Show Door Open in 3D**  or **Show Door Closed in 3D**  edit button to control the selected door's appearance in 3D views. See “In 3D Views” on page 172.
- Click the **Gable Over Door/Window**  to create a gable over the selected door(s) the next time the roof is rebuilt. See “Gable Over Door/Window” on page 258.

Centering Doors

 The **Center Object** edit button allows you to center a selected door along a wall within a room or relative to a cabinet or window. See “Using Center Object” on page 94.

To center a door along a wall



1. Select a door or combination of windows and doors in plan view.
2. Click the **Center Object**  edit button then choose from one of the following options:
 - Click near a wall inside a room to center the door along that wall in that room.
 - Click outside the house (on the exterior room) near an exterior wall to center the door along an exterior wall.

Door Style and Panels

There are a number of Door Styles available for use, including Slab, basic Panel, and Louvered. In addition, a selection of door panel symbols is available in the Library. See “Placing Library Objects” on page 281.

You can specify whether a selected door is a Single or Double Door, or whether its panel number is determined automatically by its width in the **Door Specification** dialog. See “Options Panel” on page 178.

Changing Door Swings

  Door swing direction and hinge side can be changed using the edit handles and the **Change Opening/Hinge Side** and **Change Swing Side** edit buttons.

Door Sides

Like walls, all doors have two sides: an interior side and an exterior side. This is the case even for doors placed in interior walls. See “Exterior and Interior Walls” on page 112.

By default, the interior side of the door will face the direction that the door swings to open. If you prefer, you can specify that the interior side face the opposite direction in the **Door Specification** dialog. See “General Panel” on page 177.

You can specify the materials for the two sides separately in the **Door Specification** dialog. See “Materials Panel” on page 181.

You can also specify different casing for the interior and exterior sides of exterior doors - that is, doors placed in exterior walls or walls defining a Garage or other exterior room type. See “Room Types” on page 132.

Door Casing

Doors typically feature casing, or trim, on both sides of the wall opening. See “Applying Moldings” on page 268.

- By default, interior doors use the same casing profile on both sides. You can specify that both sides be edited separately in the **Door Specification** dialog. See “General Panel” on page 177.
- Exterior doors can have different casing profiles on their interior and exterior sides.

The default casing for interior and exterior doors is a basic rectangular stock profile. You can specify a door's casing profiles in the **Door Specification** dialog, or you can choose to suppress casing altogether. See “Casing Panel” on page 179.

Door Hardware

Handles, locks, and hinges can be assigned to a door in the **Door Specification** dialog. See “Hardware Panel” on page 180.

The **Change Opening/Hinge Side**  edit button is available for all doors except double doors and garage doors.

The **Change Swing Side**  edit button is available for all doors except pocket doors.

Hinged Doors

In addition to using the edit buttons, Hinged Doors and Shower Doors' hinge side and swing direction can be changed using the triangular Rotate edit handle.

To adjust the angle of swing:

1. In plan view, select the door and grab the triangular handle.
2. Drag to change the amount of swing.

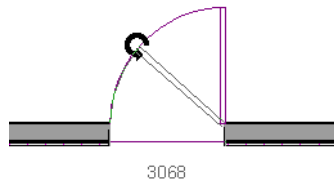

3. Release the mouse.

If you drag near the closed position, the door snaps to a closed position.

To change the swing using edit handles:

1. In plan view, select the door and grab the triangular edit handle.

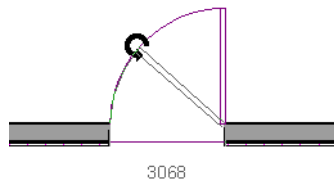

2. Drag the pointer along the path of the new arc to change the hinge side and/or swing direction.

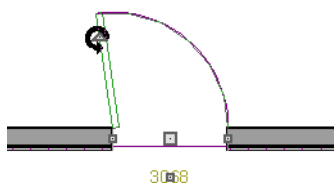

3. Release the mouse.

To change the swing using edit buttons:

1. In plan view, select the door.
2. To change the hinge side, click the **Change Opening/Hinge Side**  edit button.

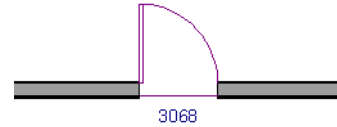
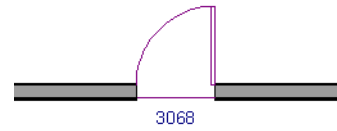

3. To change the swing direction, click the **Change Swing Side**  edit button.

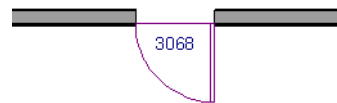
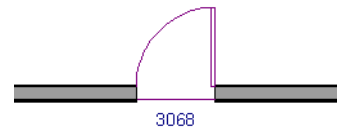

Sliding Type Doors

Sliding, Pocket, Bifold, and Barn Doors are types of sliding door.

Similar to hinged doors, the Opening/Hinge and Swing sides of a Sliding, Pocket, Bifold, or Barn Door can be changed by clicking and dragging its diamond-shaped edit handle.

To change the side of a Sliding, Pocket, Bifold or Barn door that opens, select the door and click the

Change Opening/Hinge Side  edit button.



Note: For a Pocket Door to change Opening Side, there must be enough room for the entire door to fit in the wall on that side.

To flip the fixed and moving sides of the door, click the **Change Swing Side**  edit button.

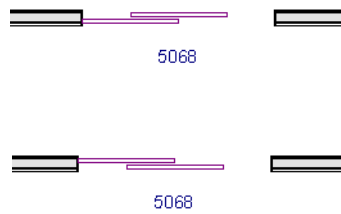

Garage Doors

To change the side of a garage door that it faces, select it and click the **Change Swing Side**  edit button.

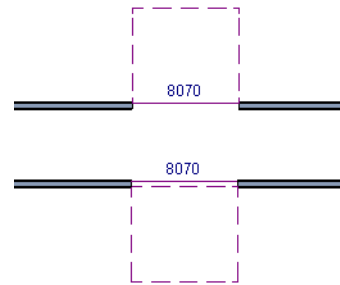

Unlike other door types, the Swing side of a garage door cannot be modified using the edit handles.

Special Doors

A variety of special doors and doorways can be created in Home Designer Suite.

Transoms Above Doors

Transom windows above doors are created the same as other stacked windows. See “Grouped Windows” on page 186.

Wrapped Openings

Wrapped openings of various shapes are available in the **Doors & Doorways Library**.

You can also create a wrapped opening by unchecking **Use Interior Casing** and/or **Use Exterior Casing** in a Doorway’s **Door Specification** dialog. See “Casing Panel” on page 179. If base molding is present, it will wrap around the opening.



Openings in Railings

Use the **Doorway**  tool to open a railing for a stairway or other access.

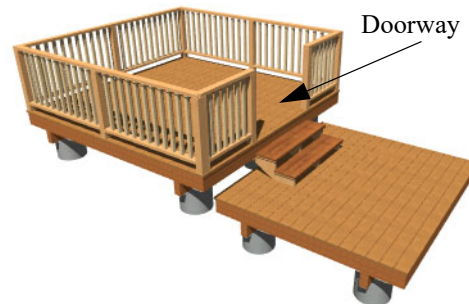

To open a railing across an entire section, resize the doorway’s **Width** so that it is greater than the length of the railing in the **Door Specification** dialog. The opening resizes to the maximum width possible for that space. See “General Panel” on page 177.



To add a gate, specify the doorway’s **Door Type** as a Door, then choose an appropriate gate as the **Door Style**. A selection of gates is available in the Fences & Railings library folder. See “Placing Library Objects” on page 281.

Creating a Doorway with a Railing



When a railing is specified as **No Room Def**, it can be positioned within a **Doorway** .



To create a doorway with railing

1. Place a **Doorway**  at the desired location in your plan.
2. Select **Build> Railing and Deck> Straight Railing** , then click and drag to draw a railing parallel to the wall with the doorway.
3. Select the railing, then use the Resize edit handles to adjust the length of the railing as needed. See “Using the Edit Handles” on page 82.
4. With the railing selected, click the **Open Object**  edit button.

Door Specification Dialog

 To open the **Interior** or **Exterior Door Specification** dialog, select a door or group of doors and click the **Open Object** edit button or double-click on a door using the **Select Objects**  or any **Door**  tool.

5. On the **GENERAL** panel of the **Railing Specification** dialog, check **No Room Def** and click **OK**. See “General Panel” on page 125.
6. With the railing still selected, **Ctrl + drag** it into position within the doorway. See “To move an object freely” on page 93.

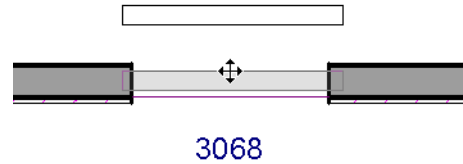

Positioning a railing in a doorway

Placing a Gable Over a Door

 Click the **Gable Over Door/Window** edit button to produce a gable roof over the selected door(s) the next time automatic roofs are built. See “Gable Over Door/Window” on page 258.

You can manually edit or delete this gable line at any time. Your changes take effect when the automatic roofs are rebuilt. This can also be used with group selected doors.

Whether a selected door is Interior or Exterior depends on where it is placed. See “Interior vs Exterior Doors” on page 169.

General Panel

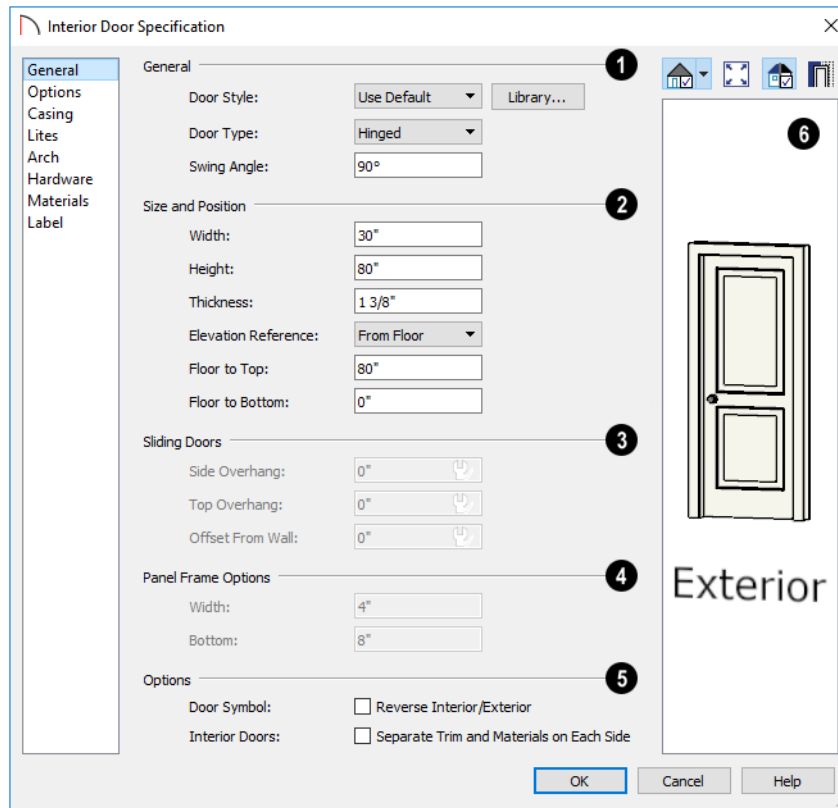

1 General -

- **Door Style** - Select Slab, Glass Slab, Panel, Glass Panel, Louvered, or Glass Louver from the drop-down list; select a style from the Library; or choose “Use Default” to use the default door style set in the **Door Defaults** dialog. See “Door Defaults” on page 169.
- Select “Library” from the drop-down list or click the **Library** button to choose a door symbol from the library. Once a library door is selected, its name is added to the Door Style list. See “Select Library Object Dialog” on page 283.
- Specify the **Door Type** as Doorway, Hinged, Sliding, Pocket, Bifold, Garage, Fixed, Barn, or Shower. In the Door Defaults dialogs, the Door Type cannot be changed.
- Specify the **Swing Angle** of the selected door in plan view, between 0° and 180°. An angle of 0° displays the door as closed and an angle of 180° displays it as wide open. The Swing Angle for Bifold doors and double doors that swing from the center can be no more than 90°.

The Swing Angle also affects the door’s appearance in 3D views if **Draw Closed** is unchecked on the **OPTIONS** panel.

2 Specify the **Size and Position** of the selected door.

- Specify the **Width, Height, and Thickness** of the door.
- Select the **Elevation Reference** from the drop-down list. This determines where the next two settings are measured from and also affects their labels.
- Specify the height **to Top**, measured from the selected Elevation Reference to the top of the door frame.
- Specify the height **to Bottom**, measured from the selected Elevation Reference to the bottom of the door frame.

3 The **Sliding Doors** settings are available for Slider, Pocket, and Barn Doors.

- Specify the **Side and Top Overhang** values, which control how much the selected door extends past its wall opening. Only available for Barn Doors.

- Specify the **Offset from Wall**, which is how far the selected door is offset from its default location. Slider and Pocket Doors are centered in the wall's Main Layer by default, while Barn Doors are positioned against the wall surface.
- ④ **Panel Frame Widths** - Specify the dimensions of the selected door's rails and stiles. Only available for Glass, Panel, and Louvered doors.
 - Specify the **Width** of the stiles and top rail.
 - Specify the height of the **Bottom** rail.
- ⑤ **Options** -
 - Check **Reverse Interior/Exterior** to reverse the two sides of the selected door so that they face the

opposite direction. Only available when a door symbol from the Library is specified as the Door Style. See "Door Sides" on page 173.

- Check **Separate Trim and Materials for Each Side** to specify the casing, lintels, and all materials for each side of the selected interior door independently. When unchecked, the two sides of the door use the same trim and materials. Only available when the selected door is placed in an interior wall. See "Exterior and Interior Walls" on page 112.

- ⑥ A preview of the door displays on the right side of the dialog box. A label indicates which side of the door is its Interior and which is its Exterior. See "Dialog Preview Panes" on page 25.

Options Panel

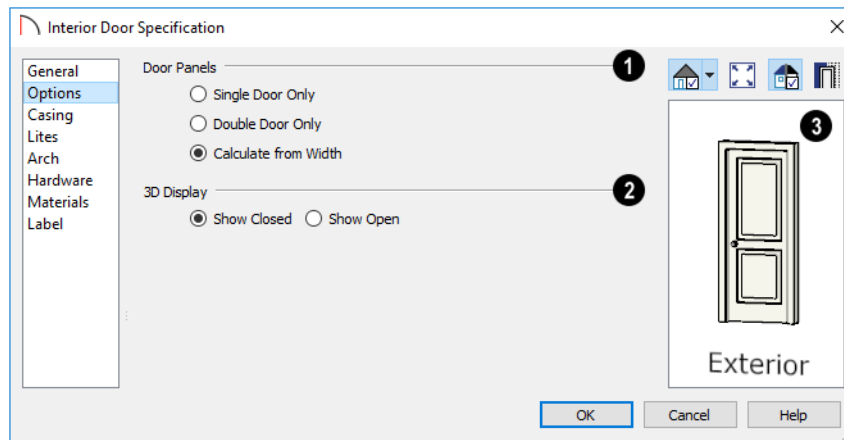

- ① Specify the number of **Door Panels** or sections that the selected door has. See "Door Style and Panels" on page 173.
 - Select **Single Door Only** to force the selected hinged, pocket or bifold door to be a single door, regardless of its width.
 - Select **Double Door Only** to force the selected hinged, pocket or bifold door to be a double door, regardless of its width.
 - Select **Calculate From Width** to use the program defaults. Hinged and pocket doors default to **Single Door** when less than four feet (1200 mm) wide; bifold doors do so when less than three feet

(900 mm) wide. If the width is greater than this, **Double Door** is the default.

Note: The Calculate From Width defaults are not editable.

- ② **3D Display** - Specify whether the selected door is shown open or closed in 3D and Elevation views.

If **Show Open** is selected, the Swing Angle set on the General Panel is used.

- ③ A preview of the door displays on the right side of the dialog box. See "Dialog Preview Panes" on page 25.

Casing Panel

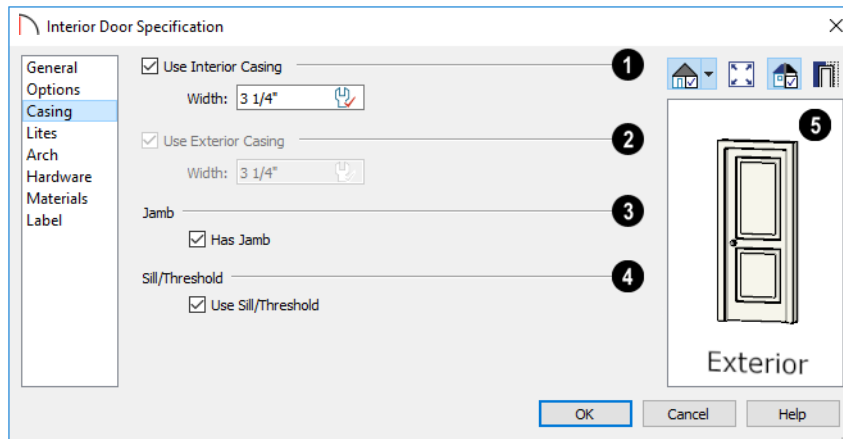

- 1 Check **Use Interior Casing**, then specify the **Width** of the casing.
- 2 Check **Use Exterior Casing**, then specify the **Width** of the casing. Not available for doors in interior walls unless **Use Exterior Trim and Materials** is checked on the **GENERAL** panel. See “General Panel” on page 177.
- 3 Uncheck **Has Jamb** to prevent a jamb from generating around the selected door. The jamb is not included in the door’s size, which is set on the General Panel.
- 4 Uncheck **Use Sill/Threshold** to prevent a sill from being generated under the door. See “Displaying Doors” on page 171.
- 5 A preview of the door displays on the right side of the dialog box. If casing is not specified for a Doorway, the **Show Wall** option will be toggled on automatically. See “Dialog Preview Panes” on page 25.

Lites Panel

The settings on the **LITES** panel of the **Door Specification** dialogs are only available when the selected door is specified as a Glass door on the

General Panel. These settings are also found on the **LITES** panel of the **Window Specification** dialog. See “Lites Panel” on page 191.

Arch Panel

The settings on the **ARCH** panel are also found in the **Window Specification** dialog.

The settings on this panel are not available if the selected door is a Sliding, Bifold or Garage door.

The **ARCH** panel is not available for window symbols from the library, and its settings are not available if a selected window has been modified using the **SHAPE** panel. See “Shape Panel” on page 192.

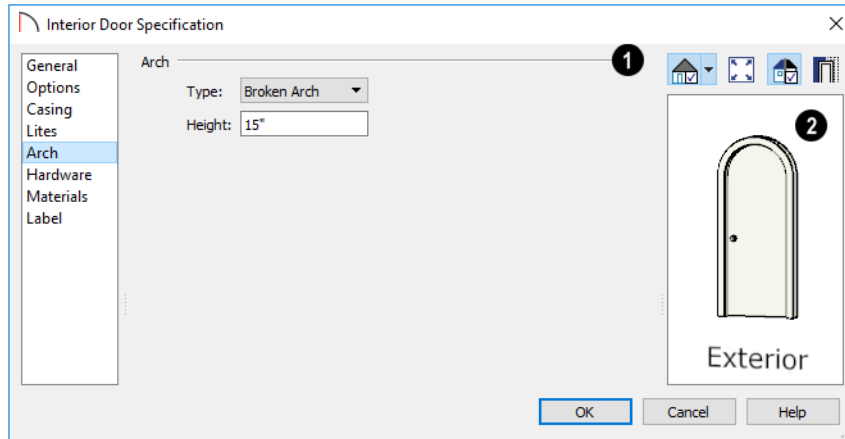

- 1 Define the style and size of the **Arch**.
 - Select a **Type** of arch from the drop-down list.
 - Specify the **Height** of the arch, as measured from the base of the arch to the top of the door. Not available for Round Top Arches.
- 2 A preview of the door displays on the right side of the dialog box. See “Dialog Preview Panes” on page 25.

Hardware Panel

Many of the settings on the **HARDWARE** panel are Dynamic Defaults: if “Use Default” is selected, the setting in the **Door Defaults** dialog for the selected

door’s **Type** is used. See “Dynamic Defaults” on page 48.

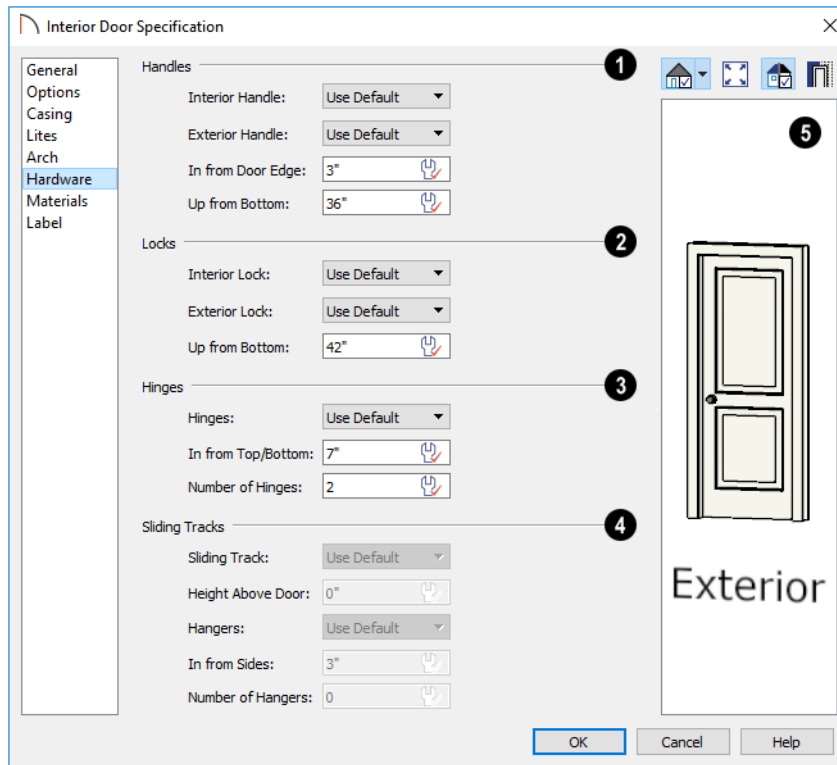

- 1 Specify the **Handles** to be used on the selected door.
 - Select an **Interior Handle** and/or **Exterior Handle** from the drop-down lists.
 - Specify the location of the door handles **In From Door Edge**.
 - Specify the location of the door handles **Up From Bottom**.
- 2 Specify the door's interior and exterior **Locks**.
 - Select an **Interior Lock** and/or **Exterior Lock** from the drop-down lists.
 - Specify the location of the door locks **Up From Bottom**. The locks use the same In From Door Edge value as the handles.

 To use the same handle and lock on both sides of a door, select "Match Interior" as the Exterior option.

- 3 Specify the **Hinges** to be used on the selected door.
 - Select a style of **Hinges** from the drop-down list.
 - Specify the distance **In From Top/Bottom** of the door to the center of the top and bottom hinges.

Note: For hinges to look right, it is best to have at least a 1/4" (6 mm) reveal for the interior, or hinge side, door casing.

- Specify the **Number of Hinges** on the selected door. Interior hinged doors and bifold doors typically have two hinges while exterior hinged doors have three.

- 4 Specify the **Sliding Tracks** to be used on the selected Barn Door.
 - Select a **Sliding Track** from the drop-down list.
 - Specify the track's **Height Above Door**.
 - Select a style of **Hangers** from the drop-down list.
 - Specify the distance **In From Sides** of the door to the center of the outermost hangers.
 - Specify the number of **Hangers** to be evenly spaced along the door.
- 5 A preview of the door displays on the right side of the dialog box. See "Dialog Preview Panes" on page 25.

Materials Panel

The MATERIALS panel is available for a variety of objects throughout the program. For more information, see "Materials Panel" on page 296.

Label Panel

Door labels display in plan view when the "Doors, Labels" is turned on and use the Text Style assigned to that layer. See "Door Labels" on page 172.

For information about the settings on this panel, see "Label Panel" on page 166.

Manufacturer Panel

The MANUFACTURER panel provides contact information for the selected door's manufacturer. Only available for doors from Manufacturer library catalogs. See "Manufacturer Catalogs" on page 276.

Windows

Home Designer Suite can model a wide variety of windows. Fixed glass, hung, casement, sliding, awning, hopper, and louver window styles can all be created with the standard Window tool. Home Designer Suite can create bay, box, and bow windows with a single click. In addition, the library contains many mulled window combinations.

Window Defaults



Default Settings can be accessed by selecting **Edit> Default Settings**. Select Window from the **Default Settings** dialog.

The settings in the **Window Defaults** dialog control the attributes of a window when it is initially placed in a plan, so you should define the type of window that will be placed most often in your model. See “Default Settings vs Preferences” on page 47.

The panels in the **Window Defaults** dialog are similar to those found in the **Window Specification**

Window Tools



To place a window, select **Build> Window** and choose the desired Window Tool. Move your mouse pointer over a wall section, then click to place a window in the wall at that location.

- If there is room enough along the wall to fit a 6” (150 mm) wide Standard Window, a preview of

Chapter Contents

- Window Defaults
- Window Tools
- Special Windows
- Grouped Windows
- Displaying Windows
- Editing Windows
- Window Specification Dialog
- Bay, Box, and Bow Windows
- Bay, Box, Bow Windows and Roofs
- Bay/Box and Bow Window Specification Dialogs

dialog. For more information, see “Window Specification Dialog” on page 188.

Dynamic Window Defaults

A variety of window default values are dynamic, including the **Window Type**, **Casing Specifications**, and **Sash** sizes. All **Materials** are also dynamic. When a dynamic default is changed, existing windows using the default value are affected. See “Dynamic Defaults” on page 48.

the window will display and a window can be placed.

- The Bay, Box, and Bow Window tools do not have preview outlines. If a minimum width of 30” (725 mm) cannot be accommodated at the location where you click, a warning message will display and a window unit will not be created.

Standard Windows can be placed in both straight and curved walls, as well as span across straight, collinear wall segments. In contrast, a Bay, Box, or Bow Window can only be placed in a single, straight wall.

Windows cannot be placed in a wall specified as Invisible. See “Room Dividers and Invisible Walls” on page 113.

Standard Windows

 Select **Build> Window> Window**, then click on a straight or curved wall to place a Standard Window at that location.

A Standard Window is a single window that is not a bay, box, or bow window. These special types are made up of multiple Standard Windows.

A Standard Window that is part of a special window is called a Component Window.

Standard Windows can be specified as any of a variety of window types, such as double hung, casement and awning. See “Window Specification Dialog” on page 188.

Bay Windows

 The roof is affected by Bay, Box and Bow Windows. These windows should therefore be placed before the roof is built.

 A **Bay Window** is composed of three wall sections, each with a single component window. The two side walls are at an angle to the main wall. Select **Build> Window> Bay Window** and click on a straight wall to produce a bay window.

When initially placed, bay windows measure 2'-2" across at the front, 4'-2" across at the back, and are 1'-0" deep. The component windows are specified in the **Window Defaults** dialog and their sizes adjust to fit the available space.

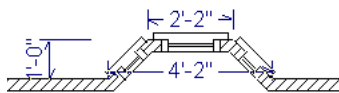

Box Windows

 A **Box Window** is a bay window with side angles set at 90°. Select **Build> Window> Box Window** and click on a straight wall to produce a box window.

Box windows initially measure 4'-2" wide with a depth of 1'-6". The component windows are specified in the **Window Defaults** dialog and their sizes adjust to fit the available space.

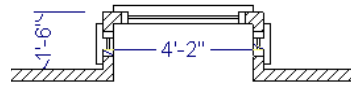

Bow Windows

 A **Bow Window** is a group of identical wall segments that form a segmented curve. Select **Build> Window> Bow Window** and click on a straight wall to produce a 5-section bow window.

The component windows are specified in the **Window Defaults** dialog. Their sizes adjust to fit the available space.

The 5-section bow below has a 4'-10" radius centered 3'-9" inside the wall, giving an opening 5'-10" across and a depth of 11½".

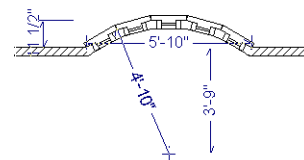

Note: Bay, box, and bow window areas are not included in the living area or in room standard area calculations. They are included in room interior area calculations.

Pass-Throughs

 Select **Build> Window> Pass-Through**, then click on a straight or curved wall to place a Pass Through at that location.

A Pass-Through is simply a wall opening without a window unit placed inside. Like a window, it can have casing and a sill. It does not, however, have a sash, frame, or glass. It is one of the window **Types** available in the **Window Specification** dialog. See “General Panel” on page 188.

Wall Niches

 Select **Build> Window> Wall Niche**, then click on a straight or curved wall to place a Wall Niche at that location.

A Wall Niche is a wall opening that does not extend through the entire depth of the wall. You can specify

the niche's depth in the **Window Specification** dialog. See "General Panel" on page 188.

Windows Library



Select **View> Library Browser**, then browse to Home Designer Core Catalogs>

Special Windows

A variety of special windows can be created using multiple standard windows, the edit tools or custom symbols.

Creating Manual Bay, Box and Bow Windows

Sometimes it is easier to draw bay, box and bow windows manually than to use the automatic tools. Bays created using walls can have more than one window per section, which is not possible using a bay window unit.

Bear in mind that moving a manually created bay, box or bow window is generally more difficult than moving a unit created with one of the **Window Tools**

 since it is composed of individual walls.

Corner Windows

To create a corner window, first create the desired window on each side of the corner. For best results, the heights, casing, and sills of both windows should be the same.

There are a number of ways to control the size of the corner post.



- Use dimensions to position the windows relative to the corner. By default, windows will stop when their interior casing bumps into the adjacent wall. See "Editing Windows" on page 187.

Architectural> Windows to access a selection of special window units. Select the desired window, then click on a wall to place the window at that location.

- To move a window all the way into a corner, check **Ignore Casing for Opening Resize**. See "General Plan Defaults Dialog" on page 49.
- To produce a minimal corner post and no siding or casing between the windows, use their Move edit handles. Click and drag each window past the exterior corner until its preview outline moves into the middle of the wall corner.

Special Window Shapes

A selection of special shaped windows is available in the Windows Library, including arched windows and mullied units.

In addition, you can create a variety of window shapes in the **Window Specification** dialog, including:

- Arched windows. See "Arch Panel" on page 192.
- Trapezoidal windows. See "Shape Panel" on page 192.

Placing a Gable Over a Window



Click the **Gable Over Door/Window** edit button to produce a gable roof over the selected window(s) the next time automatic roofs are built. See "Gable Over Door/Window" on page 258.

You can manually edit or delete this gable line at any time. Your changes take effect when the automatic roofs are rebuilt. This tool can also be used with group selected windows.

Vents

A selection of attic, foundation and gable vents are available in the Library Browser. See "The Library" on page 271.

Vents are placed in the same manner as regular windows and can be edited in much the same way, as well.

Grouped Windows

Windows can be grouped together to create a wide variety of custom configurations. Stacked windows are easy to create in 3D views, particularly Elevation views, using their edit handles. See “Editing Windows” on page 187.



Notice how the windows and door in this example are separate, with spaces between them. Doors and/or windows can also be positioned so that there are no spaces between the windows and door units, and the casing between them appears to be shared.

Automatically Mullered Openings

To form a mullered group of windows and/or doors, move them close enough together so that their casings touch. Once the casings touch, the windows are mullered together with one casing between the two of them.

The sill of each window in the group must be at the same level for them to share the middle casing. The casing tops do not have to be at the same level. The casings are modeled as if they are one unit but the windows remain separate objects for dimensioning and the Materials List.

Windows can be automatically mullered to doors if the bottom of the window is at the elevation of the floor, equal to the bottom of the door.

Displaying Windows



The display of windows in floor plan and 3D views can be controlled in the **Display Options** dialog. See “Display Options Dialog” on page 74.

Windows can only be placed in walls, so if a wall’s layer is turned off in plan view, any windows placed

Mullered Units in the Library

A selection of mullered window units is available in the Windows library. To place one in your plan, select it and click on a wall in any view. See “Placing Library Objects” on page 281.

Selecting Components of Mullered Units

To select a component of a mullered unit from the library, click at the location of the component in

question, then click the **Select Next Object**  edit button or press the Tab key until that individual component is selected. Only the component clicked on is selectable using this method. If you need to select a different component, click on it and repeat the process.

If there are multiple levels, it is easiest to select the components in a 3D view. When you have selected an individual component, you can change its parameters in the **Window Specification** dialog. See “Window Specification Dialog” on page 188.

If the selected component is not itself a mullered unit and has no components above it, its **Height** and **Arch** parameters can be changed. Changing the Height causes the component top to move. The bottom remains stationary.

Displaying Mullered Units



As with other windows, the display of mullered window units is controlled in the **Display Options** dialog. See “Layer Attributes” on page 74.

Mullered units are placed on the “Windows” layer by default and have a single label, which is on the “Windows, Labels” layer. Mullered units from the library are also included in the windows category of the Materials List. If the component objects of a mullered unit have unique moldings or materials, they will not be noted in the Materials List.

in that wall will not display, either. Windows can display independent of their containing walls in 3D views, however. See “Displaying Walls” on page 117.

If the “Windows” layer is not set to display, window casing and other components are not visible, but the

openings in the walls where they are located can still be seen.

In Plan View

A window's frame, glass, and sill are all represented in plan view. This makes some window types, notably Sliding and Double and Triple Casement windows, distinguishable.

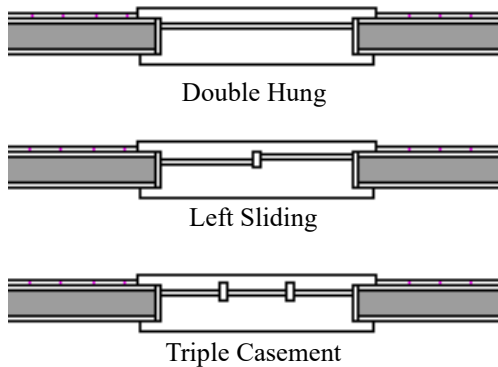

Window types in plan view

Bay, box, and bow windows have dimension lines associated with them.

- You can suppress their display by turning off the “Manual Dimensions” layer or on a unit by unit basis in the unit’s specification dialog. See “Bay/Box and Bow Window Specification Dialogs” on page 196.
- The arrow style and fill are set in the **Dimension Defaults** dialog. See “Dimension Defaults Dialog” on page 147.

Window Labels

Window labels display in floor plan view, centered on the windows they represent, when the “Windows,

Labels” layer is turned on and use the “Default Label Style” Text Style See “Object Labels” on page 166.

Window labels indicate Width and Height, followed by Type. For example:

- In Imperial plans, the automatic label for a 3’-0” wide, 4’-0” high double hung window will read 3040 DH.
- In metric plans, the automatic label for a 900 mm wide, 1200 mm high double hung window will read 900x1200 DH.

You can specify whether a Bay, Box or Bow Window displays a single label or displays the labels of its component windows.

- When **Suppress All Labels** is selected, individual components of Bay, Box and Bow Windows are counted in the Materials List.
- When **Show Component Labels** is selected, components of Bay, Box and Bow Windows are counted in the Materials List.
- When **Show Single Label for Entire Unit** is selected, the Bay, Box or Bow Windows has one label in plan view but each component is counted separately in the materials list.



These options are also available for mullied units but affect their display the materials list somewhat differently. See “Displaying Mullied Units” on page 186.

Customized labels can also be specified in the **Window Specification** dialog.

Wall Niches  can also display labels when the “Wall Niches, Labels” layer is on. Unlike other windows, these objects’ Automatic Labels are blank; however, you can specify a custom label in their specification dialog.

Editing Windows

Before a window can be edited, it must be selected.

Click on a window when the **Select Objects**  tool or any of the **Window Tools**  are active. Doors and/or windows can also be group-selected and edited. See “Selecting Objects” on page 79.

To select a window that is part of a blocked unit, click the component window, then click the **Select**

Next Object  edit button. See “Selecting Components of Mullied Units” on page 186.

Windows can be edited using their edit handles, the edit toolbar buttons, and the **Window Specification** dialog. See “Window Specification Dialog” on page 188.

When you select a window in plan view, the window size label displays the width followed by the height. For example, a 3036 window is 3’-0” wide by 3’-6” high.

In the Specification Dialog

 The most precise method of editing a window is to use the **Window Specification** dialog. The window type, size, casing, materials, and more can all be specified in this dialog. See “Window Specification Dialog” on page 188.

Using the Mouse

In plan view, click either of the two end handles and drag along the wall to change the width. The label showing the size updates as the window is resized.



In 3D views, a selected window has five edit handles: the Move handle at the center and a Resize handle on each edge. Click and drag an edge handle to resize the window.

A single window or a group of windows can be moved with the center edit handle.

A door or window moved against an intersecting wall temporarily stops when it is the casing distance from the intersecting wall. Enable **Ignore Casing for Opening Resize** in the **Plan Defaults** dialog to turn off this behavior. See “General Plan Defaults Dialog” on page 49.

You can continue to drag the selected window and it will resume movement past or onto the intersecting wall.

Window Specification Dialog

 To open the **Window Specification** dialog, select a window and click the **Open Object** edit button; or double-click the window using the **Select Objects**  or a **Window**  tool.

The settings in this dialog are similar to those in the **Window Defaults** dialog. See “Window Defaults” on page 183.

To create a corner window, drag the Move handle straight out past the wall corner, parallel to the selected window’s wall. See “Corner Windows” on page 185.



Using Dimensions

 Like various other objects, windows can be moved using dimensions. See “Moving Objects Using Dimensions” on page 154.

By default, dimensions locate the sides of windows. Once a dimension line has been drawn, you can move or add its extension lines to locate the center of a window. See “Editing Extension Lines” on page 152.

Using the Edit Tools

A selected window or windows can be edited in a variety of ways using the buttons on the edit toolbar. See “The Edit Toolbar” on page 23.

- Click the **Gable Over Door/Window**  edit button to create a gable over the selected window(s) the next time the roof is rebuilt. See “Gable Over Door/Window” on page 258.
- Click the **Change Wall Side**  edit button to move the selected Wall Niche to the opposite side of the wall. See “Wall Niches” on page 184.

The settings in this dialog are also similar to those in the **Wall Niche**, **Mulled Unit** and **Window Symbol Specification** dialogs. Although similar, a number of the options cannot be edited when either a window symbol or a mulled unit from the library is selected, and some panels are not available. See “Grouped Windows” on page 186.

General Panel

In the **Wall Niche Specification** dialog, only the **Size and Position** settings on this panel are available. See “Wall Niches” on page 184.

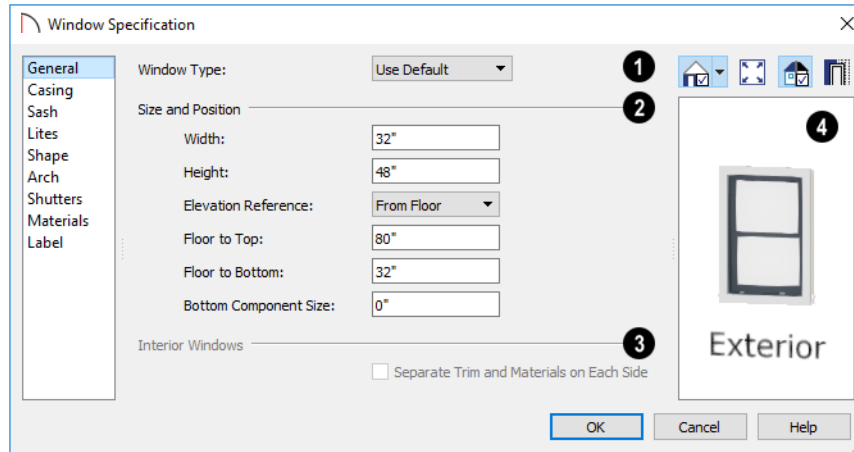

1 Window Type - Select the type of window from the list. The first entry in the list is the “Use Default”, which is set in the **Window Defaults** dialog.

2 Specify the **Size and Position** of the selected window.

- Specify the window’s **Width** and **Height**.
- Select the **Elevation Reference** from the drop-down list. This determines where the next two settings are measured from and also affects their setting labels.
- Specify the height **to Top**, measured from the selected Elevation Reference to the top of the window frame.
- Specify the height **to Bottom**, measured from the selected Elevation Reference to the bottom of the window frame.
- Specify the **Depth** of the selected Wall Niche, measured from the wall surface to the back of the niche. Only available for Wall Niches.

Note: When either the Floor to Top or Floor to Bottom setting is modified, the other will adjust in response to prevent the window’s Height from changing.

- Specify the **Bottom Component Size** for Single Hung, Double Hung, Double Awning, Double Hopper, and Triple Hopper windows; specify the **Top/Bottom Component Size** for Triple Awning windows; or,
- Specify the **Side Component Size** for Triple Casement and Triple Sliding windows, the **Right Component Size** for Left Sliding windows, or the **Left Component Size** for Right Sliding and Double Casement windows.

A **Component Size** value of 0 creates a window with identically sized components.

3 The **Interior Windows** settings are only present when the selected window is a Pass-Through placed in an interior wall. See “Exterior and Interior Walls” on page 112.

- Check **Separate Trim and Materials for Each Side** to specify the casing and all materials for each side of the selected Pass-Through independently. When unchecked, the two sides use the same trim and materials.

4 A preview of the selected window displays here. A label indicates which side of the window is its Interior and which is its Exterior. See “Dialog Preview Panes” on page 25.

Casing Panel

The CASING panel is not available in the **Window Symbol Specification** dialog.

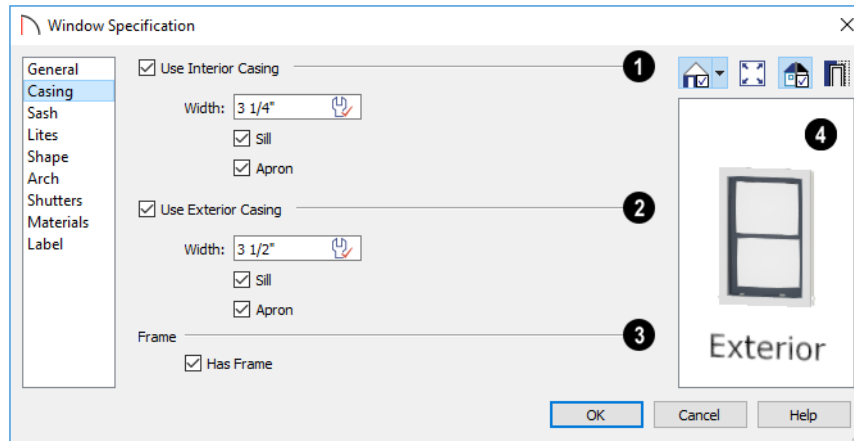

- 1 Check **Use Interior Casing**, then specify the **Width** of the casing.
- 2 Check **Use Exterior Casing**, then specify the **Width** of the casing. If the selected window is a Pass-Through placed in an interior wall, these settings will be unavailable unless **Separate Trim and Materials on Each Side** is checked on the **GENERAL** panel. See “General Panel” on page 188.

- 3 Uncheck **Has Frame** to prevent a frame from generating around the selected door. The frame is not included in the window’s size, set on the **General** Panel.

- 4 A preview of the selected window displays here. You may need to rotate the preview to see the casing on the side of the door you are editing. If casing is not specified for a Pass-Through, the Show Wall option will be toggled on automatically. See “Dialog Preview Panes” on page 25.

Sash Panel

The settings on the **SASH** panel control the size and position of the selected window’s sash. Note that increasing the Side, Middle, Top or Bottom Width decreases the area of the glass and vice versa.

The **SASH** panel is not available in the **Wall Niche Specification** dialog, and the settings on this panel are not available for Pass-Throughs.

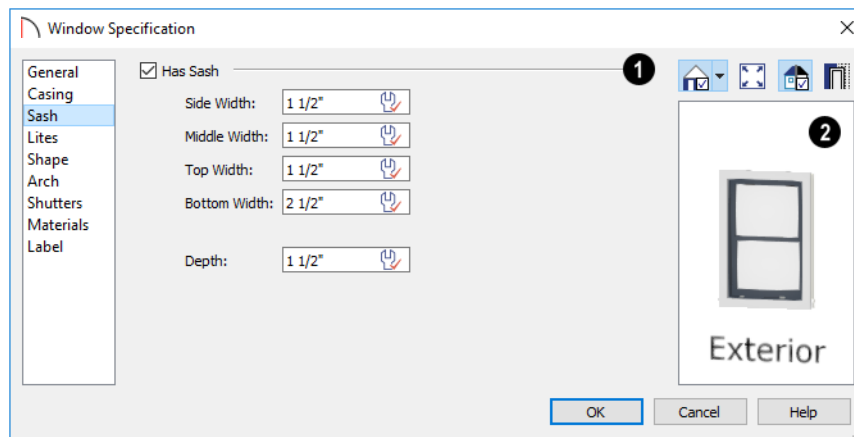

- 1 Specify the width and depth of the selected window’s **Sash**, which are the pieces of the window that hold the glass; or, uncheck this box to prevent it from having a sash.
 - Specify the **Side Width** of all vertical sash members: those at the window sides as well as the cen-

tral members of Casement and Sliding windows. This is also the width of the top portion of the window when an arch is specified.

- Specify the **Middle** width of horizontal components between the top and bottom sash in Double Hung, Double and Triple Awning, and Double

- and Triple Hopper windows. It does not affect Casement and Sliding windows.
- Specify the **Top** and **Bottom Widths**. The **Top** value is not used if the window has an arch.
- Specify the **Depth**, or thickness, of the sash stock measured from the exterior to the interior.
- 2** A preview of the selected window displays here. See “Dialog Preview Panes” on page 25.

Lites Panel

The LITES panel allows you to add muntins to windows, and is also available for Glass doors. See “Doors” on page 169.

The LITES panel is not available in the **Wall Niche Specification** dialog, and the settings on this panel are not available for Pass-Throughs.

There are four possible styles of muntin bars.

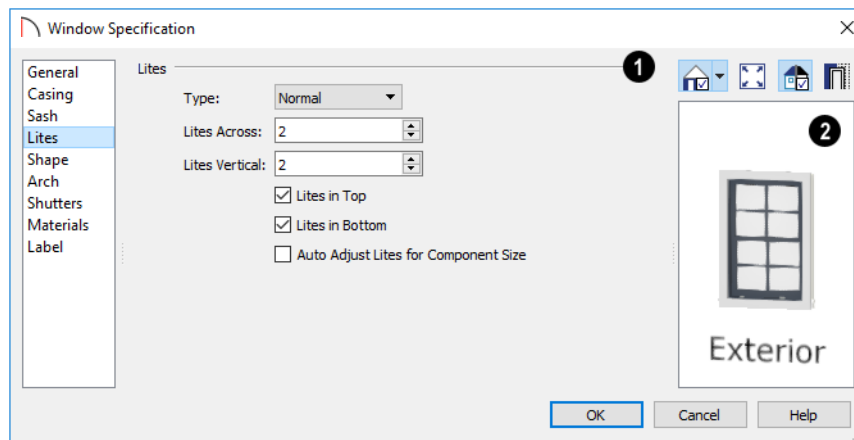

- Specify the number, position and style of **Lites** for the selected window.
- Select a **Type**, or style, of window lite from the drop-down list.

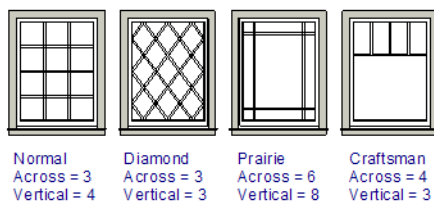

- Normal** style is the most common, with muntins going horizontally and vertically. Colonial windows are an example of the normal style.
- Diamond** style uses angled muntin bars to divide up the lites. French windows are an example of the diamond style.
- Prairie** style is based on the normal style, but with all the central muntin bars removed, leaving only the two outside muntin bars both horizontally and vertically. Typically, both Lites Across and Lites Vertical should be set between 6 and 8. Federal or Federation windows are an example of the Prairie style.
- Craftsman** style is based on the normal style, but only the topmost horizontal muntin bar is kept with all the portions of the vertical muntin bars above it. Typically, both Lites Across and Lites Vertical should be set between 4 and 8.
- Enter the number of horizontal **Lites Across** in each sash.
- Enter the number of vertical **Lites Vertical** in each sash.
- Check or uncheck **Lites in Top** and/or **Lites in Bottom** - or **Lites in Left** and/or **Lights in Right** - to specify either one or both of the sashes to have divided lites.
- Check **Auto Adjust Lites for Component Size** to have the program produce lites that are consistent in size across all components. When this is checked, the window’s lites and its specification settings may not agree; when unchecked, lites in the components may not be consistent in size.

Note: Because the fixed window in a Triple Sliding window is twice the size of the movable windows, the fixed section has a vertical muntin bar. To eliminate this, uncheck Auto Adjust Lites for Component Size.

- 2 A preview of the selected window displays here. See “Dialog Preview Panes” on page 25.

Shape Panel

The settings on the SHAPE panel control the position of the selected window’s corners, allowing you to create angled edges and mitered top corners.

If any of these settings are used to create a custom shape, the selected window will be automatically specified as “Fixed Glass” on the GENERAL panel. If

the selected window has an arch specified on the ARCH panel, it will be removed.

The SHAPE panel is not available for mulled units or window symbols from the library.

Note: The Left and Right settings on this panel refer to the window’s exterior.

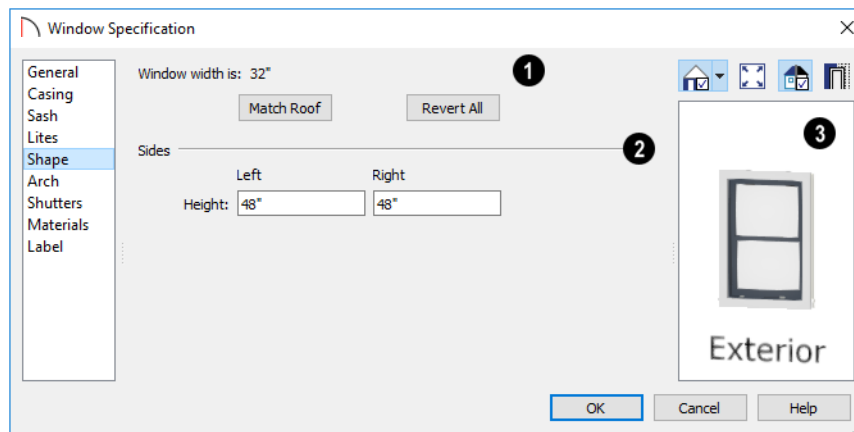

- 1 **Window Width** displays for reference. It can be changed on the General Panel.
- Click **Match Roof** to match the angle of the top of the window to the pitch of the roof above by changing its Sides heights, below. If either Top Inside Corner box is checked, it will become unchecked.

Match Roof does not work for curved roofs, has no effect if the window is not in a gable end wall, and is not available in the Window Defaults dialog.

- Click **Revert All** to restore the window to its original shape, type and arch settings.
- 2 Specify the height of the window’s **Left** and **Right Sides**, as measured from the bottom of the window. By default, these settings match the window’s Height.
- 3 A preview of the selected window displays here. You may want to rotate the view so the window’s exterior can be seen. See “Dialog Preview Panes” on page 25.

Note: The Left and Right settings on this panel refer to the window’s exterior.

Arch Panel

The settings on the ARCH panel of the **Window** and **Mulled Unit Specification** dialogs are also found on the panel of the same name in the **Door Specification** dialog. See “Arch Panel” on page 179.

The ARCH panel is not available for window symbols from the library, and its settings are not available if the selected window has been modified using the SHAPE panel.

Shutters Panel

The settings on the SHUTTERS panel allow you to specify exterior shutters for the selected window or mullied unit from the library.

The SHUTTERS panel is not available in the **Wall Niche** and **Window Symbol Specification** dialogs.

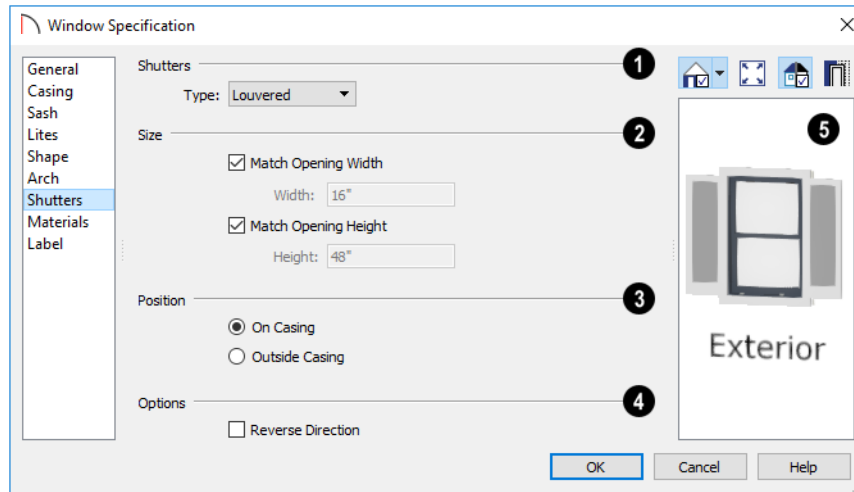

- 1 Select a **Type of Shutters** from the drop-down list.
- 2 Specify the **Size** of the selected shutters.
 - When **Match Opening Width** is checked, each shutter's width is exactly half that of the window, excluding casing.
 - Uncheck **Match Opening Width** to specify a **Width** in the text field. If the window is later resized, the shutters will not adjust in response.
 - When **Match Opening Height** is checked, each shutter's height equals that of the window, excluding casing.
 - Uncheck **Match Opening Height** to specify a **Height** in the text field. If the window is later resized, the shutters will not adjust in response.
- 3 Specify the **Position** of the shutters relative to the window.
 - Select **On Casing** to position the shutters just outside the window frame, like functional shutters.
 - Select **Outside Casing** to position shutters outside the window casing, as decorative shutters often are.
- 4 Additional shutter **Options** can be specified here.
 - Check **Reverse Direction** to orient the shutters so their exterior sides face outward and their inte-

rior sides face the wall. For functional shutters, this should remain unchecked.

- 5 A preview of the selected window displays on the right. In order to see the shutters, you may need to rotate the preview to show the Exterior. See "Dialog Preview Panes" on page 25.

Materials Panel

The settings on the MATERIALS panel are the same as those found on the same panel in dialogs throughout the program. See "Materials Panel" on page 296.

Label Panel

Window labels display in plan view when the "Windows, Labels" layer is turned on and use the Text Style assigned to that layer. See "Window Labels" on page 187.

Similarly, Wall Niche labels display in plan view when the "Wall Niches, Labels" layer is turned on and use the Text Style assigned to that layer. See "Window Labels" on page 187.

For more information about the settings on this panel. See "Label Panel" on page 166.

Manufacturer Panel

The MANUFACTURER panel provides contact information for the selected window's manufacturer. Only available for windows from Manufacturer

library catalogs. See “Manufacturer Catalogs” on page 276.

Bay, Box, and Bow Windows



Bay, Box and Bow Windows are created much the way regular windows are: select a tool, then click a wall to place that window type.

Home Designer Suite automatically builds a foundation under bay/box/bow windows placed on floor 1 unless they are raised from their original position. That section of the foundation wall is also a bay/box/bow, but without windows. If the foundation was generated before the window is placed, the foundation must be rebuilt or edited manually.

Editing Bay, Box and Bow Windows

Bay, box, and bow windows are edited similar to regular windows with one exception: in plan view, a diamond-shaped Depth edit handle displays on the section. Drag this Depth handle outward to increase the depth, or inward to decrease the depth of the unit. See “Editing Windows” on page 187.

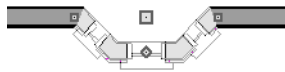

Depth edit handle on a bay window

Bay, box and bow windows can also be edited in their respective specification dialogs. See “Bay/Box and Bow Window Specification Dialogs” on page 196.

Displaying Bay, Box and Bow Windows

The display of bay, box and bow windows is controlled in the **Display Options** dialog. See “Display Options Dialog” on page 74.

Like other windows, bay, box and bow windows can display labels: either a single label for the unit, or one for each component. See “Window Labels” on page 187.

Bay, box and bow window width and radius dimensions, which display in plan view when

specified to do so in the window’s specification dialog, are placed on the “Dimensions, Manual” layer. See “Options Panel” on page 197.

Component Windows

A component window within a bay, box or bow window can be resized like any other standard window. To select a component window, click at the location of the component in question, then click the

Select Next Object  edit button or press the Tab key.

- Only the bay or box window component that was clicked on is selected using this method. If you need to select a different component, click on it and repeat the process.
- In a bow window, all components are identical, so only one component can be selected. Changing this component changes them all.

Resizing Components

An individual component window can be resized using the edit handles, by changing settings in the component’s **Window Specification** dialog.

When a bay/box/bow window is first created, there is room for one standard trimmer on each side of each component window. When the bay as a whole is moved and resized, its components automatically resize so that a standard trimmer is still accommodated.

If a component window is resized, it retains its size if at all possible when the containing bay/box/bow window is moved or resized. If the bay is resized in such a way that the component is too large to fit even with a thinner trimmer, the component resumes its default behavior, resizing as the containing bay window is resized.

Floors and Ceilings

When originally created, the floor and ceiling within a bay, box, or bow window are the same heights as the floor and ceiling of the room in which it is placed.



Both the top and bottom heights of these window units can be adjusted in its specification dialog or a 3D view using its edit handles to create a lowered ceiling and/or a bench seat or garden window.

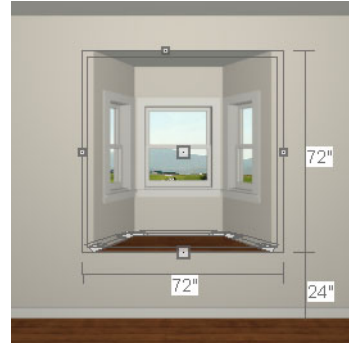

When the ceiling is lowered, the top heights of the walls that define the window unit are also lowered. When a roof is built over the unit, its height will be affected, as well.

When the bottom of the window is raised to create a bench seat, the unit's walls will not reach the ground. As a result, window units with bench seats will have no foundation beneath them when the foundation is built.

Bay, Box, Bow Windows and Roofs

Several different roof styles can be specified for bay, box and bow window units in the **Bay/Box/Bow Specification** dialog. See “Bay/Box and Bow Window Specification Dialogs” on page 196.

If you change a bay, box, or bow window's roof specification, you will need to rebuild the roofs to see the changes. See “Rebuilding Roofs” on page 256.

Hip Roofs

By default, a hip roof is built above the unit when roofs are automatically generated. No roof directives need to be selected in the specification dialog to produce this roof.



Use the Existing Roof

To generate a standard roof that ignores a bay, box, or bow window, check **Use Existing Roof**.

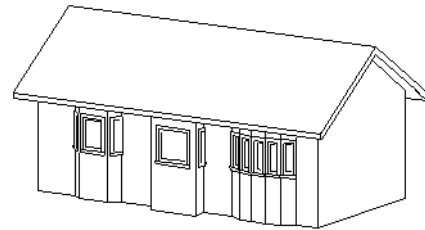

With this option the bay, box, or bow windows is tucked under the roof eave. You may find it helpful to increase the width of the eaves. See “Roof Panel” on page 257.

Extend the Existing Roof

To have the main roof extend down over the window unit and follow the shape of the unit, select **Extend Existing Roof**.

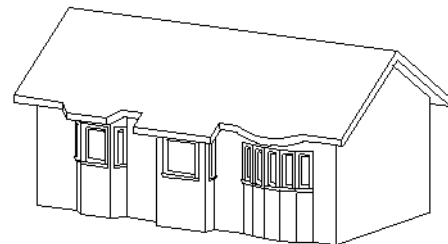

For this roof style, the ceiling heights of the window unit and the adjacent room must be the same. If you lower the ceiling of the window unit and then build the roof, a lower hip roof over the window is created. See “Floors and Ceilings” on page 194.

If a header is desired over the window unit, first build the roof, then lower the ceiling of the window unit. Do not rebuild roof planes.

Rectangular Hip Roofs

To create a rectangular-shaped hip roof above a bay, box, or bow window, select **Rectangular Roof Over**.



Extend Existing Roof - Rectangular

To extend the main roof down over a window unit to create a rectangular roof over it rather than one that follows its shape, select both **Extend Existing Roof over** and **Rectangular Roof Over**.

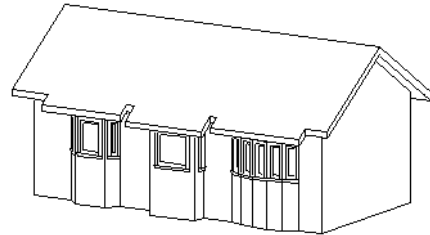

Gable Roof

A gable roof is not one of the automatic options for the roof above a bay, box or bow window.

 To create a gable roof over a normal window, use the Gable Over Door/Window edit button. See “Gable Over Door/Window” on page 258.

Bay/Box and Bow Window Specification Dialogs

 To open the **Bay/Box Window Specification** or the **Bow Window Specification** dialog, select a Bay, Box or Bow Window and click the **Open Object** edit button.

The options in this dialog can only be set for objects placed in a plan: Bay, Box, and Bow Windows do not have defaults dialogs.

General Panel

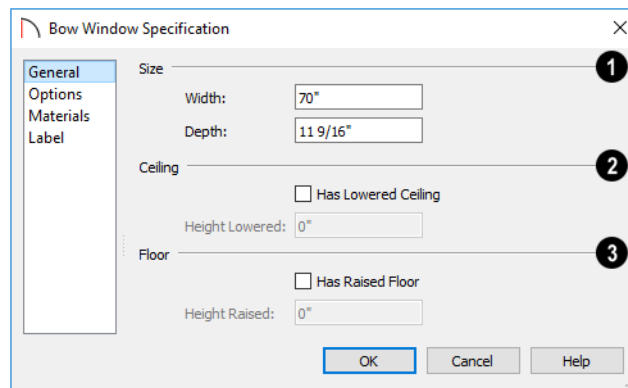

- 1** **Size** - Specify the **Width** and **Depth** of the selected Bay, Box, or Bow Window.
- 2** Specify the height and structure of the **Ceiling** within the selected window.
- Check **Has Lowered Ceiling** to enable the settings that follow. When this is unchecked, the ceiling height and finish material within the window is the same as that for the adjacent room.
- Specify the **Height Lowered**, which is measured from the ceiling height of the adjacent room.

Note: If the Height Lowered is 0", Has Lowered Ceiling will become unchecked when you click OK.

- 3 Specify the height and structure of the **Floor** within the selected window.
- Check **Has Raised Floor** to enable the settings that follow. When this is unchecked, the floor

height and material within the window is the same as that for the adjacent room.

- Specify the **Height Raised**, which is the measured from the floor height of the adjacent room.

Note: If the Height Raised is 0", Has Raised Floor will become unchecked when you click OK.

Options Panel

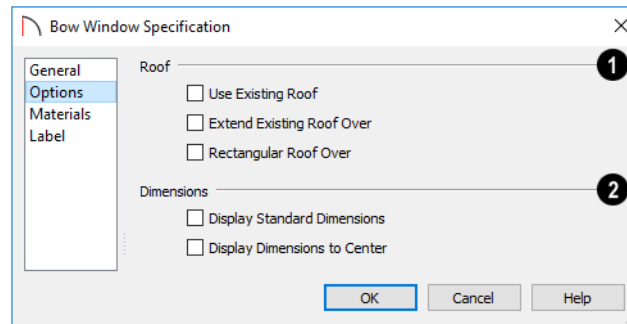

- 1 Specify the structure of the **Roof** over the selected window unit. See “Bay, Box, Bow Windows and Roofs” on page 195.
 - Check **Use Existing Roof** if the existing roof needs no changes to accommodate the bay window.
 - Check **Extend Existing Roof Over** to extend the existing roof plane to cover the bay window below.
 - Check **Rectangular Roof Over** to create a roof over the bay window that is square across the end instead of following the profile of the roof.
- 2 Specify the appearance of the selected window unit’s **Dimensions** in plan view.
 - Check **Display Standard Dimension** to display the automatically-produced dimensions that show the window’s width and depth.

- Check **Display Dimensions to Center** to display a Bow Window’s radial dimension.

Materials Panel

The settings on the MATERIALS panel are the same as those found on the same panel in dialogs throughout the program. See “Materials Panel” on page 296.

Label Panel

Bay, Box, and Bow Window labels display in plan view when the “Windows, Labels” layer is turned on and use the Text Style assigned to that layer. See “Window Labels” on page 187.

For more information about the settings on this panel. See “Label Panel” on page 166.

Cabinets

With Home Designer Suite's cabinet tools you can create base, wall, and full height cabinets as well as soffits, shelves and partitions. These objects are very versatile, allowing for a wide range of customization.

A selection of cabinet door and drawer styles are available in the Library Browser.

Home Designer Suite also has many customized cabinets and cabinet groups available in the library.

Chapter Contents

- Cabinet Defaults
- The Cabinet Tools
- Cabinet Fillers
- Placing Cabinets
- Displaying Cabinets
- Editing Cabinets
- Editing Cabinet Styles
- Special Cabinets
- Cabinet Specification Dialog
- Shelf/Partition Specification Dialog

Cabinet Defaults



There are several defaults dialogs for cabinets. Access Default Settings by selecting **Edit > Default Settings**, then clicking the arrow beside "Cabinets". Select a subheading and click the **Edit** button to open the defaults dialog associated with your selection.

Each type of cabinet object has default definitions for size, style, materials and more. In fact, the default dialog for each cabinet type is similar to its

corresponding specification dialog. For descriptions of these settings, see "Cabinet Specification Dialog" on page 206, "Shelf/Partition Specification Dialog" on page 210 and "Soffit Specification Dialog" on page 291.

In many of the new plan Style Templates, Wall and Full Height cabinets have crown molding. These cabinets can be placed from the library into any plan. See "Template Plans" on page 33.

General Cabinet Defaults

The **General Cabinet Defaults** dialog can be accessed only from the **Default Settings** dialog.

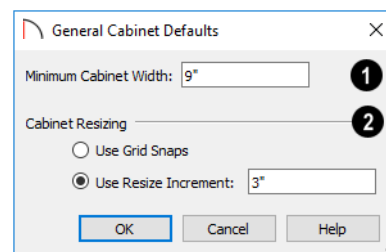

- 1 Specify the **Minimum Cabinet Width**. The smallest allowable value is 1/16 of an inch (10 mm).
- 2 Specify how **Cabinet Resizing** takes place when the edit handles are used.

- Select **Use Grid Snaps** to resize cabinets using Snap Grid increments. See “Grid Snaps” on page 68.
- Select **Use Resize Increment** to resize cabinets using the increment specified here.
- Set the **Resize Increment** at which cabinets resize. The minimum allowable increment is 1/16 of an inch (10 mm).

The Cabinet Tools



Select **Build> Cabinet** to access the Cabinet Tools.

Cabinets are easily created with a single click in plan view or any camera view. See “Click-to-Create” on page 69.

Typically, groups of cabinet objects are positioned closely together and arranged to form work spaces, and there are some special behaviors and techniques to be aware of. See “Placing Cabinets” on page 201.

Once created, cabinets, soffits, shelves, partitions and fillers can be selected and edited much like other box-based objects. See “Editing Cabinets” on page 203.

Base Cabinets



Select **Build> Cabinet> Base Cabinet** and click in any view. Base cabinets can be placed directly under wall cabinets and generate a countertop and toe kick by default.

Wall Cabinets



To place a wall cabinet, select **Build> Cabinet> Wall Cabinet** and click in any view. Wall cabinets can be placed directly over base cabinets.

Full Height Cabinets



To place a full height cabinet, select **Build> Cabinet> Full Height** and click in any view. Full height cabinets generate a toe kick by default and cannot be placed on top of other cabinets.

Soffits



Soffits typically fill the space between cabinet tops and the ceiling, but can also be used to create any object that can be modeled as a 3D box. To place a soffit, select **Build> Cabinet> Soffit** and click in any view.

By default, soffits use the material assigned to interior walls in the **Material Defaults** dialog. Like cabinets, soffits can have molding profiles applied to them.

For more information about using soffits for a variety of purposes, see “Other Objects” on page 289.

Shelves



Select **Build> Cabinet> Shelf** and click in any view to create a shelf.

Create corner shelves by placing one shelf on each wall, then moving or stretching them until they touch.

Once created, shelves can be selected and edited. See “Shelf/Partition Specification Dialog” on page 210.

Partitions



Select **Build> Cabinet> Partition** button and click in any view to create a vertical partition.

Like shelves, partitions can be selected and edited after they are placed.

Partitions can be used with shelves to create complex storage systems.

Cabinet Library Catalog



In the Library Browser, browse to Home Designer Core Catalogs> Architectural> Cabinets to access a selection of specialty cabinets. Select the library object you want, then click in any view to place it in the plan. Once placed, library cabinets can be edited. See “The Library” on page 271.

Cabinet Doors, Drawers, and Panels Catalog



A selection of cabinet door, drawer, and panel styles is available in Home Designer Core

Catalogs> Architectural. Select an item, then click on a cabinet in your plan to place the door or drawer onto that cabinet. Doors, drawers, and panels can be assigned to a cabinet in its specification dialog, as well. Cabinet doors, drawers, and panels can also be placed as stand-alone fixtures.

Built-In Sinks and Appliances

A variety of fixtures and appliances such as sinks, cooktops, and dishwashers can be placed into cabinets. See “Inserted Objects” on page 282.

 Place fixtures and appliances into cabinets early, so that any resizing can be done while there is adequate free space.

To insert a fixture into a cabinet, select the fixture in the Library Browser, then click on a cabinet. There must be enough space in the cabinet or adjoining cabinets to contain the selected fixture.

If a sink or cooktop is inserted into a cabinet with a top Drawer or Double Drawer, its Item Type will

automatically change to a False Drawer or False Double Drawer.

Once placed, an inserted fixture can be selected and edited:

- To select a fixture in a cabinet top, click on it and then click the **Select Next Object**  edit button. See “Select Next Object” on page 80.
- Front fixtures can only be modified or deleted in the **Cabinet Specification** dialog. See “Front Panel” on page 207.

 Fixtures can be added to both the top and front of the same cabinet. It is up to you to determine which can be effectively and safely combined in the real world.

Electrical Switches and Outlets

Electrical switches and outlets placed within the backsplash area of a base cabinet will display in front of the backsplash in 3D views when the “Electrical” layer is turned. See “The Electrical Tools” on page 213.

Cabinet Fillers

Home Designer Suite models a continuous countertop and generates fillers automatically when cabinets of the same height are either touching or placed with 3” (75 mm) of one another.

If two cabinets meeting at a corner are separated from each other by 3” (75 mm) or less, the program will automatically generate a filler in the angle between them. A filler is used to separate the front of one of these cabinets from the one it meets so that drawers and doors have room to operate.

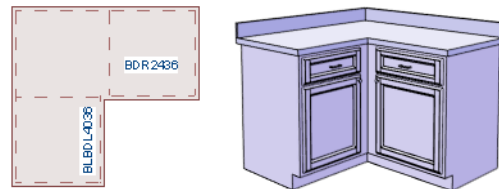

Two base cabinets and the filler between them

Placing Cabinets

Cabinets are easily created with a single click in any view. See “Click-to-Create” on page 69.

When used near a wall corner, the Cabinet Tools will produce corner cabinets and soffits. See “Corner Cabinets” on page 204.

When created, cabinets are positioned relative to the floor of the room in which they are placed. Base and full height cabinets typically rest on the floor while wall cabinets are placed a set distance above the floor. See “Cabinet Defaults” on page 199.

If the ceiling height of the room does not accommodate the height of a cabinet, its **Floor to Bottom** value will be retained and its **Height** will be reduced so that it fits under the ceiling. When this happens, some front items may be removed from the cabinet if there is not enough room for them. See “Front Panel” on page 207.

Because cabinets are typically organized into groups with shared attributes, they have some special behaviors.

Cabinet Snapping and Aligning

Cabinets have several special snapping and aligning behaviors which help you create precisely aligned cabinets quickly and easily.

- When Base and/or Full Height cabinets are within 3” of one another’s sides, they will snap together. Wall cabinets snap in a similar manner, but only with other Wall cabinets.
- When Base and/or Full Height cabinets are within 3” of one another’s sides and their front or back surfaces are within 3” of aligning, they will become aligned. Wall cabinets snap in a similar manner with other Wall cabinets as well as Full Height cabinets.
- When a Base and/or Full Height cabinet is placed against the back of another Base or Full Height cabinet, its back surface will automatically face the other cabinet’s back. Wall cabinets snap in a similar manner with other Wall as well as Full Height cabinets.
- When a cabinet is placed against a wall, its back and/or side will snap to the wall and, if the wall is moved, the cabinet will move with it.

When cabinets are snapped to a wall or to other cabinets, only exposed end cabinets have side counter overhangs.

Cabinet snapping and aligning occurs even when **Object Snaps** are turned off; however, you can override this behavior by moving a cabinet into the desired position using dimensions. See “Moving Objects Using Dimensions” on page 154.

Cabinet Merging

When cabinets of the same height and type are placed side-by-side within 3” (30 mm) of one another they will automatically merge, making any shared components such as the toe kick, countertop,

backsplash, and moldings continuous. Any gap between merged cabinets will be automatically filled.

The exposed ends of merged cabinets have side counter overhangs.

Cabinets placed at different angles will also merge if they face toward one another and meet at a front corner. Cabinets that meet at a back corner will also merge provided that they face away from one another at an angle no greater than 87°. In either case, a filler is created in the angle between the two.

If the side of a cabinet is placed within 3” (30 mm) of a wall, the countertop will extend to the wall and a filler will be created.

Base and Wall Cabinets

Base and wall cabinets have different default heights, so they can be placed directly above or below one another without interference. You can use **Object Snaps** to center a wall cabinet’s back center point above that of a base cabinet, or vice versa. See “Click-to-Create” on page 69.

Minimum Cabinet Size

If you try to place a cabinet into a space that is too narrow for its default size, the program will place a smaller cabinet with a width that is a multiple of the default **Resize Increment**. For example, if you try to place a 24” wide cabinet in a 20” wide space and your Resize Increment is 3”, the program places an 18” cabinet. See “General Cabinet Defaults” on page 199.

If you try to place a cabinet into a space narrower than the default **Minimum Cabinet Width**, a cabinet will not be placed. If, for example, you have a space that is 8” and your Minimum Cabinet Width is 9”, no cabinet is placed.

Displaying Cabinets



The display of the various cabinet object types, labels, module lines, door opening indicators and more is controlled in the **Display Options** dialog. See “Layer Attributes” on page 74.

Like other objects, cabinets are placed in Drawing Groups that affect whether they display in front of or behind other objects in plan view. By default, wall cabinets, soffits and shelves are drawn in front of base and full height cabinets and partitions. You can modify a selected cabinet’s place in the drawing

order by clicking the **View Drawing Group Edit Tools**  edit button. See “Drawing Group Edit Tools” on page 76.

Objects assigned to cabinets, including hardware and moldings, are located on the same layer as their parent object. They display in 3D views, but are not shown in plan view. There are two notable exceptions: countertops and doors/drawers.

- Countertops are drawn on the “Cabinets, Countertops” layer in all views.
- Cabinet doors and drawers are drawn on the “Cabinets, Doors & Drawers” layer in all views, but only display in 3D views.

By default, cabinet module lines display in plan view when cabinet objects of the same type are placed side by side. If you prefer that these lines not display, turn off the “Cabinets, Module Lines” layer. You can also specify whether module lines are full or partial.

Editing Cabinets

Cabinets can be selected in 2D and 3D views and edited using the edit handles, the edit toolbar and their specification dialog.

 You can marquee-select cabinets of multiple types when the Full Height Cabinet tool is active. See “Marquee Select” on page 80.

Using the Mouse

Cabinets can be edited like other box-based objects. See “Editing Box-Based Objects” on page 89. The edit handles that a cabinet displays when selected will vary depending on the view.

When a cabinet is selected in plan view or on its top surface in a 3D view, ten edit handles display: the Move handle at the center, the Rotate handle, and a Resize handle on each edge and at each corner.

In 3D views, cabinets can be selected on any surface: front, side, back or top. When the side of a cabinet is selected, five edit handles are available: the Move handle and a Resize handle on each edge.



In the Specification Dialog

 A selected cabinet can be customized in a variety of ways in its specification dialog. See “Cabinet Specification Dialog” on page 206.

You can also display cabinet front indicator arrows in plan view by turning on the “Cabinets, Front Indicators” layer.

Cabinet labels display in plan view when the “Cabinets, Labels” layer is turned on and use the “Default Label Style” Text Style. See “Object Labels” on page 166.

In 3D views, cabinet doors and drawers are drawn on the “Cabinets, Doors & Drawers” layer, and their display can be turned on and off.

Using the Edit Tools

A cabinet or cabinets can be edited in a variety of ways using the buttons on the edit toolbar. See “The Edit Toolbar” on page 23.

Add to Library

Cabinets can be saved in the Library Browser. Select a base, wall or full height cabinet or cabinet filler and click the **Add to Library** edit button. See “Add to Library” on page 279.

Using Dimensions

 Like various other objects, cabinets can be moved and resized using dimensions. See “Moving Objects Using Dimensions” on page 154.

Dimensions locate the sides and/or corners of cabinet boxes. If you wish, you can move a dimension’s extension lines to locate the centers or countertop edges in plan view after the dimension line is drawn. See “Editing Extension Lines” on page 152.

Moving Walls with Cabinets Attached

When a cabinet is placed or moved against a wall, it will snap to the wall and become attached to it. When a wall is moved, all attached cabinets move with it.

Moving a wall to an unattached cabinet will not attach the cabinet to it: the cabinet must be moved to the wall. A cabinet can also be attached to a wall when **Plan Check**  is used. See “Plan Check” on page 43.

Editing Cabinet Styles

A variety of settings allow you to customize the appearance of your cabinets to create styles ranging from traditional to contemporary.

If the desired style is known before cabinets are placed, you can save time by specifying that style in the **Cabinet Defaults** dialogs before you start drawing. See “Cabinet Defaults” on page 199.

Cabinet Face Items

A variety of different face items can be added to the front of any cabinet, including doors, drawers, cutting boards, and horizontal separations. Face items can be moved, resized, as well as removed and can also be split vertically or horizontally to produce a variety of custom configurations. See “Front Panel” on page 207.

When adding, removing, or resizing face items, it is helpful to keep a few rules in mind:

- When the overall height of a cabinet or the height of a face item is changed, the height of the lowest face item that is not a Separation is adjusted to accommodate the change.
- If you increase the height of the lowest face item, the non-Separation item directly above is adjusted; if you decrease its height, a Blank Area and Separation are created below it.

Note: To ensure that Face Item heights always equal the total cabinet front height, the program automatically adjusts the bottom Face Item as changes are made elsewhere. This means you should start editing Face Items at the top and work down.

Special Cabinets

There are a number of special cabinet shapes that can be specified. Certain requirements must be met before some special cabinet shapes can be specified. If the requirements are not met, a warning message will explain what is needed. See “Cabinet Specification Dialog” on page 206.

Standard Cabinets

Select **Build > Cabinet > Base Cabinet**  and click in plan view to place a standard, rectangular base cabinet.

Doors, Drawers and Panels

Cabinet doors, drawers, and panels can be applied in either of two ways:

- In the **Cabinet Specification** dialog. See “Door/Drawer Panel” on page 209.
- Directly from the Library Browser.

Select a style in the Library, then click on a cabinet to apply the selected style to that cabinet. See “Replace From Library” on page 283.

Cabinet Hardware and Moldings

Cabinet handles, pulls, and hinges can be assigned in the **Cabinet Specification** dialog. See “Door/Drawer Panel” on page 209.

Multiple molding profiles can also be applied around the perimeter of a cabinet at any height. For example, you may want a wood edge around base cabinet countertops and a crown molding that ties together the tops of the wall cabinets and full height cabinets. See “Applying Moldings” on page 268.

Countertops and Backsplashes

The countertop thickness, overhang, and material for a selected base cabinet can be specified in the **Cabinet Specification** dialog. See “General Panel” on page 206.

Backsplashes can be applied to base cabinets as well as down from wall cabinets on the GENERAL panel of their specification dialogs.



Standard (default) cabinet

Corner Cabinets

To create a corner cabinet, click as close to an inside wall corner as possible in using either the **Base**

Cabinet , **Wall Cabinet** , or **Full Height** 

cabinet tool. A corner cabinet remains a corner cabinet when it is moved, edited or copied.

You can turn an existing cabinet into a corner cabinet by selecting “Corner” from the **Special** drop-down list in its specification dialog. See “General Panel” on page 206.

- Before a corner cabinet can be specified in the **Cabinet Specification** dialog, the cabinet’s Width must be greater than its Depth.
- The **Left** and the **Right Side Widths** can be set independently for corner cabinets.



Corner cabinet with sides of equal width

- You can specify a Diagonal Door on corner cabinets to create an angled corner cabinet. See “Front Panel” on page 207.



Corner cabinet with diagonal door

End Cabinets

To turn a cabinet into an end cabinet, specify its Type as “Left End” or “Right End”.



Left End Cabinet

- End Cabinets have an angled front and side.
- The cabinet width must be no greater than its depth for an end cabinet to be specified.

Radius End Cabinets

To turn a cabinet into a radius end cabinet, specify its Type as “Left Radius End” or “Right Radius End”.



Radius End cabinets have a 90° arch

As you face the cabinet, a right radius end curves to the right, and a left radius end curves to the left.

Peninsula Radius Cabinets

To turn a cabinet into an end cabinet, specify its Type as “Peninsula Radius”.



Peninsula Radius Cabinet

Kitchen Islands

To create a kitchen island, simply place several cabinets back-to-back and/or side-to-side. Match the widths so that each cabinet back or side meets the back or side of only one other cabinet. If this is not done, the lines separating the cabinets cannot be suppressed.

A given side of a single cabinet cannot merge with the edges of two different cabinets. The example below shows two instances of cabinets placed back-to-back. Cabinet fronts and joining surfaces are shown.

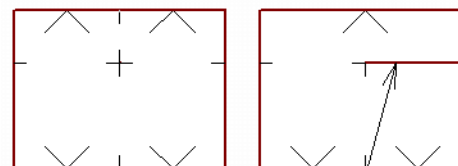

Correct - Widths of front and back cabinets match

Incorrect - Solid line here is not suppressed.

Blind Cabinets

Often, when two cabinets meet in a corner, one is partially hidden by the other. This partially hidden cabinet is called a “blind” cabinet. Home Designer

Suite will resize and offset the front items of the partially hidden cabinet so that they are not located in the hidden portion of the cabinet face.



Cabinet Specification Dialog



Select a cabinet and click the **Open Object** edit button to open the **Cabinet Specification** dialog.

The options in the **Cabinet Specification** dialogs are similar to the corresponding **Cabinet Defaults** dialog. See “Cabinet Defaults” on page 199.

General Panel

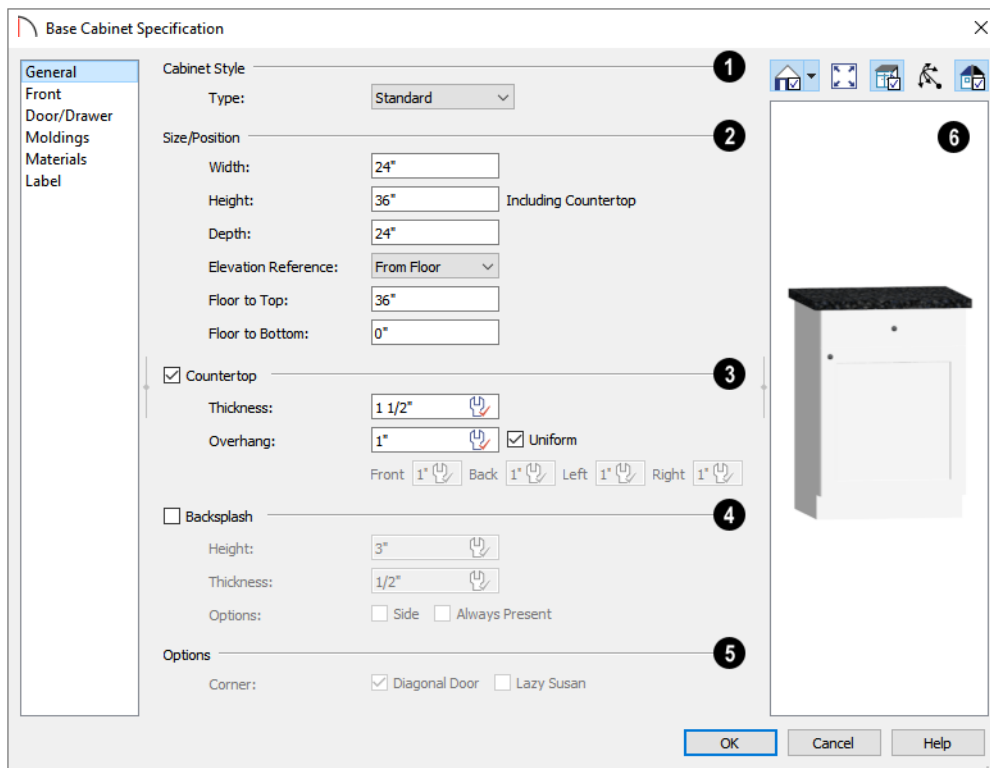

1 A number of **Cabinet Types** are available in the drop-down list. Certain requirements must be met before some types can be specified. See “Special Cabinets” on page 204.

2 **Size/Position** - The selected cabinet’s dimensions and position relative to the floor can be specified here. Fractional values are supported to 1/16th of an inch (1 mm).

- Specify the **Width** of the cabinet box, as measured across the front of the cabinet box from left to right. This does not include the countertop overhang.

- Specify the **Height (Including Counter)** of the cabinet box, as measured from bottom to top. For base cabinets, this value includes the countertop thickness, but not the height of the backsplash.

Note: Height refers to the height of the entire cabinet, including countertop and toe kick. If you change the Countertop Thickness or Toe Kick Height, the cabinet’s total height is not altered. Instead, the cabinet face height and the heights of face items change in response.

- Specify the **Depth** of the cabinet box, as measured from front to back. It does not include the thickness of overlay doors or the countertop overhang.
 - For Corner cabinets, the **Width** and **Depth** fields are instead named **Right Side Width** and **Left Side Width**.
 - Select the **Elevation Reference** from the drop-down list. This determines where the next two settings are measured from and also affects their setting labels.
 - Specify the **to Top** distance, measured from the Elevation Reference to the top of the cabinet's countertop.
 - Specify the **to Bottom** distance, measured from the Elevation Reference to the bottom of the cabinet, including the toe kick.
- 3** Specify the dimensions and style of the selected cabinet's **Countertop**, or uncheck this box to prevent it from having a countertop. Only available for base cabinets.
- Specify the countertop **Thickness**. Changing this value does not alter the cabinet height, but it does affect the height of face items. See "Front Panel" on page 207.
 - Specify the countertop **Overhang**. Uncheck **Uniform** to specify separate values for each side in the fields below, or leave it checked to use the same value for all sides. Overhangs do not generate on sides that are against a wall or another cabinet. See "Cabinet Snapping and Aligning" on page 202.
- 4** Check the box beside **Backsplash**, then specify its dimensions and when it should generate, or leave this box unchecked to prevent the selected base or wall cabinet from having a backsplash.
- Specify the backsplash **Height** and **Thickness**.
 - Check **Side** to add the backsplash to the side of the cabinet if it is against a wall or a taller cabinet. Not available for Corner cabinets.
 - Check **Always Present** to display the backsplash at all times. If unchecked, a backsplash is present only when the cabinet is against a wall.
 - Check **Backsplash to Base Below** to extend a backsplash from the selected wall cabinet down to the backsplash or countertop of the base cabinet below. Only available for wall cabinets.
- Note that while a base cabinet's backsplash is measured from the countertop up, a wall cabinet's backsplash extends downward.
- 5 Options -**
- Uncheck **Diagonal Door** to create double doors at right angles instead of a single diagonal door. This option is checked by default in the **Cabinet Defaults** dialog and is only available for Corner Cabinets. See "Corner Cabinets" on page 204.
 - Check **Lazy Susan** to indicate a lazy Susan in the cabinet's label and its appearance in plan view. This option does not display in 3D views.
- 6** A preview of the selected cabinet displays on the right side of the panel. See "Dialog Preview Panes" on page 25.

Front Panel

If you click on a cabinet face item in the preview on the right side of the dialog, the FRONT panel will become active and that face item will be selected and can be edited.

If the selected cabinet was originally created in Chief Architect Premier or Chief Architect Interiors, some settings on this panel may display for reference only. See "Opening Chief Architect Plans in Home Designer Programs" on page 32.

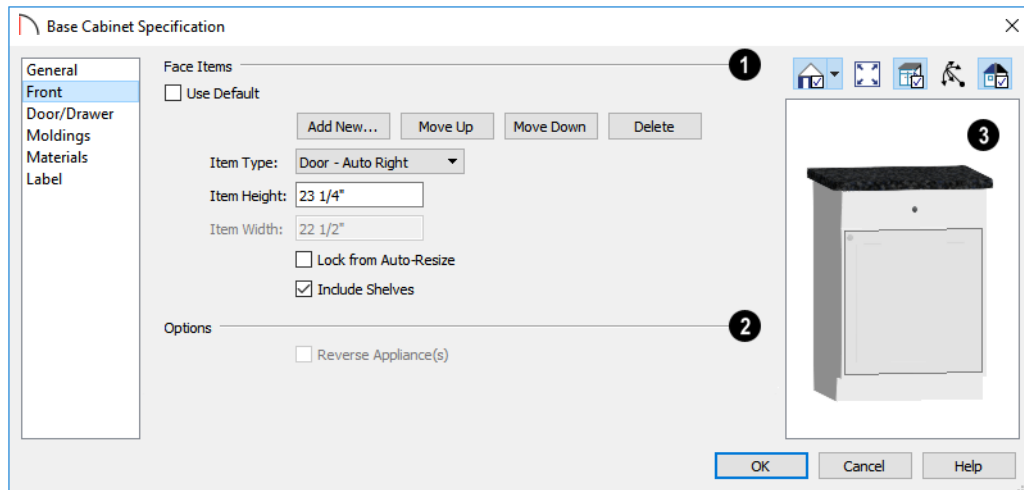

- 1** Most of the **Face Items** settings are only active when a door, drawer, or other face item is selected. To select a face item, click on it in the preview on the right.

When a face item is selected, **Use Default** will be unchecked and its attributes can be edited. The vertical frame pieces on the sides of the cabinet front are referred to as stiles and cannot be selected in the preview. See “Cabinet Face Items” on page 204.

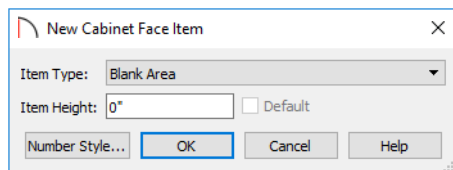

- Click **Add New** to add a new face item directly below the currently selected item. When a face item is added, the height of the lowest item on the cabinet front is reduced to make room for the new item. If you click **Add New** with no face item selected, the new item is added to the bottom of the cabinet face.
- In the **New Cabinet Face Item** dialog, define the **Item Type**, **Item Height**, and click OK. If the Item Type is “Separation”, you can check **Default** to use the default Separation Height.



- Click **Delete** to remove the selected face item. When an Auto Left, Auto Right, Left, Right, or Double Door is deleted, it is replaced by an Opening; when other face item types are deleted, the height of the lowest item is increased to make up the difference. You can also press the Delete key on the keyboard.

The program tries to maintain a single separation between all face items. When you add or delete a face item, separations are usually added or deleted with them.

- Click **Move Up** to move the currently selected item up one position, switching places with the item directly above.
 - Click **Move Down** to move the currently selected item down one position, switching places with the item directly below.
 - Choose the selected face item’s **Item Type** from the drop-down list:
 - Specify the selected face item’s **Item Height**. Fractional values are supported to 1/16th of an inch (1 mm). For doors and drawers, this is the height of the opening rather than the item front height. For best results, edit face item heights starting at the top of the cabinet and work down. See “Cabinet Face Items” on page 204.
 - The selected item’s **Item Width** displays here for reference only. For doors and drawers, this is the width of the opening rather than the item front width.
 - Check **Lock from Auto Resize** to prevent the selected face item from resizing when the cabinet is resized.
 - Check **Include Shelves** to include shelves in the selected “Door” or “Opening” face item.
- 2** Check **Reverse Appliance(s)** to reverse any appliances inserted into the selected cabinet from left to right: for example, to move a dishwasher’s controls from the left side to the right.

- 3 A preview of the selected cabinet displays on the right side of the panel. See “Dialog Preview Panes” on page 25.
- **Select Cabinet Face Item**  mode is active by default and allows you to click on a face item like a door, drawer, or separation in the preview to select it for editing. The selected face item is highlighted in grey.
 - **Mouse-Orbit Camera**  mode allows you to orbit around the preview of the cabinet. When this is active, you can right-click on a front item to select it.
 - The cabinet **Label** displays below the preview pane.

Door/Drawer Panel

The settings on the DOOR/DRAWER panel allow you to control the appearance of the selected cabinet’s doors, drawers and hardware.

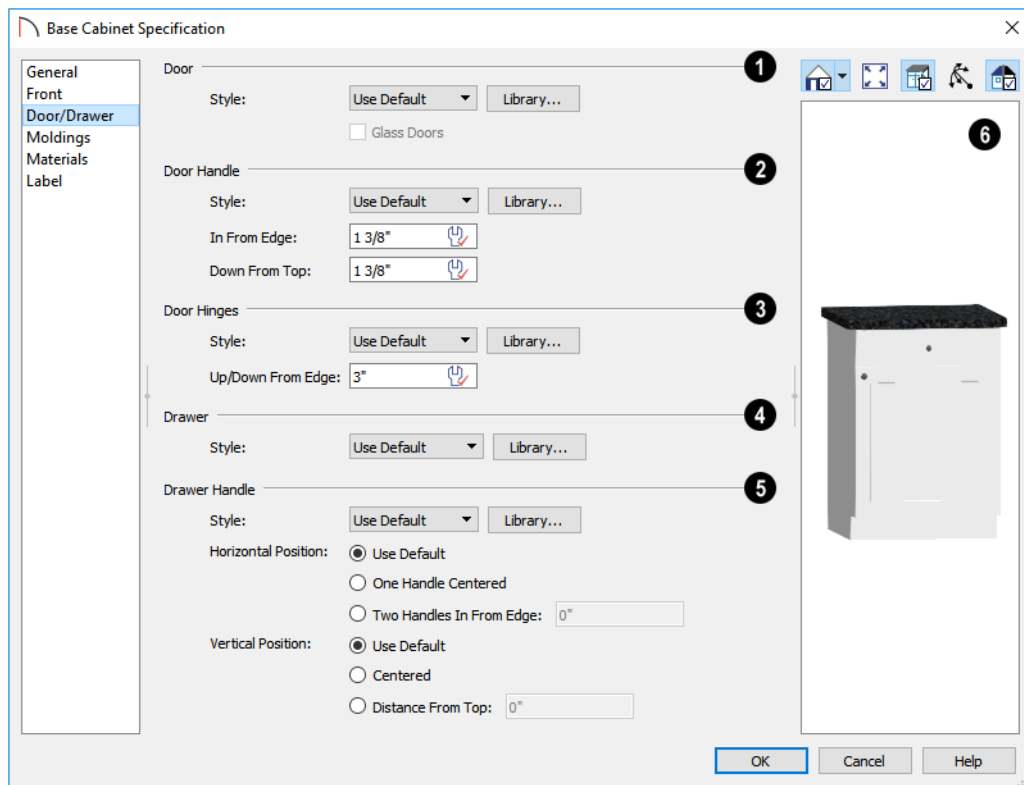

- 1 Specify the appearance of the **Doors** applied to selected cabinet.
- Select a door **Style** from the drop-down list. See “Doors, Drawers and Panels” on page 204.
- Select “Use Default” to apply the door style specified in the defaults dialog for the selected cabinet’s type. See “Cabinet Defaults” on page 199.
 - Select “Slab Doors” to apply a flat door front or “Framed Doors” to apply a door with a frame and flat panel front.
 - Select “Library” or click the **Library** button to select a cabinet door from the library. If a library door has been previously selected, its name will display in the list. See “Select Library Object Dialog” on page 283.
 - Check **Glass Doors** to use a glass material for the panel of Framed doors or for the entire door for Slab doors. Not available when “Library” is the selected door Style.
- 2 Specify the characteristics of the selected cabinet’s **Door Handles**.

- Select a door handle **Style** from the drop-down list.
 - Specify the position of the handle **In From Edge**, as measured from the edge of the door opposite the hinges.
 - Specify the height of the handle **Down From Top**, as measured from the top edge of the door. For wall cabinets, this value is measured **Up From Bottom**.
- 3** Specify the characteristics of the cabinet **Door Hinges**.
- Select a door hinge **Style** from the drop-down list.
 - Specify the location of the hinges **Up/Down From Edge**, as measured from the door edge. If the cabinet door is more than 35 1/4" (880 mm) high, three hinges will be created instead of two.
- 4** Select a **Drawer Style** from the drop-down list or choose one from the **Library**. For best results, "Framed" drawers should be at least 6" (150 mm) high.
- 5** Specify the characteristics of the selected cabinet's **Drawer Handles**.
- Select a drawer **Handle Style** from the drop-down list.
 - Specify the **Horizontal Position** of the drawer handle(s): Choose **Use Default** to use the default position; **One Handle Centered** for a single handle centered on the drawer face; or **Two Handles In From Edge** for two handles set in from the drawer sides by the value specified in the text field.
- Specify the **Vertical Position** of the drawer handle(s): Choose **Use Default** to use the default position, **Centered** for handle(s) centered on the drawer face, or specify the handle's **Distance From Top**.
- 6** A preview of the selected cabinet displays on the right side of the panel. See "Dialog Preview Panes" on page 25.
- The cabinet **Label** displays below the preview pane.

Moldings Panel

The settings on the MOLDINGS panel allow you to assign one or more horizontal moldings around the selected cabinet. See "Editing Cabinet Styles" on page 204.

For information about the settings here, see "Moldings Panel" on page 268.

Materials Panel

The settings on the MATERIALS panel affect the appearance of the selected cabinet in 3D views. For information about these settings, see "Materials Panel" on page 296.

Label Panel

Cabinet labels display in plan view when the "Cabinets, Labels" layer is turned on and use the Text Style assigned to that layer.

For more information about the settings on this panel, see "Label Panel" on page 166.

Shelf/Partition Specification Dialog



Select a shelf or partition and click the **Open Object** edit button to open the **Shelf Specification** or **Partition Specification** dialog.

The options in these specification dialogs are similar to the corresponding defaults dialogs. See "Cabinet Defaults" on page 199.

General Panel

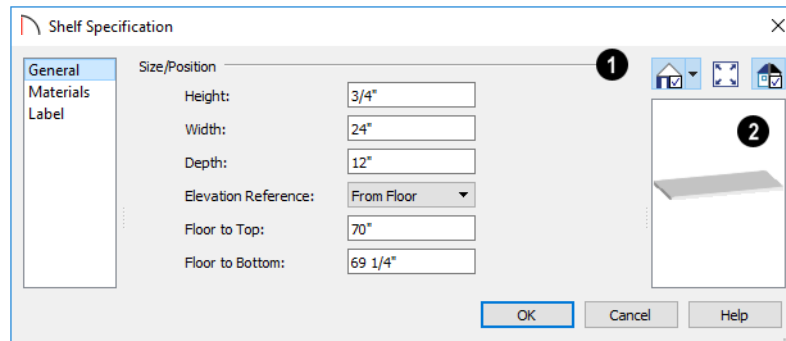

1 **Size/Position** - Specify the **Height**, **Width**, and **Depth** of the shelf or partition.

- Select the **Elevation Reference** from the drop-down list. This determines where the next two settings are measured from and also affects their setting labels.
- Specify the **to Top** distance, measured from the Elevation Reference to the top of the shelf or partition.
- Specify the **to Bottom** distance, measured from the Elevation Reference to the bottom of the shelf or partition.

2 A preview of the selected object displays on the right side of the panel. See “Dialog Preview Panes” on page 25.

Materials Panel

The settings on the MATERIALS panel affect the appearance of the selected object in 3D views. For information about these settings, see “Materials Panel” on page 296.

Label Panel

Shelf and Partition labels display in plan view when the “Cabinets, Labels” layer is turned on and use the Text Style assigned to that layer. The Automatic Labels for Shelves and Partitions are blank, but you can specify custom labels

For more information about the settings on this panel, see “Label Panel” on page 166.

Electrical

The electrical plan shows the location of all electrical objects such as lights, switches, outlets, smoke detectors and vent fans. Basic wiring diagrams show which objects share circuits and the locations of the controlling switches.

Electrical objects can be displayed in 2D and 3D views. Some electrical light fixtures also add light sources to 3D views. See “Lighting” on page 320.

Usually, the electrical plan is one of the last additions to a plan since the position of most electrical objects is determined by the location of walls, cabinets and other objects.

 Building requirements vary throughout the country and around the world. It is your responsibility to comply with local codes.

Chapter Contents

- The Electrical Tools
- Placing Electrical Objects
- Auto Place Outlets
- Creating Wiring Schematics
- Electrical Library Content
- Displaying Electrical Objects
- Editing Electrical Objects

The Electrical Tools

 Select **Build> Electrical** to access the Electrical Tools.



Most electrical objects are easily created with a single click in plan and camera views. See “Click-to-Create” on page 69.

Some electrical objects are designed to be inserted into walls, floors, ceilings or cabinets, although some can also be free-standing. See “Placing Electrical Objects” on page 214.

Different outlet, switch, and light fixture symbols can be placed in different room types. To take advantage of the program’s capabilities, define room types properly before placing electrical objects. See “Room Types” on page 132.

Once created, outlets, switches, and lights can be selected and edited. See “Editing Electrical Objects” on page 217.

Outlets

  Select **Build> Electrical> 110V Outlet** to place 110 volt duplex outlets on walls, the on floor, and on the sides of cabinets and soffits. Select **Build> Electrical> 220V Outlet** to place 220 volt outlets.

The type and height of an outlet will vary depending on where it is placed. For example:

- In rooms defined as Bath or Master Bath, Ground Fault Circuit Interrupt (GFCI) outlets are placed.

 If standard outlets are placed in a room prior to defining it as a Bath, you should replace them with GFCI outlets.

- An outlet placed at the back of a base cabinet in plan view is positioned above the counter.
- An outlet placed at the back of a base cabinet containing a kitchen sink is placed at the standard 11 1/2" (300 mm) above the floor.
- An outlet placed on the side of a cabinet or soffit will be positioned 32" (800 mm) up from that object's bottom.
- An outlet placed outside the building or in an exterior area such as a deck or porch will be weatherproof.

Light Fixtures

 Select **Build> Electrical> Light** to place light fixtures on walls, the ceiling, or on soffits. All light fixtures placed in a plan can also serve as light sources in 3D views. To place a light fixture using the Light tool:

- Click near a wall or the side of a soffit to place a wall-mounted fixture at that location.
- Click away from a wall to place a ceiling mounted light.
- Click on the center of a soffit to place a ceiling mounted light on the soffit's bottom surface.
- Click outside of a room and away from a wall to place a path light.
- Some light symbols from the library can be mounted under wall cabinets, as well.

Switches

 Select **Build> Electrical> Switch** to place electrical switches on walls or on the sides of

cabinets or soffits. Like outlets, the height of switches is measured from the floor to the center of the object.

- A switch placed on the side of a cabinet or soffit will be positioned 32" (800 mm) up from that object's bottom.
- Switches placed outside the building or in an exterior area such as a deck or porch will be weatherproof.

 If you connect two or more switches in a circuit, they update to 3-way or 4-way switches automatically.

Auto Place Outlets

 Select **Build> Electrical> Auto Place Outlets** and click in a room tool to place outlets at regular intervals around the entire room. See "Auto Place Outlets" on page 215.

Connect Electrical

 Select **Build> Electrical> Connect Electrical**, then click and drag to draw splines that snap to electrical switches, outlets, and lights to illustrate wiring circuits. See "Creating Wiring Schematics" on page 215.

Lighting and Electrical Library Catalogs

 A selection of free-standing and ceiling-, wall- and cabinet-mounted light fixtures is available in the Library Browser at Home Designer Core Catalogs> Architectural> Lighting.

Special use outlets, switches, jacks and numerous other electrical items can be found at Home Designer Core Catalogs> Mechanical, Electrical, Plumbing> Electrical. See "The Library" on page 271.

Placing Electrical Objects

Electrical switches, outlets, lights, and other symbols can be created with a single click in any view. They can also be placed from the Library. See "Click-to-Create" on page 69.

When the Outlet, Switch, and Light tools are used, the type and height of the object that is created will vary depending on where it is placed. As you move your mouse pointer around the view, an object

preview will display near the pointer whenever it is over a location where an object can be placed. Specific details for each tool are noted in "The Electrical Tools" on page 213

The electrical objects in the Library are typically designed for a specific use and can only be placed on a wall, on the floor, or on the ceiling. Some are instead free-standing and are designed to be placed

on a table or the floor. See “Placing Library Objects” on page 281.

Wall mounted outlets, switches, and Library symbols can also be placed on the sides of cabinets and soffits. They will snap to the outside of the cabinet box but will ignore doors and drawers.

When a light fixture is created using any method, including copying and pasting, it will always be turned On. This is the case even if the default symbol is turned Off.

Auto Place Outlets

 Select **Build> Electrical> Auto Place Outlets** and click in a room to place 110 volt outlets on the walls around the entire room, spaced so that no wall position is farther than six feet (1800mm) from the nearest outlet. 110 or 220 volt outlets are also placed behind large appliances. In addition, a light is placed above each sink.

It is important that a room’s Type be defined before

Auto Place Outlets  is used so that outlets are placed appropriately. For example, GFCI (Ground Fault Circuit Interrupter) outlets are placed over cabinets in Kitchen, Bath and Master Bath rooms. See “Room Types” on page 132.

Creating Wiring Schematics

Electrical schematics can be created in two ways.

Using the **Connect Electrical**  tool is quick and easy, but if you need detailed schematics, you can create your own wiring diagrams using the CAD tools. See “CAD Objects” on page 101.

Connect Electrical



 Select **Build> Electrical> Connect Electrical**, then click and drag to draw splines that snap to electrical switches, outlets, and lights to illustrate wiring circuits.

To create a new circuit or add to an existing circuit, click on a switch, outlet, or light while the **Connect Electrical**  tool is active, drag to the next object

Electrical Object Heights

When a wall-mounted electrical object is placed in plan view, its initial height off the floor is based on commonly used standards.

In 3D views, an electrical object placed on a wall in a 3D view will snap to the standard height for its type provided that the mouse pointer is near that height when you click. If you move the mouse pointer away from the standard height, the object will be positioned wherever you click on the wall, regardless of the height at that point.

Auto Place Outlets  does not work in rooms assigned an exterior room type such as Deck. To place outlets in an exterior room, place them from the Electrical Library or use the **110V Outlet**  tool.

Railings and invisible walls are ignored by **Auto**

Place Outlets . If it is used in a room defined by railings or invisible walls, outlets are automatically placed in any adjacent rooms on the other side of these wall types. See “Room Definition” on page 131.

Once placed, any outlet can be moved, edited, or deleted. See “Editing Electrical Objects” on page 217.

and release. When a **Connect Electrical**  spline is first drawn, it looks like an arc but actually consists of two segments that are defined by vertex points. When selected, its edit handles display at each of these vertices. If you click and drag one of these edit handles, the length, angle, and curvature of the spline will change but the other vertices will not move.

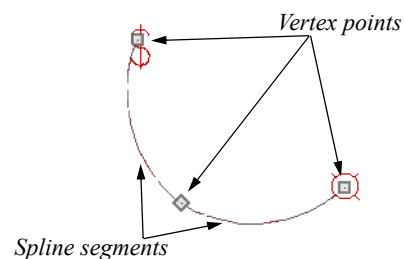

Connect Electrical  splines cannot be snapped to one another: they can only snap to electrical objects. Once drawn, though, additional vertices can be added and used to form complex curves. See “Editing Spline-Based Objects” on page 90.

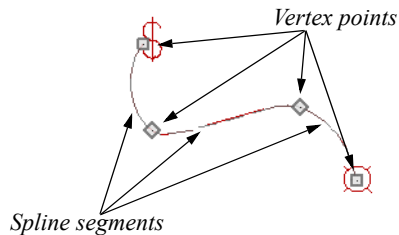

To remove a connection from a circuit, simply select and **Delete**  it. If you remove an electrical object

from a circuit, any Connect Electrical splines snapped to it will also be deleted. See “Deleting Objects” on page 98.

Three- and Four-Way Switches

Multiple switches can control an object or group of objects.

- Two switches controlling the same objects are referred to as three-way switches.
- Three switches controlling the same objects are called four-way switches.

In plan view, a three- or four-way switch’s “way” number will automatically display in its 2D symbol.

Electrical Library Content



Select **View > Library Browser** to access a variety of electrical symbols. See “The Library” on page 271.

Browse for electrical objects such as bath vent fans, an electrical panel, fluorescent lights, chandeliers, a smoke detector, thermostat, and more. Select a

symbol, then click in your plan to place it on a wall, floor, or ceiling.

Adding Electrical Content

Any electrical symbol placed into a plan can be customized and added to the User Catalog in the Library Browser. See “Add to Library” on page 279.

Displaying Electrical Objects



The display of electrical objects and connections is controlled in the **Display Options** dialog. See “Layer Attributes” on page 74.

When displayed in 3D views, light fixtures act as sources of light that help illuminate the 3D model. See “Lighting” on page 320.

In plan view, electrical objects are represented by commonly used CAD symbols that represent the type of object rather than its appearance in 3D.

Like other objects, electrical objects are placed in Drawing Groups that affect whether they display in front of or behind other objects in plan view. You can modify a selected object’s place in the drawing order by clicking the **View Drawing Group Edit**

Tools  edit button. See “Drawing Group Edit Tools” on page 76.

Electrical symbols are placed on the “Electrical” layer, while Connect Electrical splines are drawn on the “Electrical, Connections” layer.

Electrical Labels

Electrical labels display in plan view when the “Electrical, Labels” layer is turned on and use the “Default Label Style” Text Style. See “Object Labels” on page 166.

Customized labels can be specified in the **Electrical Service Specification** dialog.

Note: Some electrical objects are represented in plan view by a symbol that includes text. This text is not part of the object’s label and does not use the Default Label Text Style.

In the Materials List

Electrical objects, including outlets, switches, lights, and symbols from the library, are listed under the Electrical Category in the Materials List. Connect

Electrical splines are 2D objects only, however, and are not calculated. See “Materials Lists” on page 377.

Editing Electrical Objects

Electrical objects can be selected as a group and individually in 2D and 3D and edited using the edit handles and the edit toolbar

Moving Electrical Objects Using Dimensions

Electrical objects can be moved precisely using dimensions. See “Moving Objects Using Dimensions” on page 154.

Electrical objects are not located by dimension lines as the lines are drawn. Once created, though, you can edit a dimension line’s extensions to locate the center of any electrical object. See “Editing Extension Lines” on page 152.

Using the Edit Handles

The edit handles for electrical objects vary depending on the location of the object.

- Wall mounted electrical objects cannot be rotated, so only the Move edit handle displays.
- Electrical objects placed on floors and ceilings can be rotated.
- In 3D views, some ceiling mounted and free-standing light fixtures can be resized.
- Electrical connections  are edited like splines. See “Editing Spline-Based Objects” on page 90.

Using the Edit Tools

A selected electrical symbol can be edited in a variety of ways using the buttons on the edit toolbar. See “The Edit Toolbar” on page 23.

In the Specification Dialog

Electrical objects can be edited in the **Electrical Service Specification** dialog. See “Electrical Service Specification Dialog” on page 217.

Adjusting Electrical Object Heights

When a wall- or cabinet-mounted electrical object is placed, its initial height is based on commonly used standards. See “Placing Electrical Objects” on page 214.

Once placed, a wall-mounted electrical object’s height can be edited in either of two ways:

- Specify the height in the **Electrical Service Specification** dialog. See “General Panel” on page 218.
- In 3D views, the position of an electrical object can be adjusted using its edit handles.

Deleting Electrical Objects

An electrical object can be deleted by selecting it and clicking the **Delete**  edit button or by pressing the Delete key.

All electrical objects in a room, on a floor, or in the entire plan can also be deleted as a group using the **Delete Objects** dialog. See “Deleting Objects” on page 98.

Electrical Service Specification Dialog



Select an electrical object and click the **Open Object** edit button to open the **Electrical Service Specification** dialog. The settings in this

dialog vary, depending on the type of object you select.

General Panel

The items on this panel vary, depending on the type of electrical object selected.

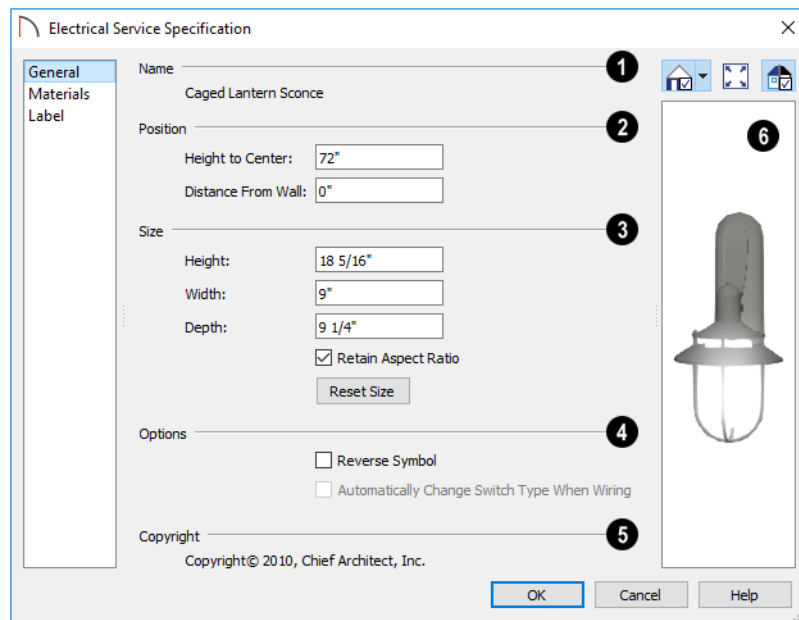

1 The **Name** of the selected object as used in the Library Browser and Materials List displays here.

2 Specify the **Position** of the selected electrical object. The options available depend on the type of object selected.

- Specify the **Offset From Ceiling** of a ceiling outlet or ceiling mounted light. If the light is mounted to a cabinet, this value is the offset from the cabinet.
- Specify the **Height to Center** of a switch, wall outlet or wall light.
- Specify the **Offset From Floor** of a floor outlet or floor lamp.
- Specify the **Distance From Wall** of a wall mounted symbol. A negative value will recess the symbol into the wall and may prevent it from being seen in 3D.

3 Specify the **Size** of the selected electrical symbol.

- Specify the **Height**, **Width** and **Depth** of the selected symbol.
- Uncheck **Retain Aspect Ratio** if you would like to modify one of the above values without affecting the others. Doing so may cause the symbol's

shape to become distorted. This check box does not affect editing performed outside of this dialog and is an action rather than a state: the next time you open this dialog, it will be checked.

- Click the **Reset** button to restore the electrical symbol's original size.

4 **Options** -

- Check **Reverse Symbol** to reverse the object's appearance so that features on its left are located on its right and vice versa. Does not affect symmetrical symbols.
- Check **Automatically Change Switch Type When Wiring** for a selected switch to become a three- or four-way switch if your wiring plan uses it as such. See "Connect Electrical" on page 215.

Switches placed from the toolbar use this option by default; switches placed from the library do not.

5 Any **Copyright** information associated with the selected symbol will be stated here.

6 A preview of the selected object displays here. See "Dialog Preview Panes" on page 25.

Materials Panel

The MATERIALS panel is found in the specification dialogs for a variety of objects. For more information, see “Materials Panel” on page 296.

Label Panel

Labels for electrical fixtures display in plan view when the “Electrical, Labels” layer is turned on and

use the “Default Label Style” Text Style. See “Electrical Labels” on page 216.

For information about the settings on this panel, see “Label Panel” on page 166.

Foundations

There are two foundation types in Home Designer Suite: stem walls with footings and monolithic slab. The foundation type can be specified in the **Foundation Defaults** dialog when the foundation is built on Floor 0.

 Always consult registered geotechnical and civil engineers for information regarding the proper foundation for your site.

Chapter Contents

- Foundation Defaults
- Building a Foundation
- Displaying Foundations
- Editing Foundations
- Deleting Foundations
- Foundations and Rooms
- Foundations and the Terrain
- Library Fireplaces.
- Chimneys

Foundation Defaults



Foundation Defaults can be accessed by selecting **Edit > Default Settings**.

Select “Foundation” and click the **Edit** button to open the **Foundation Defaults** dialog.

The settings in the **Foundation Defaults** dialog are similar to those in the **Build Foundation** dialog, which opens when **Build > Floor > Build**

Foundation  is selected. The primary difference is that when you click **OK** in the **Foundation Defaults** dialog, no changes are made to the model. See “Building a Foundation” on page 222.

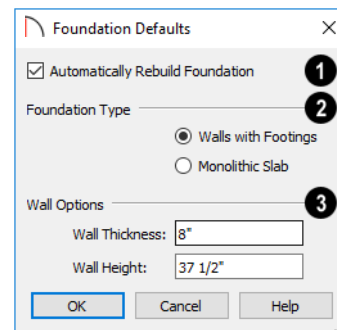

- 1 Check **Auto Rebuild Foundation** to automatically rebuild the foundation whenever changes are made to Floor 1 that affect the structure of the foundation. See “Rebuilding Foundations” on page 223.
- 2 Click the radio button beside either **Monolithic Slab** or **Walls with Footings** to specify which foundation type the program should build.

- 3 Wall Options** - Specify characteristics of the foundation walls.
- **Wall Thickness** - Specify the desired thickness of the foundation walls. See “Wall Thickness” on page 120.
 - **Wall Height** - Specify the desired height of the foundation walls.

If the wall height is at least 6 feet (1800 mm), a slab floor is generated above the footings and inside the foundation walls. The Wall Height includes the thickness of this slab.

If you do not want this slab, specify the “rooms” on Floor 0 as **Open Below** in the **Room Specification** dialog. See “Available Room Types” on page 133.

Building a Foundation



Two foundation types are available: stem walls with footings and monolithic slabs. The first option is created using walls; the second creates concrete slabs with footings.

Automatically built foundations are placed on Floor 0 and are based on wall positions and floor heights on Floor 1. Foundation walls or slab footings are generated under:

- All exterior walls on Floor 1 that define a room other than a Deck type room. See “Room Definition” on page 131.
- Any interior walls on Floor 1 defining rooms with different floor heights. See “Floor and Ceiling Heights” on page 138.

At least one room must be defined on Floor 1 for a foundation to be automatically generated. If no rooms are defined on Floor 1, a blank Floor 0 is created.

To build an automatic foundation

1. Select **Build > Floor > Build Foundation** .
2. Specify the desired foundation type and other information in the **Build Foundation** dialog. The settings in this dialog are similar to those in

the Foundation Defaults dialog. See “Foundation Defaults” on page 221.

3. In the **New Floor** dialog, select **Derive new Foundation plan from the 1st floor plan** and click **OK** to build a foundation based on Floor 1.

If you prefer, you can instead select **Make new (blank) plan for the Foundation** to create an empty foundation level where you can manually draw foundation walls or slabs.

In most cases, it is preferable to base Floor 0 off the first floor plan and then manually edit the foundation as needed. See “Editing Foundations” on page 223.

Mixing Foundation Types

You can also create a foundation that combines stem walls and/or monolithic slabs.

To create a foundation of multiple types

1. Begin by specifying any rooms on Floor 1 that require a slab floor as either a Garage or Slab **Room Type**. See “Foundations and Rooms” on page 224.
2. **Build Foundation** , as described above.

Displaying Foundations



The display of foundation walls, slabs, curbs and footings is controlled in the **Display Options** dialog. See “Display Options Dialog” on page 74.

- Foundation Walls, including slab footings and Garage curbs, are placed on the “Walls, Foundation” layer.
- Footings under slab footings and Foundation Walls are placed on the “Footings” layer.
- Deck post footings are placed on the “Footings, Deck Post” layer.
- In stem wall foundations, brick ledge lines in plan view are on the “Slabs” layer; in monolithic slab foundations, they are on the “Walls, Foundation” layer. See “Brick Ledges” on page 113.
- The “Foundations” layer controls the display of all objects on Floor 0 in 3D views but does not affect plan view.

If a door on Floor 1 extends into a stem wall or curb defining a Garage room, its location will be indicated on Floor 0.

In 3D views, all objects on Floor 0 will only display when the “Foundation” layer is turned on.

While the display of foundation walls and their footings can be controlled independent of one another in plan view, in 3D views this is not the case. If a foundation wall is set to display, its footing will

as well - even if the “Footings” layer is turned off. The reverse is also true - if a foundation wall’s display is turned off, so will its footing’s.

The display of monolithic slab foundations in 3D views is controlled by the “Foundation” layer. Slab footings are located on the “Walls, Foundation” layer; but if this layer is turned off, any slab footings that define a foundation room will continue to display as long as the “Foundation” layer is on.

Editing Foundations

Stem wall with footings and monolithic slab foundations are both created using walls which enclose room areas.

- Foundation walls can be selected and edited much like other walls. See “Editing Walls” on page 119.
- Foundation rooms can also be selected and edited like other rooms. See Foundations and Rooms.

Rebuilding Foundations

By default, foundations update automatically when changes are made to the structure on Floor 1. For example, if exterior walls are moved or floor platforms are raised or lowered, the foundation will be rebuilt.

If you prefer that the foundation not rebuild automatically, you can uncheck **Auto Rebuild Foundation** in the **Foundation Defaults** dialog. See “Foundation Defaults” on page 221.

You can also rebuild an automatically generated foundation by selecting **Build > Floor > Build**

Foundation  from the menu.

When **Auto Rebuild Foundation** is enabled, walls cannot be edited, manually drawn or deleted on Floor 0. When the foundation is rebuilt, any manually drawn or edited walls are deleted. Similarly, rooms on Floor 0 cannot be edited while this option is enabled. If you try to draw a wall or edit a room or a wall while **Auto Rebuild Foundation** is turned on, a warning message will display.

Changing Foundation Types

When a foundation is generated, the program creates **Floor Defaults** settings for Floor 0 based on the information in the **Build Foundation** dialog. If you specify a Monolithic Slab foundation, the default

Floor Structure on Floor 1 will also be changed to a slab rather than a framed platform. See “Floor Defaults Dialog” on page 227.

If you rebuild the foundation using a different Foundation Type, it is advisable to check the floor heights of all rooms on Floor 1 - particularly Garage and Slab rooms, as well as any rooms that do not use the default floor height of 0”.



To avoid unexpected results, it is recommended that you not change the Foundation Type once the foundation is built.

Stem Wall Height

When a foundation is created, all of Floor 0 uses the stem wall height specified in the **Foundation Defaults** dialog,

This height is measured from the bottom of floor platform of Floor 1 to top of the stem walls’ footings. If Floor 1 has multiple floor platform heights, the foundation stem walls will be stepped.

Once a foundation is created, stem wall heights can be adjusted either on a room-by-room basis or for individual walls.

To change a room’s stem wall height

1. Select a room on Floor 0 and click the **Open Object**  edit button.
2. Specify the desired **Stem Wall Height** in the **Room Specification** dialog. See “General Panel” on page 142.
3. If you wish to reduce the **Stem Wall Height**, you will first need to reduce the **Ceiling Height** value by the same amount.

If adjacent rooms have stem wall heights that differ by at least 1/16 of an inch, the stem wall separating them uses the larger of these two values.

Deleting Foundations



Select **Build> Floor> Delete Foundation** to delete the entire foundation floor.

You can also select and delete individual foundation walls and slabs by clicking the **Delete**  edit button

or pressing the Delete key. See “Deleting Objects” on page 98.

Deleting and rebuilding the foundation is often the quickest way to update the model when substantial changes are made to Floor 1 after the foundation is built.

Foundations and Rooms

When a foundation plan is created, rooms included in the Living Area calculation generate a stem wall or slab foundation below them. Garage rooms generate slab foundations, but exterior rooms such as Decks, Courts and Balconies do not generate any foundation. See “Room Types” on page 132.

Interior foundation walls are not generated unless:

- They separate the area under a Slab or Garage room from the rest of the plan;
- They define areas under rooms with different floor heights.

Note: To remove all or part of the concrete slab in the basement area, select a basement room and define it as Open Below in the Room Specification dialog.

- The floor height will drop 3 1/2” (88 mm) in a Monolithic Slab foundation.

To build a Garage slab with stem walls

1. Before the foundation is generated, specify the room as a Garage or Slab.
2. Build a Wall with Footings foundation.

To build a Garage slab with curbs

1. Before the foundation is generated, specify the room as a Garage or Slab.
2. Build a Monolithic Slab foundation, specifying the required Lower Garage Floor value.

Basement Rooms

When a foundation’s type is Walls with Footings and it is assigned a Minimum Wall Height of 76” (1900 mm) or greater, the resulting basement is automatically created with a 4” (100 mm) concrete slab floor and a default Floor Finish like that on Floor 1.

Similarly, if a foundation is set up to have a Basement Ceiling Height of 72” (1800 mm) or greater when built, it is automatically given a painted drywall Ceiling Finish.

Regardless of its ceiling height, however, you can specify a ceiling finish for any room in the **Room Specification** dialog. See “Structure Panel” on page 143.

Garages

When a foundation is generated based on the floor plan of Floor 1, a room on the first floor specified as either a Garage or Slab type will receive a foundation with a slab floor and stem walls. If a monolithic slab foundation is generated, the room will receive a slab floor with curbs.

By default, a room on Floor 1 specified as a Garage or a Slab will be assigned a lower floor height when the foundation is built. The amount that it is lowered depends on the foundation type:

- The floor height will drop the default thickness of the floor platform for Floor 1 plus 12” (300 mm) - a total of 24 5/8” (618 mm) - in a Walls with Footings foundation.

The resulting basement can be divided into separate rooms using **Interior Walls**  or any wall type you wish.

Foundations and the Terrain

Home Designer Suite automatically raises the structure in a plan a set distance above the terrain. See “Terrain Height vs Floor Height” on page 350.

In a plan with a foundation present, the terrain will be:

- 6” (187 mm) below the top of the stem walls in a Walls with Footings foundation.
- 8” (200 mm) below the top of the slab in a Monolithic Slab foundation.

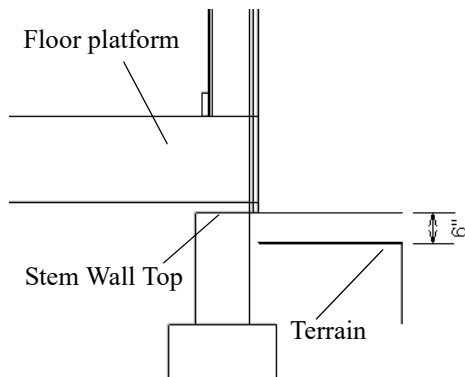

By default, the program will also create a flattened pad under the building footprint.

Not all foundations have these requirements, of course, so you can customize your foundation and terrain to suit your needs.

Daylight Basements

Daylight basements, also referred to as look-out basements, have walls that are tall enough for basement windows to be positioned above the terrain. They are often found in split level or split entry structures.

To create a daylight basement condition, build a stem wall foundation and modify these settings in the **Terrain Specification** dialog:

- Uncheck **Auto Calculate Elevation**.

- Increase the **Building Pad Elevation**, which is the distance between the default floor height of Floor 1 and the terrain.

Walkout Basements

Walkout basements are a type of daylight basement typically located on sloped terrain. They feature walls that are above ground at the lower end of the slope so that a door can be positioned above the terrain at that end.

To create a walkout basement, build a stem wall foundation and modify these settings in the **Terrain Specification** dialog:

- Uncheck **Flatten Pad**.
- Uncheck **Auto Calculate Elevation**.

You will also need to create sloped terrain and adjust the **Building Pad Elevation** and/or terrain data so that the terrain is at the appropriate height relative to the structure at both the high and low ends of the slope.

Stepped Foundations

Stepped foundations are usually built on sloping terrain. A stepped foundation will be produced automatically if more than one floor height is present on Floor 1 when the foundation is built.

As with a walkout basement, you will need to build a stem wall foundation and modify these settings in the **Terrain Specification** dialog:

- Uncheck **Flatten Pad**.
- Uncheck **Auto Calculate Elevation**.

You will also need to create sloped terrain and adjust the **Building Pad Elevation** and/or terrain data so that the terrain is at the appropriate height relative to the structure at both the high and low ends of the slope.

You can also create a stepped foundation by editing foundation rooms. See “Stem Wall Height” on page 223.

Library Fireplaces

A variety of fireplace symbols are available in the library. Flush fireplaces are designed to snap to wall surfaces. Some fireplace symbols can be enclosed by walls or positioned to project through a wall. See “Placing Library Objects” on page 281.



Always check the manufacturer's product information for the framing and clearance requirements of the fireplace unit you plan to use, and design your plan accordingly

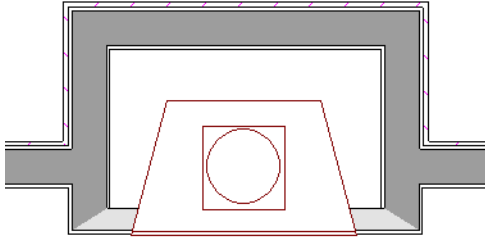

Open Front fireplace projecting through a wall

Chimneys

Chimneys can be created using a variety of methods.

Masonry Fireplace Chimneys

To create a chimney on a masonry fireplace

1. Select the fireplace in a 3D view.
2. Ctrl + drag the top edge of the chimney upward through all the floors and the roof until it is to the desired height. See “Unrestricted Movement” on page 93.
3. When the chimney is approximately the correct height, select the fireplace, click the **Open Object**  edit button, and type in the exact height.

Chimney Chases and Caps

There are two ways to draw a chimney chase:

- Place a closed box Geometric Shape or Soffit over the chimney chase, resize it to match, then increase its height either in its specification dialog or in a 3D view using the same method as extending a masonry fireplace.
- Use walls to define the chimney chase as a room area, making sure these walls are aligned between floors. The chimney chase “room” on the uppermost floor should have a much higher ceiling than the other rooms on that floor and should also have no ceiling or roof. See “Room Specification Dialog” on page 141.

A selection of chimney tops is available in the library. In addition, custom chimney caps can be made using Geometric Shapes and/or Soffits. See “Other Objects” on page 289.

Multiple Floors

When a new plan file is opened in Home Designer Suite, two floor levels are present: Floor 1 and the Attic Floor. You can add more floors whenever you like: up to 3 total. Once created, floors can also be copied and deleted.

Home Designer Suite also supports special floors for foundations and attics. Only one foundation level and one attic can exist in a plan. Foundations are discussed in their own chapter. See “Foundations” on page 221.

Chapter Contents

- Floor Defaults Dialog
- Floor Tools
- Adding Floors
- Displaying Floors
- Exchanging Floors
- Deleting Floors
- Split Levels
- The Current Floor
- The Attic Floor
- The Reference Floor

Floor Defaults Dialog



There is a **Floor Defaults** dialog for each floor in a plan file aside from the Attic floor, which can be accessed by selecting **Edit > Default Settings**. Click the arrow to the left of “Floors and Rooms” to expand the category, then expand the “Floor Levels” subcategory. Select a floor level and click the **Edit** button to open the **Floor Defaults** dialog for that floor. See “Default Settings vs Preferences” on page 47.

The **Floor Defaults** dialog also opens whenever you add a new floor to the plan. See “Adding Floors” on page 228.

The **Floor Defaults** dialog does not open when you build a foundation; however, the **Floor 0 Default** settings are created based on the current Foundation Defaults. See “Building a Foundation” on page 222.

The **Floor Defaults** dialog is similar to the **Room Specification** dialog, but controls the default settings for all rooms on the floor in question. The settings

here also control the height of individual walls as they are drawn on that floor. See “Room Specification Dialog” on page 141.

Note: The default floor height for Floor 1 is 0. It can be modified in the Room Specification dialog, but not in the Floor 1 Defaults dialog. See “Floor and Room Defaults” on page 132.

Structure Panel

The settings on the **STRUCTURE** panel are similar to those in the **Room Specification** dialog. See “Structure Panel” on page 143.

Moldings Panel

The settings on the **MOLDINGS** panel are similar to those in the **Room Specification** dialog. See “Moldings Panel” on page 144.

Fill Style Panel

The settings on the FILL STYLE panel are similar to those in the specification dialogs for many objects throughout the program. See “Fill Style Panel” on page 76.

Materials Panel

The settings on the MATERIALS panel are similar to those in the specification dialogs for many objects throughout the program. See “Materials Panel” on page 296.

Floor Tools



Select **Build > Floor** to access the floor tools.



Select **Build > Floor > Build New Floor** to build a new floor. A new floor can be generated based upon the perimeter of the floor below or a blank floor can be created and drawn from scratch. See “Adding Floors” on page 228.



Choose **Build > Floor > Delete Current Floor** to remove the Current Floor from the plan. For

more information, see “Deleting Floors” on page 229.



Choose **Build > Floor > Build Foundation** to open the **Foundation Defaults** dialog and build a foundation floor. See “Building a Foundation” on page 222.



Select **Build > Floor > Delete Foundation** to remove the foundation from the plan. See “Deleting Foundations” on page 224.

Adding Floors

When a new plan file is opened in Home Designer Suite, two floor levels are present: Floor 1 and the Attic Floor. You can add up to 3 total living floors, as well as create a foundation below Floor 1.

Floors can be added whenever you like; and once created, they can also be copied and deleted.

Note: Home Designer Suite allows only one floor, the foundation/basement, below Floor 1. See “Foundations” on page 221.

Build New Floor



New floors can be created in plan view as well as in 3D views, and are always added above the top living floor. To create a new floor, select **Build > Floor > Build New Floor**.

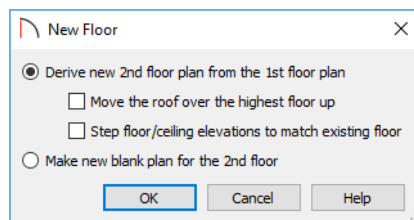

- **Derive new 2nd floor plan from the 1st floor plan** creates a new top floor with exterior walls generated directly over the exterior walls of the floor below. Wall types and roof directives associated with the walls on the floor below are dupli-

cated; however, interior walls are not. See “Roof Panel” on page 126.

- Check **Move Highest Floor’s Roof Up** to move any roof planes displaying on the highest floor in the plan up one floor when the new floor is created. Roof planes displaying on floors other than the top floor are unaffected. This option is only available if there are roof planes built on the top floor and is not available when **Auto Rebuild Roofs** is enabled. See “Build Roof Dialog” on page 256.
- Check **Step floor/ceiling elevations to match existing floor** to maintain all ceiling heights on the existing floor by stepping floor heights on the new floor to match. Ceiling heights on the new floor also become stepped accordingly. See “Stepped Floor and Ceiling Platforms” on page 139.
- **Make new (blank) plan for the # floor** creates a new top floor that is blank. This option is typically useful only if none of the exterior walls on the new floor will be directly above the exterior walls on the floor below. If you choose this method, it may be helpful to turn on the Reference Floor when drawing walls on the new floor. See “The Reference Floor” on page 231.

When you click OK, the **Floor Defaults** dialog for the newly created floor opens. Make any necessary changes to the floor structure, moldings, or materials

and click OK. See “Floor Defaults Dialog” on page 227.

The new floor becomes the Current Floor in plan view. If, however, the new floor is created in a 3D view, the camera remains on its original floor and does not move.

Adding a Foundation

To add a foundation, select **Build> Floor> Build Foundation** . See “Building a Foundation” on page 222.

Displaying Floors

Home Designer Suite allows you to view the floors in your plan in a variety of ways.



In Plan View

In plan view, only one floor can be active for editing at a time. This is referred to as the Current Floor. See “The Current Floor” on page 230.

In addition to the Current Floor, one other floor can be displayed for reference purposes: the Reference Floor. Objects on the Current Floor can snap to those on the Reference Floor, helping you align objects. See “The Reference Floor” on page 231.

In 3D Views

In most 3D views, all floors in a plan are visible, from the foundation up to the attic. There are three exceptions:

- **Doll House Views** , which show the Current Floor, not including its ceiling, plus any floors beneath it.
- **Interior Elevation**  views show a wall on a single floor, in a single room.

See “3D View Tools” on page 304.

Exchanging Floors



Select **Build> Floor> Exchange With Floor Above** or **Exchange With Floor Below** to swap the Current Floor with the floor above or below.

The floor that was moved becomes the Current Floor at its new location. You can easily move a floor up or down several floors by using either one of these buttons repeatedly.

Deleting Floors



Select **Build> Floor> Delete Current Floor** to remove the Current Floor from the plan. If there is a floor above, it becomes the Current Floor; if there is no floor below, the floor beneath becomes the Current Floor.



To delete Floor 0, select **Build> Floor> Delete Foundation**. You can delete the

foundation without actually being on Floor 0. Floor 0 cannot be deleted while **Auto Rebuild Foundation** is turned on. See “Deleting Foundations” on page 224.



When a floor is deleted, all objects on that floor are deleted with it.

Split Levels

Both split level floor plans and split level entries can be created by controlling the floor and ceiling heights of individual rooms in a multiple story structure.

For more detailed information about both types of structure, visit HomeDesignerSoftware.com.

Split Level Floor Plans

A split level, or tri-level, structure is a building where the floor level in one part of the plan is located approximately half way between the floor and ceiling levels of another part of the plan.

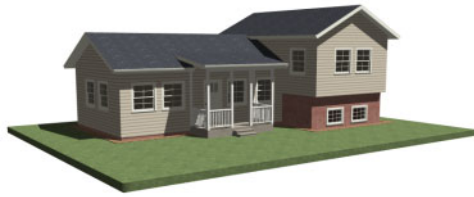

Split Level Home

To create a simple split level plan

1. Draw a simple rectangular structure divided into two separate halves by an interior wall.
2. Select one of the rooms and click the **Open Object**  edit button. See “Room Specification Dialog” on page 141.
3. Raise the **Floor Height** then press the Tab key.
4. Restore the **Relative Rough Ceiling** to the default value, then click OK.
5. Build a stem wall foundation. See “Foundations” on page 221.
 - The foundation under the room with the lower floor height will have the specified Min Stem Wall Height.
 - The foundation under the room with the raised floor will have taller stem walls.
 - Both can be edited in the **Room Specification** dialog.
6. If you add a Floor 2, note that the **Ceiling Height** in the room on Floor 1 will be reset to the default value.
 - To maintain a stepped condition on multiple floors, return to this room and set the **Relative Rough Ceiling** back to using the default.

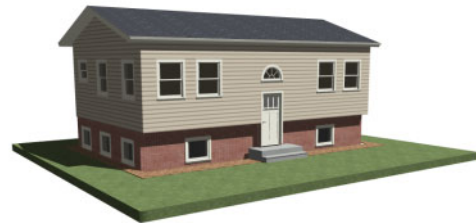

Split Level Entries

A split level entry, or divided entry, is characterized by an entry door that opens onto a landing positioned half way between the basement floor and first floor levels.



Split Level Entry

To create a simple split level entry

1. Create a plan file with a full basement at the location of the entry door. See “Basement Rooms” on page 224.
2. Go to Floor 0 and draw a stair **Landing**  at the location of the entry. See “Landings” on page 240.
3. Draw stairs upward from the basement floor to the landing.
 - The number of treads and risers in the stair section will determine the landing height.
4. Draw a second stair section from the landing upward.
5. Select the stairs and click the **Auto Stairwell**  edit button. See “Creating a Stairwell” on page 243.

Split level entries are often associated with daylight basements. See “Daylight Basements” on page 225.

The Current Floor

In a given plan view window, only one floor level can be active at any given time. The active floor is referred to as the **Current Floor**, and it is the only floor on which objects can be edited.

If you would like to view two different floor levels side by side, open a second plan view, navigate to the desired floor, and then tile the two views. Although both are visible, only one of these view windows is active. See “Working in Multiple Views” on page 61.

Floor Up / Floor Down



If you are working with more than one floor, you can select **Tools>**

Floor/Reference Display> Up One Floor or **Down One Floor** to switch from one floor to another.

You can change the Current Floor in floor plan and 3D views. The Current Floor displays on the **Change**

Floor/Reference  button, which can be found between the **Down One Floor** and the **Up One Floor** buttons.

Floors become available once they have been built. The Attic and foundation levels are also accessible using these tools.

Change Floor / Reference

1 If there are multiple floors, select **Tools> Floor/Reference Display> Change Floor/Reference** to open the **Change Floor/Reference** dialog, where you can select both the Current Floor and which floor is used in the Reference Floor.

The Attic Floor

 Home Designer Suite automatically creates a floor above the top numbered floor level of each plan. This floor is called the Attic floor and has only one purpose: to provide a space for automatically generated Attic walls. See “Attic Walls” on page 123.

In some situations, you may find it necessary to draw one or more walls on the Attic floor; however, even

if you enclose an area with walls, rooms cannot be created on this floor level. If you wish to create an attic loft or bonus room in your plan, you must do so on a numbered floor level.

Because the Attic floor is not meant to be a living area, a warning message will display if you try to draw walls or other objects on this floor level.

The Reference Floor

 When a model has more than one floor level, it is often helpful to see how they relate to each other in plan view. Select **Tools> Floor/Reference Display> Reference Display** to turn on the display of an additional reference floor along with the Current Floor.

Objects on the Reference Floor cannot be selected or edited.

If the Reference Floor Display is turned on when a view is printed, it will be included in the printed output. See “Displaying Objects” on page 384.

When the Reference Floor Display is turned on, the floor level below the Current Floor is used as the Reference Floor. If there is no floor level below, the floor above is used. By default, the Reference Floor displays in red.

Note: When objects on the Current Floor and the Reference Floor align and lines of two different colors are superimposed upon each other, discoloration may result.

Change Floor / Reference Dialog

1 By default, the floor below the Current Floor is the Reference Floor, but any floor can be referenced using the **Change Floor/Reference** dialog. To open the dialog, select **Tools> Floor/Reference Display> Change Floor/Reference** or

click the toolbar button that reports the current floor level.

When this dialog is accessed from a camera view, only the Current Floor options will be active.

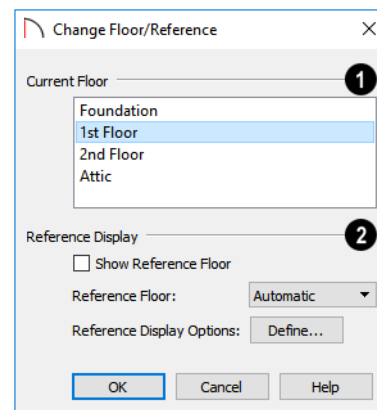

1 The **Current Floor** is highlighted here. Select another floor from the list to make it the Current Floor instead.

2 The **Reference Display** settings are only available in plan view.

Check **Show Reference Floor** to turn on the display of the Reference Floor.

Choose the current **Reference Floor** from the drop-down list. When “Automatic” is selected, the floor level below the Current Floor is always used; if there is no floor below, the floor above is used instead.

- 3 Click the **Define** button to open the **Layer Display Options** dialog and change the settings for the Reference Floor Layer Set. See “Layer Sets” on page 75.

Swap Floor/Reference



Click the **Swap Floor/Reference** button to move to the floor level shown in the Reference Floor Display, making it the new Current Floor. At the same time, the original Current Floor becomes the Reference Floor.

Stairs, Ramps, and Landings

Staircases can be composed of one or more straight or curved stair sections, ramps, and landings. Stairs and ramps can be drawn, selected and edited in 2D and 3D views.

Stairwells can be created automatically or manually and can be seen in 3D views.



Local building and fire authorities must be consulted for specific stair construction codes and access requirements.

Chapter Contents

- Stair Defaults
- The Stair Tools
- Anatomy of a Staircase
- Drawing Stairs and Ramps
- L- and U-Shaped Stairs
- Displaying Stairs, Ramps, and Landings
- Editing Stairs and Ramps
- Stair and Ramp Sections and Subsections
- Landings
- Maintaining Tread Depth
- Starter Treads
- Wrapped Stairs
- Other Special Railings and Stairs
- Creating a Stairwell
- Rooms Below Staircases
- Staircase Specification Dialog
- Ramp Specification Dialog
- Stair Landing Specification Dialog

Stair Defaults

The purpose of interior stairs is to provide passage from one floor platform to another, so the attributes that influence floor heights - including ceiling heights - also influence the structure of stairs. When

considering a staircase's structure, bear in mind that riser height is directly dependent on the distance from one floor platform to another.

The Stair Tools



Select **Build> Stairs** to access the Stair Tools.

Draw Stairs

 To draw a straight staircase select **Build> Stairs> Draw Stairs**, then click and drag in floor plan or a 3D view. You can also click once to place a staircase that extends from the current floor up to the next floor. See “Drawing Stairs and Ramps” on page 235.

Straight Stairs

 Select **Build> Stairs> Straight Stairs**, then click to create stairs between the current floor and the floor above. To create stairs between two floor platforms on the current floor, click on the low side, within a few feet of where the floor changes height.

- If you click on the low side of a floor platform defined by a railing, a doorway will be created in the railing, adjacent to the stairs.
- If you click on the low side of a floor platform defined by a wall, stairs will be created but a doorway will not.
- If you click at a location that is not near the edge of a floor platform, a full height staircase will be created.

Curved Stairs

 Select **Build> Stairs> Curve to Left** or **Curve to Right** and click once in plan view to place a curved staircase. See “Curved Stairs and Ramps” on page 236.

L-Shaped Stairs

 Select **Build> Stairs> L-Shaped Stairs**, then click to create two equal stair sections that form a 90° corner and are connected by a landing. See “L- and U-Shaped Stairs” on page 236.

Anatomy of a Staircase

Stairs as well as ramps are often described in terms of **rise** and **run**. Rise is typically between 6" and 8", and the run between 10" and 12". In metric plans, rise is 177 to 190 mm, and the run is about 250 mm. Whenever possible, Home Designer Suite will automatically apply reasonable rise and run values that meet most building codes to stairs and ramps as they are drawn.

In Home Designer Suite, staircases automatically have a consistent rise and run along their length because this is also a typical requirement of most

U-Shaped Stairs

 Select **Build> Stairs> U-Shaped Stairs**, then click to create two stair sections that form a 180° turn and are connected by a landing.

Landing

 Select **Build> Stairs> Landing** to draw a landing, which is a platform connecting two or more stair sections. See “Landings” on page 240.

There are two ways to create a landing using this tool:

- Click once to place a landing measuring 39" (975 mm) on each side.
- Click and drag to draw a rectangular landing sized as needed. See “Polylines” on page 105.

Ramp

 Select **Build> Stairs> Ramp** to draw a sloped ramp. By default, ramps are drawn at a 1:12 slope to a maximum height of 30" (760 mm). See “Drawing Stairs and Ramps” on page 235.

Spiral Stairs

 In the Library Browser, browse to Home Designer Core Catalogs> Architectural> Spiral Stairs to access a selection of spiral staircase fixtures. Select the object that you want, then click in any view to place it in the plan. See “The Library” on page 271.

Because spiral staircase symbols are fixture symbols, they do not have an Auto Stairwell edit tool. An opening in the floor above a spiral staircase must be created manually. See “Creating a Stairwell” on page 243.

building codes. When this is not desired, however, stairs and ramps can be divided into multiple sections subsections. See “Stair and Ramp Sections and Subsections” on page 238.

Staircase Terminology

Balusters - The vertical members that run between the handrail and the treads or bottom rail.

Bracket - Decorative L-shaped supports on the exposed side of stairs below each tread.

Landing - A platform connecting two or more stair sections.

Newels - The end post of a stair railing located at landings and the beginnings and endings of new stair sections.

Rise - The height of a riser, measured from tread surface to tread surface, Also referred to as Unit Rise.

Rise Angle - The angle of the staircase or stair section, defined by a line drawn through the back surfaces of its treads.

Riser - The vertical stair member located between the treads. Risers may be solid or open. When open, the front surfaces of the stringers are considered the risers.

Run - The depth of a tread, measured from riser surface to riser surface. Run does not include the Tread Overhang. Also referred to as Unit Run.

Runner - The carpet that runs down the center of the staircase.

Shoe - The bottom railing, placed on the landing floor, that anchors the balusters at landings.

Stringer - The inclined support member of a staircase that supports the treads and risers.

Tread - The horizontal member of a stair that the foot is placed on.

Tread Overhang - The portion of a tread extending past the front surface of the riser and over the tread below. Also referred to as Nosing or Nosing Extension, it is not included in the Run or Tread Depth measurements.

Tread Thickness - The vertical depth of the tread material.

Stair Structure and the Model

Stairs locate the height of the floor platform that they are drawn on and seek the next level, which may be the floor platform of the floor above or a landing. The stringers locate the subfloor of the floor platforms and maintain consistent riser height. If the stairs are long enough to reach the next level at a reasonable rise angle, their tread depth and number of treads are automatically calculated to create a staircase with consistent tread and riser dimensions along its entire length.

Drawing Stairs and Ramps

Stairs and ramps can be drawn in floor plan and 3D views but not in elevation views. There are a few things to keep in mind when drawing stairs:

- Before stairs are created, make sure that the heights for both the lower and upper floors are correctly defined.
- Stairs are drawn going **UP**, so they should be drawn from the lower of the two floors they connect.
- By default, stairs adjust their riser and tread dimensions to connect two floor heights if possible. The rise and run are calculated so that the steps are consistent in size.
- Stairs drawn within 1" (25 mm) of a wall will snap to the outer surface of the wall.
- Stairs will snap to the **Reference Display** , if you have it turned on.
- Hold down the Ctrl key to suppress these snapping behaviors.
- If a stairwell room has been defined on the floor above, the top of the stairs can be dragged until it stops at the railing or wall defining the stairwell.

- When drawing stairs or a ramp up from the terrain, it is a good idea to make sure the terrain is up to date. See "Building the Terrain" on page 356.

Straight Stairs and Ramps

The **Draw Stairs**  tool can be used in two different ways:

- Click and drag in a straight line to draw stairs that are the length that you drag.
- Click once to place stairs that go from the current floor up to the height of the next floor level.

You can also click once using the **Straight Stairs**  tool to create stairs between rooms on the same floor with different floor heights or between exterior rooms and the terrain. When the Straight Stairs tool is active, a preview outline of the stairs will follow the mouse pointer. Hold down the Alt key to reverse the direction of the Up arrow in the preview.

Similarly, **Ramps**  can be created by either clicking and dragging or by clicking. A ramp created

with a single click will be 30" (760 mm) high, have a slope of 1:12, and be 360" (9120 mm) long.

An individual stair or ramp section must be between 6" (150 mm) and 100' (30 m) in length. If a greater length is needed, connect two sections using a landing.

Curved Stairs and Ramps

You can make a straight stair or ramp section curved, or vice versa:

by selecting the stairs or ramp and clicking the **Change Line/Arc**  edit button. See "Change Line/Arc" on page 96.

You can also curve straight stairs and ramps by drawing them against a curved wall.

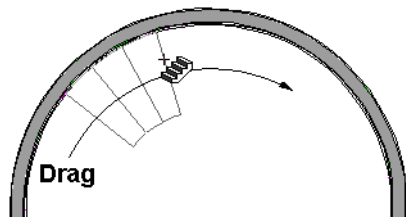

Straight stairs drawn along a curved wall



Curved Stairs can also be created in plan view by selecting **Build> Stairs> Curve to Left** or **Curve to Right**. Click to place a 90° curved stair section that can then be edited. You can

L- and U-Shaped Stairs



The **L-Shaped Stairs** and **U-Shaped Stairs** tools allow you to place staircases composed of two stair sections connected by one or more landings with a single click.

The staircases created with these tools build from the current floor to the floor above. If you need a staircase that builds between platforms on the same floor level, or in a downward direction, you will need to draw it manually. See "Landings" on page 240.

When you select either tool, the **New Shaped Staircase** dialog opens.

New Shaped Staircase Dialog

The settings in this dialog retained between sessions in the software and are global, affecting all plans.

continue clicking to place additional curved staircases until another tool is selected.

Drawing Stairs and Ramps Downward

Stairs and ramps can be drawn from the current floor level downward; however, drawing stairs or ramps between floors in this manner is not recommended. Drawing downward should only be used to create a staircase or ramp between a porch or deck and the terrain when you require the direction arrow to say "DN" instead of "UP". See "Displaying Stairs, Ramps, and Landings" on page 237.

To draw stairs going downward

1. Select **Build> Stairs> Draw Stairs** .
2. Hold down the Alt key or the right mouse button.
3. Click and drag to create straight stairs.

When drawing stairs or ramps from a floor platform to the terrain, or vice versa, they will locate the height of the terrain as long as it is lower than the floor height. You can also create a landing or "room" outside the structure and use it to establish the bottom height of the stairs or ramp. Then, draw in an upward direction from the lower platform to the upper platform.

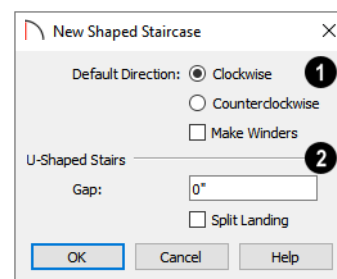

- 1 Specify the **Default Direction** of the stairs as they build upward: **Clockwise**, or **Counter-clockwise**.

- Check **Make Winders** to create multiple landings with angled edges between the two stair sections. When unchecked, a single rectangular landing is produced.

- 2 **U Shaped Stairs** -

- Specify the width of the Gap between the two stair sections.
- Check **Split Landing** to create two rectangular landings instead of one. When Make Winders is also checked, each of these two landings is further divided into triangular shaped winders.

When you click OK, a preview outline will follow the mouse pointer.

You can control the staircase’s orientation and direction by moving the mouse pointer towards a wall.

- In the case of a **U-Shaped** staircase, the landing will snap to the wall first.
- As you move the mouse pointer closer to the wall, the preview will rotate so that the upper stair section snaps to the wall.

- If you continue to move the mouse closer, the lower stair section will snap to the wall instead.
- If you move the mouse pointer into a wall corner, the preview will rotate so that the bottom stair section snaps to the wall that is nearest to the mouse pointer.
- When a **U-Shaped** staircase preview is in a wall corner, move the mouse pointer within the landing area to control which wall the back of the landing snaps to. With the landing in place, move the mouse pointer over the two stair sections to control which is the bottom section.
- Press the Alt key to reverse these snapping behaviors and the stairs’ direction.
- Hold down the Ctrl key to prevent the stairs from rotating or snapping to walls.

Displaying Stairs, Ramps, and Landings



The display of stairs, ramps, and landings in all views is controlled in the **Display Options** dialog. Stairs, ramps, and landings are placed on the “Stairs & Ramps” layer. See “Layer Attributes” on page 74.

In Plan View

In plan view, stairs, ramps and landings display on the floor they were drawn on and are only visible from the floor above if there is a stairwell. See “Creating a Stairwell” on page 243.

Stairs and ramps have an arrow indicating the direction they run. Interior stairs and ramps have an **UP** arrow on the floor they were created on and a **DN** arrow when viewed from the floor above. See “Drawing Stairs and Ramps” on page 235.

When a staircase is selected in plan view, the numbers associated with each of its sections and subsections display. Stair sections are assigned a single number, while subsection numbers have two

parts: a section number and subsection number separated by a hyphen.

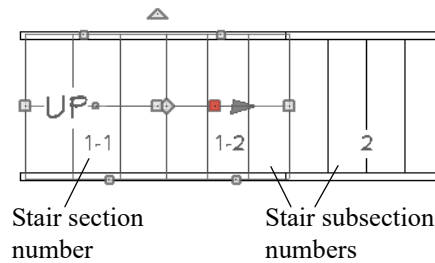

In 3D Views

Although stairs span between two floors, they can only belong to one floor. As a result, only multi-floor views show the upper floor with the platform opening and the lower floor with the staircase simultaneously. In Doll House Views, stairwells may appear as an empty spaces. See “3D View Tools” on page 304.

Editing Stairs and Ramps

Staircases and ramps can be selected and edited in plan view and 3D views. See “Selecting Objects” on page 79.

Using the Mouse

When a staircase or ramp is selected, its edit handles display. These edit handles can be used to customize

the object in many ways. See “Editing Objects” on page 79.

- Straight stair sections and ramps are edited like lines. They have additional edit handles for resizing the width of the section. See “Editing Line-Based Objects” on page 82.

- Curved stair sections and ramps are edited like arcs and also include edit handles for resizing the stair's width. See "Editing Arc-Based Objects" on page 83.
- When stair sections are merged, the edit handles display differently depending on what subsection is currently selected. See "Merging Stair and Ramp Sections" on page 238.
- When moving merged stair sections, all merged sections and landings move as one unless **Stair Sections Move Independently** is checked in the **Preferences** dialog. To temporarily enable this behavior, hold down the Alt key on the keyboard.
- Additional edit handles display on the first two treads of a staircase if the **Starter Tread**  edit button is clicked. See "Starter Treads" on page 241.

Stair and Ramp Sections and Subsections

In Home Designer Suite, staircases and ramps can be composed of multiple sections. In addition, each section can be broken into multiple subsections.

- Both sections and subsections can be curved while their neighbors are straight and can have different tread depths.
- Stair sections can also have different tread widths, can be disconnected from adjacent sections using the edit handles, and are usually separated from other sections by landings.
- Subsections both move and rotate as a single object, while sections move with other sections but rotate separately.

You can identify sections and subsections by clicking on a stair or ramp to select it: sections are identified with labels using whole numbers (1, 2, etc), while subsections are identified using hyphens (1-1, 1-2, etc). In addition, when a stair or ramp is selected, only the selected section will have edit handles.

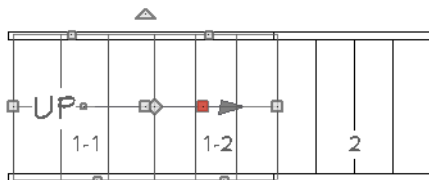

1-2 is the selected subsection.

The selected section or subsection can be identified by the Move edit handle, which is red by default. See "Selected Edge" on page 80.

In the Specification Dialog



Stairs and ramps can be customized in the **Staircase and Ramp Specification** dialogs. See "Staircase Specification Dialog" on page 245, "Ramp Specification Dialog" on page 251, and "Stair Landing Specification Dialog" on page 252.

Stair, ramp, and landing railings can also be customized. See "Railing Panel" on page 249, and "Newels/Balusters Panel" on page 249.

Using the Edit Tools

A selected staircase can be edited in a variety of ways using the buttons on the edit toolbar. See "The Edit Toolbar" on page 23.

Creating Stair and Ramp Subsections

There are several ways to create a stair section with multiple subsections:

- Draw one section, then draw a second section that begins at the first one's endpoint.
- Draw two separate segments, then snap the start point of one segment to the endpoint of the other using the edit handles.
- Draw one segment and use the **Break**  edit tool to divide it into two subsections. See "Break" on page 95.

Creating Stair and Ramp Sections

There are also three ways to create multiple stair sections:

- Draw two separate stair sections and join them using a landing.
- Use the **Complete Break**  edit tool to divide a section into two sections. See "To create a complete break" on page 96.
- Use the **Disconnected Selected Section** edit tool to change a subsection into a section.

Merging Stair and Ramp Sections

Any combination of straight and curved stair sections or straight and curved ramps using **Automatic**

Heights can be merged. The resulting staircase or ramp section is made up of subsections and, if there are no landings, functions as a single unit.

Stair and ramp subsections must be drawn in the same direction if they are to be merged:

- The top edge of a stair section or ramp cannot merge with the bottom edge of another section or ramp.
- Combinations of stairs drawn in the **UP** and **DOWN** directions cannot be merged.

Stair subsections merge at the center points of their upper and lower edges.

Stair sections and ramps cannot be merged directly. If a combination of stairs and a ramp is required, connect them with a landing. See “Landings” on page 240.

To merge stair or ramp sections

1. Confirm that the stairs or ramps that you wish to merge are using **Automatic Heights**. See “General Panel” on page 245.
2. Position the sections so they are in the desired relationship to each other.
 - In order to merge stair sections correctly, they must be parallel to one another.
 - To create merged subsections that change direction, make one of the merged sections curved.
3. Select either stair section so that its edit handles display.
4. Click the Extend handle on the end to be merged and drag it to the point where the two stairs are to meet.

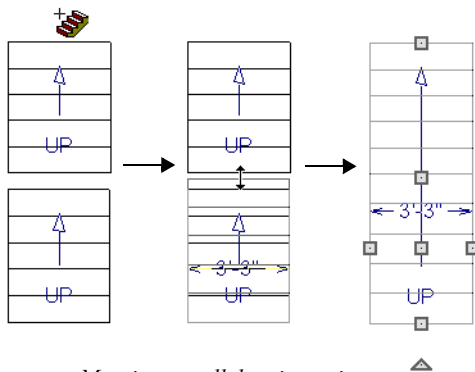

Merging parallel stair sections

A staircase consisting of merged subsections resembles a single stair section in plan view. The **UP**

(or **DN**) arrows join, becoming a single direction arrow.

When a subsection is selected, the entire staircase is selected. Additional edit handles, indicating the presence of multiple subsections and allowing you to reposition the line along which they join. See “Using the Mouse” on page 237.

Curved Subsections

Stair subsections attached at both ends by other sections do not have a free end that can be dragged into a curve. In this situation, change the middle subsection to a curve using the **Change Line/Arc** edit button. See “Change Line/Arc” on page 96.

To curve an enclosed stair subsection

1. Draw three straight stair sections and connect them end to end.
2. Select the middle subsection.

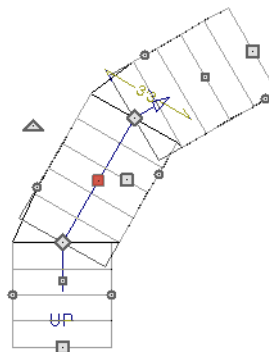

The middle stair subsection is selected

3. Click the **Change Line/Arc** edit button. The center section turns into a curved stair section.

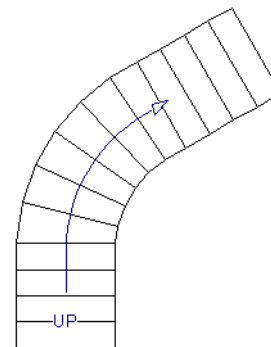





After using Change Line/Arc

- Use the triangular Change Curve edit handle to adjust the curvature of the middle section as needed.

Landings

Stair landings are platforms between stair sections and/or ramps, and can be created in either of four ways:

- Click and drag using the **Landing**  tool.
- Single-click using the **Landing**  tool to create a 3'-3" (975 mm) square landing.
- Click between two stair sections using the **Draw Stairs**  tool.
- One or more landings are also created when the **L-Shaped Stairs**  or **U-Shaped Stairs**  tool is used.

To create a landing between stair sections

- Draw two stair sections going UP. They can be at any angle.
- Click between the two sections using the **Draw Stairs**  tool to create a landing. Notice that only one direction arrow displays after the sections are joined by a landing.

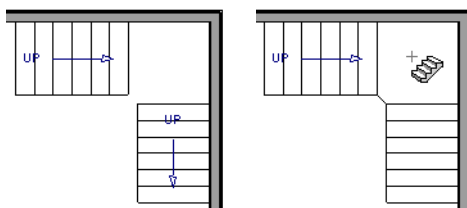

Creating a stair landing

Similarly, a landing can be created between two ramps by clicking between them with the **Ramp**  tool active.

Multiple stair sections and/or ramps can be connected to one landing. For example, two or three stair sections might meet at a landing with a single stair section continuing to the next level.

To be linked by a landing, all sections must be drawn in the same **UP** direction and the top of one section should be near the bottom of the next.

Stair sections connected with a landing will move together as a single unit.

Stairs joined in this manner can be turned into winders, which are steps located where a staircase turns and are narrower on the inside of the turn than they are on the outside.

A landing formed between two stair sections having less than a 90° angle between them are created with a short edge not less than 6" (150 mm). This is because most building codes require the shortest tread to be at least 6" wide. This edge can be manually edited to less than 6" if needed.

Adjacent Landings

Some staircases have more than one landing adjacent to one another. When **Auto Adjust Height** is used, landings in Home Designer Suite recognize other nearby landings and will automatically adjust their heights and railings when their edges are sufficiently close to one another.

To create adjacent landings, draw two landings and then position them so that their edges are within 1" (25 mm) of one another. The landing that was drawn first will maintain its position while the height of the one drawn later will be the equivalent of one riser higher than the first. The railings on adjacent edges are suppressed, as well.

Editing Landings

Once created, landings can be selected in 2D and 3D views and edited like other closed-polyline based objects. See "Editing Closed Polyline-Based Objects" on page 87.

Landings derive their initial materials, height, thickness, and railings from the stairs and/or ramps attached to them. You can assign a unique railing or material to a landing in the **Stair Landing Specification** dialog. See "Stair Landing Specification Dialog" on page 252.

When moving a landing, all stair or ramp sections connected to it move as one unless **Stair Sections Move Independently** is checked in the **Preferences** dialog. To temporarily enable this behavior, hold down the Alt key on the keyboard.

Landing Height and Thickness

A landing's height and thickness can either be dynamically controlled by the program or user-defined and static.

By default, landing top height and thickness are both set to **Auto Adjust**. This means that if the structure of the attached stairs is edited so that their length or riser height is affected, the landing's height and thickness will adjust automatically to maintain consistent riser height in all connected stair sections.

If you uncheck either **Auto Adjust** box in the **Stair Landing Specification** dialog, the landing will maintain the specified height and/or thickness no matter how the attached stairs or ramps are modified. This can result in stairs that have inconsistent risers. See “General Panel” on page 253.

Landing Railings

By default, landings have railings on all edges, but will automatically suppress the railing along any portion of an edge that connects to a stair section or has an adjacent landing. You can specify whether this

automatic behavior is used, the railing is suppressed, or the railing is always applied in the **Stair Landing Specification** dialog. See “General Panel” on page 253.

You can also suppress the railing on a selected edge by clicking the **Remove Railing from Selected**

Edge  edit button. To always generate the railing on a selected edge, click the **Add Railing to**

Selected Edge  edit button. See “Selected Edge” on page 80.

Landings can be edited into a wide variety of shapes. So that the railings of stair sections connect properly to the landing railings, you may find it helpful to use

the **Break**  edit tool to create a break in a landing edge if it is longer than the connecting stairs are wide. See “Break” on page 95.

Maintaining Tread Depth

Most building codes require staircases to maintain a consistent tread depth.

Home Designer Suite measures a stair section's length and tread depth along a Walk Line located 12" (30 cm) from the right edge of the stair section. On curved stairs, it is located 12" (30 cm) from the inside edge of the curve.

When a curved stair section has **Automatic Treads** specified in the **Staircase Specification** dialog and the Walk Line is used, the number and/or width of treads in a section or subsection changes when the inner edge is moved. For this reason, it is best to finalize stair section width as early as possible.

Starter Treads



The first and second treads of a staircase can be turned into starter treads by clicking the **Starter Tread** edit button. Starter treads extend to the side of the staircase, have rounded edges and are common on traditional staircases.

A starter tread can be added only to open sides of a stair section. If one side of a stair section is against a wall or wrapped (see “Wrapped Stairs” on page 242), only the exposed tread end can become a starter tread.



To create starter treads

1. Click on a staircase to select it.

2. Click the **Starter Tread**  edit button. An edit handle displays on each end of both the first and second treads.

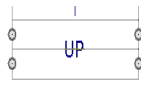

3. Drag either of the handles on the first tread outward from the stair section. If the stair section is against a wall, only one handle displays on the side opposite the wall.
4. As you drag, the ends of the tread become rounded.

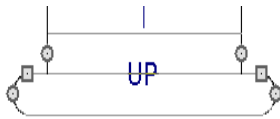

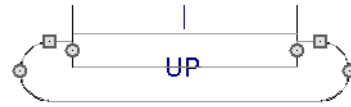

5. Two additional edit handles display on each side of the tread, along the back edge.

6. Drag either of the two square handles upward to increase the width of the rounded ends of the tread.

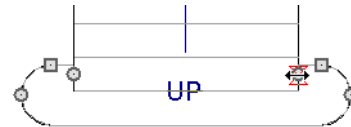

7. Drag the edit handle on the second tread outward from the stair section to create a second starter tread.



8. To make changes to existing starter treads, select the stairs, click the **Starter Tread**  edit button and repeat the above steps as needed.
9. When you are finished editing the starter treads, click the **Main Edit Mode**  to restore the stairs' regular edit handles and toolbar buttons.

Wrapped Stairs

Stairs can be wrapped around the corner of a deck or landing. Curved stairs and stairs with multiple subsections cannot be wrapped. See “Style Panel” on page 247.

To wrap stairs around a deck

1. Begin by drawing a deck. See “Decks” on page 138.
2. Use the **Straight Stairs**  tool to place a stair section on each side of the corner around which you want them to wrap.
3. Move the stair sections toward the corner of the deck. When the two sections are sufficiently close to the corner, they will merge to form wrapped steps.



 You can also draw stairs down from a deck by right-clicking to draw them or by pressing the Alt key while you drag. See “To draw stairs going downward” on page 236.

To wrap stairs around a landing

1. Use the **Draw Stairs**  tool to create two perpendicular stair sections with top ends that share a corner.

2. Click between them to create a landing.
3. Rotate one stair section 180°.

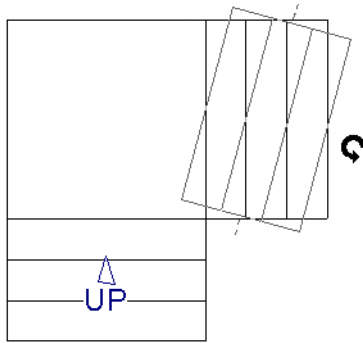

4. The stairs wrap around the corner. Notice that the Up arrow displays on the most recently edited stair section.

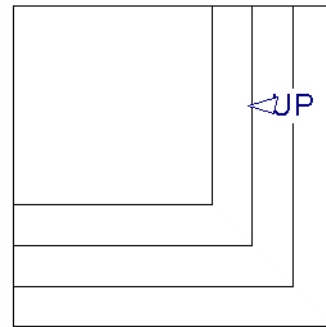

Other Special Railings and Stairs

Stairs can be customized to meet a variety of needs.

Solid Railings

To create a solid rail along a staircase, position a solid Railing or Half Wall  against, but not underneath, the stairs.

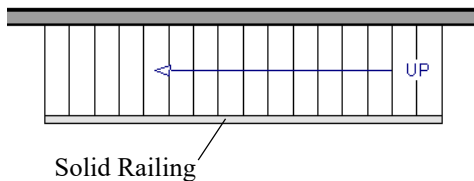

The solid railing recognizes the adjacent stairs and climbs alongside them.



If any balusters extend beyond the railing, eliminate them by unchecking **Left Railing** or **Right Railing** in the **Staircase Specification** dialog. See “Style Panel” on page 247.

Note: To create housed stringers, check **Trim Against Wall** in the **Staircase Specification** dialog. See “Stringers Panel” on page 247.

Creating a Stairwell

An interior staircase must be located in a stairwell, an opening to the floor above. A stairwell is an **Open Below** room type on the floor above. See “Room Types” on page 132.

If you create a stairwell away from other walls so the **Open Below** is created in the center of another room, connect a wall of the **Open Below** room to another wall using an invisible wall.

Creating a Stairwell Automatically



To create a stairwell that matches the perimeter of a selected staircase, click the



Auto Stairwell edit button. This button is only available when a living space exists above the staircase. It will not be available if the space above is **Open Below** or on the **Attic Floor**.

Auto Stairwell  automatically creates a room on the floor above enclosed by railings, defined as **Open Below** in the **Room Specification** dialog, and given a **Stairwell** room label. This room can be selected and edited like any other room.

Creating a Stairwell Manually



Stairwells can also be created manually.

To create a manual stairwell

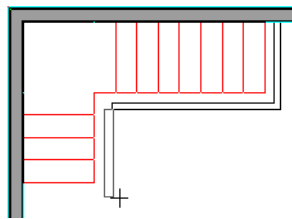
1. Draw a two-story building. Create the staircase on the first floor.
2. Make the second floor the **Current Floor** and the first floor the **Reference Floor**. See “The Reference Floor” on page 231.
3. Select **Tools> Floor/Reference Display> Reference Display**  to show the Reference Floor, including the stairs.
4. On the upper floor, use the **Railing**  tool to create a room around the stairs. Use the edit handles to position the railings as needed.



5. Select the railings one at a time and move them into position.
 - When a railing is selected, its bounding box shows the location of the outer surface of the railing’s drywall layer. For best results, this outer surface (which does not display when the railing is not selected) should meet the top edge of the stairs.
 - If you prefer, you can also go **Down One Floor**  and adjust the top edge of the staircase to snap it to the surface of the railing on the floor above.

6. When the railings are positioned properly, select **Tools> Floor/Reference Display> Reference Display**  to turn off the display of the Reference Floor.
7. Click inside the room using the **Select Objects**  tool to select it, then click the **Open Object**  edit button.
8. On the GENERAL panel of the **Room Specification** dialog, select “Open Below” from the **Room Type** list. Click **OK** to close the dialog.

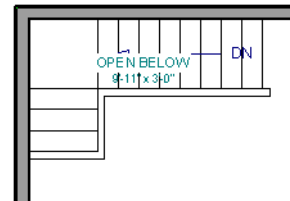

9. Place a **Doorway**  in the railing at the top step for an opening.
10. Select the doorway and define a large width in the **Door Specification** dialog. If the doorway is specified wider than the railing, its width adjusts to fit the available space.

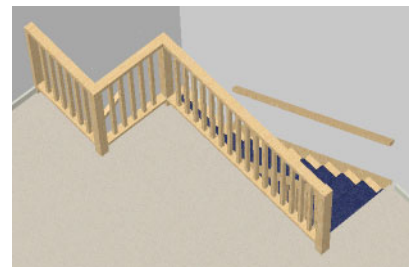

Rooms Below Staircases

Rooms such as closets or storage areas are commonly located beneath staircases.

To create a room below a staircase

1. Draw a staircase, select it, and click the **Open Object**  edit button to open the **Staircase Specification** dialog.
 - On the FILL STYLE panel, select “No Pattern” so the walls and other objects under the stairs can be seen.

2. On the same floor as the staircase, draw the **Interior Walls**  under them, following their shape.
3. Reposition the walls as needed, making sure that each is entirely under the stairs.
4. The wall at the foot of the stairs should be placed no closer to the bottom than the second step.
5. Add a door and specify the Room Type.

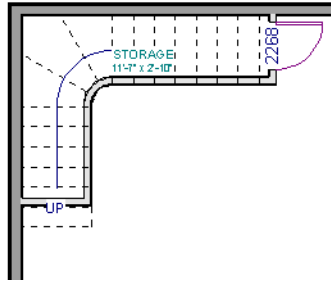

Staircase Specification Dialog

Staircases can be defined with the greatest accuracy in the **Staircase Specification** dialog. To open this dialog, select a stair section and click the **Open Object** edit button or double-click a stair section using the **Draw Stairs**, **Straight Stairs**, or **Select Objects** tool.

If a staircase is composed of multiple stair sections, the section that you clicked on to select the staircase

is the Selected Section; however, information about all the sections is available and can be edited in the dialog.

 It is recommended that all floor heights, ceiling heights and platform thicknesses be established before using the Staircase Specification dialog.

General Panel

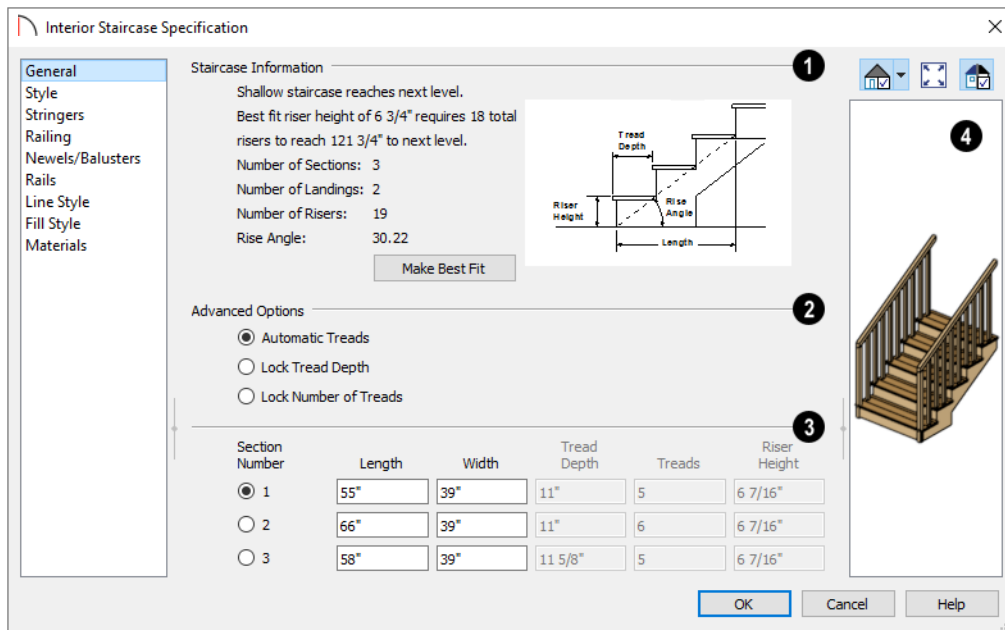

1 Staircase Information - Structural information about the selected staircase displays here for reference and updates as changes are made on the GENERAL panel.

- The first comment tells whether or not the staircase reaches the next level. It also indicates whether its rise angle is either steeper or more shallow than the Best Fit, described below. If

Automatic Heights is unchecked, this comment instead says “Start and end heights are set manually”.

- The second comment, **Best fit riser height of ___ requires ___ total risers to reach ___ to next level**, describes the ideal rise and run for the selected staircase. The program defines the Best Fit Riser Height as the riser height closest to 6 3/

4" (168.75 mm) that allows the selected staircase to meet the next level precisely. This comment is only active if **Automatic Heights** is checked, below.

- The total number of stair **Sections, Landings, and Risers** associated with the selected staircase also display here.
- The **Rise Angle** of the currently active stair section also displays here.
- Click the **Make Best Fit** button to add or remove risers to the Selected Section. Only available when **Automatic Heights** is checked and the staircase does not currently use the Best Fit Riser Height.

Make Best Fit will also extend stairs drawn in a downward direction until they reach the terrain. See "Terrain Perimeter" on page 349.

A diagram of a sample staircase's structure displays here for reference, as well.

- 2 The **Advanced Options** apply to all sections and subsections.
 - Select **Automatic Treads** to have the program define the depth and number of stair treads. If the staircase has multiple sections, each may have different tread depths.
 - Select **Lock Tread Depth** to specify the Tread Depth for each stair section, below, and prevent them from changing. When Lock Tread Depth is selected and the length of the stairs is changed, the number of treads will change.
 - Select **Lock Number of Treads** to specify the number of treads in each stair section and prevent it from changing. When Lock Number of Treads is selected and the length of the stairs is changed, the tread depths will change.
 - If a staircase with multiple sections is selected, **No Change** may be an option as well. Select this

to maintain the multiple sections' individual settings.

- 3 The specifications for each stair section and subsection are listed and can be edited here. Up to ten items total can display.

A change in one value usually affects other values. You may need to reposition the staircase after making changes.

- The **Section Number** column identifies the Selected Section and the number of each section of the selected staircase. The radio button to the left indicates which section or subsection is selected. See "Displaying Stairs, Ramps, and Landings" on page 237.
- Define the **Length**, or run, of each section.

When the length of a section changes, other sections and landings in the staircase unit move in response. You can specify whether the bottom or top edge of the Selected Section moves when you resize it by selecting either the Lock Bottom or Lock Top radio button, above.

- Define the **Width** of each section. If a section is connected to a landing, its width should equal the length of the landing edge that it connects to. See "Landings" on page 240.
- Specify the **Tread Depth**, or run, of each stair tread in the selected section.
- Define the number of **Treads** in a stair section or subsection.
- Define the **Riser Height**, the height of the risers in each stair section.

- 4 A preview of the selected staircase displays on the right side of the panel. If the staircase includes any landings, only the section that was selected when the dialog was opened will display. See "Dialog Preview Panes" on page 25.

Style Panel

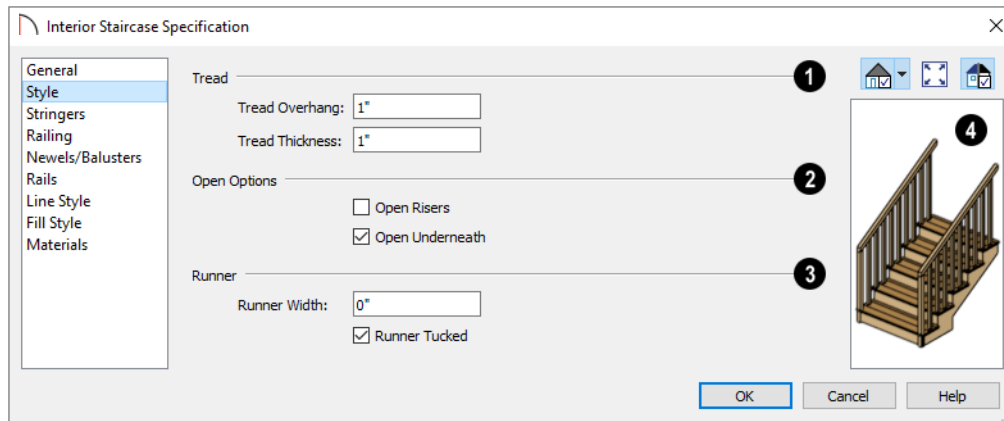

- 1** Specify characteristics of the staircase **Treads**. See “Anatomy of a Staircase” on page 234.

 - Specify the **Tread Overhang**, which is the distance that each tread overhangs the riser.
 - Specify the **Tread Thickness**.
- 2** The **Open Options** control whether the selected stairs have open risers or an open underside.

 - Check **Open Risers** to eliminate the riser face under each tread and expose the stringers.
 - Uncheck **Open Underneath** to add a skirt below the staircase along the two sides. It looks like a wall in 3D, but only has a single face. Base molding does not generate along the bottom of the skirt, and doors cannot be placed in it. In most cases, the recommended way to enclose the area beneath stairs is to use walls. See “Rooms Below Staircases” on page 244.
- 3** Specify the attributes of the staircase’s carpet **Runner**. Only available when **Open Risers** is unchecked, above.

 - Specify the **Runner Width**. The default value of 0 does not create a runner.
 - Uncheck **Runner Tucked** to have the runner drop straight down from the tread front to the riser below. This is checked by default.
- 4** A preview of the selected staircase displays on the right side of the panel. If the staircase includes any landings, only the section that was selected when the dialog was opened will display. See “Dialog Preview Panes” on page 25.

Stringers Panel

The settings on the STRINGERS panel affect all sections of a selected staircase.

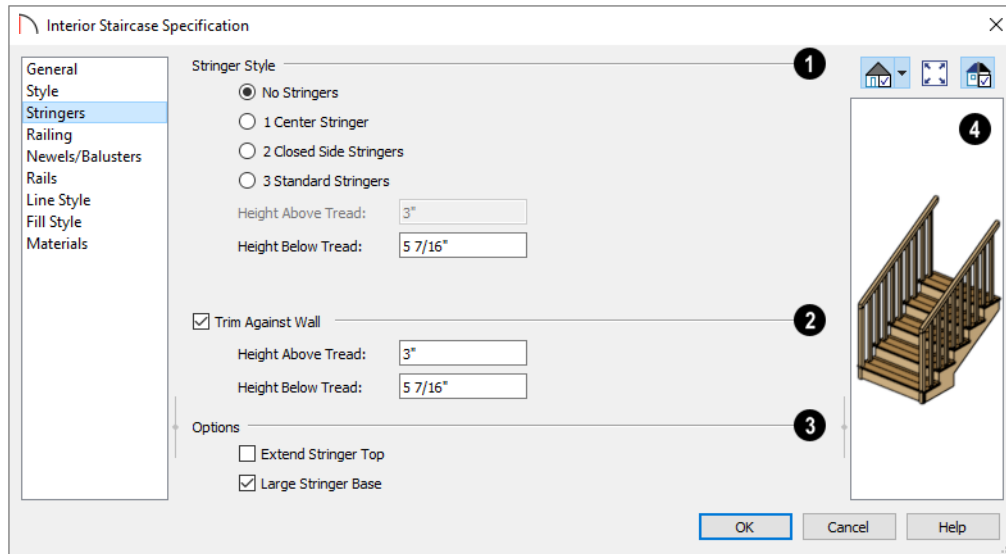

1 Stringer Style -

- Click a radio button to specify the number of stringers assigned to the staircase.
- Specify the **Height Above Tread**, measured straight down from the top outer edge of the tread nosing to the top of the stringer. Only available when 2 Closed Side Stringers is selected, above.
- Specify the **Height Below Tread**, measured straight down from the back bottom edge of the tread to the bottom of the stringer. Not available when Custom Stringers is selected, above.

2 Specify the attributes of the **Trim Against Wall** that generates when the staircase is positioned against a wall.

- Specify the **Height Above Tread**, measured straight down from the top outer edge of the tread nosing to the top of the tread.
- Specify the **Height Below Tread**, measured straight down from the back bottom edge of the tread to the bottom of the trim.

3 Options -

- **Extend Stringer Top** is checked by default and extends a triangular portion of the stringer under the landing or platform at the top of the stairs.
- Check **Large Stringer Base** to widen the stringers at the foot of the staircase. This is helpful when walls are created below the stairs.

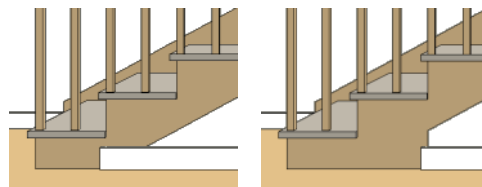

Large Stringer Base shown at right

- 4** A preview of the selected staircase displays on the right side of the panel. To see the stringers, click in the preview and drag upward to rotate. See “Dialog Preview Panes” on page 25.

Railing Panel

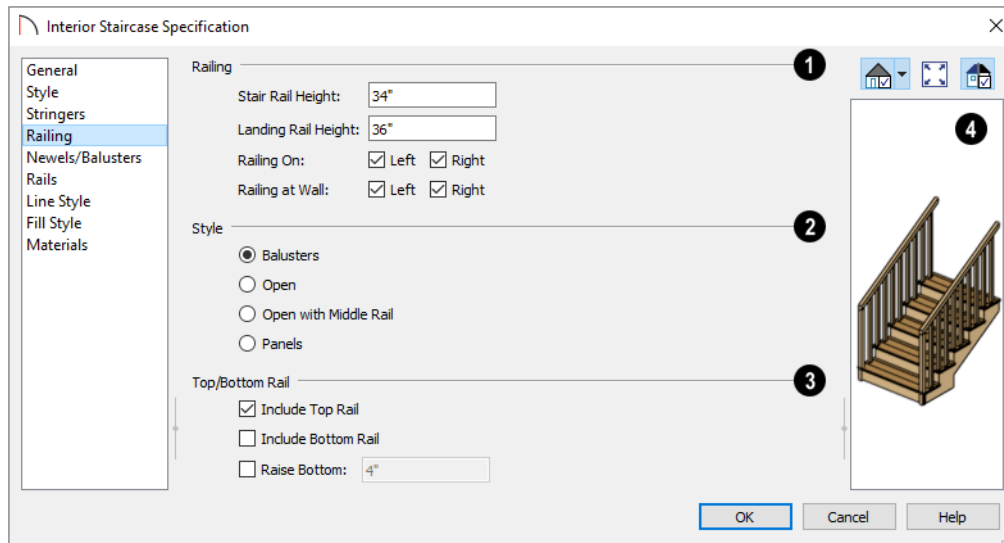

- 1 Specify how the **Railing** is applied to the selected staircase.
 - **Stair Rail Height** defines the height from tread surface directly over the riser to railing top.
 - **Landing Rail Height** defines the height of the landing rail top from the landing surface.
 - **Railing at Wall** - Select **Left** and/or **Right** to specify the placement of wall railings. Not available for ramps.

2 Style -

- Select **Balusters** to create regularly spaced balusters between larger newel posts.
- Select **Open** to create with only newels posts.
- Select **Open with Middle Rail** to create railings with newel posts and a middle rail.
- Select **Panels** to create railings composed of panels. The panel style is specified on the **NEWELS/BALUSTERS** panel. See “Newels/Balusters Panel” on page 249.

3 Top/Bottom Rail -

- Check **Include Top Rail** to produce a top rail on the stair railings that receives the top baluster ends and typically acts as a handrail.
- Check **Include Bottom Rail** to place a low rail on the landing surface that receives the balusters ends.

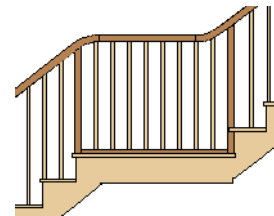

- Check **Raise Bottom**, then specify the distance to raise the bottom rail or panel from the stair tread.
- 4 A preview of the selected staircase displays on the right side of the panel. If the staircase includes any landings, only the section that was selected when the dialog was opened will display. See “Dialog Preview Panes” on page 25.

Newels/Balusters Panel

The settings on the **NEWELS/BALUSTERS** panel will also affect the appearance of railings on any landings

attached to the selected staircase. See “Landings” on page 240.

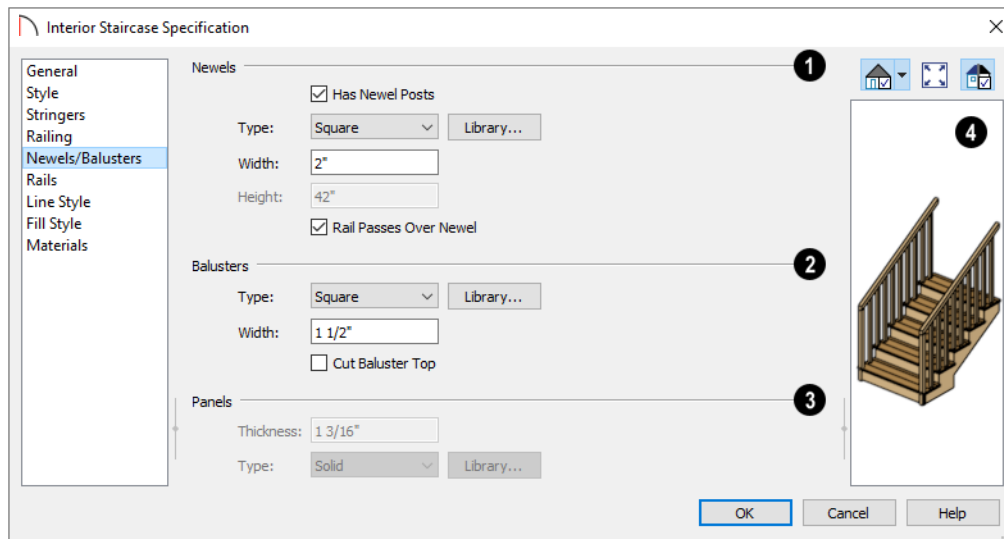

1 Newels -

- Uncheck **Has Newel Posts**, to prevent newels from generating in the selected staircase's railings. When this box is checked, newels are generated and can be edited using the settings that follow.
- **Type** - Select **Square**, **Round**, or newels from the **Library**. Selecting **Library** from the drop-down list is the same as clicking the **Library** button to the right and allows selection of a newel from the library.
- Specify the **Width**, which is the width or diameter of each newel. For Library newels, this is the width at its widest point.
- Specify the **Height**, which is the height from the landing surface to the top of the newel. Only available when **Rail Passes Over Newel** is unchecked below.
- Specify the on-center **Spacing** of the newel posts.

2 The first three **Balusters** settings are similar to the Newels options of the same names, above.

- **Cut Baluster Top** - Each tread normally has two to three balusters, growing longer toward its back. The default is to use the same baluster and cut it off at the bottom to shorten it toward the tread front. Check this box to cut the balusters at the top instead.

3 Specify the characteristics of the selected railing's **Panels**. These settings are only avail-

able when the railing Style specified as "Panels" on the Railing Panel.

- Specify the panel's **Thickness**.
- Select "Solid" or "Library" from the **Type** drop-down list.



You can also apply newels, balusters, and panels onto stair or ramp railing directly from the Library Browser. See "Inserted Objects" on page 282.

- ### 4
- A preview of the selected staircase displays on the right side of the panel. If the staircase includes any landings, only the section that was selected when the dialog was opened will display. See "Dialog Preview Panes" on page 25.

Rails Panel

The settings on the RAILS panel are similar to those on the RAILS panel of the **Wall Specification** dialog as well as the MOLDINGS panel of a variety of other dialogs. See "Moldings Panel" on page 268.

By default, the settings on the RAILS panel will also affect the appearance of railings on any landings attached to the selected staircase. See "Landings" on page 240.

Line Style Panel

The settings on the LINE STYLE panel are available for a variety of other objects in the program. For information about these settings, see "Line Style Panel" on page 103.

Fill Style Panel

The settings on the FILL STYLE panel affect the appearance of the selected staircase in plan view. For information about these settings, see “Fill Style Panel” on page 76.



Materials Panel

The settings on the MATERIALS panel affect the appearance of the selected staircase in 3D views and are available for a variety of objects throughout the program. For information about these settings, see “Materials Panel” on page 296.

The settings on this panel will also affect the materials applied to any landings attached to the selected staircase. See “Landings” on page 240.

Ramp Specification Dialog

 Ramps can be defined with the greatest accuracy using the **Ramp Specification** dialog. To open this dialog, select one or more ramps and click the **Open Object** edit button or double-

click a ramp section using the **Ramp**  or **Select Objects**  tool.

General Panel

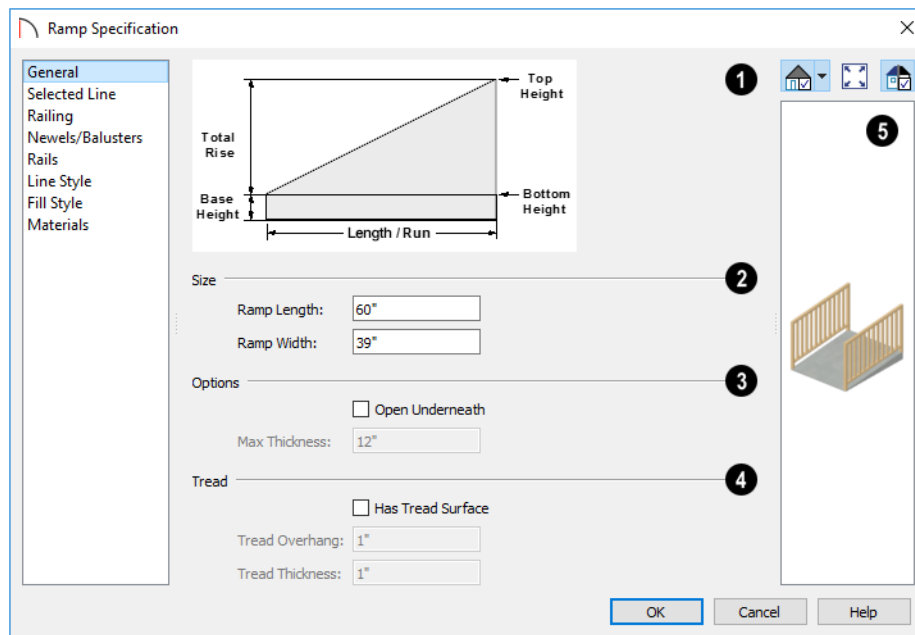

- 1 A diagram of a sample ramp's structure displays here for reference.
- 2 **Size** - Specify the **Ramp Length** and **Width**.
- 3 **Options** -
 - Check **Open Underneath** to remove the skirt around the bottom of the ramp so that it has a uniform, sloped thickness that may not reach the floor or terrain at the high end. This is unchecked by default.
 - Specify the **Max Thickness**, which is the ramp's maximum thickness. At the low end of the ramp where it meets the floor or terrain, its thickness may be less than this value.
- 4 **Tread** - Specify the structure of the ramp's **Tread**, which is an optional surface layer placed over the top of the ramp.
 - Check **Has Tread Surface** to apply a top tread surface to the ramp and enable the settings below.
 - Specify the **Tread Overhang**, which is the distance the tread surface extends past the ramp's edges.

- Specify the **Tread Thickness**, which is the tread surface's vertical depth.

5 A preview of the selected ramp displays on the right side of the panel. If the ramp is composed of multiple sections separated by landings, only the section that was selected when the dialog was opened will display. See “Dialog Preview Panes” on page 25.

Selected Line/Arc Panel

The SELECTED LINE panel is available when the selected edge is a line as opposed to an arc. For more information, see “Line Panel” on page 103.

The SELECTED ARC panel is available when the selected edge has been converted to an arc. For more information, see “Arc Panel” on page 104.

See, too, “Selected Edge” on page 80 and “Change Line/Arc” on page 96.

Railing Panel

The settings on the RAILING panel are similar to those on the same panel in the **Staircase Specification** dialog. For information about these settings, see “Railing Panel” on page 249.

By default, the settings on this panel will also affect the appearance of railings on any landings attached to the selected ramp. See “Landings” on page 240.

Newels/Balusters Panel

The settings on the NEWELS/BALUSTERS panel are similar to those on the same panel in the **Staircase Specification** dialog. For more information, see “Newels/Balusters Panel” on page 249.

Stair Landing Specification Dialog



Select a landing and click the **Open Object** edit button to open the **Stair Landing Specification** dialog. See “Landings” on page 240.

By default, the settings on this panel will also affect the appearance of railings on any landings attached to the selected ramp. See “Landings” on page 240.

Rails Panel

The settings on the RAILS panel are similar to those on the RAILS panel of the **Staircase Specification** dialog as well as the MOLDINGS panel of a variety of other dialogs. See “Moldings Panel” on page 268.

By default, the settings on this panel will also affect the appearance of railings on any landings attached to the selected ramp. See “Landings” on page 240.

Line Style Panel

The settings on the LINE STYLE panel are available for a variety of other objects in the program. For information about these settings, see “Line Style Panel” on page 103.

Fill Style Panel

The settings on the FILL STYLE panel affect the appearance of the selected ramp in plan view. For information about these settings, see “Fill Style Panel” on page 76.

Materials Panel

The settings on the MATERIALS panel affect the appearance of the selected ramp in 3D views and are available for a variety of objects throughout the program. For information about these settings, see “Materials Panel” on page 296.

The settings on this panel will also affect the materials applied to any landings attached to the selected ramp. See “Landings” on page 240.

General Panel

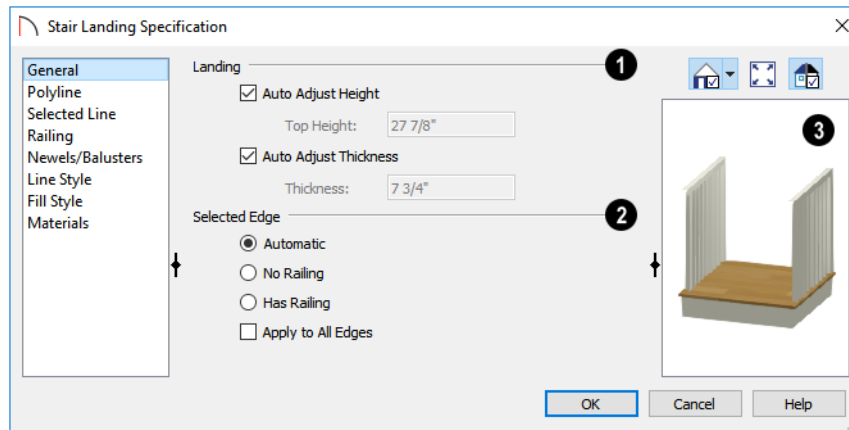

1 Landing -

Uncheck **Auto Adjust Height** to specify the selected landing's Top Height.

- A free-standing interior landing will have a default Top Height equal to one riser plus the thickness of the default floor finish. A free-standing exterior landing will have a default top height equal to its thickness. When this box is checked, the landing height may adjust as needed to maintain consistent riser height in all connected stair sections or adjacent landings.
- The **Top Height** field is only active when Auto Adjust Height is unchecked. See "Landing Height and Thickness" on page 240.

Note: A network of adjacent landings can only be created when Auto Adjust Height is checked. See "Adjacent Landings" on page 240.

Uncheck **Auto Adjust Thickness** to specify the selected landing's **Thickness**.

- A free-standing landing will have a default thickness of 6 3/4" (169 mm). When checked, the thickness is based on the riser height of the stair sections it is attached to, or the thickness of the ramps it is attached to.
- The **Thickness** field is only active when Auto Adjust Thickness is unchecked.

2 Specify how railings are applied to the landing's **Selected Edge**. See "Selected Edge" on page 80.

- Select **Automatic** to suppress the railing on any portion of the selected edge that either connects

to a stair section or has an adjacent landing, but to produce a railing where that is not the case. See "Landing Railings" on page 241.

- Select **No Railing** to suppress the railing on the selected edge of this landing.
- Select **Has Railing** to produce a railing along the selected edge, even where it connects to a stair section or has an adjacent landing.
- Check **Apply to All Edges** to apply your selection to all edges of the landing. This is an action rather than a state - the next time this dialog is opened, this box will be unchecked.

3 A preview of the selected landing displays on the right side of the panel. See "Dialog Preview Panes" on page 25.

Polyline Panel

The POLYLINE panel states the length of the landing's **Perimeter**, its enclosed **Area**, and its **Volume**.

The settings on this panel are available for a variety of other objects in the program. See "Polyline Panel" on page 106.

Selected Line/Arc Panel

The SELECTED LINE panel is available when the selected edge is a line as opposed to an arc. For more information, see "Line Panel" on page 103.

The SELECTED ARC panel is available when the selected edge has been converted to an arc. For more information, see "Arc Panel" on page 104.

See, too, "Selected Edge" on page 80 and "Change Line/Arc" on page 96.

Railing Panel

The settings on the RAILING panel are similar to those on the same panel in the **Staircase Specification** dialog. For information about these settings, see “Railing Panel” on page 249.

There is one setting that is unique to the **Landing Specification** dialog:

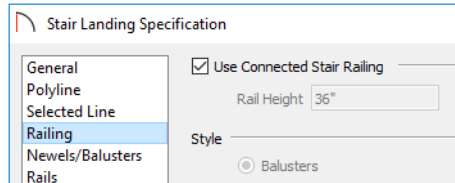

Uncheck **Use Connected Stair or Ramp Railing** to enable the settings on this panel and the NEWELS/BALUSTERS panel. When checked, the selected landing derives all railing settings from the connected stairs or ramp.

If the selected landing is not connected to a stair or ramp, this checkbox will be named **Use Default Interior or Exterior Stair Railing**, depending on where the landing is located.

Newels/Balusters Panel

The settings on the NEWELS/BALUSTERS panel are similar to those on the same panel in the **Staircase**

Specification dialog. For more information, see “Newels/Balusters Panel” on page 249.

By default, the settings on this panel will also affect the appearance of railings on any landings attached to the selected ramp. See “Landings” on page 240.

Line Style Panel

The settings on the LINE STYLE panel are available for a variety of objects throughout the program. See “Line Style Panel” on page 103.

Fill Style Panel

The settings on the FILL STYLE panel affect the appearance of the selected landing in plan view. See “Fill Style Panel” on page 76.

Materials Panel

When a landing is attached to stairs, its initial materials are derived from the stairs.

The settings on this are available for a variety of objects throughout the program. For information about these settings, see “Materials Panel” on page 296.

Roofs

Home Designer Suite's automatic Roof Tools allow you to draw almost any roof style.

Proficiency with the Roof Tools can only be attained through practice, but mastering these tools saves you time and effort in plan development. For information about creating specific roof styles, see "Roof Tutorial" on page 43 of the User's Guide.

Roof Defaults



Select **Edit > Default Settings**, to open the **Default Settings** dialog for a variety of drawing tools, several of which directly affect roof generation.

Roof Defaults Dialog

The **Build Roof** and **Roof Defaults** dialogs are nearly identical in appearance and function. The only difference is that the **Build Roof** dialog has a checkbox that allows you to automatically generate roof planes. See "Build Roof Dialog" on page 256.

Floor and Ceiling Heights

The initial heights of floors and ceilings, which influence roof heights, are specified in the **Floor Defaults** dialog for each floor. See "Floor Defaults Dialog" on page 227.

Chapter Contents

- Roof Defaults
- The Roof Tools
- Automatic Roofs
- Build Roof Dialog
- Editing Roofs
- Gable Over Door/Window
- Gable Line Specification Dialog
- Skylights
- Skylight Specification Dialog
- Dormers
- Editing Auto Dormers
- Dormer Specification Dialog
- Roof Returns and Other Details

The floor and ceiling heights in individual rooms also influence roof heights and are specified in the **Room Specification** dialog. See "Structure Panel" on page 143.



If Auto Rebuild Roofs is checked in the Build Roof dialog and you change floor or ceiling heights, wall positions or roof directives in walls, the roof rebuilds to reflect your changes. See "Rebuilding Roofs" on page 256.

Wall Specification Dialog

By default, when a roof is built, a roof plane is generated over each exterior wall, creating a hip roof.

Any deviations from this default hip roof, such as a gable or a different pitch, can be specified in the **Wall**

Specification dialog for any exterior wall. See “Roof Panel” on page 126.

Dormer Defaults

The settings in the **Dormer Defaults** dialog determine the initial settings for automatic dormers

and are much like those in the **Dormer Specification** dialog. See “Dormer Specification Dialog” on page 262.

The Roof Tools



Select **Build> Roof** to access the Roof Tools.

Build Roof



Select **Build> Roof> Build Roof** to open the **Build Roof** dialog, specify the settings for automatically generated roof planes, and build or rebuild a roof. See “Build Roof Dialog” on page 256.

When roofs are automatically generated, a roof plane is created over each exterior wall by default, resulting in a hip roof.

To automatically generate a roof plane using values other than the defaults or to not generate a roof plane bearing on a particular wall (as with a gable or the sides of a shed roof), you can change the settings in the **Wall Specification** dialog. See “Roof Panel” on page 126.

For more information about creating different roof styles, see “Roof Tutorial” on page 43 of the User’s Guide.

Automatic Roofs

When roofs are automatically generated, a roof plane is created over each exterior wall by default, resulting in a hip roof.

Roof Directives in Walls

To automatically generate a roof plane using values other than the defaults or to not generate a roof plane bearing on a particular wall (as with a gable or the sides of a shed roof), you can change the settings in the **Wall Specification** dialog for that wall. See “Roof Panel” on page 126.

For more information about creating different roof styles, see “Roof Tutorial” on page 43 of the User’s Guide.

Build Roof Dialog



The **Build Roof** dialog is used to automatically build or rebuild roof planes. To

Skylight



Select **Build> Roof> Skylight**, then draw a rectangle over an existing roof plane to create a skylight. The skylight, skylight shaft, and ceiling hole (if a ceiling exists) are drawn at the same time. See “Skylights” on page 259.

Dormer



Select **Build> Roof> Dormer** and click within an existing roof plane to place an auto floating dormer. See “Dormers” on page 261.

Delete Roof



Select **Build> Roof> Delete Roof** to delete all roof planes in the plan. See “Deleting Roof Planes” on page 258.

Rebuilding Roofs

By default, whenever changes are made to wall placement, floor/ceiling heights, or roof directives in walls, the roof will update in response. If you do not want the roof to rebuild automatically, uncheck **Auto Rebuild Roofs** in the **Build Roof** dialog. See “Roof Panel” on page 257.

You can also rebuild the roof at any time to reflect the current state of the model by opening the **Build Roof** dialog and clicking OK.

open the **Build Roof** dialog, select **Build> Roof> Build Roof** .

Roof planes are generated based on the positions and roof directive settings for each exterior wall in the plan. If you make changes to any of these walls, you will need to build the roof again for them to take effect. See “Roof Panel” on page 126.

Aside from a checkbox on the ROOF panel that allows you to automatically generate roof planes, the settings in this dialog are also found in the **Roof Defaults** dialog. See “Roof Defaults” on page 255.

There are three panels in the **Build Roof** dialog:

- Roof Panel
- Materials Panel
- Roof Styles Panel

Roof Panel

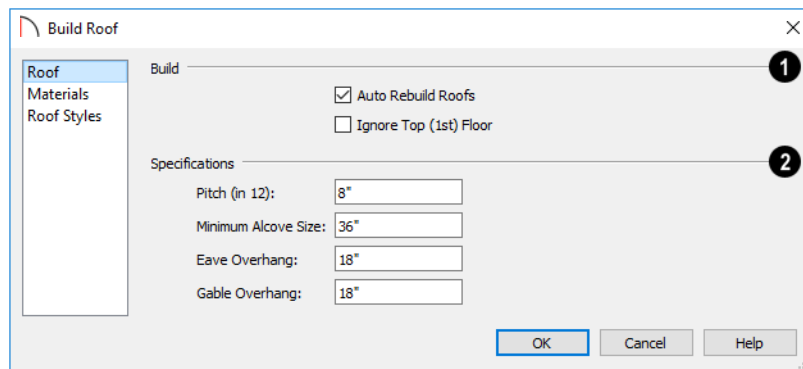

- 1 The **Build** options are commands related to building and rebuilding roofs.
 - If you check **Auto Rebuild Roofs**, the program automatically rebuilds the roof if you make a change that affects the roof, such as to exterior wall positions or ceiling heights.
 - Check **Ignore Top Floor** to build the roof so that it bears on the walls of the floor below the top living floor in the plan. When unchecked, the roof builds so that it bears on the walls on the top floor of the plan.
- 2 The **Specifications** settings affect basic roof structure.
 - Enter a value to describe the **Pitch**. In plans using U.S. units of measurement, pitch is described as a ratio over 12; in metric plans, it is measured in degrees.
 - **Minimum Alcove Size** - Specify the minimum width of an alcove (depression into an otherwise straight exterior wall). Any alcove less than the specified width is treated as though the exterior wall continues straight across. Alcoves that measure wider than this value are not roofed over; they cause a change in roof planes.

Following is an example showing this difference. If **Min Alcove** is 36", a 36" wide alcove requires a change in the roof line. Each wall of the alcove has

an eave. On the right, the alcove is less than the 36" minimum, so the roof passes right over it.

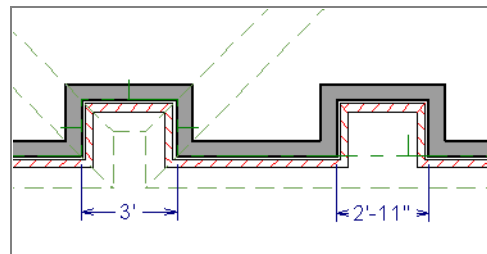

The **Roof Overhang** is measured horizontally from the exterior surface of the wall's framing layer to the end of the top of the rafter. It does not include gutters, sheathing or siding.

- **Normal** is the overhang at the eaves and is always the overhang for a roof plane having the default Pitch specified above. If the pitch for a particular roof plane is set differently, its overhang may try to maintain its fascia at the same height. Overhang can be greater for a shallower pitch, lesser for a greater pitch.
- **Gable** is the overhang dimension at gable ends or rake walls.



 If the roof overhang values are not sufficient to extend past the outer layer of exterior walls, the walls may not generate correctly in 3D views.

Materials Panel

The settings on this panel allow you to specify the default materials for the roof's various components. See "Materials Panel" on page 296.

Editing Roofs

Unlike most other objects in Home Designer Suite, roof planes cannot be selected and edited. To make changes to the roof, you must edit the edit roof directives in walls and/or settings in the **Build Roof** dialog, and then rebuild. See "Rebuilding Roofs" on page 256.

An exception to this rule is the **Material Painter**  tool, which you can use to change the materials used by individual roof planes without rebuilding the roof. Bear in mind, though, that any changes made using the **Material Painter**  will not be retained

Roof Styles Panel

The ROOF STYLES panel provides links to tutorial information about creating different roof styles automatically. Click on a roof style to launch the online Help to a page with information about the roof style you selected. See "Roof Tutorial" on page 43 of the User's Guide.

if the roof is later rebuilt. See "Material Painter Tools" on page 295.

Deleting Roof Planes

There are several ways to delete roof planes.



Delete the entire roof quickly by selecting **Build > Roof > Delete Roof**.





You can also delete all roof planes at once in the **Delete Objects** dialog. See "Delete Objects Dialog" on page 99.

Gable Over Door/Window



The **Gable Over Door/Window** edit button allows you to add a small gable dormer over one or more selected doors or windows the next time automatic roof planes are built.

To use the Gable Over Door/Window tool

1. Select one or more doors or windows.
2. Click the **Gable Over Door/Window**  edit button.
 - **Gable Over Door/Window**  is not available for openings placed in Full Gable Walls or for Bay, Box or Bow Windows. See "Bay, Box, Bow Windows and Roofs" on page 195.
3. In the **Gable Line Specification** dialog, specify the desired Pitch and Overhang for the gable roof. See "Gable Line Specification Dialog" on page 259.
4. The next time automatic roof planes are built, gables will be created over each of these doors and windows.

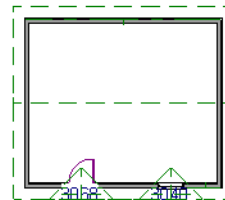

- Each gable will extend 12" (300 mm) on either side of its door or window.
 - If two of these openings are within 30" (750 mm) of each other on the same wall, a single gable will be created.
 - If you move or resize the door or window(s), the associated Gable Line will not update until the roof is built again.
5. To remove a Gable Over Door/Window, select the door(s) or window(s) and click the **Delete Gable Over Opening**  edit button. The next time the roof is built, the gable will be removed.

Gable Line Specification Dialog



To open the **Gable Line Specification** dialog, select a door or window and click the **Gable Over Door/Window** edit button.

Gable Line Panel

The settings on this panel affect the structure of the two roof planes associated with the selected Gable Over Door/Window.

The defaults for these settings are set in the **Build Roof** dialog. See “Roof Panel” on page 257.

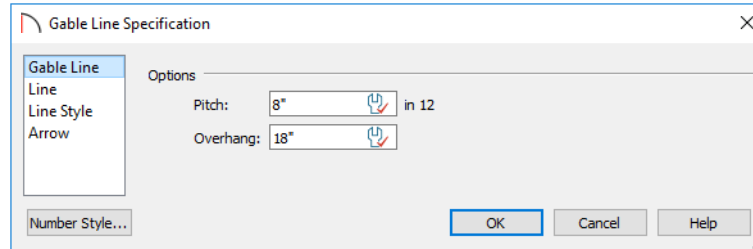

- Specify the **Pitch** of the roof planes that form the gable.
- Specify the **Overhang** of the roof planes that form the gable.

Line Panel

The settings on the **LINE** panel are available for a variety of other objects in the program. See “Line Panel” on page 103.

Line Style Panel

The settings on the **LINE STYLE** panel are available for a variety of other objects in the program. See “Line Style Panel” on page 103.

Arrow Panel

The settings on the **ARROW** panel are available for a variety of other objects in the program. See “Arrow Panel” on page 103.

Skylights



A skylight can be created by selecting **Build> Roof> Skylight** and drawing a rectangular polyline within a single roof plane. You can also simply click once within a roof plane to place a 2' x 2' skylight. These measurements describe the skylight's projected size, as measured in plan view: roof pitch is not taken into account.

The **Skylight**  tool places a flat panel skylight into a roof hole, produces a hole in the ceiling platform below, and automatically generates the skylight shaft between these two holes.

To place a skylight in a vaulted ceiling, uncheck **Flat Ceiling Over This Room** in the **Room Specification** dialog, draw the ceiling planes to produce the vault and edit them as needed, and then draw the skylight. See “Structure Panel” on page 143.

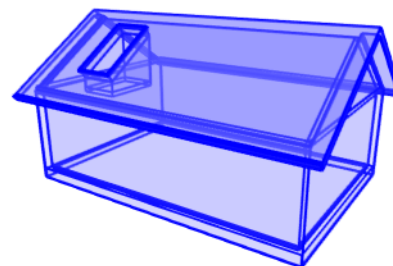
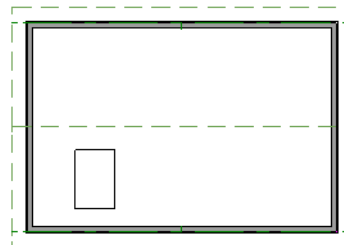

Although inserted into roof planes, skylights are able to display in both plan and 3D views when their containing roofs do not.

Editing Skylights

Skylights can be edited using the edit handles, edit toolbar buttons, or the **Skylight Specification** dia-

log. See “Skylight Specification Dialog” on page 260.

Skylights must always be contained by a single roof plane. If the roof plane is deleted, any skylights it contains are also deleted. Aside from this restriction, skylights can be edited much like standard closed polylines. See “Editing Closed Polyline-Based Objects” on page 87.

Skylight Specification Dialog



Select a skylight and click the **Open Object** edit button to open the **Skylight Specification** dialog. See “Skylights” on page 259.

General Panel

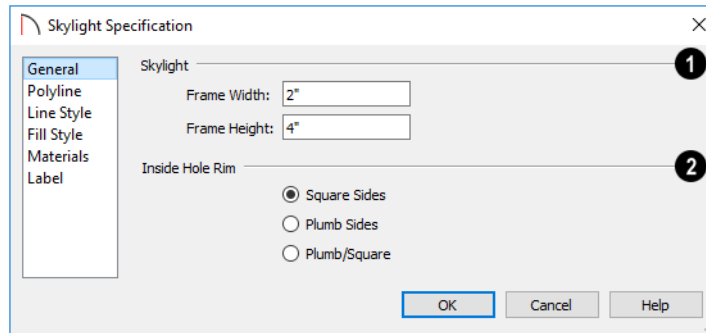

1 Specify the **Frame Width** and **Height** of the selected skylight. These values describe the skylight’s projected size, as measured in plan view: roof pitch is not taken into account.

2 The **Inside Hole Rim** settings define how the hole for the skylight is framed, as well as the shape of the skylight well where it passes through the roof plane.

- Select **Square Sides** to cut the framing for the skylight square to the pitch of the roof.
- Select **Plumb Sides** to produce framing for the skylight that is plumb-cut.
- Select **Plumb/Square** to produce framing with the bottom edge plumb-cut and the top edge, square-cut.

Polyline Panel

The POLYLINE panel states the skylight’s **Perimeter**, its **Framing Area**, and its **Projected Area**.

- The **Perimeter** is the length of the skylight’s perimeter with the pitch taken into account. It does not equal the perimeter as measured in plan view.

- The **Framing Area** is the area of the skylight with the pitch taken into account.
- The **Projected Area** is the area of the skylight as seen in plan view.

Line Style Panel

For information about the settings on this panel, see “Line Style Panel” on page 103.

Fill Style Panel

The settings on the FILL STYLE panel control the appearance of the selected skylight in plan view. See “Fill Style Panel” on page 76.

Materials Panel

For information about the MATERIALS panel, see “Materials Panel” on page 296.

Label Panel

Skylight labels display when the “Roofs, Labels” layer is turned on and use the “Default Label Style”

Text Style. The Automatic Label for these objects is blank, but you can specify a custom label.

For information about the settings on this panel, see “Label Panel” on page 166.

Dormers

 Dormers can be drawn manually or placed automatically using the **Dormer** tool.

Automatic Dormers can be placed only under certain conditions:

- Automatic Dormers can only be placed entirely within a single roof plane. They cannot extend past the eaves or ridge of this roof plane.
- Automatic Dormer side walls cannot be positioned above other walls in the plan.

If you click within a roof plane to place an automatic dormer, but click too close to an eave or the ridge, a dormer will not be created; however, its outline will. Move this outline box to a location that meets the dormer’s requirements and it will be created.

The initial width, height, roof style and other settings of Auto Dormers are set in the **Dormer Defaults** dialog. See “Dormer Defaults” on page 256.

Dormer

 Select **Build> Roof> Dormer** and click the roof plane where you would like to place the center of the dormer’s front wall.

The bottom edges of all dormer walls are cut off by the underlying roof plane.

The images below show both the outside and inside of a typical dormer.

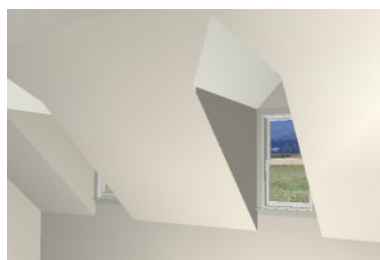
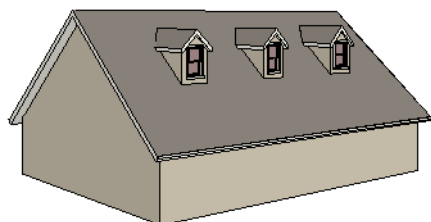

A dormer can be placed in plan view on the same floor that its underlying roof plane displays on, or it can be placed on the floor above. Normally, it does not matter what floor the dormer is on; but in some cases, it may need to be on the floor above so that the dormer walls do not interfere with walls or railings in the room below.

Regardless of which floor it is placed on, a dormer must always fit within a single roof plane. When placing a dormer on the floor above, you may find it helpful to turn on the **Reference Display** . See “The Reference Floor” on page 231.

Manually Drawn Dormers

Once you are familiar with Home Designer Suite’s roof tools, drawing dormers manually can be quite simple. There are several different ways to draw dormers; some methods work better in certain applications.

A variety of resources with information about drawing dormers manually is available at HomeDesignerSoftware.com.

See, too, “Manually Drawn Dormers” on page 54 of the User’s Guide.

Editing Auto Dormers

Auto Dormers are a collection of objects that behave as one. When a dormer is selected, it can be edited using its edit handles, edit tools, and specification dialog. See “Dormer Specification Dialog” on page 262.

Using the Mouse

When selected, an auto dormer displays three edit handles. The Move handle displays over the front wall and allows you to relocate the dormer. Two resize handles display on the side walls and allow you to change the width of the dormer.

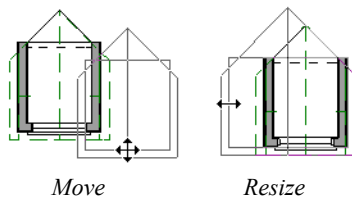

There are some things to keep in mind when editing auto dormers and auto floating dormers using the mouse.

- Dormers move at 90° angles unless the Ctrl key is pressed before moving them.
- The dormer must be contained within one underlying roof plane.
- Auto dormers cannot be moved beyond the required knee wall.

Editing the Window

Dormer windows can be selected, edited, deleted and replaced just like other windows. See “Editing Windows” on page 187. You can place several windows in the front wall.

Unless the dormer's window has been edited or changed in the **Window Specification** dialog, when the dormer width is changed, its width changes automatically to fill the front dormer wall. If the window has been edited, its width stays fixed. If a change to the dormer makes its front wall too short to hold the window, the window reverts to auto width.

Dormer Specification Dialog



Select a dormer and click the **Open Object** edit button to open the **Dormer Specification** dialog.

The settings in this dialog are also found in the **Dormer Defaults** dialog, where they apply to all dormers as they are created rather than to a selected dormer.

Roof Panel

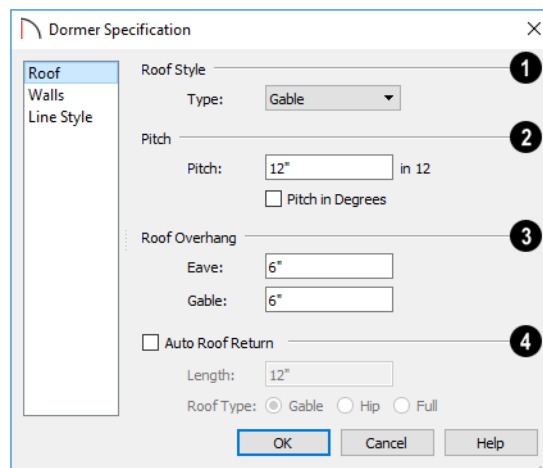

1 Specify the selected dormer's **Roof Style**.

- Choose a roof **Type** from the drop-down list. You can choose from Hip, Gable, Shed, Gambrel,

Mansard, Barrel, Curved Eave, Hip Curved Eave or Eyebrow.

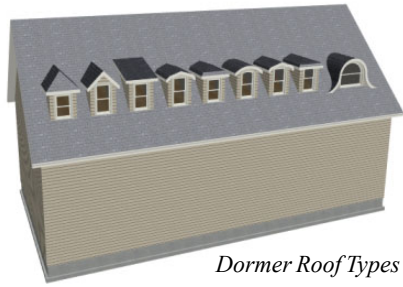

- 2 Describe the **Pitch** of the dormer’s roof planes.
 - Specify the **Pitch** of the dormer roof planes. The default dormer pitch applies to all dormer roof types except Shed, which has a default 3 in

12 pitch. For Gambrel and Mansard types, this applies to the lowest, or eave, roof planes.

- Check **Pitch in Degrees** to display the pitch in degrees; uncheck it to display the pitch in terms of rise and run.
- 3 **Roof Overhang** - Specify the depth of the selected dormer’s **Eave** and **Gable Overhangs**.
- 4 Check **Auto Roof Returns** to generate roof returns on the selected dormer. Roof Returns can be only specified for Gable dormers. See “Roof Returns” on page 263.
 - Specify the horizontal **Length** of the roof return in inches (mm).
 - Specify a **Gable, Hip, or Full** roof return.
 - Specify a **Sloping or Flat** roof return.

Walls Panel

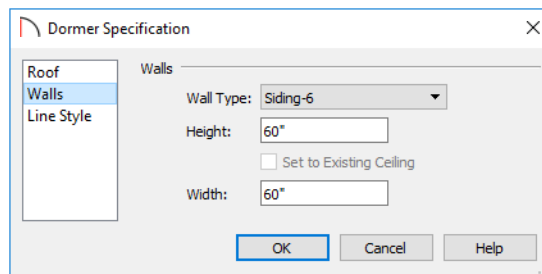

- Select a **Wall Type** for the dormer walls from the drop-down list.
- Specify the **Height** of the dormer, as measured from where the top of the underlying roof plane meets the dormer front wall exterior to the top plate of the dormer roof’s bearing walls.
- Check **Set to Existing Ceiling** to assign the ceiling height of the room behind the dormer to the

dormer. Not available in the **Dormer Defaults** dialog.

- Specify the dormer’s **Width**, measured from the outside surfaces of the dormer side walls.

Line Style Panel

For information about the settings on this panel, see “Line Style Panel” on page 103.

Roof Returns and Other Details

Home Designer Suite offers a selection of tools to add architectural details to your roof design.

Roof Returns

A roof return is a small decorative roof plane that connects to the low side of a gable roof overhang and extends below the upper triangular portion of the gable wall. Three styles of roof returns that can be produced.

The first two styles are called **Gable** and **Hip** returns since the return ends in a gable or hip.

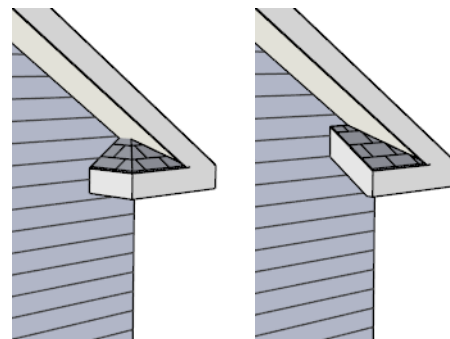

Hip Return

Gable Return

The third is called a **Full** return because it extends under the entire gable to connect both sides and is sometimes referred to as a water table. In order for a Full return to be created, the roof planes on each side must have the same height.

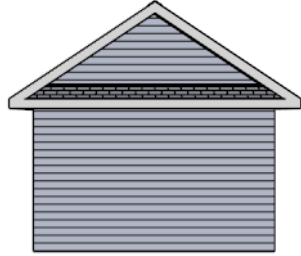

Full Return

Roof returns are generated automatically on a wall by wall basis using settings found in the **Wall Specification** dialog. See “Roof Panel” on page 126.

These roof return settings are also found in the **Dormer Specification** dialog for gable roof dormers and function similarly. See “Roof Panel” on page 262.

The pitch of an automatically generated roof return is the same as that of the roof plane above it.

Trim Tools

The Trim Tools allow you to place corner boards and quoins at wall intersections that form corners.

You can also assign moldings to a variety of objects, such as rooms and cabinets, in those objects' specification dialogs. See "Specification Dialogs" on page 25.

Trim and Molding Defaults



Select **Edit> Default Settings** to open the **Default Settings** dialog where you can access the defaults for a variety of drawing tools, including a number that affect trim and moldings.

- Click the + beside "Floors and Rooms", then beside "Floor Levels". Select a floor level and click the **Edit** button to specify the default moldings for rooms on that floor. See "Floor Level Defaults" on page 132.

Corner Boards



Corner boards are added to a building exterior in any view by selecting **Build> Trim> Corner Boards**.



Chapter Contents

- Trim and Molding Defaults
 - Corner Boards
 - Corner Board Specification Dialog
 - Quoins
 - Quoin Specification Dialog
 - Editing Corner Boards and Quoins
 - Millwork
 - Applying Moldings
- Click the + beside "Door" to access the defaults for Interior and Exterior Doors. See "Door Defaults" on page 169.
 - Select "Window" and click the **Edit** button to specify the default casing for windows. See "Window Defaults" on page 183.
- Wall and Full Height cabinets in many of the new plan Style Templates have crown molding. These cabinets can be placed from the library into any plan. See "Cabinet Defaults" on page 199.

Click at a wall corner where you want to add trim. Be sure to click where the outside wall surfaces meet. If you click where the inside surfaces meet, corner trim will be created inside the room.

Corner boards extend from the top plate down to the bottom of the floor platform of the floor on which it is placed, but do not extend to other floors. You must add corner boards to all floors of the building that you want to have corner boards.

A selected corner board or boards can be moved, but only to another wall corner or corners. In 3D views, corner boards can be lengthened or shortened using the edit handles. Corner boards can be copied, deleted and resized similar to other objects using the edit toolbar or the **Corner Board Specification** dialog.

The default material for corner boards is defined by the **Exterior Trim** entry in the **Material Defaults** dialog. See “Material Defaults” on page 294.

Corner Board Specification Dialog

 Select a corner board and click the **Open Object** edit button to open the **Corner Board Specification** dialog.

General Panel

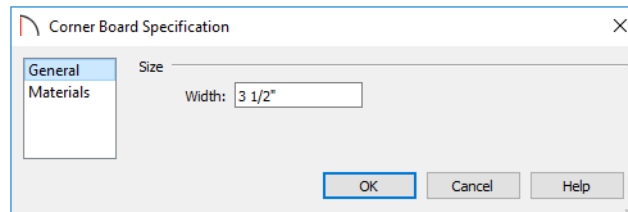

Specify the **Width** of the selected corner board.

information about these settings, see “Materials Panel” on page 296.

Materials Panel

The settings on the MATERIALS panel are available for a wide variety of objects in the program. For

Quoins

 Select **Build > Trim > Quoins** in any view and click at a wall corner where you want to place quoins.

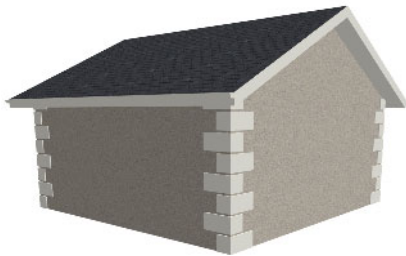

A selected quoin or quoins can be moved, but only to another wall corner or corners. In 3D views, quoins can be lengthened or shortened using the edit handles. Quoins can be copied, deleted and resized similar to other objects using the edit toolbar or the **Quoin Specification** dialog.

The size of quoins in plan view is relative on their size in 3D.

Initially, quoins use the same material as the default material of the wall surface they are placed against.

Quoin Specification Dialog

 Select a quoin and click the **Open Object** edit button to open the **Quoin Specification** dialog.

General Panel

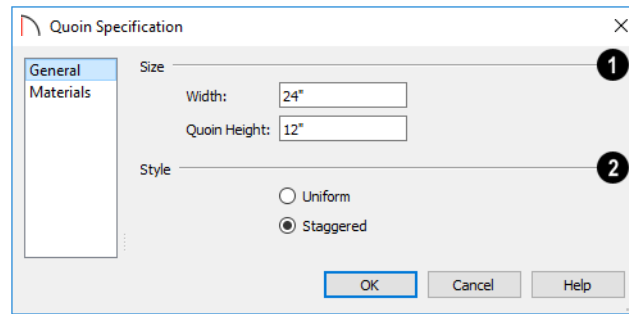

- 1 Specify the **Size** of the quoins in the selected Quoin object.
 - Specify the **Width**, which is the horizontal dimension of each quoin in the selected Quoin object. The dimension along the other wall is half this value when they are staggered or mirrored.
 - Specify the **Quoin Height** for individual quoins in the selected Quoin object.
- 2 Specify the arrangement of quoins used by the selected Quoin object.
 - **Uniform** - Produce quoins that are of equal length on both sides of the corner.
 - **Staggered** - Produce quoins that have one long side and one short side staggered on opposite sides of the corner.

Materials Panel

The settings on the MATERIALS panel are available for a wide variety of objects in the program. For information about these settings, see “Materials Panel” on page 296.

Editing Corner Boards and Quoins

Before a corner board or quoin can be edited, it must be selected. Click on a trim object when the **Select Objects**  tool is active. Corner boards and quoins can also be group selected and edited. See “Selecting Objects” on page 79

Corner boards and quoins can be edited using their edit handles, the edit toolbar buttons, and their specification dialogs.

Using the Mouse

Depending on the type of view, a corner board or quoin displays a different set of edit handles when selected.

- In plan view, corner boards and quoins display one edit handle and can be moved from one eligible location at a wall corner to another.

Millwork

A selection of various types of millwork including columns, corbels and finials is available in the Library Browser. See “The Library Browser” on page 271.

- In 3D views, corner boards and quoins can be moved, lengthened, and shorted much the other line-based objects are. See “Editing Line-Based Objects” on page 82.

Using the Edit Buttons

A selected corner board or quoin can be edited in a variety of ways using the buttons on the edit toolbar. See “The Edit Toolbar” on page 23.

Deleting Corner Trim

Corner boards and quoins can be selected individually or in groups and deleted using the

Delete  edit button or the Delete key on the keyboard. They can also be removed using the **Delete Objects** dialog. See “Deleting Objects” on page 98.

Most millwork objects are designed to be placed in a plan as free-standing objects. Some - notably, newels and balusters - can be assigned to objects such as railings and stairs. See “Placing Library Objects” on page 281.

Millwork assigned to an object can be replaced from the library in 3D views. See “Replace From Library” on page 283.

Applying Moldings

Moldings can be applied to a variety of different types of objects in Home Designer Suite, including rooms, doors, windows, and cabinets. Moldings are assigned to their containing object in that object’s specification dialog.

Replacing an Existing Molding

If a molding profile has already been applied to an object, it can be replaced by another directly from the library in a 3D view. Select a molding in the library,

then click on a molding assigned to an object in the plan. See “Replace From Library” on page 283.

In a 3D view, select a molding profile from the Library Browser and move your mouse pointer into the view window. When a molding is selected, the

pointer displays the Moldings  icon. When the mouse pointer is moved over a molding in the view,

the Replace From Library  icon displays instead. Click on the molding in the view to change its molding profile.

Moldings Panel

 The specification dialogs for a variety of objects in the program include a MOLDINGS panel. Select an object or group of similar objects

and click the **Open Object** edit button to open the specification dialog for that selection.

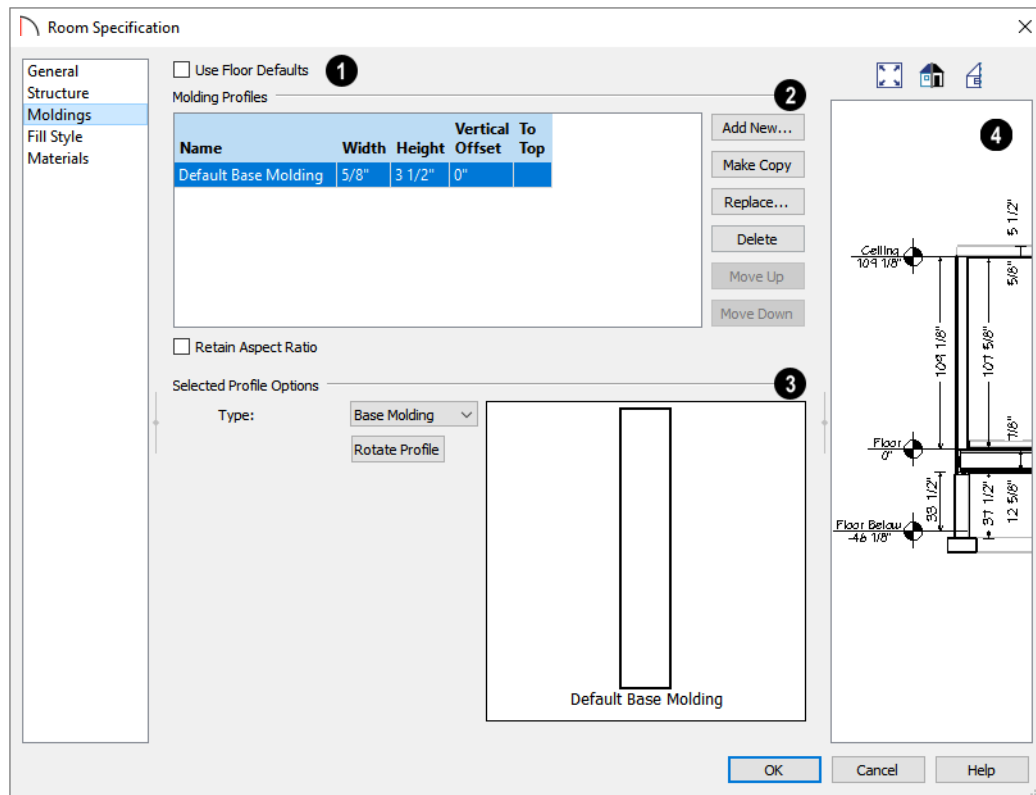

- 1 At the top of the dialog, one or more check boxes may be available.
 - Only available for rooms, uncheck **Use Floor Default** to make the settings that follow active.

Check this box to use the defaults set in the **Floor Defaults** dialog for the current floor. See “Floor Level Defaults” on page 132.

- If multiple objects with different moldings assigned to them are selected, a **No Change** check box will be available. Uncheck this box to make the settings that follow active but note that only moldings that all selected objects have in common will be retained.

2 The selected object's **Molding Profiles** are listed in a table and can be edited here.

- Select the name of a molding to edit it or remove it from the object.
- Click in the **Width** and/or **Height** column and type to specify the selected molding's size.
- Specify the **Vertical Offset** of the selected molding, measured relative to the default molding location on the object it is assigned to.
- A check mark in the **To Top** column means that the Vertical Offset value is measured from the top of the molding. When unchecked, this value is measured from the bottom of the molding. Click to place or remove a check mark.
- When **Retain Aspect Ratio** is checked, if you change either the Height or Width, the other value changes to maintain their original ratio. When this is unchecked, the two values can be edited independently.

The buttons on the right allow you to manage the moldings listed in the table.

- Click the **Add New** button to open the **Select Library Object** dialog and add a new molding profile to the selected object. See "Select Library Object Dialog" on page 283.
- Click the **Make Copy** button to add a copy of the selected molding profile at the bottom of the list.
- Click the **Replace** button to remove the selected profile and replace it with a new profile from the Library.

- Click the **Delete** button to remove the currently selected profile from the table.
- Click the **Move Up** or **Move Down** button to change the order of the line items in the table. This does not change a selected item's Height, Offset, To Top setting, or Type: only its position in the table.

3 The **Selected Profile Options** only apply to the molding profile selected above.

- A preview of the molding profile(s) displays here. When multiple moldings of the same Type, To Top setting, or similar Height are specified, they will display together here, even when only one is selected. The selected profile is identified by thicker edge lines than the others. When multiple moldings of different Types, To Top, or Height settings are selected, no preview will display.
- Click the **Rotate Profile** button to rotate the selected profile 90° counterclockwise, or to the left. Not available for stacked moldings or a selected molding symbol.
- Choose the currently selected molding's **Type** from the drop-down list: Base Molding, Chair Rail, or Crown Molding. See "Room Moldings" on page 141.

Note: The Default Base Molding is a basic rectangular stock profile rather than a profile from the library.

- 4** Many specification and defaults dialogs have previews of the selected object in which the moldings assigned to it can be seen. See "Dialog Preview Panes" on page 25.

The Library

Home Designer Suite’s library offers thousands of symbols, materials, and images that can enhance any plan.

New library catalogs and enhancements are made available by Chief Architect on a continuing basis and are available for download for the current program version.



You can also customize items from the library or import new items from outside the program and then save them in the library for future use.

The Library Browser



The Home Designer Suite Library Browser allows you to manage the contents of the library as well as add library content to your drawings.

To open the Library Browser:

- Select **View> Library Browser** .
- Click the **Library Browser** button .
- Press **Ctrl + L** on your keyboard.

By default, the Library Browser is docked to the right side of the program window, but can be undocked or docked to another side. See “Docking the Library Browser” on page 274.

The Library Browser has four sections:

Chapter Contents

- The Library Browser
- Searching the Library
- Find in Library
- Library Content
- Downloading Library Content
- Importing Library Catalogs
- Adding Library Content
- Organizing the Library
- Exporting Library Catalogs
- Placing Library Objects
- Select Library Object Dialog
- Displaying Library Objects
- Editing Library Objects
- Symbol Object Specification Dialogs

- The search options at the top.
- The Directory and Search Results Pane.
- The Selection Pane.
- The Preview Pane.

To adjust the height or width of a section, place the pointer over the split bar you want to move. When the double-headed arrow \leftrightarrow displays, click and drag.



You can control the configuration of the Library Browser panes in the Preferences dialog. See “Library Browser Panel” on page 52.

You can work on your drawing with the Library Browser open. To close the Browser, click the Close

✕ button or double-click on an object in the Selection Pane.

The library directory is presented in a tree list with five categories: Home Designer Core Catalogs, Home Designer Bonus Catalogs, Manufacturer Catalogs, User Catalog and Trash. See “Library Content” on page 276.

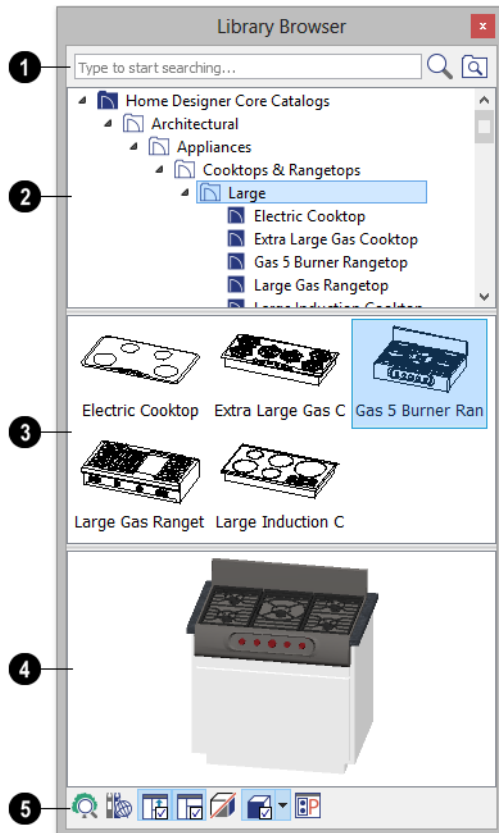

1 Search the library using keywords and optional search filters. See “Searching the Library” on page 274.

- Begin typing in the text field to search for library items. As you type, search results will display in the Directory Pane.
- Search a specific catalog or folder by right-clicking on it and selecting Search Folder. Multiple items can be searched in this manner.
- Right-click on an item in the Search Results list and select **Show in Browser** to view the item’s location in the Directory list.
- Click the **Browse** button to stop searching and restore the Directory list.
- Click the **Search** button to display the search results for your search entry.

- Click the **Search Filtering Options** button to customize your search parameters. If the Library Browser is resized so that it is narrow, this button will be replaced by two arrows.

2 The library **Directory** and **Search Results** display here. The basic structure of the directory tree is:

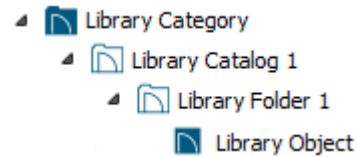

Library items are always placed in alphabetical order within their hierarchy.

The Library Browser includes a Trash bin, where deleted items are moved until you choose to Empty Trash. See “Deleting Library Items” on page 281.

Navigate the Directory Pane using the mouse. Click the gray Expand arrow beside a catalog or folder to display its contents. Once expanded, you can click the black Collapse arrow to close it again. You can also browse the list using the arrow keys on your keyboard.

Click on an item to select it. Preview images display in the Selection and Preview Panes and basic information about it also displays in the program’s Status Bar. See “The Status Bar” on page 26.

3 The **Selection Pane** shows a thumbnail image of the item selected in the Directory Pane.

When an item is selected in the Directory Pane, a basic line-based representation of the item displays in the Selection Pane.

- If the selected item is a single object, a preview of that object displays in the Preview Pane. You can move your cursor into the drawing area to place the item. See “Placing Library Objects” on page 281.
- If the selected item is a folder, a thumbnail image displays, representing each item inside. Move your pointer over an item in this pane to see a Tool Tip with the item’s name. Click on a folder in the Selection Pane to display its contents here and make it the item selected in the Directory Pane.
- Some folders may have too many items to display useful thumbnails for each; when this is the case, they do not display.

Click the **Show/Hide Selection Pane**  button to toggle the Selection Pane on and off.

4 When an individual item is selected in either the Directory or Selection Pane, an image of it displays in the **Preview Pane**. If the item is designed to be inserted into another object such as a cabinet, that parent object will also display in the preview.

You can click the **Toggle Preview Display**  button at the bottom of the browser window to switch between preview images in high and low detail.

If the selected object is a 3D symbol, you can rotate and zoom in or out on the Preview using the mouse.

If you have rotated a view in the Preview Pane, you can restore the default angle either by clicking in the Selection Pane or by right-clicking on the Preview Pane and selecting **Reset Preview**.

Click the **Show/Hide Preview Pane**  button to toggle the Preview Pane on and off.

5 The toolbar at the bottom of the browser aids in searching, displaying panes, and managing library content.

 Click the **Plant Chooser** button to open the **Plant Chooser** dialog. See “Plant Chooser Dialog” on page 372.

 Click the **Get Additional Online Content** button to launch your default web browser to the Home Designer Suite web site, where additional library content is available for download.

 Click the **Show/Hide Selection Pane** button to toggle the Selection Pane on and off.

 Click the **Show/Hide Preview Pane** button to toggle the Preview Pane on and off.

 Click the **Toggle Preview Display** button to switch between high and low detail images of a selected library object in the Preview Pane.

 A selected material will display on a shape in the Preview Panel. The initial shape is a Sphere, but you can select a Cube, Teapot, or 2D Plane instead if you prefer.

 Click the **Preferences** button at the bottom of the Library Browser to open the **Preferences** dialog, where display properties for the Library Browser can be controlled. See “Library Browser Panel” on page 52.

Using the Contextual Menus

A number of important library functions can be accessed using the contextual menus. Right-click on an item in the Library Browser to open a contextual menu displaying options related to that item. See Contextual Menus.

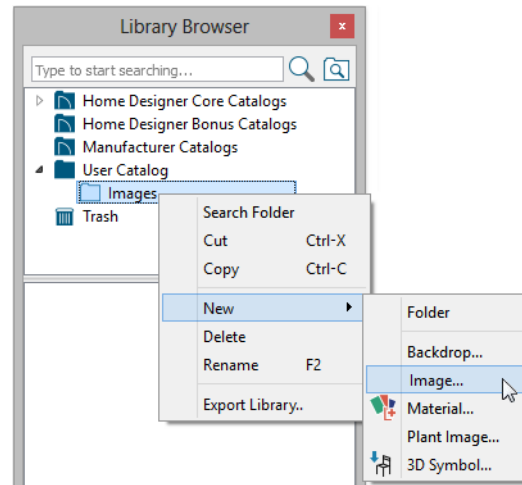

The options in the contextual menu vary depending on the item selected, but may include:

- Search Folder
- Cut/Copy/Paste
- Paste Shortcut
- Locate Shortcut Source
- New
- Rename
- Delete
- Export Library
- Open Object
- Reset Preview
- Expand All/Collapse All
- Show in Browser

Keyboard Commands

The Library Browser can be navigated using the arrow keys on your keyboard.

- The right and left arrow keys expand and collapse folders.
- The up and down keys change which library object is currently selected.
- Select an item and press F2 to rename it.
- Select an item and press the Delete key to delete it.

Expand/Collapse All

When a library category or folder is selected in the Directory Pane, **Expand All** and **Collapse All** are available in the contextual menu, allowing you to expand or contract its contents in the tree view.

Docking the Library Browser

Initially, the Library Browser side window is docked to the right side of the main Home Designer Suite program window. To undock it, click and drag its title bar towards the center of the program window. Once undocked, it can be moved and redocked in the same manner. See “Side Windows” on page 22.



When moved to the top, bottom, or side of the program window, it automatically docks in a vertical

or horizontal orientation, depending on its location. You can prevent the Library Browser from docking by holding down the **Ctrl** key while dragging it.

To return the Library Browser to its original position and size, click the **Restore Position/Size** button in the **Preferences** dialog. See “Reset Options Panel” on page 55.

Closing the Library Browser



The Library Browser can be closed in either of two ways:

- Click the **Close**  button at the top right corner of the browser window.
- Select **View > Library Browser** .

Searching the Library

The Library Browser filtering options let you focus your searches to meet parameters that you define.

To search the Library Browser

1. Select **View > Library Browser**  and click in the Search field at the top of the Library Browser.
2. Begin typing a keyword to search for. As you type, the search results will populate in the Directory Pane below.
3. You can use quotation marks “” to search for an exact word or phrase, but other operations are not supported.
4. You can click the **Clear**  button on the right side of the Search field to remove anything typed in this field.
5. If you move your mouse pointer over the Search field, a Tool Tip will state the number of results of your search.
6. Right-click on an item in the Search Results list and select **Show in Browser** to view the item’s location in the Directory list.

You can also search the contents of one or more specific catalogs and/or folders. Right-click on a catalog or folder level item or group-select multiple catalogs and/or folders and right-click on them, select **Search Folder** from the contextual menu, and proceed with step 2, above. See “Shift and Ctrl Select” on page 81.

Substrings are not included. For example, searching for “windows” will not produce “window” as a search result. On the other hand, searching for “window” will produce “windows” as a search result.

To search using custom filters

1. Click the **Turn on search filtering options**  button.
 - Check **Keyword** to match the entered search keyword with an object’s search attributes.
 - Check **Entire Word** to match the entire keyword or words with the complete name of the object.
 - Check **Folders** to include library folders in your search.
2. Click the arrow beside **Type**, **Style**, or **Manufacturer** to expand that category.
 - Check the box beside one or more **Type** of library item that you want to include in your search.
 - Check the box beside one or more architectural or design **Style** to include items of that style in your search.
 - Check the box beside one or more **Manufacturer** to include in your search. Manufacturer catalogs that were imported during the current program session will not be listed here until you exit out of and restart Home Designer Suite.

 To save time, check the box beside Type, Style, or Manufacturer to select all of the options in that category at once; uncheck the box to deselect all of the options.

Find in Library

 You can find out whether a selected object is saved in the library and if so, where, using the **Find Original in Library** edit tool.

The **Find Original in Library** edit tool also allows you to locate any objects inserted into the selected object as well as any materials or moldings assigned to it. See “Inserted Objects” on page 282.

Find in Library Dialog

The **Find in Library** dialog opens when you select one or more objects and click the **Find Original in Library** edit button. This dialog lists all of the selected objects as well as all objects assigned to and inserted into them.

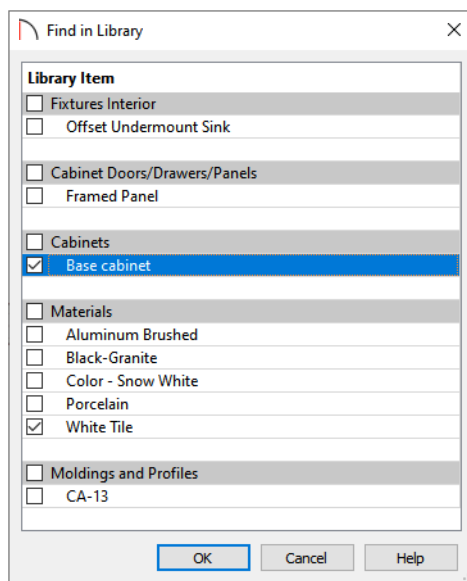

Highlighted line items are categories that may have multiple components beneath them.

- Check the box beside a line item to find that object in the library.
- Check the box beside a category heading to select all items in that category.

When you click OK, the dialog will close and one of three things will happen:

3. Type a keyword in the **Search** field. The results will be filtered to match your selected filtering options.

- If a single line item was selected in the **Find in Library** dialog was clicked, that item will be selected in the tree list of the Library Browser.
- If the single line item is not found in the library, a message box will inform you of this and give you the option of adding it to the library.
- If multiple line items were selected, the **Show in Library Results** dialog will open, summarizing the status of each.

Show in Library Results

If multiple line items are selected in the **Find in Library** dialog, the **Show in Library Results** dialog will report where, or if, they are found in the library.

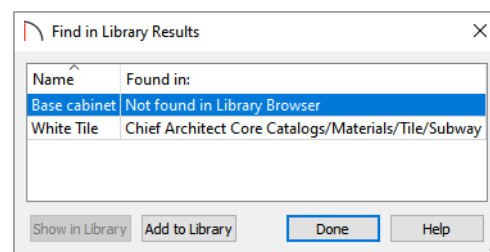

Each line item selected in the **Find in Library** dialog is listed here.

- Click on a line item to select it. Multiple lines can also be selected. See “Shift and Ctrl Select” on page 81.
- Click the **Show in Library** button to locate and select the selected line item in the tree list of the Library Browser. Not available if the selected item is “Not Found in Library Browser”, or if multiple line items are selected.
- Click the **Add to Library** button to add the selected line item(s) to the User Catalog in the library.
- Click the **Done** button to close the dialog.

Library Content

The Home Designer Suite library has five categories: Home Designer Core Catalogs, Home Designer Bonus Catalogs, Manufacturer Catalogs, User Catalog and Trash.

Home Designer Core Catalogs

The Home Designer Core Catalogs category contains a wide selection of 3D symbols, images, and materials. If you install the program from USB drive, this library content will also be installed; if you download the software, you will be able to download the Core Catalogs separately, after the program is installed.

When you launch the program for the first time, it will ask if you want to download the Core Catalogs. Click Yes to begin the download. If you click No, you can download at any time by selecting **Library> Install Core Content** from the menu.

Home Designer Bonus Catalogs

Chief Architect regularly posts new library catalogs available for download. Select **Library> Get**

Additional Content Online  from the menu to access the bonus catalogs and content.

Most Bonus Catalogs can be purchased for a nominal fee, while others are available free of charge. In addition, some Bonus Catalogs are only available to Chief Architect Support and Software Assurance program members.

Manufacturer Catalogs

A variety of name brand library catalogs is available for download on the Home Designer web site with content ranging from materials to fixtures.

Select **Library> Get Additional Content Online**

 to access these Manufacturer Catalogs.

As with the Bonus Catalogs, some Manufacturer Catalogs are available free of charge while others can be purchased, and some are available for Support and Software Assurance members only.

Note: Support and Software Assurance is an optional program for holders of Chief Architect Premier and Chief Architect Interiors software licenses and is not available for Home Designer licenses.

The User Catalog

The User Catalog is the location for items that you add to the library either from a drawing or by importing. See “Adding Library Content” on page 279.

You can create and organize custom library folders and imported items such as symbols, images, backdrops, and materials. See “Organizing the Library” on page 279.

Updating Library Catalogs

The Home Designer Core Catalogs, Bonus Catalogs, and Manufacturer Catalogs are updated periodically to include new and improved content. You can update your installed catalogs to include the latest content by selecting **Library> Update Library Catalogs** at any time.

The program will gather information about the content in each of these three categories, and then download and replace any content that is not up to date, and you may see a progress indicator at the bottom of the Library Browser while it is doing so. See “Download Progress” on page 277.

Library Content Location

All library content aside from your User Catalog is stored in the **System Library Database Folder**. This folder is created in the directory intended for shared application data in your operating system (C:\ProgramData in Windows; /Library/Application Support in macOS).

The Home Designer User Catalog File, User_Library.calib, is located in the Home Designer Suite 2021 Data folder by default. See “Home Designer Suite Data” on page 32.

You can specify a different location for the Data folder if you wish in the **Preferences** dialog. If you choose a removable drive or network location, library slowness may result. See “Folders Panel” on page 53.

If you choose to use a different location, it is important that you specify a directory on a hard drive with sufficient space to hold these files.

 Library catalogs are not designed to be shared between program titles or versions. Items designed for use in Home Designer Suite 2021 are not compatible with earlier program versions.

Backing up Custom Content

The best way to back up your custom library content is to export the items in your User Catalog, as this will ensure that the textures used by custom materials or imported symbols are not lost. See “Backing Up Your Files” on page 36.

Exported libraries use the **.calibz** file format: a zipped file type that can include textures and images along with other library data.

Downloading Library Content

The Home Designer Core Catalogs, Home Designer Bonus Catalogs, Manufacturer Catalogs are all available for internet download.

Core Catalogs

When you launch Home Designer Suite for the first time, you will be asked if you want to download the Core Catalogs. Click Yes to begin the download.

If you click No, you can download at any time by selecting **Library> Install Core Content** from the menu.

Bonus and Manufacturer Catalogs

Bonus and Manufacturer Catalogs can be downloaded from our web site, www.HomeDesignerSoftware.com. Select

Library> Get Additional Content Online  to launch your default internet browser to our Content Resources page.

Download Progress

When library content is downloading, a green progress bar will display at the bottom of the Library Browser. If you choose to download the Core Catalogs while the library is not open, the Browser will open so the progress indicator can display.

Click on the progress bar to display the name of the current file being downloaded, the total amount of data to be downloaded in KB, and the amount downloaded so far.

To back up your custom library content

1. Launch Home Designer Suite and select **View> Library Browser**  from the menu.
2. Right-click on a folder or item in the User Catalog.
3. Select **Export Library** from the contextual menu.
4. The **Export Library Data** dialog is a typical Save dialog. See “Exporting Files” on page 36.
 - Notice that the file type in the Save as type field is “Library File with Textures/Images (*.calibz)”.

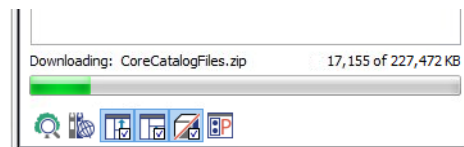

Pausing and Resuming

Library downloads can only take place while Home Designer Suite is running. If you close the program while a download is in progress, a dialog will confirm whether you wish to stop the download.

- Click **Stop Download and Close Program** to stop the download and close the program.
- Click **Cancel** to leave the program open and continue downloading.

Most catalogs are composed of a single file. If you stop the download midway, none of the downloaded data will be retained.

The Core Catalogs, on the other hand, contain a large volume of data saved in multiple files. If you close the program and stop the Core Catalogs download midway, only data associated with the file currently being downloaded will be lost. You can resume the download beginning with that file at a later time by selecting **Library> Install Core Content**.

Download Errors

If any problems occur during the library download process, a dialog box will notify you at the end of the download. Click **Retry Download** to repeat the

download and correct any errors or click **Cancel** to discard the downloaded catalog.

Importing Library Catalogs

Home Designer Suite library files have two different file extensions: **.calib** and **.calibz**. Both files can include any combination of Home Designer Suite library items; in addition, **.calibz** files are able to save data associated with textures and images. Both file types can be imported into the Home Designer Suite library.

There are several ways to import a **.calib** or **.calibz** file into the program library:

- Double-click on the file in an operating system window while a plan file is open.
- Drag the file from an operating system window and drop it into the Home Designer Suite program window.
- Select **Library> Import Library** from the program menu.

Although multiple versions of Home Designer can be installed on a computer, the operating system will only associate **.calib** and **.calibz** library files with one version. If they are not associated with Home Designer Suite 2021, click the **Associate Files with this Program** button in the **Preferences** dialog. See “File Management Panel” on page 53.

Note: Library files cannot be imported if no plan file is open, or when a Materials List window is active.

To import library files into the library

1. Select **Library> Import Library** to display the **Import Library Data** dialog.
2. Browse to the **.calib** or **.calibz** file(s) that you want to import and either single or group-select the files so that their names display in the **File Name** field.
 - To select a group of files, click on the first one, hold down the Shift key, then click on another file. The two files plus all files in between are selected.
 - To select multiple files individually, click on one, hold down the Ctrl key, then click on additional files. Only the files you click on are selected.

- To select all files in the directory, click on one and press Ctrl + A. Only do this if you wish to import all files in the folder.
3. Click the **Open** button.
 4. A progress bar will display, telling you the progress of each library data file as it is imported.
 5. Once imported, each file will be listed in its corresponding library category and will be selected in the Library Browser tree list. See “Library Content” on page 276.

When a **.calibz** file is imported into the program, any images or textures saved in it will be copied into the Home Designer Suite 2021 Data\Images and Textures folders for backup purposes. The program will only reference these copies if it cannot locate the files in their original locations. See “Home Designer Suite Data” on page 32.

Library Catalog Migration

If you have library catalogs from Home Designer Suite 2014 through 2020 installed on your computer, the initial startup of Home Designer Suite 2021 will give you the opportunity to migrate that content into the Home Designer Suite 2021 Library. See “Migrating Content and Settings” on page 13.

Legacy Library Conversion

You can import **.calib** and **.calibz** files created in Home Designer versions 2012, 10, or 9 for use in version 2021 at any time. See “Exporting Library Catalogs” on page 281.

Note: Library content exported from Home Designer Suite 10 will not include catalog names. Any subscribed content from version 10 that has not been downloaded will not be included, either.

In addition, legacy **.alb** files created in Home Designer versions 8.0 and prior can be converted for use in version 2021.

To convert legacy library files

1. Select **Library> Convert Legacy (.alb) Library Files**.

2. In the **Select a Legacy Library File Folder** dialog, select an **.alb** file that you want to bring in to Home Designer Suite 2021.
3. The selected file's name will display in the **File name:** field.
4. Click the **Open** button to import the prior version third party **.alb** file into the User Catalog.
5. Organize the imported content to suit your needs. See "Organizing the Library" on page 279.

Adding Library Content

In addition to downloading Home Designer Suite Content and importing entire catalogs into the library, you can also add a variety of individual objects to the library.

Add to Library

Nearly any object imported into a plan or placed from the Library Browser can be added to the User Catalog in the library.

- Check **Add to Library** in the **Import 3D Symbol** dialog. See "Importing 3D Symbols" on page 345.
- Select an object in your plan and click the **Add to Library**  edit button.

A few objects cannot be added to the library: notably terrain objects, CAD objects, imported pictures, metafiles, and PDF files.

Any object created using a drawing tool in Home Designer Suite will automatically be added to the User Catalog using the name of that tool, whereas a symbol will automatically use the Symbol Name. See "Native Objects vs Symbols" on page 284.

Once added to the library, objects in the User Catalog can be renamed. See "Renaming Library Items" on page 280.

Using the Contextual Menu

A variety of new content can be added to the User Catalog by right-clicking on it or on a folder within it and selecting **New>** from the contextual menu:

- Backdrops - See "3D Backdrops" on page 333.

Organizing the Library

Library folders and objects can be copied, pasted, moved, and deleted: allowing you to organize your User Catalog to best suit your work style and needs.

- Images - See "Images" on page 326.
- Materials - See "Creating Materials" on page 299.
- Plant Image - See "Plant Image Specification Dialog" on page 373.
- 3D Symbols - See "Importing 3D Symbols" on page 345.

See also "Using the Contextual Menus" on page 273 and "Adding New Folders" on page 279.

Creating a Customized Library Item

You can customize an existing library item and save your changes for future use by first copying the item into an unlocked library.

To customize a library object

1. Right-click on a library item and select **Copy** from the contextual menu.
2. Browse to the User Catalog or a folder within it and right-click on it.
3. Select **Paste** from the contextual menu to make a copy of the library item in this new location.
4. Right-click on the copied item and select **Open Object**  from the menu.
5. The item's specification dialog opens, and you can make any changes that you wish to the item.
6. Make any needed changes to the item, then click OK. Your changes will be saved with this item for use in any plan.

Adding New Folders

New folders can be added to the User Catalog or to any folder located within it. To add a new folder, right-click on User Catalog or one of its sub-folders and select **New> Folder** from the contextual menu.

The new folder is created inside the library item you right-clicked on and is initially named “Untitled”. Type a short, descriptive name and press Enter.

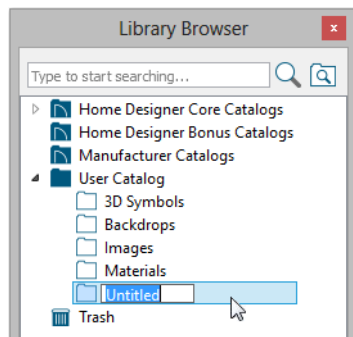

Selecting Library Items

To select a library object, folder, or category, simply click on it.

When an item is selected, preview images display in the Selection and Preview Panes and basic information about it also displays in the program’s Status Bar. See “The Status Bar” on page 26.

A selected library item can be modified in a number of ways to help meet your organizational needs.

Renaming Library Items

Only folders and objects in the User Catalog can be renamed. There are several ways to do this from the tree list:

- Right-click on the item, select **Rename** from the contextual menu, and type a new name.
- Click once on the item, press F2 on your keyboard and type a new name.
- Click once on the item, pause for a moment, then click a second time and type a new name.

Library names are case-sensitive and can contain up to 63 characters. While you can have more than one library item that uses the same name, it is best to use short, descriptive and unique names.

Moving Library Items

Folders and objects in the User Catalog can be moved to new locations within the User Catalog. Folders and library objects are always organized alphabetically within each hierarchy.

To move an item to a different location, select it in the tree list, then click and drag it to the new location in the list. Directories and folders able to accept new content highlight as your mouse pointer moves over

them. Release the mouse button to relocate the selected library item in the highlighted location.

You can also cut a library item from one location and paste it in another. When an item is cut, it is removed from its current location and saved to the system clipboard. To cut an item:

- Right-click on it and select **Cut** from the contextual menu.
- Click on the library item and press Ctrl + X on your keyboard.

To **Paste** the item, click on a library catalog or folder in the Library Browser tree view and either:

- Right-click on the new location and select **Paste** from the contextual menu.
- Press Ctrl + V on your keyboard.

Copying Library Items

All library folders and library objects can be copied and pasted to new locations in the User Catalog.

There are two ways to copy a library item to the system clipboard:

- Right-click on it and select **Copy** from the contextual menu.
- Click on the library item and press Ctrl + C on your keyboard.

To **Paste** the item, click on a library catalog or folder in the Library Browser tree view and either:

- Right-click on the new location and select **Paste** from the contextual menu.
- Press Ctrl + V on your keyboard.

When a library item is copied and pasted, the new item that results is independent of the original item. If you make changes to it, the original item is unaffected. Similarly, changes to the original item do not affect the copy.

Library Shortcuts

In addition to copying and pasting to create new, independent library items, you can copy and paste to create Library Shortcuts. Library Shortcuts are not independent items - they are linked to the original item and are affected if changes are made to the original.

Library Shortcuts are advantageous because you can place a given library item in multiple locations to suit your organizational style without increasing the size

of the library database and without having to maintain multiple copies of the same item.

To create a Library Shortcut, copy a library item to the system clipboard. Then, right-click on the location where you would like to create a copy and select **Paste Shortcut** from the contextual menu. Library Shortcuts use the same name as their source item but use the Library Shortcut  icon.

To locate a Library Shortcut's source item, right-click on it in the tree list and select **Locate Shortcut Source**.

If you move or delete an item from the library, any shortcuts to it will not be updated or removed. If you try to use a “hanging” shortcut, a message about its status will display in the library preview panes.

Deleting Library Items

The five installed library categories: Home Designer Core Catalogs, Home Designer Bonus Catalogs, Manufacturer Catalogs, User Catalog, and Trash cannot be deleted.

Catalog level folders in all categories can be deleted; however, individual subfolders and objects can only be deleted out of the User Catalog.

Exporting Library Catalogs

Exporting library files allows you to:

- Back up your custom library content.
- Transfer library content between computers.

Exporting is often preferable to simply copying library files because it allows you to include images and textures in the exported library.

To export content from the library

1. Locate an object, folder, or catalog that you want to export, right click on it, and select **Export Library**.
2. In the **Export Library Data** dialog.
 - Choose the appropriate **Save in:** location for your exported library file.
 - Type a short, descriptive name for your library file in the **File Name** field.

Placing Library Objects

Library objects are subject to placement restrictions based upon typical real-life placement. Most library

Items in the library that are eligible for deletion can be deleted in either of two ways:

- Right-click on it and choose **Delete** from the contextual menu.
- Select it and press the **Delete** key on your keyboard.

When items from the User Catalog are deleted, they are moved to the Library Browser Trash . Items in the Trash can be retrieved by clicking and dragging them into any location in the User Catalog.

To empty the Trash , right-click on it and select **Empty Trash** from the contextual menu.

Depending on how much content is in the Trash, emptying it can be time consuming. You can click the **Cancel** button to end the process if you wish.

 The Empty Trash command is both immediate and permanent. It cannot be undone, so use care when using it. You should back up all your library files regularly. See “Backing up Custom Content” on page 277.

- Click the **Save as type:** drop down list and select whether or not you want the library to include Textures/Images.

 If any of the items being exported are images or use textures, be sure to select the **.calibz** file type.

- Click **Save**.
3. Your exported library file can now be copied to a network location or storage device in an operating system window.

Any Shortcuts  present in a catalog will be converted to regular library objects when exported. See “Library Shortcuts” on page 280.

objects require sufficient free space at the location where they are placed, for example, and some library objects have additional requirements.

Library windows and doors, for example, must be placed in a wall just like standard windows and doors, and some fixtures are designed to be placed in cabinets.

Library symbols have placement restrictions that are determined when the symbol is created but can be changed later. See “Native Objects vs Symbols” on page 284 and “Symbol Specification Dialog” on page 183.

If a warning message displays when placing a library object, it will indicate where the object can be placed.

There are three main categories of items available in the Library Browser:

- Stand-alone objects that can be placed directly into a plan. Examples include cabinet modules, furnishings and images.
- 3D objects designed to be inserted into another 3D object. Examples include cabinet fixtures, windows and doors. Some items, such as cabinet doors and fixtures and fence panels, can be inserted into another object or placed as stand-alone objects.
- Materials, which cannot stand alone and must be assigned or applied to another object.

Stand-Alone Objects

Most library categories contain objects that can be selected in the Library Browser and placed directly in a 2D or 3D view.

- Most stand-alone objects are designed to rest on the floor or terrain.
- Some objects will rest on top of a cabinet, shelf, furniture or roof plane object if one is located at the point where they are first placed.
- A few objects, notably some light fixtures, will mount on the bottom of a wall cabinet or on the ceiling.
- In addition, some objects will attach to a wall if one is nearby.

To place a stand alone library object

1. Click on an object in the tree view or Selection Pane of the Library Browser to select it for

placement. See “The Library Browser” on page 271.

2. Move your mouse pointer into the view area and notice that it displays an icon indicating the type of object selected instead of an arrow.
3. Click to place the selected object at that location.
4. Continue clicking to place as many instances of the selected object as needed. When you are finished, click the **Select Objects**  button.

Once a stand-alone object has been placed, it can be edited in a variety of ways. See “Editing Library Objects” on page 284.

Inserted Objects

Some objects cannot stand alone and must be placed into other objects in a plan. For example, doors and windows must be inserted into a wall, while some appliances and plumbing fixtures are designed be placed inside a base cabinet. See “Doors” on page 169, “Windows” on page 183 and “Cabinets” on page 199.

With the exceptions of doors, windows, and skylights, an inserted library object can only display in a 2D or 3D view if the object that contains it is set to display. This is the case even if the inserted object’s layer is turned on. See “Displaying Library Objects” on page 283.

To insert a library object

1. Click on an item in the tree view or Selection Pane of the Library Browser to select it for placement. See “The Library Browser” on page 271.
2. Move your pointer into the drawing area.
3. Click on the object into which you wish to insert the selected library item. If the selected library item is designed to be inserted into that type of object, it will be placed into it.
4. Continue clicking on other objects to place as many instances of the selected item as needed. When you are finished, click the **Select Objects**  button.

When an object has been inserted into another object, it can be replaced directly from the library. See “Replace From Library” on page 283.

Assigned Items

Some library items, such as materials, are not objects in themselves but can be applied to objects in a variety of ways.

- Using the specification dialog of the containing object. See “Select Library Object Dialog” on page 283.

Select Library Object Dialog

The **Select Library Object** dialog is a modal version of the Library Browser that is accessible from object specification dialogs. See “Specification Dialogs” on page 25.

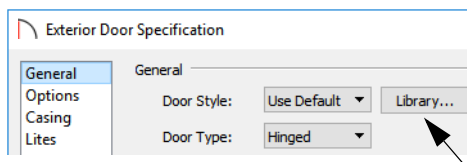

The **Select Library Object** dialog only displays categories of items that are related to the selected

- By selecting the item in the library and then clicking on the containing object.
- Materials can be assigned to objects directly from the library in 3D views by selecting the material and then clicking on an object’s surface. See “Eyedropper and Painter Tools” on page 97.

object. For example, if this dialog is accessed from the GENERAL panel of the **Door Specification** dialog, only door symbols will be listed:

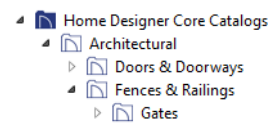

The **Select Library Object** dialog is similar to the LIBRARY MATERIALS panel of the **Select Material** dialog. See “Select Material Dialog” on page 297.

Replace From Library

In 3D views, an inserted object can be replaced by a different item from the library with a single click. See “Inserted Objects” on page 282.

To replace an inserted object

1. Open the Library Browser, and browse to an object of a type similar to the one you wish to replace.
2. Select the object and move the mouse pointer into the 3D view window.

3. The Replace from Library  icon will display near the mouse pointer when it passes over an object that can be replaced by the selection from the library.
4. Click once to replace the object in the plan with the selected object from the library.

Some types of inserted objects - notably, doors and cabinet doors and drawers - can also be replaced in this manner in plan view. The Replace from Library  icon does not display in plan view, however.

Displaying Library Objects

The display options available for library objects depend on the type of object in question, as well as the view.

If the display of an object is turned off in a 2D or 3D view, any objects inserted into it will not display in that view, either - even if the inserted object’s layer is turned on. The exception to this rule is doors and windows, which can display in 3D views when their containing wall does not. See “Inserted Objects” on page 282.

In Plan View

All library objects except materials, doors and drawers applied to cabinets, and backdrops can display in plan view. Library objects are represented in plan view by 2D symbols that resemble the size and shape of the object when viewed from above.

As with other architectural objects, the display of library objects is controlled by layer in the **Display Options** dialog. Each library category has its own layer. See “Display Options Dialog” on page 74.

Like other objects, each library symbol is placed in a Drawing Group that affects whether it displays in front of or behind other objects. You can modify a selected symbol's place in the drawing order by clicking the **View Drawing Group Edit Tools**  edit button. See “Drawing Group Edit Tools” on page 76.

Object Labels

Free-standing library objects can display labels in plan view when the appropriate layer is set to display in the **Display Options** dialog. Fixture labels, for

example, are located on the “Fixtures, Labels” layer. See “Object Labels” on page 166.

You can specify a custom label for many library objects in its specification dialog. See “Symbol Object Specification Dialogs” on page 285.

In 3D Views

All library objects can display in 3D views.

By default, images rotate to face the camera in 3D views. For information about turning off image rotation, see “Image Specification Dialog” on page 328.

Editing Library Objects



Library objects can be customized to suit your design needs. There are three approaches to doing so:

- Select an object in the User Catalog, edit it using any of the options in its contextual menu, and your changes will be reflected when you next place this library object in a drawing.
- Place an object in a drawing and then edit it using the various edit tools available for it. This will not affect the original object still saved in the library.
- Place an object in a drawing, edit it using the available edit tools, and then add it back to the library for future use. This will not replace the original object still saved in the library. See “Add to Library” on page 279.

Library objects placed in a drawing can be selected individually or as a group, like other objects in Home Designer Suite. See “Selecting Objects” on page 79.

Once selected, a library object can be edited in a variety of ways using dimensions, the edit handles, the edit toolbar buttons and its specification dialog. See “Symbol Object Specification Dialogs” on page 285.

Native Objects vs Symbols

In Home Designer Suite, objects created using the program's standard tools, such as the **Door Tools**  and **Cabinet Tools** , are referred to as native objects.

On the other hand, objects placed from the library, such as fixtures and furnishings, are symbols. Symbols are typically more limited than native objects in how they can be edited.

In addition to the symbols available in the library, you can import additional symbols into the program from 3D **.obj**, **.3ds**, **.skp**, or **.dae** files. See “Importing 3D Symbols” on page 345.

Any changes made to objects like fixtures and furniture will not be reflected in their Materials List Description, although they may be seen in other columns, such as Size. See “Materials Lists” on page 377.

Using Edit Handles

Most free-standing library symbols are box-based objects and can be edited as such once placed in a drawing. See “Editing Box-Based Objects” on page 89. Depending on the type of view and the surface selected, the edit handles a symbol displays will vary.

When a typical symbol is selected in plan view or on the top surface in a 3D view, up to ten edit handles display. They are the Move handle at the center, the Rotate handle just outside the front indicator (a V) and a Resize handle on each edge and at each corner.

When a symbol is selected on a side in a 3D view, it displays six edit handles: the Move handle, a Rotate handle, and a Resize handle on each edge. See “Selected Side” on page 80.

When a free-standing symbol is selected on its side and rotated, you will be prompted to choose whether to update its plan view symbol to reflect its new orientation, as viewed from above. See “In Plan View” on page 283.

Fixtures and furniture placed in a plan are subject to bumping/pushing behavior when moved. See “Bumping/Pushing” on page 93.

In the Specification Dialog

The specification dialog for an individual symbol, image, or plant image in the User Catalog can be edited from the Library Browser Directory Pane. Right-click on the item and select **Open Object** from the contextual menu. See “Specification Dialogs” on page 25.

Individual or multiple group-selected materials can be edited by right-clicking and selecting **Open Object** as well. See “Define Material Dialog” on page 300.

Specification dialogs are not available for native objects saved in the library.

Deleting Built-in Fixtures and Appliances

A fixture installed into the front of a cabinet becomes a cabinet face item, like a door or drawer. It can be resized or deleted like other face items in the **Cabinet Specification** dialog. See “Front Panel” on page 207.

Symbol Object Specification Dialogs

The **Fixture**, **Furniture**, **Geometric Shape**, **Hardware**, and **Millwork Specification** dialogs all feature the same options. The actual name of the dialog is determined by the type of object that is currently selected.

For example, selecting a library object placed from the Interiors Core Catalog and clicking the **Open Object** edit button opens the **Furniture Specification** dialog.

General Panel

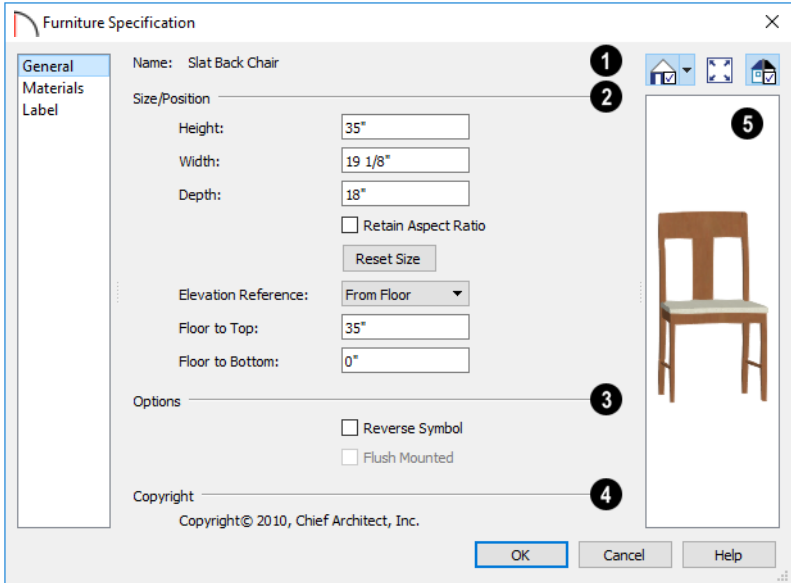

- 1 The **Name** of the selected symbol object displays here.
- 2 **Size/Position** -
 - Specify the **Width**, **Height**, and **Depth** of the object.
 - Check **Retain Aspect Ratio** to maintain the ratio between the object’s Height, Width, and Depth when it is resized in the specification dialog.
- Does not affect the behavior of the object’s edit handles.
- Click **Reset Size** to reset the symbol’s original, unmodified size. The symbol’s elevation is not affected by this option.
- Select the **Elevation Reference** from the drop-down list. This determines where the next two settings are measured from and also affects their setting labels.

- Specify the height **to Top**, measured from the selected Elevation Reference to the top of the object.
- Specify the height **to Bottom**, measured from the selected Elevation Reference to the bottom of the object.

3 Options -

Check **Reverse Symbol** to reverse the object's appearance, so that features on its left are positioned on its right, and vice versa. This turns a right-hand refrigerator, for example, into a left-hand refrigerator. This option has no effect on objects that are symmetrical.

- Check **Flush Mounted** to specify that the selected object follow the pitch of either the ceiling or roof. Only available when "From Ceiling" or "From Roof" is selected as the Elevation Reference, above.

4 If the selected object has a **Copyright**, information about it displays here.

5 A preview of the selected library object displays here and updates with changes. If the selected symbol is inserted into another object, such

as an appliance in a cabinet, the parent object will also display. See "Dialog Preview Panes" on page 25.

Materials Panel

The settings on the MATERIALS panel affect the appearance of the selected object in 3D views. See "Materials Panel" on page 296.

Label Panel

A variety of library objects can display labels in plan view. Labels use the Text Style assigned to the layer they are on.

For information about the settings on this tab, see "Label Panel" on page 166.

Manufacturer Panel

The MANUFACTURER panel provides contact information for the selected object's manufacturer. Only available for symbols from Manufacturer library catalogs. See "Manufacturer Catalogs" on page 276.

Architectural Blocks

A selection of pre-arranged rooms library catalogs is available for download. These pre-arranged rooms are a collection of fixtures, furnishings and accessories that are grouped together so that they can be placed and moved as a single object. See “Downloading Library Content” on page 277.

3D objects that are grouped together like this are referred to as Architectural Blocks. Although

blocked together, these objects retain many of their own attributes, such as materials.

Architectural blocks can also be exploded so that the individual sub-objects become independent of one another.

Displaying Architectural Blocks



As with individual objects, the display of architectural blocks is controlled in the **Display Options** dialog. See “Layer Attributes” on page 74.

Editing Architectural Blocks

Architectural blocks can be selected and edited in 2D and 3D views. See “Selecting Objects” on page 79

Once selected, an architectural block can be edited using its edit handles and edit toolbar buttons.

Using the Edit Handles

A selected architectural block displays a Move handle and a Rotate handle.

Architectural blocks cannot be resized, but the individual objects in the block can be.

Chapter Contents

- Displaying Architectural Blocks
- If an architectural block is composed of objects that are on the same layer, the block will be placed on that layer, as well.
- If an architectural block is composed of objects on different layers, the block will be placed on the “Architectural Blocks” layer.

Using the Edit Tools

A selected architectural block or blocks can be edited in a variety of ways using the buttons on the edit toolbar. See “The Edit Toolbar” on page 23.

Editing Sub-Objects

The individual objects included in an architectural block can also be selected and edited. See “To select a sub-object” on page 288.

Explode Architectural Block



You can break an architectural block to make its objects independent. Select the

architectural block and click the **Explode Architectural Block** edit button.

Note: If you open a plan created in another version of Home Designer and an architectural block includes an object that you cannot create in your version of the software, you cannot unblock it or edit its components.

Once exploded, an architectural block cannot be made into a single object again.



Architectural Blocks and Sub-Objects

An architectural block is composed of a group of sub-objects that have been blocked together. For example, a kitchen island architectural block may consist of cabinets, appliances, and other accessories.

Each of the sub-objects in an architectural block may contain additional parts called components. The cabinets in a kitchen island, for example, may contain handles, hinges, and drawer glide.



Sub-Objects

Certain attributes of an architectural block can be edited at the sub-object level. A sub-object can be edited by accessing its specification dialog in either of two ways:

- Explode the architectural block, select the sub-object, and click the **Open Object**  edit button.
- Select the sub-object while it is part of the architectural block and click the **Open Object**  edit

button. Some attributes may not be editable while the object is part of a block. See “Editing Architectural Blocks” on page 287.

To select a sub-object

1. Click the **Select Objects**  button, then click on the sub-object that you would like to edit.
2. With the architectural block selected, click the **Select Next Object**  edit button or press the Tab key.

The selection switches to the individual object and it can be edited using its edit handles, edit toolbar and specification dialog.

The options for editing a sub-object may be more restricted than if the object were independent. If more extensive editing is required, the architectural block must be exploded.

Other Objects

Home Designer Suite has additional objects that can be used to customize your design.

General Shapes



Items in the Home Designer Core Catalogs> Shapes library catalog allow you to create a variety of custom objects using basic geometric shapes. These shapes can be used individually or combined to create a wide variety of custom objects.

Soffits



Soffits typically fill the space between the tops of wall cabinets and the ceiling, but they are very versatile and can be used to create almost any other object that can be modeled as a 3D box. Select **Build> Cabinet> Soffit** to activate this tool.

Soffit Defaults



The default settings for soffits are set in the **Soffit Defaults** dialog. The settings in this dialog are similar to those in the **Soffit Specification** dialog. See “Soffit Specification Dialog” on page 291.

When a soffit is created, it is placed on the “Cabinets, Soffits” layer. See “Layer Attributes” on page 74.

For best results when placing soffits above wall cabinets:

Chapter Contents

- General Shapes
- Soffits
- Special Applications for Soffits
- Soffit Specification Dialog

General Shape objects are placed and edited much like other library objects. See “Editing Box-Based Objects” on page 89.

- The default soffit should be the same width as and 1" (20mm) deeper than the default wall cabinet. See “Cabinet Defaults” on page 199.
- The default soffit **Floor to Bottom** value should equal the sum of the default wall cabinet’s Floor to Bottom value plus its Height. See “General Panel” on page 291.
- The default soffit **Height** should be equal to or greater than the space between the ceiling and the top of the wall cabinets.

If the sum of the default soffit’s Floor to Bottom value and Height is larger than the ceiling height of the room in which a soffit is placed, the Floor to Bottom value will be retained and its Height will be adjusted so that it fits under the ceiling.

The maximum soffit width is 250 feet (48m), and the minimum width is 1/16" (1 mm).

Once a soffit is placed in a plan, you can change its size and position to meet a variety of needs.

Placing Soffits

Soffits can be created in both 2D and 3D views by simply clicking with the **Soffit**  tool active. See “Click-to-Create” on page 69.

To create a corner soffit, click as close to an inside wall corner as possible. A corner soffit retains its shape when it is moved, edited, or copied.

Special Applications for Soffits

Nearly any object with straight, flat sides can be represented by one or more Soffits. They can be resized to as small as 1/16" (1mm) per side, or as large as 250 feet (48m).

Soffits can have materials applied to them to represent simple mirrors, posts, chimneys and so on. Following are some additional examples.

Coffered Ceilings

Soffits can be used to create coffered ceilings. They will display any moldings assigned to the room it is in that are at its height.



Accent Tiles

A material such as ceramic tile can be assigned to one or more soffits applied to the walls above tubs or in showers.

When positioned against a wall in a room, soffits will automatically display any moldings present in that room that are at the same height as the soffit. Soffits can also have custom molding profiles assigned to them. See “Moldings Panel” on page 144.

When positioned against the ceiling in a room, a soffit will prevent the Ceiling Finish layers directly above it from generating in 3D. See “Lowered Ceilings” on page 139.



Masonry Veneer

You can use a soffit to create a brick or stone veneer over part of a wall. Specify a soffit depth equal to the masonry material to be used.

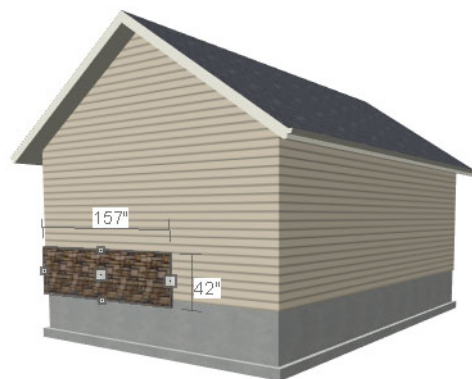

Soffits automatically stop at the floor platform when moved downward or at the ceiling platform when moved upward - even when the soffit is not located in a room. To move or resize a soffit through a floor

or ceiling platform, select it and hold the Ctrl key down while dragging its edit handles. See “Unrestricted Movement” on page 93.

Calculating Materials on Soffits

By default, soffit materials are not calculated in the Materials List. In order for a soffit’s material to be counted, it must be edited so that it is not using the default material. See “Material Defaults” on page 294.

The number of bricks, tiles, shingles, shakes or other materials applied to a soffit is calculated using the following rules:

- If the soffit depth is less than the larger of 4 inches (10 mm) or 1 ½ times the material thickness, then only the front area of the soffit is used. Thus if a soffit is 48"x48"x4" thick, and the Dark Red brick material is used (3"x 8" with 3/8" mortar joint) the front of the soffit is 48"x48"=2304 square inches. Including the mortar joint, each brick requires $3 \frac{3}{8} \times 8 \frac{3}{8} = 28.26$ square inches. 2304 sq. in. divided by 28.26 sq. in. per brick gives 81.5 bricks.
- If the soffit depth is greater than both 4 inches (10 mm) and 1 ½ times the material thickness, then the surface areas of the soffit back, sides and top are used in addition to the front, if these surfaces are not attached to a wall or other soffit. However, only those portions of the sides, top and bottom remaining after subtracting twice the material thickness are used. So, for Dark Red brick, which has a depth of 4", the sides, top and bottom surface areas cannot contribute to the brick count unless the soffit depth is greater than 8 inches.
- If surface materials such as brick are applied to a large soffit, the soffit center is assumed to be hollow, with only a single layer of the material applied to each applicable face.
- For shingles and shakes, the overlap amount should be subtracted from the height, as opposed to brick or tile, where the joint width is added to the size.
- For materials in the area category, the soffit area calculation above is used, with the material thickness treated as zero.
- For materials in the volume, concrete or earth categories, the true volume of the soffit is used.

Soffit Specification Dialog



To open the **Soffit Specification** dialog, select the soffit and click the **Open Object** edit

button or double-click on a soffit using the **Soffit**  tool.

The settings in this dialog are similar to those in the **Soffit Defaults** dialog, but affect only the selected object(s).

General Panel

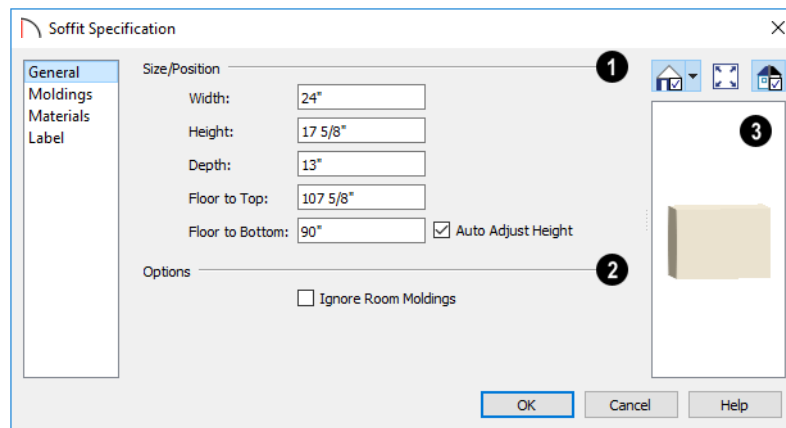

- 1 Define the **Size** and **Position** of the selected soffit relative to the floor or terrain.
 - Specify the **Width** of the soffit.
 - Define the vertical **Height** of the soffit.
 - Define the **Depth**, which is the distance between the front and the back of the soffit. When selected

in plan view, the front of a soffit has a “V,” and the back of the soffit has a triangular rotation handle.

- If the selected soffit is a corner soffit, the **Width** controls its left side width, and **Depth** controls its right side width.
- Specify the distance from **Floor to Top** of the soffit.
- Specify the distance from **Floor to Bottom** of the soffit.
- When the selected soffit is outside a room, its Floor to Bottom height is measured relative to the terrain. Check **Auto Adjust Height** to maintain the same distance above the terrain if the soffit is moved to a location with different terrain height. Uncheck this to maintain the same absolute height regardless of the terrain below. When **Auto Adjust Height** is checked, the Floor to Bottom value may automatically adjust if the soffit is moved.

2 Check **Ignore Room Moldings** to prevent the selected soffit from displaying moldings assigned to the room that it is placed in. See “Special Applications for Soffits” on page 290.

3 A preview of the soffit displays on the right side of the dialog box. See “Dialog Preview Panes” on page 25.

Moldings Panel

The settings on the **MOLDINGS** panel allow you to assign one or more horizontal moldings around the selected soffit.

For information about the settings on this panel, see “Moldings Panel” on page 268.

Materials Panel

Soffits are not calculated in the Materials List unless a non-default material is specified. See “Calculating Materials on Soffits” on page 291.

For information about the settings on this panel, see “Materials Panel” on page 296.

Label Panel

Soffit labels display in plan view when the “Cabinets, Labels” layer is turned on and use the Text Style assigned to that layer. The Automatic Label for Soffits is blank, but you can specify a custom label.

For more information about the settings on this panel, see “Label Panel” on page 166.

Materials

The objects used in Home Designer Suite have a variety of 3D properties. These objects - walls, windows, doors, cabinets, roof planes, lot perimeters, etc. - can have materials assigned to them so that they look realistic in 3D views. These materials can also be used to generate materials lists that can help with cost estimations.

Designing with objects that look correct in 3D and calculate properly in the Materials List requires that you use realistic material definitions and apply them appropriately to objects in your plan.

Home Designer Suite comes with many materials that are ready for use. From siding, roofing, flooring, masonry, tile, and paneling, to grass, water, and wood materials, Home Designer Suite has materials for every application, inside and out. If you cannot find a material that suits your needs, you can customize the materials provided or create your own.

Chapter Contents

- About Materials
- Material Defaults
- Material Painter Tools
- Materials Panel
- Select Material Dialog
- Editing Materials
- Creating Materials
- Define Material Dialog

 Redefining only the visual properties of a material may create unexpected results. For example, changing the image of a brick material to represent siding does not cause the material to be considered as siding during material calculations.

About Materials

The materials that are assigned to objects in Home Designer Suite perform two important roles:

- They determine what the surfaces of objects look like in 3D views.
- They influence how objects are calculated in the Materials List. See “Materials Lists” on page 377.

Materials are stored in the Library Browser and can be applied to objects in either of two ways:

- Using the **Material Painter** .
- In an object’s specification dialog. See “Materials Panel” on page 296.

Material Defaults



Most objects in the program have defaults dialogs which allow you to set up a variety of attributes, including materials, before the objects are created. These defaults dialogs are accessed by selecting **Edit> Default Settings**. See “Preferences and Default Settings” on page 47.

The **Material Defaults** dialog serves two purposes. It allows you to:

- Set the default materials for objects that do not have a defaults dialog: for example, fireplaces and furnishings from the library.
- Set the initial materials that can then populate a variety of defaults dialogs. **Door, Window, and Cabinet Defaults** are examples of defaults dialogs that can draw their material assignments from the **Material Defaults** dialog.

Material defaults are dynamic, which means that if you change a particular default material, all objects that are set to use that default will automatically update to use the new material. See “Dynamic Defaults” on page 48.

Because material defaults are dynamic, you can use the **Material Defaults** dialog to apply a material to multiple objects that share similar components. For example:

- The “Room Moldings” Material Default applies to the base, crown, and chair rail moldings that can be assigned to rooms, as well as to interior door and window casing. If you change this Mate-

Textures

In Home Designer Suite, materials have textures associated with them that determine how they look in 3D views.

Textures are created using special image files that tile seamlessly when applied to surfaces.

In 3D views, you can turn the display of textures on and off by selecting **3D> Render View Options>**

Toggle Textures . When textures are turned off, materials are represented using solid colors.

rial Default, all of these objects in the plan can be affected.

- The “Cabinet”, “Cabinet Door/Drawer”, “Countertop”, and “Hardware” Material Defaults can be used in your **Cabinet Defaults** dialogs to ensure that all cabinets use the same materials.

Material Defaults Dialog

Select **Edit> Default Settings**  from the menu, select “Materials”, and click the **Edit** button to open the **Material Defaults** dialog.

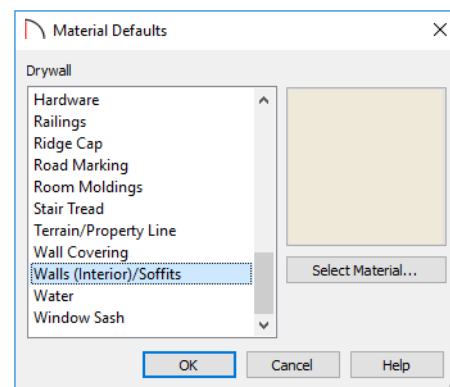

- Select a material category from the scrollable list. Select multiple line items using the Shift or Ctrl key. See “Shift and Ctrl Select” on page 81.
- Click the **Select Material** button or material preview box to open the **Select Material** dialog. See “Select Material Dialog” on page 297.

Material Painter Tools

 In a 3D view, select **3D> Material Painter** to access the **Material Painter Tools**, which are used to apply materials to object surfaces.

The Material Painter tools are not available in Glass House views. See “Glass House” on page 323.

Material Painter

 The **Material Painter** tool allows you to apply a selected material to other objects in 3D views. It can be activated in several ways:







- Select **3D> Material Painter> Material Painter** .
- Select a material in the Library Browser while a 3D view is active.
- The Material Painter also becomes active when the Material Eyedropper is used.



The **Material Painter**  is similar to the other Painter tools but has some additional considerations. See “Painter Tools” on page 97.

To use the Material Painter tool

1. In a 3D view, select **3D> Material Painter> Material Painter** .
2. Choose a material from the **Select Material** dialog. See “Select Material Dialog” on page 297.
 - Check **Use Default Material** at the bottom left of the dialog to apply the default material to any object that has a defaults dialog. See “Material Defaults” on page 294.
3. Select one of the **Material Painter Modes** from the edit toolbar.



4. If you selected a solid color material, choose whether to use the **Blend Colors with Materials**  option and click the edit button to turn this feature on or off.
 - The mouse pointer displays a paint roller icon  when **Blend Colors With Textures**  is active.
 - The mouse pointer displays a spray can icon  when the **Material Painter**  is active and **Blend Colors With Textures**  is not.

5. Note that the name of the material being painted displays on the left side of the Status Bar at the bottom of the program window. See “The Status Bar” on page 26.
 - Move your pointer over a surface in the 3D view. The Status Bar now states both the material being painted and the current material on the target surface.
6. Click on a surface to apply the selected material to that surface. The material is applied to surfaces in the model based on the active Material Painter Mode.
7. If either the **Component**  or **Object Mode**  is active, you can continue to click on surfaces to apply the selected material. When you are finished, select a different tool.

Material Eyedropper

 The **Material Eyedropper** tool allows you to load the material assigned to an existing object into the Material Painter and apply that material to other objects and is similar to other Eyedropper tools. See “Eyedropper Tools” on page 97.

Blend Colors With Materials

 The **Blend Colors With Materials** option allows you to apply a solid color to a surface displaying a texture and blend the two.





Blend Colors With Materials  works in all five Material Painter Modes. See “Blending Materials” on page 299.

Material Painter Modes

There are five Material Painter Modes, each specifying how broadly or narrowly the selected material will be applied to surfaces in your plan. They are similar to other Painter Modes in the program, but rather than modify instances of an object type, the Material Painter Modes replace instances of a material based on the selected scope. See “Painter Modes” on page 98.





- **Material Painter Component Mode**  is unique to the Material Painter Tools. It is the default mode and applies the selected material to a single component on the target object. For most object types, using this tool is the same as

opening an object’s specification dialog and changing the material of one of its components on the MATERIALS panel. See “Materials Panel” on page 296.

- **Material Painter Object Mode**  replaces all instances of a material on the target object.
- **Material Painter Room Mode**  replaces all instances of a material in the current room.
- **Material Painter Floor Mode**  replaces all instances of a material on the current floor.
- **Material Painter Plan Mode**  replaces all instances of a material in the entire plan.

Material Painter and Walls

Painting walls is an obvious use for the **Material Painter** ; however, it is important to note that the Material Painter Modes affect walls and rooms somewhat differently than they do other objects: particularly if a wall defines multiple rooms on the side that is being painted.

- **Component**  and **Object Modes**  only paint the section of the wall that defines the room located where you click to apply a new material. Sections of the same wall that define other rooms are unaffected.
- **Room Mode**  applies the material to all walls and solid railings that define the room where you click provided that they have the same original surface material as the one being painted. Any other objects in the room with that original material are also affected, but railings are not unless they are specified as Solid.
- **Floor**  and **Plan Modes**  apply the material to all walls, all railings, and any other objects with the same original surface material as the one being painted: either on the current floor, or throughout the plan.

Note: Wall materials applied using the Material Painter tool are not calculated in the Materials List. See “In the Materials List” on page 118.

Materials Panel

The specification dialogs for most objects include a MATERIALS panel. Select an object and click the

Open Object  edit button to open the specification dialog for that selection.

On the MATERIALS panel, you can specify material assignments for the components that make up that object. When a new material is assigned, the

appearance of the preview image on the right side of the dialog updates.

If the selected object is using a material that is missing its texture, a Caution  symbol will display next to the Materials panel name in the list on the left side of the object’s specification dialog. See “Referenced Files” on page 39.

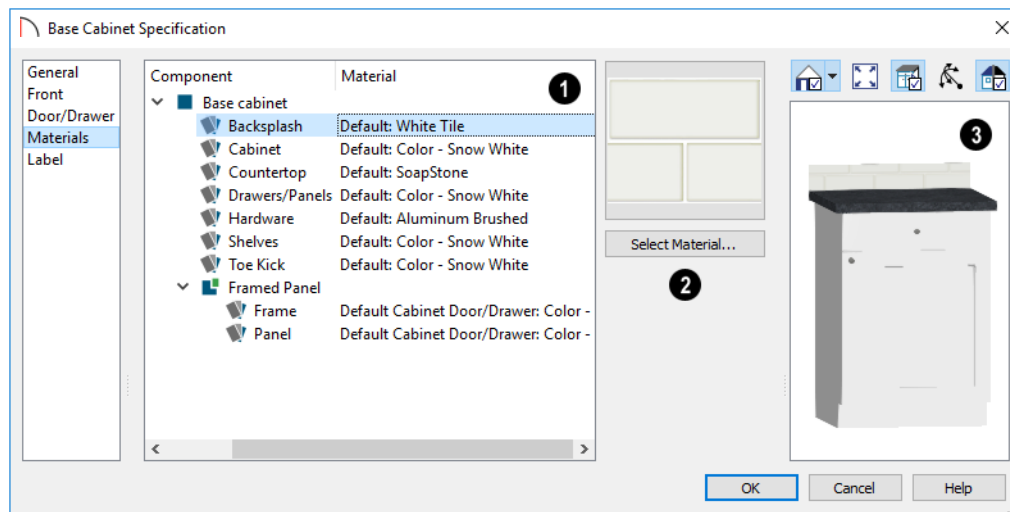

1 The table on the left side of the panel lists the components of the selected object that can be assigned unique materials, along with the names of those materials and whether or not the default materials are used. Some objects may have only one component while more complex objects may have many. As changes are made to the selected object, components may be added to or removed from this table.

- Click on a Component in the table to select it. Multiple line items can be added to the selection set by holding down the Shift or Ctrl key. See “Shift and Ctrl Select” on page 81.
- The selected component’s Material is stated in the list, to the right of the component name. If the component is using the default material, the name will be preceded by the word “Default:”. If it is using a Material Default, it will be preceded by the word “Default” followed by the name of an object type. See “Material Defaults” on page 294.

Note: If the selected object is a wall or a room modified using the Material Painter, a component’s Material may be described as “No Change”. See “Material Painter and Walls” on page 296.

2 The box to the right of the table displays a preview of the material assigned to the selected component. If “No Texture” displays in the preview window, the material has no texture assigned to it; if

a Caution  symbol and the words, “Texture Missing” display, the texture file could not be found on the system.

- Click **Select Material** to open the **Select Material** dialog. Choose a material and click **OK** to assign that material to the selected component. See “Select Material Dialog” on page 297.

3 A preview of the selected object displays on the right side of the panel. To view material textures, select **Standard** as the View Type. See “Dialog Preview Panes” on page 25.

Select Material Dialog

The **Select Material** dialog allows you to select a material to apply to one or more objects and is opened by clicking the **Select Material** button on the MATERIALS panel of most specification dialogs or by using the **Material Painter** . See “Materials

Panel” on page 296 and “Material Painter Tools” on page 295.

Most of the time, the **Select Material** dialog has a single panel; however, if a component of a library symbol is selected in an object specification dialog, two panels will be present.

Library Materials Panel

The LIBRARY MATERIALS panel is a modal version of the Library Browser that lists only materials. See “The Library Browser” on page 271.

Most of the settings on this panel are also found in the **Select Library Object** dialog. See “Select Library Object Dialog” on page 283.

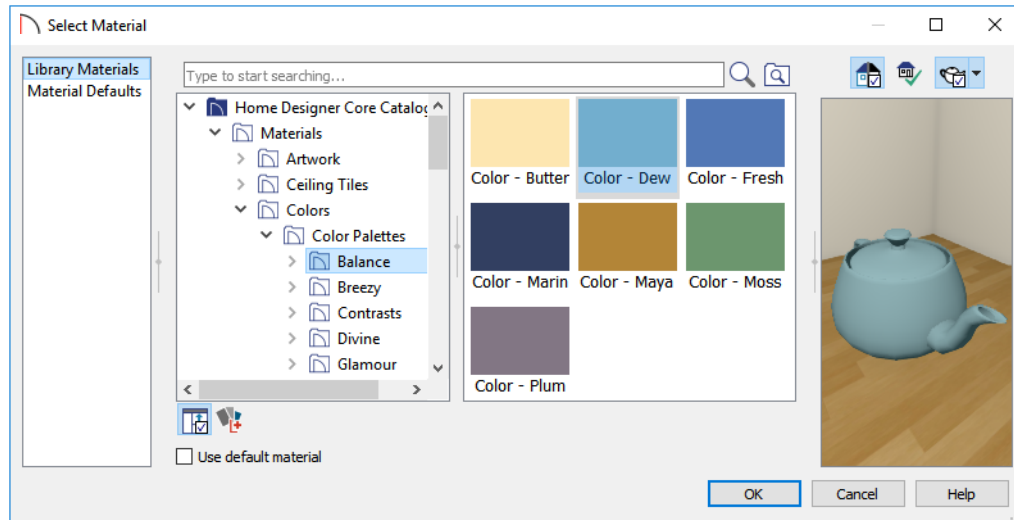

The **LIBRARY MATERIALS** panel has most of the functionality that the Library Browser has, including the search and preview options.

- To locate a material, either search using keywords or browse the tree list. See “Searching the Library” on page 274.
- To apply a material to an object, either click on the material and click **OK** or double-click on the item in the Selection Pane.
- Click the **Add New Material**  button to open the **Define Material** dialog and create a new material saved in the user Catalog. See “Define Material Dialog” on page 300.
- Check **Use default material** to apply the default material to the selected object, if one exists. See “Material Defaults” on page 294.

Editing Materials

Much like objects, materials in Home Designer Suite can be edited so that they better suit your design needs. There are two approaches to material editing:

- Select a material in an unlocked library in the Library Browser, edit it, and your changes will be used when you next use the material in any plan. Changes made in this manner do not affect materials already in use in a plan.
- Apply a material to an object in a plan and then edit that applied material using the **Adjust Material Definition**  tool. Changes made in this

- A preview of the selected material displays on the right. See “Dialog Preview Panes” on page 25.

The **OK** button is only active when a library item is selected. If a library folder or catalog is selected, the **OK** button cannot be clicked.

Material Defaults Panel

The **MATERIAL DEFAULTS** panel will only be present if the **Select Material** dialog was accessed via an object specification dialog where a component of an inserted library symbol was selected.

Rather than apply a specific material to the selected component, you can dynamically associate it with a Material Default category. See “Material Defaults” on page 294.

way will affect any instances of that material in the current plan only.

Editing the material applied to an object is not the same as applying a different material to that object. See “Material Painter Tools” on page 295.

Library Browser

Right-click on a material in an unlocked library and select **Open Object**  from the contextual menu to open the **Define Material** dialog for that material. See “Define Material Dialog” on page 300.

Adjust Material Definition



The **Adjust Material Definition** tool is useful for changing plan materials directly from a 3D view.

Select **3D> Materials> Adjust Material Definition**



and then click any surface in a 3D view to modify the material currently assigned to that surface

in the **Define Material** dialog. See “Define Material Dialog” on page 300.

Changing a material definition with this tool affects all objects in the current plan that are using that material but does not affect any materials saved in the library or materials used in other plans. See “Adding Library Content” on page 279.

Creating Materials

Home Designer Suite provides a wide variety of materials - including numerous name brand material catalogs - that are ready to download and use. If you cannot find a suitable material, you can edit an existing material or create a new one. See “Editing Materials” on page 298.

Note: Adding a material to a plan is not the same as adding it to the library. If you want a new material to be available for use in other plans, create it in the Library Browser.

In the Library Browser

Materials can be created in the Library Browser, making them available for use in any plan. See “Adding Library Content” on page 279.

In the directory pane of the Library Browser, right-click on an unlocked folder and select **New>**

Material  from the contextual menu. See “Using the Contextual Menus” on page 273.

The **Define Material** dialog opens, allowing you to specify the new material’s attributes. See “Define Material Dialog” on page 300.

Blending Materials



In 3D views, you can create a new material by blending a solid color such as a paint color with a textured material. Select **3D> Material Painter> Blend Colors With Materials** to toggle this feature on or off. See “Blend Colors With Materials” on page 295.

The result is a new material that is saved in the current plan.

Materials created using the **Blend Colors With Materials**  tool are given the name of the patterned/textured material with the extension “--

PAINTED:” followed by the name of the solid color material.

Component	Material
Base cabinet	
Backsplash	Default: White Tile
Cabinet	Rustic Hickory--PAINTED: Color - Chocolate

Texture File Management

In order to display a material’s texture, Home Designer Suite needs to be able to locate the image file associated with it on your computer. See “Referenced Files” on page 39.

If a texture referenced by a newly created material is not located in either the Home Designer Suite 2021 Data folder or the installation folder for the program’s library textures, a copy of the file will be made in Home Designer Suite 2021 Data\Textures\Material Data and the material will reference that copy. See “Home Designer Suite Data” on page 32.

Stretch to Fit

Some special textures, often used for artwork, stretch across any surfaces that they are applied to. Materials that behave this way are specified as **Stretch to Fit** in the **Define Material** dialog.



To display an artwork texture, first place a wall or desk frame in your plan. A selection of both are available in the library. See “Placing Library Objects” on page 281.

Next, simply apply a material specified as **Stretch to Fit** to the center portion of the frame. See “Material Painter Tools” on page 295.

For more information about creating and using custom materials, see “Materials Tutorial” on page 91 of the User’s Guide.

Define Material Dialog

The **Define Material** dialog allows you to adjust how materials look in 3D views and can be accessed in a number of ways:

- Use the **Adjust Material Definition**  tool. See “Adjust Material Definition” on page 299.
- Right-click on material in the Library Browser User Catalog and select **Open Object**  from the contextual menu. See “Using the Contextual Menus” on page 273.
- You can also right-click on the User Catalog and select **New> Material**.

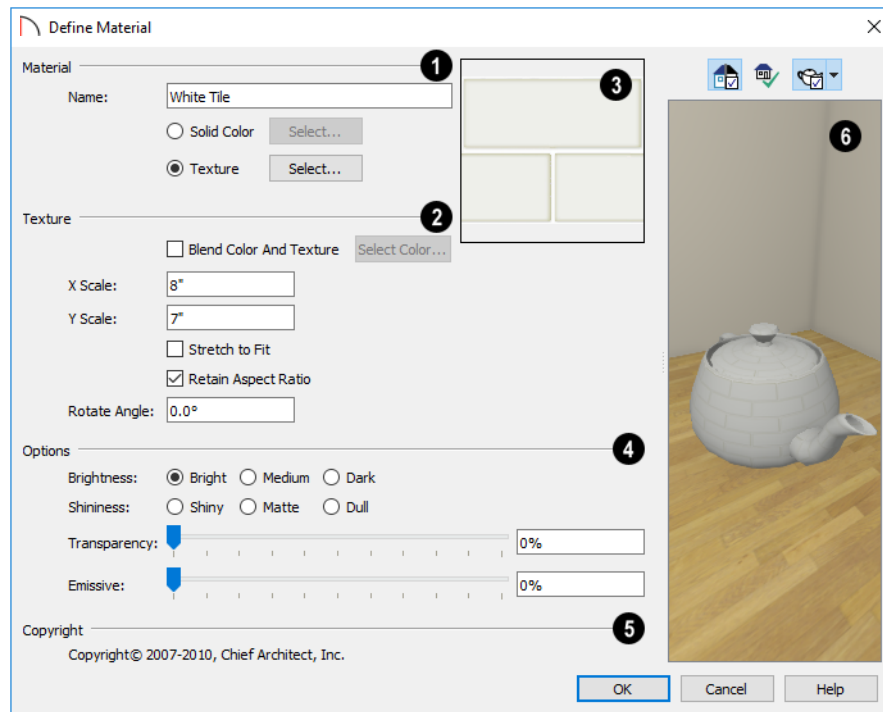

1 The **Material Name** displays here. In this field, you can type a new name if you wish. Renaming the material does not create a new material: it redefines the existing material in the current plan.

- Click the **Solid Color** radio button to specify the material as a solid color, then click the **Select** button to open the **Select Color** dialog and select a new color. See “Select Color Dialog” on page 77.
- Click the **Texture** radio button to specify a texture for the material instead of a solid color, then click the **Select** button to open the **Select Texture File** dialog, a standard Open File dialog, and specify an image saved on your computer to serve as the texture.

2 The **Texture Options** are only enabled when Texture is selected, above.

- Check **Blend Color and Texture** to blend the selected texture with a solid color, then click the

Select Color button to specify the color you would like to blend it with. When a new material is created using the **Blends Color With Materials**  tool, the resulting material has this box checked. See “Blend Colors With Materials” on page 295.

- Specify the **X** and **Y Scale** for the chosen texture in inches (mm). If you specify **x** and **y** values of 30”, the pattern repeats every 30 inches in both directions along a surface.
- Check **Stretch to Fit** to stretch the texture image over the entirety of each surface it is applied to. This is useful when you wish to create a painting or photo material to display in a frame. See “Stretch to Fit” on page 299.

Note: Changing the scale or selecting Stretch to Fit can cause textures to appear distorted if they are mapped to a surface using a different aspect ratio than they were originally created with.

- Check **Retain Aspect Ratio** to maintain the ratio between the texture image's height and width and prevent distortion when either its X or Y Scale value is adjusted.
- **Rotate Angle** - Specify how the texture is rotated on the surface it is applied to.

3 General Options -

- **Brightness** controls how bright the material appears relative to other materials.
- **Shininess** controls the sheen of the material when it is rendered with a point or spot light source on it. Shiny materials such as metal will reflect light when viewed at the right angle.
- **Transparency** controls the opacity of the material. A transparency value of 0 results in a completely opaque material, while a value of 100 creates a material that is completely invisible.
- Use the **Emissive** slider bar or text field to control how bright a material appears independent of the lighting in the scene. It can be used to simulate surfaces that are glowing with their own light, such as the glass on a light fixture.

4 Any **Copyright** information about the material displays here.

5 A preview of the selected texture or color displays in the square pane.

6 A preview of the material applied to an object displays here and updates as changes are made to the material definition. Various options allow you to view different aspects of the material's attributes:

- Zoom and orbit the object in the view.
- Toggle **Color** on or off.
- Select an object shape: Cube, Sphere, Teapot, or Plane.

Manufacturer Panel

If the selected material is from a Manufacturer library catalog, the Define Material dialog will have a second panel: the MANUFACTURER panel, which lists contact information. See "Manufacturer Catalogs" on page 276.

3D Views

Little preparation is needed to create a 3D view of a model: simply click a button to create an overview or click and drag to create a camera or elevation view.

To improve the quality of the rendering and create a custom look, you can adjust lighting and edit the materials used in the plan. You can create Final views that are even more realistic. See “3D Rendering” on page 319.

Many objects can be placed and edited in 3D views, and any camera view or overview can be saved or even used to record a walkthrough. See “Pictures, Images, and Walkthroughs” on page 325.

OpenGL and Hardware

Home Designer Suite features an easy to use rendering engine that makes use of OpenGL rendering technology, which has good hardware support on most video cards.

- ### Chapter Contents
- OpenGL and Hardware
 - Camera Defaults Dialogs
 - 3D View Tools
 - Creating Camera Views
 - Creating Overviews
 - Elevation Views
 - Displaying 3D Views
 - Repositioning Cameras
 - Editing 3D Views
 - Cross Section Slider
 - Working in 3D
 - Saving and Printing 3D Views
 - Camera Specification Dialog
 - Elevation Camera Specification Dialog

To take full advantage of these rendering capabilities of Home Designer Suite, a graphics card or chipset that supports OpenGL 3.3 on Windows or 4.1 on Mac is required. For more information, visit HomeDesignerSoftware.com.

Camera Defaults Dialogs



There are several defaults dialogs for cameras, which can be accessed by selecting **Edit> Default Settings**. In the **Default Settings** dialog, click the arrow next to “Camera tools”, then select a subheading and click the Edit button to open the defaults dialog associated with your selection.

The settings in the **Camera Defaults** dialogs control the initial use of effects that improve the appearance of 3D views.

The settings in these defaults dialogs are also found in the **Camera Specification** dialog. See “Camera Specification Dialog” on page 315.

Once a camera is created, its attributes can be customized. See “Editing 3D Views” on page 311.

Full Camera Defaults

Specify the initial attributes of cameras created using the **Full Camera**  tool. See “Camera Views” on page 304.

The settings in this dialog also affect **Glass House Cameras** .

The settings in this dialog are the same as those the **Full Camera Specification** dialog.

Note: The Reflections setting in the Full Camera Defaults is used by walkthroughs created using the Walkthrough Path tool. See “Recording a Walkthrough” on page 337.

Perspective Full Overview Defaults

Specify the initial attributes of cameras created using the **Perspective Floor Overview**  tool. See “Full Overview” on page 305.

The settings in this dialog also affect **Perspective Framing Overviews** .

The settings in this dialog are the same as those in the **Perspective Full** and **Framing Overview Specification** dialogs.

Doll House View Defaults

Specify the initial attributes of cameras created using the **Doll House View**  tool. See “Doll House View” on page 306.

The settings in this dialog are the same as those in the **Doll House View Specification** dialog.

Elevation Defaults

Specify the initial attributes of cameras created using the **Elevation**  tool. See “Elevation Views” on page 304.

Although Elevation views do not have a specification dialog, the settings in this dialog can be found in the **Camera Specification** dialog. See “Camera Specification Dialog” on page 315.

3D View Tools

Select **3D> Create Camera View** to display the Camera View Tools.

Camera Views

 The **Full Camera** tool creates multi-floor views of the 3D model. It can be used to create interior and exterior perspectives, and is good for displaying cathedral ceilings, roofs, lofts, stairwell openings, and other variation in floor and ceiling levels.

 The **Glass House Camera** tool creates full camera view of the 3D model using the Glass House Rendering Technique. See “Glass House” on page 323.

Overviews

 The **Full Overview** tool creates views of the entire model including all floors, ceilings, and the roof.

 The **Doll House View** tool creates views of the current floor with the ceiling removed and all floors beneath it visible.

 The **Framing Overview** tool creates views of the framing in the model. See “Framing Overview” on page 306.

Elevation Views

 The **Wall Elevation** tool creates views similar to the traditional, orthographic views often used in drafting. See “Elevation Views” on page 306.

- When an interior view is created, an elevation of a wall on a single floor and in a single room is shown.

- When an exterior view is created, the entire model is shown.

Creating Camera Views

All Camera views are created using the same method.

To create a camera view

1. In plan view, select the desired camera tool. The mouse pointer displays the camera icon.
2. Click and drag a line to define the view direction.
 - Where your line begins is the camera's position.
 - The line that you drag defines the direction the camera is pointed.
 - The end of the line is the focal point of the view, the point the camera rotates around.
 - By default, the field of view is 55°.

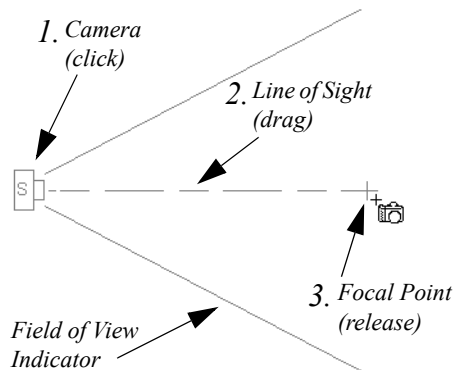

3. When you release the mouse button, a view generates in a new window.
4. Return to the plan view. A camera symbol now displays in plan view. See “Working in Multiple Views” on page 61.

Camera Height

By default, Cameras are created at a height of 60” (1500 mm). Where this height is measured from depends on the location of the camera:

- If the camera is inside of a room, it is measured from that room's subfloor.
- If the camera is outside of a room but inside of the Terrain Perimeter, it is measured from the terrain at the location of the camera.
- If the camera is located in neither a room nor within the Terrain Perimeter, it is measured from the default height of the subfloor for the current floor.

Once created, a camera's height can be modified in its **Camera Specification** dialog See “Camera Specification Dialog” on page 315.

Creating Overviews

Overviews generate as soon as you select the tool and are always created at the same angle. The focal point is always located at the center of the model; however, the position of the camera will vary depending on the size of the 3D model. The larger or more spread out the model, the further away the camera will be from the focal point so that the entire model can be seen in the view.

Once generated, an overview window's title bar indicates its view type and a camera symbol representing the overview displays in plan view. The overview 'camera' can be edited much like regular camera views can. See “Editing 3D Views” on page 311.

Full Overview

- Select **3D > Create Camera View > Perspective Full Overview** to generate an exterior view of the entire model.





Doll House View

 Select **3D> Create Camera View> Doll House View** to create a view of the current floor with the ceiling removed and all floors beneath it visible.

Doll House Views are an effective tool for illustrating traffic flow and the relationships between spaces.





To see a different floor, select **Tools> Floor/Reference Display> Up One Floor**  or **Down One Floor** . You can also return to plan view and

Elevation Views

 The **Elevation** tool produces views in which all lines and dimensions are their true lengths, regardless of their distance from the camera.

When an Elevation camera is created inside of a room, it is referred to as a Wall Elevation and shows a single wall defining that room, along with any objects in the room that are located between that wall and the camera. The camera does not cut through walls or show the ceiling, floor, or roof and any adjacent rooms are not shown.

To create an elevation view

1. Select the **Elevation**  tool. The pointer changes to a  with crosshairs marking the position of the pointer.
 - Click in the building's interior to create an elevation of a wall on a single floor and in a single room.
 - Click outside of the building to create a view of the entire model.
2. Click and drag a line in plan view.
 - A Camera symbol displays where you click.

make another floor current before generating the Doll House View.

Framing Overview

 Select **3D> Create Camera View> Framing Overview** to create a view of the entire model, displaying only framing and the foundation.

Select **3D> Create Camera View> Framing Overview** to create a view of the entire model, displaying only framing and the foundation.

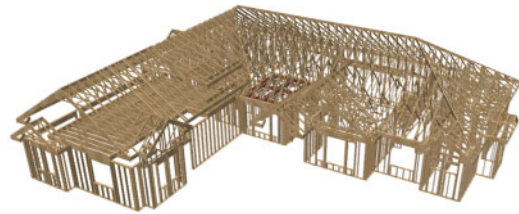

Framing overviews include all floor, wall, and roof framing as well as foundations.

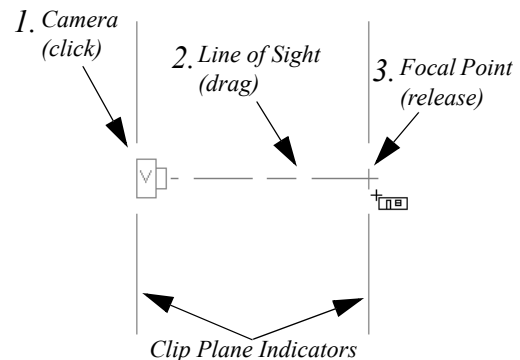

3. Drag in the direction of the Line of Sight to draw a camera arrow.
 - Always drag the camera arrow perpendicular to the wall to be viewed.
4. When you release the mouse button, the view generates in a new window.

If the Line of Sight does not cut through a 3D object, such as a window shown in elevation, the object retains its 3D definition and can be selected, moved, stretched, or otherwise modified in the view. The 3D model is updated in all views.

Displaying 3D Views

A variety of tools and settings allow you to control the appearance of 3D views. There are also numerous ways to adjust a 3D view's position, focal point and field of view. See "Editing 3D Views" on page 311.

The name of the current plan file and the type of view displays at the top of each view window in its title bar.

There is no limit to the number of 3D view windows that you can have open at a given time; bear in mind, though, that each window demands use of your computer's resources and that you may see poor performance if too many views are open. See "Working in Multiple Views" on page 61.

Display Options



Which objects display in a 3D view is controlled in the **Display Options** dialog. See "Display Options Dialog" on page 74.



Different view types use different layer sets when they are created. See "Layer Sets" on page 75.

In Plan View

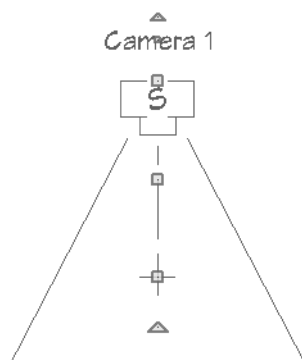
Cameras are represented in plan view by symbols that indicate the camera's position, field of view and focal point.



The symbols for Elevation views and Full Overviews display on all floors, while those for Full Cameras and Doll House Views display only on the floor where the view was created. See "Creating Camera Views" on page 305.

You can move a camera to a different floor by clicking the **Up One Floor**  or **Down One Floor**  button while the camera view is active. Note that this may affect what is seen in the view as well as its



display in plan view. See "Floor Up / Floor Down" on page 230.

Active cameras can have labels indicating the camera number. Camera labels are located on the "Cameras, Labels" layer. They are numbered sequentially in each plan in the order they were created.

Camera symbols are an on-screen reference: they do not print unless **Print Image** is used.

In Rendered Views

There are a number of factors that contribute to the appearance of rendered 3D views:

- Select **3D> Toggle Textures**  in a 3D view to turn off the display of material textures. See "About Materials" on page 294. Not available in Glass House Views.
- Select **View> Color**  to toggle between color and grayscale in 3D views. See "Color On/Off" on page 76.
- Select **3D> Lighting> Toggle Sunlight** to turn on and off the light source that represents the sun. This feature can be used to simulate day vs. night exterior views. User defined exterior lights are turned off in day views and turned on in night views. See "Generic Sunlight" on page 321.
- Select **3D> Lighting> Adjust Sunlight**  to open the **Default Sun Light Specification** dialog.

Several other factors can contribute to the overall quality of a rendered 3D view. See "Rendering Tips" on page 319.

3D Backdrops

A backdrop is an image, usually of an exterior view, that displays in the background of 3D views to help place the model into a realistic setting and add a sense of perspective. If a backdrop is not specified, Home Designer Suite applies a background color. See "3D Backdrops" on page 333.

Delete 3D Surface



The individual surfaces that make up objects can be temporarily removed from any 3D view by selecting **3D> Delete Surface** and then clicking on a surface. When the pointer is over a surface, that surface will become highlighted.

Surfaces removed in one view are removed in all 3D views, but are not permanently removed from the model. Continue clicking surfaces to remove them, then select another tool when you are finished.

Surfaces in 3D views are composed of multiple triangles. Hold the Alt key while clicking to delete one triangular face at a time rather than all triangles forming a surface.

To restore the most recently deleted surface, select **3D> Delete Surface** or click the toolbar button.

Repositioning Cameras

Once a 3D view is created, there are many ways to manipulate the camera location and the direction of its line of site using the mouse, the keyboard, and the menus.

When the keyboard, toolbar buttons, or menu commands are used to move or rotate a camera, the adjustments occur in regular increments. The size of these increments is specified in the **Camera Specification** dialog:

- The **Incremental Move Distance** controls Panning movement and forward and backward Dolly movement.
- The **Incremental Rotate Angle** controls Orbit movement, Tilt movement, and side to side Dolly movement.

Mouse Scroll Wheel and Trackpad

3D views can be panned and zoomed when any tool is active using the mouse scroll wheel or trackpad gestures. See “Trackpads” on page 20.

The program adjusts the speed of these actions depending on characteristics of the camera:

- Zoom speed depends on how close the camera is to the object located behind the mouse pointer. When the target object is far from the camera, zooming is faster; as the camera gets closer to the target, zooming slows.
- Panning speed depends on the length of the camera’s Line of Sight. In general, it is likely to be

There are several ways to restore all deleted surfaces:

- Select **Build> Floor> Rebuild Walls/Floors/Ceilings**.
- Exit the 3D view and reopen it.
- Generate a new 3D view.



Rebuild 3D



Select **3D> Rebuild 3D** to regenerate all 3D data associated with the current plan. All open views will remain open.

See “Camera Specification Dialog” on page 315.

Each time you move the camera, the view is updated. If you are using either the toolbar or keyboard to move the camera, you can hold down the Shift key, suppressing the redraw of the view until the Shift key is released and allowing you to move multiple increments more quickly.

You can also move a camera to a different floor by clicking the **Up One Floor**  or **Down One Floor**  button while the camera view is active. Note that this may affect what is seen in the view as well as its display in plan view. See “Floor Up / Floor Down” on page 230.

faster in an exterior view of a large model, slower in an interior view of a small room. See “Creating Camera Views” on page 305.

By default, panning and zooming adjusts the position and direction of the camera. It does not, however, adjust the distances at which surfaces are clipped. This means that if you zoom in closely on an object, some of its surfaces may be removed from the view. One way to avoid this is to lower the camera’s **Clip Surfaces Within** value in the **Camera Specification** dialog. See “Camera Specification Dialog” on page 315.

3Dconnexion® 3D Mice

3Dconnexion®’s 3D mice can be used to navigate in all views - including camera views and overviews.

In the Windows version of Home Designer Suite, pre-programmed view direction hotkeys are supported on devices with buttons for that purpose.

MacOS™ does not provide mapping support to the view direction commands. See Hotkeys.

You can specify whether navigation is centered about the camera or its focal point in the **Preferences** dialog. See “Render Panel” on page 54.

Rolling is not supported in Home Designer Suite. In addition, 3D mice cannot be used to move the mouse pointer. For details about using your 3D Connexion® mouse, refer to its documentation.

Gamepads

In the Windows version of Home Designer Suite, gamepads can be used to navigate in camera views and overviews as well as elevation views.

To use a gamepad in Home Designer Suite, check **Enable Gamepad** in the **Gamepad Settings** dialog. You can also adjust the sensitivity and other aspects

of thumbstick functionality when used in Home Designer Suite. See “Gamepad Settings Dialog” on page 59.

You can specify whether navigation is centered about the location of the camera or its focal point in the **Preferences** dialog. See “Render Panel” on page 54.

Move Camera with Mouse



An active camera’s position can be edited using the mouse. Select **3D> Move Camera**

With Mouse to access the Move Camera with

Mouse modes. These tools are not available in Elevation views.

	Description
	<p>Mouse-Orbit Camera lets you move the mouse to rotate the camera around its focal point. The camera’s position and direction both change.</p> <p>To continuously rotate the camera around its focal point, click in the 3D view, drag the mouse, and release the mouse button to “throw” the view. Click again in the view to stop it from rotating.</p>
	<p>To temporarily activate Mouse-Orbit Camera in the Windows version, hold down the Alt key and then click and drag using the middle mouse button. In the Mac version, hold down the Option + Shift keys, then drag using the left mouse button. When mouse button and keys are released, whatever tool was previously in use will still be active.</p>
	<p>Mouse-Pan Camera lets you move the camera up, down, left and right using the mouse. The camera’s position changes, but its direction does not.</p>
	<p>Mouse-Dolly Camera lets you move the camera forward and backward by moving mouse up and down. Move the mouse left or right to rotate the camera side to side.</p>
	<p>Mouse-Tilt Camera lets you move the mouse to tilt the camera in any direction while staying in the same location.</p>
	<p>3D Center Camera on Point lets you focus the camera at a particular point in the scene. This changes the camera’s direction and focal point, but not its position. To use the 3D Center tool, activate the tool and then click on any object in the scene.</p>
	<p>3D Focus on Object lets you focus the camera on a specific object, changing the camera’s position, direction, focal point, and the length of its line of sight. To use this tool, activate it and then click on an object in the scene. Alternatively, select an object in the view and click the Focus on Selected edit button.</p>

Move Camera with Keyboard

An active camera's position can be changed using the Arrow keys on your keyboard. Select **3D> Move Camera with Keyboard** to access the Move Camera with Keyboard modes. These modes are not available in Elevation views.

These modes use the **Incremental Move Distance** and **Incremental Rotate Angle** set in the active 3D view's **Camera Specification** dialog.







- **Keyboard-Orbit Camera** lets you use the keyboard to rotate the camera around the focal point. The camera's position and direction both change.
- **Keyboard-Pan Camera** lets you move the camera up, down, right, and left using the keyboard. The camera's position changes, but its direction does not.
- **Keyboard-Dolly Camera** lets you move the camera forward and back using the Up and Down Arrow keys, and rotate side to side using the Left and Right keys.
- **Keyboard-Tilt Camera** lets you use the Arrow keys to tilt the camera up, down, or side to side to change the focal point. The camera's direction changes, but its position does not.

Move Camera Tools



Select **3D> Move Camera** in a 3D view to access these tools. These tools change the active camera's position, but not its direction and are not available in Elevation views.

These tools use the **Incremental Move Distance** set in the active 3D view's **Camera Specification** dialog.

	Description
	Move Camera Forward moves the camera and its focal point forward.
	Move Camera Back moves the camera and the focal point back.
	Move Camera Left moves the camera and the focal point to the left in a line perpendicular to the line of sight.
	Move Camera Right moves the camera and the focal point to the right in a line perpendicular to the line of sight.
	Move Camera Up moves the camera and the focal point up.
	Move Camera Down moves the camera and the focal point down.







Orbit Camera Tools



Select **3D> Orbit Camera** in a 3D view to access these tools. Orbiting the camera rotates it about the focal point using the **Incremental**

Rotate Angle set in the active view's **Camera Specification** dialog.





These tools are not available in Cross Section/Elevation views.

	Description
	Move Camera In moves the camera closer to the focal point along the line of sight. The camera cannot move past the focal point using this tool.
	Move Camera Out moves the camera away from the focal point along the line of sight.
	Orbit Camera Upward rotates the camera up about the focal point. The camera cannot rotate past a vertical line looking straight down on the focal point.
	Orbit Camera Downward rotates the camera down about the focal point. The camera cannot rotate past a vertical line looking straight up at the focal point.
	Orbit Camera Left rotates the camera to the left about the focal point.
	Orbit Camera Right rotates the camera to the right about the focal point.

Tilt Camera Tools

 Select **3D> Tilt Camera** to access these tools. Tilting keeps the camera in one place and pivots the camera about its vertical or horizontal axis. This movement uses the **Incremental Rotate Angle** set in the active view's **Camera Specification**

dialog and is similar to tilting your head up and down or turning it side-to-side. These tools are not available in Elevation views.

	Description
	Tilt Camera Upward tilts the camera up while keeping it in the same location. The camera cannot tilt beyond the vertical position.
	Tilt Camera Downward tilts the camera down while keeping it in the same location. The camera cannot tilt beyond the vertical position.
	Turn Camera Left turns the camera to the left while staying in the same location.
	Turn Camera Right turns the camera to the right while staying in the same location.

Editing 3D Views

In addition to its position and direction, there are other ways to modify a 3D view.

appearance, and other attributes. See “Camera Specification Dialog” on page 315.

In the Specification Dialog

 You can make adjustments to a camera view or overview in the **Camera Specification** dialog. This dialog is particularly helpful for making fine adjustments to the camera's position,

 Tile a 3D view and plan view and use the camera movement tools to see how they affect the camera. See “Tiling Views” on page 62.

Using the Edit Tools

A camera symbol or symbols selected in plan view can be edited in a variety of ways using the buttons on the edit toolbar. See “The Edit Toolbar” on page 23.

The **Copy/Paste**  edit tool is available for a selected camera or overview. It is not, however, available for Elevation views. See “Copying and Pasting Objects” on page 70.

Using the Edit Handles

Return to plan view without closing the 3D view. See “Working in Multiple Views” on page 61.

Using the **Select Objects**  tool, select the camera object. When a camera symbol is selected it displays four edit handles.

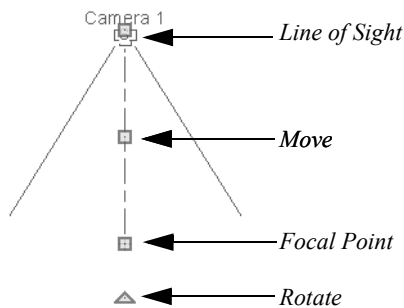

- Drag the **Line of Sight** handle to change the camera angle without moving the focal point.
- Drag the **Move** handle to relocate the camera while maintaining its relative angle.
- Drag the **Focal Point** handle to reposition the focal point and change the line of sight without moving the camera.
- Drag the **Rotate** handle to rotate the camera's line of sight about its center.

The 3D view corresponding to the camera symbol reflects changes made to the symbol in plan view.

Multiple camera symbols can be selected; however, their editing options are limited to being moved, rotated, and deleted.

Using the Contextual Menu

In a 3D view, right-click in an empty space in which the backdrop or background color displays to access

the contextual menu. See “Contextual Menus” on page 23.

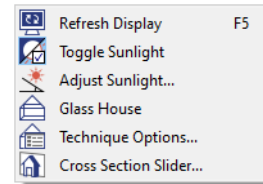

These options are a selection of tools and toggles specific to the current view.

Up One Floor/Down One Floor

You can move a camera to a different floor. While the camera view is active, select **Tools > Floor/**

Reference Display > Up One Floor  or **Down**

One Floor . Note that this may affect what is seen in the view as well as its display in plan view. See “In Plan View” on page 307.

The position and movement of a camera is affected by its location within the model. When the camera is outside a building, its height is relative to the terrain and follows the terrain as it is moved. When inside a building, the camera height is relative to the floor of the room it is drawn in.

If the camera is on an upper floor and you move the camera outside of the building, the camera remains at the same height relative to the floor it was created on.

Zooming

 The **Zoom Tools** are available in all 3D views. See “Zoom Tools” on page 63.

Selecting **Window > Zoom In** , **Zoom Out**  or

Fill Window  does not change the camera's location or field of view. Instead, the extents of the view are expanded or cropped.

Field of View

The **Field of View** refers to a camera's field of vision. A wider field of view makes the focal point appear further away, as more of the image is included in the same view window.

In plan view, the angled lines of a camera symbol indicate its field of view.

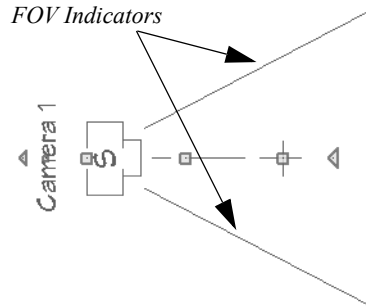

A camera's field of view can be adjusted in the **Camera Specification** dialog. See "Camera Specification Dialog" on page 315.

Cross Section Slider

 Select **3D > Cross Section Slider** when a camera view or overview is active to open the **Cross Section Slider** dialog.

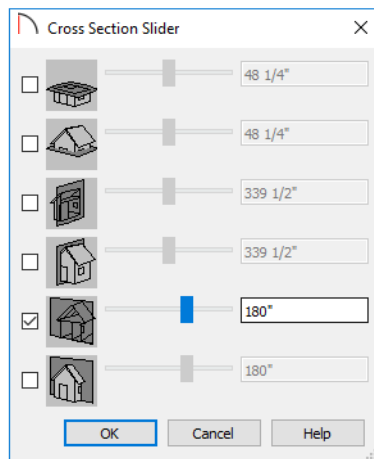

To use the Cross Section Slider

1. Check the box beside a cross section cutting plane to select it and make its Position slider and text box active.
2. Move the Position slider to adjust the position of the cutting plane.
 - The cutting plane Position is measured from the edge of the model that is cut first by the selected cutting plane.
3. Repeat steps 1-3 to use additional cutting planes if you wish.
4. Click **OK** to close the dialog. If the active camera is saved, its Cross Section Slider settings will also be retained. See "Saving 3D Views" on page 314.

Working in 3D

A variety of tools are available in 3D views that allow you to edit your 3D model. Y

Creating Objects in 3D Views

You can place windows, doors, and most library objects directly into 3D views. To do this, select the

appropriate tool and click in the 3D view. You can then edit the object's size and placement.

When created in 3D, most objects must be placed against a wall, on a floor platform, or within the Terrain Perimeter.

You can also click and drag to draw some objects such as terrain features and road, in camera views and overviews views.

Selecting and Editing Objects in 3D Views

Most objects can be selected and edited in 3D views.

Select **Edit> Select Objects**  and click on the surface of an object to select it. Once selected, objects can be edited using their edit handles, buttons on the edit toolbar, and the object's specification dialog. See "Editing Objects" on page 79.

When you select an object, edit handles and a handle surface display. The handle surface is a rectangle around the perimeter of the object that indicates the overall height and width of the selected surface. The edit handles that display depend on the type of object selected. Walls, for example, display two resize edit handles when selected while a slab displays ten handles, allowing you to move, resize and reshape it.

Note: If the wall height of the Exterior Room is adjusted in a 3D view, the default Floor or Ceiling Height of the entire floor is changed. See "Floor and Room Defaults" on page 132.

All moving or resizing is in the plane of the handle surface. You cannot move an object directly towards or away from the camera, for example, because that surface plane cannot be seen in the view.

By default, object movement is restricted to one inch or 10 mm increments. See "Grid Snaps" on page 68.

Unrestricted positioning can also be enabled by holding down the Ctrl key while moving or resizing an object. See "Unrestricted Movement" on page 93.

Saving and Printing 3D Views

3D camera views, overviews and Elevation views can be saved with the plan in which they are created, exported and saved as image files, as well as printed.

Saving 3D Views



Select **3D> Save Active Camera** to save the current camera in the plan. You can also save a camera view by checking the **Saved** box in the **Camera Specification** dialog. See "Camera Specification Dialog" on page 315.

Saved cameras can be closed and re-opened for later use, and retain their Cross Section Slider, Shadows,

Temporary dimension lines display when many objects are selected to help you resize the object and determine its height.

Because Elevation views are orthogonal and display objects at their actual dimensions, they are sometimes more suitable for editing objects than camera views or overviews. See "Elevation Views" on page 306.

When several 3D views are open, changes made in the plan automatically rebuild the model in all views. Because of this, it is typically faster to make changes to your plan with as few windows open as possible.

Editing Materials in 3D Views



Select **3D> Materials> Adjust Material Definition**, then click on a surface in the 3D view to open the **Define Material** dialog for that material. See "Adjust Material Definition" on page 299.



Select **3D> Material Painter** to apply materials to surfaces in the view using the Material Painter Tools. See "Material Painter Tools" on page 295.



Select **3D> Material Painter> Material Eyedropper** to apply the material on a surface in the view to other surfaces in the view. See "Material Eyedropper" on page 295.

Rebuild 3D





As changes are made to your plan, a 3D view automatically updates to reflect any changes visible in the view. If you find that a view is not updating as expected, select **3D> Rebuild 3D** to rebuild the entire 3D model.

and Glass House settings. See "Cross Section Slider" on page 313, "Adjust Sunlight Dialog" on page 322, "Shadows" on page 319, and "Rendering Techniques" on page 323.

Activating Saved Views

There are three ways to open a saved 3D view:

- Select the camera symbol in plan view and click the **Open View**  edit button.
- Double-click the camera symbol using the **Select Objects**  tool.

- Right-click on it and select **Open View** from the contextual menu.

Unsaved cameras that are open in another view window can also be activated using the **Open View**

 edit button.

If you open a saved camera view and then modify its location or direction using any of the tools available in that view, the program will confirm whether you want to re-save the camera using these new settings when you close it. See “Repositioning Cameras” on page 308.

Exporting 3D Views



All 3D views can be exported and saved as .bmp, .jpg, .png, or .tif files. Select **File> Export> Picture** to save the current screen image as an image file. See “To export a picture” on page 329.

Once saved, a picture can be opened and converted into many other formats using a graphics program.

Camera Specification Dialog



The **Camera Specification** dialog can be accessed in plan view by selecting one or more camera symbols and clicking the **Open Object** edit button. See “In Plan View” on page 307.

This dialog can also be accessed while a camera view or overview is active by selecting **3D> Edit Active**

Camera .

Printing 3D Views



Since 3D views are created using pixels instead of lines, **File> Print> Print Image** must be used when printing. Print Image is a special Home Designer Suite function that prints the screen in picture format. The entire view prints, including images such as plants and textures.

The quality of your print image is affected by your current window size and screen resolution. To maximize the quality of your printed image, generate it in full screen size and use the maximum screen resolution.

Closing 3D Views

Although you can have any number of 3D views open at a time, to conserve resources on your computer it is a good idea to close views when you no longer need them. There are a number of different ways to do this. See “Closing Views and Files” on page 65.

The selected view’s specific type is indicated in the dialog’s title bar: the specification dialog for a **Full**

Camera , for example, is named **Full Camera Specification**.

The settings in this dialog are also found in the **Full Camera** and all **Overview Defaults** dialogs. See “Camera Defaults Dialogs” on page 303.

Camera Panel

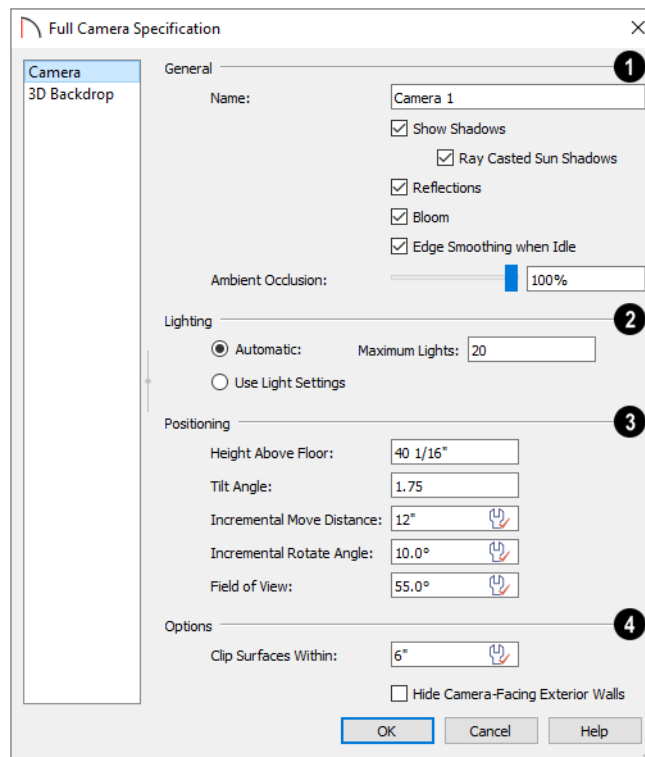

1 General -

- Specify the **Name** that displays in the camera label in plan view.
- Check **Show Shadows** to turn on shadows in the selected camera view. When unchecked, shadows are not generated. See “Shadows” on page 319.
- Check **Ray Casted Sun Shadows** for higher quality shadows cast by sun light. Ray Casted Sun Shadows take longer to generate than regular shadows and only refresh when the camera is not moving.
- Check **Reflections** to turn on reflections in the selected camera view. When unchecked, reflections are not generated. See “Reflections” on page 320.
- Light **Bloom** occurs around areas of intense illumination and looks as though the light is ‘bleeding’ beyond the edges of the light source. It adds realism to the view but can take longer to render. Only affects Standard and Watercolor renderings. See “Rendering Techniques” on page 323.
- Check **Edge Smoothing When Idle** to apply high quality edge smoothing to edge lines when

the selected camera is not in motion. See “Edge Smoothing” on page 320.

- Select the amount of **Ambient Occlusion** in the view using the slider bar or text field. Ambient Occlusion allows variation in the strength of the ambient light in Standard renderings. It is more realistic than uniform ambient light, but can take longer to render. See “Ambient Lighting and Occlusion” on page 321.

2 The **Lighting** settings control which and how many light sources are used in the current view. See “Lighting Modes” on page 322.

- Select **Automatic**, then specify the **Maximum Number** of lights that can be used in the current camera view.
- Select **Use Light Settings** to use all light sources in the entire plan provided that they are turned **On** .

3 The **Positioning** settings determine the position and orientation of the camera. See “Repositioning Cameras” on page 308.

- The **Height Above Floor** defines the height that the camera is above the floor level for the current floor. See “Camera Height” on page 305.

- The **Tilt Angle** determines the vertical angle that the camera is tilted. The camera maintains its focal point and position in plan view, but if the camera is tilted, the focal point is above or below the current camera height.
- The **Incremental Move Distance** controls how far the camera moves each time you Pan in any direction or Dolly forwards or backward using the keyboard, toolbar buttons, or menu. For interior views a small number is good, but for exterior you may want a larger increment.
- The **Incremental Rotate Angle** defines how many degrees the camera rotates each time you Tilt, Orbit, or Dolly side to side using the keyboard, toolbar buttons, or menu. A setting of 90° would make one full rotation in four moves.
- The **Field of View** defines the camera's field of vision in angular degrees. See "Field of View" on page 312.

4 Options -

- **Clip Surfaces Within** - Objects located within this distance from the camera do not display in the view. Decrease this value to display objects located close to the camera; increase it to improve the appearance of some surfaces in Overview cameras with very large extents.
- Check **Hide Camera-Facing Exterior Walls** to suppress the display of any exterior walls that face the camera. Interior walls set as Attic walls are also suppressed. This setting only has an effect when the selected camera's position is on the exterior of a structure and can also have an associated toggle. See "Hide Camera-Facing Exterior Walls" on page 320.

3D Backdrop Panel

The settings on the 3D Backdrop panel allow you to specify a backdrop image or color to display behind

your model in the selected 3D view. See "3D Backdrops" on page 333.

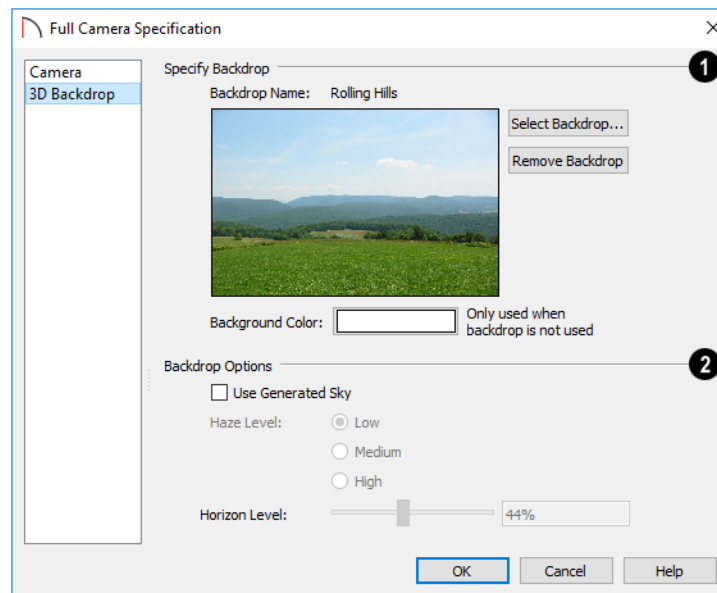

1 Specify Backdrop - A preview of the selected backdrop image is shown here. A backdrop cannot be selected or removed when Use Generated Sky is checked, below.

- **Backdrop Name** - The selected backdrop image's name displays for reference.

- Click **Select Backdrop** to choose a backdrop image from the library. See "Select Library Object Dialog" on page 283.
- Click **Remove Backdrop** to use a solid color instead of a backdrop image in all 3D views, then specify the color below.
- Click the Color bar to select the **Background Color** that displays when a backdrop image is not

being used. See “Select Color Dialog” on page 77.

The Background Color for plan views is set in the **Preferences** dialog. See “Colors Panel” on page 51.

2 Backdrop Options -

- Check **Use Generated Sky** to simulate a daytime sky backdrop. When checked, Spherical Panoramic Backdrop will also be checked and a preview of the Generated Sky will display above.

Note: If Use Generated Sky is in use as the backdrop in the current view and Sun Follows Camera is checked, the Generated Sky will not update if the camera is moved.

- Specify a **Haze Level** of **Low**, **Medium**, or **High**. This determines the degree to which light in the sky backdrop appears to be scattered by particles in the air.
- Specify a **Horizon Level** using the text field or slider bar. The default value of 44% works well in most situations.

Elevation Camera Specification Dialog



The **Elevation Camera** and **Wall Elevation Camera Specification** dialogs can be accessed in plan view by selecting an elevation camera symbol and clicking the **Open Object** edit button. See “In Plan View” on page 307.

This dialog can also be accessed while an elevation camera view is active by selecting **3D> Edit Active**

Camera .

The settings in this dialog are also found in the **Elevation Defaults** dialog. See “Camera Defaults Dialogs” on page 303.

Camera Panel

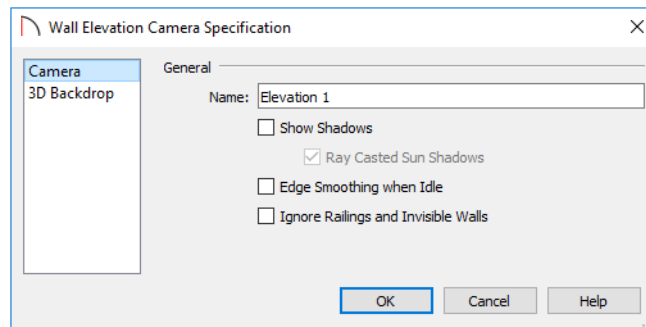

The **Camera Name** displays in plan view.

- Check **Show Shadows** to turn on shadows in the selected camera view. When unchecked, shadows are not generated. See “Shadows” on page 319.
- Check **Ray Casted Sun Shadows** for higher quality shadows cast by sun light. Ray Casted Sun Shadows take longer to generate than regular shadows and only refresh when the camera is not moving.
- Check **Edge Smoothing When Idle** to apply high quality smoothing to edge and pattern lines when the camera is not in motion. See “Edge Smoothing” on page 320.

- Check **Ignore Railings and Invisible Walls** to ignore the room definition created by these types of walls in a selected interior **Wall Elevation** view. When this is unchecked, interior **Wall Elevation** views only recognize room definition created by regular walls. See “Elevation Views” on page 306.

Backdrop Panel

The settings on the **BACKDROP** panel allow you to specify a backdrop image or color to display behind your model in the selected 3D view. See “3D Backdrop Panel” on page 317.

3D Rendering

There are a variety of tools available to create 3D views of a model: simply click a button to create an overview, or click and drag to create a camera or elevation view. See “3D Views” on page 303.

To improve the quality of the rendering and create a custom look, you can adjust lighting, edit the materials used in the plan, choose from several rendering techniques and fine-tune 3D view quality settings.

Rendering Tips

There are a variety of factors which affect the appearance and quality of rendered 3D views. You can use these tools and settings to achieve renderings that meet your needs.

- Lighting
- Shadows
- Reflections
- Material Definitions
- Images
- Backdrops
- Edge Smoothing
- Hide Camera-Facing Exterior Walls

Lighting

Lighting is extremely important in most 3D renderings. Lighting controls the visibility of objects in a view, affects the appearance of surfaces, and influences the appearances of colors and textures on those surfaces. Even small changes to light intensity,

Chapter Contents

- Rendering Tips
- Lighting
- Displaying Lights
- Lighting Modes
- Adjust Sunlight Dialog
- Rendering Techniques
- Rendering Technique Options

direction and color can have a large impact on image quality. See “Lighting” on page 320.

Shadows



Like lighting, shadows have an important effect on image quality. Shadows can be generated in any type of camera view using any Rendering Technique aside from Glass House. See “Rendering Techniques” on page 323.

When shadows are enabled and the sun is shining directly at a window, its light can shine through the window and into an interior room. These shadows use **Ray Casted Sun Shadows** by default, but this option can be unchecked if it slows performance in 3D views. See “Generic Sunlight” on page 321.

Shadows are enabled in Full Camera views by default. You can, however, check or uncheck **Show Shadows** and **Ray Casted Sun Shadows** in the defaults dialog for any camera tool or in the **Camera Specification** dialog. In addition, you can select **3D>**

Camera View Options > Toggle Shadows  in any camera view. See “Camera Panel” on page 316.

Reflections

 Reflections are another aspect of lighting that can increase a 3D view’s realism. When a flat surface is assigned a Mirror material, it can display the reflections of other objects in the scene.

Note that a Mirror surface cannot display the reflection of another mirror. When one mirror can be seen in another, its material is shown rather than a reflection.

Reflections only generate in Perspective 3D views using the Standard Rendering Technique. They can slow down 3D view generation and responsiveness considerably.

Reflections can be toggled on or off in a camera view by selecting **3D > Camera View Options > Toggle**

Reflections  as well as in the **Camera Specification** dialog. See “Camera Specification Dialog” on page 315.

Material Definitions

Textures are graphic files that represent contoured surfaces of objects such as carpet, bricks, tile, and wood in 3D views. Textures are assigned to materials which in turn are assigned to objects. See “Textures” on page 294.

The display of materials in 3D views is controlled by settings in the **Define Material** dialog. See “Define Material Dialog” on page 300.

Brightness, shininess and transparency control how light sources affect the display of surfaces in 3D views. See “Lighting” on page 320.

If no texture is selected for a material or if the display of textures is turned off, affected surfaces are a solid color instead.

Images

Images are very important for the appearance of 3D views. Images are picture files that represent individual objects such as trees, flowers, and vehicles. See “Placing Images” on page 326.

Lighting

Lighting controls the visibility of objects in 3D views, affects the appearance of surfaces, and

Backdrops

A backdrop is an image, usually of an exterior view, that displays in the background of 3D views to help place the model into a realistic setting and add a sense of perspective. If a backdrop is not specified, Home Designer Suite applies a background color. See “3D Backdrops” on page 333.

Edge Smoothing

Angled surface edges will sometimes display on screen as jagged or stair-stepped. Edge Smoothing softens this effect, producing cleaner lines.

You can specify how much **Hardware Edge Smoothing** occurs in 3D views in the **Preferences** dialog. **Hardware Edge Smoothing** is set to “High” by default; however, if 3D views render slowly on your system, you can try using a lower setting. See “Render Panel” on page 54.

Even higher quality Edge Smoothing can be produced by checking **Edge Smoothing When Idle** in the **Camera Specification** dialog. This setting does not affect a camera while its position or orientation are being changed, but applies additional smoothing to edge lines when the camera is not in motion. See “Camera Specification Dialog” on page 315.

This high quality Edge Smoothing option is view-specific and can also be toggled on or off by selecting **3D > Camera View Options > Toggle Edge Smoothing When Idle** .

Hide Camera-Facing Exterior Walls

 Occasionally, it can be very helpful to view the interior of a structure from an exterior view. To achieve this, create an exterior camera view or overview and select **3D > Camera View Options > Hide Camera-Facing Exterior Walls**. This option is view-specific and can also be set in the **Camera Specification** dialog. See “Camera Panel” on page 316.

Hide Camera-Facing Exterior Walls is also an option for Walkthrough Paths. See “Walkthrough Options Dialog” on page 337.

influences the appearances of colors and textures on those surfaces.

By default, a maximum of eight lights can display in a given camera view or overview. If more than eight are present, those with the highest intensity located in the same room as the camera are rendered. Lights in adjacent rooms may also be rendered, with the highest intensity lights rendered first.

You can specify a different Maximum Lights number in the **Camera Specification** dialog. See “Camera Panel” on page 316.

You can also manually turn on and off individual lights in order to get the desired lighting effects. See “Displaying Lights” on page 321.

When the camera is outside a building, the program normally uses sunlight for lighting calculations and turns off all other light sources. You can turn the sunlight off and use all the other exterior lights to simulate nighttime views.

There are four types of light sources in Standard 3D views:

- Default Interior Light
- Light Fixtures
- Generic Sunlight
- Ambient Lighting and Occlusion

Default Interior Light

If you create a Standard interior in a room where no lights have been placed, the program creates a Default Light source within that room. The Default interior light acts like a central point light source but cannot be selected or edited.

Because the Default Light cannot be adjusted, if you want to control the light in an interior 3D view, you must add lights to the rooms in your plan by placing light fixtures and Added Lights

Light Fixtures

An electric symbol that represents a Light Fixture has a light source associated with it. When a light is placed in a room, it will be used as a light source in 3D views instead of the Default Light. In large rooms, more than one light fixture may be needed for sufficient light.

Displaying Lights



The display of light fixtures in floor plan and 3D views is controlled in the **Display Options**

Generic Sunlight

When you create a 3D view, the program creates a **Generic Sun** light source.

The Generic Sun’s intensity, color, and angle can be modified in the **Adjust Sunlight** dialog. In addition, you can specify that it follow the camera in 3D views so surfaces are always illuminated. See “Adjust Sunlight Dialog” on page 322.



When standard shadows are enabled, sunlight can shine through windows into interior rooms. See “Shadows” on page 319.

Select **3D> Lighting> Toggle Sunlight**  turn the Generic Sun on or off to simulate either daytime or nighttime exterior lighting.

Ambient Lighting and Occlusion

Ambient lighting simulates the way light bounces around a scene, producing a basic level of uniform illumination on all surfaces. It is used in camera views and overviews using the Standard Rendering Technique.

There are three types of ambient light in Home Designer Suite:



- **Interior Ambient** controls the ambient light in interior views.
- **Daytime Ambient** controls the ambient light in exterior views when **Toggle Sunlight**  is on.
- **Nighttime Ambient** controls the ambient light in exterior rendered views when **Toggle Sunlight**  is off.

You can control the brightness of each in the **Rendering Technique Options** dialog. See “Standard Panel” on page 323.

Ambient occlusion adds shading to surfaces near corners which, because of their location, reflect less light compared to other surfaces. Too little ambient occlusion can result in a view having a flat appearance. You can specify the amount of **Ambient Occlusion** to use in Standard renderings in the **Camera Specification** dialogs. See “Camera Panel” on page 316.

dialog. Light fixtures are placed on the “Electrical” layer. See “Display Options Dialog” on page 74.

In addition, they can serve as sources of light in rendered 3D views. They can be turned on and off, as well.

To turn one or more light fixtures on or off in 3D views, select them and click the **Turn Light(s) Off in 3D**  or **Turn Light(s) On in 3D**  edit button.

Lighting Modes

By default, cameras use an Automatic Lighting Mode that allows a set number of lights to illuminate the view. This number can be specified in the **Camera Specification** dialog. See “Camera Panel” on page 316.

If more than the set number of lights are present, lights are prioritized in this order:

- Lights in the same room as the camera before those in different rooms.
- Higher intensity lights before lower intensity lights.
- Lights closer to the camera before those further away.

Adjust Sunlight Dialog



The **Adjust Sunlight** dialog allows you to control the intensity, direction and color of the Generic Sun light source in the currently active 3D view. See “Generic Sunlight” on page 321.

To open this dialog, select **3D> Lighting> Adjust Sunlight**  while a 3D view is active.

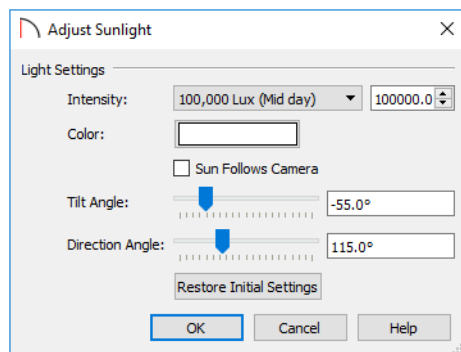

- Use the **Intensity** slider bar or text field to control how bright the Generic Sun light appears.
- Click the **Color** bar to define the color of the light being modeled. Colored sunlight may be used to

In plan view, light fixtures can display labels when the “Electrical, Labels” layer is turned on.

Sunlight will shine through windows into interior rooms when shadows are enabled. See “Shadows” on page 319.

- Regardless of their intensity or proximity to the camera, lights on floors above the camera are not used in Floor Overviews. See “3D View Tools” on page 304.

The Automatic Lighting Mode is useful because it is an easy way to produce reasonable lighting without taxing your video memory.

An alternative to the Automatic Lighting Mode is the **Use Light Settings** option. When **Use Light Settings** is selected, all lights in the current plan that are turned On are used in 3D views. This gives you control over which lights are used as light sources but may require more resources on your system.

achieve special lighting effects, but may alter the appearance of your material colors and textures.

- Check **Sun Follows Camera** to adjust the position of the Generic Sun so that it is always behind the camera, illuminating surfaces in the view. When this is checked, the Tilt and Direction Angle settings that follow are disabled.
- Specify the **Tilt Angle**, which is the angle of the sunlight with respect to the horizon. A value of 90° means that the light points straight up, while a value of -90° means that the light points straight down. 0° is parallel to the horizon.
- Specify the **Direction Angle**, which is the direction that the sunlight points toward. 0° is measured horizontally on screen, pointing to the right. Positive values rotate in a counter-clockwise direction from there, while negative values rotate clockwise.
- Click the **Restore Initial Settings** button to restore the original Generic Sun settings.

By default, the Generic Sun light color is pure white, which has the least effect on the appearance of material colors and textures. See “Materials” on page

293.

Rendering Techniques

 Any camera view, elevation view, or overview can be generated using either of two Rendering Techniques. When a 3D view is active, select **3D> Rendering Techniques** to access these tools.

 In plan view, the camera symbol for a view using the **Standard** technique displays an S in its center. See “Displaying 3D Views” on page 307.

Standard Rendering

 **Standard** rendering is a photo-realistic technique that represents materials using textures, models lighting, and can also display shadows.



Glass House

Glass House rendering uses different shades of a single color to display the model with surface edge lines and semi-transparent surfaces. Lighting and shadows are not modeled, and materials are not represented, so textures are not used.

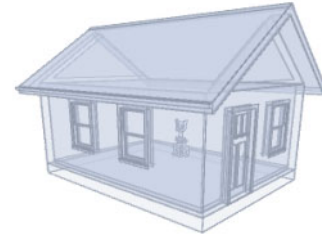

 In plan view, the camera symbol for a view using the **Glass House** technique displays a G in its center.

Rendering Technique Options

 The settings in the **Rendering Technique Options** dialog allow you to control the specific effects of each rendering technique on an active 3D view. To access this dialog, create a camera view or overview and select **3D> Rendering Techniques> Technique Options**.

In the **Rendering Technique Options** dialog, select a technique from the list on the left to make its

options active on the right. When this dialog is first opened, the technique currently used by the view is selected.

As changes are made in the **Rendering Technique Options** dialog, the 3D view automatically updates to reflect those changes.

Standard Panel

 The active 3D view immediately updates to reflect any changes made to the Rendering Technique Options for Standard renderings.

There are a variety of other tools that affect the appearance of Standard rendered views, as well. See “Displaying 3D Views” on page 307.

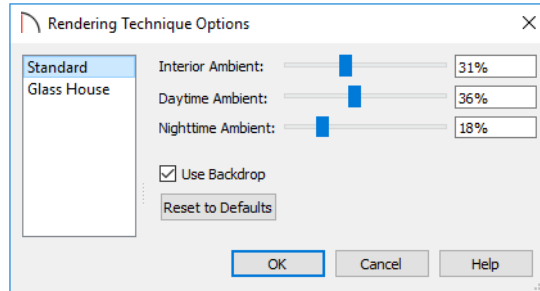

Specify the amount of Ambient light to use in different situations in Standard renderings. See “Ambient Lighting and Occlusion” on page 321.

- **Interior Ambient** affects interior views.
- **Daytime Ambient** affects exterior views.

- **Nighttime Ambient** affects nighttime exterior views.
- When **Use Backdrop** is checked, the backdrop image specified for this view is used. When unchecked, the specified Backdrop Color is used instead. See “3D Backdrops” on page 333.

Glass House Panel



The active 3D view immediately updates to reflect any changes made to the Rendering

Technique Options settings for Glass House renderings.

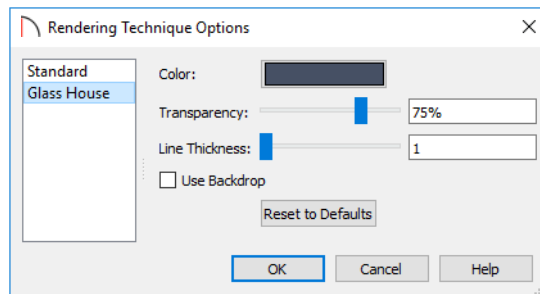

- Click the **Color** bar to select a color for the semi-transparent surfaces and lines in a Glass House view. See “Select Color Dialog” on page 77.
- Specify the **Transparency** of the surfaces in Glass House view. For example, to create a wire-frame line drawing of your structure, turn transparency to full and minimize line thickness.
- Specify the **Line Thickness** of surface lines in Glass House view.

- When **Use Backdrop** is checked, the backdrop image specified for this view is used. When unchecked, the specified Backdrop Color is used instead. See “3D Backdrops” on page 333.
- Click **Reset to Defaults** to restore the default settings used when the Glass House technique was first enabled.

Pictures, Images, and Walkthroughs

Home Designer Suite uses picture files in a variety of ways to enhance your drawings.

The Library Browser contains images of real world objects like plants and vehicles that can display in 3D views.

Picture files can also be imported into Home Designer Suite and shown in most views.

You can save any view using a variety of picture file formats. In addition, Home Designer Suite allows you to create virtual tour videos that can be played back later and shared with others.

Chapter Contents

- Picture Files vs Pictures and Image Objects
 - Images
 - Displaying Images
 - Editing Images
 - Image Specification Dialog
 - Pictures
 - Picture File Box Specification Dialog
 - Metafiles
 - Metafile Box Specification Dialog
 - PDF Files
 - PDF Box Specification Dialog
 - Displaying Pictures, Metafiles, and PDF Boxes
 - Editing Pictures, Metafiles, and PDF Boxes
 - 3D Backdrops
 - Backdrop Specification Dialog
 - Walkthrough Paths
-
- Recording a Walkthrough

Picture Files vs Pictures and Image Objects

In common computer language, picture files, pictures and images are more or less synonymous. In the Home Designer Suite environment, however, there are some notable differences between these terms.

In Home Designer Suite, a two dimensional image file such as a .bmp, .jpg, .gif, or .png is referred to as a picture file or an image file. Examples of these files are saved on most computers and can be opened in a variety of applications.

A Picture, on the other hand, is a file that has been imported into the program. Pictures can be imported into plan view and Elevation views. They are two-

dimensional only and do not display in camera views or overviews.

An Image object is also based on a picture file, but it does display in both 2D and 3D views. Images have 3D width and height data associated with them, as well as a 2D symbol which displays in plan view.



Picture files have additional uses in Home Designer Suite, as well:

- Backdrops are picture files that display behind 3D views. See “3D Backdrops” on page 333.
- Textures are picture files that realistically represent materials in 3D views. See “About Materials” on page 294.

Images

Images add realistic detail to 3D views without adding many surfaces to the model. For example, a tree image with a single surface can be used instead of a tree symbol with thousands, dramatically improving realism without compromising drawing time.

There are two types of Images in Home Designer Suite:

- **Images**  rotate so that they always face the camera in 3D views.
- **Billboard Images**  do not rotate to face the camera. An example of when this may be useful is an image of a trellis, which might look awkward when facing a camera from a side view.

Placing Images



 A selection of Images are available in the Library Browser. Select one and click in a plan view, camera view or overview to place it. See “Placing Library Objects” on page 281.

Creating Images

 Custom Images can be added to the User Catalog in the library, as well as created in plan files. Home Designer Suite can use any image with a *.bmp, *.jpg, *.png, *.gif, or *.tif extension.

Generally, .png files work best as Images because this format has good compression and allows for the Image to contain transparency information.

To create an Image in plan view

1. In plan view, select **Build> Image> Create Image**  or **Billboard Image**  to open the **Image Specification** dialog. See “Image Specification Dialog” on page 328.
2. On the IMAGE panel:
 - Click the **Browse** button to select a picture file on your computer or enter the path to a valid picture file in the **Image File** field. If the file is not located in the Home Designer Suite 2021 Data folder, a copy of the file will be created at Home Designer Suite 2021 Data\Images\My Images and the Image object will reference that copy. See “Home Designer Suite Data” on page 32.
 - Select a **2D Plan Symbol** from the drop-down list or click the **Library** button and select a symbol from the library. The selected symbol represents the image in plan view. See “Image Panel” on page 328.
 - Specify the **Size** and **Position** of the image.
3. Specify transparency information on the TRANSPARENCY panel.
4. Click OK to close the **Image Specification** dialog.
5. Click to place the new Image in plan view.

To create an image in the Library Browser

1. In the Library Browser, right-click on an unlocked folder.

2. Select **New> Image** from the contextual menu to open the **Image Specification** dialog.
3. Browse to the image file you want to add and select your other options. See “Image Specification Dialog” on page 328.
4. Once created, the image is listed in the library folder that you right-clicked on. Size and other data is saved.

Using Paste Image



You can also import an image by first copying it to the system clipboard, then navigating to a Home Designer Suite window and selecting **Edit> Paste> Paste** from the menu. See “Paste Special” on page 71.

Displaying Images



The display of images in floor plan and 3D views is controlled in the **Display Options** dialog. See “Layer Attributes” on page 74.

Images are placed on the “Images” layer.

In Plan View

In plan view, most images are represented by an Image  symbol. You can specify a different symbol to represent an image if you wish. See “Image Specification Dialog” on page 328.

In 3D Views

The actual picture associated with an image object can be seen in 3D views, as can any transparency data associated it. See “Image Specification Dialog” on page 328.

Images can be set to either rotate so that they always face the camera or remain stationary, like billboards. See “Images” on page 326.

Editing Images

Images can be selected in 2D and 3D views and edited using the edit handles, edit tools and the **Image Specification** dialog.

When an image is resized using the edit handle, its aspect ratio is retained and 2D symbol resizes proportionally.

Using the Mouse

In plan view, a selected image can be rotated, moved, and resized. In 3D views, a selected image only has two edit handles: the circular **Resize** handle and square **Move** handle.

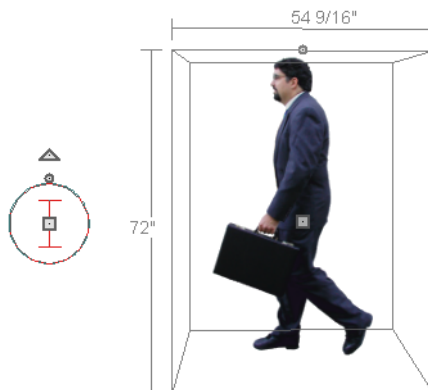

Using the Edit Toolbar

A selected image or images can be edited in a variety of ways using the buttons on the edit toolbar. See “The Edit Toolbar” on page 23.

Image Specification Dialog



Select an image and click the **Open Object** edit button to open the **Image Specification** dialog.

Image Panel

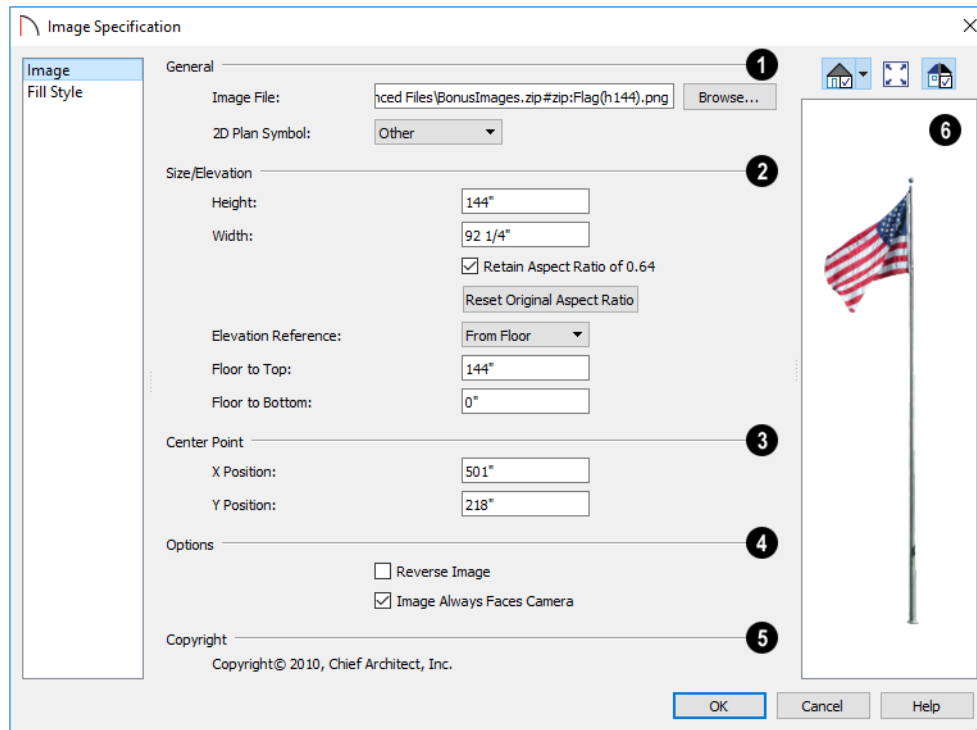

- 1 **General** information about the selected Image can be specified here.
 - The **Image File** associated with the Image can be specified. Click **Browse** to choose a file saved on your computer or type the file's full pathname in the text field.
 - Select a **2D Plan Symbol** from the drop-down list to represent the Image in plan view. See "Displaying Images" on page 327.
- 2 Specify the **Size/Elevation** of the image as it displays in 3D views.
 - Enter a **Height** for the selected image.
 - Enter a **Width** for the selected image.
 - Uncheck **Retain Aspect Ratio of X** if you would like to modify the Height or Width without affecting the other value. If you do this, the image may appear distorted. This check box does not affect editing performed outside of this dialog and is an action rather than a state: the next time you open this dialog, it will be checked.
 - Click **Reset Original Aspect Ratio** to reset the image's original aspect ratio and remove any distortion caused by resizing.
 - Select the **Elevation Reference** from the drop-down list. This determines where the next two settings are measured from and also affects their setting labels.
 - Specify the height **to Top**, measured from the selected Elevation Reference to the top edge of the image.
 - Specify the height **to Bottom**, measured from the selected Elevation Reference to the bottom edge of the image.
- 3 Specify the location of the **X and Y Coordinates** of the selected image's **Center Point**.
- 4 **Options**
 - Reverse Image
 - Image Always Faces Camera
- 5 **Copyright**
 - Copyright © 2010, Chief Architect, Inc.
- 6 **Preview** window showing the image on a pole.

4 Options -

- Check **Reverse Image** to reflect the appearance of the image about an imaginary vertical line through its center.
- Check **Image Always Faces Camera** to prevent the image from rotating to face the camera in 3D views. This box is unchecked for Billboard Images. See “Images” on page 326.

5 Any **Copyright** information associated with the selected Image will be stated here.

- 6** A preview of the selected Image displays here. The Glass House Rendering Techniques is not available for images. See “Dialog Preview Panes” on page 25.

Fill Style Panel

The settings on the FILL STYLE panel affect the appearance of the selected image’s **2D Plan Symbol** in plan view, provided that the selected symbol is a closed shape. For information about these settings, see “Fill Style Panel” on page 76.

Pictures

A variety of picture file types can be imported into and exported out of Home Designer Suite.

Metafiles are also types of picture files that can be imported and exported. See “Metafiles” on page 330.

Exporting Pictures

There are several ways to save a picture of a view in Home Designer Suite:



Using the **Export Picture** tool is similar to creating a screen capture of everything in the current view window. Pictures can be saved in various file formats and used in other applications.

Export Picture  is best suited for 3D views. When exporting a line-based view, best results can be achieved by saving it as a Metafile. See “To export a metafile” on page 330.



Use the **Print Image** tool to either print or save the current view as a PDF file. See “Print Image Dialog” on page 389.

To export a picture

1. Open the view that you would like to export as a picture file.
2. Zoom, pan or otherwise adjust the view so that what you see on screen suits your needs. See “Displaying 3D Views” on page 307.
3. Select **File> Export> Export Picture (BMP, JPG, PNG)**  to open the **Export Picture** dialog, below, and specify the desired image size and other properties.
4. In the **Export Picture File** dialog, which opens next, give the file to be exported a name, file

type, and location. See “Exporting Files” on page 36.

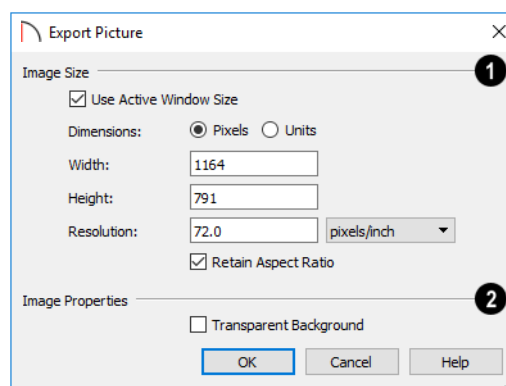
Export Picture Dialog

- 1** Specify the exported file’s **Image Size** in pixels or inches (mm).

- Check **Use Active Window Size** to export the picture at the same size as the active view window. The window’s **Width** and **Height** are described below. In camera views only, these values can be changed, in which case this box becomes unchecked automatically.
- Select either **Pixels** or **Units** as the method by which the picture’s dimensions are measured.
- Specify the **Width** and **Height** of the image. The initial values correspond to the view window’s size. In plan view, they display for reference only.
- Specify the **Resolution** of the image. Select **Dots/Inch** or **Dots/mm** from the drop-down list.
- Uncheck **Retain Aspect Ratio** if you would like to modify the **Height** or **Width** without affecting

the other value. Leave this box checked to prevent the image from becoming distorted.

- 2 Check **Transparent Background** to produce alpha transparency in the spaces between all objects that can be seen in the current view. Transparency associated with Fill and Text Styles is retained, as well. Note that the **.png** and **.tif** file types support transparency, while the **.jpg** and **.bmp** file types do not.

Importing Pictures



Pictures can be imported into and displayed in plan view. Pictures do not display in camera views or overviews. See “Displaying Pictures, Metafiles, and PDF Boxes” on page 332.

There are several ways to import a Picture into Home Designer Suite:

- Select **File> Import> Import Picture (BMP, JPG, PNG)**  to open the **Import Picture File**

dialog, which is a typical open file dialog. See “Importing Files” on page 38.

- Click and drag an image file from an operating system window into the Home Designer Suite window.
- In any application, copy an image to the system clipboard, then select **Edit> Paste> Paste**  from the Home Designer Suite menu in an eligible view window. See “Paste Special” on page 71.

Note: Importing large, or multiple, Pictures into a plan file can result in program slowness.

An imported picture is placed in the center of the current view. Once imported, pictures can be selected and edited. See “Editing Pictures, Metafiles, and PDF Boxes” on page 333.

Picture File Box Specification Dialog



Select an imported picture file and click the **Open Object** edit button to open the **Picture File Box Specification** dialog.

The settings in this dialog are similar to those on the **LINE STYLE** panel in numerous other dialogs, with one exception: check **Show Outline** to turn on the display of the picture’s border polyline. For more information, see “Line Style Panel” on page 103.

Metafiles

A metafile (**.emf**, **.wmf**) is a special picture file format made up of vectors (lines) that allow the image to be rescaled without loss of quality. High resolution pictures of line-based views can be exported as a metafile.

Note: Metafiles are not supported in Mac operating systems and cannot be imported or exported in Mac versions of the software.



Exporting Metafiles



An enhanced metafile (**.emf**) can be exported from plan view.

Only objects that display on screen are included in an exported metafile.

To export a metafile

1. Accurately position the view on screen.
2. Select **File> Export> Export Metafile (EMF)** .
3. Drag a marquee  from corner to corner, defining the area that will included in the metafile.
4. Release the mouse button to open the **Export Metafile** dialog, which is a typical Save As dialog. See “Saving, Exporting, and Backing Up Files” on page 34.
5. When you click the Save button, the **Metafile Size** dialog opens.

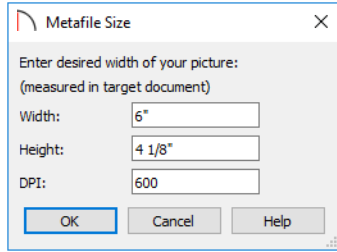

- Specify the desired **Width** or **Height** of the metafile. When one value is edited, the other changes to maintain its aspect ratio.

Specify, too, the desired **Dots Per Inch (DPI)** for the metafile. A larger value results in a higher quality metafile, but also a larger file size.

Importing Metafiles



Metafiles can be imported into and displayed in plan view. Metafiles do not display in

camera views or overviews. See “Displaying Pictures, Metafiles, and PDF Boxes” on page 332.

There are two ways to import a metafile into Home Designer Suite:

- Select **File> Import> Import Metafile (EMF,WMF)** to open the **Import Metafile** dialog, which is a typical open file dialog. See “Importing Files” on page 38.
- You can also click and drag a metafile file from an operating system window into the Home Designer Suite window to import it.

An imported metafile is placed in the center of the current view. Once imported, metafiles can be selected and edited. See “Editing Pictures, Metafiles, and PDF Boxes” on page 333.

Metafile Box Specification Dialog



Select an imported metafile and click the **Open Object** edit button to open the **Metafile Box Specification** dialog.

The settings in this dialog are similar to those on the **LINE STYLE** panel in numerous other dialogs, with one exception. Check **Show Outline** to turn on the display of the picture’s border polyline. For more information, see “Line Style Panel” on page 103.

PDF Files

Portable Document Format (**.pdf**) files are a special type of file that can be viewed on nearly any computer and can include a wide variety of visual information.

Printing and Exporting PDF Files



You can save any view as a 2D **.pdf** file by selecting **File> Export> Export PDF**. This

will open either the **Print View** or **Print Image** dialog, depending on the view type.

You can also save any view as a 2D **.pdf** file by selecting “Chief Architect Save as PDF” as the Destination printer **Name** in either of these dialogs. See “Printing to a PDF File” on page 387.

Importing PDF Files



To import a **.pdf** file, select **File> Import> Import PDF**.

You can also import a **.pdf** file by dragging it from an operating system window into the Home Designer Suite window.

You can import **.pdf** files into Home Designer Suite in plan view. Once imported, PDF boxes behave and can be edited similar to imported pictures and

metafiles. See “Editing Pictures, Metafiles, and PDF Boxes” on page 333.

Some **.pdf** files can contain both 2D and 3D information; however, Home Designer Suite can only support 2D data in an imported **.pdf** file. When a 3D **.pdf** file is imported, it may display text, a static image of the 3D model, or it may not import at all.

Note: Importing large, or multiple, .pdf files into a plan file can result in program slowness.

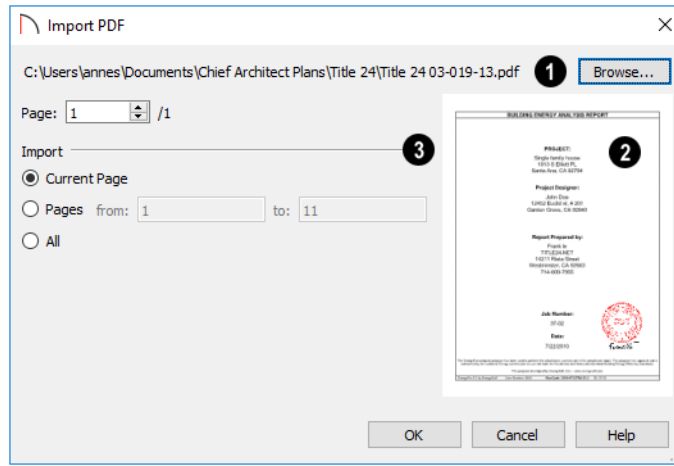

- 1 The full pathname of the **.pdf** file displays here. If the pathname is not that of a valid **.pdf** file, this text will display in red.
 - Click the **Browse** button to choose a new **.pdf** file or to relink to a missing file.
 - Specify the **Page** of the **.pdf** file that displays in the preview on the right. Type a page number in the text field or use the spin control arrows to browse the pages sequentially.
- 2 A preview of the page selected above displays on the right.
- 3 Specify how much of the **.pdf** file you wish to **Import**. When multiple pages are imported, a separate PDF box is created for each one.
 - Select **Current Page** to import only the page specified above and shown in the preview to the right.
 - Select **Pages**, then specify the starting page in the **From** field and the ending page in the **To** field.
 - Select **All** to import the entire **.pdf** file.

PDF Box Specification Dialog

 Select an imported PDF box and click the **Open Object** edit button to open the **PDF Box Specification** dialog.

The settings in this dialog are similar to those on the **LINE STYLE** panel in numerous other dialogs, with

one exception: Check the **Show Outline** box to turn on the display of the PDF box's border polyline.

See "Line Style Panel" on page 103.

Displaying Pictures, Metafiles, and PDF Boxes

 The display of Pictures, Metafiles, and PDF Boxes is controlled in the **Display Options** dialog. See "Layer Attributes" on page 74.

Pictures, Metafiles, and PDF Boxes are placed on the "CAD, Default" layer.

Pictures, Metafiles, and PDF Boxes can be imported into and displayed in plan view. A Picture, Metafile, or PDF Box can only be seen in the view where it

was imported and cannot be imported into a camera view or overview.

Drawing Groups

Each object in a plan file is included in a Drawing Group, which influences whether it displays in front of or behind other objects. By default, imported

pictures and PDF Boxes are placed in the Back Group, and imported metafiles are placed in the same Drawing Group as CAD objects.

Once imported, the drawing order of pictures, metafiles, and PDF Boxes can be customized. See “Drawing Groups” on page 75.

Editing Pictures, Metafiles, and PDF Boxes

Pictures, Metafiles, and PDF Boxes can be selected and edited using the edit handles, the edit toolbar, and their specification dialogs.

In the Specification Dialog

Pictures, Metafiles, and PDF Boxes can be customized in their specification dialog. See:

- “Picture File Box Specification Dialog” on page 330
- “Metafile Box Specification Dialog” on page 331
- “PDF Box Specification Dialog” on page 332

Using the Mouse

Pictures, Metafiles, and PDF Boxes have edit handles similar to other box-based objects. See “Editing Box-Based Objects” on page 89.

- The corner Resize handles behave do not behave the same for Pictures, Metafiles, and PDF Boxes as they do for CAD boxes, however. If you drag a corner handle of one of these objects while the Default Edit Behavior is active, its contents will resize and height to width ratio will be retained.
- If you drag an Extend handle along a Picture, Metafile, or PDF Box’s edge, the contents of the box will not be resized. If you resize it larger, an empty space will be created between that edge and the contents; if you resize it smaller, the contents will be cropped.

To resize a picture or metafile

1. Find two items on the imported picture or metafile that are separated by a known horizontal or vertical distance, such as two walls or plot lines.
2. Draw parallel CAD lines to represent these two items and use dimensions to position the lines so that they are the known distance between the two items in the imported picture. See “The CAD Drawing Tools” on page 101.
3. Click and drag one of the imported picture’s corner edit handles to resize it concentrically until the two items are aligned with the two CAD lines.

Using Dimensions

Pictures, Metafiles, and PDF Boxes can be relocated relative to other objects with precision using dimensions.

To avoid changing the selected object’s aspect ratio, make sure you choose to move the entire object rather than the selected edge. See “Moving Objects Using Dimensions” on page 154.

Using the Edit Tools

A selected Picture, Metafile, or PDF Box can be edited in a variety of ways using the buttons on the edit toolbar. See “The Edit Toolbar” on page 23.

3D Backdrops

A backdrop is an image, typically of an exterior view, that displays in the background of 3D views to help place the model into a realistic setting and add a sense of perspective.



The backdrop in this view includes hills and clouds

Backdrops automatically adjust to fit each view window, so they look best when they are created with a height to width ratio that is similar to the window you are working in.



You can create digital photos of a building site for use as a backdrop.

Specifying a Backdrop Image

Backdrop images are view specific. You can select a backdrop image for a camera view from the library in either of two ways:

- In a 3D view, open the Library Browser. Select a Backdrop image, then move your mouse pointer  into the view window. Click anywhere in the view to apply the selected backdrop.
- Open the **Camera Specification** dialog, and on the BACKDROP panel, click the **Select Backdrop** button. See “3D Backdrop Panel” on page 317.

When a backdrop image is not applied, Home Designer Suite applies a background color instead. This color can be specified on the BACKDROP panel of the **Camera Specification** dialog, as well.

The **Use Generated Sky** option produces a special Spherical Panoramic Backdrop that simulates a daytime sky using the Generic Sun.

Backdrop Defaults

By default, Home Designer Suite uses backdrop images in Full Cameras only. You can, however, specify which types of views use backdrops by default, and also select the default backdrop images for each, in the **Camera Tools Defaults** dialogs. See “Camera Defaults Dialogs” on page 303.

Similarly, backdrop images are only used by default in Standard renderings. You can choose whether a backdrop is used in either technique in the **Rendering Technique Options** dialog. See “Rendering Technique Options” on page 323.

Adding New Backdrops

A new backdrop image can be created using a variety of graphic file formats and can be imported into Home Designer Suite in several ways:

- Select **File> Import> Backdrop**  to open the **Import Backdrop File** dialog, which is similar to the **Import Picture File** dialog. See “Importing Pictures” on page 330.
- Right-click on the User Catalog and select **New> Backdrop** from the contextual menu.
- Copy and paste an image into Home Designer Suite. See “Copying and Pasting Objects” on page 70.

Backdrop Specification Dialog



To open the **Backdrop Specification** dialog, select **File> Import> Import Backdrop** or right-click on the User Catalog in the Library Browser and select **New> Backdrop** from the contextual menu. See “Adding New Backdrops” on page 334.

You can also open this dialog by right-clicking on a backdrop image in the User Catalog in the Library Browser and selecting **Open**  from the contextual menu.

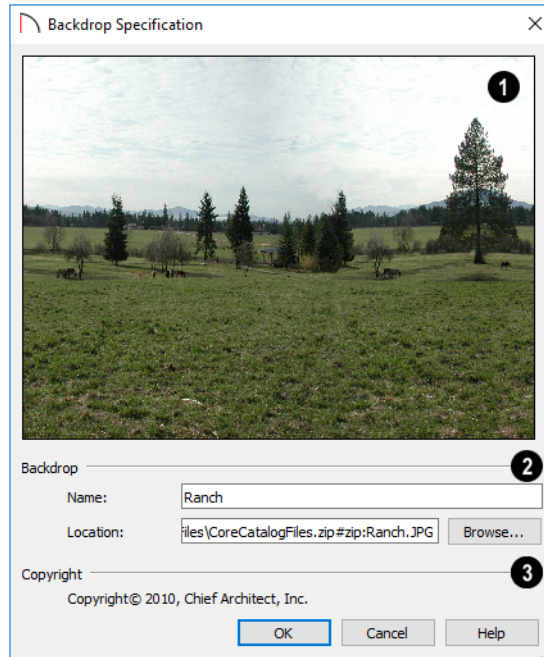

- 1 A preview of the selected image displays here.
- 2 **Backdrop** - Specify backdrop's Name and the image file associated with it.
 - Type a **Name** for the selected backdrop, to be used in the Library Browser and **3D View Defaults** dialog.
 - In the **Location** field, type the full pathname of the image file or click the **Browse** button and browse to the file on your computer. If the file is

not located in the Home Designer Suite 2021 Data folder, a copy of the file will be created at Home Designer Suite 2021 Data\Backdrops\My Backdrops and the program will reference that copy. See "Home Designer Suite Data" on page 32.

- 3 If the selected image has a **Copyright**, information about it will display here.

Walkthrough Paths



A 3D Walkthrough is a series of pictures saved as an **.mp4**, **.wmv**, or **.avi** file that can be played like a video by other applications such as Windows Media Player.



Create Walkthrough Path

There are several ways to create a walkthrough along a path, but the **Create Walkthrough Path** tool is the fastest and most flexible option.

To create a Walkthrough Path

1. Begin by choosing a codec for recording walkthroughs. See "Selecting a Codec" on page 339.
2. In plan view, select **3D> Walkthroughs> Create Walkthrough Path** , then click and drag

to draw a Walkthrough Path. See "To use the Spline tool" on page 107.

3. Edit the direction and curvature of the spline's segments, as needed. See "Editing Spline-Based Objects" on page 90.
4. Add **Key Frames**  to the path and modify their specifications.
5. Select the path and click the **Record Walkthrough Along Path**  edit button. See "Record Walkthrough Along Path" on page 337.



Walkthrough Paths can follow stairs and ramps to span multiple floors. See "Walkthrough Paths and Stairs" on page 336.

You can also create a walkthrough based on a regular CAD polyline or spline by selecting it and clicking the **Record Walkthrough Along Path**  edit button. This was the only way to record a walkthrough along a path in Home Designer Suite versions and does not provide as many options as using a Walkthrough Path.

Walkthrough Paths display in plan view when the “Walkthrough Paths” layer is turned on. When displayed, Walkthrough Paths display in front of other objects and will print. They are included in views exported to **.dxf**. See “Layers” on page 74.

Key Frames

Key Frames are points along a Walkthrough Path that allow you to change:

- Camera direction, tilt angle, and height;
- Changes in walkthrough speed;
- The floor that the walkthrough is on.

These changes are applied as the camera moves along the Walkthrough Path from one Key Frame to another.

To add a Key Frame to a Walkthrough Path, select the path and click the **Add Key Frame**  edit button. Then click on the path to add a Key Frame at that location.

In plan view, each Key Frame is represented by a camera symbol centered along the walkthrough path. It displays the frame number, is pointed in the direction of its **Camera Angle**, and its position along the path corresponds to its **Time** setting.



Key Frame **Time**, **Angle**, and other properties can be edited in the **Walkthrough Path Specification** dialog. See “General Panel” on page 339.

You can also use the **Edit Key Frames**  edit tool to enable Move and Rotate edit handles for each Key Frame on the selected Walkthrough Path.

To use the Edit Key Frames edit tool

1. Select a Walkthrough Path and click the **Edit Key Frames**  edit tool.

2. Each Key Frame on the selected Walkthrough Path will display a Move and Rotate edit handle.
 - Click and drag the square Move handle to reposition the Key Frame along the path.
 - Click and drag the rectangular Rotate handle to change the Key Frame’s direction angle
3. When you are finished adjusting the Key Frames, click the **Main Edit Mode**  edit tool to restore the Walkthrough Path’s normal edit handles.

Walkthrough Paths and Stairs

If you draw a Walkthrough Path up or down a staircase or ramp, it will follow the height of the stairs or ramp and continue on the next floor.

To create a multiple floor walkthrough

1. Draw a Walkthrough Path so that it extends into a staircase or ramp in the same direction as its Direction Arrow. See “Displaying Stairs, Ramps, and Landings” on page 237.
 - Do not drag the Walkthrough Path across the entire length of the stairs or ramp. If you do, its height will remain relative to the current floor.
2. When you release the mouse button, the program will automatically display a dashed line with an arrow extending past the last Key Frame on the current floor.
 - If it follows stairs or a ramp going upward, the path will also extend to the top end of the staircase or ramp.
3. Go up or down one floor, select the Walkthrough Path, and resize and reshape it as needed. You can use the **Create Walkthrough Path**  tool to draw more segments and additional Key Frames can be added, as well.

Playing a Walkthrough

Once a walkthrough has been recorded, it can be played using a media player.

To play a walkthrough

1. Select **3D> Walkthroughs> Play Walkthrough**  to open the **Select Video File** dialog.
2. Browse to the **.mp4**, **.wmv**, or **.avi** file on saved on your computer. Your default video application plays the walkthrough video.

Recording a Walkthrough

There are two approaches to recording a walkthrough of a plan:

- Select a path in plan view, then direct the program to record a walkthrough along that path.
- Create a 3D view, then begin recording and use the Move Camera tools to navigate through the view.

Record Walkthrough Along Path

Once a Walkthrough Path has been drawn, you can use it to record a walkthrough video. See “Create Walkthrough Path” on page 335.

To record a walkthrough along a path

1. In plan view, select a Walkthrough Path or a CAD polyline or spline.
2. Click the **Record Walkthrough Along Path**  edit button.
3. In the **Walkthrough Options** dialog, specify the desired Quality, Resolution, Rendering Options, and Video Codec, then click OK.

Note: You can specify your preferred settings, including Frame Rate and Compression, in the Walkthrough Defaults dialog. See “Default Settings” on page 47.

4. In the **Save Video As** dialog, specify a name and saved location for your walkthrough file. The available file type will vary depending on the Codec you are using. See “Exporting Files” on page 36.
5. When you click Save, a camera view will open, showing the progress of the recording.

To cancel the recording as it is being created, press the ESC key on your keyboard.

Walkthrough Options Dialog

Most of the settings in this dialog are also found in the **Walkthrough Defaults** dialog.

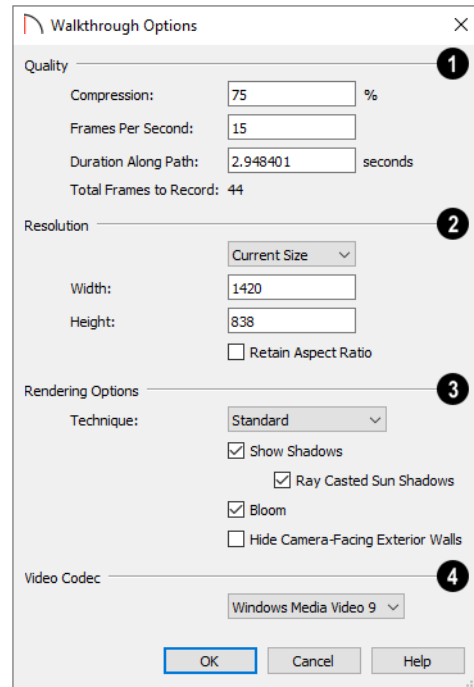

1 The **Quality** settings control the compression and total number of individual frames in the walkthrough.

- Specify a **Compression** percentage between 0 and 100. A value of 0 gives the highest quality images and largest file sizes.
- Specify the desired number of **Frames Per Second**, between 1 and 100. A higher number results in a higher quality recording but also a larger video file.
- Specify a **Duration Along Path**, in seconds.
- The **Total Frames to Record** displays for reference and equals the Frames Per Second times the Duration along Path.

2 The **Resolution** settings control the size of the walkthrough’s frames.

- Select a size from the drop-down list. “Current Size” is selected by default. If you modify the Width or Height below, “Custom” will become selected.
- The current **Width**, based on the selected Resolution, is stated here. If you change this value, the selected Resolution will become “Custom”.
- The current **Height**, based on the selected Resolution, is stated here. If you change this value, the selected Resolution will become “Custom”.

- Check **Retain Aspect Ratio** to retain the original ratio between the frame Width and Height. If you modify either value while this is unchecked, the walkthrough may appear distorted.

3 Rendering Options -

- Select the walkthrough's **Rendering Technique** from the drop-down list. See "Rendering Techniques" on page 323.
- Check **Show Shadows** to turn on shadows in the walkthrough. See "Shadows" on page 319.
- Check **Ray Casted Sun Shadows** for higher quality shadows cast by sun light. Ray Casted Sun Shadows take longer to generate than regular shadows.
- **Bloom** occurs around areas of intense light and looks as though the light is 'bleeding' beyond the edges of a light source. It adds realism to the view but takes longer to render. Only available when a Rendering Technique that supports lighting is selected above.
- Check **Hide Camera-Facing Exterior Walls** to suppress the display of any exterior walls that face the camera. Interior walls set as Attic walls are also suppressed. This setting only has an effect when the walkthrough path is on the exterior of a structure.

Note: Reflections will be used in a walkthrough if they are enabled in the Full Camera Defaults dialog when the walkthrough is recorded. See "Full Camera Defaults" on page 304.

- 4 Select a **Video Codec** from the drop-down list. This setting is retained between sessions and is also global, affecting all walkthroughs in all plan files. See "Selecting a Codec" on page 339.

When you click OK, the **Save Video As** dialog will open, allowing you to specify the name, location, and file format for the walkthrough file. The available file formats may vary, depending on which codec you selected.





Frame by Frame Walkthroughs

You can also create a walkthrough by recording it frame by frame. Although time-consuming, creating a walkthrough in this manner lets you see exactly what is being recorded as you record it.

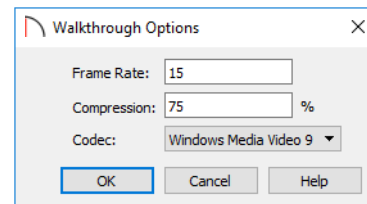
To record a walkthrough frame by frame

1. Create a camera view. This view is the first frame of the walkthrough.
2. While the camera view is active, select **3D> Walkthroughs> Record Walkthrough** .
3. In the **Walkthrough Options** dialog:



- Select a **Frame Rate** between 1 and 100. The value entered is the number of frames per second.
 - Select a **Compression Percent** between 0 and 100. A value of 0 gives the highest quality images and the largest file size.
 - Select a **Codec** from the drop-down list. See "Selecting a Codec" on page 339.
 - Click OK.
4. In the **Save Video As** dialog, specify the name, location, and file format for the walkthrough file, then click **Save**. The available file formats will vary, depending on the codec you selected.
 5. Use the camera movement tools to navigate the view. Each time the screen redraws, it is recorded as the next frame in sequence. See "Editing 3D Views" on page 311.
 6. To move the camera without saving a view, select **3D> Walkthroughs> Pause Recording**  to temporarily stop recording.
 - You can then select **3D> Walkthroughs> Save Frame**  button to control what views are saved.
 - You can start recording again by selecting **Pause Recording**  once more.
 7. When the walkthrough sequence is complete, select **3D> Walkthroughs> Stop Recording**  or close the view.

Note: Zooming in and out and using the scroll bars does not change the viewpoint and does not produce a frame for the walkthrough.

If you resize the current view window while recording a walkthrough, the program will stop recording.

Selecting a Codec

A codec is a utility that compresses and decompresses media files, and is used when both recording and viewing videos such as walkthroughs. When you record a walkthrough in Home Designer Suite, you can choose which of the codecs installed on your system you want to use. This selection is universal and is retained between program sessions: when you choose a codec in either **Walkthrough Options** dialog, it will become selected the next time

you open either dialog, even if you do so in another plan.

“Windows Media Video 9” is the default codec in the Windows version and “H.264”, in the Mac version; but any codecs installed on your system will be available to use.

To choose the codec that best suits your needs, it is a good idea to create a test walkthrough using each of the codecs installed on your system to see how well their walkthrough quality and file compression meet your requirements. Note that your choice of codec may affect the file formats in the **Save Video As** dialog.

For more information about codecs, visit HomeDesignerSoftware.com.

Walkthrough Path Specification Dialog



Select a Walkthrough Path and click the **Open Object** edit button to open the **Walkthrough**

Path Specification dialog. See “Walkthrough Paths” on page 335.

General Panel

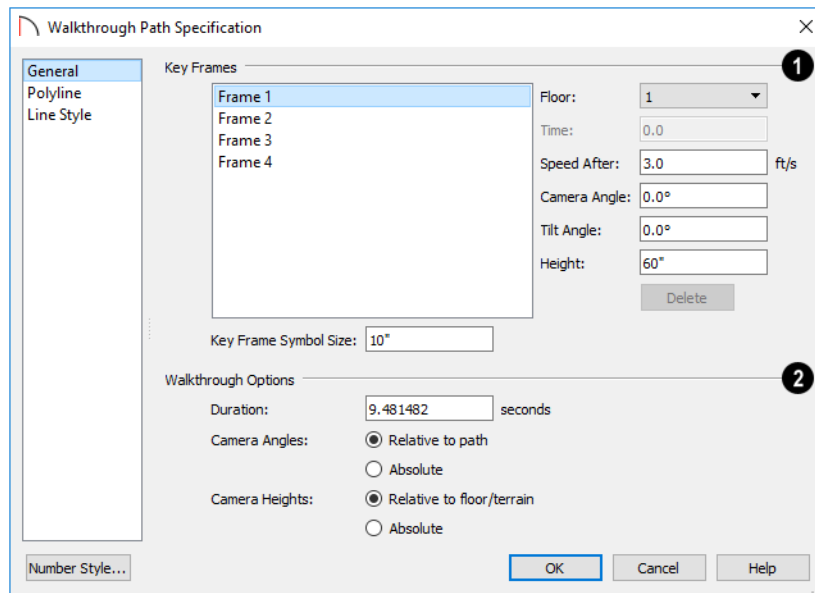

1 A list of the selected path’s **Key Frames** displays on the left. Click on a Frame in the list to select and edit it using the settings on the right. When the dialog is opened, the last key frame edited in the current program session will be selected automatically. See “Key Frames” on page 336.

- Specify the **Floor** that the selected Key Frame is located on. See “Multiple Floors” on page 227.

- Specify the **Time** in seconds at which the selected Key Frame is found in the duration of the walkthrough. Frame 1 is always at 0.0 and cannot be moved; similarly, the last frame is always at the end of the walkthrough Duration.
- Specify the **Speed After (ft/s)**, which is how fast the camera moves along the walkthrough path from the current Key Frame to the next. Not available if the last Key Frame is selected.

- Specify the **Camera Angle** at the selected Key Frame.
- Specify the **Tilt Angle** of the camera at the selected Key Frame.
- Specify the **Height** of the camera at the selected Key Frame.
- Click the **Delete** button to remove the selected Key Frame from the path.
- Specify the **Key Frame Symbol Size**, which is the size of the symbols representing the selected walkthrough path's Key Frames in plan view. See "Key Frames" on page 336.

2 Walkthrough Options -

- Specify the **Duration**, or total length of the walkthrough video in seconds.

Specify how **Camera Angles** are measured:

- Select **Relative to Path** to measure each camera angle relative to the direction of the walkthrough path at each Key Frame location.
- Select **Absolute** to measure each camera angle relative to the plan's X, Y, and Z axes. See "3D Drafting" on page 19.

Note: When Relative Angles are used, a Camera Angle of 0° points in the direction of the walkthrough path. When Absolute Angles are used, 0° always points in the positive direction along the X axis.

Specify how **Camera Height** is measured:

- Select **Relative to Floor/Terrain** to measure camera height relative to the floor or terrain at each Key Frame location.
- Select **Absolute** to measure camera height relative to the plan's Z axis.

Polyline Panel

The POLYLINE panel states the length of the path's **Perimeter**. The **Area** and **Volume** of a walkthrough path will always be described as "Not closed". See "Polyline Panel" on page 106.

Line Style Panel

This panel is similar to the LINE STYLE panel in the **Line Specification** dialog. See "Line Style Panel" on page 103.

Importing and Exporting

Importing is the process of opening a file that was produced in a different program in Home Designer Suite. Exporting, on the other hand, is the process of saving information in a Home Designer Suite file to a format that can be read by another program.

Home Designer Suite allows you to import and export a variety of information from and to other applications. This chapter focuses on exporting 2D .dwg/.dxf files and importing a variety of 3D file formats. Other importing and exporting options are described in the chapters in which those objects or settings are discussed.

Chief Architect Account Login

Your online Chief Architect Account allows you to take advantage of a variety of valuable resources including catalog downloads, license management, and technical support. See “Creating a Chief Architect Account” on page 14.

In order to export a 3D model to a Chief Architect 3D Viewer, export a 360° Panorama image file, or import a drawing from the Room Planner mobile app, you must first log in your Chief Architect account. See “Export Chief Architect 3D Viewer File” on page 342, “Export 360 Panorama” on page 348, and “Import Room Planner File” on page 343.

If you try to do any of these tasks while you are logged out of your account, the **Chief Architect Account Login** dialog will open, giving you an opportunity to log in.

You can also log into or out of your online account at any time by selecting **Help> Log in to Chief**

Chapter Contents

- Chief Architect Account Login
- Export Chief Architect 3D Viewer File
- Import Room Planner File
- DXF vs DWG File Formats
- Exporting 2D DXF/DWG Files
- Additional 2D Export Information
- 3D Data Import Requirements
- Importing 3D Symbols
- Symbol Specification Dialog
- 3D Symbols and Materials
- Export 360 Panorama

Architect Account or Help> Log out of Chief Architect Account.

Chief Architect Account Login Dialog

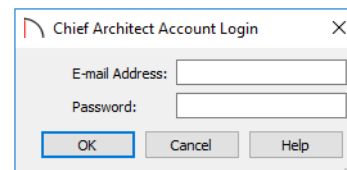

When importing a Room Planner file, use the same **E-mail Address** and **Password** that you used to save the drawing to the cloud in Room Planner.

When exporting a Chief Architect 3D Viewer or 360° Panorama file, use the **E-mail Address** and **Password** that you use to log in to the account on our website that is associated with your software product key.

Export Chief Architect 3D Viewer File

 The **Chief Architect 3D Viewer** allows a model created in Chief Architect to be viewed in either:

- A web browser on a computer.
- The 3D Viewer app on a mobile device.

In order to export a Chief Architect 3D Viewer file, you must be logged in to your Chief Architect cloud account.

For more information about the Chief Architect 3D Viewer, visit HomeDesignerSoftware.com.

To export a file to the cloud for viewing with either option, select **File > Export > Export Chief Architect 3D Viewer File**  while a 3D view is active.

Any light sources that are On in the current view, as well as ambient light, will be exported along with the model. See “Lighting” on page 320.

3D Viewer Export Options

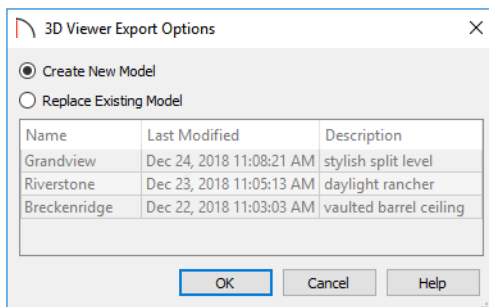

- Select **Create New Model** to export a new model without affecting any previously exported files.
- Select **Replace Existing Model** to select a previously-exported model in the list and replace it with the model being exported now.
- To select an existing model to replace, click on its line item in the list.

When you click OK, the **Export 3D Viewer File** dialog opens, where you can specify the exported model’s name, description, and other details.

Export 3D Viewer File Dialog

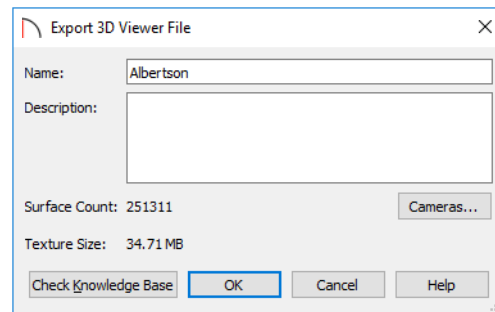

- The **Name** of the current plan file populates this field by default. Specify a different name for the exported 3D Viewer file if you would like.
- Type a brief **Description** of the model.
- Click the **Cameras** button to open the **Select Cameras to Export** dialog and specify which saved cameras to export with the model. See “3D Views” on page 303.
- The **Surface Count** and **Texture Size** display here for reference. Large Surface Count and/or Texture Size values can impact performance in the app.

 To reduce Surface Count and Texture Size, consider turning off unnecessary layers in the current 3D view before exporting. See “Layers” on page 74.

When you click OK, the 3D model is exported using the layer settings in the camera view that was active when the model was exported.

On the 3D Viewer page, you can also choose to share an exported model with someone so that it can be opened in a 3D Viewer page or in the 3D Viewer mobile app.

Select Cameras to Export Dialog

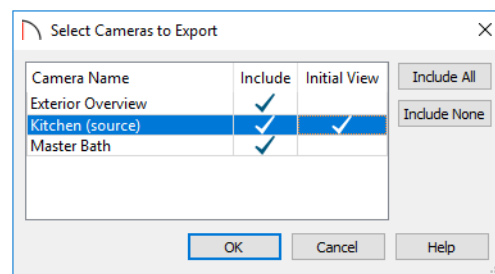

- The **Camera Name** of each saved Perspective Camera and Overview in the plan is listed here. The camera that is active when you export the model, if listed, is followed by “(source)”. Doll House Views can be exported; however, they behave like Full Overviews in the 3D Viewer.
- In the **Include** column, click to add or remove a check mark for each camera that you would like to export. By default, only cameras of the same type, on the same floor, and using the same layer set are Included.
- In the **Initial View** column, add a check mark for the camera that you would like to be active when the model is opened in 3D Viewer.
- Click the **Include All** button to export all saved cameras with the model. A large number of saved cameras may slow down the interface of the 3D Viewer app.
- Click the **Include None** button to export no saved cameras with the model. When the model is opened, an unsaved 3D Overview will be the initial view.

Import Room Planner File



Select **File> Import> Import Room Planner File**, then select and download a Room Planner file from the cloud. When prompted to log in, use the same credentials you used to save a plan to the cloud in Room Planner.

Files created in Room Planner version 2 and newer can be imported into Home Designer Suite 2021.

Note that the exterior walls in an imported Room Planner drawing will inherit their thickness and other properties from the **Exterior Wall Defaults** dialog in

the current plan, while interior walls will retain the thickness that was set in Room Planner. See “Exterior and Interior Wall Defaults Dialogs” on page 110.

Unless a custom ceiling height has been specified in Room Planner, rooms in an imported file use the Default ceiling height set in the **Floor Defaults** dialog. See “Floor Level Defaults” on page 132.

Visit roomplanner.chiefarchitect.com for more information about the Room Planner mobile app.

DXF vs DWG File Formats

.dwg is the native AutoCAD® file format. Originally a proprietary format, it is now widely used with many different products.

.dxf (Drawing eXchange Format) is a standard file format created by Autodesk for the transfer of data between other programs.

Many design programs can read and write **.dxf** and **.dwg** files. Both formats interpret data as CAD objects such as lines, polylines, and circles.

Binary **.dxf** format is another related file format. It is easier for computers to read, is more accurate, and occupies less disk space and regular **.dxf** files. When exporting, however, bear in mind that not all applications support binary **.dxf**.

Exporting 2D DXF/DWG Files

Line-based 2D files can be exported from Home Designer Suite in both **.dxf** and **.dwg** file formats. You can specify the version of AutoCAD® to export to. Compatibility with other software may vary.

There are two ways to export a 2D drawing file in Home Designer Suite: Export Current View and Export All Floors.

Export Current View



To export a plan view that is currently active, select **File> Export> Current View (DWG/DXF)**.

Export All Floors



To export the plan view for all floor plans simultaneously, select **File> Export> All Floors (DWG/DXF)** from any floor of the plan. The floor plans are exported to a single **.dxf** or **.dwg** file.

If you choose to export all floors, the file will contain all floors superimposed on each other. Upon export, each layer in your Home Designer Suite drawing is divided into separate layers: one for each floor. For example: “Electrical-2” contains objects on Floor 2 that were originally on the “Electrical” layer.

Export Drawing File Dialog

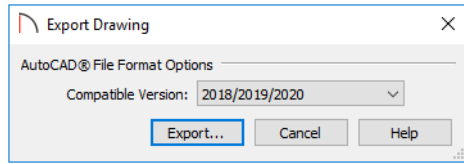

Additional 2D Export Information

The export process converts high level Home Designer Suite objects (doors, windows, etc) into simple, CAD-based objects (lines, arcs, etc). Home Designer Suite exports all data to AutoCAD®'s Model Space.

Supported Entities

The following entity types are currently supported for 2D export:

Line - The simplest entity. In AutoCAD®, lines are 3 dimensional with the Z coordinate set to zero.

Arc - Arcs have a start angle, end angle and radius.

Circle - Fully Supported.

Multi Line Text - If exporting to an AutoCAD® release that supports multi-line text, Home Designer Suite writes the file as multi-line text. If exporting to a version that does not support multi-line text, the file is written as simple text.

Polylines - Polylines are a collection of points with lines or arcs connecting them. Home Designer Suite supports both lines and arcs. Arcs are referred to as bulges in AutoCAD®.

Block Insert - A block insert is a reference to a block, which is a named collection of entities. A block can also contain block inserts.

Dimensions

Each dimension has an associated block containing a representation of the dimension as it is drawn in Home Designer Suite. It also contains all the data to recreate that information.

- When an exported dimension is modified in AutoCAD® or other CAD program, its appearance changes.
- Home Designer Suite does not support arrowhead styles or fonts.

Specify which **Compatible Version** of AutoCAD® you want your **.dwg/.dxf** file to be compatible with.

Click the **Export** button to save the exported file as a **.dwg** or **.dxf** file. See “Exporting Files” on page 36.

- Three kinds of dimensions are generated: Aligned, Rotated and 3 Point Angular.
- Please refer to AutoCAD® documentation for more information.

Note: Uncheck “Use Associative Dimensions” in the Export Drawing File dialog if the CAD program you are using does not support AutoCAD® Associative dimensions. See “Export Drawing File Dialog” on page 344.

Layers

Layers in other systems are similar to Home Designer Suite layers, but there are some subtle differences. Layer information is mapped as follows:

Home Designer Suite	Other Systems
Name	Name
Color	Nearest AutoCAD® Color. Home Designer Suite uses the default AutoCAD® color table to determine this mapping.
Display	On
Size	Line Weight. In AutoCAD®, line weights are determined by a table of mm line widths. Home Designer Suite maps to the closest match in this table based the current view's Line Weight Scale. See “Drawing Sheet Setup Dialog” on page 384.
Style	Line type
Lock	Lock

Line Types

A line type, or line style, is used by layers and entities to determine how lines are drawn. Home Designer Suite line types installed with the program are supported on export.

3D Data Import Requirements

Importing a symbol that can be used by Home Designer Suite is a relatively simple process that begins with previously created 3D data. This 3D data often comes from a program other than Home Designer Suite. If you use another 3D modeling program to create the 3D data, be aware of the following requirements before attempting to create symbols.

 Home Designer Suite does not provide support for any third party software.

There are a number of requirements that must be met before any 3D data can be used to create a symbol in Home Designer Suite:

- The 3D data must be stored in an, object (**.obj**), 3D Studio[®] Mesh (**.3ds**), COLLADA (**.dae**), or SketchUp version 2019 and prior (**.skp**) file format. If you have 3D data in another format, you must convert it into one these formats first.
- Geometry and material information stored in **.3ds** files are imported; cameras and lights are not.
- The 3D model must be composed of 3DSOLID solid entities, or face data. Faces are typically referred to as 3D faces, polygonal faces, or poly meshes. Other types of entities such as lines, curves, circles, polylines, and free form surfaces can exist in the file but are not imported when the symbol is created. This is true for all (**.obj/.3ds/.skp**) file types.
- The face data should be assigned to different layers so that you can map them to the correct materials when viewing them in 3D. It is helpful to name your layers using a convention that identifies that materials should be assigned to each sub-component.
- Pay attention to the origin and orientation of the 3D data when designing symbols. Home Designer Suite allows some adjustment when creating the symbol, but it is easier to build the 3D data cor-

rectly before importing it into Home Designer Suite. For more information about defining the origin, see “Symbol Origin” on page 191.

- If a symbol with faces that have more than four vertices is imported, the faces are truncated, resulting in an object that appears to have holes. The best remedy is to re-export the model from the original application using only triangular or quadrilateral faces.
- Home Designer Suite does not support grouped objects in symbols imported from **.3ds** files.

Surface Normals

If you use third party software to create an **.obj/.3ds/.skp** file that will be imported as a symbol, you should be familiar with the concept of surface normals.



A surface normal is a vector that is perpendicular to the plane of a surface. This vector points in one direction, determined by the way the face is drawn.



If a face is drawn clockwise, the surface normals are directed outward; if a face is drawn counter-clockwise, the surface normals point inward. Home Designer Suite assumes that the face on the positive side of the normal vector is the outside face.

Many objects can be drawn using only one side of each face. A cube is a good example: the inside of a cube is not visible, so it is not necessary to create its inside faces. When inside faces are not calculated, 3D views in Home Designer Suite can generate more quickly.

Importing 3D Symbols

 Home Designer Suite supports the import of 3D surface and 3D solid objects saved in **.3ds**, **.obj**, **.dae**, and **.skp** formats.

There are three ways to import a 3D symbol into Home Designer Suite:

- By selecting **File> Import> Import 3D Symbol**  tool.
- By selecting **New> 3D Symbol**  from the contextual menu in the Library Browser. See “Using the Contextual Menus” on page 273.

- By dragging and dropping the file from an operating system window into plan view.

Symbols imported by clicking and dragging are imported for use in the current plan, while those imported using the **Import 3D Symbol** dialog are also saved in the library. See “The Library” on page 271.

To drag and drop a 3D symbol file

1. Open the plan in which you would like to import a 3D symbol and remain in plan view.
2. Open an operating system window in front of the Home Designer Suite program window.

3. Resize and position the window so that the Home Designer Suite program window can be seen behind it.
4. Click on the desired **.3ds**, **.obj**, **.dae**, or **.skp** file and drag it into the Home Designer Suite program window.
5. When your cursor changes to a +, click in the drawing area to place as many copies of the symbol as desired. When you are finished, select a different tool.

Symbols imported by clicking and dragging cannot be edited in the **Symbol Specification** dialog. If a symbol needs to be rotated, or its unit of measurement specified, use the **Import 3D Symbol**  tool to import it.

Symbol Specification Dialog



To import a symbol object, select **File> Import> Import 3D Symbol**.

Home Designer Suite supports the import of 3D surface and 3D solid objects saved to **.3ds**, **.obj**, and **.skp** formats and treats imported symbols as stand alone fixtures.

The **Import 3D Symbol File** dialog, which opens first, is a typical **Open File** dialog in which multiple files can be group-selected for import. See “Importing Files” on page 38.

The **Symbol Specification** dialog opens next.

3D Panel

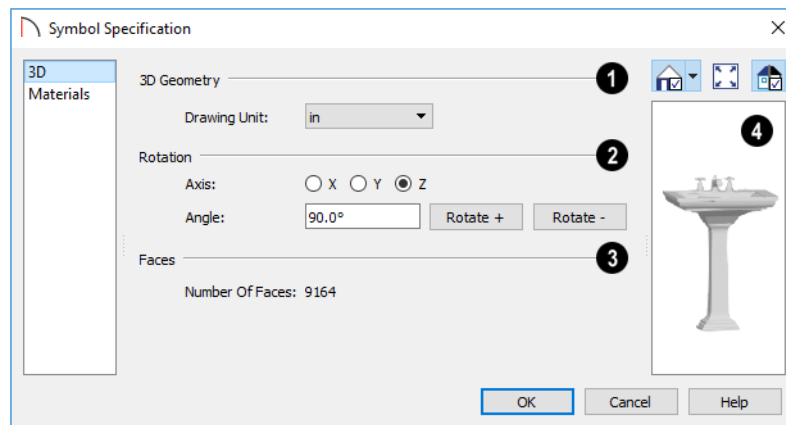

- 1 **3D Geometry** - Select the **Drawing Unit** that was used to create the symbol. If any units other than inches or mm are selected, the program will convert the data into units appropriate for Home Designer Suite.

Note: SKP files are always imported using inches, regardless of the default units used in the plan file. See “Creating a New Plan” on page 33.

- 2 The **Rotation** settings allow you to rotate the selected symbol about the X, Y, and Z axes.
 - Select the **X**, **Y**, or **Z Axis**.
 - Specify the **Angle** to rotate the symbol in the text field. 90° is set by default.
 - Click the **Rotate +** or **Rotate -** button to rotate the object around the selected axis in a clockwise or counterclockwise direction, respectively.

- ③ The **Number of Faces** that the symbol has displays here for reference. When multiple symbols are being imported, nothing displays. Although there is no limit to the number of surfaces that a symbol can have, large numbers can increase the rendering time for 3D views significantly.
- ④ A preview of the symbol's appearance displays here and updates as changes are made to the settings in this dialog. When multiple symbols are

selected, the most recently selected symbol displays. See “Dialog Preview Panes” on page 25.

Materials Panel

The MATERIALS panel allows you to assign materials to the symbol's components and is similar to the same panel in many specification dialogs. See “Materials Panel” on page 296.

3D Symbols and Materials

When a symbol is imported into Home Designer Suite, material definitions may be included with it. How material information is included depends on the symbol's file format. See “About Materials” on page 294.

OBJ Files

Material definitions for most **.obj** files are saved in a separate file with the **.mtl** file extension. If such a file exists, the materials associated with the **.obj** file display in the list on the left side of the MATERIALS panel of its specification dialog.

If Home Designer Suite does not receive material definition information in an accompanying **.mtl** file, default material properties are assigned.

Material definitions for **.obj** files can also include texture information in the form of image files (**.jpg**, **.png**, etc).

In order to properly import an **.obj** file, Home Designer Suite needs the **.obj** file, the **.mtl** file, and any referenced texture files. If a texture file is not available, the material it is associated with is created without a texture.

The material definitions associated with an imported **.obj** symbol are not available for use by other objects

in Home Designer Suite until that symbol has been placed into a plan. The associated texture files are then copied to the user's Textures folder. See “Home Designer Suite Data” on page 32.

3DS and DAE Files

Material definitions for **.3ds** and **.dae** files refer to texture information in separate image files.

In order to properly import a **.3ds** and **.dae** file, Home Designer Suite needs these referenced image files. If a texture file is not available, the material it is associated with will be created without it. The associated texture files are copied to the user's Textures folder.

SKP Files

The textures associated with a **.skp** file are saved in the file. After you import a symbol and either place it in a plan or add it to the Library, these textures are saved in the Home Designer Suite Textures folder.

Home Designer Suite does not support deformed textures. If a texture associated with a **.skp** file is deformed, it will be imported without the deformations.

Texture Filename Conflict

If a texture of the same name already exists in the plan when an **.obj**, **.3ds**, or **.skp** file is imported, the **Texture Filename Conflict** dialog displays.

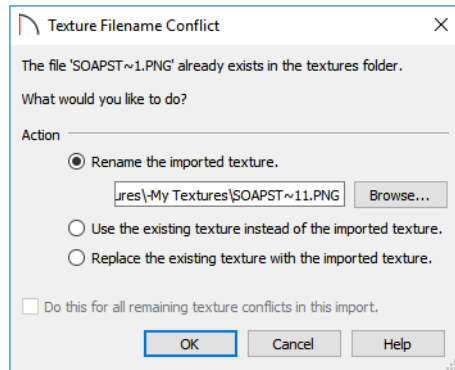

- Select **Rename the imported texture**, then click the **Browse** button to create a copy of the texture's image file with a new name that you specify.
- Select **Use the existing texture instead of the imported texture** to keep the existing texture.
- Select **Replace the existing texture with the imported texture** to replace the texture already present in the plan with the new, imported one.
- Check **Do this for all remaining textures in this object** to use the same selection for all textures with filename conflicts associated with this symbol.

Export 360 Panorama



The **Export 360 Panorama** tool creates a spherical panoramic image that can be opened in various panorama viewers. Select **File> Export> Export 360 Panorama** while a 3D view is active to access this tool.

For best results, position the camera as near as you can to the center of the scene before exporting.

Export 360 Panorama File

All of the settings in this dialog are retained during the current program session.

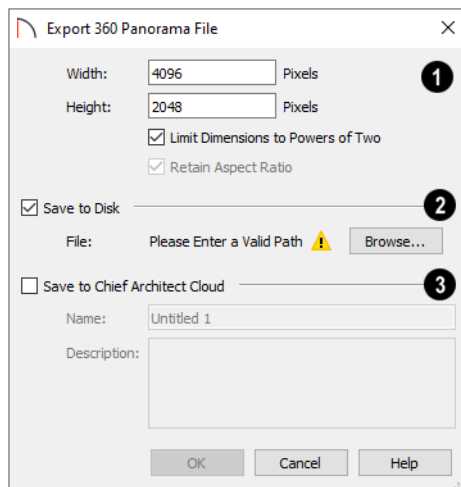

- 1 Specify the size of the exported image, in pixels.
- Specify the **Height** and **Width** of the exported image file, in pixels.
 - Check **Limit Dimensions to Powers of Two** to restrict the Width and Height to values that are powers of two. When this is checked and an in-

eligible value is entered, it will adjust up or down to the nearest power of two. Although not required, this option is recommended for best results in some panoramic image viewers.

- The **Retain Aspect Ratio** check box displays for reference and cannot be changed. The ratio between Width and Height is 2 to 1 when Limit Dimensions to Powers of Two is unchecked, above.
- 2 Check **Save to Disk** to save the exported panoramic image file on the local computer system.
 - 3 Check **Save to Chief Architect Cloud** to save the exported panoramic image file to your Chief Architect Cloud Account. See "Chief Architect Account Login" on page 341.
- Type a short, descriptive **Name** for the exported panoramic image file.
 - Type a brief **Description** of the file.

When you click OK, a panoramic image is created and a progress dialog may display. Because spherical panoramas are composed of multiple images stitched together, they may take longer to create than a standard exported picture.

Note: You can also upload a previously saved panoramic image file to the cloud on the 360 Panoramas page of your online account.

Terrain

Home Designer Suite allows you to model the terrain around a house. Begin by specifying elevation data that creates the surface contours, and then add surface features such as planting areas and water features.

You can import terrain data from a variety of sources and use this data to produce your 3D model.

Driveways, parking lots and sidewalks as well as plants and sprinklers are among the objects that can be placed in your terrain and are discussed in “Plants” on page 371 and “Roads, Driveways and Sidewalks” on page 367.

Terrain Perimeter



The Terrain Perimeter is a closed polyline defining the boundary of the terrain that generates in 3D views and of the contour lines that generate in plan view. Select **Terrain > Create Terrain Perimeter** to create a terrain perimeter.

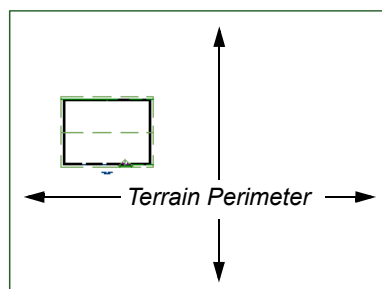

Chapter Contents

- Terrain Perimeter
- Elevation Data Tools
- Terrain Modifier Tools
- Terrain Feature Tools
- Garden Bed Tools
- Water Feature Tools
- Stepping Stone Tools
- Terrain Wall and Curb Tools
- Terrain Objects in the Library
- Displaying Terrain
- Editing Terrain Objects
- Importing Elevation Data



If you create a terrain perimeter in plan view but do not see it, select **Window > Fill Window** . See “Zoom Tools” on page 63.

Once created, the terrain perimeter can be resized and edited like other polyline-based objects. See “Editing Closed Polyline-Based Objects” on page 87.

When a terrain perimeter is first created, it is completely flat and is placed at a height of 0'-0", or sea level.



Terrain perimeter at 0' - 0" in a 3D view

The terrain perimeter by itself does not have elevation data associated with it. You can use the **Elevation Data**  and **Terrain Modifier**  tools to create terrain that slopes in a wide variety of ways. If you do not create elevation data within the terrain perimeter, the terrain remains flat at an elevation of 0' - 0". See "Elevation Data Tools" on page 350 and "Terrain Modifier Tools" on page 352.

Terrain Height vs Floor Height

Home Designer Suite always defines the default height of Floor 1 at 0'-0". This height value is the constant by which the heights of structural elements in the program like walls, floors, and ceilings are measured. The heights of architectural object can be measured relative this absolute height, as well. See "Floor 1 Default Height" on page 132.

The default height of Floor 1 is not, however, the absolute by which terrain elevation is measured. Instead, elevation data is measured relative to sea level. This means that if you want to, you can use real-world elevation data to generate a 3D terrain model without also having to measure floor and ceiling heights from sea level. See "Importing Elevation Data" on page 363.

The program automatically positions Floor 1 a set distance above the terrain. To do this, it first finds the

center point of the building footprint. Then, it determines the elevation of the terrain at that point.. Finally, it adds the thickness of the floor platform to this value plus either 6" (150 mm) or 8" (200 mm) depending on the foundation type. The resulting value, referred to as the automatic Subfloor Height Above Terrain, is how far the default height of Floor 1 is above sea level in the current plan. See "Foundations and the Terrain" on page 225.

The Subfloor Height Above Terrain distance is stated and can be modified in the **Terrain Specification** dialog. You can specify a custom value to produce a daylight or walkout basement. See "General Panel" on page 357.

Build Terrain



Select **Terrain > Build Terrain** to generate the terrain surface based on the provided elevation data. Build Terrain also updates the Building Pad Elevation value in the **Terrain Specification** dialog. See "Building the Terrain" on page 356.



The Terrain Perimeter has a variety of editable properties that affect the appearance of the terrain in 2D and 3D views. See "Terrain Specification Dialog" on page 357.

Elevation Data Tools



Select **Terrain > Elevation Data** to add elevation information to your terrain.

When terrain is generated, this data is used to calculate the surface of your site and is represented by contour lines in plan view and a curved surface in 3D. See "Displaying Terrain" on page 356.

Elevation data can be specified using the **Elevation Point** , **Elevation Line** , **Elevation Region**  tools.

Elevation data can also be imported. See "Importing Elevation Data" on page 363.

The elevation of each Elevation Line, Spline and Region is specified relative to sea level.

In order to create rising and/or falling terrain, multiple terrain data objects with different elevation values must be used. If only one terrain data object is

placed, the terrain will be flat regardless of the object's specified elevation.



To avoid unexpected results, do not draw Elevation Data objects with different elevation information at the same location.

Elevation Points



An **Elevation Point** contains the absolute elevation data for one point in the terrain model. Typically, Elevation Points are imported rather than placed manually.

Home Designer Suite requires many points to make an accurate approximation of your site. Even small sites may require over a hundred points to generate an accurate model of the terrain if it is sloped. For the sake of illustration, the following example shows only a few elevation points.

To place an elevation point

1. Select **Terrain> Elevation Data> Elevation Point**  and click in plan view at the point where you would like to place elevation data.
2. The **Elevation Point Specification** dialog opens. Enter an elevation value and click **OK**. See “Elevation Point Specification Dialog” on page 358.
3. Click somewhere else in plan view and the **Elevation Point Specification** dialog opens again with the last elevation value entered.

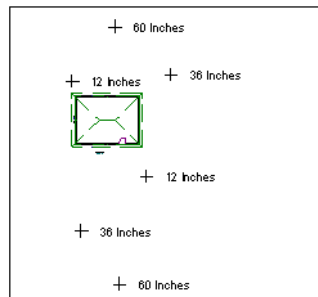

Elevation Points before terrain generation

4. Repeat steps 1, 2 and 3 to place additional elevation points with varied elevation values as needed.
5. Select **Terrain> Build Terrain** . See “Building the Terrain” on page 356.

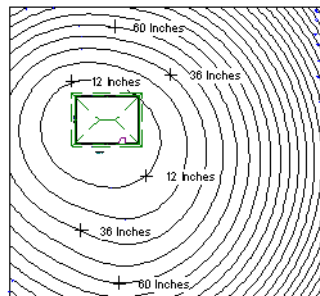

Contour lines after terrain generation



 Elevation Points are most effective when they are imported. When adding elevation data manually, use Elevation Lines instead. See “Importing Elevation Data” on page 363.

Elevation Lines

 An **Elevation Line** contains absolute elevation data for many points along a line at a

constant elevation. Elevation lines can be connected to create a polyline with many straight sections. For the sake of illustration, the images in the following example show single-section elevation lines.

To draw an elevation line

1. Select **Terrain> Elevation Data> Elevation Line** , then click and drag a line inside the Terrain Perimeter in plan view.
2. Click on the elevation line to select it, then click the **Open Object**  edit button.
3. At first, an elevation line is at elevation 0' - 0". In the **Elevation Line Specification** dialog, specify the desired elevation and click OK. See “Elevation Line/Region Specification Dialog” on page 359.
4. Repeat steps 2 and 3 to draw additional elevation lines as needed.

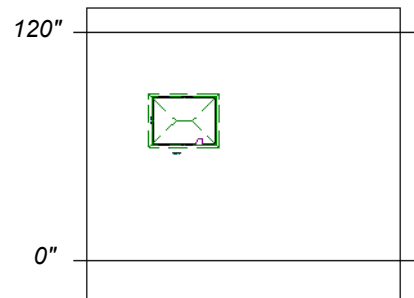

Elevation Lines before terrain generation

5. Select **Terrain> Build Terrain** . See “Building the Terrain” on page 356.

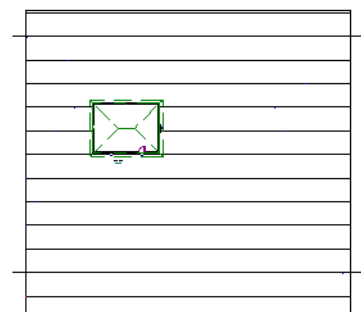

Contour lines after terrain generation

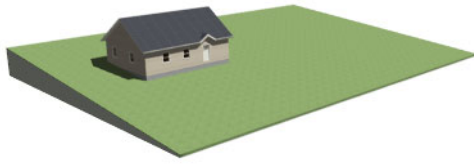



Full Overview after terrain generation

After it is drawn, an Elevation Line can be edited much the way other line-based objects can. See “Editing Line-Based Objects” on page 82.



Elevation Regions

 An **Elevation Region** contains absolute elevation data for an enclosed region and is ideal for creating a flat surface in your terrain.

To create an elevation region

1. Select **Terrain > Elevation Data > Elevation Region** .
2. There are two ways to add a Terrain Modifier to your plan:
 - Click once to place an 8' (0.6 m) square feature at that location.
 - Click and drag from end-to-end to draw a feature sized as needed. See “Draw Polyline” on page 102.
3. Click on the region to select it, then click the **Open Object**  edit button.
4. At first, an elevation line is at elevation 0' - 0". In the **Elevation Region Specification** dialog, specify the desired elevation and click OK. See “Elevation Line/Region Specification Dialog” on page 359.

After it is drawn, and Elevation Region can be reshaped much the way other closed polyline-based objects can. See “Editing Closed Polyline-Based Objects” on page 87.

An **Elevation Region**  can also be created by drawing a closed polyline using **Elevation Lines** .

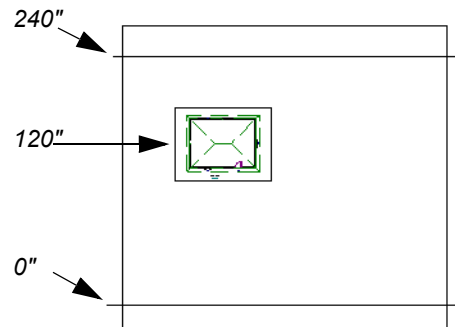

Elevation lines create a terrain grade; an elevation region creates a building pad.

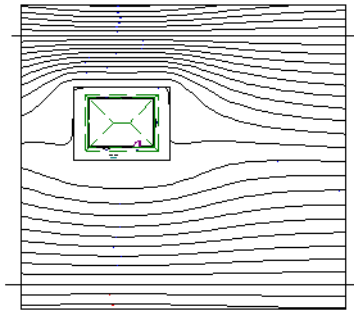

Contour lines after terrain generation

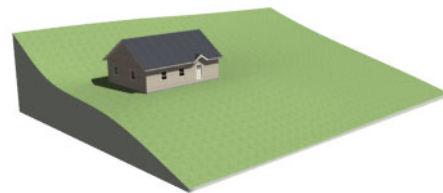



Full Overview after terrain generation

Terrain Modifier Tools

 Select **Terrain > Modifier** to access tools that allow you to modify the existing elevation data by drawing a closed polyline. Their height is relative to the terrain surface generated from the Elevation Data provided in your plan.

The elevation data associated with a Terrain Modifier only affects the terrain within its perimeter. The rest of the terrain is unaffected.

Raised and Lowered Regions

  The **Raised Region** tool creates a raised area with a top surface that is flattened like a plateau but follows the surface of the terrain. The **Lowered Region** tool creates a depression with a bottom that follows the terrain and is flattened.

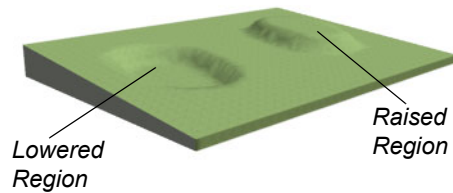

Hills and Valleys



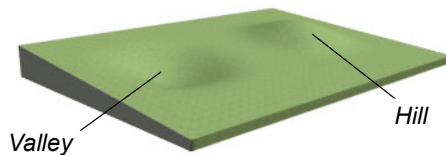

 The **Hill** and **Valley** tools create raised and lowered areas in the terrain that come to a point rather than flattening at their highest or lowest elevations.



Terrain Feature Tools

 Select **Terrain > Feature** to access tools for drawing bounded areas that follow the contours of the terrain rather than modifying them.

Terrain Features are useful for creating landscaping features because they have specified heights and materials. You can, for example, create paths and planting beds with gravel or mulch materials that stand out in a grassy Terrain Perimeter. See “Adding Terrain Features” on page 111 of the User’s Guide.

In fact, **Driveways** , **Garden Beds** , **Water Features**  and **Stepping Stones**  are special Terrain Features with material and height attributes already applied to them, saving you time when drawing these objects.

Terrain Features can only be drawn when a Terrain Perimeter is present, and will only display in 3D when they are drawn within the perimeter. See “Displaying Terrain” on page 356.

Terrain Features can be created in either of two ways:

- Click once to place a feature with endpoints that form a 10’ (4 m) square at that location.
- Click and drag from end-to-end to draw a feature sized as needed. See “Draw Polyline” on page 102.

Once created, Terrain Features can be edited into nearly any shape you require. See “Editing Closed

There are two ways to add a Terrain Modifier to your plan:

- Click once to place a modifier with endpoints that form a 10’ (4 m) square at that location.
- Click and drag from end-to-end to draw a feature sized as needed. See “Draw Polyline” on page 102.

Terrain Modifiers can only be drawn when a Terrain Perimeter is present, and will only display in 3D when they are drawn within the perimeter. See “Displaying Terrain” on page 356.

Once created, Terrain Modifiers can be selected and edited in a variety of ways. See “Editing Spline-Based Objects” on page 90.

Polyline-Based Objects” on page 87 and “Editing Spline-Based Objects” on page 90.

 Terrain Features can be drawn in 2D and 3D views.

Rectangular Features

 The **Rectangular Feature** tool can be used to create straight-sided features that can be edited into a wide variety of shapes.

Rectangular Features can also be edited like other closed polyline-based objects. See “Editing Closed Polyline-Based Objects” on page 87.

Round Feature

 The **Round Feature** tool can be used to create features with rounded edges and smoothly curved corners.

Round Features can be edited like other closed spline-based objects. See “Editing Spline-Based Objects” on page 90.

Kidney Shaped Features

 The **Kidney Shaped Feature** tool allows you to quickly create features with curved edges, smooth corners and a right angle bend in its shape.

Kidney Shaped Features can be edited like other closed spline-based objects. See “Editing Spline-Based Objects” on page 90.

For information about adding height and material information to Terrain Features, see “Terrain Feature Specification Dialog” on page 360.

Terrain Holes

By default, the program automatically cuts a hole in the terrain around any structures located within and

on the same floor as the Terrain Perimeter. The shape of these holes follow the exterior surfaces of the walls and will automatically update if any of those walls are moved.



A **Terrain Hole** is a Terrain Feature that cuts a hole in the terrain. **Terrain Holes** are useful for manually clipping the terrain around a foundation that does not match the footprint of the first floor.

Garden Bed Tools



Select **Terrain > Garden Bed** to access tools that can be used to place garden bed features in your terrain.

Polyline Garden Bed



This tool draws a garden bed with straight sides and four right angles. See “Rectangular Features” on page 353.

Round Garden Bed



Use this tool to draw garden beds with rounded edges and smoothly curved corners. See “Round Feature” on page 353.

Kidney Shaped Garden Bed



You can draw a kidney shaped garden bed with this tool. See “Kidney Shaped Features” on page 353.

Garden Beds are basically **Terrain Features** with material and height attributes typical of planting beds. See “Terrain Feature Tools” on page 353.

You can specify a Garden Bed’s material and height in its **Terrain Feature Specification** dialog. See “Terrain Feature Specification Dialog” on page 360.

In addition, you can choose to distribute copies of a plant image within a Garden Bed. See “Distributed Plant Panel” on page 360.

Water Feature Tools



Select **Terrain > Water Feature** to access tools for drawing ponds and streams in your terrain.

Ponds are basically **Terrain Features** with material and height attributes typical of bodies of water. See “Terrain Feature Tools” on page 353.

Similarly, Streams are Terrain Curbs with a water material. See “Terrain Wall and Curb Tools” on page 355.

Round Pond



Use this tool to draw a pond with rounded edges. See “Round Feature” on page 353.

Kidney Shaped Pond



This tool draws a kidney shaped pond. See “Kidney Shaped Features” on page 353.

Stream



Select the **Stream** tool, then click and drag to draw a stream. Streams are drawn and edited the same way that splines are. See “Draw Spline” on page 102 and “Editing Spline-Based Objects” on page 90.

Streams follow the contours of the terrain, so they may appear to flow uphill if they are not drawn correctly in the terrain. Try to draw them so that they follow a downward course for their entire length.

Once drawn, Water Features can be selected and edited just like any other Terrain Feature.

Specify the material and set the height of Water Features in their specification dialogs. See “Terrain Feature Specification Dialog” on page 360 and “Terrain Path Specification Dialog” on page 362.

Stepping Stone Tools



Select **Terrain > Stepping Stone** to place a walkway made of individual stepping stones.

Stepping Stones are basically **Terrain Features** with material and height attributes typical of walking paths. See “Terrain Feature Tools” on page 353.

There are two ways to draw Stepping Stones:

- Click once to place a stepping stone with end-points that form a 1’ (300 mm) square at that location.
- Click and drag from end-to-end to draw a stepping stone sized as needed. See “Draw Polyline” on page 102.

Terrain Wall and Curb Tools



Select **Terrain > Terrain Wall and Curb** to draw landscaping walls and curbs that follow the contours of the terrain.

Straight and curved Terrain Walls and Curbs are drawn just as other walls are. See “Creating Walls” on page 114.

Terrain Walls and Curbs are examples of Terrain Paths. Other examples include Sidewalks and Streams. See “Terrain Path Specification Dialog” on page 362.

Terrain Walls



Use the **Straight Terrain Wall** tool to draw a wall that sits on top of and follows the terrain.



Use the **Spline Terrain Wall** to draw a curved terrain wall. This wall is drawn the same way as a CAD Spline. See “Draw Spline” on page 102.

Once drawn, a Terrain Wall can be like other line-based objects. See “Editing Line-Based Objects” on page 82 and “Editing Spline-Based Objects” on page 90.

Terrain walls are 5’ (1500 mm) high and concrete by default, but you can specify the material, height and more in the **Terrain Path Specification**. See “Terrain Path Specification Dialog” on page 362.

Polyline Stepping Stone



The **Polyline Stepping Stone** tool draws rectangular stepping stones. See “Rectangular Features” on page 353.

Round Stepping Stone



The **Round Stepping Stone** tool draws stepping stones with rounded edges. See “Round Feature” on page 353.

Once drawn, Stepping Stones can be selected and edited just like any other Terrain Feature.

By default, Stepping Stones have a concrete material; however, you can specify the material and set the height of Stepping Stones in the **Terrain Feature Specification** dialog. See “Terrain Feature Specification Dialog” on page 360.

Retaining Walls



Use the **Straight Retaining Wall** tool draws a straight wall that holds back sloped terrain.



Use the **Curved Retaining Wall** tool to draw a curved retaining wall.

A Retaining Wall’s height is determined by the elevation of the terrain on each side. By default, the height of the wall matches the terrain on the high side of the break and the bottom matches the low side. If you insert a Retaining Wall into flat terrain, it looks like a concrete strip in 3D views.

Once drawn, a Retaining Wall can be edited much like other walls. See “Editing Walls” on page 119.

Terrain Curbs

Terrain Curbs are useful for creating curbs around planting beds and along paths, driveways and roads.



Use the **Straight Terrain Curb** tool to draw a straight landscaping curb.



Use the **Spline Terrain Curb** tool to draw a curved landscaping curb. This curb is drawn the same way as a CAD Spline. See “Draw Spline” on page 102.

Once drawn, a Terrain Curb can be like other line-based objects. See “Editing Line-Based Objects” on

page 82 and “Editing Spline-Based Objects” on page 90.

You can specify the height of straight and spline terrain curbs on the **GENERAL** panel of the **Terrain Path**

Specification. See “Terrain Path Specification Dialog” on page 362.

 You can also add Fencing to your terrain, complete with gates from the Doors Library. See “Fencing Tools” on page 112.

Terrain Objects in the Library



The Library Browser contains a variety of objects that can be placed in a plan’s terrain, including plants, exterior fixtures, accessories and

roadway objects. See “The Library Browser” on page 271.

Displaying Terrain



The display of terrain objects in 2D and 3D views is controlled in the **Display Options** dialog. See “Display Options Dialog” on page 74.

Like other objects, terrain objects are placed in Drawing Groups that affect whether they display in front of or behind other objects. You can modify a selected object’s place in the drawing order by

clicking the **View Drawing Group Edit Tools**  edit button. See “Drawing Group Edit Tools” on page 76.

You can customize appearance of Terrain Features, Roads and other terrain objects in plan view by changing their line and fill styles.

Plant images are represented in plan view by 2D CAD symbols. You can select a plant’s symbol in the **Plant Image Specification** dialog. See “Image Panel” on page 374.

When elevation data has been drawn or imported into a plan, contour lines will display in plan views. See “Elevation Data Tools” on page 350.

In 3D Views

In order for objects such as Terrain Features and Roads to be visible in 3D views, they must be drawn within the Terrain Perimeter. Any portions of these objects drawn outside of the Terrain Perimeter will not be seen in 3D views. See “Terrain Feature Tools” on page 353.

A variety of tools are available to help you adjust the perspective of your 3D views. See “Editing 3D Views” on page 311.

Building the Terrain



When terrain is generated, Home Designer Suite gathers all elevation data that has been added to the model and creates a terrain surface. The program interpolates the data to produce smooth contours.

A terrain perimeter with no additional elevation data drawn within it generates terrain that is flat at the elevation 0' - 0", or sea level.

The terrain is automatically built before a 3D view is generated. This process takes a variable amount of time, depending on the amount of elevation data and number of terrain features in the plan. The **Building Terrain** progress dialog displays as terrain is generated, sometimes only briefly, indicating the progress.

Terrain and 3D Drawing Time

Terrain is typically large with many surfaces, which often increases the drawing time of 3D views. The time required is affected by the amount of elevation data and number of terrain features present.

Lights and symbols can be placed outdoors and included in 3D views when the terrain is generated. These objects can also contribute to the time needed to generate 3D views. See “Rendering Tips” on page 319.

Editing Terrain Objects

Before a terrain object can be edited, it must be selected. All terrain objects can be selected in plan

view. In addition, the Terrain Perimeter and Terrain Features can be selected in 3D views. See “Selecting Objects” on page 79.

A selected terrain object can be edited using its edit handles, edit tools and specification dialog. See “Specification Dialogs” on page 25.

Any time elevation data is changed, the terrain must be rebuilt. This can be done by selecting **Terrain>**

Build Terrain , and occurs automatically when a 3D view is created.

Using the Edit Handles

Terrain objects can be moved, resized, and reshaped using their edit handles. How a selected object can be edited depends on what type of object it is. See “Editing Objects” on page 79.

- The Terrain Perimeter can be moved, resized, and reshaped like a polyline-based objects.
- Elevation Points can be moved in plan view using the Move edit handle.

- **Elevation Lines** are edited like other line-based objects.
- The shape of a **Raised Region**, **Lowered Region**, **Hill**, and **Valley** can be edited like a spline.
- Terrain Features are edited like other spline- and polyline-based objects.

Using the Edit Tools

A selected terrain object can be edited in a variety of ways using the buttons on the edit toolbar. The edit tools available for a terrain object depends on the type of object selected. See “The Edit Toolbar” on page 23.



Note: If you copy terrain objects from one plan to another, you cannot view the pasted objects in 3D unless a Terrain Perimeter exists.

Using Dimensions

Like many other types of objects, terrain objects can be resized and moved using dimensions. For more information see “Moving Objects Using Dimensions” on page 154.

Terrain Specification Dialog

 The **Terrain Specification** dialog controls how your terrain is modeled, as well as its appearance. It can be accessed in any of two ways:

- Select the Terrain Perimeter and click the **Open Object**  edit button.
- Double-click the Terrain Perimeter using the **Select Objects**  tool.

General Panel

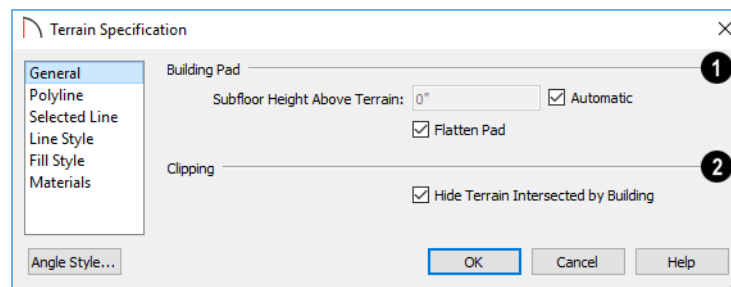

1 Specify how the **Building Pad** is generated beneath the structure. See “Foundations and the Terrain” on page 225.

- To specify the distance between Floor 1 and the terrain at the building footprint center, uncheck **Automatic** and enter a value in the **Subfloor Height Above Terrain** field.

- Check **Automatic** to have Home Designer Suite automatically lower the terrain relative to the first floor. See “Terrain Height vs Floor Height” on page 350.
- Check **Flatten Pad** to flatten the area beneath the building. To create a walkout basement, uncheck this box.

- 2 **Clipping** - Check **Hide Terrain Intersected by Building** to cut out the portion of the terrain that is intersected by the first floor footprint. Checking this box prevents the generation of contour lines inside the house.

Polyline Panel

The POLYLINE panel states the length of the Terrain Perimeter's **Perimeter**, its enclosed **Area**, and its **Volume**.

The settings on the this panel are available for a variety of other objects in the program. For information about these settings, see "Polyline Panel" on page 106.

Selected Line/Arc Panel

The SELECTED LINE panel is available when the selected edge is a line as opposed to an arc. See "Line Panel" on page 103.

The SELECTED ARC panel is available when the selected edge has been converted into an arc. See "Arc Panel" on page 104.

See, too, "Selected Edge" on page 80 and "Change Line/Arc" on page 96.

Line Style Panel

The settings on the LINE STYLE panel are available for a variety of other objects in the program. See "Line Style Panel" on page 103.

Fill Style Panel

The settings on the FILL STYLE panel affect the appearance of the Terrain Perimeter in plan view. See "Fill Style Panel" on page 76.

Materials Panel

The settings on the MATERIALS panel let you specify the terrain surface and terrain skirt materials used in 3D views. These materials are not calculated in the Materials List. See "Materials Panel" on page 296.

Elevation Point Specification Dialog

To open the **Elevation Point Specification** dialog, select an elevation point and click the **Open Object** edit button, or double-click on an Ele-

vation Point using the **Select Objects**  tool.

Use the **Elevation Point Specification** dialog to define the selected elevation point and control its appearance in plan view.

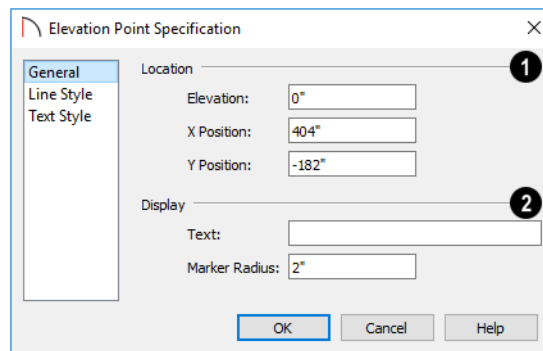

- 1 **Location** - Specify the exact location of the elevation point.
 - Specify the **Elevation** of the selected Elevation Point.
 - **X Position** - Enter the x coordinate of the elevation point.
 - **Y Position** - Enter the y coordinate of the elevation point.

- 2 **Display** -
 - In the **Text** field, type any notes that you would like to display beside the selected Elevation Point in plan view.
 - Enter the **Marker Radius**, which is the size of the point marker, measured from the center to an edge.



Line Style Panel

The settings on the LINE STYLE panel are available for a variety of other objects in the program. For information about these settings, see “Line Style Panel” on page 103.

Text Style Panel

The settings on the TEXT STYLE panel control the appearance of the selected Elevation Point’s text. For more information, see “Text Style Panel” on page 165.

Elevation Line/Region Specification Dialog

 To open the **Elevation Line** or **Elevation Region Specification** dialog, select one or more Elevation Line, or a polyline composed of elevation Lines, or an Elevation Region and click the **Open Object** edit button. You can also double-click an Elevation Line using the **Select Objects**  tool.

The **Elevation Line Specification** dialog is used to define the selected Elevation Line and controls its appearance in plan view.

The settings in this dialog are the same as those in the **Elevation Region Specification** dialog. See “Elevation Regions” on page 352.

Elevation Panel

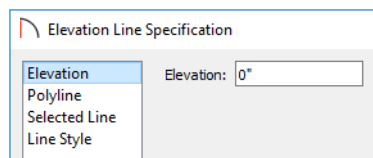

- Specify the **Elevation** of the selected Elevation Line, Spline, or Polyline.

Polyline Panel

The POLYLINE panel states the **Length** of an open polyline or the **Perimeter** of a closed polyline. If multiple Elevation Line segments form a closed Elevation Region, its Area will be calculated. Elevation Lines do not have a thickness, so they have no Volume.

Selected Line/Arc Panel

The SELECTED LINE panel is available when the selected edge is a line as opposed to an arc. See “Line Panel” on page 103.

The SELECTED ARC panel is available when the selected edge has been converted into an arc. See “Arc Panel” on page 104.

See, too, “Selected Edge” on page 80 and “Change Line/Arc” on page 96.

Line Style Panel

The settings on the LINE STYLE panel are available for a variety of other objects in the program. See “Line Style Panel” on page 103.

Hill / Valley Specification Dialog

 The **Hill/Valley Specification** defines the selected Hill or Valley and controls its appearance in plan view.

To open the **Hill/Valley Specification** dialog, select a Hill or Valley and click the **Open Object** edit button, or double-click the region(s) using the **Select**

Objects  tool.

Hill / Valley Panel

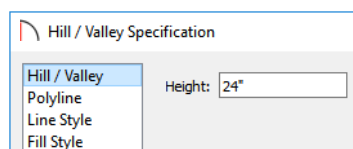

- Enter a **Height** for the selected Hill or Valley. This height is relative to the terrain surface that is generated from the Elevation Data in your plan. See “Terrain Modifier Tools” on page 352.

Polyline Panel

The POLYLINE panel states the length of the hill or valley’s **Perimeter** and its enclosed **Area**. Hills and Valleys do not have a volume measurement.

Line Style Panel

The settings on the LINE STYLE panel are available for a variety of other objects in the program. See “Line Style Panel” on page 103.

Fill Style Panel

The settings on the FILL STYLE panel affect the appearance of the selected object in plan view. See “Fill Style Panel” on page 76.

Raised / Lowered Region Specification Dialog

To open the **Raised/Lowered Region Specification** dialog, select a raised or lowered region and click the **Open Object** edit button, or double-click the region(s) using the **Select Objects** tool.

The **Raised / Lowered Region Specification** dialog is similar to the **Hill / Valley Specification** dialog. See “Hill / Valley Specification Dialog” on page 359.

Terrain Feature Specification Dialog

To open the **Terrain Feature Specification** dialog, select a Terrain Feature and click the **Open Object** edit button, or double-click the Terrain Feature using the **Select Objects** tool.

Most of the panels in this dialog are similar to those for a variety of other objects in the program,

including Water Features, Stepping Stones, Driveways, and Parking Lots.

Garden Beds are also a type of Terrain Feature and have an additional Distributed Plant panel in their specification dialog. Garden Beds also have a preview pane on the right side of their specification dialog.

General Panel

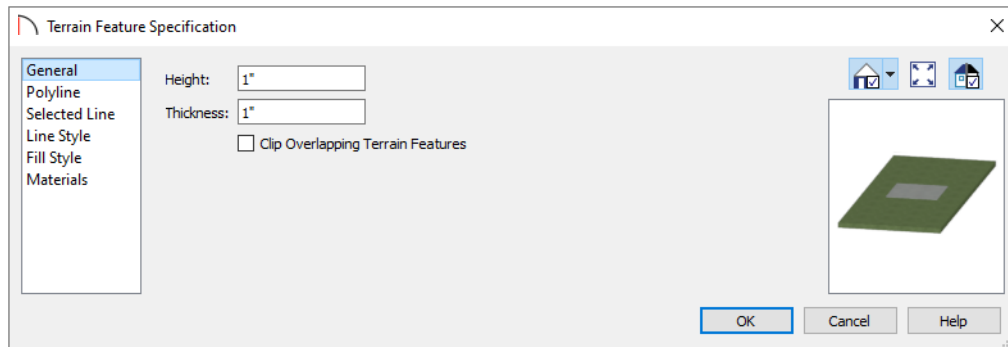

- Specify the top **Height** of the Terrain Feature, relative to the terrain surface, using a positive or negative number.
- Specify the feature’s **Thickness**.
- Check **Clip Overlapping Terrain Features** to suppress the 3D display of any part of the selected Terrain Feature intersected by other Terrain Features with a lower Height value. Clipping is useful for creating features that contain other features such as planters or swimming pools.

If a feature’s height above the terrain is greater than its thickness, the program will fill in the resulting gap.

Distributed Plant Panel

This panel is only available when the selected Terrain Feature is a Garden Bed. See “Garden Bed Tools” on page 354.

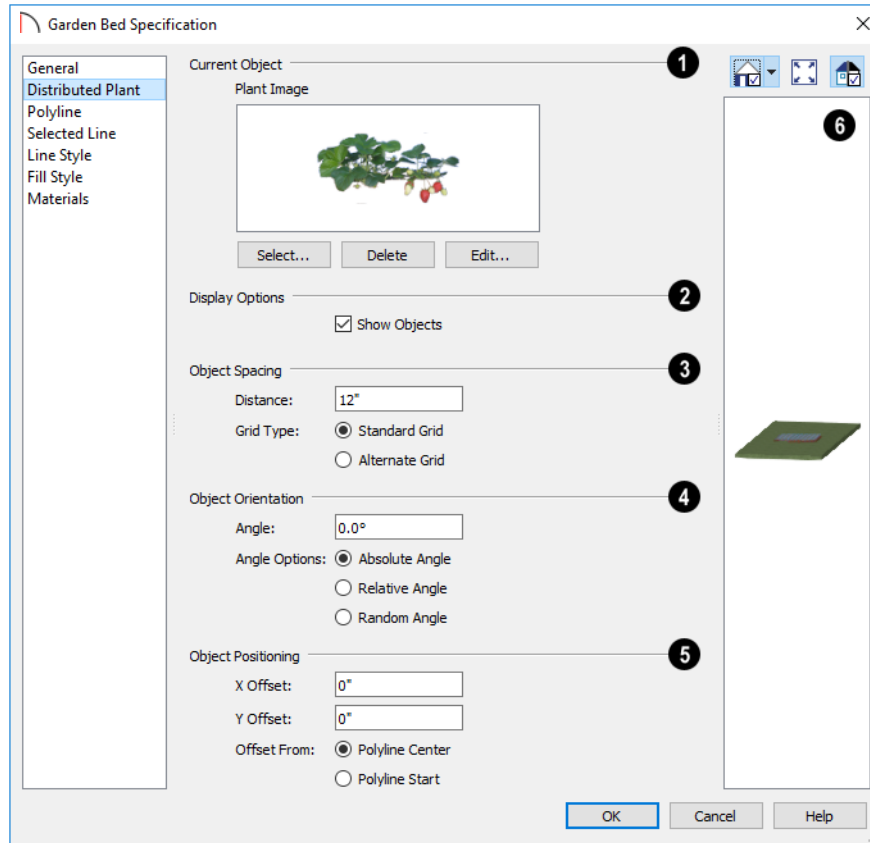

1 Specify the **Current Object** assigned to the selected garden bed. When an object is assigned, its name and a preview of a single instance of it display here.

- Click the **Select** button to choose an object from the library. See “Select Library Object Dialog” on page 283.
- Click the **Delete** button to unassign the Current Object from the selected garden bed.
- Click the **Edit** button to open the Current Object’s specification dialog. Changes made here affect all objects generated within the garden bed. See “Specification Dialogs” on page 25.



You can replace the plant assigned to a Garden Bed by applying a new one directly from the library. See “Replace From Library” on page 283.

2 **Display Options** -

- Check **Show Objects** to display the distributed objects in plan view.

3 **Object Spacing** - Specify how the objects in the garden bed are spaced.

- Specify the **Distance** between the objects in the garden bed, as measured from their center points.
- Select **Standard Grid** to position the objects in rows and columns based on the standard X/Y grid in the program.
- Select **Alternate Grid** to position the objects in rows and columns based on the shape of the garden bed.

4 **Object Orientation** - Specify how or if the objects in the garden bed are rotated. These settings do not affect the garden bed itself or its edges.



- Specify the **Angle** that the distributed objects should be placed at.
- Select **Absolute Angle** to rotate the objects to the specified Angle as measured from an imaginary horizontal line drawn from the origin towards the right.
- Select **Relative Angle** to rotate the objects relative to the angle of the region’s first edge or, if that edge is curved, to the angle of its chord. The first edge is typically located at the top of the garden bed when it is first created; however, this can change as the bed is edited.

- Select **Random Angle** to rotate the objects in the region at a variety of random angles.
- 5 Object Positioning** - Specify the positioning of the distributed objects relative to a point of origin within the garden bed.
- Specify the **X Offset**, the horizontal distance in plan view from the garden bed's specified point of origin.
 - Specify the **Y Offset**, the vertical distance in plan view from the garden bed's specified point of origin.
 - Select **From Polyline Center** to measure the offset from the garden bed's center point.
 - Select **Polyline Start** to measure the offset from the garden bed's start point. This start point is typically located at the top left of the garden bed when it is first created; however, this can change as the garden bed is edited.
- 6** A preview of the garden bed displays on the right side of the dialog box. See "Dialog Preview Panes" on page 25.

Polyline Panel

The POLYLINE panel states the length of the garden bed's **Perimeter**, its enclosed **Area**, and its **Volume**.

Garden Bed Specification Dialog

 To open the **Garden Bed Specification** dialog, select a Garden Bed and click the **Open Object** edit button or double-click the Garden Bed using the **Select Objects**  tool.

Terrain Path Specification Dialog

 To open the **Terrain Path Specification** dialog, select a Sidewalk, Stream, Terrain Wall or Terrain Curb and click the **Open Object** edit

Selected Line/Arc Panel

The SELECTED LINE panel is available when the selected edge is a line as opposed to an arc. See "Line Panel" on page 103.

The SELECTED ARC panel is available when the selected edge has been converted into an arc. See "Arc Panel" on page 104.

See, too, "Selected Edge" on page 80 and "Change Line/Arc" on page 96.

Line Style Panel

The settings on the LINE STYLE panel are available for a variety of other objects in the program. See "Line Style Panel" on page 103.

Fill Style Panel

The settings on the FILL STYLE panel affect the appearance of the selected object in plan view. See "Fill Style Panel" on page 76.

Materials Panel

The settings on the MATERIALS panel affect the appearance of the selected object in 3D views. See "Materials Panel" on page 296.

Because a Garden Bed is a type of Terrain Feature, the settings in this dialog are essentially the same as those in the **Terrain Feature Specification** dialog. See "Terrain Feature Specification Dialog" on page 360.

button or double-click the terrain path using the **Select Objects**  tool.

Most of the panels in this dialog are similar to those for a variety of other objects in the program.

General Panel

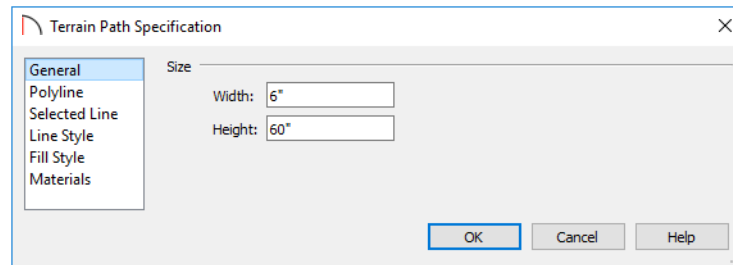

Size - Enter the **Width** of the object and the **Height** above the terrain. If the Height value is a negative number, the object sinks into the terrain.

See, too, “Selected Edge” on page 80 and “Change Line/Arc” on page 96.

Polyline Panel

The POLYLINE panel states the length of the Terrain Path’s **Perimeter**, its enclosed **Area**, and its **Volume**. See “Polyline Panel” on page 106.

Selected Line/Arc Panel

The SELECTED LINE panel is available when the selected edge is a line as opposed to an arc. See “Line Panel” on page 103.

The SELECTED ARC panel is available when the selected edge has been converted into an arc. See “Arc Panel” on page 104.

Line Style Panel

The settings on the LINE STYLE panel are available for a variety of other objects in the program. See “Line Style Panel” on page 103.

Fill Style Panel

The settings on the FILL STYLE panel affect the appearance of the selected object in plan view. See “Fill Style Panel” on page 76.

Materials Panel

The settings on the MATERIALS panel affect the appearance of the selected object in 3D views. See “Materials Panel” on page 296.

Importing Elevation Data

Elevation data can be added to a plan using the tools and techniques described in this chapter or it can be imported from a file.

Home Designer Suite can import elevation data saved in GPS Exchange (.gpx) and a variety of text file formats (.txt, .csv, .prn, .xyz, .auf and .nez). If your terrain data is not saved in one of these file formats, there are third party programs available that can convert to these formats.

Text Files

Elevation data can be saved in text files as x, y, and z coordinates where x and y define the location of a point on a Cartesian grid, and z defines the elevation for that point. Each data point must be on a separate line in the text file.

Importable text files can come from surveyors, other software programs, or you can create your own using a GPS system.

Elevation data saved in text files can be imported using the **Import Terrain Assistant**.

GPS Exchange Files

Elevation data in standard format .gpx files created using a GPS system can also be imported using the **Import GPS Data Assistant**. See “Import GPS Data Assistant” on page 365.

GPS data may include three types of points - Way, Track, and Route. Home Designer Suite can only import a .gpx file if it includes one or more Way Points, and cannot use Route Points at all. If a .gpx file does not include any Way Points, it will not be imported, and if it includes any Route Points, they will be ignored.

Home Designer Suite supports the import of data in standard .gpx files that adhere to the GPX 1.1 Schema. Files that do not follow this standard cannot be imported.

Import Terrain Assistant



The **Import Terrain Assistant** allows you to import elevation data saved in text (.txt) file format into a plan.

Each data point in this format has information about its X-axis (East to West location), Y-axis (North to South location), and Z-axis (elevation). It might also

have a brief description. In order to import elevation data from a text file, you need to know how the data in the file is organized.

To launch the **Import Terrain Assistant**, select **File> Import> Terrain Data** . Click **Next**.

Select File

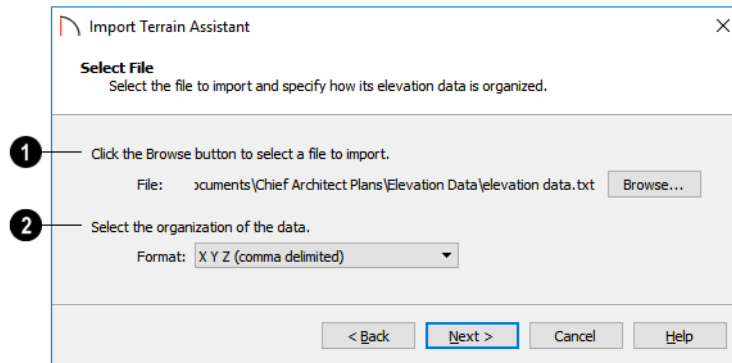

1 Select a file to import.

- Click the **Browse** button to locate a file on your computer. See “Importing Files” on page 38.
- If a file has been selected, its full pathname displays here for reference; if a file has not been selected, the directory of the last file imported displays. If the pathname is not that of a valid .txt file, this text will display in red.

2 Select the organization of the data.

Elevation information can be organized in one of six different ways, and can be separated by either a comma (comma delimited) or a space (space delimited).

- **XYZ** - Information in this format begins with the X coordinate, followed by the Y coordinate and the Z coordinate.

- **#XYZ** - Information in this format begins with a number that belongs to each data point followed by the X coordinate, the Y coordinate, and the Z coordinate.
- **#XYZ Description** - Information in this format begins with a number that belongs to each data point followed by the X coordinate, the Y coordinate, the Z coordinate, and a description.
- **YXZ** - Information in this format begins with the Y coordinate followed by the X coordinate and the Z coordinate.
- **#YXZ** - Information in this format begins with a number that belongs to each data point followed by the Y coordinate, the X coordinate, and the Z coordinate.
- **#YXZ Description** - Information in this format begins with a number that belongs to each data point followed by the Y coordinate, the X coordinate, the Z coordinate, and a description.

Click **Next** to continue.

Scale Data

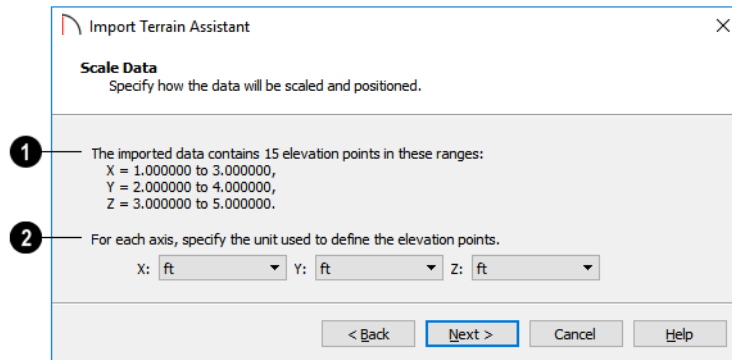

1 The total number of data points to be imported and the ranges of their coordinates are described here.

2 Select the **Units** of measurement used for each axis.

Click **Next** to finish.

Import GPS Data Assistant

 The **Import GPS Data Assistant** allows you to import terrain data from the standard **.gpx** file format. See “GPS Exchange Files” on page 363.

Select **File> Import> GPS Data** to open the **Import GPS Data Assistant**, then click **Next** to continue.

 Due to the lack of accuracy in some GPS systems, exact distances using the Import GPS Data Assistant are not guaranteed.

Select File

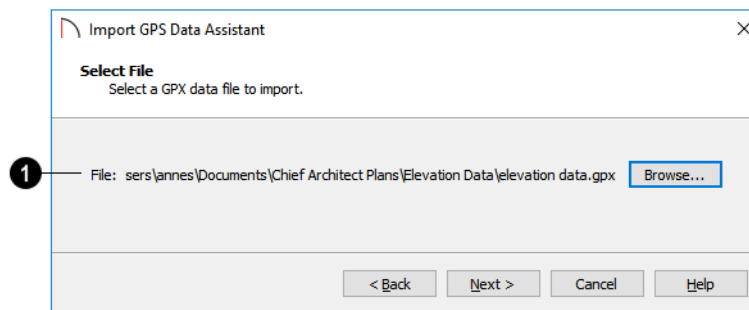

1 Select a file to import.

- Click the **Browse** button to locate a **.gpx** file on your computer. See “Importing Files” on page 38.
- If a file has been selected, its full pathname is reported here for reference; if a file has not been selected, the directory of the last file imported

displays. If the pathname is not that of a valid **.gpx** file, this text will display in red.

Note: Not all GPS programs use the standard .gpx file format; however, only files using the standard format can be imported.

Click **Next** to continue.

Import Data As

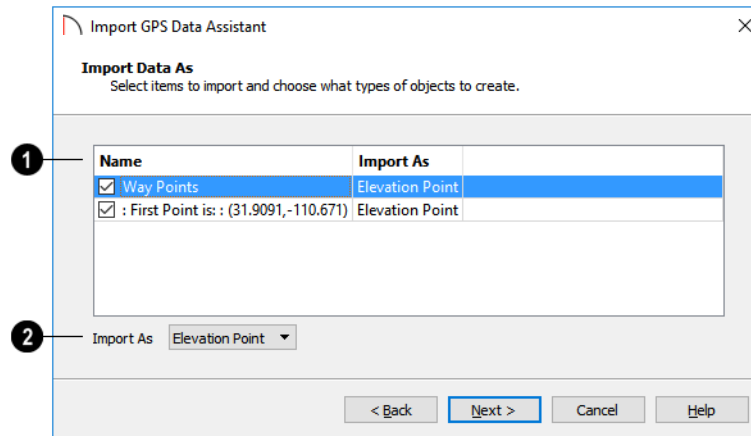

- 1 Specify which items you want to import by checking the box to the left of the **Name**. Items with unchecked boxes are not imported.
- 2 Specify what you would like the selected item to **Import As** from the drop-down list.
 - Only Way Points have elevation data associated with them. To import this data, import them as “Elevation Points”.
 - Select “Marker” to import either Way Points or Track Points as location markers. Markers have no elevation data associated with them.
 - Select “Polyline” to create an open CAD polyline based on the position of Way Points or Track Points. The points themselves are not imported. Polylines have no elevation data associated with them.

- Select “Terrain Perimeter” to create a closed Terrain Perimeter polyline based on the position of either Way Points or Track Points. The points themselves are not imported. A Terrain Perimeter has no elevation data associated with it. See “Terrain Perimeter” on page 349.

 Way Points are typically imported as “Elevation Data”, while Track Points are imported as “Markers”, “Polylines”, or “Terrain Perimeter”.

Click **Next** to finish.

If you do not see the imported terrain, select **Window > Fill Window** .

Roads, Driveways and Sidewalks

Roads and sidewalks are modeled in 3D like other terrain objects in Home Designer Suite. Because they have much in common with terrain objects and rely upon terrain data to be viewed in 3D, it is helpful to be familiar with terrain modeling before using these tools. See “Terrain” on page 349.

Road, Driveway and Sidewalk Tools



Road objects can be drawn in plan view, camera views and overviews, but only when a Terrain Perimeter exists in the plan. See “Terrain Perimeter” on page 349.

Straight and Spline road objects:

- Are typical line- and spline-based objects, and can be edited as such.
- Are flat along their widths, which makes it easy to create roads on sloping terrain.
- Can be joined end-to-end to form intersections and networks.
- Have a consistent width that can be defined in their specification dialogs. See “Road Specification Dialog” on page 369 and “Terrain Path Specification Dialog” on page 362.

Driveways and Parking Lots, on the other hand, are actually Terrain Features which follow the contours of the terrain rather than cut into them. They are drawn as rectangles but can be edited to any shape. See “Terrain Feature Tools” on page 353 and

Chapter Contents

- Road, Driveway and Sidewalk Tools
- Displaying Road Objects
- Editing Road Objects
- Road Specification Dialog

“Editing Closed Polyline-Based Objects” on page 87.

Once road objects have been placed, they can be edited individually or as a group. See “Editing Road Objects” on page 368.

Road Tools



Select **Terrain> Road and Sidewalk>**

Straight Road, then click and drag to draw a line within the Terrain Perimeter to draw a Straight Road.

The ends of multiple road sections can be connected together. Roads are edited along their center line and can be edited much like other line-based objects. See “Editing Line-Based Objects” on page 82.



Select **Terrain> Road and Sidewalk> Spline**

Road, then click and drag to draw a curved road composed of spline segments.

Spline roads are drawn and edited like other spline-based objects. See “Editing Spline-Based Objects” on page 90.

Sidewalk Tools

 To create a sidewalk with no curves, select **Terrain> Road and Sidewalk> Straight Sidewalk**, then click and drag a line within the Terrain Perimeter.

Sidewalks are edited along their center line like line-based objects. See “Editing Line-Based Objects” on page 82.

 Select **Terrain> Sidewalk> Spline Sidewalk**, then click and drag to draw a curved sidewalk composed of spline segments.

Driveway Area

 A **Driveway Area** is a terrain feature with a concrete material assignment. To create a driveway, select **Terrain> Road and Sidewalk> Driveway Area**, then click and drag from corner to

corner to draw a rectangle. See “Draw Polyline” on page 102.

Height, thickness and material information can be specified in a driveway’s specification dialog. See “Terrain Feature Specification Dialog” on page 360.

Driveways can be edited like other closed polylines. See “Editing Closed Polyline-Based Objects” on page 87.

Parking Lot

 A **Parking Lot** is a terrain feature with an asphalt material assignment. To place a parking lot, select **Terrain> Road and Sidewalk> Parking Lot**, then click and drag from corner to corner to draw a rectangle. See “Draw Polyline” on page 102.

Height, thickness and material information can be specified in a parking lot’s specification dialog. See “Terrain Feature Specification Dialog” on page 360.

Displaying Road Objects

 Roads and sidewalks display in floor plan and 3D views based on the settings in the **Display Options** dialog. See “Layers” on page 74.

In 3D Views



In order for Road objects to be visible in 3D views, they must be drawn within the Terrain Perimeter.

Any portions of these objects drawn outside of the Terrain Perimeter will not be seen in 3D views.

By default, the terrain rebuilds automatically when road objects are added, removed or edited. If it does not, you can select **Terrain> Build Terrain** . See “Terrain Perimeter” on page 349.





Editing Road Objects







Road objects can be selected in 2D and 3D views and edited using the edit handles, the edit toolbar and their specification dialogs.

Terrain Walls  and **Terrain Curbs**  are also examples of Road objects. See “Terrain Wall and Curb Tools” on page 355.

Using the Mouse

The edit handles available for a selected road object depend on the type of object selected.

- **Straight Roads** , straight **Terrain Walls** , straight **Terrain Curbs** , and **Straight Sidewalks**  are edited along their centerline like a line or open polyline. See “Editing Line-Based Objects” on page 82.

- **Spline Roads** , **Spline Sidewalks** , **Spline Terrain Walls** , and **Spline Terrain Curbs**  are edited along their centerline like CAD splines. See “Draw Spline” on page 102.
- **Driveway Areas**  and **Parking Lots**  are edited like other closed polyline based objects. See “Editing Closed Polyline-Based Objects” on page 87.

In the Specification Dialog

 Road objects can be customized in their specification dialogs. See “Road Specification Dialog” on page 369, “Terrain Feature Specification Dialog” on page 360, and “Terrain Path Specification Dialog” on page 362.

Using the Edit Tools

A selected road object can be edited in a variety of ways using the buttons on the edit toolbar. See “The Edit Toolbar” on page 23.

Road Specification Dialog



To open the **Road Specification** dialog, select a Straight Road or Spline Road and click the **Open Object** edit button.

Many of the settings in this dialog are similar to those in the **Terrain Path Specification** dialog. See “Terrain Path Specification Dialog” on page 362.

General Panel

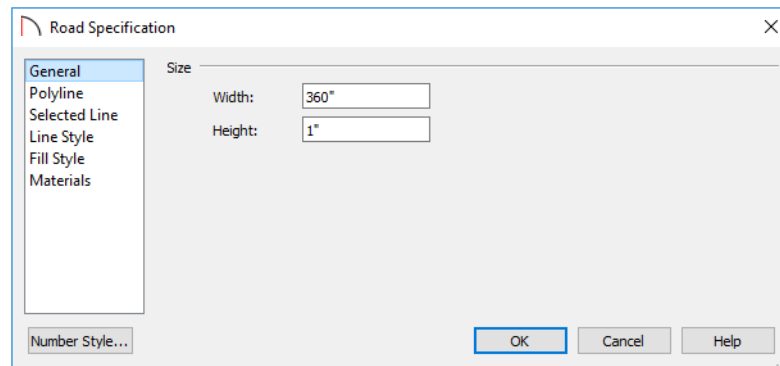

Size - Specify the **Width** and **Height** of the road relative to the terrain.

Polyline Panel

The **POLYLINE** panel states the length of the road’s **Perimeter**, its **Area** and its **Volume**. For more information, see “Polyline Panel” on page 106.

Selected Line/Arc Panel

The **SELECTED LINE** panel is available when a Straight Road is selected. For more information, see “Line Panel” on page 103.

The **SELECTED ARC** panel is available when the curved segment of a Straight Road is selected. See “Arc Panel” on page 104.

Line Style Panel

This panel is the same as the **LINE STYLE** panel in many other specification dialogs. See “Line Style Panel” on page 103.

Fill Style Panel

The settings on the **FILL STYLE** panel affect the appearance of the selected object in plan view. For information about these settings, see “Fill Style Panel” on page 76.

Materials Panel

The settings on the **MATERIALS** panel affect the appearance of the selected object in 3D views. For information about these settings, see “Materials Panel” on page 296.

The material selected here is not calculated in the Materials List. See “Materials Lists” on page 377.

Plants

The Plant Tools allow you to create planting designs in your terrain.

The Terrain Tools are discussed in their own chapter. See “Terrain” on page 349.

Plant Tools

 Select **Terrain> Plant** to add plants to your landscaping plan. Plants can also be placed in a plan directly from the library. See “Placing Library Objects” on page 281.

Plant objects are actually images, which provide realism while avoiding high 3D surface count. Once created, plant images can be selected and edited much like other image objects. See “Editing Images” on page 327.

 Select **Terrain> Plant> Plant Chooser** to open the **Plant Chooser** dialog and find plants based on their characteristics and requirements. See “Plant Chooser Dialog” on page 372.

 Select **Terrain> Plant> Create Plant Image** to create a plant image. Once a plant image is created, it can be added to the library for future use. See “Creating Images” on page 326.

 Select **Terrain> Plant> Show Hardiness Zones** to access regional climate zone maps. See “Hardiness Zones” on page 373.

Chapter Contents

- Plant Tools
- Plant Chooser Dialog
- Hardiness Zones
- Plant Image Specification Dialog

Garden Beds

 Garden Beds are special **Terrain Features** with material and height attributes typical of planting beds. In addition, you can choose to distribute copies of a plant image within a Garden Bed. See “Garden Bed Tools” on page 354.

Plants Library Catalogs

 In the Library Browser, browse to Home Designer Core Catalogs> Plants to access a selection of plant images. Select the library object you want, then click in any view to place it in the plan. See “The Library” on page 271.

A selection of Bonus Catalogs of plants is also available for download. See “Home Designer Bonus Catalogs” on page 276.

In addition, you can add plants to the library. See “Adding Library Content” on page 279.

Plant Chooser Dialog



Select **Terrain > Plant > Plant Chooser** or click the **Plant Chooser** button at the bottom of the Library Browser window to open the **Plant Chooser**.

Use this dialog to search the library for plant images that match your search parameters. You can search using any or all of the options in the **Plant Chooser**.

The search parameters in this dialog correspond to the settings on the PLANT INFORMATION panel of the **Plant Image Specification** dialog. See “Plant Information Panel” on page 375.

The screenshot shows the 'Plant Chooser' dialog box with the following details:

- Name:** Common Name: oak, Variety Name: (empty), Scientific Name: (empty), Pronunciation: (empty).
- Type:** Annual, Perennial/Biennial, Tree, Shrub, Bulb, Cactus/Succulent.
- Sub-Type:** Fruit, Vegetable, Herb, Nut, Turf, Ornamental Grass, Evergreen, Deciduous, Houseplant, Groundcover, Climber, Aquatic.
- Needs:** Sun (Sun, Cloud, Moon icons), Water (Water drop icons), Soil pH (pH scale icons), Hardiness Zone from: Unknown to: 15.
- Flowers and Foliage:** Flower Color (Color selection icons), Bloom Time (Season icons), Leaf Color (Color selection icons).
- Height:** From: 0"-12", To: 24+, Height at Maturity: 0", Starting Age: 0 months, Age at Maturity: 0 months.
- Special Characteristics:** Easy To Grow, Fast Growing, Self-Sowing, Container, Fragrant, Attracts Birds & Butterflies, Deer Resistant, Winter Interest, Cut Flowers, US Native/Wildflower, Fall Color, Attractive Foliage.
- Object Type:** 3D Plants, Plant Images, Both.
- Search Results:** A list of 30 items, with 'Turkey Oak' selected. The list includes various oak species and hydrangeas.
- Buttons:** Search, View Item, Close, Help.

- 1 Type the **Name** of a plant that you would like to find.
 - Specify the plant’s **Common Name**, **Scientific Name**, or its **Variety Name**.
 - A **Pronunciation** field is also provided. In the Plant Image Specification dialog, it is populated with a phonetic pronunciation guide for the plant’s scientific name.
- 2 Check one or more boxes to indicate selected plant **Type** to search for.
- 3 Check one or more boxes to specify the selected **Sub-Type** to search for.
- 4 Specify the plant **Needs** to search for. These include the **Sun**, **Water**, **Soil pH**, and **Hardiness Zone** range. See “Hardiness Zones” on page 373.
- 5 **Flowers and Foliage** -
 - Specify the **Flower Color** to search for. Multiple colors can be selected.

- Specify the **Leaf Color** to search for. Multiple colors can be selected
 - Specify the **Bloom Time** to search for, which is the season when the plant produces flowers.
- Specify the plant **Height** at maturity to search for.
 - An average mature height range can be entered using the **From** and **To** drop-down lists.
 - A specific **Height at Maturity** to search for can be entered in the text field.
 - A specific **Starting Age**, in months, can be entered in the text field.
 - A specific **Age at Maturity**, in months, can be entered in the text field.
 - Check one or more boxes to search for plants with **Special Characteristics**.
 - Select which types of plant **Object Type** to search for. 3D Plants are symbol objects, while Plant Images are two dimensional images.
 - Click the **Search** button at the bottom of the dialog to search for plants that meet your search criteria. The search results display to the right.
 - Your search results display here.
 - The **Number of Items** that match your search criteria is stated.
 - Specify whether you want the search results to use the **Common Name** or **Scientific Name**.
 - Click on the name of a plant in the list to see its location in the Library Browser.
 - Click the **View Item** button to see more information about the selected plant in the **Plant Information** dialog. See “Plant Image Specification Dialog” on page 373.

Hardiness Zones



Select **Terrain> Plant> Show Hardiness Zones** to view a selection of regional **Hardiness Zone Maps**. Click the drop-down list at the top left to select various regions.

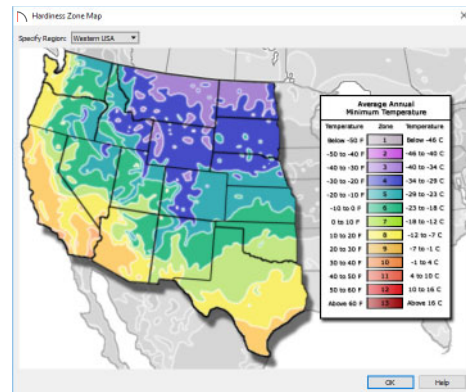

Plant Image Specification Dialog



Select a plant in a plan view or 3D view and click the **Open Object** edit button to open the **Plant Image Specification** dialog.

This dialog can also be accessed by selecting

Terrain> Plant> Create Plant Image .

The **PLANT INFORMATION** and **PLANT DESCRIPTION** panels are also found in the **Plant Information** dialog, which can be accessed from the **Plant Chooser** dialog. See “Plant Chooser Dialog” on page 372.

Image Panel

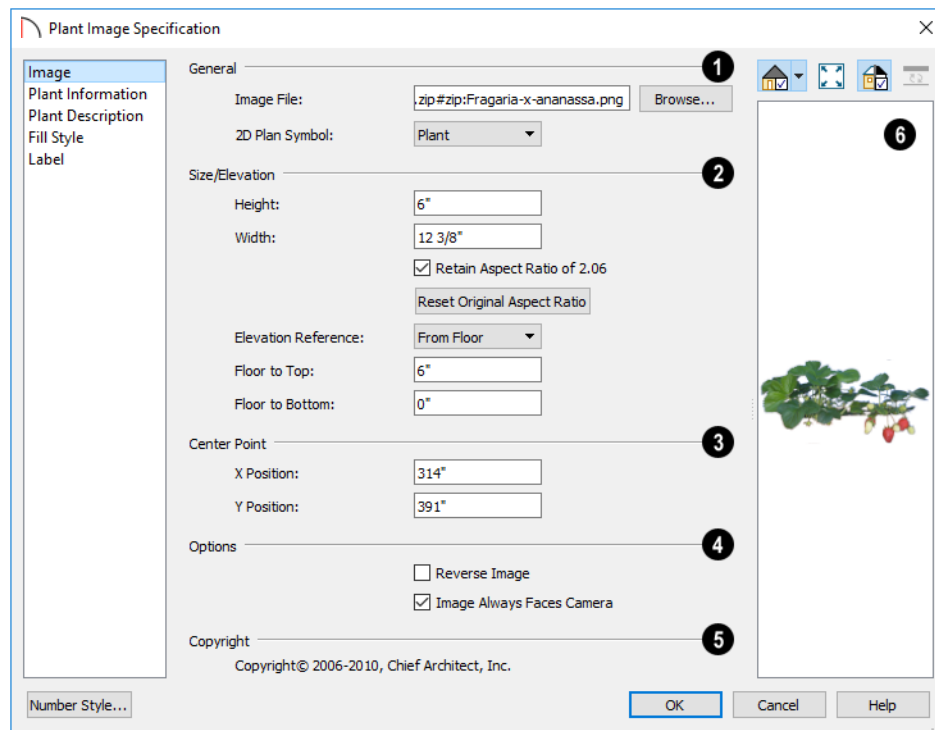

1 General -

- The path and name of the selected plant's **Image File** displays here.
- Click **Browse** to specify the saved location on your computer of the image that represents the plant in 3D views.
- A number of **2D Plant Symbols** are available to represent the image in plan view. Select one from the drop-down list.

- ### 2 Specify the **Size/Elevation** of the plant image, as seen in 3D views.
- Specify the **Height** and **Width** of the image.
 - When **Retain Aspect Ratio of** is checked, if you change either the Height or Width, the other value changes to maintain this ratio. If this is unchecked and you resize the plant image, it may become distorted.
 - Click **Reset Original Aspect Ratio of** to reset the image's original aspect ratio and remove any distortion caused by resizing.
 - Select the **Elevation Reference** from the drop-down list. This determines where the next two settings are measured from and also affects their setting labels.

- Specify the **to Top** distance, measured from the Elevation Reference to the top edge of the image.
- Specify the **to Bottom** distance, measured from the Elevation Reference to the bottom edge of the image.

3 Specify the location of the selected plant image's **Center Point**.

- Position the selected plant image in reference to the plan coordinates by specifying its **X Coordinate** and **Y Coordinate**.

4 Options -

- Check **Reverse Image** to reflect the appearance of the image about an imaginary vertical line through its center.
- Check **Image Always Faces Camera** to prevent the plant image from rotating with the camera.

5 If the selected plant image has been copyrighted, its **Copyright Information** displays here.

- ### 6 A preview of the selected plant image displays here. The Glass House Rendering Technique is not available for plant images. See "Dialog Preview Panes" on page 25.

Plant Information Panel

The settings on the Plant Information panel correspond to the search parameters in the **Plant Chooser**. See “Plant Chooser Dialog” on page 372.

Plant Description Panel

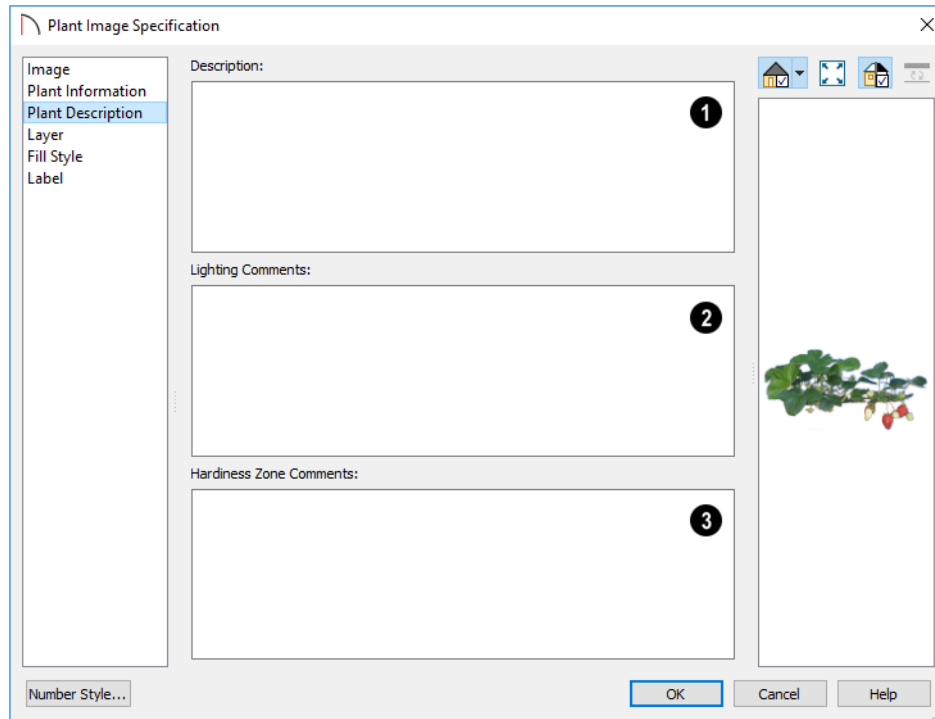

- ❶ A detailed **Description** of the plant displays in this text field.
 - ❷ Information in the **Lighting Comments** fields describes the plant’s light requirements.
 - ❸ **Hardiness Zone Comments** are given here. See “Hardiness Zones” on page 373.
- assigned to that layer. See “Label Panel” on page 166.

Fill Style Panel

The Fill Style panel controls the appearance of the selected plant’s 2D Plant Symbol in plan view. By default, plant images’ fill style is None (Transparent). For information about the settings on this panel, see “Fill Style Panel” on page 76.

If the plant’s 2D Plan Symbol does not form a closed shape, the settings on the Fill Style panel will have no effect on the appearance of the plant in plan view.

Label Panel

Plant labels display in plan view when the “Plants, Labels” layer is turned on and use the Text Style

Materials Lists

Home Designer Suite can calculate a Materials List in three ways: **for All Floors, From Area, or for Room.**

Materials Lists can be created, edited, and printed directly from the program. They can also be exported as text files for use in other programs.

 The Materials List's calculations are based on assumptions that may not match your building style. Home Designer Suite makes no representation as to the accuracy or reliability of the Materials List generated by Home Designer Suite. Always compare the Materials List with a manual take-off before providing a quote or ordering materials for a job.

The Materials List Tools



Select **Tools> Materials List** to access the Materials List tools.

A Materials List is like a snapshot of the current plan at the time that the list is made. Any changes made to the model after a Materials List is generated are not included in that list. Create a new Materials List if you would like it to include these changes.

It is not necessary to wait until the plan is complete to generate a Materials List. In fact, you can create a series of Materials Lists reflecting costs at various stages of a project.

Calculate from All Floors



Select **Tools> Materials List> Calculate Materials for All Floors** to generate a Materials List for the entire model.

Materials lists calculated from all floors can be lengthy, and only a portion of the list may display on your screen at one time. Use the scroll bars to scroll through the complete list. Move the pointer to cells in the list and click to make changes.

Calculate From Area



In plan view only, select **Tools> Materials List> Calculate From Area** to produce a Materials List for the portion of a plan on a single floor that is included within a temporary rectangular Materials List Polyline.

To use Calculate from Area

1. In plan view, select **Tools> Materials List> Calculate from Area** .
2. Click and drag to draw a rectangular marquee around the area of the current floor that you would like to produce a Materials List for.
3. When the mouse button is released, a Materials List for the area within the rectangle will display.

Calculate From Area rectangles are temporary and do not display in plan view after the list is created.

Calculate Materials in Room



To create the Materials List for a room, select the room and then select **Tools> Materials List> Calculate Materials for Room**.

Calculate Materials in Room is also available on a selected room's edit toolbar. See "Editing Rooms" on page 135.

A Materials List calculated from a room is created for only the contents of that room: wall materials are

not included. An object will be counted in the Materials List if its center point is located inside of the room.

Calculate Structural Materials for Deck



The structural materials for a selected deck can be calculated in a Materials List by clicking the **Calculate Structural Materials for Deck** edit button. See "Decks" on page 138.

Creating an Accurate Materials List

In order to take full advantage of Home Designer Suite's Materials List capabilities, there are several things to keep in mind.

- The accuracy of your Materials List is directly related to the accuracy of your model. Floor and ceiling heights, wall lengths, and structural settings all directly affect Materials List calculations.
- It takes more than just making your drawing look right to generate an accurate Materials List. If, for example, you use CAD lines to draw an item on a floor plan, that item will not be included in the Materials List. A better way would be to use a

symbol or structural element. See "Architectural vs CAD Objects" on page 67.

- Bear in mind that using generic objects like geometric shapes from the library to represent objects that aren't available in Home Designer Suite can result in items being calculated in the Materials List in a manner that you might not expect.

Framing in the Materials List

You can specify whether framing materials are calculated by lineal foot, as a cut list, or as a buy list in the **Structural Member Reporting** dialog.

Structural Member Reporting



The **Structural Member Reporting** dialog allows you to specify the method used to calculate framing members in the Materials List. There are four options to choose from:

- **Lineal Length** calculates the framing materials of the different structural components of the plan in linear feet.
- **Cut List** calculates the framing materials of the different structural components of the plan by

counting the individual pieces present in the model.

- **Buy List** calculates the framing materials of the different structural components of the plan by counting individual pieces and matching them to common board lengths.
- **Mixed Reporting** calculates framing materials using a combination of lineal lengths and piece counts and is recommended for saved Materials Lists in legacy plans.

Structural Member Reporting Dialog



To open the **Structural Member Reporting** dialog, select **Edit> Default Settings**, then select "Structural Member Reporting" from the tree

list and click the **Edit** button. See "Default Settings vs Preferences" on page 47.

You can also open this dialog by selecting **Tools> Materials List> Structural Member Reporting** .

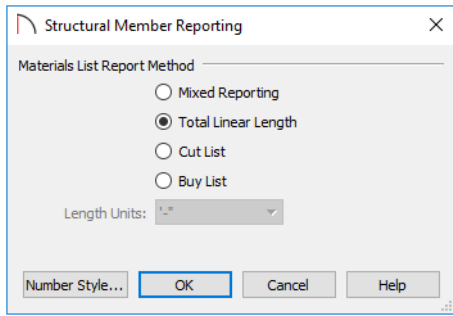

Choose a **Materials List Report Method**. The selected method will affect subsequently created Materials Lists, but not any that may already exist.

- Select **Mixed Reporting** to calculate framing materials using a combination of lineal lengths and piece counts.

- Select **Total Lineal Length** to calculate framing materials in linear feet.
- Select **Cut List** to calculate framing materials by counting the individual pieces present in the model.
- Select **Buy List** to calculate framing materials by counting individual pieces and matching them to common board lengths.
- Select the **Length Units** that you want to use from the drop-down list. The selected unit(s) are used in the Materials List when either **Cut List** or **Buy List** is the selected method of reporting. Not available when **Mixed Reporting** or **Total Lineal Length** is selected.

Organizing Materials Lists

You can control what items are calculated in the Materials List by specifying which categories are used.

There are some parts of a model that cannot be excluded from the Materials List. Floor and ceiling

platforms are prime examples. If you need to generate a Materials List for only part of a plan, such as an addition, consider making a copy of the plan file. In the copy, delete the as-built portion of the plan and then generate a Materials List.

ID	Floor	Size	Description	Count	Extra	Unit	Price	Total Cost	Comment	Label
General										
1										
2		1 109 1/8 high...	Siding-6	99		ft		\$0.00		
3		1	thermal envelope - wall area - North	264.48		sq ft		\$0.00		
4		1	thermal envelope - wall area - East	173.17		sq ft		\$0.00		
5		1	thermal envelope - wall area - South	264.10		sq ft		\$0.00		
6		1	thermal envelope - wall area - West	172.79		sq ft		\$0.00		
7		1	thermal envelope - ceiling area	551.00		sq ft		\$0.00		
8		1	thermal envelope - floor area	551.00		sq ft		\$0.00		
9								Subtotal:	\$0.00	
Subfloor										
10										
11		1 4'x8'x3/4"	OSB-Hrz	19				\$0.00		
12								Subtotal:	\$0.00	
Framing										
13										
14		1 2" x 6"	ceiling joists - lumber	420		ft		\$0.00		
15		1 2" x 6"	fir plate	295		ft		\$0.00		
16		1 2" x 6"	fir stud	541		ft		\$0.00		

Categories

The line items in the Materials List are organized into a set of predefined categories, such as Electrical

and Framing, which display in the **ID** column.

Unlike other categories that calculate materials or objects, the General category lists information about

the building’s thermal envelope. See “Conditioned Area Totals” on page 382.

To specify a line item’s category

1. Create a Materials List.
2. Click in the cell in the ID column for a line item.
3. Select the desired category from the drop-down list that becomes available.

The categories that are available cannot be altered; however, you can specify which categories are included for individual lists in the **Materials List Display Options** dialog.

Details Dialog



For information about one or more selected line items in a Materials List, click the **Details** edit button. The **Details** dialog displays all Materials List columns for reference, which can be helpful when not all columns are in use in the Materials List. It also lists the Source Object of the selected line item or items.

This dialog will also open when multiple objects located on more than one floor are selected in a Materials List and you click the **Find Object in Plan** edit button.

When one or more line items located on the same floor are selected, click the **Find** button at the bottom

of the dialog to view their location in a plan view window.

Find Object in Plan



To find out where a line item in the Materials List is located in the model, select its row or any cell in its row and click the **Find Object in Plan** edit button. A view window opens in which the object or objects associated with that line item are selected.

If a plan view showing the floor that the object is on is open, that view will become active and the object will be selected. If no such view is open, a new unsaved view showing the object’s floor will be created. See “View Windows” on page 61.

If the selected item is a component of a complex object like an Auto Dormer, Mulled Unit, Bay Window, or Architectural Block, the parent object will be selected in the plan instead of the individual component.

Note: The Find Object in Plan tool is not available for objects that cannot be selected: for example, wall framing objects and roofs.

If the selected row or rows in a Materials List refer to objects on different floors, the **Details** dialog will open when you click the **Find Object in Plan** edit button.

Materials List Specification Dialog



When a Materials List is open, select **Tools>Display Options** to open the **Materials List Specification** dialog for the current list.

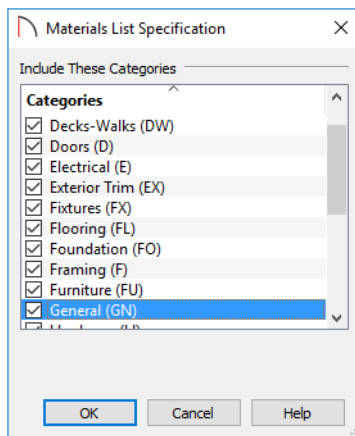

The Categories listed here appear in the ID column of the Materials List in the order they are presented here.

- Check the box beside the name of each category that you want to display in the currently active Materials List.
- Multiple rows can be selected together using Shift and Ctrl keys. See “Shift and Ctrl Select” on page 81.

Note: The information in a suppressed category is still part of the Materials List. If the Materials List is exported, suppressed categories are exported, as well.

Editing Materials Lists

Materials lists can be edited in a variety of ways. You can adjust the width of a column by clicking and dragging the bar on the right side of the column name.

Adding Information

You can enter information in the Price and Comment column for each line item.

Adding price or other information for any item is straightforward. Simply click in the cell and type the desired information.

Changing Information

You can change the information in any column in an individual Materials List. As with added information, click in a cell to select the existing text, then type in the desired text.

To move an item in a Materials List to a new category, select the cell in the **ID** column and choose a new category from the drop-down list that becomes available. See “Categories” on page 379.

Changing Count Units

The material for a given object component will be counted either by piece; linear feet or meters; square feet or meters; or cubic yards or meters. The same method and unit used in the Count column will be used in the Extra column.

When the Count is linear, area, or volume, you can choose a different unit of measurement:

- Double-click in a cell in the Count column to select and edit it, then choose a unit of measurement from the drop-down list to the right of the selected cell.
- You can also click the **Number Formatting**  button when a Count cell is selected to specify the units and accuracy of the value in the selected field. The specified unit is also used in the Extra field for that row. See “Number Formatting Dialog” on page 381, below.

Printing and Exporting the Materials List



To print a Materials List, select **File> Print** while the Materials List window is active. See “Print View Dialog” on page 387.



A Materials List can also be exported into a tab delimited text (.txt) file that can be opened directly by most spreadsheet programs. In a

Tool Tips

Whenever you mouse over a cell in the Count column, a Tool Tip will display, providing information about the cell’s contents. When the Count is a total length, area, or volume, it may be rounded. The Tool Tip will show the value with greater accuracy.

Total Cost

Total Cost for a line item is calculated using the Count, Price, %Markup, Labor and Equipment columns to calculate the cost. The formula used is:

$$(\text{Count} + \text{Extra}) * \text{Price} * (1 + (\% \text{ Markup}/100)) + ((\text{Count} + \text{Extra}) * \text{Labor}) + ((\text{Count} + \text{Extra}) * \text{Equipment})$$

If a column does not appear, 0 is used for the value of that column with the exception of Count and Price, which are always used in the calculation even if they are not shown.

Copying Information

Portions of a Materials List can be copied and then pasted into a **Text**  object or into a word processing program or spreadsheet program using the standard Windows Copy (Ctrl + C), Cut (Ctrl + X), and Paste (Ctrl + V) commands. See “Copying and Pasting Text” on page 162.

Number Formatting Dialog



Double-click in a cell in the Count column of the Materials List and click the **Number Formatting** button to open this dialog and specify the units, formatting, and accuracy of the value in that cell.

The settings in this dialog are also found in the **Dimension Defaults** dialog. See “Format Panel” on page 148.

Materials List window, select **File> Export Materials List**.

The **Write Materials Export File** dialog will open. This is a typical File Save dialog. See “Exporting Files” on page 36.

Estimating Software

You can export a Materials List to a word processor or spreadsheet program to arrange it in your estimating format. You can also export the Materials List to a number of commercial estimating programs

in whose databases you can keep your current pricing and generate reports based on this data.

Before purchasing an estimating software program, be sure that the program supports the direct import of Chief Architect Materials Lists.

Any questions regarding estimating software packages and how they interact with Home Designer Suite should be directed toward the company providing the estimating software. Home Designer Suite is unable to provide any technical support for third party programs.

Conditioned Area Totals

Conditioned Area is the space within a building that is heated and/or air conditioned, and a Thermal Envelope is a three dimensional boundary built around the Conditioned Space that separates it from the unconditioned space around it. Thermal Envelopes are composed of floor platforms, ceiling platforms, walls, doors, and windows.

When a Materials List is created, Home Designer Suite calculates the total areas of the components that make up a structure’s Thermal Envelope and lists them in the General category of the Materials List. See “Categories” on page 379.

Doors are always categorized as doors rather than as windows. This is the case even when a door is specified as a Glass Door or when it is part of a mullied unit.

Conditioned area totals can be entered into third party programs such as **REScheck™** to determine whether the plan meets the energy code in use in your area.



Home Designer Suite does not check plans for compliance with building or energy codes.

Conditioned Area

With the exception of Unspecified rooms, rooms that are assigned an interior Room Type are included in the Conditioned Area. “Open Below” rooms are also

included; however, other hybrid Room Types as well as exterior Room Types are not. See “Room Types” on page 132.

Building Orientation

Walls, doors, and windows are categorized as north-, south-, east-, or west-facing for the purposes of conditioned area totals. The definition of North in a plan is straight up on screen in plan view.

- If a wall is oriented at 45° or less to north in a plan, it will be categorized as a “North” wall. Any doors and windows in this wall will also be categorized as “North”.
- Similarly, walls, doors, and windows oriented within 45° of south, east, or west will be classified as “South”, “East” or “West”, respectively.

The orientation of a curved wall is based on the direction of its chord.

The General Category

The General category of the Materials List lists information about the Thermal Envelope of the current plan. The total linear length of each wall type used in the plan is also calculated in the General category. Walls with different heights are each listed separately. See “Wall Type Definitions” on page 124.

Printing

Home Designer Suite provides a variety of printing options, from printing scaled plan views and 3D perspectives, to a set of templates that can be assembled into a 3D model.

Home Designer Suite also allows you to save your drawings in **.pdf** file format that can then be sent to a printing service.

Note: Screen captures are provided for illustrative purposes only and are not an endorsement of any products.

Chapter Contents

- Introduction to Printing
- The Printing Tools
- Drawing Sheet Setup Dialog
- Print Preview
- Printing to Scale
- Printing Across Multiple Pages
- Printing to a PDF File
- Print View Dialog
- Print Image Dialog

Introduction to Printing

Home Designer Suite offers printing options to suit a variety of needs. It is helpful to be familiar with these options and choose the one that makes the most sense for the project at hand.

Output Options

Printing a View - Floor plan and elevation views can be printed to scale. See “The Printing Tools” on page 384.

Printing an Image - Any view of your plan can be printed as an unscaled image. See “Print Image Dialog” on page 389.

Printing to PDF - Plans can be printed to a **.pdf** file and printed remotely. See “Printing to a PDF File” on page 387.

Terminology

Paper Size - The dimensions of the paper to be printed on. Specifying a paper size that is smaller than the scaled drawing allows large drawings to be printed across multiple pages.

Drawing Scale - Drawings are often printed to scale for accuracy. $\frac{1}{4}'' = 1'$ and $1\text{ m} = 50\text{ m}$ are examples of common scales. You can specify this scale in the **Drawing Sheet Setup** dialog. See “Drawing Sheet Setup Dialog” on page 384.

When a particular scale is not important, drawings can also be sized to fill a particular area. See “Printing to Scale” on page 386.

Printing Problems

If you encounter difficulties when trying to print, see “Troubleshooting Common Technical Issues” on page 422.

Printer Drivers

A printer driver is a program that allows a printer to communicate with the rest of the computer system. Drivers are usually created by the printer manufacturer, are typically updated regularly, and can usually be downloaded free of charge from the manufacturer’s web site.

In addition to interpreting between the printer and the rest of the system, printer drivers save default page size, orientation, margin size, and other information that Home Designer Suite refers to unless you specify otherwise. See “Print View Dialog” on page 387.

If you experience printing problems, consider installing updated drivers for your printer. Visit your printer manufacturer’s web site for more information.

 Options available with one driver may not be available with another. Printers supported in one operating system may not be supported by the manufacturer in another.

Clearing Printer Information

Some information specific to individual printers, such as available paper sizes, is saved with each plan file. You can select **File> Print> Clear Printer Info** to clear the printer-specific information stored with the plan file.

Displaying Objects



You can control the display of objects when printing directly from a view in the **Display Options** dialog. See “Display Options Dialog” on page 74.

Objects must be visible in order for them to print; however, not all items that are visible will print. See “Print Preview” on page 385.

The Printing Tools



Select **File> Print** to view the Print Tools submenu. These tools fall into two categories.

Print Setup Tools



Drawing Sheet Setup - Opens the **Drawing Sheet Setup** dialog. See “Drawing Sheet Setup Dialog” on page 384.



Scale to Fit - Automatically selects a scale that fits your plan to the printer page. See “Printing to Scale” on page 386.



Center Sheet - Automatically centers the drawing sheet on your drawing. See “Center Sheet” on page 386.



Print Preview - Shows on screen how the current view will appear printed, based on the

current scale and other settings. See “Print Preview” on page 385.

Print Tools



Print - Prints the current plan to a specified scale. See “Print View Dialog” on page 387.



Print Image - Prints the current view including images, textures, and backdrop. Views printed with Print Image are not scaled. See “Print Image Dialog” on page 389.



You can also select **File> Export> Export PDF** to open the **Export PDF** dialog. See “Print View Dialog” on page 387.

Clear Printer Info - Clears the printer information associated with the current page setup.

Drawing Sheet Setup Dialog



Select **File> Print> Drawing Sheet Setup** to open the **Drawing Sheet Setup** dialog.

The **Drawing Sheet Setup** dialog is only available when plan view or an Elevation view is active. When

a perspective view is active, **Drawing Sheet Setup**

 is not available.

The settings in this dialog are specific to the current view and are saved with the .plan file..

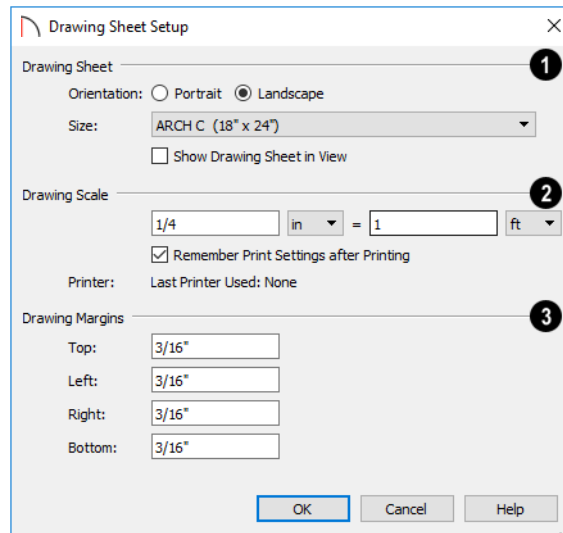

1 Specify the **Orientation** and **Size** of the **Drawing Sheet**, which is the final printed output.

Check **Show Drawing Sheet in View** to turn on the display of the Drawing Sheet in orthographic views. See “Drawing Sheet” on page 386.

2 Specify the **Drawing Scale** for the active view. This scale is applied only when the view is printed.

The scale is specified in two parts, which by default are $\frac{1}{4}$ inch = 1 ft or 1 m = 50 m. Both imperial and metric units of measurement are available and can be selected independently.

- Uncheck **Remember Print Settings after Printing** to use the default settings every time a **Print** dialog is opened. When checked, the program remembers your settings for each type of view. This setting is global, affecting all plan files.

3 Specify the **Drawing Margins** which define the extents of the printable area of the active view’s Drawing Sheet.

- Specify the width of the **Top**, **Bottom**, **Left**, and **Right** margins.

Clearing Printer Information

Select **File> Print> Clear Printer Info** to clear the printer-specific information stored in the **Drawing Sheet Setup** dialog.

Print Preview



Print Preview and its related display toggles allow you to get a sense of what the current view will look like when it is printed.

Print Preview



Select **File> Print> Print Preview** for an on-screen representation of how the current view will appear when printed. Print Preview is only available in plan view. See “Printing to Scale” on page 386.

The printer page displays as a solid white rectangle, and blue lines along the edges of the printer page indicate the edges of the printable area, as defined by the currently selected printer. See “Drawing Sheet Setup Dialog” on page 384.

Objects such as camera symbols, and the Reference Grid that do not print do not display in **Print**

Preview . Text and dimension objects appear on-screen as they will on the printed page.

When **Print Preview**  is enabled, color will display depending on whether **Print in Color** is selected in the **Print View** dialog. See “Print View Dialog” on page 387.

The Reference Display does print if it is visible. See “The Reference Floor” on page 231.

Color

The **Color** toggle turns the on-screen display of color on or off in all views.

Reference Grid

The **Reference Grid** is an on-screen grid composed of regular squares that can be used to convey a sense of scale while drawing. It does not print, and its size can be specified in the **General Plan Defaults** dialog. See “General Plan Defaults Dialog” on page 49.

Printing to Scale

Several different print scaling options are available. The type of view that you are printing determines which options you may choose from.

Orthogonal Views

Plan views are orthogonal views, which means:

- Your line of sight is at a right angle to all objects in the view.
- Objects do not appear to decrease in size as their distances from the viewer increase.

Orthogonal views can be printed to scale.

The scale set in the **Page Setup** dialog is inherited by the **Print** dialog. This scale can be overridden on an individual basis in the **Print** dialog. See “Print View Dialog” on page 387.

Select **File> Print> Scale to Fit**  in an orthogonal view to select a suitable scale and re-center the printer page so that everything fits on the page.

Printing Across Multiple Pages

When printing directly from a plan view it is possible to print at a scale that does not fit the drawing on one page.

Drawing Sheet

The Drawing Sheet is a representation of the size and orientation of the final printed output. It is different from the printed page size, which means that you can print a large Sheet to multiple smaller pages.

The Drawing Sheet size and orientation are specified in the **Drawing Sheet Setup** dialog. See “Drawing Sheet Setup Dialog” on page 384.

When the Drawing Sheet is set to display, a blue border representing the margins of the printable area will also display for reference.

Center Sheet



Select **File> Print> Center Sheet** to center the printer page on the drawing. This moves the printer page relative to the drawing but does not affect the coordinates of objects in the drawing. The location of the printer page is independent for each floor of the model.

Imperial drawing scales are typically noted in inches per foot. Larger scales, such as 1 inch = 50 feet or 1:200m, are often used for property layouts.



Perspective Views

Camera views and overviews display the model much the way the eye would see it and cannot be scaled.

- Objects in the view may be at any angle relative to your line of sight.
- Objects seem to decrease in size as their distances from the viewer increase.



Perspective views can only be printed using the

Print Image  tool. See “Print Image Dialog” on page 389.

To see on-screen what the drawing will look like when printed, select **File> Print> Print Preview**  and then **Window> Fill Window** . Grey lines across the drawing sheet indicate where the page

breaks will occur. See “Print Preview” on page 385.

To print across multiple pages

1. Select **File> Print> Print Preview**  to display the white rectangle representing the printer paper. See “Print Preview” on page 385.
2. Click the **Select Objects**  button, then click near an edge of the printer paper rectangle to select it.
When selected, the printer paper is highlighted in pale grey and a square Move edit handle displays at its center.
3. Click and drag the Move edit handle to position the printer paper so that the portion of your drawing that you would like to print on your first

page is located within the printable area of the page.

4. Select **File> Print> Print** . In the **Print** dialog, make sure **To Scale** is selected, then click OK. See “Print View Dialog” on page 387.
5. Select the printer paper rectangle and move it so that the desired contents of your second printed page are within the printable area and print **To Scale**.
6. Continue moving the printer paper and printing as needed.

When printing multiple pages, it is generally a good idea to leave some overlap on the edges of each page to make sure that information near those edges is not left off the printed pages by mistake.

Printing to a PDF File

Portable Document Format, or **.pdf** files, are one of the most universally compatible and efficient file formats and can be viewed and printed on most computer platforms.

You can save any view as a **.pdf** file by selecting “Chief Architect Save as PDF” or any other PDF writer installed on your system as the Destination printer **Name** in either the **Print View** or **Print Image** dialog. See “Print View Dialog” on page 387 and “Print Image Dialog” on page 389.

You can also print to **.pdf** from any view by selecting **File> Export> Export PDF** . See “PDF Files” on page 331.

When you print to **.pdf**, you will be asked to create a file name and choose a destination to save it in the **Save as PDF File** dialog. See “Saving, Exporting, and Backing Up Files” on page 34.

You can also import **.pdf** file into Home Designer Suite. See “Importing PDF Files” on page 331.

Print View Dialog



To print from plan view and the Materials List, select **File> Print> Print**. The **Print View** or **Print Materials List** dialog opens. The

settings that are available will vary depending on which version of the dialog is open.



Select **File> Export> Export PDF** to open the similar **Export PDF** dialog.

Note: 3D views can be printed using Print Image.

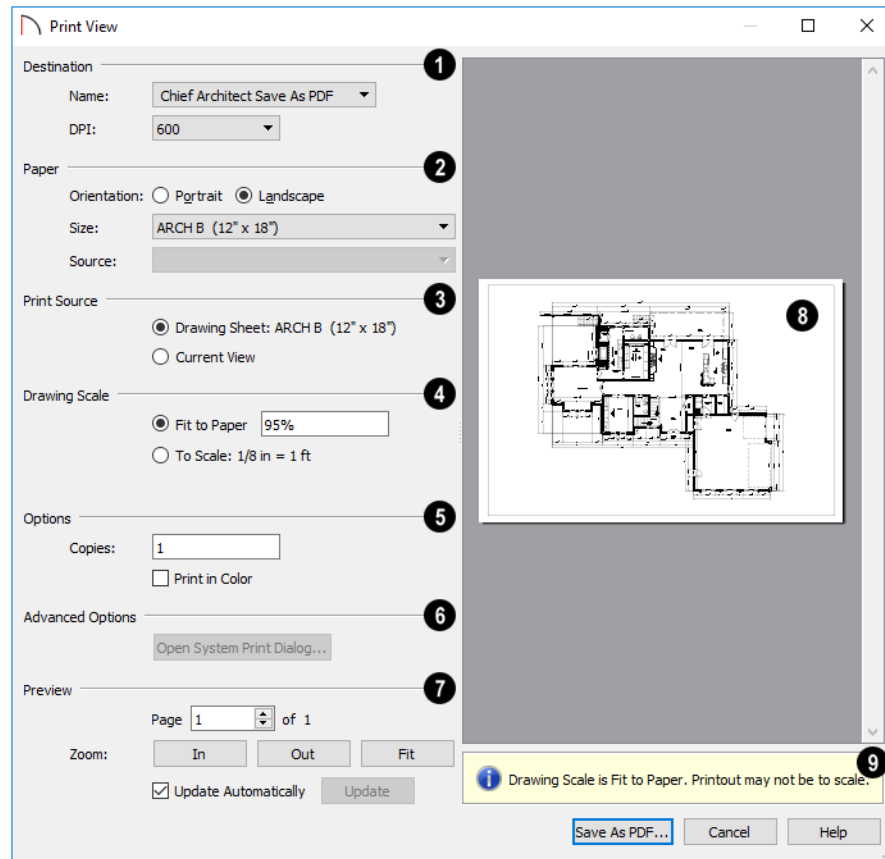

- 1 Select the **Name** of the **Printer** that you would like to use from the drop-down list. To print to **.pdf**, select “Chief Architect Save as PDF” from the list, or choose a **.pdf** writer installed on your system. See “Printing to a PDF File” on page 387.
 - Select the **DPI**, or Dots Per Inch to use when printing, from the drop-down list. The available options may vary depending on the selected printer.
- 2 Select the **Paper Orientation**, **Size**, and **Source**. The available Size and Source options are controlled by the selected printer’s driver.
 - When possible, the program will automatically set the Size and Orientation to match those of the Drawing Sheet.
 - The Paper Size may be automatically adjusted if the Drawing Scale option is changed, below.
- 3 Specify the **Print Source**. Not available in the **Print Materials List** dialog.
 - Select **Drawing Sheet** to print the entire sheet even though you may be zoomed in on a portion of the view. This is selected by default when the Drawing Sheet is set to display in the current view.
 - Select **Current View** to print only that portion of the active view that is currently visible on screen. If you are zoomed out, any blank space outside of the printable objects in the view is ignored. This is selected by default when the Drawing Sheet is not displaying in the current view.
- 4 Specify the **Drawing Scale** of the printed output. Changes to these options may cause the Paper Size to change, above. Not available in the **Print Materials List** dialog or in camera views or overviews.
 - **Fit to Paper** prints the view on one page. The program uses whatever scale is necessary to fit the plan on one page.

- When **Fit to Paper** is selected, specify the percentage of the paper to be used. The default value is 95%.

Note: The Fit to Paper percentage value is global - affecting all views in all files, and is retained between sessions.

- Select **To Scale** to print at the scale specified in the **Drawing Sheet Setup** dialog. See “Drawing Sheet Setup Dialog” on page 384.

5 Options -

- Specify the number of **Copies** you would like to print.
- Check **Print in Color** to print in color or clear the check box to print in either grayscale or black and white. In the **Print Materials List** dialog, system default colors are used when this box is unchecked.

- 6 Advanced Options -** Click the **Open System Print Dialog** button to close the **Print View** dialog and print using your operating system’s Print dialog instead. Not available when No Printer is selected.

7 Control the appearance of the print job **Preview** on the right side of the dialog.

- Specify the **Page** that displays in the Preview area.
- Click the buttons to **Zoom In**, **Zoom Out**, or **Fit** the selected Page to the extents of the Preview area.
- Uncheck **Update Automatically** to turn off the print job Preview and prevent it from updating as changes are made to the settings in this dialog.
- Click the **Update** button to update the print job Preview to reflect the current settings in this dialog. If Update Automatically is unchecked, clicking Update may force the Preview to be blank.

- 8** When **Update Automatically** is checked, a preview of the current print job displays here. The drawing sheet displays as a white rectangle, and if multiple sheets are required, you can scroll through them. If the print job is large, a progress dialog may display briefly as the preview draws or updates.

- 9** To help prevent unwanted printed output, information messages regarding page size, resolution, and scale may display here, depending on the settings in this dialog.

Print Image Dialog

 Any view can be printed by selecting **File>Print Image**. This is the only way to print 3D views. See “3D Rendering” on page 319.

The **Print Image** dialog is similar to the **Print View** dialog; however, the printing process is different. **Print Image** prints individual pixels as opposed to vectors (lines).

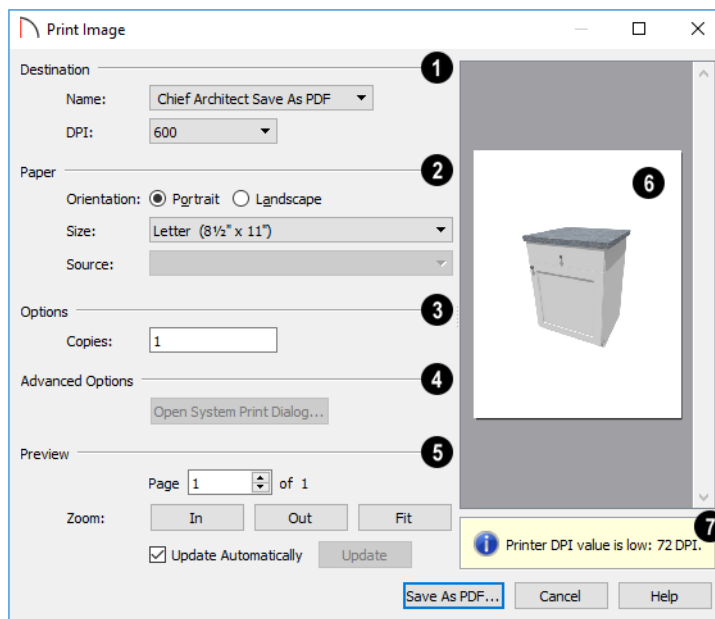

- ❶ Select the Name of the **Printer** you wish to use from the drop-down list. To print to **.pdf**, select “Chief Architect Save as PDF” from the list, or choose a **.pdf** writer installed on your system. See “Printing to a PDF File” on page 387.
- ❷ Select the **Paper Orientation, Size, and Source**. The available Size and Source options are controlled by the selected printer’s driver. See “Printer Drivers” on page 384.
- ❸ Specify the number of **Copies** you would like to print.
- ❹ **Advanced Options** - Click the **Open System Print Dialog** button to close the **Print View** dialog and print using your operating system’s Print dialog instead. Not available when No Printer is selected.
- ❺ Control the appearance of the print job **Preview** on the right side of the dialog.
 - Specify which **Page** displays in the Preview area.
 - Click the buttons to **Zoom In, Zoom Out, or Fit** the selected Page to the extents of the Preview.
 - Uncheck **Update Automatically** to turn off the print job Preview and prevent it from updating as changes are made to the settings in this dialog.
 - Click the **Update** button to update the print job Preview to reflect the current settings in this dialog. If Update Automatically is unchecked, clicking Update may force the Preview to be blank.
- ❻ When **Update Automatically** is checked, a preview of the current print job displays here. If the print job is large, a progress dialog may display briefly as the preview draws or updates.
- ❼ To help prevent unwanted printed output, information messages regarding page size and resolution may display here, depending on the settings in this dialog.

Resources and Support

Chief Architect technical support and training resources to help you be successful using our software.

- Learning and Inspiration
- Contacting Technical Support
- Error Messages
- Program Paths Dialog

Learning and Inspiration

Chief Architect offers a variety of resources that help you learn how to use the software, discover new drawing techniques, and connect with other Home Designer users.

Home Designer Web Site

The Home Designer web site has an array of resources, including downloadable library content, program updates and more. Select **Help> Visit**

Home Designer Web Site  from the program menu to launch your default internet browser to HomeDesignerSoftware.com.

Reference Manual

The Home Designer Suite Reference Manual is a comprehensive source of information about the entire Home Designer Suite 2021 program interface. This manual is available online in .pdf format by selecting **Help> View Reference Manual** .

User's Guide

Written for new Home Designer Suite users, but a helpful reference for users of all experience levels as well, the User's Guide walks you through the process

of creating a complete model, from the first wall to the interior design and landscaping.

This guide is available online by selecting **Help> View User's Guide**.

Online Help Videos

Another resource that illustrates Home Designer Suite's tools is the collection of tutorial videos available on our web site. To view the online videos, select **Help> View Online Help Videos** from the program menu or visit www.homedesigner.chiefarchitect.com/videos.

Online Knowledge Base

The Home Designer Knowledge Base is a collection of online articles that address common technical issues as well as a range of how-to questions with illustrations and step-by-step instructions. To access these resources, visit HomeDesignerSoftware.com.

HomeTalk Online Forum

The HomeTalk User Forum hosts ongoing discussion on a variety of topics related to the use of Home Designer Suite. It is rich with useful tips and

available free of charge to all registered Home Designer Suite users.

- Discussions are initiated and carried out by users.
- Experienced users share knowledge with each other and beginners.
- Home Designer Suite Staff members post announcements, advice and technical information.

Contacting Technical Support

Chief Architect's world class technical support services can be accessed both online and by telephone. Select **Help> Technical Support** from the program menu to visit HomeDesignerSoftware.com.

Before contacting Technical Support, take a moment to see if the answer to your question is found in the program's Help, Training Videos, or other online resources. When you contact us, you will be referred to these resources if the answer can be found there.

There are a number of things you can do to ensure a speedy answer to your question when you contact Technical Support.

- Select **Help> About Home Designer Suite (PC)** or **Home Designer Suite> About Home Designer Suite (Mac)** and make a note of the first characters of your Product Key and the program's Build number.
- We periodically release updates to the current program version. Before contacting Technical Support, select **Help> Download Program Updates** and make sure you are running the most current update for your program version.
- When you encounter an error message, click the **Send Report** button if possible and copy the message's exact wording. See "Error Messages" on page 392.

Error Messages

Most common error messages have a known cause and simple resolution. When you encounter an error or warning message in Home Designer Suite, you can click the **Check Knowledge Base** button in the message box to launch your default internet browser to the Home Designer Knowledge Base on our Web site, HomeDesignerSoftware.com.

To visit HomeTalk, select **Help> HomeTalk** or go to hometalk.chiefarchitect.com.

Online Samples Gallery

A collection of plan sets and renderings is available for viewing and download on our web site. Select

File> Download Sample Plans  to launch your internet browser to HomeDesignerSoftware.com

- When calling Technical Support, have Home Designer Suite running on the computer where the problem occurs. This is necessary in order to troubleshoot the issue and verify that a solution is found.
- Be prepared to reproduce and describe the problem in detail. If we cannot reproduce the problem, there is a reduced chance that we will be able to resolve it.

Telephone Support

Our Technical Support team is committed to answering your questions as quickly as possible and in the order received. We can resolve most issues in just a few minutes and are happy to help you find the best resource to answer your questions. So that we can quickly answer all calls, though, we may ask that you limit your inquiry to one question.

Online Support

If a Support technician needs to see a copy of a plan or other file, they will ask you submit it to us using the Chief Architect [Online Support Center](#).

Questions can also be submitted directly to the Technical Support department using the Online Support Center as well. Be sure to provide a detailed description of the problem you are encountering in your ticket.

If the message is discussed in an article it will display, providing information about the message and how best to avoid it.

It is important that abnormal errors be reported to Chief Architect Technical Support so that we can identify and resolve any problems.

The content of an error message is useful in diagnosing its cause. If you encounter an error message, make a note of the error number and the full text of the message. You can also click the **Details** button and copy the text into a text document or Online Support Center ticket.

If you encounter the error more than once, make a note of your steps prior to receiving the message.

Finally, check to see if there are program updates available. Program updates contain enhancements and other changes that allow the software to perform at an optimum level. Select **Help> Download Program Updates** from the Home Designer Suite menu and follow the instructions on our Web site, HomeDesignerSoftware.com.

Program Paths Dialog

Some technical issues can be caused by problems with support files used by Home Designer Suite. In the event of such an issue, Chief Architect Technical Support may direct you to the **Program Paths** dialog. This dialog displays a list of files utilized by the software along with the pathname of each.

Error Reporting

When an error occurs, you may have the option in the message box to send the report to Chief Architect by clicking the **Send Report** button in the error message box. A report containing technical details about the error, but no personal information, is sent to our Testing team for evaluation.

After clicking the **Send Report** button, please contact [Technical Support](#) with any additional information that you may have about the circumstances of the error: for example, the type of view that was open and the tool that was active.

To avoid unintended problems that could prevent you from using the software, it is strongly recommended that you make no changes to any of the files in this list except with the direct assistance of Technical Support.

Index

Numerics

360 Panorama Export	348
3D	
Backdrops	317
Data Import	345
Delete Surface.....	307
Mice.....	20
Symbols, Importing	345
3D Roof Designer	258
3D Views	
Display.....	307
Doll House	305–306
Editing	313
Framing Overview.....	306
Full Overview	305
Overviews	304
Save	314
Working in.....	313
3D Wall Designer	114

A

Adding	
to the Library	279
Adjust	
Material Definition.....	299
Align	
Curved Stairs Between Floors	94
Curved Walls Between Floors.....	122
Objects	93
Text	162
Walls.....	121
Alphabets	
International	158
Unicode	158
Ambient Light	
Daytime	321
Interior	321
Nighttime.....	321
Angle Snaps	68
Angle Style	
Dialog	55
Appearance Preferences	50
Appliances	
Built into cabinets	201
Arc	
Panel	104
Specification Dialog	104

Architectural Blocks	
Displaying	287
Edit Sub-Objects	287
Explode	287
Sub-objects.....	288
Archive Files	37
Area	
Living Area calculation.....	133
of a Polyline.....	106
of Rooms	136
Arrow	
Auto Positioning	165
Panel.....	103
Text Line With.....	164
Artwork	
Creating textures.....	299–300
Attic	
Floor.....	231
Rooms.....	133
Walls	123
Auto	
Archive	36
Dormers, Editing	262
Floating Dormer	261
Interior Dimensions	150
Place Outlets	215
Roof Returns.....	263
Save Files.....	37
Stairwell.....	243
Auto Rebuild	
Attic Walls.....	110
Foundation.....	223
Roofs.....	256
Automatic	
Exterior Dimensions	150

B

Backdrops	333
3D	317
Definition	333
Generated Sky	318
Background Color	51
Backup	
Entire Plan or Project	40
Files	36
Balusters	128
Definition	234
Base	

Cabinets.....	200
Basements	
Daylight.....	225
Walkout.....	225
Bay Windows	184
Bay/Box Window	
Specification Dialog.....	196
Blend Colors with Materials	295
Blind Cabinets	205
Bonus	
Library Catalogs.....	276
Rooms.....	231
Bow	
Window Specification.....	196
Bow Windows	184
Box	
Windows.....	184
Break	
Line.....	95
Line, complete.....	96
Line, partial.....	95
Brick Ledges	113
Build	
Foundation.....	222, 229
House.....	42
New Floor.....	228
Roof Dialog.....	256
Terrain.....	356
Bumping/Pushing	93

C

Cabinet	
Defaults.....	199
Designer.....	199
Modules Library.....	200
Specification Dialog.....	206
Tools.....	200
Cabinets	
Angled front.....	204
Backsplash.....	207
Base.....	200
Blind.....	205
Built-in appliances.....	201
Corner.....	204
Delete face items.....	208
Door/drawer style.....	200
Doors, diagonal.....	207
Doors, glass.....	209
Editing.....	203
End cabinets.....	204
Fillers.....	201
Front Indicators.....	203
Front Panel.....	207
Full Height.....	200
General Defaults.....	199
Glass doors.....	209

Island.....	205
Lazy Susan.....	207
Minimum Width.....	200
Module Lines.....	203
Moving, with Wall.....	203
Normal.....	204
Peninsula radius.....	204
Radius end.....	204
Resize Increment.....	200
Reverse Appliance.....	208
Shaped.....	204
Special shapes.....	204, 206
Wall.....	200

CAD

Angle Snaps.....	68
Circles.....	102
Drawing Tools.....	101
Ellipses.....	102
Ovals.....	102
Polyline.....	102
Polylines.....	105
Rectangle.....	102

CAD Box

Specification Dialog.....	107
---------------------------	-----

CAD Objects

Displaying.....	108
-----------------	-----

Calculate

From All Floors.....	377
From Room.....	378
Loan.....	44
Materials on soffits.....	291

Camera

Activating.....	314
Change Settings.....	315
Create Views.....	305
Defaults.....	303
Field of View.....	312
Move Tools.....	310
Move Up/Down One Floor.....	312
Orbit Tools.....	310
Specification Dialog.....	315
Tilt Tools.....	311

Casing

Door.....	173, 179
-----------	----------

Cathedral Ceilings

.....	140
-------	-----

Ceiling

Break Lines.....	140
Heights.....	138
Shelf.....	139

Ceilings

Cathedral.....	140
Lowered.....	139
Over this room.....	144
Special.....	139
Trey.....	140

Center

Doors.....	173
Object edit tool.....	94
Sheet.....	386

Text	162
Change	
Door Swings	173
Floor/Reference	231
Line to arc	239
Chimneys	226
Circle	
Specification Dialog	105
Circles	102
Ovals	102
Click Stairs	234
Close	
Plans and Views	65
Program	40
Views	65
Color	
Off/On	76
Color Chooser	
Eyedropper	78
Colors	
Selecting	77
Compatibility	
with other programs	31
Connect	
Electrical	215
Walls	116
Contextual Menus	50
In Render views	312
Copy	
Folders and Library Objects	280
Copy/Paste	
Main Edit Mode	71
Sticky Mode	71
Corner	
Boards	265
Windows	185
Corner Board	
Specification Dialog	266
Create	
New Plan Dialog	33
Plant Image	373
Cross Section Slider	313
Cross Section/Elevation Camera	
Specification Dialog	318
Crosshairs	21
Aligning with	93
Crown Molding	
Cabinets	204
Current	
Floor	230
Floor, Delete	229
Curved	
Deck Edge	111
Deck Railing	111
Stairs	234
Walls, Draw	116

D

Deck	138
Designer	111
Edges	111
Framing	138
Railing	111
Roof Over	138
Decks	138
Default	
Lights	321
Default Sun Light	
Specification Dialog	322
Defaults	
Cabinet	199
Camera	303
Defined	47
Dimension	147
Door	169
Dormer	256
Dynamic	48
Floor	132, 227
Foundation	221
General Plan	49
Material	294
Reset	49
Roofs	255
Room	132
Settings	47
Structural Member Reporting	378
Wall	110
Window	183
Define Material Dialog	300
Delete	
3D Surface	307
Built-in Fixtures and Appliances	285
Current Floor	229
Floors	229
Foundation	224
Gable Over Opening	258
Library Content	281
Objects	99
Roof Planes	256, 258
Wall Hatching	114
Dimension	
Defaults	147
Tools	149
Dimension Defaults	147
Dialog	147
Dimension Line	
Specification Dialog	154
Dimensions	
Auto Interior	150
Editing	151
End to end	150
Exterior	150
Interior	150
Locating railings	125
Move Objects Using	154

Number Height	155
Tape Measure	150
Temporary.....	150
Zeroes in.....	149
Display	
3D Views.....	307
CAD Objects	108
Drawing Groups.....	75
Drawing Sheet.....	386
Electrical	216
Foundations	222
Images.....	327
Objects	74
Room labels	136
Terrain	356
Walls, Railings, and Fences	117
Display Options Dialog	74
Distributed Object Tab	360
Doll House View	305–306
Door	
Casing	173
Defaults	169
Specification Dialog	176
Swing Angle	177
Tools.....	169
Trim	173
Doors	
Arched	179
Bifold Doors	170
Casing	179
Center.....	173
Change Opening/Hinge Side	174
Change Swing Side	174
Doorways.....	170
Frame	179
Gables Over	258
Garage.....	170
Garage, opening direction	175
Handles	180
Hardware	180
Hinged Doors	170, 174
Hinges	180
Ignore Casing when Resizing	49
Labels.....	172
Library	171, 177
Lites.....	179
Locks.....	180
Openings in railings	175
Pocket Doors.....	170
Rough opening	177
Size	177
Sliding Doors.....	174
Style	177
Swing, change.....	173
Threshold lines.....	171
Transoms.....	175
Type	177
Wrapped Openings	175
Doorways	
Adding a Door	171

with Railing	175
Dormer	
Defaults	256
Specification Dialog.....	262
Dormers	261
Gable Over Door/Window	258
Manually drawn.....	261
Windows in	262
Draw	
Curved Railing	116
Curved wall.....	116
Drawing Group	
Edit Tools	76
Move to Back	76
Move to Front.....	76
Drawing Groups	75
Drawing Sheet	
Center	386
Select.....	386
Show	386
Driveway Tools	367
Driveways	368
DWG	
File Format	343
DXF	
File Format	343
DXF/DWG	
DXF vs. DWG	343
Dynamic	
Defaults.....	27, 48
Print Preview	385

E

Edit	
Handles	21
Preferences	54
Toolbar.....	23
Edit Area	81
Electrical	
Auto Place Outlets	215
Connections.....	215
Deleting	217
Displaying.....	216
Editing Objects.....	217
General	213
Labels	216
Library	216
Lights	214
Outlets.....	213
Switches	214
Tools	213
Wiring.....	215
Electrical Service	
Specification Dialog.....	217
Elevation	

Data Tools.....	350
Points	350
Regions	352
Tab	359
Elevation Data	
Tools.....	350
Elevation Line	
Specification Dialog	359
Elevation Point	
Specification Dialog	358
Elevation Region	
Specification Dialog	359
Elevation Views	306
Ellipse	102
Specification Dialog	105
End	
Cabinets.....	205
To-End Dimensions	150
Enhanced Metafiles	330
Error Messages	392
Estimating Software	382
Exit Program	40
Expand/Collapse All	274
Explode	
Architectural Blocks	287
Export	
2D Drawings.....	343
360 Panorama	348
3D Viewer File	342
All Floors.....	343
Current View	343
Drawing File Dialog.....	344
EMF.....	330
From the Library	281
Materials List.....	381
Picture Files	329
Windows Metafiles.....	330
Windows Metafiles Dialog	330
WMF.....	330
Extend	
Slope Downward.....	123
Extension Lines	
Adding	152
Deleting	153
Editing	152
Extension Snaps	68
Exterior	
Dimensions	150
Room types.....	133
The Exterior Room.....	134
Walls.....	112
Eyedropper	
Object	98

F

F6 Key	
Fill Window	64
Fence Designer	112
Field of View	312
File	
Backing Up Your Files	36
Create New.....	33
Management.....	31
Open	37
Organization	32
File Management Preferences	53
Fill	
Patterns.....	76
Window.....	64
Window Building Only.....	64
Fill Style Panel	76
Filter	
Library Search	274
Find Object in Plan	380
Fireplace	
Library	226
Symbol	226
Fireplaces	
Chimneys.....	226
Fix	
Wall Connections	116
Fix Off Angle Walls	115
Fixtures	
Lights	214
Floating Auto Dormer	261
Floor	
3D Overview	304
Build New Floor.....	228
Camera.....	304
Defaults	132, 227
Heights	138
Overview	304
Tools	228
Floor Plan	
Drawing.....	27
View	28
Floors	
Adding.....	228
Attic.....	231
Change Floor/Reference.....	231
Current Floor	230
Deleting	229
Exchange With Floor Above.....	229
Exchange With Floor Below	229
Floor Up/ Floor Down	230
Maximum number.....	228
Reference Floor	231
Focus on Object	309
Folders Preferences	53

Fonts..... 158
 and Alphabets 158
Footings 221
Foundation
 Auto Rebuild..... 223
 Defaults 221
 Walls..... 112
Foundations
 Build 222
 Daylight Basement..... 225
 Delete 224
 Display..... 222
 Garage..... 224
 Mixed Types..... 222
 Stem Wall..... 222
 Stepped 225
 Walkout Basement..... 225
Framing
 3D Overview..... 306
 Deck 138
 Structural Member Reporting..... 378
Full
 Height Cabinets 200
 Overview 304–305

G

Gable
 Over Door/Window..... 258
Gamepad
 Enable 59
Gamepad Settings..... 59
Gamepads 309
Garage
 Door Tool 170
Garages
 Foundation 224
Garden Bed
 Kidney Shaped 354
 Polyline 354
 Round 354
 Tools..... 354
General
 Cabinet Defaults 199
 Preferences..... 52
Getting Help..... 29
GFCI Outlet 213
GPS
 Importing..... 365
Grid
 Snaps 50, 68
Ground Fault Circuit Interrupt 213

H

Half
 Walls 128
Half-Walls 110
Hardiness Zone Maps 373
Hardware
 for Doors 180
Hatch
 Fill Patterns 76
 Wall 114
Height
 Railings 129
Help
 Tool Tips 29
Hill / Valley
 Specification Dialog..... 359
Hill/Valley 353
Holes
 In terrain 354
Home Designer
 Product Key 29
 Version Number 29
Hotkeys 23, 58
 Create List 59
House Wizard
 Editing Rooms..... 41
 Multiple Floors 42
 Placing Rooms..... 41

I

Image
 Specification Dialog..... 328
Images..... 320
 Adding to Library 326
 Creating..... 326
 Displaying..... 327
 Editing 327
 Place 326
 Printing..... 389
Import
 3D Data 345
 3D Symbols 345
 GPS Data 365
 PDF 331
 Terrain Assistant 364
 Terrain Data..... 363
Interior
 Dimension Tool 150
 Dimensions, Auto 150
 Room types..... 133
Invisible Walls..... 113

K

Key Frames	336
Keyboard	
Commands	23, 58, 273
Kidney Shaped	
Garden Bed	354
Pond	354
Terrain Features	353
Kitchen Island	205
Knee Walls	123, 126

L

Label Panel	166
Labels	166
Displaying	166
Door	172
Electrical	216
Plant	375
Room	136
Window	187
Landing	240
Landings	
Height	240
Landscape Designer	349
Layer	
Layer Sets	75
Layers	
Primary and Secondary	74
Left Mouse Button	
Definition	20
Library	
Adding Folders	279
Bonus Catalogs	276
Content	276
Deleting Content	281
Export	281
Manufacturer Libraries	276
Renaming Libraries	280
Search	274
Shortcuts	280
Trash	281
Library Browser	271
Adding Items	279
Docking	274
Panels	271
Preferences	52
Library Object	
Specification Dialog	285
Library Objects	
Editing	284
Placing	281
Light	
Ambient	321

Light Sources	320
Default Lights	321
Default Sun Light	321
Fixtures	321
Lights	
Fixtures	214, 321
Turn On/Off	322
Line	
Color	103
Panel	103
Specification Dialog	102
Line Style	103
Panel	103
Lites	
Craftsman	191
Diamond	191
Doors	179
Normal	191
Prairie	191
Living Area	137
and Room Types	133
Calculation	137
Delete label	137
Label	137
Restore label	137
Show	50
vs. Footprint	137
Loan Calculator	44

M

Main	
Edit Mode	71
Manual	
Dimensions	150
Manufacturer Libraries	276
Marquee Select	80
Marquee Select Similar	81
Material	
Defaults	294
Eyedropper	295
Material Painter	295
and Walls	296
Blending	295
Modes	295
Using	295
Materials	
Add to Library	279
Artwork	299–300
Blending	299
Brightness	301
Calculating amounts	291
Color	300
Creating	299
Define Material Dialog	300
Editing	298
On Soffits	291

Panel	296
Textures.....	320
Walls.....	117
Materials List	377
Calculate from All Floors	377
Calculate from Room	378
Conditioned Areas	382
Display Options Dialog.....	380
Editing	381
Estimating software	382
Export	381
Menus	23
Message Boxes	
Reset	26
Metafile Size Dialog	330
Metafiles	330
Middle Mouse Button	20, 63
Minimum	
Alcove.....	257
Molding	
Profiles, changing	268
Moldings Panel	268
Monolithic Slab	221
Mouse	
3D.....	20
Pointer Icons	21
Mouse Buttons	
Using	20
Move	
Along Rails.....	120
Camera with Mouse	309
Folders and Library Objects	280
Nudging	93
Object Using Dimensions	154
Objects	92
Restrictions	93
Walls with Cabinets Attached	203
Mulled Unit	
Specification Dialog	188
Mulled Units	
Labels.....	167
Mullions	
Window	191
Multiple	
Select	80
Muntins	
Window	191

N

Newels	
Definition.....	234
Newels/Balusters Panel	129
Niche	184
No Locate Wall	125

Nudging	93
----------------------	----

O

Object	
Based Design.....	19
Object Snaps	68
Extension Snaps	68
Off Angle Walls	115
One-Click Auto Dimension	150
One-Click Stairs	234
Open	
Below	133
Object.....	25
Plan Files.....	37
Symbol	285
View	314
OpenGL	303
Organizing	
your Files.....	32
Orthogonal Views	386
Outlets	213
Above cabinet	214
Automatic	215
Dishwasher	214
GFCI	213
Manually placed	213
Place	215
Sink.....	214
WP	214
Oval	102
Specification Dialog.....	105
Overview	17
Full	305

P

Page Setup Dialog	384
Painting	
Over Materials	299
Pan	
Pan Window Tool	65
the Display.....	64
Using the Keyboard.....	64
Using the Mouse	64
Using the Scroll Bars.....	64
Panorama Export	348
Paragraph Options Dialog	161
Partition Tool	200
Pass-Through	184
Paste	70
Hold Position	71
Special	71
Paste Image	70

PDF	331
Importing	331
Print to	387
Peninsula Radius Cabinets	205
Picture File Box	
Specification Dialog	330
Picture Files	
Export	329
Import	330
Scale	333
Pitch	
Above Wall	123
Place	
Gable Over Window(s)	185
Images	326
Library Objects	281
Outlets	215
Plan	
Create New	33
Drawing	27
Files, Opening	37
General Defaults	49
Saving	34
View	28
Plan Check	43
and room labels	133
Dialog	44
Hold	44
Restart	44
Plant	
2D Symbols	374
Chooser Dialog	372
Encyclopedia	372
Labels	375
Tools	371
Plant Image	
Create	373
Specification Dialog	373
Plant Shelf	139
Pointer	
Crosshairs	21
Polygon	
Shaped Deck	111
Polyline	
Area	106
Definition	105
Garden Bed	354
Panel	106
Specification Dialog	106
Ponds	354
Round	354
Preferences	
Appearance Panel	50
Colors Panel	51
Definition of	48
Dialog	50
Edit Panel	54
File Management Panel	53

Folders Panel	53
General Panel	52
Global settings	50
Library Browser Panel	52
Render Panel	54
Reset preferences	55
Print	383
3D Views	386
Across Multiple Pages	386
Center Sheet	386
Clear Printer Info	384
Color or Black and White	389
Dialog	387
Drawing Scale	383
Drivers	384
Options	384
Paper Size	383
Perspective Views	386
Preview	385
Printable Area	385–386
Scale to Fit	386
Terminology	383
Tiled	386
to PDF File	387
To Scale	386
Print Image	315
Dialog	389
Printers	
Select Printer	388

Q

Quoin	
Specification Dialog	266
Quoins	266

R

Radius	
End Cabinets	205
Rail Style Panel	127
Railings	111
Balusters	128
Decks	111
for Stairs	249
Glass	112
Half Walls	110
in a Doorway	175
Locate with dimensions	125
Middle Rail	128
Newels	129
Open	128
Openings	175
Solid	128
Stairs	243, 250
Type	128
Raised / Lowered Region	

Specification Dialog	360	Styles, Automatic	256
Ramp		Tools	256
Specification Dialog	251	Roof Designer	256
Rebuild	256	Roof Hole/Skylight	
3D.....	314	Specification Dialog.....	260
Roofs.....	256	Roof Planes	
Rectangular Polyline	102	Delete.....	258
Redo	100	Roofs	255–256
Reference		Auto Rebuild	256–257
Grid	50	Auto Roof Return	126
Remove		Build Roof Dialog	256
Backdrop.....	317	Defaults	255
Render		Dormers.....	261
Daytime Ambient	321	Hole for skylights.....	259
Graphics card.....	303	Knee walls	123
Interior Ambient.....	321	Min. Alcove	257
Light Sources	320	Overhang.....	257
Nighttime Ambient	321	Pitch.....	123
Preferences.....	54	Returns.....	263
Status	55	Skylights.....	259
Tips	319	Story-and-a-half	123
Rendering Techniques	323	Room	
Defaults	323	Defaults	132
Options	323	Specification Dialog.....	141
Reset		Room Labels	136
Defaults	49	Custom	136
Message Boxes	26	Display	136
Preferences.....	55	Edit	136
Reshape objects	95	Interior room area.....	136
Resize		Interior room dimensions	136
House using Dimensions.....	154	Room area.....	136
Objects	94	Standard room area.....	136
Restrictions		Room Types	133
Moving objects	93	Rooms	
Retaining Wall	355	Area	136
Reverse		Attic.....	133
Plan	97	Below Stairs.....	244
Rich Text		Editing	135
Defaults	157	Exterior types.....	133
Specification Dialog	159	Flat Ceiling over	144
Text Color	160	Interior.....	133
Right Button Definition	20	Interior area	136
Road		Interior dimensions	136
Specification Dialog	369	Living Area	133
Road Objects		Name for PlanCheck.....	44
Different Types	367	Open Below	133
Road Tools	367	Roof over	144
Roads		Room Definition	131
Displaying	368	Room Types	133
Roof	255	Selecting	134
Extend Slope Downward	126	Standard area	136
Full Gable Wall	126	The Exterior Room	134
Over this room.....	144	Types	132
Panel	126	Rotate objects	96
Second pitch	126	Round	
		Garden bed.....	354
		Pond.....	354

S

Sample Plans	
Download	392
Save	
3D Views.....	314
and Save As.....	34
Plan.....	34
Thumbnail Image.....	36
Scale	
Picture Files	333
Printing to	386
Terrain Data.....	365
Text Size.....	162
to Fit.....	386
Schematics, Wiring	215
Scroll Bars	64
Seat	
in Bay Window.....	195
Select	
Backdrop.....	317
Components of Blocked Units.....	186
Ctrl+Click	81
Library Object Dialog	283
Marquee.....	80
Material Dialog	297
Multiple Objects.....	80–81
Next Object	80
Objects button	80
Objects in 3D Views.....	314
Room.....	134
Selected Edge	80
Shift+Click.....	81
Similar Objects	80
Select Color Dialog	77
Selection Fill Color	51
Shadows	319
Ray Casted	319
Shelf	200
Shelf Ceiling	139
Shelf Tool	200
Shelf/Partition	
Specification Dialog	210
Shift Key	
Marquee selection	80
Select multiple objects	81
Shininess	301
Shortcut Keys	23, 58
Show	
Living Area.....	50
Reference Grid.....	50
Sheet.....	386
Shutters	193
Side Windows	22
Sidewalk	368
SidewalkTools	367
Skylights	256, 259
Sliding Doors	170
Snap Behaviors	67
Angle Snaps	68
Extension Snaps	68
Grid Snaps.....	50, 68
Object Snaps	68
Soffit	
Defaults.....	289
Specification Dialog.....	291
Soffits	200, 289
Calculating Materials	291
Corner	290
Special applications.....	290
Space Planning	41
Special	
Shaped Cabinets.....	204
Specification Dialogs	
Arc	104
Bay/Box Window	196
Bow Window	196
Cabinet.....	206
CAD Box.....	107
CAD Circle.....	105
CAD Ellipse	105
CAD Oval.....	105
Camera.....	315
Corner Boards.....	266
Cross Section/Elevation Camera.....	318
Default Sun Light	322
Dimension Line	154
Door	176
Dormer	262
Electrical Service	217
Elevation Line	359
Elevation Point.....	358
Elevation Region.....	359
Hill / Valley	359
Image	328
Library Object	285
Line	102
Plant Image	373
Polyline	106
Quoins.....	266
Raised/Lowered Region.....	360
Ramp	251
Rich Text	159
Road	369
Roof Hole/Skylight.....	260
Room	141
Shelf/Partition	210
Soffit.....	291
Stair Landing	252
Staircase	245
Terrain.....	357
Terrain Feature	360
Terrain Path.....	362
Text.....	137
Wall.....	124
Wall Hatch	130

Window 188

Splines 107

Split

 Level Entries 230

 Level Floor Plans 229

Stacked Windows 186

Stair

 Landing Specification Dialog 252

 Tools 233

Stair Designer 233

Stair Landing

 Specification Dialog 252

Stair Landings

 Height 240

Stair Railing

 Solid 243

Stair Treads

 Automatic 246

 Depth 246

 Lock Number 246

 Lock Tread Depth 246

 Number 246

 Overhang 247

 Thickness 247

Staircase

 Specification Dialog 245

Stairs

 Align Curved Stairs 94

 Auto Stairwell 243

 Balusters 249

 Change Line/Arc 239

 Click 234

 Curved 234, 236

 Deck to ground 236

 Direction 235

 Down 236

 Edit Handles 237

 Editing 237

 Handrails 250

 Landings 240

 Large Stringer Base 248

 Make Reach 245

 Merge Sections 238

 Newels 249–250

 Railings 243

 Reach Next Floor 245

 Rooms Below 244

 Section Width 246

 Stairwell 243

 Starter Treads 241

 Straight 234

 Stringers 247

 Subsections 245

 Terminology 234

 Tread Depth 241

 Treads 245

 Wrapped 242

Stairwell

 Automatic 243

Startup Options 17

Status Bar 26

 Angle style 56

Stem Walls 222

Stepped Foundations 225

Stepping Stones 355

Sticky Mode 71

Story-and-a-half 123

Straight

 Deck Edge 111

 Stairs 234

Streams 354

Structural Member Reporting 378

Sunlight Toggle 307

Swap

 Views 61

Switch

 Three way 216

Symbol

 Surface Normals 345

 vs. Native Objects 284

T

Tab Key 80

Tape Measure 150

Technical Support

 Contact 392

 Error Messages 392

 Online 392

 Online Knowledge Base 391

 Telephone 392

Temporary

 Dimensions 150

Temporary Dimensions 150

Terrain

 and 3D Draw Time 356

 Build 356

 Displaying 356

 Editing 356

 Elevation Data Tools 350

 Feature Tools 353

 Hill 353

 Holes 354

 Modifier Tools 352

 Specification Dialog 357

 Valley 353

 Wall and Curb Tools 355

Terrain Data

 Import 363

Terrain Feature

 Specification Dialog 360

Terrain Features

 Clip 360

 Height 360

Terrain Modeler	
3D Views.....	356
Terrain Path	
Specification Dialog	362
Terrain Perimeter	349
Text	
Aligning.....	162
Arrows	164
Bullets.....	161
Copy, Cut and Paste	162
Creating	159
Displaying	159
Editing	161
Layer	159
Line Spacing	161
Lists.....	161
Move.....	162
Numbering	161
Paragraph Options.....	161
Printed Size.....	162
Reshape	162
Resize.....	162
Rotate.....	162
Scaling.....	162
Specification Dialog	137
Text Style Defaults Dialog	165
Text Styles	165
Texture	
Filename Conflict Dialog	347
Textures	320
Thumbnails	36
Creating	36
Tiling Views	62
Toolbars	22
Drop-Down	57
Edit.....	23
Hide.....	57
Parent-Child	57
Transom Windows	175
Transparency	301
Trim	
Door.....	173

U

Undo	100
Files.....	37
Undo Zoom	64
Unrestricted Movement	93

V

Valley	353
Vents	185
Video Card	

Memory	303
OpenGL.....	303
Status.....	55

Videos	
View Online Help Videos	391

Views	
Tiling	62

Virtual Graph Paper	49–50
----------------------------------	-------

Visual CAD Snaps	49
-------------------------------	----

Volume	
Of a Polyline	106

W

Walkthroughs	335
Along a Path	335
Codecs	339
Create Path	335
Key Frames	336
Pause Recording.....	338
Playing	336
Recording	338
Save Frame	338
Stop Recording	338

Wall	
Angles	115
Assemblies	124
Cabinets	200
Defaults	110
Niche.....	184
Specification Dialog.....	124
Tools	110

Wall Hatch	
Specification Dialog.....	130

Walls	
Align between floors	122
Align collinear	121
and Material Painter	296
Attic Walls.....	123
Connecting	116
Curved.....	116
Curved, align between floors.....	122
Delete hatching	114
Display surfaces only.....	117
Drawing	114
Editing	119
Exterior and Interior.....	112
Fix Connections	116
Flip layers	115
Foundation.....	112
Full Gable Wall	126
Grid snapping	115
Half	128
Half Walls	110
Hatching	114
Heights	120
Invisible	113
Knee Wall	126

