

Home Designer Pro 2022

Professional 3D Home Design Software



Reference Manual

A description of the software interface, including drawing tools and settings.

Chief Architect, Inc
6500 N. Mineral Dr
Coeur d'Alene, ID 83815
www.homedesignersoftware.com

4/8/2022

© 1990–2021 by Chief Architect, Inc. All rights reserved.

No part of this documentation or accompanying software may be reproduced or transmitted in any form or by any means, electronic or mechanical, including photocopying, recording, or by any information storage and retrieval system, without permission in writing from Chief Architect, Inc.

Chief Architect® and Home Designer® are registered trademarks of Chief Architect, Inc.

This software uses **Open CASCADE Technology**. See <https://www.opencascade.com> for details. Open CASCADE is used under the GPL version 2.1 license.

This software uses the **FreeImage open source image library**. FreeImage is used under the FIPL license, version 1.0. See <https://freeimage.sourceforge.net> for details.

This software uses the **Ruby open source library**. See www.ruby-lang.org for details.

This application incorporates **Teigha® software** pursuant to a license agreement with Open Design Alliance. Teigha® Copyright © 2003-2018 by Open Design Alliance. All rights reserved.

3D input device development tools and related technology are provided under license from **3Dconnexion**. © 3Dconnexion 1992 - 2018. All rights reserved.

The **Sentry Spelling-Checker Engine** © 1994–2003 Wintertree Software Inc.

This software uses **Intel’s Embree library**, which is licensed under the Apache License version 2.0. See <https://github.com/embree/embree> for details.

This software uses the **OpenCOLLADA SDK**. Copyright © 2008-2012 NetAllied Systems GmbH, Ravensburg, Germany.

This software uses the **OpenVR SDK**. Copyright © 2015, Valve Corporation. All rights reserved. See <https://github.com/ValveSoftware/openvr> for details.

This software uses the **OpenCV open source computer vision library**. OpenVR and OpenCV are both used under the 3-clause BSD License. See <https://www.opencv.org> for details.

This software uses the **PDFium** PDF renderer, which is licensed under a three-clause BSD license and the Apache License version 2.0. Copyright 2014 PDFium Authors. All rights reserved.

All other trademarks and copyrights are the property of Chief Architect, Inc. or their respective owners.

Created in the United States of America.

Cover house designed by Michael Rust - Architect LLC.

Contents

Copyrights	2	Hotkeys	98
Program Overview	9	Gamepad Settings Dialog	99
Startup Options	10	Window and View Tools	101
The Home Designer Pro Environment	11	View Windows	102
Using Input Devices	13	Plan Views	102
View and Side Windows	16	Working in Multiple Views	103
Menus, Toolbars, and Hotkeys	17	View Tools	105
Dialogs	18	Zoom Tools	106
Edit Handles	21	Fill Window	107
The Status Bar	23	Panning the Display	107
Message Boxes	23	Closing Views and Files	108
Preferences and Default Settings	24	Creating Objects	110
Drawing a Plan	25	Architectural vs CAD Objects	111
Viewing Your Plan	26	Defaults and Preferences	111
Sharing Your Files with Clients	28	Snap Behaviors	112
Getting Help	28	Object Snaps	113
About Home Designer	29	Angle Snaps	114
Product Upgrade Options	29	Grid Snaps	115
Home Designer Trial Software	29	Creating Objects	115
File Management	31	Copying and Pasting Objects	117
Compatibility with Other Programs	32	Displaying Objects	122
Organizing Your Files	33	Displaying Objects	123
Home Designer Pro Data	33	Layers	123
Creating a New Plan or Layout	34	Layer Attributes	124
Saving, Exporting, and Backing Up Files	36	Layer Display Options Dialog	126
Thumbnail Images	39	Layer Sets	127
Auto Archive	40	Drawing Groups	128
Opening and Importing Files	41	Display Toggles	129
Referenced Files	43	Fill Styles	130
Backup Entire Plan or Project	44	Select Color Dialog	134
Exiting Home Designer	45	Editing Objects	136
Project Management	46	Defaults, Preferences, and Edit Behaviors	137
Space Planning	47	Selecting Objects	141
Room Box Specification Dialog	49	Selecting Multiple Objects	143
Finding Objects	50	Editing Line-Based Objects	145
Plan Check	50	Editing Arc-Based Objects	147
Loan Calculator	51	Editing Open Polyline-Based Objects	151
Preferences and Default Settings	53	Editing Closed Polyline-Based Objects	155
Default Settings vs Preferences	54	Editing Box-Based Objects	158
Dynamic Defaults	55	Editing Spline-Based Objects	160
Reset to Defaults	56	Editing Circles, Ovals and Ellipses	162
General Plan Defaults Dialog	56	Editing Multiple Objects	164
Preferences Dialog	59	Moving Objects	165
Dialog Number/Angle Style Dialog	87	Aligning Objects	168
Toolbars and Hotkeys	89	Resizing Objects	171
Toolbar Arrangement	90	Reshaping Objects	171
Customizing Toolbars	91	Rotating Objects	175
Creating Custom Toolbar Configurations	94	Reflecting Objects	177
Toolbar Customization Dialog	95	Converting Objects	179
		Transform/Replicate Object Dialog	180

Edit Area Tools	182	Room Types	282
Stretch CAD	184	Displaying Rooms	284
Eyedropper and Painter Tools	185	Selecting Rooms	284
Object Painter	187	Editing Rooms	286
Deleting Objects	187	Room Labels	288
Delete Objects Dialog	188	Room Label Specification Dialog	290
Undo and Redo	191	Decks	292
CAD Objects	192	Floor and Ceiling Heights	293
CAD Defaults and Preferences	193	Floor and Ceiling Platforms	295
The CAD Drawing Tools	194	Special Ceilings	297
Point Tools	195	Room Moldings	300
Line Tools	199	Room Specification Dialog	300
Line Specification Dialog	202	Dimensions	311
Drawing Arcs - Arc Creation Modes	206	Compatibility With Previous Versions	312
Arc Tools	207	Dimension Preferences and Defaults	312
Arc Specification Dialog	209	Dimension Defaults Dialog	313
Circle Tools	212	The Manually Drawn Dimension Tools	323
Circle/Oval/Ellipse Specification Dialog	213	Automatic Dimensions	325
Polylines	214	Displaying Dimension Lines	326
Polyline Specification Dialog	215	Selecting Dimension Lines	327
Box Tools	217	Editing Dimension Lines	328
Box Specification Dialog	218	Editing Extension Lines	329
Splines	219	Moving Objects Using Dimensions	332
Displaying CAD Objects	220	Dimension Line Specification Dialog	334
Walls, Railings, and Fencing	222	Text, Callouts, and Markers	337
Wall, Railing, and Fencing Defaults	223	Text Defaults and Preferences	338
Wall Tools	226	Fonts and Alphabets	339
Railing and Deck Tools	227	The Text Tools	340
Fencing Tools	230	Creating Text, Callouts and Markers	341
Exterior and Interior Walls	230	Displaying Text Objects	341
Foundation Walls	231	Rich Text Specification Dialog	342
Pony Walls	232	Editing Text	347
Room Dividers and Invisible Walls	233	Copying and Pasting Text	350
Polygon Shaped Decks	234	Find/Replace Text	351
Wall Hatching	235	Text Arrows	352
Creating Walls	236	Callouts	354
Connecting Walls	238	Callout Specification Dialog	355
Displaying Walls	240	Editing Callouts	357
Measuring Walls	242	Markers	357
Editing Walls	244	Marker Specification Dialog	358
Edit Handles for Walls	247	Editing Markers	359
Editing Straight/Curved Wall Combinations	249	Text Styles	360
Aligning Walls	249	Object Labels	362
Roof Directives in Walls	252	Label Panel	363
Attic Walls	254	Doors	365
Stepped and Raked Walls	255	Door Defaults	366
Wall Type Definitions	256	Door Tools	367
Wall Type Definitions Dialog	259	Displaying Doors	369
Wall Specification Dialog	262	Editing Doors	371
Railing and Fencing Specification Dialogs	274	Changing Door Swings	374
Wall Hatching Specification Dialog	278	Special Doors	376
Rooms	279	Door Specification Dialog	378
Room Definition	280	Windows	393
Floor and Room Defaults	280		

Window Defaults	394
Window Tools	394
Special Windows	396
Grouped Windows	398
Window Levels	399
Displaying Windows	401
Editing Windows	403
Window Specification Dialog	404
Bay, Box, and Bow Windows	422
Bay, Box, Bow Windows and Roofs	424
Bay/Box and Bow Window Specification Dialogs	426
Cabinets	431
Cabinet Defaults	432
The Cabinet Tools	434
Cabinet Fillers	436
Placing Cabinets	436
Countertops	437
Custom Backsplashes	439
Displaying Cabinets	439
Cabinet Labels	441
Cabinet Construction	443
Editing Cabinets	444
Editing Cabinet Styles	446
Special Cabinets	448
Cabinet Specification Dialog	450
Cabinet Shelf Specification Dialog	461
Shelf/Partition Specification Dialog	462
Custom Countertop Specification Dialog	463
Custom Backsplash Specification Dialog	466
Electrical	468
Electrical Defaults Dialog	469
The Electrical Tools	470
Placing Electrical Objects	472
Auto Place Outlets	472
Creating Wiring Schematics	473
Electrical Library Content	474
Displaying Electrical Objects	474
Editing Electrical Objects	475
Electrical Service Specification Dialog	476
Foundations	481
Foundation Defaults	482
Foundation Defaults Dialog	482
Building a Foundation	485
Displaying Foundations	487
Editing Foundations	488
Deleting Foundations	490
Foundations and Rooms	490
Foundations and the Terrain	491
The Slab Tools	493
Editing Slabs	493
Slab Specification Dialog	494
Editing Piers and Pads	495
Fireplaces	496
Fireplace Specification Dialog	497
Library Fireplaces	499
Chimneys	500
Multiple Floors	501
Floor Defaults Dialog	502
Floor Tools	502
Adding Floors	503
Displaying Floors	504
Exchanging Floors	505
Copying Floors	506
Deleting Floors	506
Rebuilding Walls, Floors and Ceilings	506
Split Levels	507
The Current Floor	508
The Attic Floor	509
The Reference Floor	509
Stairs, Ramps, and Landings	510
Stair and Ramp Defaults	511
The Stair Tools	511
Anatomy of a Staircase	512
Drawing Stairs and Ramps	513
L- and U-Shaped Stairs	515
Displaying Stairs, Ramps, and Landings	516
Editing Stairs and Ramps	517
Stair and Ramp Sections and Subsections	518
Landings	521
Maintaining Tread Depth	523
Flared Stairs and Curved Treads	524
Starter Treads	527
Winders	529
Wrapped Stairs	530
Other Special Railings and Stairs	531
Creating a Stairwell	535
Rooms Below Staircases	537
Staircase Specification Dialog	538
Ramp Specification Dialog	550
Stair Landing Specification Dialog	553
Roofs	556
Automatic vs. Manual Roofs	557
Roof Defaults	557
The Roof Tools	558
Automatic Roofs	560
Build Roof Dialog	562
Roof Planes	570
Displaying Roofs	572
Editing Roof and Ceiling Planes	573
Connecting Roof and Ceiling Planes	576
Roof Plane Specification Dialog	578
Roof Baseline Polylines	583
Roof Baseline Specification Dialog	584
Roof and Ceiling Framing	586
Ceiling Planes	586
Ceiling Plane Specification Dialog	587
Gable/Roof Lines	590
Gable Line Specification Dialog	593

Skylights and Roof Holes	593	Organizing the Library	682
Roof Hole/Skylight Specification Dialog	594	Filtering the Display of Library Content	684
Dormers and Crickets	596	Exporting Library Catalogs	686
Editing Auto Dormers	598	Placing Library Objects	686
Dormer Specification Dialog	599	Select Library Object Dialog	688
Roof Returns and Other Details	601	Place Library Object Button	688
Roof Pitches in Degrees	604	Replace From Library	689
Framing	605	Displaying Library Objects	690
Framing Defaults	606	Editing Library Objects	691
Manual vs. Automatic Framing	608	Symbol Object Specification Dialogs	693
Framing Tools	611	Architectural Blocks	696
Build Framing Dialog	613	Creating Architectural Blocks	697
Framing Reference Markers	628	Displaying Architectural Blocks	697
Joist Direction Lines	630	Editing Architectural Blocks	698
Joist Direction Specification Dialog	630	Architectural Block Specification Dialog	699
Bearing Lines	631	Architectural Blocks, Sub-Objects, and	
Displaying Framing	632	Components	700
Editing Framing	634	Other Objects	702
Keeping Framing Current	635	General Shapes	703
Framing and the Materials List	636	Soffits	703
Framing Specification Dialog	637	Special Applications for Soffits	704
Trusses	641	Soffit Specification Dialog	706
Truss Defaults	642	Material Layers Definition Dialogs	709
Floor and Ceiling Trusses	642	Materials	711
Roof Trusses	642	About Materials	712
Drawing Trusses	643	Material Defaults	712
Displaying Trusses	644	Material Painter Tools	713
Editing Trusses	644	Materials Panel	716
Editing Truss Envelopes	646	Select Material/Library Object Dialog	717
Truss Labels	647	Editing Materials	719
Mixing Trusses with Stick Framing	647	Creating Materials	721
Hip Trusses	648	Mapping Patterns and Textures	722
Special Roof Trusses	649	Materials and the Materials List	723
Roof Truss Specification Dialog	652	Managing Plan Materials	725
Floor/Ceiling Truss Specification Dialog	656	Define Material Dialog	726
Framing and Truss Schedules	658	3D Views	735
Trim and Moldings	659	Types of 3D Views	736
Trim and Molding Defaults	660	3D View Defaults and Preferences	736
Corner Boards	660	Camera Defaults Dialogs	737
Corner Board Specification Dialog	661	3D View Defaults Dialog	739
Quoins	662	3D View Tools	740
Quoin Specification Dialog	662	Creating Camera Views	741
Editing Corner Boards and Quoins	664	Creating Overviews	742
Millwork	665	Cross Section/Elevation Views	744
Applying Moldings	665	Clipped Section Views	745
The Library	668	Displaying 3D Views	747
The Library Browser	669	Navigating in Camera Views	749
Searching the Library	675	Editing 3D Views	754
Find in Library	676	Cross Section Slider	756
Library Content	677	Working in 3D	757
Downloading Library Content	678	Saving and Printing 3D Views	759
Importing Library Catalogs	679	Camera Specification Dialogs	760
Adding Library Content	681	Cross Section/Elevation Specification Dialogs	765

3D Rendering	769
Rendering Tips	770
Lighting	772
Light Types	773
Displaying Lights	774
Lighting Modes	775
Light Specification Dialog	777
Sun Angles and Shadows	778
Sun Angle Specification Dialog	781
Adjust Sunlight Dialog	783
Rendering Techniques	785
Rendering Technique Options	787
Pictures, Images, and Walkthroughs	794
Picture Files vs Pictures and Image Objects	795
Images	795
Displaying Images	796
Editing Images	797
Image Specification Dialog	797
Pictures	801
Picture File Box Specification Dialog	802
Metafiles	804
Metafile Box Specification Dialog	806
PDF Files	807
PDF Box Specification Dialog	808
Displaying Pictures, Metafiles, and PDF Boxes	809
Editing Pictures, Metafiles, and PDF Boxes	810
3D Backdrops	812
Backdrop Specification Dialog	813
Walkthrough Paths	815
Walkthrough Path Specification Dialog	818
Walkthrough Previews	820
Recording a Walkthrough	823
Importing and Exporting	827
Chief Architect Account Login	828
Export Chief Architect 3D Viewer File	828
Import Room Planner File	830
DXF vs DWG File Formats	830
Importing 2D Drawings	831
Import Drawing Assistant	832
Exporting 2D DXF/DWG Files	836
Additional 2D Export Information	837
3D Data Import Requirements	839
Importing 3D Symbols	840
Symbol Specification Dialog	840
3D Symbols and Materials	842
Exporting a 3D Model	843
Export 360 Panorama	844
Export Thermal Envelope Data	845
Terrain	846
Terrain Toolbar Configuration	847
Terrain Perimeter	847
Elevation Data Tools	849
Terrain Modifier Tools	854
Terrain Feature Tools	855

Garden Bed Tools	856
Water Feature Tools	857
Stepping Stone Tools	858
Terrain Wall and Curb Tools	858
Sun Shadows	859
Terrain Objects in the Library	859
Displaying Terrain	860
Editing Terrain Objects	861
Terrain Specification Dialog	861
Elevation Point Specification Dialog	865
Elevation Line/Region Specification Dialog	866
Flat Region Specification Dialog	868
Hill / Valley Specification Dialog	868
Raised / Lowered Region Specification Dialog	869
Terrain Feature Specification Dialog	869
Garden Bed Specification Dialog	871
Terrain Break Specification Dialog	874
Terrain Path Specification Dialog	874
Importing Elevation Data	876
Import Terrain Assistant	877
Import GPS Data Assistant	879
Importing DWG/DXF Elevation Data	881
Converting CAD Objects to Terrain Data	882
Roads, Driveways and Sidewalks	883
Road, Driveway, and Sidewalk Tools	884
Displaying Road Objects	885
Editing Road Objects	886
Road Specification Dialog	886
Plants and Sprinklers	889
Plant Tools	890
Plant Chooser Dialog	891
Hardiness Zones	893
Plant Image Specification Dialog	893
Sprinkler Tools	897
Sprinkler Specification Dialogs	897
Plant Schedules	898
Schedule Numbering and Columns	899
Plant Schedule Specification Dialog	899
Materials Lists	904
The Materials List Tools	905
Creating an Accurate Materials List	906
Structural Member Reporting	907
Organizing Materials Lists	908
Materials List Specification Dialog	909
Materials List Columns	912
Editing Materials Lists	914
Find Object in Plan	915
Saving and Managing Materials Lists	916
Printing and Exporting the Materials List	916
The Master List	918
Object Components	920
Object Information Panel	922
Layout	924

Layout Preferences and Defaults	925
The Layout Tools	925
Creating a Layout File	926
CAD and Text in Layout	926
Pictures, Metafiles, and PDFs in Layout	927
Sending Views to Layout	927
Keeping Layout Views Current	929
Displaying Layout Views	932
Editing Layout Views	932
Layout Box Specification Dialog	934
Opening Layout Views	935
Managing Layout Links	936
Printing Layout Files	938
Exporting Layout Files	938
Printing and Plotting	939
Introduction to Printing	940
Printers and Plotters	940
Printing Defaults	941
The Printing Tools	942
Drawing Sheet Setup Dialog	943
Print Preview	947
Printing to Scale	948
Printing Across Multiple Pages	950
Printing to a PDF File	950
Line Weights	950
Watermarks	953
Print View Dialog	955
Print Image Dialog	958
Resources and Support	961
Learning and Inspiration	962
Contacting Technical Support	963
Error Messages	963
Program Paths Dialog	964
What's New in Home Designer 2022	965
Getting Started Checklist	966
Migrating Legacy Content	967
Migrating Legacy Settings	967
Migrating Legacy Templates	968
Considerations for Legacy Files	968
New and Improved Features by Chapter	973
Index	979

Program Overview

Chapter 1

Home Designer Pro is specifically designed for the residential and light commercial design professional. It allows you to easily and efficiently produce 3D models and construction documents for your projects. We thank you for choosing Home Designer and wish you the best in your design work.

TOPICS

Startup Options	10
The Home Designer Pro Environment	11
Using Input Devices	13
View and Side Windows	16
Menus, Toolbars, and Hotkeys	17
Dialogs	18
Edit Handles	21
The Status Bar	23
Message Boxes	23
Preferences and Default Settings	24
Drawing a Plan	25
Viewing Your Plan	26
Sharing Your Files with Clients	28
Getting Help	28
About Home Designer	29
Product Upgrade Options	29
Home Designer Trial Software	29

Startup Options





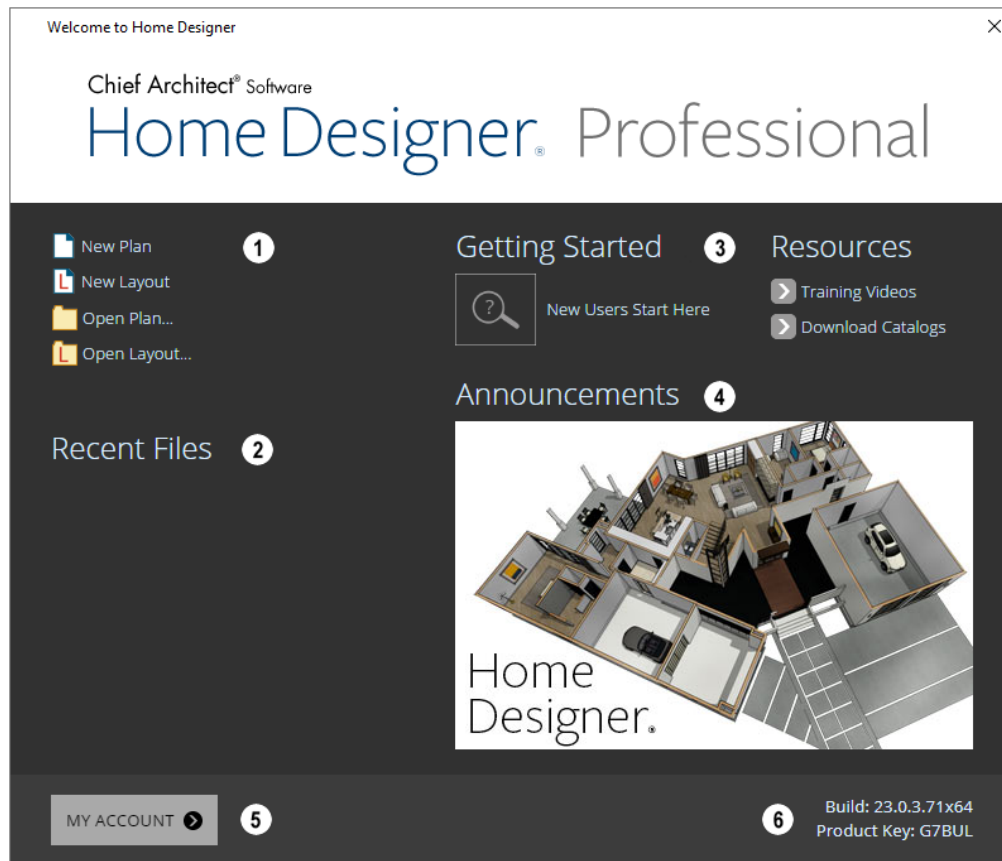

When Home Designer opens, the Startup Options dialog displays, allowing you to choose how you want to begin working in the program or access useful resources.

The Startup Options dialog can be opened at any time by selecting **File> Startup Options** .



1 New/Open File

Select a **File** command to open a .plan or .layout file.

- Click **New Plan**  or **New Layout**  to open a new, blank file. See [Creating a New Plan or Layout on page 34](#).
- Choose **Open Plan**  or **Open Layout**  to work on an existing or layout file. See [Opening and Importing Files on page 41](#).

2 Recent Files

The full pathnames of the most recently opened files are listed here. Click on a name to open the file. You set the number of files in this list in the Preferences dialog. See [General Panel on page 66](#).



Move your mouse pointer over a name to see the file's full pathname.

3 Getting Started & Resources

A selection of useful online **Getting Started** options and **Resources** are available here. Click on an option to launch your default internet browser to HomeDesignerSoftware.com.

- Click **Getting Started** to visit the Getting Started page on our website with links to a variety of resources to help you begin using the program.
- Click **Training Videos** to access a searchable collection of videos focused on specific topics.
- Click **Download Catalogs** to visit our 3D Library of downloadable bonus and manufacturer library catalogs. See *Library Content on page 677*.

4 Announcements

When an internet connection is available, the **Announcements** section displays updated messages and news from Chief Architect.

5 My Account

Click **My Account** to launch your default internet browser to the Login page on our website.

6 Build & Product Key

Your software version's **Build** number and the first five characters of your **Product Key** display here for reference.

To prevent the Startup Options dialog from displaying when you launch Home Designer, uncheck **Show Options on Startup** in the Preferences dialog. See *General Panel on page 66*.

The Home Designer Pro Environment

Home Designer is designed to be intuitive and efficient.

3D DRAFTING

In Home Designer, the drawing area is laid out on a Cartesian grid, a three dimensional coordinate system described using the X, Y, and Z axes. The current position of your mouse pointer displays in the Status Bar at the bottom of the program window.

Architectural objects take up space in all three dimensions and their height, width and depth can be specified in Imperial or metric units. In addition, the location of objects can be precisely defined using coordinates, again specified in Imperial or metric units.

CAD objects such as lines and arcs take up space in two dimensions in the current view. Their dimensions can also be specified in Imperial or metric units and their locations precisely defined using coordinates.

Objects can be rotated relative to the Cartesian grid system, as well. When the program presents the option to rotate to an Absolute Angle, this angle will be measured relative to an imaginary horizontal line drawn in floor plan view from the origin in the positive X direction.

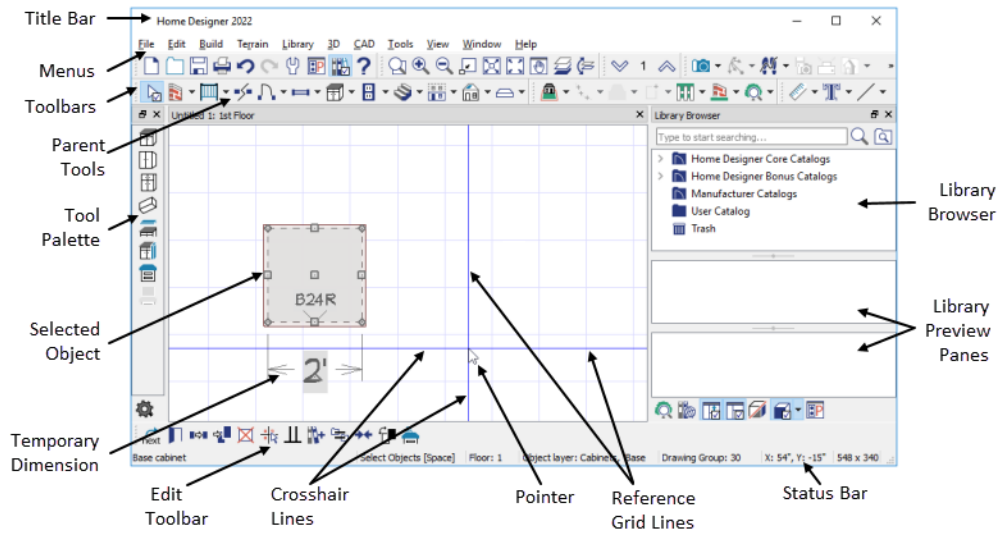

EASY ACCESS TO TOOLS

You can access Home Designer’s features in various ways using the mouse and keyboard.

- Convenient toolbar buttons allow fast access to frequently-used tools and let you customize the interface.
- Menus provide access to most tools and settings.
- Keyboard shortcuts are available for most tools.
- Contextual menus display with a right-click of the mouse.
- *The Status Bar on page 23* at the bottom of the screen provides tool descriptions and other information about the current task.

OBJECT-BASED DESIGN

Home Designer’s parametric, object-based design technology means you place and edit objects, rather than work with the many individual lines or surfaces used to represent them.

You can quickly select and edit the location, size, shape, style and other properties of objects as well as change the materials applied to their surfaces.

Use Home Designer’s editing capabilities to make the objects you place in a plan match the objects they represent in real life. For example, you can set up your windows and doors to match those available from your supplier.

INTERFACE TOGGLES

A number of useful drawing and editing behaviors, as well as the display of important elements in the interface, can be easily enabled and disabled using the menus and toolbars.

- Object Snaps, Angle Snaps, and Grid Snaps can be toggled on or off as needed. Individual Object Snaps and Extension Snaps can be toggled as well. See *Snap Behaviors on page 112*.
- Display Elements like Print Preview, Show Line Weights, and the Reference Display can be turned on when needed and then toggled off.
- Special Edit Behaviors can be enabled for particular tasks, then replaced by the Default Behavior. See *Defaults, Preferences, and Edit Behaviors on page 137*.

When a setting is turned on, or a tool is selected, its toolbar icon will be shaded and a small check is displayed at its lower right corner. In Windows its menu icon will appear the same, but in Mac OS only a large check will be displayed to the left of the icon.

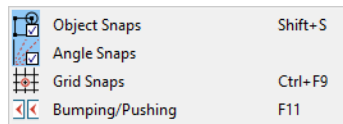

Menu in Windows

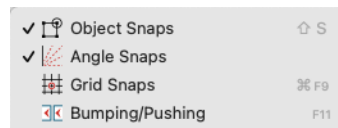

Menu in Mac OS

Many of these interface elements are global Preferences while others are file-specific default settings. See [Default Settings vs Preferences on page 54](#).

Using Input Devices

You can interact with Home Designer using a variety of input devices.

KEYBOARD

A keyboard is necessary for entering text and size values. See [Dialogs on page 18](#).

Your keyboard can also be used to navigate the dialog panels, as well as navigate the program menus. Many commands can also be invoked using keyboard hotkeys. See [Menus, Toolbars, and Hotkeys on page 17](#).

In addition to the keyboard, a mouse or other device that can move a pointer is necessary in order to draw, select, and edit objects in your drawings.

THREE BUTTON MICE

Left Button



The **left button** is the primary button used in Home Designer. Unless specified otherwise, Home Designer documentation refers to the left mouse button.

Many objects, such as doors and cabinets, are created by clicking the left mouse button. Others, such as walls, stairs and dimension lines, are created by dragging the pointer from one end of the object to the other.

Note: If you are left-handed and have re-programmed your mouse, reverse the instructions for left and right buttons in this manual.

Right Button



The **right button** has several uses:

- Right-click to select any object. If, for example, the **Straight Exterior Wall**  tool is active, the left mouse button only allows you to select walls. You can, however, select other types of objects such as cabinets with the right mouse button.
- Use the right mouse button to temporarily switch to the Alternate edit behavior. See *Defaults, Preferences, and Edit Behaviors on page 137*.
- You can also use the right mouse button to open a context sensitive menu with additional editing commands. See *Contextual Menus on page 18*.

Middle Button



The **middle button** can be used to pan in most view types or to temporarily use the Move edit behavior. To close a tabbed view window, click on its tab using the middle mouse button. You can also program it to work as a double-click.

If your mouse does not have a middle mouse button, in the Mac version of Home Designer you can use the left button and the Command key to achieve the same results.

Mouse Wheel



The **mouse wheel** can be used to zoom in and out in most view types. See *Zoom Tools on page 106*.

The Back, or X1, button on a 5-button mouse can be used to temporarily enable the Concentric edit behavior. See the documentation for your mouse.

The Forward, or X2, button on a 5-button mouse can be used to temporarily enable the Resize edit behavior. See the documentation for your mouse.

3D MICE

3Dconnexion®'s 3D mice can be used to navigate in Home Designer. For information about navigating in camera views and overviews, see *3Dconnexion® 3D Mice on page 750*.

TRACKPADS

In addition to the standard trackpad gestures on your system, in Home Designer you can pinch to zoom.

In macOS™, you can Option + click to pan. Panning with a trackpad is not supported in the Windows version of the software, however.

TOUCH SCREENS

Standard one-finger touch screen gestures are supported in both the Windows and Mac versions of the software. In the Windows version, touching with a second finger to cancel an action is also supported, as are two-finger pan and two-finger pinch to zoom.

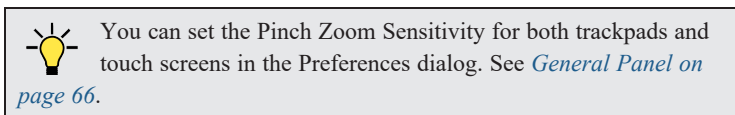

GAMEPADS



In the Windows version of Home Designer, gamepads can be used to navigate in camera views, overviews, as well as elevation views. See *Gamepads on page 750*.

CROSSHAIRS











 Crosshairs help you position the pointer relative to objects in a view while drawing and editing. They can be set to display in Plan and Cross Section/Elevation views, and in Perspective and Orthographic camera views. Select **View> Crosshairs** to toggle crosshairs on or off in the current view type.

You can customize the Crosshairs' appearance and control their display in different view types in the Preferences dialog. See [Edit Panel on page 75](#).

POINTER ICONS

The appearance of the pointer in Home Designer will vary, depending on which tool is active. For example, when the **Select Objects**  tool is active, it will look like a white arrow, and when a **Cabinet Tool**  is active, it will look like a base cabinet with a small cross.

In addition, one or more additional icons may follow the pointer if a recommended setting is not in use or if a problematic condition exists in the file:

Icon	Reason
	Angle Snaps has been disabled. See Angle Snaps on page 114 .
Alt	The Alternate Edit Behavior has been selected. See Alternate on page 138 .
	The Resize Edit Behavior has been selected. See Resize on page 138 .
	The Concentric Edit Behavior has been selected. See Concentric on page 139 .
	The Fillet Edit Behavior has been selected. See Fillet on page 140 .
	Connect CAD Segments has been disabled. See Connect CAD Segments on page 140 .
	The Rotate/Resize About Current Point Edit Behavior has been selected. See Rotate/Resize About Current Point on page 141
	Auto Rebuild Terrain has been disabled. See Auto Rebuild Terrain on page 849
	Rebuild Walls, Floor and Ceilings has been disabled. See Rebuilding Walls, Floors and Ceilings on page 506
	A bad wall connection has been detected. See Fix Wall Connections on page 239
	An irregular wall angle has been detected. See Wall Angles on page 236
	A reversed wall has been detected. See Reverse Layers on page 245

You can turn the display of these informative pointer icons in the Preferences dialog if you wish. See [Behaviors Panel on page 76](#).

View and Side Windows

Home Designer Pro's main program window has a number of important features that let you interact with the program, such as toolbars and menus. It also features two different kinds of windows: view windows and side windows.

VIEW WINDOWS

View windows are sometimes referred to as “the drawing area” because most of them are windows in which you can draw or place architectural and/or CAD objects. There are a number of different types of view windows in Home Designer:

- Plan views
- Camera views and overviews
- Cross section/elevation views
- Materials Lists
- Layout

View windows can be navigated by panning and zooming. You can also enable scrollbars on their right side and bottom. Select **View > Scrollbars**  to toggle their display. See [View Tools on page 105](#).

Although only one view window can be active at any given time, there is no limit to the number of view windows that can be open. View windows can be tiled or tabbed, and you can navigate between them in a number of different ways. See [Window and View Tools on page 101](#).

You can also tear a view window out of the main program window. This creates a second, separate program window complete with toolbars and menus. Individual view windows can be torn out and transferred between program windows.

SIDE WINDOWS

Side windows provide access to a variety of tools and content that helps you add detail your drawings.

Side windows are so-named because they are typically docked to either the left or right side of the program window - although, they can also be docked to the top or bottom, or undocked entirely. There are two side windows in Home Designer:

- [Child Tool Palette on page 90](#)
- [The Library Browser on page 669](#)

Each of these side windows can be opened via the **View** menu or by clicking the toolbar button associated with it. Similarly, each can be closed by clicking the **Close** button in its title bar or tab, via the **View** menu, or by clicking its toolbar button. See [View Tools on page 105](#).

To undock a side window, either drag its title bar out into the drawing area or click the Undock button on its title bar. To dock a side window, drag its title bar to any side of the program window. You can also double-click on its title bar to return it to its last docked location.

Two or more side windows can be docked together to form a shared side window, and can be tiled and/or tabbed within that shared window. To create a shared side window, begin by docking a side window to a side of the main program window, then:

- To create tabbed side windows, drag a second side window over the first. When the docked window becomes highlighted, release the mouse button.
- To create tiled side windows, drag a second side window over the first. When the docked window becomes highlighted, slowly drag the mouse towards one of its sides. When a highlighted space is created along that side, release the mouse button.

You can choose to disable **Side Window Drag Docking** in the Preferences dialog, and you can also enable **Top/Bottom Docking**. See [Appearance Panel on page 60](#).

Side windows can also be set to their initial states in the Preferences dialog. See [Reset Options Panel on page 86](#).

Menus, Toolbars, and Hotkeys

Home Designer's drawing, editing, and view tools can be accessed via menus, toolbar buttons, and keyboard hotkeys.

PROGRAM MENUS

Home Designer's program menus are located below the title bar in the program window and can be used to access nearly all tools in the program. Click on a menu name to expand it, then click on a menu item to either activate that tool or access the item's submenu. Items with a submenu have an arrow to the right of the name.

In the Home Designer documentation, menu paths are written in this format: **Tools> Floor/Reference Display> Up One Floor** .

The menus can be accessed using the keyboard:

- Press the Alt key once to enable this functionality - one letter in each menu will become underlined.
- Press the key associated with one of these underlined letters to expand its menu - one letter in each menu item's name will be underlined. Press the key associated with one of these letters to activate that tool or access the item's submenu.
- Press the Esc key to undo your last selection, or click with the mouse to exit out of this functionality.

Menu items with an icon to their left have a toolbar button associated with them. In addition, many tools can also be activated using keyboard hotkeys. If a menu item has a hotkey, it will display to the right of the item's name.

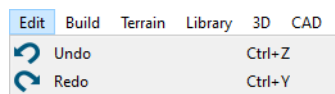

Edit menu items with button icons to the left and hotkeys to the right

TOOLBARS AND HOTKEYS

Home Designer installs with a set of toolbars docked to the margins of the program window. Using these toolbar buttons is a fast and easy way to access many program features. If a tool is active, a small check mark will display at the lower right of its button icon. See [Toolbars and Hotkeys on page 89](#).

The Edit Toolbar is a special toolbar with buttons that can be used to modify a selected object or objects. The buttons on this toolbar vary, depending on the type(s) of object selected, the current view, and how you selected the object; when no object is selected, the Edit Toolbar is blank. See [The Edit Toolbar on page 91](#).

You can move the toolbars, customize them by adding or removing buttons, or create your own toolbars from scratch. See [Toolbar Customization Dialog on page 95](#).

Many tools also have a keyboard hotkey associated with them. See [Hotkeys on page 98](#).

CONTEXTUAL MENUS

Contextual menus are context-sensitive menus that display tools relevant to a selected object or view. To open a contextual menu, right-click on an object, in an empty space in a view window, on a line item in the Library Browser, or in a text field in a dialog box.

Contextual Menu for Plan Views

The options in an object's contextual menu are usually the same as those on an object's Edit Toolbar. See [The Edit Toolbar on page 91](#).

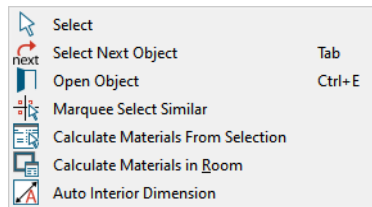

Contextual Menu for a selected room

Contextual menus can be enabled or disabled in the Preferences dialog. When contextual menus are disabled, right-clicks perform generic object selection, much like when the **Select Objects**  tool is active. See [Appearance Panel on page 60](#).

Dialogs

Default and preference settings, object specifications, display settings, and many other functions are accessed through dialog boxes.

Note: Some of the dialog box images in the software documentation have been resized smaller than their actual minimum size.

DIALOG PANELS

Many dialogs have multiple panels, which are listed in a tree list on the left side of the dialog. Click on a panel name in the list to make it active. In Windows, panels can also be navigated using the keyboard. Press:

- **Ctrl + Tab** or **Ctrl + F6** to navigate forward;
- **Ctrl + Shift + Tab** or **Ctrl + Shift + F6** to navigate backward.

When a panel name is actively selected in the list, you can also navigate the tree list using the **Up** and **Down** arrow keys.

By default, dialogs always open to the first panel in the list; if you prefer, you can choose to **Open Dialogs to the Last Panel Visited**. See [General Panel on page 66](#).

UNITS AND MATH OPERATIONS IN DIALOGS

The units of measurement used in dialogs are determined by your choice of template files. See [Creating a New Plan or Layout on page 34](#).

The number format used in dialogs are set based on your operating system's defaults. See [Region and Language Settings on page 55](#). You can change the number format as well as the angle format in the Dialog Number Style/Angle Style dialog. See [Dialog Number/Angle Style Dialog on page 87](#).

Basic addition, subtraction, multiplication, and division can be performed in the text boxes where numeric values are entered.

Note that settings for angle, pitch, or bearing do not support math, nor do those with spin controls or slider bars.

- To add, type the + character followed by the amount that you wish to add. Spaces are ignored and including a unit of measurement is optional.
- To subtract, type the - character followed by the amount you wish to subtract. As with adding, spaces are ignored and a unit of measurement is optional.
- To multiply, type the * character followed by the amount you wish to multiply by. Spaces are ignored, and only one of the values being multiplied can have a unit of measurement.
- To divide, type the / character followed by the amount you wish to divide by. To divide, there must be a space before the / - if there is not, the input may be treated as a fraction. The denominator, or value typed after the /, cannot have a unit of measurement.

Math expressions support a single operation only: more than one operation character (+, -, *, /) at a time is not allowed.

Basic math operations can also be used to move objects using dimensions. See *Moving Objects Using Dimensions on page 332*.

DIALOG SIZE AND POSITION

Dialog boxes can be both moved and resized to suit your needs. By default, the program will remember both the position and size that you specify for a dialog and use it the next time you open it. The size of dialog preview panes can also be changed, and are remembered as well. You can specify whether the program does this always, per session, or never in the Preferences dialog. See *General Panel on page 66*.

- To move a dialog, position your mouse pointer within its title bar and then simply click and drag.
- To resize a dialog, position your mouse pointer on any edge or corner and then click and drag outward or inward. If you drag an edge, only that edge will move; if you drag a corner, the two adjacent edges will move.
- To resize a preview pane, click and drag the vertical grab handle to its left. See *Dialog Panel Splitters on page 20*, below.

When a dialog is resized, some elements such as list boxes and text fields within it may resize in response.

All dialogs have a minimum size limitation but no maximum size. If a dialog opens on a monitor with resolution too low to display its full extents, it will have vertical and/or horizontal scrollbars.

You can reset the default sizes and positions of all dialogs in the Preferences dialog. See *Reset Options Panel on page 86*.

SPECIFICATION DIALOGS

 Each object in Home Designer has a unique specification dialog where you can enter size, style and other information specific to the selected object. To access it, select the object and click the **Open Object** edit button.

You can also double-click on an object with the **Select Objects**  tool active to open its specification dialog. See *Selecting Objects on page 141*.

In addition, you can access an active camera view's specification dialog by selecting **3D> Edit Active Camera** . The 3D View tools also have defaults dialogs where you can specify the initial attributes of camera views. See *3D Views on page 735*.

Most objects also have a defaults dialog that lets you specify the initial values in the specification dialog. See *Default Settings on page 54*.

You can open the specification dialog for group-selected objects if they are of the same type, such as base cabinets.

- If a particular setting varies among the different objects, its check box will have a solid fill instead of a check mark. Click once to clear the box for all selected objects, or click a second time to place a check mark for all selected objects.
- In some dialogs, if a particular setting varies among the different objects, it will have a “No Change” radio button. Leave this button selected, or choose a different option to apply it to all objects in the selection set.
- If the setting has a text field or drop-down list, it will say “No Change”. Changes made to such a setting can be undone by replacing the value in the text field with the letter N before you click OK.

If you select multiple objects of different types, the **Open Object**  edit button is usually not available. This button may be available if the objects have data in common, but you can only edit the common data.



DIALOG PREVIEW PANES

Many specification dialogs have a preview pane that shows how changes to settings affect the selected object. This preview updates when you click in a different field or press the **Tab** key on your keyboard.

If you switch to a panel with settings that affect the selected object’s appearance in a certain view, that view will be shown in the preview. For example, if you select the GENERAL panel, a 3D view will be shown; but if you select the FILL STYLE panel, floor plan view will be shown. When floor plan view is shown, the primary and all secondary layers associated with the object will display. See *Primary and Secondary Layers on page 124*.

When you click in the preview pane, your mouse pointer changes to a four-headed arrow and you can rotate around the object as well as zoom in and out using the mouse scroll wheel. Some objects, notably walls, doors, and windows, have Interior and Exterior labels to indicate which side is visible in the preview. Click the **Fill Window**  button above the preview pane to zoom in or out so that the object fills the extents of the pane, maintaining the current rotation.

In most dialogs, the Standard, Vector View, and Glass House Rendering Techniques can be applied to the preview. See *Rendering Techniques on page 785*. You can specify whether Standard or Vector View is used by default in the Preferences dialog. See *Appearance Panel on page 60*.

Click the **Color**  button to turn color in the preview off or on. Some objects have additional tools that affect object previews. For example, the Cabinet Specification dialogs have a **Select Cabinet Face Item**  button. Object specific tools like this are discussed in the documentation for that object type.

Note: When multiple objects are selected, their shared specification dialog preview will typically only show one of the objects.



DIALOG PANEL SPLITTERS

Many dialog panels are divided into up to three sections: a list of panels on the left, an object preview on the right, and a central area where settings are located. The vertical splitters separating these sections each have a pale grey, vertical grab handle.

To resize the panel list or preview, as well as the area in the middle, move your mouse pointer over the vertical grab handle: when the splitter cursor  can be seen, click and drag to the left or right.

KEYBOARD NAVIGATION

Dialog panels and settings can be accessed using the mouse. You can also navigate the settings on a given dialog panel using the keyboard. For example:

- Line items in tree lists can be browsed using the arrow keys. **Up** and **Down** navigate the list, while **Left** and **Right** expand and contract categories.
- Press the **Tab** key to shift focus from the tree list to the first setting on the selected panel.
- Press the **Tab** key to shift focus from one setting to the next, or **Shift + Tab** to go in the reverse direction.
- A check box can be checked or cleared by pressing the **Spacebar** or the + or - keys, respectively, while it is in focus.
- Columns of radio buttons can be navigated using the **Up** and **Down** arrow keys; rows can be navigated using the **Left** and **Right** arrows. Select a radio button by pressing the **Spacebar** while it is in focus.
- Settings in list boxes can be navigated using the **Up** and **Down** arrow keys. When a check box is in focus, it can be checked or cleared by pressing the **Spacebar**.
- Drop-down lists can be browsed using the **Up** and **Down** arrow keys. When the mouse pointer is directly over the drop-down, the mouse scroll wheel can also be used; on a Mac, the list must also be expanded. In Windows only, you can press **Tab** to select the highlighted item in the list and proceed to the next setting.
- Settings with spin control arrows  can be adjusted by typing in the text field or using the **Up** and **Down** arrow keys. When the mouse pointer is directly over the setting, the mouse scroll wheel can also be used.
- Slider bars  can be adjusted by typing in the text field or using the **Left** and **Right** arrow keys. When the mouse pointer is directly over the slider bar, the mouse scroll wheel can also be used.
- Line items in tables can be group selected using the **Ctrl** or **Shift** keys, or by pressing **Ctrl + A**.
- Press **Enter** on your keyboard to close most dialogs and apply your changes.
- In the Mac version, **Command + .** closes dialogs.

Note: Keyboard navigation in dialogs may vary somewhat depending on your computer platform.

In the Mac version of the software, Dictation is supported in dialogs. Select **Edit> Start Dictation**, then open a dialog. Say the word “Numeral” before a number to enter it as a numeric value or immediately follow a number with a unit such as “foot” to enter it as a measurement.

Edit Handles

A selected object has edit handles that can be used to modify its size, position, and orientation. When you move the pointer over an edit handle, information about what it does displays in the Status Bar and the pointer changes to suggest how you can use it.

The edit handles that display depend on the type of object selected, the current view, and how far you are zoomed out. Edit handles do not resize as you zoom in or out. If you are zoomed out far enough, some edit handles may be hidden so that they do not stack over one another. As you zoom in, these handles become visible again.

How each handle behaves when it is clicked and dragged may depend on which **Edit Behavior**  is currently active. See [Defaults, Preferences, and Edit Behaviors on page 137](#).

 You can cancel any edit handle operation before it is completed by pressing the Esc key on your keyboard or by pressing any two mouse buttons at the same time.

MOVE EDIT HANDLE



The square Move handle located at the center of a selected box or polyline-based object, or at the center of a group of selected objects, lets you move the selection orthogonal, or at right angles to, its edges. When you position the mouse pointer over the Move handle, it displays a four-headed arrow. See [Moving Objects on page 165](#).

Depending on the type of object(s) selected and how far you are zoomed in or out, the position of the Move handle may shift so that it remains on-screen. See [Zoom Tools on page 106](#).

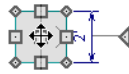

RESHAPE/RESIZE EDIT HANDLES



Square edit handles on the edges and corners of a selected object allow you to resize the object by moving its edges. A two-headed arrow indicates that the object's edge or corner can be moved in the direction of the arrows. When multiple objects are selected, the Resize handle is not available. See [Resizing Objects on page 171](#).

Depending on the type of object selected and how far you are zoomed in or out, the Resize handles may not display on-screen.



In the case of a selected line-based object, clicking and dragging the Resize edit handle will move the object perpendicular to itself. See [Editing Line-Based Objects on page 145](#).

ROTATE EDIT HANDLE



The triangular Rotate handle lets you rotate the selected object or group of objects. The Rotate handle is located adjacent to either the object's selected edge or its front if it has one, and when you move your mouse pointer over this handle, it displays a circular arrow. See [Rotating Objects on page 175](#).

A selection's Rotate handle will display regardless of how far you are zoomed out; however, it is possible to zoom in far enough that it no longer can be seen.



OTHER EDIT HANDLES

In addition to the Move, Reshape/Resize, and Rotate edit handles, a variety of objects in Home Designer Pro have additional edit handles for special purposes. Examples include:

- Same Wall Type edit handles. See [Edit Handles for Walls on page 247](#).
- Change Swing/Hinge Side edit handle for doors. See [Changing Door Swings on page 374](#).
- Add Extension and Extension Line End edit handles for dimension lines. See [Editing Dimension Lines on page 328](#).
- Resize edit handles for Schedule columns. See [Plant Schedules on page 898](#).

The Status Bar

The Status Bar at the bottom of the main program window displays information about the current state of the program.

This information depends on a variety of conditions such as settings in the Preferences dialog, the type of object selected, and the current position of the pointer. Examples of information that may be reported include:

- The type of object currently selected or the total number of group-selected objects.
- Plan file name and view information when a layout box is selected.
- A description of the edit handle that the pointer is over.
- A brief description of the toolbar button or menu item that the mouse pointer is positioned over.
- The name of the active tool, a brief description of that tool, and its hotkey, if it has one.
- The length and/or angle of an object as it is being drawn.
- Basic information about a selected library object, folder, or catalog.
- The current floor level.
- The layer that the selected object is on and its Drawing Group.
- The size of the active window in pixels.
- Whether a camera view is rendering or has finished rendering.
- The current CAD coordinates of the mouse pointer.

The number format used in the Status Bar is set in the Dimension Defaults dialog, while the angle style can be specified in the Number Style/Angle Style dialog. See [Format Panel on page 320](#) and [Dialog Number/Angle Style Dialog on page 87](#).

Message Boxes

As you work in Home Designer, the program will occasionally prompt you to examine your settings, alert you if you command it to do something that could potentially cause a problem, or notify you if it encounters a problem that needs your attention.

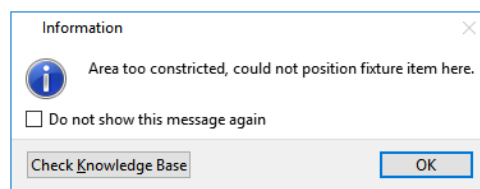

Situations where such message boxes may display include:

- Closing a file or view without saving;
- Modifying an object that is set to rebuild automatically;
- A file referenced outside the program, such as an image or texture, is missing;
- Creating an object in a space too small to contain it.

As with dialog boxes, you can access the options in a message box using the mouse or navigate them using the keyboard.

A few messages have a **Send Report** button. Click this button to send details regarding the issue that prompted the message to Chief Architect via the internet.

Some message boxes include a “Remember my choice” or a “Do not show this again” checkbox. Check this box to prevent messages of this specific type from displaying in the future. When this box is checked, some options in the message box may become inactive.

To allow all message boxes to display again, click the **Reset Message Boxes** button in the Preferences dialog. See [Reset Options Panel on page 86](#).

NAME PROMPT

The Name Prompt dialog allows you to **Rename** an entity such as a column in a Plant Schedule. See [Plant Schedule Specification Dialog on page 899](#).

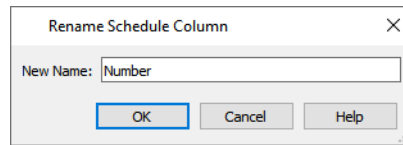

For best results, type a short, descriptive, and unique name and then click **OK**.

Preferences and Default Settings

Preferences and default settings control many aspects of the user interface and tool behavior in Home Designer. You can use these settings to customize the program to suit your personal work style.

For more information about defaults and preferences, see [Preferences and Default Settings on page 53](#).

PREFERENCES



Preference settings let you change program behavior to suit your workflow. For example, you can:

- Turn certain display elements on or off.
- Choose background and editing feedback colors.
- Set the frequency of autosaves, the maximum number of “undos,” and file locking.
- Set the default folders for various files.
- Control the editing behaviors of objects.
- Setup the materials list categories, sub-categories, and report style, as well as manufacturer and supplier information.
- Set rendering specifications to maximize efficiency and quality.

Preference settings are global, affecting all plan and layout files.

DEFAULTS

Most objects in Home Designer derive their initial properties from their respective default dialogs.

For example, a newly placed **Window**  gets its initial values from the Window Defaults dialog and a newly placed **Hinged Door**  gets its initial values from the Door Defaults dialog.

Once an object is placed in a plan, its initial properties can be overridden, but setting up your defaults before you begin drawing can save you considerable time as you build a model in the program.

Default settings, unlike Preferences, are file specific.

DYNAMIC DEFAULTS

Most default settings are static: if you change one, any objects of that type in the current file will not be affected. A few defaults, however, are dynamic: they are tied to existing objects in the drawing and if you change the default, those objects may be affected. See *Dynamic Defaults on page 55*.

Drawing a Plan

When you draw a plan in Home Designer, you are placing 3D objects that represent building components. Home Designer comes with predefined default settings so you can start drawing plans immediately. You should review these default settings to be sure they match your drawing and building methods. See *Preferences and Default Settings on page 53*.

SET THE DEFAULTS

1. Open a new plan using the template of your choice. See *Template Plans on page 35*.
2. Set the structural defaults:
 - Floor Defaults. Set the default ceiling height for Floor 1. See *Floor Defaults Dialog on page 502*.
 - Foundation Defaults. Set the foundation specifics such as type, footing size, and stem wall height. See *Foundation Defaults on page 482*.
 - Framing Defaults. Set the floor framing specifications, including type and dimensions. See *Framing Defaults on page 606*.
 - Default Wall Types. Specify the defaults for walls and railings. See *Wall, Railing, and Fencing Defaults on page 223*.
3. Set material defaults for roof, walls, and rooms (optional). See *Material Defaults on page 712*.
4. Set style defaults for doors, windows, molding, cabinets and other objects.

DRAW THE FLOORS

1. While the size of the drawing area in Home Designer is limited only by the resources on your computer, it is best to begin your drawing near the origin, 0,0. See *3D Drafting on page 11*.
2. Draw the exterior walls on Floor 1. See *Creating Walls on page 236*.
3. Adjust the perimeter shape and size as required. See *Using the Edit Handles on page 245*.
4. Place any first floor bearing walls.
5. Define types for special rooms such as garages and decks in the plan. See *Room Types on page 282*.
6. Place perimeter doors and windows. See *Doors on page 365* and *Windows on page 393*.
7. Build additional floors. See *Adding Floors on page 503*.
8. Specify the default ceiling height for each floor as soon as it is created. See *Floor Defaults Dialog on page 502*.
9. Adjust the perimeter shape of additional floors as needed. See *Editing Walls on page 244*.
10. Align edited or moved walls with those above or below where appropriate. See *Aligning Walls on page 249*.

ENTERING DIMENSIONS

When using Imperial units, enter distances as inches or feet and inches, in fractional or decimal form. Millimeters are the default unit for all metric distances. See *Dimensions on page 311*.

- To enter feet, include the (') marker or the program assumes inches.
- In most cases, the program allows precision to 1/16th of an inch. Fractions with denominators 2, 4, 8 and 16 are allowed.
- The program usually converts decimals to fractions.
- You can enter angles as decimal degrees, degrees, minutes, and seconds, quadrant bearings, or azimuth bearings. See *Dialog Number/Angle Style Dialog on page 87*.

BUILD THE FOUNDATION

1. Derive the foundation plan from the first floor. See *Building a Foundation on page 485*.
2. Adjust the foundation perimeter shape as needed.
3. Place interior foundation walls as needed for the first floor bearing walls.
4. Place any other foundation walls required.
5. **Align with Above** as needed. See *Aligning Walls on page 249*.

ADD STRUCTURE AND DETAILS

1. Build non-structural interior walls. Begin on floor one and work up in multiple story structures.
2. Add walls where needed to create features such as chimney chases, plumbing walls, or Open Below areas.
3. Finish the relevant interior structure including interior doors, doorways, cabinets, fixtures, and fireplaces.
4. Build the roof planes. If you generate the roof automatically, remember to carry the roof directives in the walls from the first floor up to the top floor for multiple story structures. See *Roofs on page 556*.
5. Build the framing. See *Framing on page 605*.
6. Build the terrain and landscaping. See *Terrain on page 846*.
7. Create the plot plan. See *Plot Plans on page 848*.

CREATE THE LAYOUT

1. If one does not exist, create a Layout file with a title block, placing the border, title block, and other text on page 0. See *Layout on page 924*.
2. Send views to the layout. See *Sending Views to Layout on page 927*.
3. Print the layout. See *Printing and Plotting on page 939*.

Viewing Your Plan

You can see your model in a variety of different 2D and 3D views. You can display more than one view at a time; and in any view, you can pan or zoom in or out. See *Window and View Tools on page 101*.

Plan view is a 2D view of the model most commonly used for drawing and editing. Each floor displays separately; however, you have extensive control over which objects display at any given time, can easily switch between floors, and can also display items on a second floor for reference. See [Multiple Floors on page 501](#).

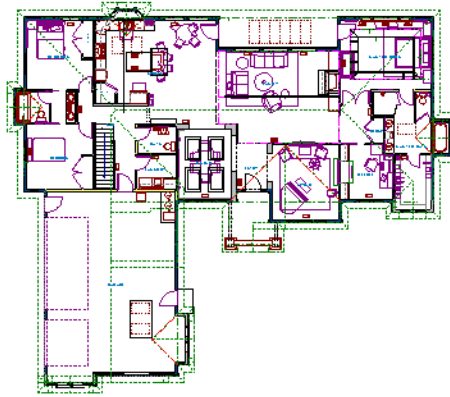

You can create interior and exterior 3D views of your model from any perspective. As in plan view, you can select and edit many objects in 3D views and control which objects are visible. See [3D Views on page 735](#).

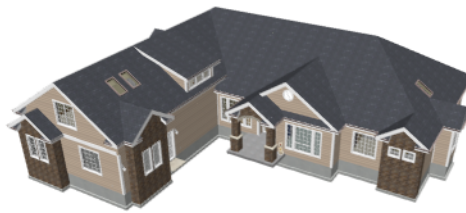

You can also create **Doll House Views** that show only the current floor plus any floors beneath it. Ceilings on the current floor are omitted so you can see the interior, visualize the relationships between spaces, and plan traffic flow.

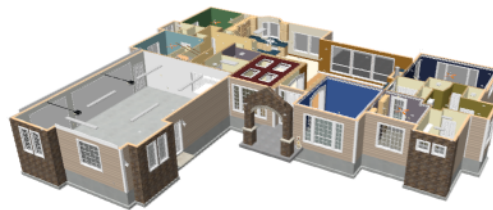

Framing Overviews display framing in 3D, provided that framing has been built. You can customize 3D views to serve special purposes such as this.

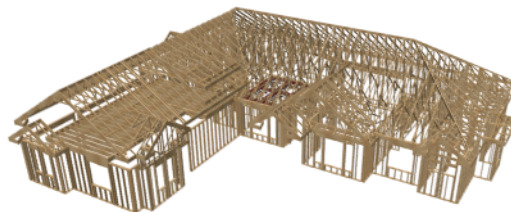

The Cross Section and Elevation camera tools create scaled 2D views of a model's exterior and interior that can be dimensioned and annotated. Just as in other views, you can select and edit objects in a Cross Section/Elevation view as well as control which objects display.

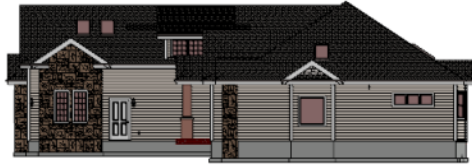

LAYOUT FILES

 All plan views can be sent to a layout where they can be arranged to produce construction documentation. See [Sending Views to Layout on page 927](#).

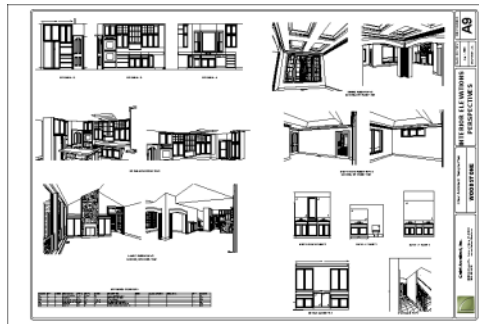

All views can also be exported as a graphic image. See [To export a picture on page 801](#).

Sharing Your Files with Clients

Chief Architect users have the option of letting their clients review plan and layout files on their own computers, at their convenience, using the Chief Architect Viewer. The Chief Architect Viewer allows clients to open plan and layout files, create 3D views, and add text annotations without making any changes to the actual model.

To share files using the Chief Architect Viewer, first invite a client to request a copy of the Viewer at HomeDesignerSoftware.com.

To ensure that all custom backdrops, images and material textures are included, use the **Backup Entire Plan**  tool when preparing to send files to your client. See [Backup Entire Plan or Project on page 44](#).

You can also invite clients to explore the 3D model of their project using the **3D Viewer** mobile app. Learn more at: chiefarchitect.com/products/3d-viewer/

Getting Help

 There are many forms of help available in Home Designer Pro including: Tool Tips, the Status Bar, and the online Help menu. See [Resources and Support on page 961](#).

All these forms of help assume you have a basic working knowledge of your operating system, including how to use a mouse, open, close and save files, copy, paste, and right-click to access contextual menus. Help also assumes you are familiar with basic computer terminology.

More information is available on Home Designer's website, HomeDesignerSoftware.com.

TOOL TIPS

When you move the pointer over a toolbar button or menu item, a **Tool Tip** displays, offering a brief description of the tool. More information displays in the Status Bar at the bottom of the window. The Status Bar also reports information about the currently active tool or the currently selected object. See *The Status Bar on page 23*.

CONTEXTUAL HELP

 Home Designer Pro's **Help** is a searchable menu that provides information about all of the tools in the program. Select **Help> Launch Help** or press the F1 key to open the program's Help and explore the table of Contents, browse the Index, or Search for keywords.

The Help can be used to provide instant information about toolbar buttons, menu items, and objects in your plan.

- Position the mouse pointer over a toolbar button or menu item, then press the F1 key to open the Help to a page with more information about the tool.
- When an object is selected, press the F1 key to open the Help to a page with information about that object. If you position the mouse pointer over one of the selected object's edit handles and press F1, a page with information about that handle will display instead.
- Press the **Help** button in any dialog box to open online Help to a page describing the options in that dialog.

When the Help is open, it will update automatically to show information about the currently selected object, active tool or dialog, or highlighted item. If you would like to turn off this dynamic behavior, click the **Prevent Help from Updating Dynamically**  button at the top of the Help window.

Additional buttons at the top of the Help window allow you to zoom as well as search the current page.

Chief Architect strives to make our documentation as helpful as possible.
Please send any suggestions to: documentation@chiefarchitect.com.

About Home Designer

Select **Help> About Home Designer** in Windows[®] or **Home Designer> About Home Designer** in macOS[™] to view information about your software license, the program's version number, and its release date.

Contact information for Chief Architect, Inc. is available on the MORE INFORMATION panel.

Product Upgrade Options

Ready to expand your design capabilities in the software? Select **Help> Product Upgrade Options** to launch your default web browser and learn about options for upgrading your software license at www.homedesignersoftware.com.

Home Designer Trial Software

All Home Designer program titles have Trial versions available for free download at HomeDesignerSoftware.com.



The Trial software offers the same functionality as a purchased license with a few limitations:

- File Saving
- Printing

- File Exporting
- Recording of Walkthroughs
- Printing or Exporting of Materials Lists
- Library Browser restrictions

CONVERTING THE TRIAL VERSION

An installation of any of our Trial programs can be converted into a full working version of the program at any time by purchasing a software license. There are several ways to begin this process in the Trial:

- Click the **Purchase Full Version Now** button in any Trial Restriction message box.
- Select **Help> Purchase Home Designer Pro** .
- Select **File> Startup Options**  and then click the **Purchase Full Version Now** button.

Once you have purchased a license, you can activate it while the Trial software is running.

To activate the full version

1. Select **Help> Activate Full Version**.
2. In the Product Activation dialog, type or paste the **Product Key** associated with your software license.
3. Click the **Activate Full Version** button.

File Management

Chapter 2

Home Designer Pro reads and edits two main document types: **.plan** files and **.layout** files. The complete 3D model of a structure, surrounding terrain and any CAD data associated with it are stored in the plan file. Data used to create working drawings and the links to various views are stored in the layout file.

All commands related to opening, saving and closing plans are located in the File menu. You can also open plans from the Startup Options dialog. See *Startup Options on page 10*.

Just as with files created in other software applications, you should back up your plan and layout files externally on a regular basis to avoid accidental loss of work.

TOPICS

Compatibility with Other Programs	32
Organizing Your Files	33
Home Designer Pro Data	33
Creating a New Plan or Layout	34
Saving, Exporting, and Backing Up Files	36
Thumbnail Images	39
Auto Archive	40
Opening and Importing Files	41
Referenced Files	43
Backup Entire Plan or Project	44
Exiting Home Designer	45

Compatibility with Other Programs

Plans and layout files produced in the following programs can all be read by Home Designer Pro 2022.

- Chief Architect® X1 through X13 (limited editability if enabled)
- Chief Architect® 10.0 through 11.3 (read only)
- All Better Homes and Gardens Home Designer® products, Interior Designer, and Landscaping and Deck Designer, Versions 7 and 8.
- All Chief Architect Home Designer® products, Interior Designer, and Landscaping and Deck Designer, Versions 9 through 2021.

Only the **.plan** and **.layout** files from prior versions can be opened in Home Designer Pro 2022. A number of steps are recommended when migrating plans created in an earlier program version into Home Designer Pro 2022. Before doing so, see [Getting Started Checklist on page 966](#).

Files that have been opened and saved in Home Designer Pro 2022 cannot be read by any of the program versions listed above. To continue to read files in the program in which they were created, be sure to create copies of your files before opening them in version 2022.

Plans and layout files produced in the Windows® version of Home Designer Pro 2022 can be read in the Mac® version, and vice versa.

FILE ASSOCIATION

Although multiple versions of Home Designer can be installed on a computer, the operating system will only associate **.plan**, **.layout**, **.calib**, and **.calibz** files with one of them. If they are not associated with Home Designer Pro 2022, click the **Associate Files with this Program** button in the Preferences dialog. See [File Management Panel on page 68](#).

OPENING CHIEF ARCHITECT PLANS IN HOME DESIGNER PROGRAMS

Plans created in Chief Architect Versions 10 through X13 and Home Designer Pro Versions 7 through 2022 can be opened in the latest Home Designer programs for viewing and annotating, but not for general editing or drawing of architectural objects.

Plans created in build 11.4 or later of Chief Architect X1 or Home Designer Pro 8, or in later program versions, can be set to allow limited editability in other Home Designer programs. When this permission is enabled, a Home Designer user can use all of their program's drawing tools and can edit objects in the plan that those tools can create. If an object cannot be created in the Home Designer program, however, it will not be editable.

Please note, too, that if a plan has more floors than the Home Designer program supports, the entire plan can be viewed and annotated only.

To protect some objects from being edited when a file with editing permission is opened in another Home Designer program, consider locking their layers. See [Locking Layers on page 125](#).

Allow Editing in Select Home Designer Products can be enabled or disabled only when the file is opened in Home Designer Pro. See [General Plan Defaults Dialog on page 56](#).

Organizing Your Files

You should keep your plan and layout files separate from the support files needed to run Home Designer. To keep files organized, you may find it helpful to create a new folder for each project.

Home Designer files may use imported images, textures and other custom content saved in their own external data files. Consider storing copies of all external files in the same folder as the plan and layout files that use them so that they are easily found.

Here is one way to organize your files:

- Create a folder in your Documents directory called “Home Designer Plans” or another name you prefer. See your operating system’s Help to learn how to create folders.
- Inside this folder, make a new folder for each client or project. Save all the files for that client or project inside this folder, including plan and layout files and referenced external files. See *Saving, Exporting, and Backing Up Files on page 36*.

Bear in mind, though, that path names exceeding 260 characters cannot be opened by Home Designer. As a result, it is a good idea to limit the number of embedded folders you use in your file organization method.

Once you understand the file management of Home Designer, you should decide on a naming convention that suits your needs.

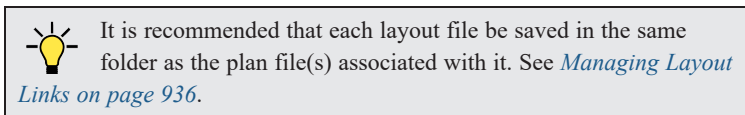

To specify a default Save As location

1. Select **Edit> Preferences** , then select New Plans from Category list. See *New Plans Panel on page 71*.
2. Under Open and Save As, click **Use this Folder**. The **Browse** button becomes available.
3. Browse to the folder you plan to save your projects in. Click **OK**.

Home Designer Pro Data

When Home Designer Pro 2022 is installed, the program automatically creates a folder in the user Documents directory called **Home Designer Pro 2022 Data**. This folder contains important user-specific information saved in the following folders and files and should not be moved, renamed or deleted:

- **Archives** - A folder of automatically archived plan and layout files. See *Auto Archive on page 40*.
- **Backdrops** - A folder of custom backdrop images. See *3D Backdrops on page 748*.
- **Images** - A folder of custom images. See *Using the Contextual Menu on page 681*.
- **Database Libraries** - A folder of user library data. See *Library Content on page 677*.
- **Scripts** - A folder for custom Ruby scripts associated with Chief Architect plans.
- **Templates** - A folder of plan and layout template files. See *Creating a New Plan or Layout on page 34*.
- **Textures** - A folder where you can save image files used to create custom material textures. See *Creating Materials on page 721*.
- **Toolbars** - A folder of customized toolbar files. See *Toolbar Customization Dialog on page 95*.
- **mmaster.mat** - The Master Materials List file. See *The Master List on page 918*.

- **sheetSizes.sheet** - A list of user-created Drawing Sheets. See *Customize Sheet Sizes Dialog on page 946*.
- **_MigrateBackup** - If you migrated legacy settings into Version 2022, additional folders with names appended with **_MigrateBackup** may also be present.

 If the Home Designer Pro 2022 Data folder is renamed, moved or deleted, the program will automatically replace it using default information from the program's installation folder. When this occurs, customized user settings and custom user library content will not be available.

DATA FOLDER NAME AND LOCATION

The name of the Home Designer Pro 2022 Data folder cannot be changed, but you can specify its location on your system in the Preferences dialog. See *Folders Panel on page 69*.

If you specify a new location for this folder, the program will not migrate any custom user settings that you might have. Instead, it will automatically create a new folder at that location containing default information from the Home Designer Pro 2022 installation folder. If you would like to copy custom settings to the new location, you can do this yourself in an operating system window.

When specifying a location for the Data folder, bear these considerations in mind:

- If you move the Home Designer Pro 2022 Data folder on your computer without specifying its location in Preferences, the program will automatically replace the folder in its default location using default information from the software's installation folder.
- The same will result if you specify a location on a network or removable device and that location becomes inaccessible. For this reason, it is best to use a location on your local hard drive.
- The User Database Libraries in particular may contain a large amount of data. Whatever location you choose to use must be located on a hard drive with sufficient space to hold these files.

Just as with your plan and layout files, it is a good idea to back up your Home Designer Pro 2022 Data folder.

Because the Home Designer Pro 2022 Data contains custom user data, it is not deleted when the program is uninstalled.

Creating a New Plan or Layout

 To open the Create New Plan dialog, select **File> New Plan**. You can also choose **New Plan** in the Startup Options dialog. See *Startup Options on page 10*.

 Create a new layout file by selecting **File> New Layout** or by sending a view to layout when no layout file is yet open or associated with the current plan file. See *Creating a Layout File on page 926*.

By default, a new layout file will be assigned the same name of the first plan file sent to it, associating the layout files with the plan files used.

Note: Only one layout file can be open at any given time.

New, blank plans are called **Untitled.plan** and new, blank layout files, **Untitled.layout**. Unless these files are named and saved, they will be lost when closed. See *Saving, Exporting, and Backing Up Files on page 36*.

UNITS OF MEASUREMENT

All plan and layout files save measurements in either Imperial or metric units. New files are created using one or the other, depending on the current setting in the Preferences dialog. When the program is first installed, the Windows OS setting for

units determines what system is used. See *New Plans Panel on page 71*.

A plan or layout file's unit of measurement must be specified before it is created and cannot be changed later.

While it is recommended that you create new plans using the type of unit that you plan to use, you can display dimensions using any type of unit. See *Dimension Preferences and Defaults on page 312*.

TEMPLATE PLANS

When you select **File> New Plan**  in Home Designer, the Create New Plan dialog opens, letting you select a template for your new plan. The resulting new plan uses either metric or U.S. units of measurement and predefined default settings for objects like walls, doors, windows, and cabinets. See *Default Settings on page 54*.

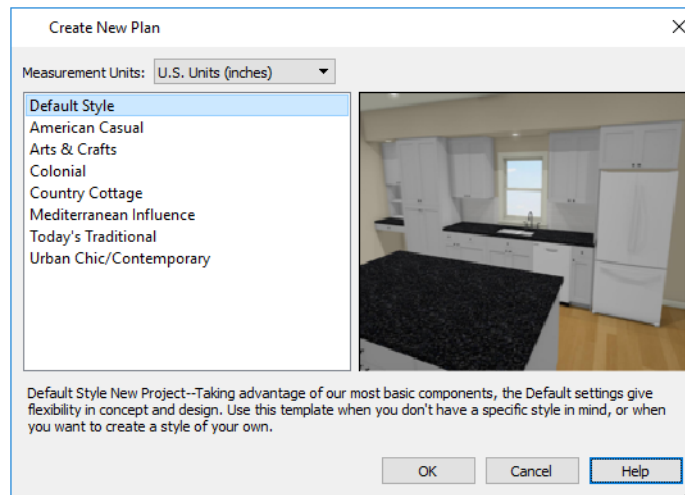

- Select either **U.S. Units** or **Metric Units** of measurement. Once a new plan has been created, its Measurement Units cannot be changed.
- Select a style template from the list. If you are uncertain as to the right style for your plan, choose Default, as you cannot change the plan style template once a plan has been created.

When you click **OK**, a new floor plan view window opens, ready for you to begin drawing.

When Home Designer Pro opens a new, blank plan or layout file, the new file is actually a copy of a template using either metric or U.S. units of measurement and predefined default settings, wall definitions, and page setup information.

SELECT TEMPLATE DIALOG

When a new, blank plan or layout file is opened in Home Designer Pro, the new file is actually a copy of a template using either metric or U.S. units of measurement and predefined default settings, wall definitions, and page setup information.

Creating a new plan without referencing a template file is not recommended. If you try to create a new plan or layout using a template file that is not available, the Select Template dialog will prompt you to specify a template for the new file you are creating.

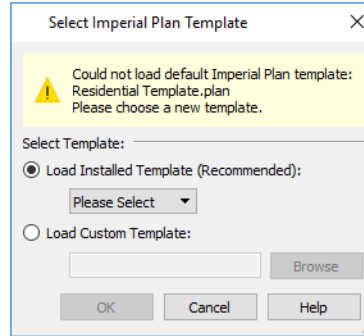

- Select **Load Installed Template (Recommended)**, then select a template file from the drop-down list.
- Select **Load Custom Template**, then click the **Browse** button and browse to a plan or layout file saved on your computer.
- You can also type or paste the full path name of a file in the text field.

If you encounter this dialog, make sure that the program Data folder is at a location that can be accessed by the program. See [Home Designer Pro Data on page 33](#).

Saving, Exporting, and Backing Up Files

Saving, exporting, and backing up your files are three separate tasks that accomplish different things:

- Saving a plan or layout file retains your work so that it can be later opened in Home Designer Pro.
- Exporting a file allows you to save certain kinds of data in a format that can be used by a program other than Home Designer.
- Backing up your files involves taking steps to make sure that your valuable data is protected and available when needed.



Whether you are saving, exporting, or backing up your data, it is important that you select a location on your computer for the files you create, and also specify a short, meaningful name that you will be able to identify in the future.

To save an untitled plan or layout file

1. Select **File> Save As**  to open the Save File dialog.
2. Specify a location on your local computer where you would like to save the file. See [Organizing Your Files on page 33](#).
3. In the **File name** text field, type a name for the file.
4. Home Designer automatically assigns the **File of type** and file extension **.plan** to plan files and **.layout** to layout files.
5. When both the Save in location and File name are correct, click **Save**.

 Although the program warns you if you try to exit without saving, you should get in the habit of saving plan files before exiting the program.

SAVING PLAN AND LAYOUT FILES

When you first save a new, untitled file, you must select a location for it on your computer and give it a name. There are two options for saving plan and layout files: **File> Save**  and **File> Save As** .



Both **Save** and **Save As** can be used to save your plan and layout files; however, they accomplish this in two different ways:



Save saves the current state of your plan or layout file without changing its name and should normally be used for saving your work.



Save As opens the Save File dialog, allowing you to save the plan or layout file using a different name or location on your computer.

Initially, all **Open**  and **Save As**  operations go to your Documents directory. After that, the location last visited is remembered and subsequent **Open** or **Save As** commands default to the directory last used for that operation. This path is saved when the program exits. The next time Home Designer is launched, these defaults are used.

If you prefer, you can instead specify a directory to be used for all **Open** or **Save As** operations in the **Preferences**  dialog. See [New Plans Panel on page 71](#).

SAVED VIEWS

All saved camera views are saved with their plan file. See [View Windows on page 102](#).

When saving a layout, the program saves all the links to the various views saved in the layout, and all the CAD objects added to the **.layout** file.

By default, a new layout file is assigned the same name as the first plan file from which a view is sent to it. It is also saved in the same directory as the plan file. If no view has been sent to a layout, it remains untitled until you save it.

SAVE FILE DIALOG

The Save File dialog uses the operating system's file save dialog format, and is also used when exporting files. The dialog name may vary, depending on the type of file being saved or exported.

A similar Select Folder dialog allows you to select a folder to which files can be exported.

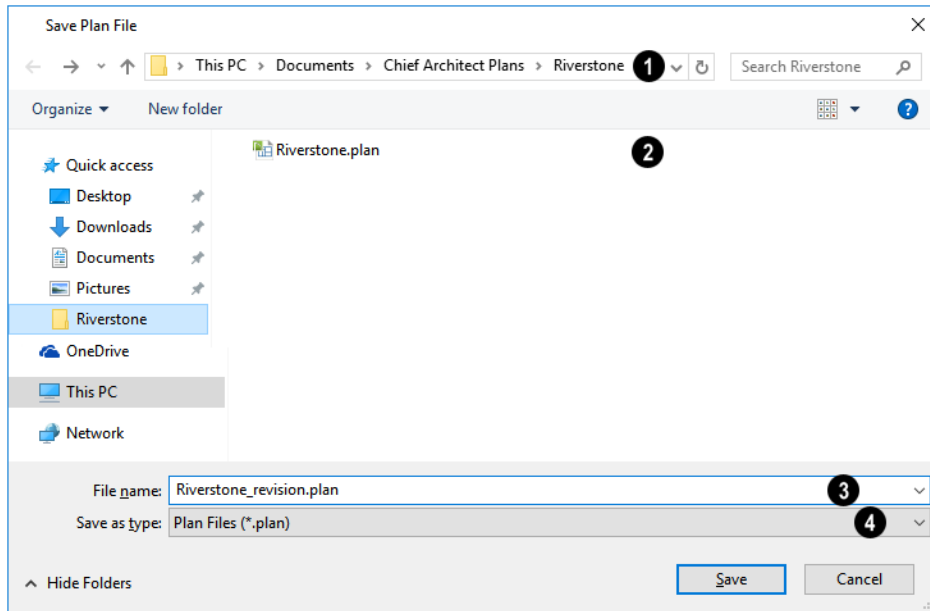

1 Location

Choose a location on your local computer for the file you are saving.

2 Files

Any existing folders and/or files in the current location display here.

3 File Name

In the **File Name** field, type a name for the file. If you select an existing file from the space above, its name will display here automatically.

4 Save as Type

When saving a file, the program will choose the appropriate file type from the **Save as type** drop-down list. When exporting, you may need to choose a specific file type.

SAVING REVISION FILES

Revisions are a common aspect of any design project. There are a number of possible strategies for organizing revision files:

- Prepending the file name;
- Appending the file name;
- Saving revisions in separate folders.

To avoid confusion and potential mistakes, it is recommended that you always give files unique names - including revision files. If you choose to organize your revisions by saving them in separate folders, you should also give each file a unique name that makes it impossible to confuse it with another file saved in a different folder.

EXPORTING FILES

Home Designer has a number of options for exporting and importing information out of and your drawings. See [Importing and Exporting on page 827](#).

Often, file export dialogs are simply versions of the Save File dialog. See [Save File Dialog on page 37](#), above.

Similarly, file import dialogs are often similar to the Open File dialog. See [Importing Files on page 42](#).

BACKUP ENTIRE PLAN

File > Save As  is a simple way to transfer a plan or layout to a different location on your computer. Bear in mind, though, that plan and layout files often reference external data files such as imported textures, images, and backdrops. These external files are not affected when **Save As** is used.

If you transfer a plan file from one computer to another, the program will warn you of missing files if the external data files used by the plan cannot be found when you open it.

Layouts are also dynamically linked to plan files. When transferring layout files to another computer, be aware that the plan files are also external file references and are not actually contained in the layout.

When transferring plans or layouts to another computer that does not have these external files, use the **Backup Entire Plan**  tool. See [Backup Entire Plan or Project on page 44](#).

BACKING UP YOUR FILES

It is always a good idea to create backup copies of all your important files on your computer.

It is strongly recommended, however, that you never save directly:

- Across a network, such as onto a server;
- Onto removable media such as a USB thumb drive.
- Across the Internet.

Instead, copy your files to such locations only after you have saved them on your computer's hard drive and exited the program.

Similarly, you should never open files saved in these locations. Copy the files to the local hard drive, and then open them. See [Opening and Importing Files on page 41](#).

Archive folders are used by Home Designer to manage prior versions of your files. You should not view these files as a substitute for your own backup routine, and should never save a file in an archive folder. See [Auto Archive on page 40](#).

When backing up your Home Designer files, consider backing up not only your **.plan** and **.layout** files, but your custom user data, as well - including library content, toolbar configurations, and textures. This custom data is all located in the Home Designer Pro Data folder, so it can be easily backed up. See [Home Designer Pro Data on page 33](#).

You can, if you wish, create a folder inside the Data folder for your **.plan** and **.layout** files, as well. See [Organizing Your Files on page 33](#).

Thumbnail Images

A thumbnail is a miniature image that helps identify a file in the Open Plan File dialog in the Windows version of the software.

If thumbnails are enabled in the Preferences dialog, the program automatically creates one when you first save a new plan or layout. You can, however, create a custom thumbnail using any view as well as choose to generate small or large thumbnails. See [File Management Panel on page 68](#).

To create a custom thumbnail image

1. You must save the file and give it a name before you can save a thumbnail.
2. Create the 2D or 3D view that you want to use as a thumbnail for the current file.
3. With the desired view active, select **File> Save Thumbnail Image** .

Thumbnail images are saved in the plan or layout file that they are associated with.

Auto Archive

The first time a plan or layout is saved, an Archive folder is automatically created in the Home Designer Pro 2022 Data folder. The Archive folder contains Auto Save and Archive files.

The program will also create Auto Save files for unsaved plans and layouts provided that they have been open for longer than the Auto Save frequency setting in the Preferences dialog. See [Auto Save Files on page 41](#), below.

 Auto Save and Archive files should not be viewed as a substitute for regularly saving your work by selecting **File> Save** or pressing **Ctrl + S** on the keyboard, nor should they be considered an alternative to your own file backup routine.

ARCHIVE FILES

Every time a drawing is saved, Archive files that keep a historical archive of your plan are automatically created or updated.



JonesResidence.plan



JonesResidence_2021_1_15.plan



JonesResidence_2021_1_15_13.plan

 If you do not save your work regularly, your archive files will not be updated.

Plan, layout and related files from previous versions of the program are automatically moved to the archive folder when the plan is opened and saved in Home Designer Pro 2022.

Archive files are meant to be for emergency use only. If you must access an archive file, open it as you would any other file. As soon as the file is open, use **Save As**  to save this file to another location.

LEGACY ARCHIVE FILES

Plan and layout files saved in the current program version are not backwards-compatible: that is, they cannot be opened in older versions of the software.

If you open a Home Designer plan or layout file from a previous program version and immediately **Save** it (not **Save As**), the Auto Archive utility will create an additional archive file using the original program version format. This archive file is a copy of the original and can still be opened in the original program version.

AUTO SAVE FILES

As you work, Home Designer automatically creates Auto Save files at regular intervals when changes are made to a file but not saved by selecting **File> Save** .

These Auto Save files are appended **_auto_save.plan** or **_auto_save.layout** and are saved in the Archive folder.

When you close a file normally, its Auto Save file is retained until the next time the file is opened - at which time the Auto Save file is overwritten.



JonesResidence_auto_save.plan

Auto Save file after normal shutdown

You can enable Auto Save and set its frequency in the Preferences dialog. See *File Management Panel on page 68*.

Auto save files created as a result of an improper program shutdown are appended **_auto_save_bak.plan** or **_auto_save_bak.layout**.





JonesResidence_auto_save_bak.plan

Auto Save file after abnormal shutdown

If your computer shuts down accidentally, you can recover some of your work by opening the **_auto_save_bak** file.

When you reopen a file after a computer shut down or system crash, the program will notify you if an Auto Save file newer than the original file is found and give you the option to one that file.

Even with Auto Save, you should save your work manually on a regular basis using any of the following methods:

- Click the **Save**  button.
- Select **File> Save** .
- Press Ctrl + S on the keyboard.

Opening and Importing Files



Opening and importing files are often similar tasks, but accomplish two very different things:

- Opening a file refers to opening it in the program in which it was created. Only plan or layout files can be opened in Home Designer Pro. See *Compatibility with Other Programs on page 32*.
- Importing a file brings data that was created in a different program into Home Designer. A number of different file types can be imported into Home Designer.

Select **File> Open Plan** to open an existing **.plan** file or **File> Open Layout** to open an existing **.layout** file located on your computer. Home Designer Pro automatically browses to either the directory last used or to a specific directory, depending on your current Preferences settings. See *New Plans Panel on page 71*.



Before opening a file located on a removable storage device, server, or other computer on a network, copy it to your local machine's hard drive first.

OPEN FILE DIALOG

The Open File dialog uses the operating system's file open dialog format, and is also used when importing files. The dialog name may vary, depending on your operating system and the type of file being opened or imported.

A similar Select Folder dialog allows you to select an entire folder of files to import.

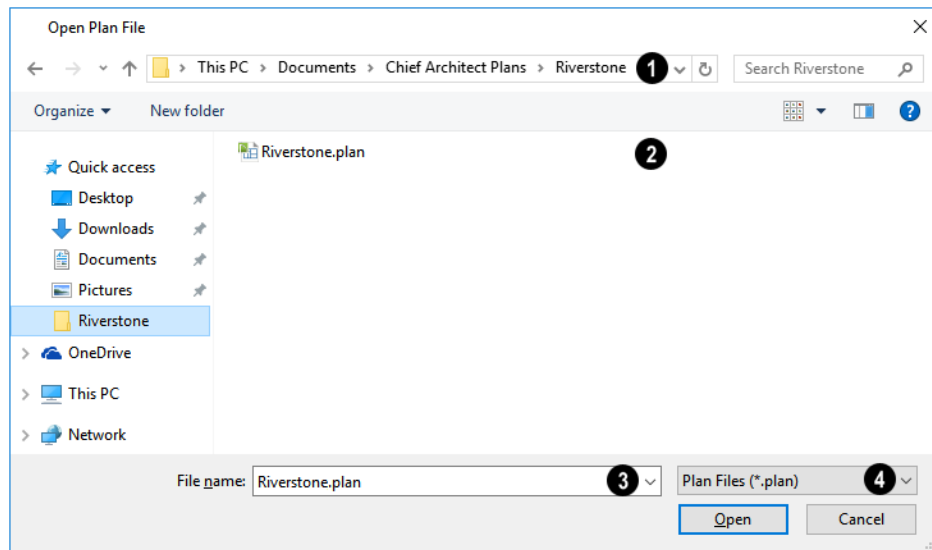

1 File Path

Choose the location on your local computer for the file you are opening.

2 Folder Contents

Any existing folders and/or files in the current location display here.

3 File Name

When selecting a file, its name will automatically display in the **File Name** field. You can also type the file's name to locate a specific file. When importing some types of files, multiple files may be selected.

4 File Type

When opening or importing a file, the program will usually choose the appropriate file type from the **File type** drop-down list. When importing, you may need to choose a specific file type.

Plan files open to the floor that was active when the file was last saved and closed; layout files open to the page that was active.

IMPORTING FILES

Home Designer has a number of options for exporting and importing information out of and into your drawings. Often, file import dialogs are simply versions of the Open File dialog. See [Importing and Exporting on page 827](#).

Similarly, file export dialogs are often similar to the Save File dialog. See [Exporting Files on page 38](#).

RECENTLY OPENED FILES

A list of recently opened and saved plan and layout files can be accessed by selecting **File> Open Recent Files**. Select one of these files to open it without using the Open File dialog.

The maximum number of recent files listed in the **File** menu can be changed in the **Preferences**  dialog. You can also specify that the recent files list display at the bottom of the **File** menu rather than in a submenu. See *File Management Panel on page 68*.

The names of recent files also display in the Startup Options dialog. Click on the name of a file to open it. See *Startup Options on page 10*.

Referenced Files

Home Designer plan and layout files often reference a variety of external files for added detail, including:

- Material Textures
- Images
- Plant Images
- 3D Backdrops
- Picture Files
- PDF Files

Whenever any view in a plan or layout is opened, the program checks for referenced files used in that view and will notify you if any of those files cannot be found by opening the Missing Files dialog.

You can also open this dialog at any time by selecting **Tools> Checks> Missing Files**. When accessed this way, all missing files associated with the current file are listed: not just those used in the current view.

MISSING FILES DIALOG

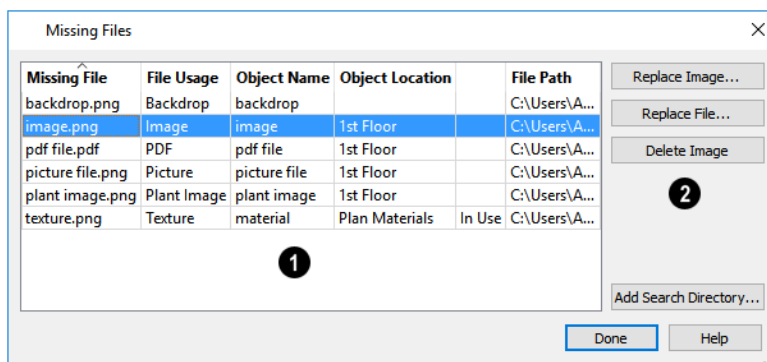

1 File Information

The table lists any Missing Files as well as useful information about each:

- **Missing File** reports the name and file extension of the missing file.
- **File Usage** indicates how the missing file is used in the program.
- **Object Name** states the name of the object in Home Designer that references the file.
- **Object Location** indicates where in the file the object can be found.
- The next column indicates whether a missing texture is in use in the plan.
- **File Path** states the last known location of the missing file on your computer system.

Click on a line item in the table to select it and resolve it using the options on the right. Multiple line items can be selected; however, the selections on the right may be limited. See [Shift and Ctrl Select on page 144](#).

2 Options

The buttons on the right offer options for resolving a selected missing file. The names of these buttons will vary somewhat, depending on the type of file(s) selected in the list on the left.

- Click the top **Replace Object** button to replace any instances of an object or material referencing the selected missing file with a different object or material from the library. Not available for PDF files or picture files.
- Click the **Replace File** button to open the Browse for Missing File dialog and select a file saved on your system to replace the missing one. See [Opening and Importing Files on page 41](#).
- Click the **Delete Object** button to remove the object or material referencing the missing file from the plan. Not available for material textures that are In Use.
- Click the Add Search Directory button to direct the program to a particular folder to search for missing files in. The list of Search folders can be reset in the Preferences dialog. See [Reset Options Panel on page 86](#).

You can prevent this dialog from opening automatically by checking **Do not display missing files again during this session** at the bottom of the dialog. This option is not available when the dialog is opened manually.

Backup Entire Plan or Project



Because Home Designer plans contain many references to external files such as material textures and images, it is a good idea to make copies all the associated files when a plan is moved to a new location. You can easily do this by selecting **File> Backup Entire Plan**.

Layout files also rely on references to plan files, images, and other files. Select **File> Backup Entire Project** to copy these files when you want to move a layout file to a new location.

Backing up an entire plan or layout is important when:

- Migrating legacy files created in older program versions.
- Transferring files to another computer or sending them to another user.
- Archiving or backing up your work.

Note: Always use File> Backup Entire Plan or Project when sending files to a user of the Chief Architect Viewer. See [Sharing Your Files with Clients on page 28](#).

To back up a plan or layout

1. To copy all associated plan or layout files to a new directory, select **File> Backup Entire Plan or Project** 
2. The Backup Entire Plan or Project dialog opens.

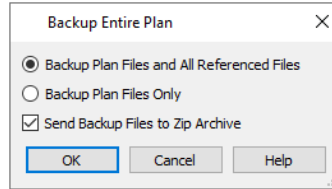

- Choose **Backup Plan Files and All Referenced Files** to copy the plan or layout file and all externally referenced files such as linked plan files, inserted picture files, metafiles, and texture, image, and backdrop graphics files.
 - Choose **Backup Plan Files Only** to copy all associated plan files and any externally linked files and inserted picture files, but no graphics or texture files. This is best used only when transferring a file to a computer that already has the graphics files installed.
 - When **Send Backup Files to Zip Archive** is checked, the files are saved in a zipped folder. Uncheck this if you prefer to save them in a regular folder instead.
 - Click **OK**.
3. The Select the Plan or Project Backup Folder or Choose Zip Archive to Backup dialog opens next. This is a typical Save File dialog. See [Saving, Exporting, and Backing Up Files on page 36](#).
 - Navigate to a folder on your system and select it.
 - With the destination folder for the backup selected, click **OK**.
 4. If the destination folder already contains files, the program will confirm whether you want to overwrite them. The resulting folder contains a copy of the plan or layout file and all referenced files, and can be moved to a new computer.

Exiting Home Designer

Select **File> Exit** to exit the program. If you have not saved any open files, you will be reminded to do so. It is better to save your work before exiting than to save on exit. See [Closing Views and Files on page 108](#).

When you exit from the program using **File> Exit**, all Autosave files and Undo files are automatically deleted. See [Auto Save Files on page 41](#) and [Undo and Redo on page 191](#).

On a Mac, if you click the program window's red **Close** button, the window will close but the program itself will continue to run. To close it down completely, right-click on its icon on the Dock and select **Quit** from the contextual menu.

Project Management

Chapter 3

The tools described in this chapter allow you to conduct preliminary budget and space planning, and to and run checks on plans so you can be more confident that they are free of common drawing errors.

TOPICS

Space Planning	47
Room Box Specification Dialog	49
Finding Objects	50
Plan Check	50
Loan Calculator	51

Space Planning

 The **Space Planning Tools** are a time-saving way to create a preliminary room-by-room design of a home without getting caught up in the details. When the room boxes are laid out, the **Build House** tool converts them into a working plan that can be edited and detailed to completion.

SPACE PLANNING ASSISTANT

In plan view, select **Tools> Space Planning> Space Planning**. The Space Planning Assistant gathers information about the rooms you want to include in your house. When you click **Finish**, the selected room boxes display.



Room boxes can now be arranged into a floor plan.

Note: Each Bedroom called for in the Space Planning Assistant also produces a Closet.

PLACING ROOM BOXES



In addition to or as an alternative to the room boxes created for you by the Space Planning Assistant, you can create your own room boxes. In plan view, select **Tools> Space Planning** , choose the desired room type from the submenu, then click to place a room box of that type.





DISPLAYING ROOM BOXES

Room boxes and their labels are located on the “Space Planning Boxes” layer. Space Planning Box labels use the Text Style assigned to that layer, as well. See [Displaying Objects on page 123](#).

EDITING ROOM BOXES

Once created, room boxes can be edited in a variety of ways.

- Select room boxes using the **Select Objects**  tool just like other objects in Home Designer. See [Selecting Objects on page 141](#).
- Room boxes can be resized, rotated, and rearranged. See [Editing Box-Based Objects on page 158](#).
- When arranging room boxes, make sure **Object Snaps**  are enabled so their edges snap to one another. See [Object Snaps on page 113](#).

- Rooms can be overlapped: when this is the case, the room box edges drawn in front will be converted to walls when the **Build House**  tool is used. By default, smaller rooms draw over larger rooms; however, you can control their drawing order. See *Drawing Groups on page 128*.
- Rooms can be copied and pasted using the **Copy/Paste**  edit button and deleted using the **Delete**  edit button.
- Select **Tools> Space Planning**  or click the **Space Planning Configuration**  button to access the room box tools and place additional room boxes in your plan. Select a tool and click in the plan to place a room box of that type.



- Select **Tools> Space Planning> Toggle Room Boxes**  or click the toggle button to hide or show the room boxes.

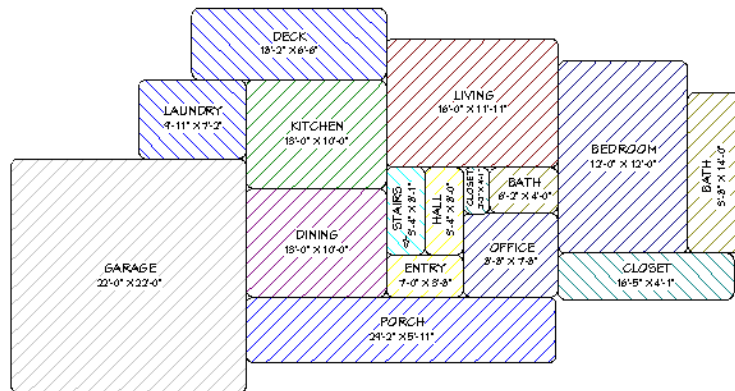

BUILD HOUSE

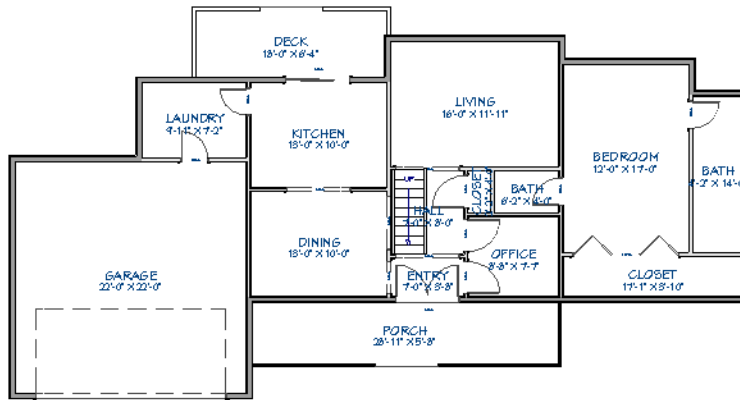

-  When the room boxes are in place, select **Tools> Space Planning> Build House** to convert them into a building composed of walls and railings. Doors are inserted between the rooms, as well.



When you Build House, the “Space Planning Boxes” layer is automatically turned off. The room boxes that you created are not deleted, however.

MULTIPLE FLOORS

If you specified a two-story house in the Space Planning Assistant:

1. Edit and arrange the room boxes on Floor 1 as desired.
2. Select **Tools> Space Planning> Build House**  tool to create the walls on the first floor.
3. Go **Up One Floor**  and notice that the positions of the walls on Floor 1 display in red as a reference.
4. Arrange the rooms on Floor 2 as desired using the red polylines as a guide.
5. On the second floor, select **Tools> Space Planning> Build House**  to complete the second floor.

Room Box Specification Dialog

 Select one or more room boxes and click the **Open Object** edit button to open the Room Box Specification dialog. See *Space Planning on page 47*.

GENERAL PANEL

Most of the settings on the GENERAL panel are used when the selected room box is converted to a room using the **Build House**  tool.

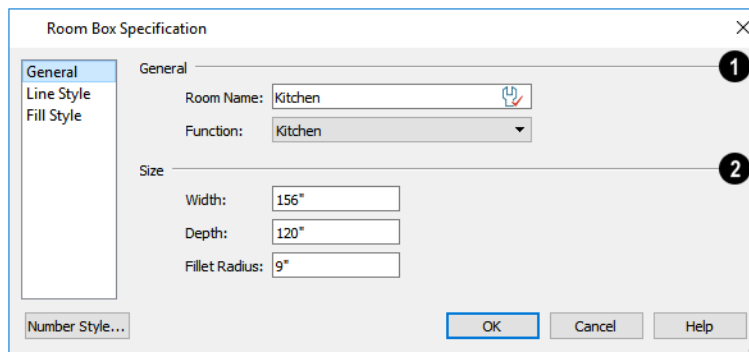

1 General

Specify the selected room box's **Room Type and Name**.

- Specify a **Room Name** for the selected room box. When the default is specified, the Function selected below is used as the name.
- Select a **Function** from the drop-down list. See *Room Types on page 282*.

2 Size

Specify the **Size** of the selected room box.

- Specify the room box's **Width** and **Height**.
- Specify the **Fillet Radius**, which is the radius of the curve on each of the room box's corners. Unlike the other settings on this panel, this value does not affect the shape of the room created using **Build House** .

LINE STYLE PANEL



The LINE STYLE panel is available for a variety of other objects in the program. For more information, see *Line Style Panel on page 204*.

FILL STYLE PANEL

The FILL STYLE panel is available for a variety of other objects in the program. See *Fill Style Specification Dialog on page 131*.

Finding Objects

There are a variety of tools in the program designed to help you locate specific objects. These tools often open a new view window in which the object in question is either highlighted or selected.

- To find out where a line item in the Materials List is located in the model, select its row or any cell in its row and click the **Find Object in Plan**  edit button. See *Find Object in Plan on page 915*.
- To locate a string of text, select **Edit> Find/Replace Text**. See *Find/Replace Text on page 351*.
- In a Framing Overview or other 3D view in which wall framing can be seen, select a wall framing member and click the **Find Wall**  edit button to locate its owner wall in plan view. See *Selecting Walls on page 244*.

Additional tools are available to help you find files referenced by your plans and layout files.

- Select **Tools> Checks> Missing Files Check** to identify and locate any missing referenced files. See *Referenced Files on page 43*.
- Select **Tools> Layout> Referenced Plan Files** to identify and locate any plans linked to the current layout file. See *Managing Layout Links on page 936*.

Plan Check



Plan Check examines the current floor of a plan, checking for anything that appears to violate common building practices. Plan Check may not find all the problems in a plan, but does it point out areas that may need improvement.

 Disclaimer: The Plan Check feature in Home Designer does not claim to detect all building code and design requirements. It merely compares your plan with common building practices.

To run Plan Check, select **Tools> Checks> Plan Check** .

Potential plan errors found are usually highlighted in plan view. To ensure the highlighted item is on-screen, make sure the entire plan is shown in the window before you run **Plan Check**.

PLAN CHECK DIALOG

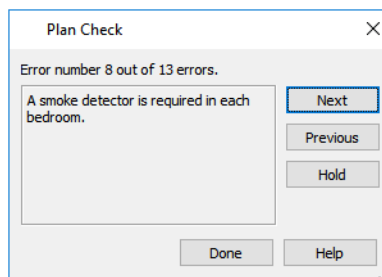

The current error number, along with the total number of errors found, is stated at the top of the dialog.

A description of the current error displays in the field on the left.

Options for navigating Plan Check are found on the right side.

- Click **Next** to ignore the current error and proceed to the next.
- Click **Previous** to return to the previous error.
- Click **Hold** to suspend Plan Check so you can fix the current error. Select **Tools> Checks> Plan Check** again and the check starts where it left off.
- Click **Done** to terminate Plan Check.

If this dialog obscures the plan view, drag its title bar to move it. It remembers its new position and displays there the next time **Plan Check** is run.

ROOM TYPES

Plan Check can do a much better job of checking for problems if it knows what the rooms in your plan are to be used for, so you should assign a Room Type to each room in your plan. See [Room Types on page 282](#).

The first time **Plan Check** runs in a plan, it automatically assigns a room type to as many undesignated rooms as it can. Some rooms are determined by their size and shape, and others by their contents. For example, a shelf in a small room indicates a closet; a stove or refrigerator indicates a kitchen; or a bed, a bedroom. If the program cannot assign a room type, **Plan Check** highlights it and suggests that you do so manually.

Loan Calculator

 Select **Tools> Loan Calculator** to open the Loan Calculator dialog. This dialog lets you calculate different aspects of a loan for the current plan based on a variety of parameters.

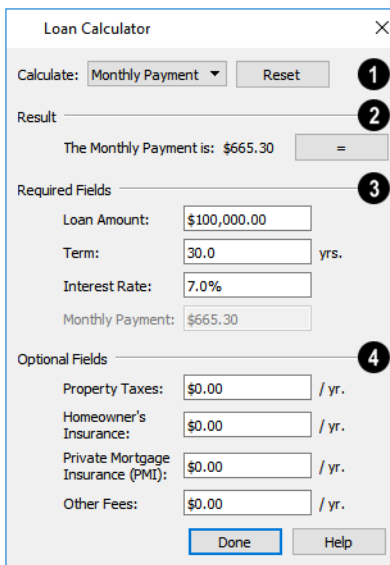

Loan Calculator

Calculate: Monthly Payment

Result

The Monthly Payment is: \$665.30

Required Fields

Loan Amount: \$100,000.00

Term: 30.0 yrs.

Interest Rate: 7.0%

Monthly Payment: \$665.30

Optional Fields

Property Taxes: \$0.00 / yr.

Homeowner's Insurance: \$0.00 / yr.

Private Mortgage Insurance (PMI): \$0.00 / yr.

Other Fees: \$0.00 / yr.

1 Calculate

Specify what aspect of the loan you would like to calculate from the **Calculate** drop-down list:

- Monthly Payment
- Loan Amount
- Term
- Interest Rate

2 Result

The calculation **Result**, based on the information you provide, displays here.

- If you make changes to any of the fields in the dialog, click the = button to refresh the **Result**.

3 Required Fields

The **Required Fields** are the same as the options in the **Calculate** drop-down list. The option selected under **Calculate** will be inactive under **Required Fields**.

- Specify the desired **Loan Amount**.
- Specify the desired **Term**, in years.
- Specify the desired **Interest Rate**.
- Specify the desired **Monthly Payment**.

4 Optional Fields

The **Optional Fields** allow you to include additional information in your loan calculation.

- Specify the expected **Property Taxes** per year.
- Specify the expected **Homeowner's Insurance** cost per year.
- Specify the expected **Private Mortgage Insurance (PMI)** cost per year.
- Specify the cost of any expected **Other Fees**.

When Monthly Payment is calculated, each Optional value is divided by twelve (months) and then added to the total payment.

When a Calculate option other than Monthly Payment is selected, these values are divided by twelve (months) and then subtracted from the specified Monthly Payment value. The result, which does not display, is then used to determine the Loan Amount, Term or Interest Rate.

Preferences and Default Settings

Chapter 4

Preferences are global settings that affect the functionality and appearance of the Home Designer environment, while default settings control what objects look like when they are initially created. You can save time and increase your productivity by becoming familiar with these settings and customizing them before you begin a new project or as needed thereafter.

TOPICS

Default Settings vs Preferences	54
Dynamic Defaults	55
Reset to Defaults	56
General Plan Defaults Dialog	56
Preferences Dialog	59
Dialog Number/Angle Style Dialog	87

Default Settings vs Preferences

Default and preference settings have important effects on how the tools in Home Designer function. Default settings are file specific, while Preferences are global, taking effect regardless of what file is open.

Defaults and Preferences can be customized to suit your needs and improve your efficiency, so it is recommended that you become familiar with them and learn how you can use them to your advantage.

DEFAULT SETTINGS

 Default settings determine the initial characteristics of objects when they are first drawn. For example, when you place a base cabinet in a plan, its size, materials, front items, and hardware are determined by settings in the Base Cabinet Defaults dialog.

Some defaults affect the structure of your model: for example, Floor, Foundation, Framing, and Wall defaults.

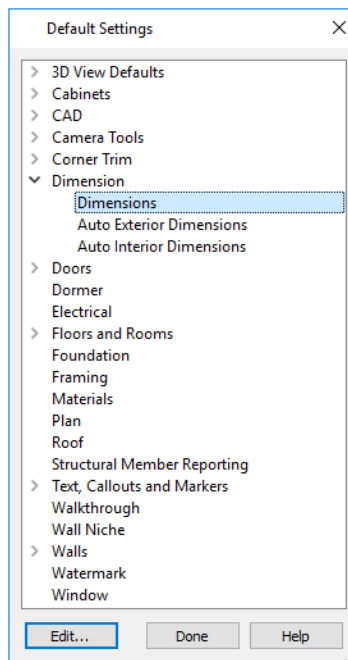

Defaults are file-specific, which means that any changes that you make to the default settings in one plan or layout file will have no effect on other plans or layout files.

You can access a complete list of the various default settings in the current plan or layout file by selecting **Edit> Default Settings**  from the menu.



- Click the + beside a category to expand it and access the defaults for items related to that category.
- To open the defaults dialog associated with an item in the list, double-click on the line item, or click on the item and then click the **Edit** button.
- General CAD defaults are view-specific and are only available in views where CAD objects can be drawn. See [CAD Defaults Dialog on page 193](#).

Many defaults dialogs can also be opened by double-clicking on a parent and/or child toolbar button of a tool affected by the settings in that dialog. For example, you can:

- Double-click the **Cabinet Tools**  parent button to open the Defaults Settings dialog for Cabinet tools only;
- Double-click the **Base Cabinet**  child button to open the Base Cabinet Defaults dialog.

PREFERENCES

 Preference settings influence the overall environment of the program, such as what the interface looks like, how the tools are accessed, and the basic rules governing how objects are drawn and edited. See [Preferences Dialog on page 59](#).

Unlike default settings, Preferences are global, which means that any changes that you make to them will take effect in all plan and layout files.

To access the Preferences dialog, select **Edit> Preferences**  from the menu.

REGION AND LANGUAGE SETTINGS

There are a few formatting considerations in Home Designer that are set based on your operating system's Region settings:

- **Units of measurement** - When you first install and launch the program, your template plan and layout files will be set to use either Imperial or metric units, depending on your operating system settings. See [New Plans Panel on page 71](#).
- **Currency** - The currency associated with your Region settings will be used in the Materials List, Components dialogs, and Loan Calculator. See [Materials Lists on page 904](#) and [Loan Calculator on page 51](#).
- **Decimal mark format** - Depending on your operating system settings, either a dot or a comma will be used in dimension lines, dialogs, and anywhere the program can display a numeric value using decimals.
- **Date format** - The format of Sun Angle date labels vary depending on your operating system settings. See [Sun Angles on page 779](#).

Dynamic Defaults

Dynamic defaults are values that can be changed globally throughout the current plan or layout file. They are available for a variety of objects, including dimension lines, walls, doors, cabinets and rooms.



- If you change a dynamic default value in a defaults dialog, all objects of that type that are set to use the default will update automatically to use the new value.
- Any objects of that type that are not using the default value because of editing will not be affected if you change the default.

Dynamic defaults are presented in several different ways in specification dialogs. Some settings have a **Use Default** radio button, or a “Use Default” option in a drop-down list.

Dynamic default check boxes have a **Default** checkbox. Uncheck this box to make the setting not dynamic, or check it again to restore the dynamic behavior.

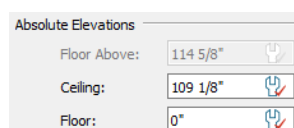
Dynamic default text fields have an Active Defaults  icon in the value field.



- Click on the Active Defaults  icon to remove the red check mark and prevent the value from being dynamic.
- Type a value into the text field. The red check mark is removed from the Active Defaults icon and the setting is no longer dynamic.
- Click on the Defaults  icon to restore the red check mark and make the setting dynamic again.

Materials are another example of an attribute that uses Dynamic Defaults. See *Material Defaults on page 712*.

Reset to Defaults

Select **Edit> Reset to Defaults** to open the Reset to Defaults dialog.

This dialog allows you to reset critical structural settings in the current plan to the default values.

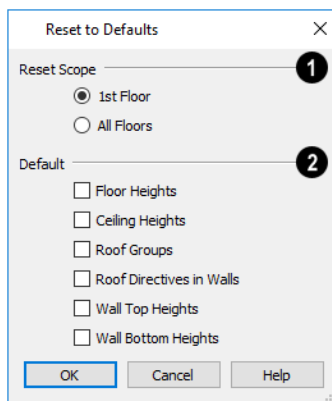

1 Reset Scope

The settings can be cleared for the **current floor** or for **All Floors**.

2 Default

Specify which settings you want to reset to **Default**.

- Check **Floor and Ceiling Heights** to reset the default values as specified in the Floor Defaults dialog. Floor and ceiling heights for any room can be changed in the Room Specification dialog. See *Floor Defaults Dialog on page 502*.
- **Roof Groups** - You can specify a room's Roof Group in the Room Specification dialog. This builds the roof over this room and others in the same Roof Group independent of the roof built over other parts of the plan. Check to reset to the default Roof Group, zero. See *Roof Groups on page 560*.
- When **Roof Directives** are reset, all items on the ROOF panel of the Wall Specification dialog are reset to the default. See *Roof Directives in Walls on page 560*.
- **Wall Top Heights** and **Wall Bottom Heights** - Wall shape and height can be edited in 3D views. Check to reset wall shapes and heights. See *Editing Walls on page 244*.

General Plan Defaults Dialog



The settings in the General Plan Defaults dialog control basic features of the Home Designer environment in plan

files. Just as with other default settings, they are file specific, which means that they can be set differently in individual plan files. To open this dialog, select **Edit**> **Default Settings**, select **Plan**, and click the **Edit** button.

You can also open this dialog by double-clicking the **Select Objects**  button.

The General Layout Defaults dialog is similar to the General Plan Defaults dialog, but has fewer settings and is available in layout files only. Its settings, too, are file specific.

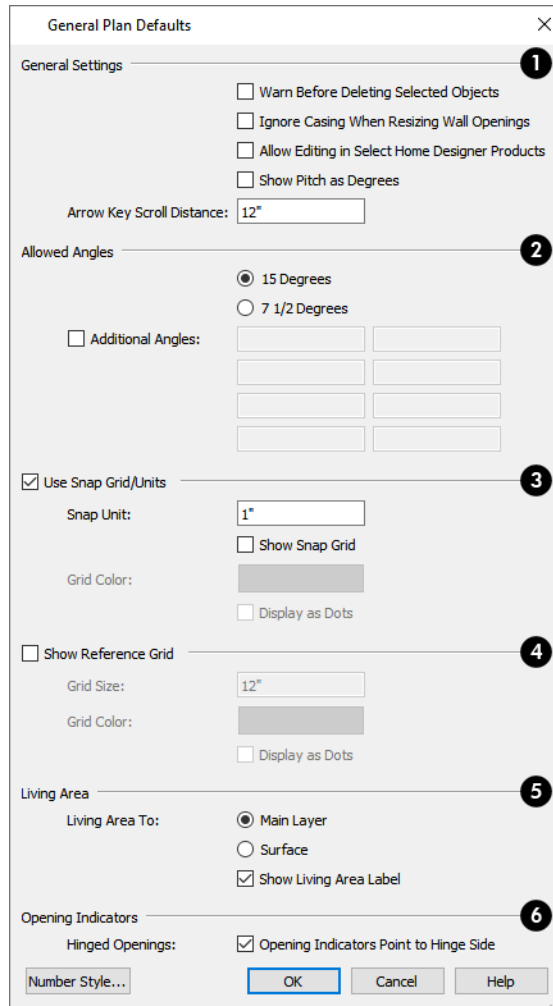

1 General Settings

- Check **Warn Before Delete Selected Item** if you want the program to require confirmation before an item is deleted.
- Check **Ignore Casing for Opening Resize** to allow wall openings such as doors to be positioned against an intersecting interior wall. Clear this box retain sufficient space for the opening's specified interior trim width. Not available in layout files.
- Check **Allow Editing in Select Home Designer Products** to allow limited editing of the current file in other compatible Home Designer programs. See [Compatibility with Other Programs on page 32](#).
- Check **Warn Before Delete Selected Item** if you want the program to require confirmation before an item is deleted.
- The **Arrow Key Scroll Distance** setting determines how far to scroll in plan view when you press an arrow key. The initial default is 12 inches (300 mm). Not available in layout files. See [Using the Arrow Keys on page 107](#).

2 Allowed Angles

See [Angle Snaps on page 114](#).

- Select **15 Degrees** to enable Angle Snaps in 15° increments.
- Select **7 1/2 Degrees** to enable Angle Snaps in 7 1/2° increments.
- Check **Additional Angles** and enter up to eight custom Allowed Angle values. Click the **Number Style** button to specify the format used to enter angles in dialogs. See [Dialog Number/Angle Style Dialog on page 87](#).

3 Snap Grid

See [Grid Snaps on page 115](#).

- Check **Use Snap Grid/Units** to enable Grid Snaps.
- Specify the **Snap Unit** you wish to use. The initial default is 1 inch (10 mm).



It may be helpful to temporarily change the Snap Unit when working with large objects such as terrain.

- Uncheck **Show Snap Grid** to turn off the display of the Snap Grid, a visual indicator of the location of the snap points.
- Click the **Color** bar to specify the **Snap Grid Color**. See [Select Color Dialog on page 134](#).
- Check **Display as Dots** to display the Snap Grid using dots rather than lines.
- You can also click the **Grid Snaps**  toggle button to turn on/off grid snapping.

4 Reference Grid

- Check **Show Reference Grid** to display the Reference Grid, the virtual graph paper used to create a sense of scale in plan view.
- Specify the **Reference Grid Size**.
- Click the **Color** bar to specify the **Reference Grid Color**. See *Select Color Dialog on page 134*.
- Check **Display as Dots** to display the Reference Grid using dots rather than lines.
- You can also click the **Display Reference Grid**  toggle button to turn on/off the grid display.

5 Living Area

Not available in layout files. See *Living Area on page 289*.

- Select **Main Layer** to have the Living Area calculation measure from the walls' Main Layer.
- Select **Surface** to have the Living Area calculation measure from the walls' exterior surface.
- Uncheck **Show "Living Area"** to turn off the display of the Living Area label.

6 Opening Indicators

Not available in layout files. Opening Indicators display on doors, windows, and cabinet doors in camera views when the "Opening Indicators" layer is turned on. See *Opening Indicators on page 370*.

- Check **Hinge Indicators Point to Handle** for opening indicators to point towards the handle side of openings. When unchecked, opening indicators point towards the hinge side.

Preferences Dialog



The settings in the Preferences dialog are global: they apply to all plan and layout files and are preserved between sessions. To access this dialog, select **Edit> Preferences** in Windows[®] or **Home Designer> Preferences** in macOS[™]. Unlike most dialogs in the program, it is not necessary to have a plan or layout file open to access the Preferences dialog.

The Preferences dialog has the following panels:

APPEARANCE PANEL

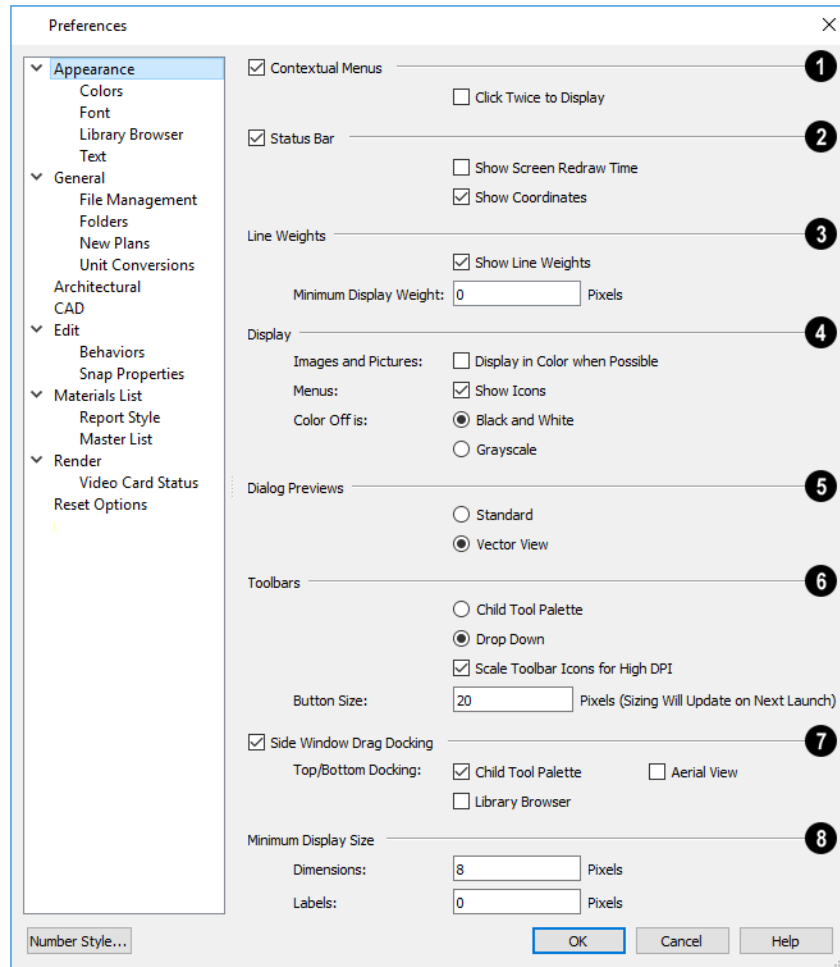

1 Contextual Menus

- Check **Contextual Menus** to activate contextual menus that display when you right-click. See *Contextual Menus on page 18*.
- Check **Click Twice to Display** to require two right-clicks on an object before the contextual menu displays. This allows the first right-click to be used for object selection. See *Selecting Objects on page 141*.

Note: In 3D views, the two clicks must be on the same object surface in order for the contextual menu to display: Clicking on two different surfaces of the same object is treated like two single-clicks.

2 Status Bar

- Check **Status Bar** to activate the Status Bar at the bottom of the main program window. See *The Status Bar on page 23*.
- Check **Show Screen Redraw Time** to display the number of seconds it takes to redraw the current view.
- Check **Show Coordinates** to display the coordinates of your cursor at all times on the right side of the Status Bar.
- The coordinates' number style is controlled in the Number Style/Angle Style dialog. See *Dialog Number/Angle Style Dialog on page 87*.

3 Show Line Weights

Specify the on-screen display of **Line Weights**. See *Line Weights on page 950*.

- Check **Show Line Weights** to represent line weights on-screen. Depending on your zoom factor and your monitor's resolution, lines may appear to be wider on screen than when they are printed. Zooming closer may reflect a more accurate idea of the actual line width.
- Specify the **Minimum Display Weight**, in Pixels. This is the lowest line weight possible on screen, regardless of how far you zoom out. A Minimum Display Weight of 0 is the same as 1. This setting is ignored when printing or when **Print Preview**  is enabled.

4 Display

- **Images and Pictures** - Check **Display in Color when Possible** to display pictures and images in color even when Color  is toggled off. Does not affect the display of images in any 3D views aside from Vector Views. See *Color On/Off on page 129*.
- **Menus** - Check **Show Icons** to display tool icons next to items in the menus.
- **Color Off is** - Specify whether views appear in **Black and White** or **Grayscale** when color is toggled off. Does not apply to any 3D views aside from Vector Views. See *Vector View on page 785*.

5 Dialog Previews

Specify whether Dialog Previews use the **Standard** or **Vector View** Rendering Technique by default. See *Dialog Preview Panes on page 20*.

6 Toolbars

Specify how the program's toolbars present child tools when a parent button is clicked.

- Choose **Parent-Child** to display child tools as buttons at the end of the toolbar where the parent button resides.
- Choose **Drop Down** to display child tools when the drop-down arrow to the right of the parent button is clicked.
- Uncheck **Scale Toolbar Icons for High DPI** to prevent toolbar icons from becoming larger on systems running Windows and using Custom Scaling to increase DPI resolution. When checked, toolbar buttons will increase in size when high DPI is used. Not available in the Mac version of the software.
- Specify the desired toolbar **Button Size**, in pixels. Increasing this value will proportionally resize the text in the drop-down toolbars, as well. See *Toolbar Button Size on page 91*.

7 Side Window Drag Docking

Specify whether side windows dock to the edges of the program window. See *View and Side Windows on page 16*.

- Uncheck **Side Window Drag Docking** to prevent undocked side windows from docking when moved using the mouse. A side window can still be docked to its last docked location by double-clicking its title bar.
- **Top/Bottom Docking** - Check the box beside a side window's name to allow it to dock on the top and bottom edges of the program window. Does not affect docking to the left and right sides.

8 Minimum Display Size

Specify the minimum display size of **Dimensions** and **Labels**, in pixels. This is the on-screen size and does not affect printed or exported output. To use the printed scale, set these values to 0 or turn on **Print Preview** .

- Dimension sizes are set in the Dimension Defaults dialog. See *Dimension Defaults Dialog on page 313*.

COLORS PANEL

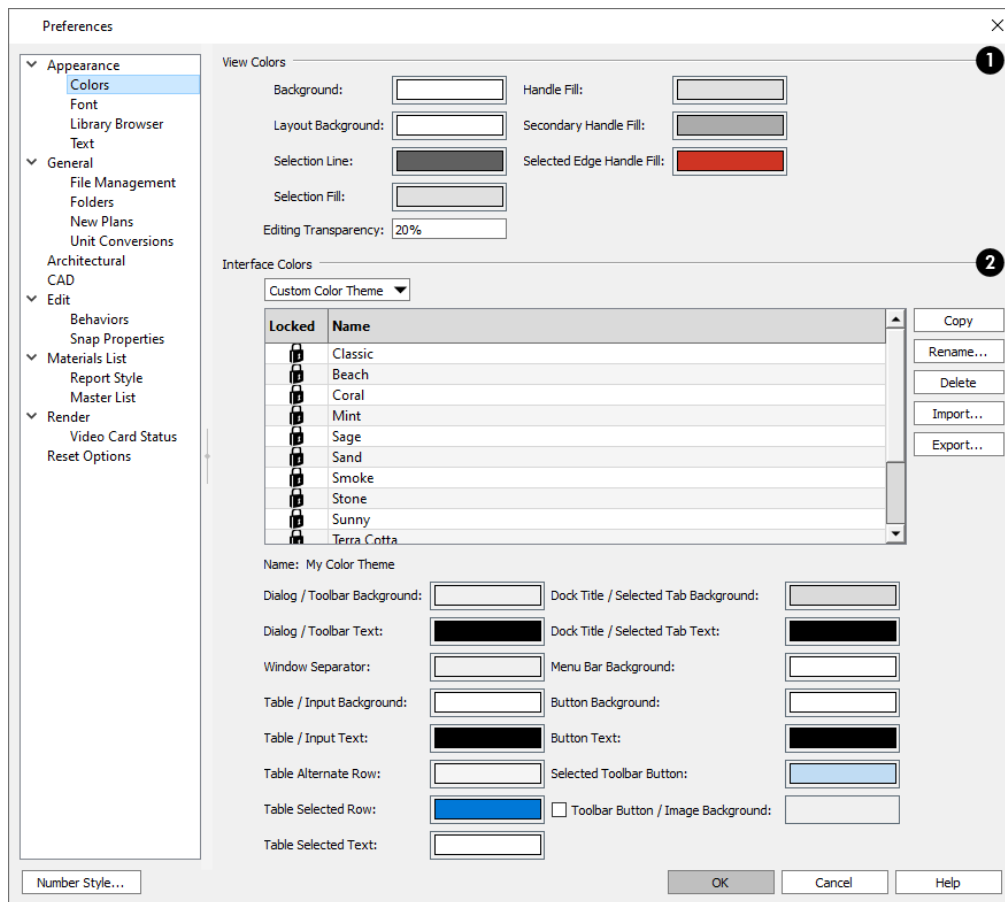

1 View Colors

Specify view background colors and colors associated with selected objects by clicking a color bar to open the Select Color dialog. See *Select Color Dialog on page 134*.

- Specify the **Background** color for plan view. The background colors for 3D views can be set in their defaults and specification dialogs. See *Backdrop Panel on page 763*.
- Specify the **Layout Background** color, which is the background color in layout files. See *Layout on page 924*.
- Specify the **Selection Line** color, which is the color of the lines that represent object(s) and their edit handles when they are selected.
- Specify the **Selection Fill** color, which is the fill color for selected objects. Note that depending on the fill assigned to a selected object, its Selection Fill color may vary.
- Specify the **Editing Transparency**, which is the degree to which the selection fill and edit handles are transparent. The default value is 20%.
- Specify the **Handle Fill** color, which is the fill color of the edit handles for selected objects.
- Specify the **Secondary Handle Fill** color, which is used to identify special edit handles such as the Key Frame handles on Walkthrough Paths. See *Key Frames on page 816*.
- Specify the **Selected Edge Handle Fill** color, which is the fill color of the edit handle on a selected object's Selected Edge. See *Selected Edge on page 142*.

Note: If the Selection Line and Handle Fill Colors are similar, it may be difficult to distinguish between active and inactive CAD Points.

2 Interface Colors

Specify the colors for a variety of different elements in the software's interface by selecting an option from the drop-down list:

- Select "System" to use your operating system's color settings.
- In the Mac version of the software, select "Force Light" to use Light Mode in Home Designer regardless of the system settings, or "Force Dark" to use Dark Mode in Home Designer regardless of the system settings.
- Select "Custom Color Theme" to apply a color theme to the program interface and select its characteristics below.

The table and settings that follow are only available when "Custom Color Theme" is selected, above:

- The table lists all available Color Themes. Click on a line item to select and activate that color theme.
- Locked themes are installed with the program and cannot be modified or deleted.
- To create an unlocked theme, select any theme in the list and click the **Copy** button.
- Select an unlocked theme and click the **Rename** button to specify a new name.
- Select an unlocked theme and click the **Delete** button to remove the theme from the list.
- When an unlocked theme is selected, the settings below the table are enabled, allowing you to specify the colors for a variety of elements in the program interface.
- When **Toolbar Button/Image Backgrounds** is unchecked, toolbar buttons and images in dialogs use the Dialog/Toolbar Background color.

The program interface will update as you select different color themes or edit the selected unlocked theme's color settings.

FONT PANEL

The FONT panel controls the font used by dimensions in legacy plans when they are opened in Home Designer Pro 2022, as well as the font used in the Materials List.

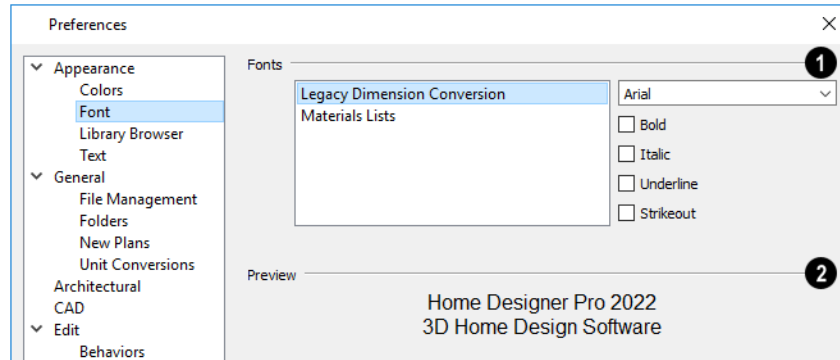

1 Fonts

Specify the Fonts for use in Legacy Dimension Conversion and Materials Lists.

- Select **Legacy Dimension Conversion** from the list to specify the font used by dimensions in legacy files from Versions 7 to 10. See [Dimensions on page 311](#).
- Select **Materials Lists** from the list to specify the font used by Materials Lists and the Master List. See [Materials Lists on page 904](#).

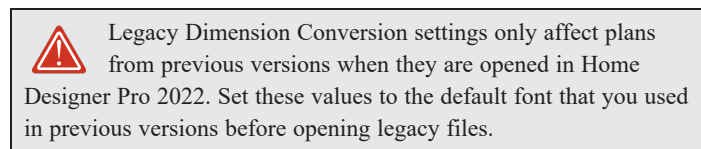

- Select a **Font** from the drop-down list for the use selected to the left. See [Fonts and Alphabets on page 339](#).
- Select one or more font styles to apply to the selected use: **Bold**, **Italic**, **Underline**, and/or **Strikeout**.

2 Preview

A sample of the selected font and style displays here.

For information about text in Home Designer Pro 2022 files, see [Text, Callouts, and Markers on page 337](#).

LIBRARY BROWSER PANEL

The LIBRARY BROWSER panel controls the appearance of the Library Browser window. See [The Library Browser on page 669](#).

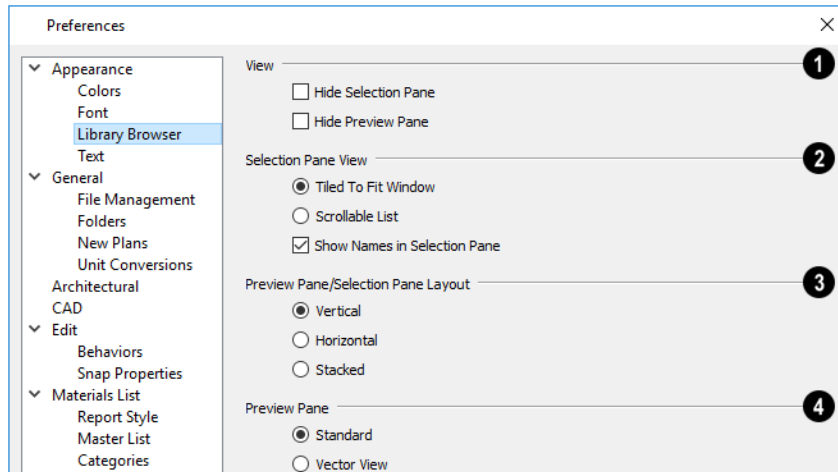

1 View

Control the display of the main sections of the Library Browser.

- Check **Hide Selection Pane** to hide the pane that displays objects in a selected catalog or folder.
- Check **Hide Preview Pane** to hide the pane that shows a preview of a selected object.

2 Selection Pane View

Specify how objects in the Selection Pane are presented.

- Select **Tiled to Fit Window** to display all items in a catalog or folder. If there are many items, their previews may be very small to fit in the pane.
- Select **Scrollable List** to display all items in the selected catalog or folder in a scrollable list. If there are many objects, the list may be long but each object preview will be sized to fit the pane.
- Check **Show Names in Selection Pane** to display the names of the objects in the Selection Pane.

3 Preview Pane/Selection Pane Layout

Select a radio button to change the layout of the Library Browser's sections.

- **Vertical** - Displayed sections of the Library Browser are divided vertically.
- **Horizontal** - Displayed sections are divided horizontally.
- **Stacked** - Displayed sections are divided both horizontally and vertically.

4 Preview Pane

Specify whether selected library items in the are displayed using the **Standard** or **Vector View** Rendering Technique. See [Rendering Techniques on page 785](#).

To restore the original size and position of the Library Browser and other side windows, click the **Restore Side Windows** button on the [Reset Options Panel on page 86](#).

TEXT PANEL

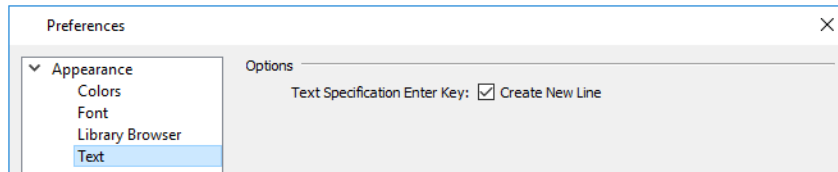

Text Specification Enter Key

- Uncheck **Create New Line** to close the Text and Rich Text Specification dialogs when the Enter key is pressed. When this is checked, a new line of text is created when Enter is pressed and the dialog remains open.

GENERAL PANEL

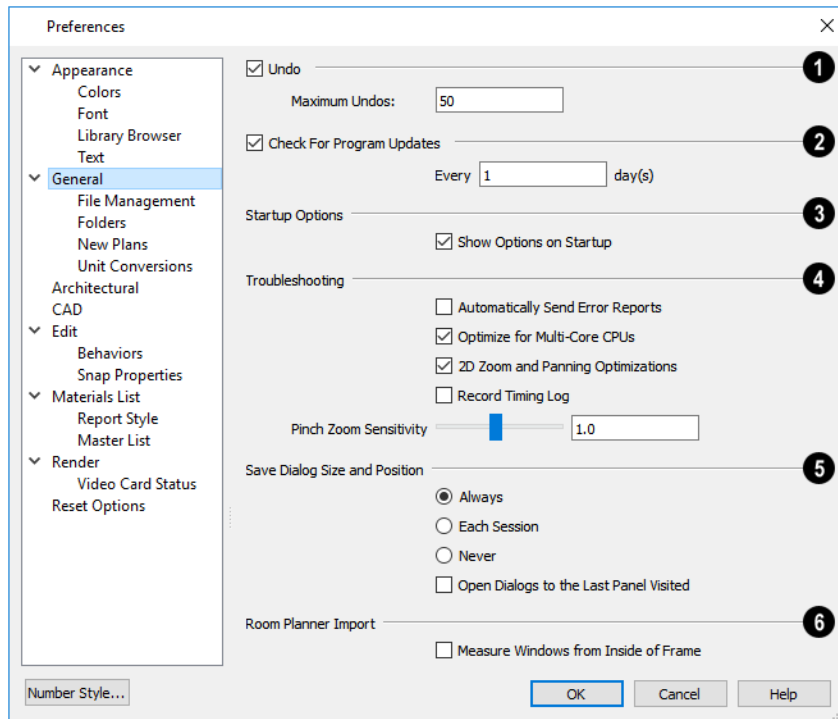

1 Undo

- When Undo is checked, the Undo and Redo commands can be used. See [Undo and Redo on page 191](#).
- **Maximum Undos** - Specify how many levels of Undo and Redo you want available, from 1 to 100. Undo files are saved in the Undo Directory.

2 Check For Program Updates

- When **Check For Program Updates** is checked, Home Designer will check for updates when the program is launched.
- By default, Home Designer checks for program updates once a day when the program is launched. You can specify a different frequency, in days, if you prefer.

3 Startup Options

- When **Show Options at Startup** is checked, the Startup Options dialog opens when Home Designer is launched. See *Startup Options on page 10*.

4 Troubleshooting

- Check **Automatically Send Error Reports** to automatically send a report to Chief Architect in the event of a program error. This box becomes checked automatically if you click the Send Report button in an error message box. If an unsent error report generated during the current program session exists, it will be sent automatically if this box is checked by the user. See *Error Messages on page 963*.
- Uncheck **Optimize for Multi-Core CPUs** to turn off program optimizations for multi-core processors. This box is checked by default and should only be unchecked for technical troubleshooting purposes.
- Uncheck **2D Zoom and Panning Optimizations** to turn off program speed optimizations for zooming and panning in 2D views.
- Check **Record Timing Log** to have the program create an event timing log in the Hidden User Settings Folder for troubleshooting purposes. Unless you are actively troubleshooting program performance, this box should be unchecked.
- Specify the desired **Pinch Zoom Sensitivity**, which affects the zoom rate for touch screens, trackpads, as well as Ctrl+scroll wheel actions in Home Designer. The default value is 1. See *Using Input Devices on page 13*.

Additional options are available in the Mac version of the software only:

- When **Mouse Movement Optimizations** is checked, zooming using the mouse scroll wheel is optimized for Mac systems. This box is checked by default and should only be unchecked when troubleshooting issues with the mouse scroll wheel in the Mac version of the software.
- Use the **Mouse Scroll Sensitivity** scrollbar or text field to control how sensitive the mouse scroll wheel is when zooming using the mouse scroll wheel in the Mac version of the software.

5 Save Dialog Size and Position

Specify when the program should remember dialog sizes and positions: **Always**, **Per Session**, or **Never**. See *Dialog Size and Position on page 19*.

- Check **Open Dialogs to the Last Panel Visited** to open paneled dialogs to the last panel that you accessed during the current program session. When unchecked, dialogs always open to the first panel. See *Dialogs on page 18*.

6 Room Planner Import

Specify how window sizes in **Room Planner Imports** are measured. See *Import Room Planner File on page 830*.

- Check **Measure Windows from Inside of Frame** to measure window heights and widths from the inside of the frame. When unchecked, window sizes are measured from the outside of the window frame, as they are in the Window Specification dialog in Home Designer. See *General Panel on page 404*.

FILE MANAGEMENT PANEL

The settings on the FILE MANAGEMENT panel let you modify functions related to the program’s plan and layout file management.

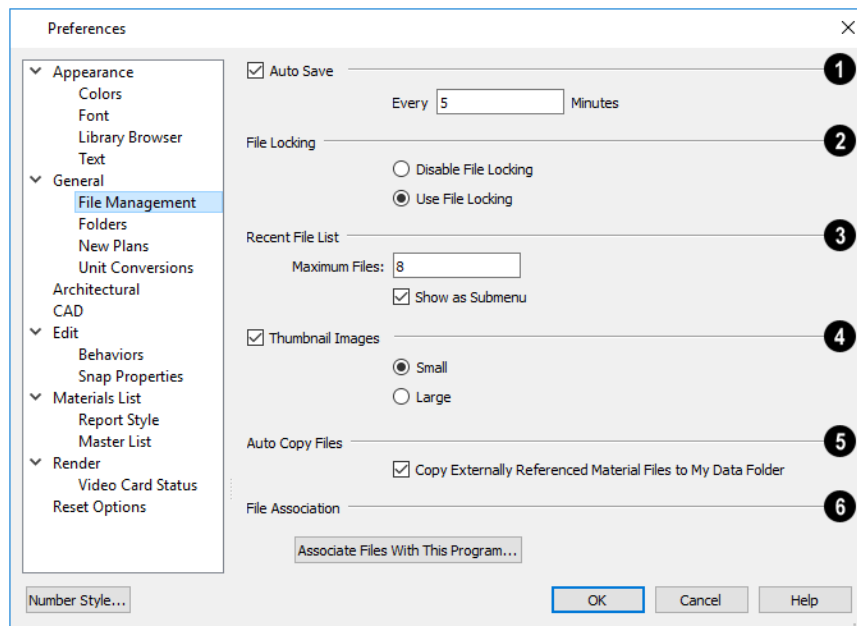

1 Auto Save

- Check **Auto Save**, then enter a value greater than zero in the text field to specify the frequency in minutes that Auto Save files are created. Auto Save files are stored in the Archive folder. See *Auto Save Files on page 41*.

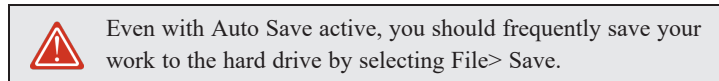

2 File Locking

Choose whether or not to lock **.plan** and **.layout** files when they are open. File Locking prevents another program or copy of Chief Architect software from opening and modifying the same file at the same time and is recommended in nearly all circumstances.

- Select **Use File Locking** to lock files.
- Select **Disable File Locking** to disable this feature.

3 Recent File List

Specify the maximum size and location of the Recent File List.

- Specify the maximum number of recently opened **files** to list in the Startup Options dialog and at **File> Open Recent Files**. You can open any of the files in this list by selecting it, making it a quick way to access your most recent work.
- Uncheck **Show in Submenu** to display the Recent File List at the bottom of the File menu rather than in a submenu.

4 Thumbnail Images

Thumbnail images are file previews that display when opening or searching for saved plan and layout files. See [Thumbnail Images on page 39](#).

- Check **Thumbnail Images** to automatically create thumbnail images when a plan or layout is first saved. If this option is disabled, you can still create thumbnails manually.
- Select either **Small** or **Large thumbnails**. Large thumbnails provide a higher quality image but result in larger file sizes.

5 Auto Copy Files

- When **Copy Externally Referenced Material Files to My Data Folder** is checked, the program automatically makes a copy of the material texture files associated with any custom materials that you create in your Home Designer Pro 2022 Data folder. This can help prevent these files from becoming lost if the originals are deleted. See [About Materials on page 712](#) and [Home Designer Pro Data on page 33](#).

6 File Association

- Click the **Associate Files With This Program** button to direct your computer's operating system to associate all **.plan**, **.layout**, **.calib**, and **.calibz** files with Home Designer Pro 2022. This button will not be active if plan, layout, and library files are already associated with this program and version. See [File Association on page 32](#).

FOLDERS PANEL

Home Designer stores many support files in various folders on your computer. The default locations of these directories are listed and can be redefined on the FOLDERS panel if necessary.

You do not need to change default locations under normal circumstances, but sometimes it may be preferable to locate certain files in another location. To specify a new default folder for a particular purpose, click the **Browse** button to the right of that item.



Changing settings on the Folders panel can result in unexpected program functionality.

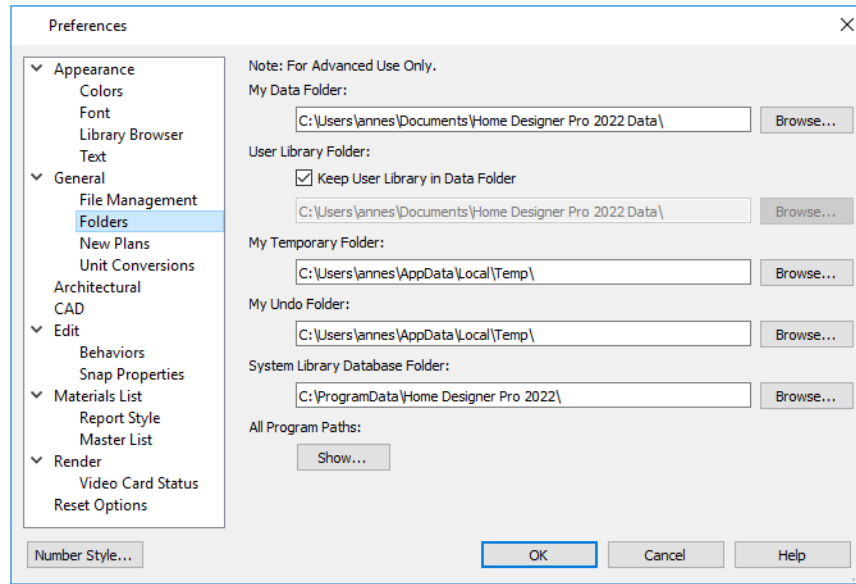

- Important user-specific information is stored in the **Home Designer Pro 2022 Data** folder, which is located in your Documents directory by default. See [Home Designer Pro Data on page 33](#). If you specify a new location, any custom toolbars or other settings that you may have will not be copied to the new location: you can do this yourself if you wish.

 Make sure that the location you specify is accessible and has adequate space for the files in this folder. See [Data Folder Name and Location on page 34](#).

- The **User Library Folder** contains custom library objects saved in the User Catalog in the Library Browser. When **Keep User Library and Referenced Files in Data Folder** is checked, this folder's location will update if you specify a new location for the Data folder, above. When this is unchecked, this folder will remain in the location specified below. If you specify a new location, the program will automatically copy your existing User Library content as well as your Backdrops, Images, Patterns, and Textures folders to the new location. See [The User Catalog on page 677](#).
- By default, **Temporary** files and **Undo** files are stored in the same folder. If you wish to use a different folder, you must specify a directory on a hard drive with sufficient space to hold these files. See [Undo and Redo on page 191](#).
- Home Designer will not let you save your work in the Temporary or Undo folder, or open files saved in either location.
- All library content aside from your User Catalog is stored in the **System Library Database Folder**. By default, this folder is created in the directory intended for shared application data in your operating system (C:\ProgramData in Windows;/Library/Application Support in macOS). If you specify a new location, the program will automatically copy your library content to that location. See [Library Content on page 677](#).

 If you choose to use a different folder, you must specify a directory on a hard drive with sufficient space to hold these files.

- **All Program Paths** - Click the **Show** button to open the Program Paths dialog, where you can find the location of files that may be needed for troubleshooting purposes. See [Program Paths Dialog on page 964](#).

NEW PLANS PANEL

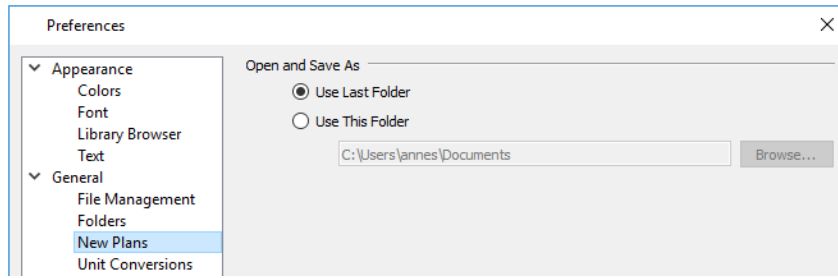

Open and Save As

Control how the program behaves when a new plan is opened or an existing plan is saved.

- **Use Last Folder** refers the program to the directory last used to save or open a plan file.
- **Use This Folder** refers the program to a particular location specified by you.
- Click the **Browse** button to define a particular directory when **Use This Directory** is selected.

UNIT CONVERSIONS PANEL

In many places throughout Home Designer, you can specify the size of an object with any Length unit listed on the UNIT CONVERSIONS panel. Using the data on this panel, the program will convert your entry into the unit set in the Dialog Number/Angle Style dialog. See *Dialog Number/Angle Style Dialog on page 87*.

These conversions are also useful when you import drawings. When an object is drawn in a Home Designer plan file, it is always at its true, unscaled size and the drawing is only scaled when you print it. This means that if you import a scaled drawing, you must compensate for its scaling by creating a custom unit of measurement. See *Import Drawing Assistant on page 832*.

The default unit conversions are locked and cannot be changed, but custom conversions can be added to the list and later modified.

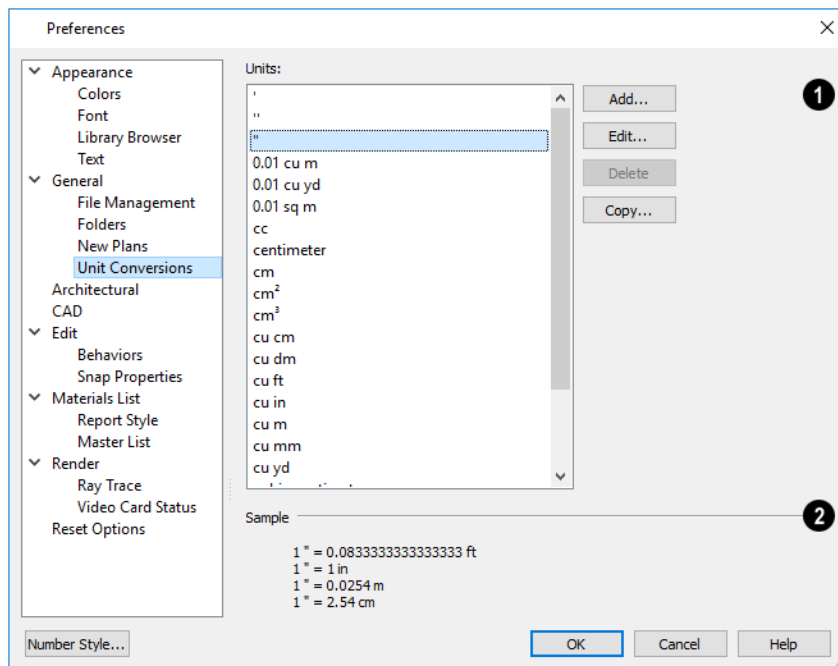

1 Units

A list of available units of measurement displays here. Click on the name of a unit to select it.

- **Add, Edit, Delete,** or **Copy** the unit conversions. Certain unit conversions are locked and cannot be edited or deleted.
- If you click **Add, Edit** or **Copy**, the Add Unit Conversion dialog displays.

2 Sample

An example of how the unit selected above converts to a selection of similar units. You can use this to verify that any unit conversion you create is correct.

ADD UNIT CONVERSION DIALOG

1 Unit Name

- Type a short, descriptive name of the new unit. Names must be unique: the names of units installed with the program cannot be used.
- Names can include any characters, as well as spaces. Bear in mind, though, that names of units for measuring length that have numbers in them may be unusable if entered in some dialogs in the program.
- Check **Default Unit** to display this new unit in places that present lists of available units. For example, if you have inches as units and make inches a default, inches appear on the list when you are given a choice of units, such as in the Import Drawing Assistant. In other places, such as the Materials List, all units are listed.

2 Measurement Type

Specify what the new unit measures.

- Select the appropriate radio button: **Length, Area,** or **Volume.**

3 Conversion

- Specify how much to **Multiply by** your custom unit **to convert to** the unit you select from the drop-down list. A measurement type must be selected before the list is populated.

4 Sample

An example of the Unit Conversion defined above displays here.

When importing a drawing with a 1" = 20' scale, for example, create a unit to convert this scaling to 1" = 1".

To create a new unit of measurement

1. Click the **Add** button to open the Add Unit Conversion dialog.
2. Type a short, descriptive name like “convert 1:20” in the **Unit Name** field.
 - Because this unit will be used only for scaling conversion, including numbers in its name will not cause any issues.
3. Select **Length** as the **Measurement Type**.
4. Type 20 in the **Multiply by** field.
5. Select “ft” from the drop-down list.

Note: You can achieve the same results if you Multiply by 240 to convert to inches.

6. Click **OK** to close the dialog.

ARCHITECTURAL PANEL

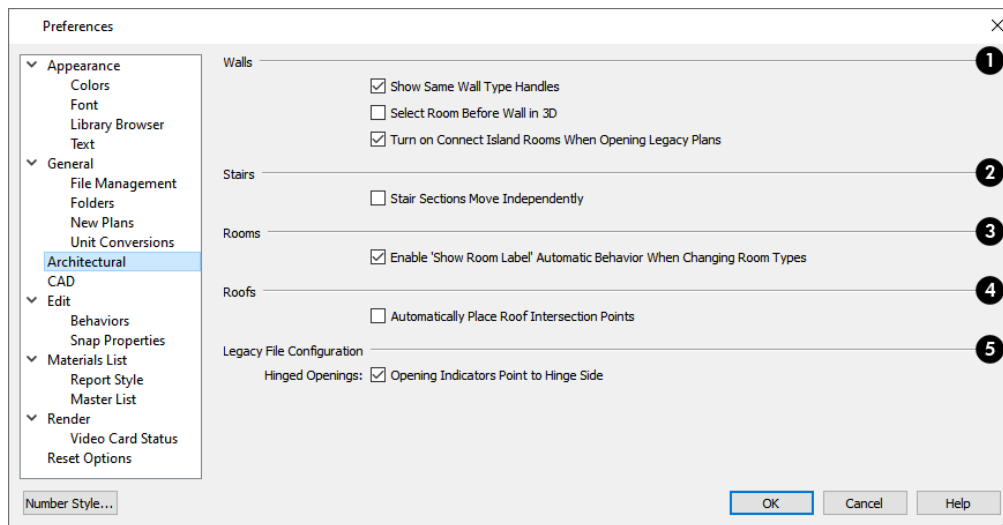

1 Walls

Select the desired default behaviors for selected walls.

- Check **Show Same Wall Type Handles** to display edit handles on selected walls that draw new walls of the same type when dragged. See [Same Wall Type Edit Handles on page 248](#).
- Check **Select Room Before Wall in 3D** to select the room defined by a wall when you click on the wall in 3D views. See [Selecting Rooms on page 284](#).
- Check **Turn on Connect Island Rooms When Opening Legacy Plans** to automatically connect “island” rooms an Invisible wall in legacy plans opened in Version 2022. See [Room Definition on page 280](#).

2 Stairs

- Check **Stair Sections Move Independently** to allow stair sections connected by landings to move separately, without moving the entire staircase. See *Editing Stairs and Ramps on page 517*.

3 Rooms

- Uncheck **Enable ‘Show Room Label’ Automatic Behavior When Changing Room Types** to prevent a room’s label from displaying when an “Unspecified” room is assigned a different Room Type in its Room Specification dialog. When this box is checked, the room label’s display will be enabled when the Room Type is changed from “Unspecified”. See *General Panel on page 300*.

4 Roofs

- Check **Automatically Place Roof Intersection Points** to automatically generate temporary CAD points that correspond to roof plane intersection points. When unchecked, these temporary points are not created. See *Locating Intersections on page 577*.

5 Legacy File Configuration

Specify how obsolete settings are handled when legacy files are opened in the current program version. See *Considerations for Legacy Files on page 968*.

- When **Opening Indicators Point to Hinge Side** is checked, the opening indicators for hinged openings point to the hinge side of the opening in legacy files opened in Home Designer Pro 2022. When unchecked, opening indicators in these files point to the handle side. See *Opening Indicators on page 370*.

CAD PANEL

The CAD panel controls whether or not objects snap together to form polylines and objects that behave like polylines. See *Polylines on page 214*.

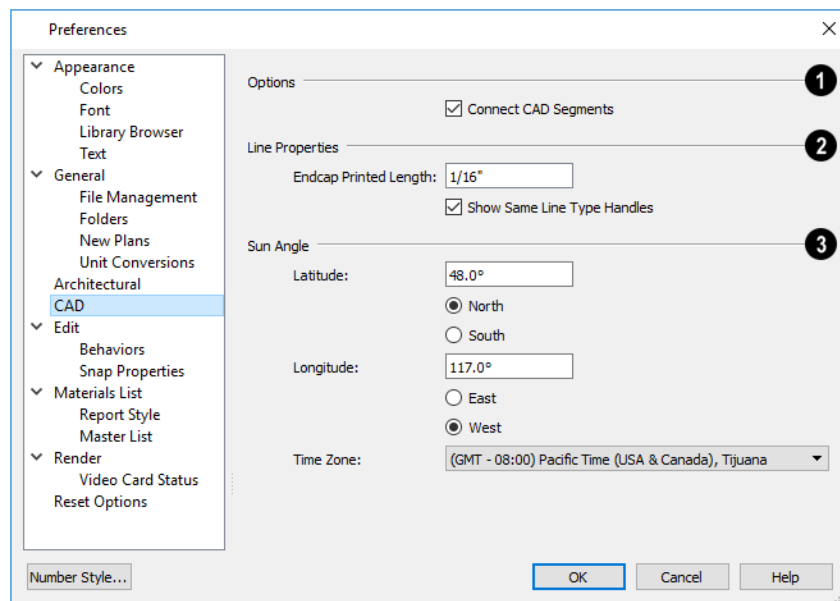

1 Options

- Uncheck **Connect CAD Segments**  to prevent CAD objects from snapping together to form polylines as they are drawn or edited. See *Connect CAD Segments on page 140*.

Note: Unlike other Preferences, the program always resets Connect CAD Segments to be on whenever you close the program.

2 Line Properties

These settings affect open CAD shapes, including lines, arcs, and splines.

- **Endcap Printed Length** - The beginning and end of CAD lines that use a dashed line style are sometimes difficult to distinguish. Endcaps can be placed to eliminate this problem. Specify the printed endcap length in inches (mm).
- Uncheck **Show Same Line Type Handles** to turn off the display of these edit handles on selected CAD objects. See *Same Line Type Edit Handles on page 202*.

3 Sun Angle

See *Sun Angles and Shadows on page 778*.

- Define the default **Latitude**, **Longitude** and **Time Zone** used when creating Sun Angles.

EDIT PANEL

The settings on the EDIT panel of the Preferences dialog control the appearance of the cursor and selection behavior of edit handles. See *Using the Crosshairs on page 168*.

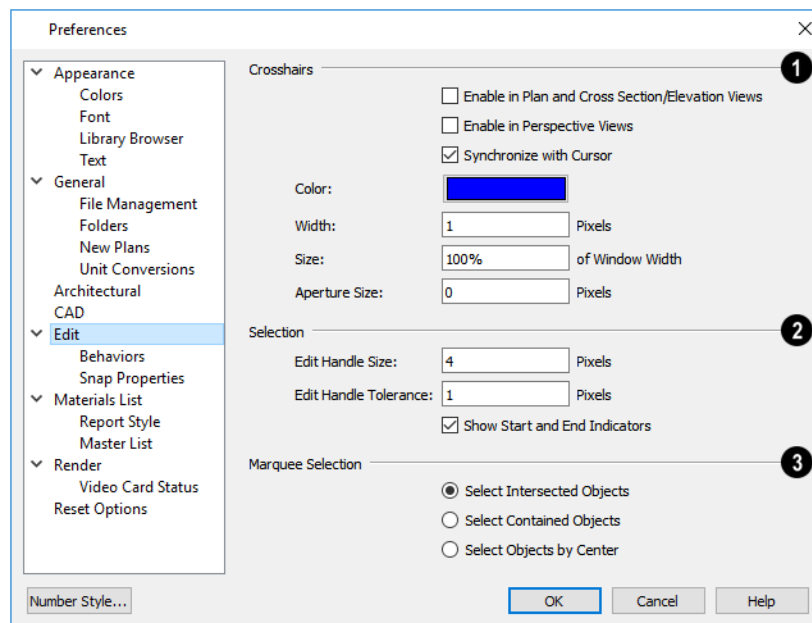

1 Crosshairs

You can use a cursor with Crosshairs in different view types and control its appearance. See [Crosshairs on page 15](#).

- Check **Enable in Plan and Cross Section/Elevation Views** to use a cursor with crosshairs in plan and cross section/elevation views. This option is checked by default.
- Check **Enable in Perspective Views** to use a cursor with crosshairs in perspective camera views and overviews.
- When **Synchronize with Cursor** is checked, the mouse pointer and crosshairs always move together on screen. If you feel that they do not keep up with your mouse movements, try unchecking this option.
- Click the **Color** bar to open the Select Color dialog and specify the color of the crosshairs.
- Specify the **Width** of the crosshairs lines, in pixels.
- Crosshairs **Size** is specified as a percentage of the view **Window Width**. Specify the **Size** as 100% to extend the crosshairs across the entire screen.
- Set the **Aperture Size**, measured in pixels. The aperture is the space where the crosshairs meet. A value of 0 makes the crosshairs meet at a point. Larger numbers leave a gap in the center.

2 Selection

Customize the appearance of some types of selected objects, and edit handle sensitivity.

- Enter an **Edit Handle Size** in pixels. The edit handles are twice this number of pixels plus one. For example, the default value is 4, which results in a handle that is 9 x 9 pixels ($4 \times 2 = 8$, and $8 + 1 = 9$). The minimum value is 1, which results in a handle that is 3 x 3 pixels.
- Enter a value, in pixels, for **Edit Handle Tolerance** to specify how close to an edit handle you must click in order to select it. The default value is 0.
- Check **Show Start and End Indicators** to display an S and an E at the start and end points of a selected wall or the selected edge of a CAD-based object. This can make it easier to edit the selected edge in the object's specification dialog. See [Selected Edge on page 142](#).

3 Marquee Selection

Specify program behavior when selecting objects using a marquee. See [Marquee Select on page 143](#).



Select Intersected Objects selects any objects whose bounding boxes are intersected by or located within the marquee.



Select Contained Objects selects only objects located entirely within the marquee. This option provides the best results in most situations.



Select Objects by Center selects only objects whose center points are located within the marquee.



You can add the Selection Modes tools to your toolbars. See [To add a button to a toolbar on page 92](#).

BEHAVIORS PANEL

The settings on the BEHAVIORS panel of the Preferences dialog define basic editing behaviors of CAD and architectural objects.

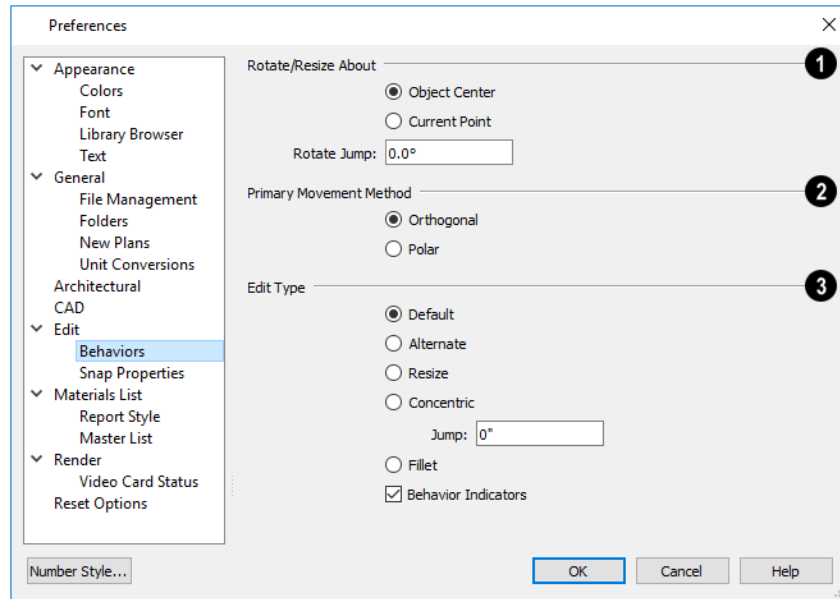

1 Rotate/Resize About

Define the point about which an object or a group of objects rotates or resizes. See [Rotate/Resize About on page 112](#).

- Select **Object Center** to rotate or resize the selection about its center point. Object Center is the default setting.
- Select **Current Point** to rotate the object about the current CAD point instead.
- To resize a CAD object about a current point, select the **Resize** Edit Type.
- This function can also be accessed by selecting **Edit> Edit Behaviors> Resize** . See [Defaults, Preferences, and Edit Behaviors on page 137](#).
- **Rotate Jump** defines the angles an object or group of objects jumps to as it is rotated. When this value is set to 0°, the Allowed Angles set in the Plan Defaults dialog are used; otherwise, Allowed Angles are ignored.

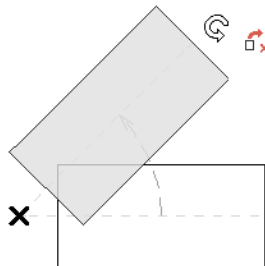

2 Primary Movement Methods

Control the directions that you can move objects using their edit handles.

- Select **Orthogonal** to move an object perpendicular to any of its edges.
- Select **Polar** to move an object at Allowed Angles.

3 Edit Type

Specify the active Edit Behavior. See *Defaults, Preferences, and Edit Behaviors on page 137*.

- If **Concentric** is selected, specify the desired **Jump** increment.
- Uncheck **Behavior Indicators** to turn off the display of the mouse pointer icons associated with these Edit Behaviors. This box is checked by default.

Note: Unlike other Preferences, the program always restores the Default Edit Behavior whenever you close the program.

SNAP PROPERTIES PANEL

The settings on the SNAP PROPERTIES panel of the Preferences dialog control the behavior of Object Snaps as well as the appearance of snap indicators. See *Object Snaps on page 113*.

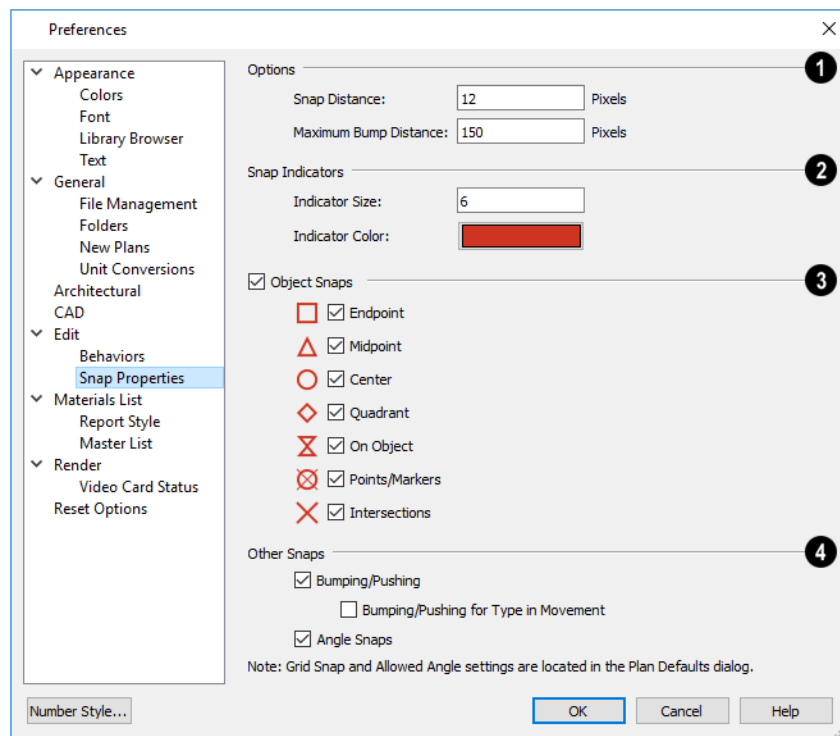

1 Options

- Specify the **Snap Distance**, which is how far the cursor can be from a snap point for the snap to occur. This value is measured in screen pixels; the default value is 12. When working with very small objects, you may find it helpful to reduce this value; when working with very large objects, it may be helpful to increase it. This setting also controls the minimum length of camera and cross section/elevation lines of sight. See *Creating Camera Views on page 741*.
- Specify the **Maximum Bump Distance**, which is the distance that a selected object must be dragged to override bumping and move past an obstructing object.

2 Snap Indicators

- Specify a snap **Indicator Size** in pixels. This setting also controls the size of temporary CAD Points. See *Place Point on page 196*.
- Click the color bar to select a snap **Indicator Color** from the Select Color dialog. See *Select Color Dialog on page 134*.

3 Object Snaps

These options can also be turned on and off using the toggle buttons on the toolbar and/or keyboard hotkeys.

Check **Object Snaps** to enable the object snap options, below.

Endpoint enables snapping to the ends of lines, arcs, splines and other objects.



Endpoint snaps

Midpoint enables snapping to the midpoint of an object such as a line or arc. For objects such as boxes, you can snap to the midpoint of any side of the box.

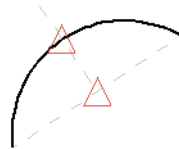

Midpoint snaps

Center enables snapping to the center of cabinets, fixtures, furniture, as well as circles and arcs.



Center snap

Quadrant enables snapping to the left, right, top, or bottom of an object. Only used for arcs and circles.

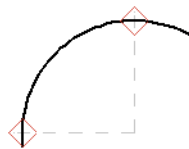

Quadrant snaps

On Object enables snapping to any point on the selected object, including CAD objects and cabinets.

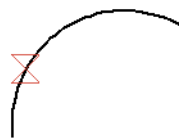

On Object snap



Points/Markers allows you to snap to temporary CAD points. Note that this only affects CAD Points, not Text Markers. See [Point Tools on page 195](#).



Points/Markers snap



Intersection enables snapping to the intersection of two objects, such as the intersection of a line with another line. Intersection snapping also snaps extension lines to objects, and allows you to snap two extension lines to each other.



Intersection snap

When Intersection snapping is enabled, wall extension line snapping will also occur. See [Creating Walls on page 236](#).

4 Other Snaps



Check **Bumping/Pushing** to allow objects to bump into and move other objects. See [Bumping/Pushing on page 166](#).

- Check **Bumping/Pushing for Type-in Movement** to cause objects moved using dimensions to bump into objects in their path of movement and stop. When unchecked, objects moved using type-in methods move to their specified destination locations. See [Moving Objects on page 165](#).



Check **Angle Snaps** to enable snapping to Allowed Angles. See [Angle Snaps on page 114](#).

MATERIALS LIST PANEL

The settings on the MATERIALS LIST panel control which categories are included in Materials Lists. The names of all categories and their ID prefixes are listed here. They are defined by the program and cannot be changed. See [Materials Lists on page 904](#).

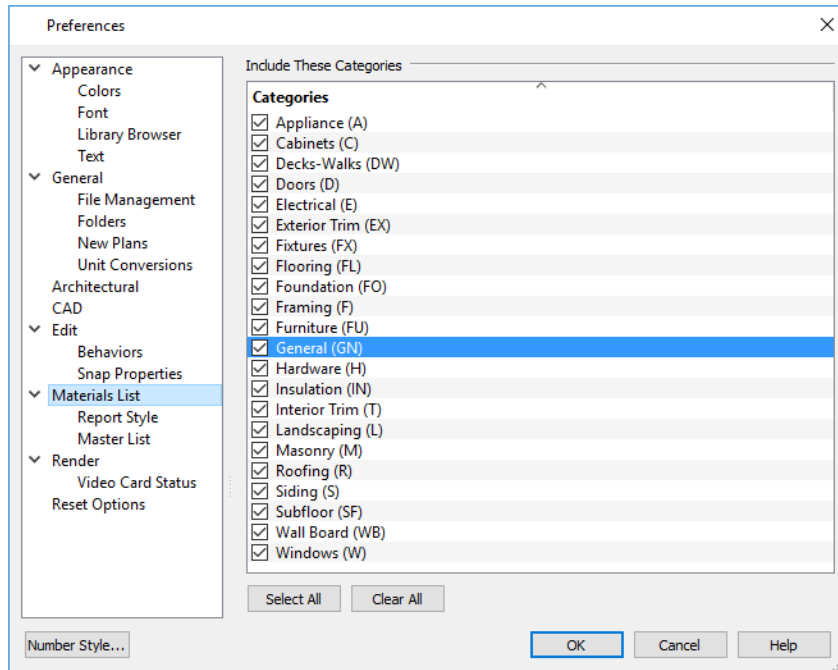

When a material is entered in the Materials List, the program decides what category it goes in and assigns it an ID, which is the prefix followed by a number. EX1 would be the first exterior trim piece entered in the Materials List for a particular plan.

- **Include These Categories** - Check the categories you want to include in every new materials list generated. Before you hide a category, make sure you know what items are listed within it.
- Click **Select All** to check the boxes beside all categories, or click **Clear All** to clear the check boxes beside all categories.



It is usually better to remove categories from individual plan lists in the Layer Display Options dialog, rather than globally. See [Layer Display Options Dialog on page 126](#).

REPORT STYLE PANEL

The REPORT STYLE panel controls the appearance of Materials Lists and the Master List.

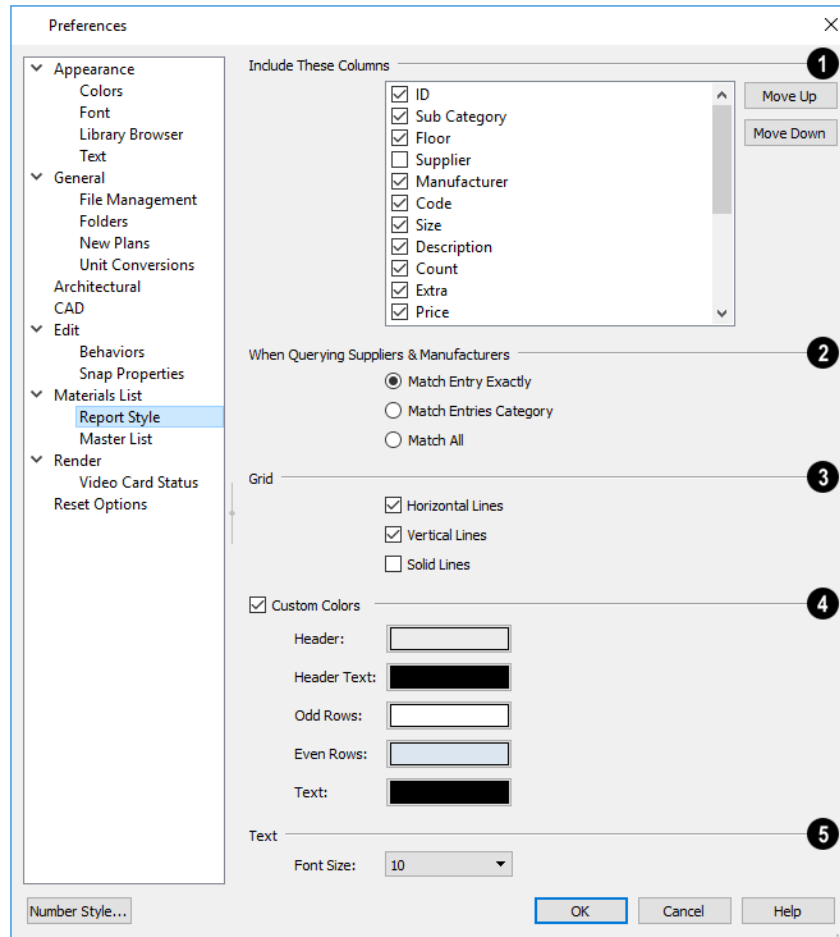

1 Include These Columns

Columns can be specified for an individual Materials List by choosing **Tools> Materials List Specification** while that Materials List is active. See *Materials List Specification Dialog on page 909*.

- Check the box beside each column to include it in newly created Materials Lists.
- Use the **Move Up** and **Move Down** buttons to change the order that columns appear. To change the order, select one or more items in the list and click the button. The selected columns move up or down by one in the list.

2 When Querying Suppliers and Manufacturers

Select an option to narrow or broaden your query when searching the Master List.

3 Grid

Choose whether grid lines display in the Materials and Master Lists, both on-screen and printed.

- Check **Horizontal Lines** for lines between Materials List rows.
- Check **Vertical Lines** for lines between Materials List columns.
- Check **Solid Lines** for a solid line style. When unchecked, dotted lines are used.

4 Custom Colors

- When **Custom Colors** is checked, Materials Lists use the colors defined below. When this is unchecked, either the colors associated with the active Color Theme or your operating system's default colors are used. See *Colors Panel on page 62*.
- **Background Colors** can be specified for **Odd** and **Even** numbered rows.

5 Text Font Size

Specify the height of the font used in the Materials List and Master List. See *Editing Materials Lists on page 914*.

MASTER LIST PANEL

The MASTER LIST panel specifies how the Master List(s) for materials appears. You can maintain Multiple Master Lists, but only one may be used at any given time. See *Materials Lists on page 904*.

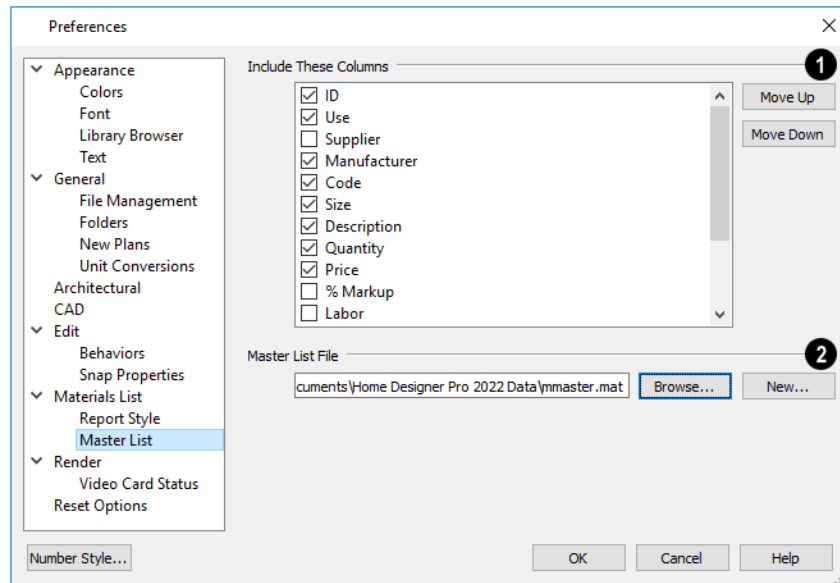

1 Include These Columns

- Use the **Move Up** and **Move Down** buttons to change the order of columns. To change the order, select one or more items in the list and click the button. The selected columns move up or down by one in the list.

2 Master List File

The name and pathname of the currently referenced Master List is shown. It is referenced for all subsequently opened plans when a materials list is generated.

- Click the **Browse** button to select a different Master List. Navigate the directory structure until you find the new Master List to be used, select it, and click **OK**.

Note: If the Master List file is saved in the program Data folder, and the location of My Data Folder is changed, this pathname will automatically update. See *Folders Panel on page 69*.

- Click the **New** button to create a new Master List. Name and save it in the location of your choice. When you create a new Master List, it is blank until you build a materials list and enter prices, supplier or manufacturer information. The Master List is saved automatically when you close.

RENDER PANEL

The settings on the RENDER panel control how 3D views are generated and navigated.

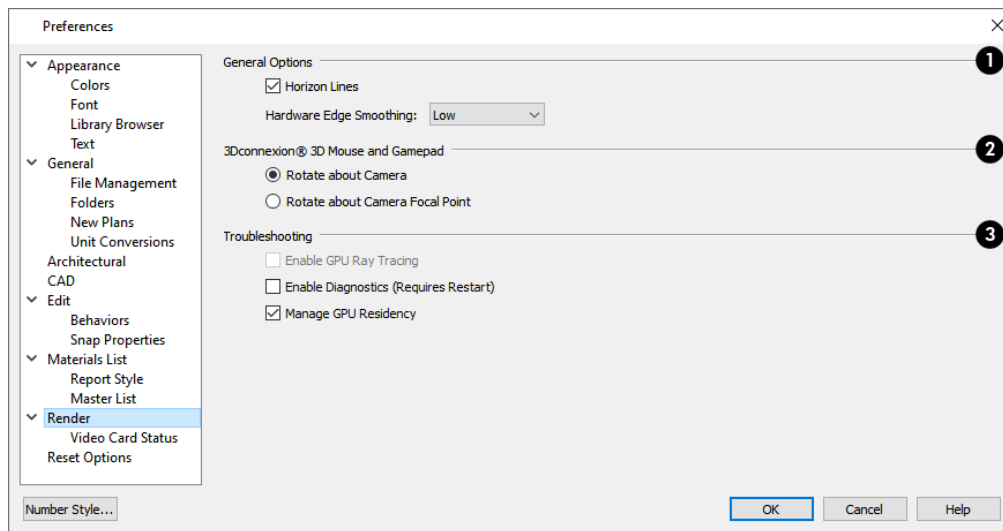

1 General Options

- **Horizon Lines** are lines that generate along the curved edges of symbol objects in Vector Views. Uncheck this box to increase the speed of Vector View generation but also suppress these lines. See *Vector View on page 785*.
- **Hardware Edge Smoothing** uses the video card to reduce the jagged appearance of angled surface edges and pattern lines, producing cleaner lines. The higher the smoothing effect, the longer the rendering time. See *Edge Smoothing on page 771*.

2 3Dconnexion® 3D Mouse and Gamepad

See *3Dconnexion® 3D Mice on page 750*.

- Select **Navigate about Camera** to center mouse movement about the location of the camera.
- Select **Navigate about Camera Focal Point** to center mouse movement about the location of the camera's focal point. See *To create a camera view on page 741*.

3 Troubleshooting

- In the Windows version of the program, uncheck **Enable GPU Ray Tracing** to disable enhanced shadow and ambient occlusion quality in 3D views that support these effects. This box is checked by default and should only be unchecked for troubleshooting purposes. If this option is disabled, it is not supported on the system. See *Rendering Tips on page 770*.
- In the Windows version of the software, the **Enable Diagnostics (Requires Restart)** option makes it possible for information about certain errors to be collected. Restarting with Diagnostics enabled will degrade program performance and should only be done when requested Chief Architect Technical Support. See *Contacting Technical Support on page 963*.
- **Manage GPU Residency** helps improve performance when printing very large files. This option is checked by default and should only be unchecked for troubleshooting of printing issues. See *Printing and Plotting on page 939*.

VIDEO CARD STATUS PANEL

The VIDEO CARD STATUS panel displays information about your video card, including the vendor and whether it supports the software's minimum requirements. See *System Requirements*.

This information may be important if you are having problems generating 3D views.

RESET OPTIONS PANEL

In order for some of the Reset Options to take effect, you will need to restart Home Designer.

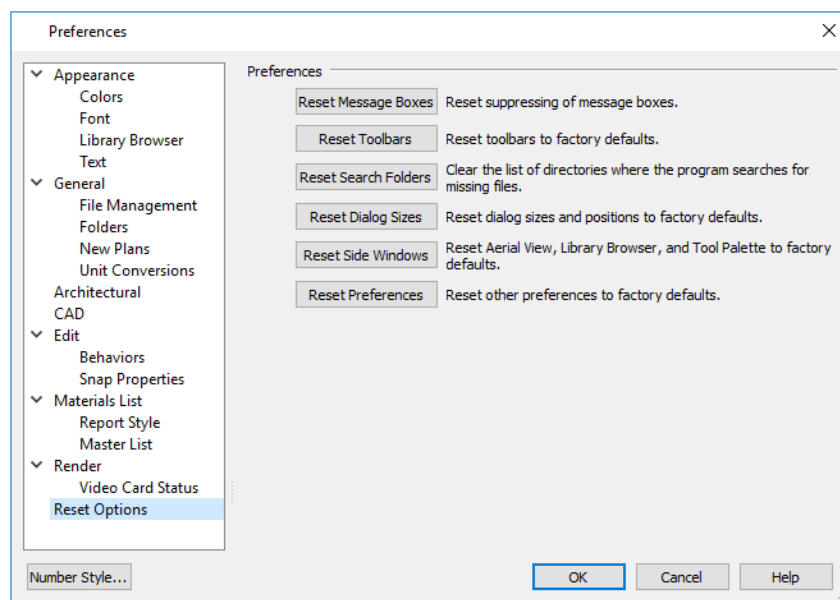

- If message boxes have been suppressed, you can make them display again by clicking **Reset Message Boxes**. See [Message Boxes on page 23](#).
- Click the **Reset Dialog Sizes** button to restore all dialog boxes to their original sizes and positions. See [Dialogs on page 18](#).
- Click the **Reset Toolbars** button to reset all toolbars to their original states. If you are encountering warning messages regarding toolbars, this option may resolve the issue. Note that any custom toolbar configurations that you may have created will be discarded if you click this button. See [Creating Custom Toolbar Configurations on page 94](#).
- Click the **Reset Side Windows** button to restore all side windows to their original sizes and positions. Tool Palette Settings  are also reset, as are the panes in the Library Browser. See [Side Windows on page 16](#).
- Home Designer retains a list of locations where you have located missing files in the past. If you find that the program takes a long time searching before informing you that files are missing, you can click the **Reset Search Folders** button to clear this list. See [Referenced Files on page 43](#).
- Click the **Reset Migration** button to be prompted to migrate your content and settings from an older program version the next time you launch the software.
- Click the **Reset Preferences** button to restore all preferences to those originally installed with the program.

 Resetting all preferences to default can be a drastic step and should be done with caution.

Dialog Number/Angle Style Dialog

At the bottom of many dialogs, you can click the **Number Style** button to open the Dialog Number/Angle Style dialog.

The settings in this dialog are global and control the format of distances, coordinates and angles of angles in dialog boxes and inline text fields, as well as in the Status Bar. They are also persistent for the current program session only: when you restart the program, they are reset. See [The Status Bar on page 23](#).

These settings control the format of values used in dialogs but do not limit how you must enter these values. For example, if you set your Number Style to use Inches, values will display using fractional inches. You can, however, enter values using decimal inches, inches and feet, or even decimal feet by including the appropriate unit indicators. When the dialog you're typing in updates, the value will be converted to fractional inches.

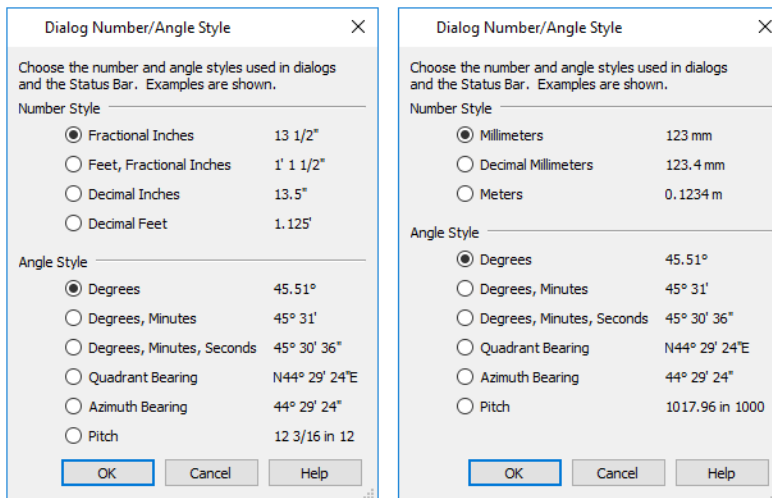

When Imperial units are used, the **Fractional Inches** and **Feet, Fractional Inches** options use fractional inches with denominators of 2, 4, 8 and 16. A few objects, notably text, dimensions, and floor, ceiling and wall structure layers can be sized using smaller fractions with larger denominators.

Angles can be displayed using one of the following methods:

- **Degrees/Minutes/Seconds** - Measured counterclockwise from a line drawn horizontally to the right of the angle's vertex. Useful for most drawing tasks. Select the level of accuracy that you require.
- **Quadrant Bearings** - Measured from a vertical line representing North/ South, Quadrant Bearings use directional bearings in their measurements. Useful for site drawings.
- **Azimuth Bearings** - Measured from a line drawn straight up from the angle's vertex (ie, North on a site plan). Useful for site drawings, Azimuth Bearings use degrees, minutes, and seconds in their measurements.
- **Pitch** - Defined as a ratio of vertical rise to horizontal run. In Imperial units, the run is always 12"; in metric units it is 1000 mm. Useful for roofs.

Quadrant and Azimuth Bearings are affected by the orientation of the **North Pointer** , if one is present in the current plan. See *North Pointer on page 778*.

Toolbars and Hotkeys

Chapter 5

Two of the most efficient ways to access Home Designer’s tools and settings are the toolbars and keyboard shortcuts, also referred to as hotkeys.

TOPICS

Toolbar Arrangement	90
Customizing Toolbars	91
Creating Custom Toolbar Configurations	94
Toolbar Customization Dialog	95
Hotkeys	98
Gamepad Settings Dialog	99

Toolbar Arrangement

Home Designer’s toolbars provide fast access to the program’s most commonly used tools and settings, and are organized so that related tools are grouped together and easy to find.

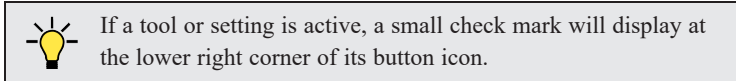

The toolbars that display in a given view depend on the view type. For example, the toolbars that are available in floor plan and 3D views are not available in Materials Lists. Some toolbars are available in more than one type of view. If a tool cannot be used in that view, its icon will appear pale grey in color.

You can turn off the display of toolbars entirely or turn them on again by selecting **View> Toolbars**

Many of Home Designer’s tools are organized into families of related tools which can be accessed using either of two styles of toolbar interface: the **Child Tool Palette** or **Drop Down** tools. You can select the interface that you prefer in the Preferences dialog. See [Appearance Panel on page 60](#).

DROP-DOWN TOOLS

Click on the arrow to the right of a button to display a drop-down list of related tools. For example, click the arrow to the right of the **Window** button to display a drop-down list of the other Window Tools.

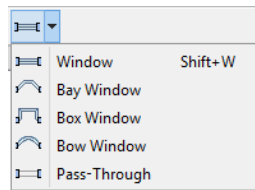

The most recently selected tool displays in the toolbar.

CHILD TOOL PALETTE

An alternative to Drop-Down toolbars is the Parent button and Child Tool Palette interface. Parent toolbar buttons have a blue triangle in the lower right corner. When you select a Parent button, its Child tools display in the Child Tool Palette. If the Child Tool Palette has been closed, it will open.

By default, the Child Tool Palette is docked on the left side of the program window; but it can be undocked and moved, as well as resized and closed, just like other side windows. See [Side Windows on page 16](#).

As long as it is open, the Child Tool Palette will also display the members of a selected tool’s family when the Drop Down interface is active. If you select a tool that does not belong to a family, the previously selected tool’s family will continue to display in the Tool Palette.

When you click the **Window Tools** Parent button, for example, its Child buttons display in the Child Tool Palette.

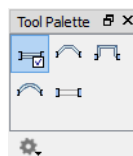

Click the **Settings**  button at the bottom of the palette to select how the tools within it are presented:



Fit Palette: resize the palette so that it is one row wide.



Grid View: display only the button icons of the child tools in a grid that may have multiple rows, depending on the width of the palette side window.



List View: display child tools in a vertical list with each tool's button icon and name in a row.

You can open the Tool Palette at any time, even when Drop Down tools are enabled, by selecting **View> Tool Palette** .

See [View Tools on page 105](#).

THE EDIT TOOLBAR

The Edit Toolbar is a special toolbar that only features buttons when one or more objects in the drawing window is selected. By default, it is located at the bottom of the program window, just above the Status Bar. The buttons on this toolbar vary, depending on the type of object selected, the current view, and how you selected the object; when no object is selected, it is blank.



TOOLBAR CONFIGURATIONS

Home Designer Pro installs a set of Toolbar Configurations, which control what tools are initially included in the toolbars, as well as where these toolbars are located.



The **Default Configuration** displays architectural tools used for house design, including walls, windows, doors, stairs, cabinets, etc.



The **Terrain Configuration** displays buttons associated with the terrain and road tools, including the plant and sprinkler tools. See [Terrain Toolbar Configuration on page 847](#).



The **Space Planning Configuration** displays buttons associated with the Space Planning Assistant. See [Space Planning on page 47](#).

To switch toolbar configurations

There are several ways to switch from one Toolbar Configuration to another.

- Click a Toolbar Configuration button.
- Choose a configuration in the Toolbar Customization dialog. See [Configurations Panel on page 97](#).
- Right-click in an empty space on any toolbar and select a **Toolbar Configuration** from the contextual menu.

TOOLBAR BUTTON SIZE

By default, toolbar buttons are sized at 20 pixels, which works well on most computer monitors running default system settings. If you wish, you can increase or decrease this size in the Preferences dialog. See [Appearance Panel on page 60](#).

Customizing Toolbars

The Toolbar Configurations installed with the program are designed to help make tools quickly and easily accessible; however, for greatest efficiency, you may want to customize them to meet your own particular needs. A number of options

are available:

Any changes made to an existing Toolbar Configuration will be saved whenever you:

- Switch to a different configuration;
- Close the Toolbar Configuration dialog;
- Exit out of Home Designer.

Bear in mind that the size of the Home Designer program window and the space available for toolbar button depends on your monitor's size and screen resolution settings.

TOGGLING TOOLBARS



You can turn off the display of all toolbars entirely or turn them on again by selecting **View> Toolbars**.

There are also several ways to toggle individual toolbars on or off:

- Right-click in an empty space on any toolbar and mouse over **Toolbars** in the contextual menu. In the submenu, toolbars with a check mark next to their name are on in the current view. Click on a toolbar name to turn it off if it is on, or vice versa.
- Toolbars can be turned on or off in the Toolbar Customization dialog. See *Toolbar Panel on page 96*.
- If a toolbar is undocked, click the **Close** button at its top right corner.

MOVING TOOLBARS

You can move any toolbar to a different location by clicking and dragging its dotted grab bar. Toolbars can be docked to any side of the program window, or they can be undocked and left floating.

Undocked toolbars can be moved outside of the program window, and they can be closed completely. They can also be reshaped; however, they cannot be resized in such a manner that any buttons become hidden.

Changes to toolbars are saved between program sessions.

ADDING AND REMOVING BUTTONS

Toolbar buttons can be added to or removed from toolbars using the Toolbar Customization dialog.

To add a button to a toolbar

1. Select **Tools> Toolbar and Hotkeys> Customize Toolbars**  and go to the TOOLS panel of the Toolbar Customization dialog. See *Tools Panel on page 95*.
2. Select the **View Type** that you want to add a toolbar button in.
 - You can add any buttons you like to any View Type; however, not all buttons will necessarily be available for use in all views.
3. Search or browse to find the desired button or its parent in the **Available Toolbar Buttons** list.
4. Click and drag the button you wish to add to a toolbar out of the dialog box.
 - Drop it onto an existing toolbar to add the button to that toolbar.
 - Drop it away from an existing toolbar to create a new toolbar. See *To create a new toolbar on page 93*.

To remove a button from a toolbar, open the Toolbar Customization dialog, then click and drag the button out of the toolbar area.

Buttons cannot be added to or removed from the Edit Toolbar. See *The Edit Toolbar on page 91*.

ADDING AND REMOVING TOOLBARS

Toolbars can be added to or removed from each View Type using either the toolbar contextual menu or the Toolbar Customization dialog.

To add or remove an existing toolbar

1. Right-click on an empty space in a toolbar.
2. In the contextual menu, click on the name of a toolbar.
 - If the toolbar has a check mark next to it, clicking on it will clear the check mark and remove the toolbar from the current View Type.
 - If the toolbar does not have a check mark next to it, clicking on it will add the toolbar to the current View Type.

You can also specify which toolbars are used in each View Type in the Toolbar Customization dialog. See *Toolbar Panel on page 96*.

CREATING NEW TOOLBARS

New toolbars can be created using the Toolbar Customization dialog.

To create a new toolbar

1. Select **Tools> Toolbar and Hotkeys> Customize Toolbars**  and go to the TOOLS panel of the Toolbar Customization dialog.
2. Select the **View** type to which you want to add a new toolbar.
3. Select the first button that you want on the toolbar from the **Available Toolbar Buttons** list.
4. Click and drag the button out of the dialog box and drop it:
 - In an empty section of the program window border to create a new toolbar docked at that location.
 - In the drawing area to create a new, undocked toolbar.
5. Additional buttons can be added by dragging them onto to this new toolbar.



Use the Empty Space button in your toolbars as a spacer.

6. A new toolbar will inherit the name of the first tool that was added to it, preceded by the word Custom. You can assign a new name on the TOOLBAR panel of the Toolbar Customization dialog.
7. Also on the TOOLBAR panel, specify the View Types that the new toolbar should be used in.

LOCKING TOOLBARS



When your toolbars are organized the way you want them, you can select **Tools> Toolbars> Lock Toolbars** to prevent them from being moved. Select the same tool to unlock toolbars. **Lock Toolbars** is also available in the contextual menu for toolbars: right-click in an empty space on any toolbar to access it. See *Contextual Menus on page 18*.

RESTORING TOOLBARS

To discard your changes and restore all installed Toolbar Configurations to their original condition, click the **Reset Toolbars** button in the Toolbar Customization dialog. See [Toolbar Panel on page 96](#).

Because resetting toolbars affects all installed Toolbar Configurations, you may find it worthwhile to create your own custom Toolbar Configurations. See [Creating Custom Toolbar Configurations on page 94](#).

You can also restore toolbars to their original state in the Preferences dialog; however, please note that if toolbars are restored using this option, any custom configurations that you have created will be discarded. See [Reset Options Panel on page 86](#).

Creating Custom Toolbar Configurations

If you extensively edit your toolbars, consider creating one or more custom Toolbar Configurations so that your changes can be backed up as well as transferred to a different computer if you wish.

To create a custom configuration

1. Go to the CONFIGURATIONS panel of the Toolbar Customization dialog. See [Configurations Panel on page 97](#).
2. Select a configuration similar to the one you want to create and click **Copy**.
3. Give the new configuration a short, unique name. It will be saved in the Home Designer Pro 2022 Toolbars folder. See [Home Designer Pro Data on page 33](#).
4. When you click OK, the new configuration will appear in the list, and it will be active.
5. On the TOOLBARS panel, select each of the different **View Types** to see the toolbars active in each and confirm that they suit your needs.
6. You can now move toolbars, add or remove buttons, and add or remove toolbars to meet your requirements.
7. When you are satisfied with your new Toolbar Configuration, click **Close**.



It is a good idea to back up your custom Toolbar Configurations files. See [Home Designer Pro Data on page 33](#).

CUSTOM CONFIGURATION BUTTONS

By default, new Toolbar Configurations display a default configuration  button; however, if you want you can make your own button icon for your custom Toolbar Configuration.

Create a **.bmp** file with the same name as the configuration and save it in the Toolbars folder. To see an example, look at the Default **.bmp** file in the Home Designer Pro Toolbars folder, which corresponds to the Default Toolbar configuration. See [Home Designer Pro Data on page 33](#).

- Toolbar button bitmaps must be 20 x 20 pixels in size.
- The color (R:192, G:192, B:192) maps to the system 3D face color.
- The color (R:128, G:128, B:128) maps to the system 3D Shadow color.
- The color (R:223, G:223, B:223) maps to the system 3D light color.

IMPORTING CUSTOM CONFIGURATIONS

Toolbar Configurations can be imported into the program, allowing you to transfer custom configurations between computers as well as add backed up configurations to new installations.

To import a custom configuration

1. Go to the Configurations tab of the Toolbar Customization dialog.
2. Click **Add**.
3. Browse to the location of the toolbar you want to import.
4. Click **Open**. If the **.toolbar** file is not in the Home Designer Pro 2022 Toolbars folder, a copy of the file will be created there.

Toolbar Customization Dialog



Select **Tools> Toolbars and Hotkeys> Customize Toolbars** to open the Toolbar Customization dialog. You can also right-click in an empty space in any toolbar and select **Customize Toolbars** from the contextual menu.

In the Toolbar Customization dialog, you can:

- Add and remove buttons from toolbars.
- Specify which toolbars display in different view types.
- Select the active Toolbar Configuration.

The Toolbar Customization Specification dialog has the following panels:

TOOLS PANEL

From the TOOLS panel, you can add or remove buttons from your toolbars, as well as create new toolbars.

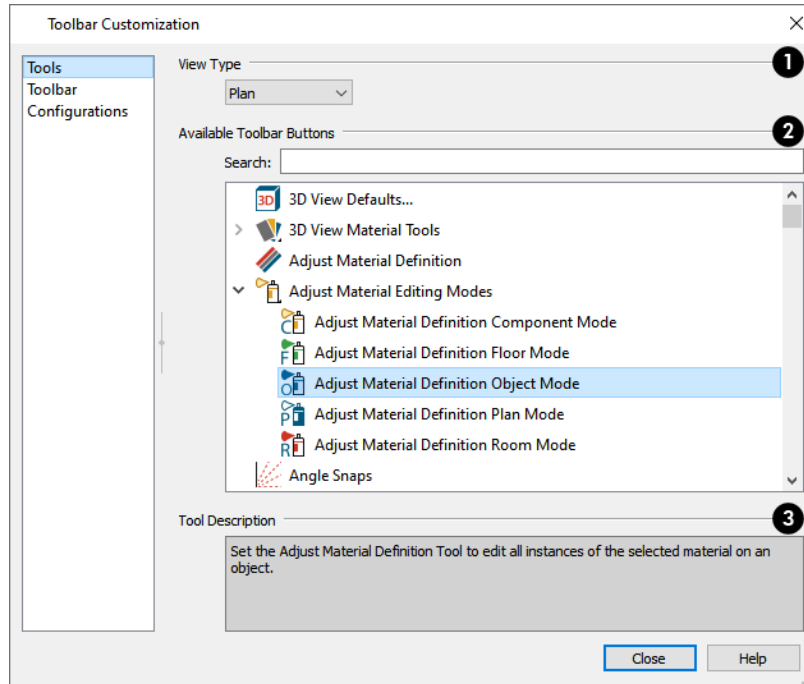

1 View Type

Select the **View Type** that you would like to add toolbar buttons to. When the dialog is first opened, the selected View Type is that of the current view. If you select a different View Type, the toolbars associated with it will display behind the dialog for reference until you click the **Done** button.

2 Available Toolbar Buttons

The **Available Toolbar Buttons** display in a list that can be searched or browsed.

- Type a keyword or the name of a tool in the **Search** field. As you type, only buttons that match your search will display.
When nothing is typed in this field, all buttons will display in the list.
If a child tool matches your search, its parent will display in the search results. Click the arrow next to the parent's name to see the child tools.
- The Available Toolbar Buttons list can be browsed using the scrollbar to the right.
- Click on a button in the list to display a description of that tool, below.
- Parent tools have an arrow to the right of their button icon in the list. Click on this arrow to display the child tools below the parent. See *Toolbar Arrangement on page 90*.

If you do not see a particular button in the list, it may be the child of a parent tool.

3 Tool Description

When a button is selected in the list above, a description of it displays here.

TOOLBAR PANEL

The TOOLBAR panel allows you to manage the use of individual toolbars.

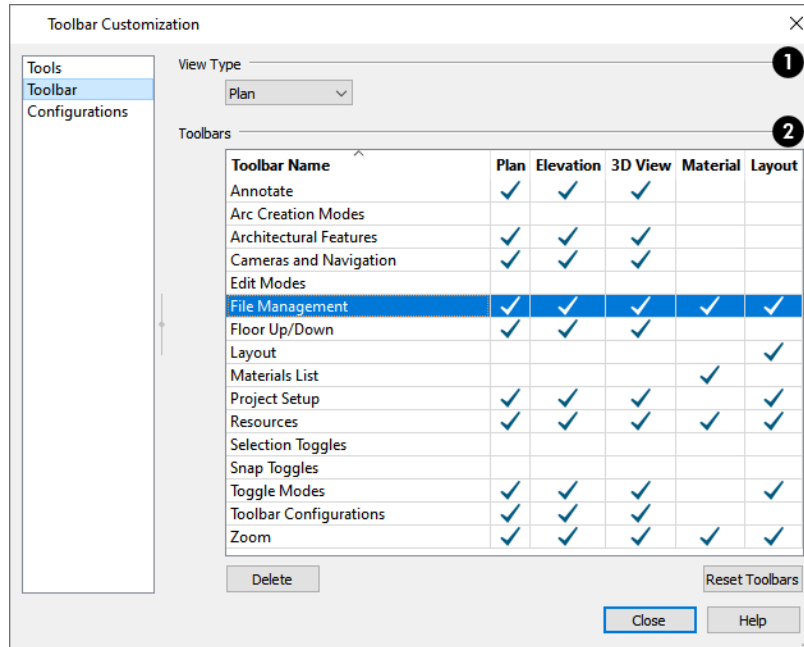

1 View Type

When this dialog is first opened, the selected **View Type** is that of the current view. If you select a different View Type, the toolbars associated with it will display behind the dialog for reference until you click the **Done** button.

2 Toolbars

The **Toolbars** table displays the names of all available toolbars, along with the View Types in which they are in use.

- Select a toolbar by clicking on its name.
- Click to place a check mark in a column to add the selected toolbar to that View Type; click on check mark to remove it.
- Double-click on a toolbar in the Toolbar Name column to rename it. Toolbar names must be unique.
- Click **Delete** to remove the selected toolbar from the list. A deleted toolbar is no longer available in any View Type.
- Click **Reset Toolbars** to restore all the toolbars to their original configuration. See *Restoring Toolbars on page 94*.

 Clicking the Reset Toolbars button removes all changes that you may have made to all installed Toolbar Configurations.

CONFIGURATIONS PANEL

The CONFIGURATIONS panel allows you to add, remove, and switch between Toolbar Configurations. See *Toolbar Configurations on page 91*.

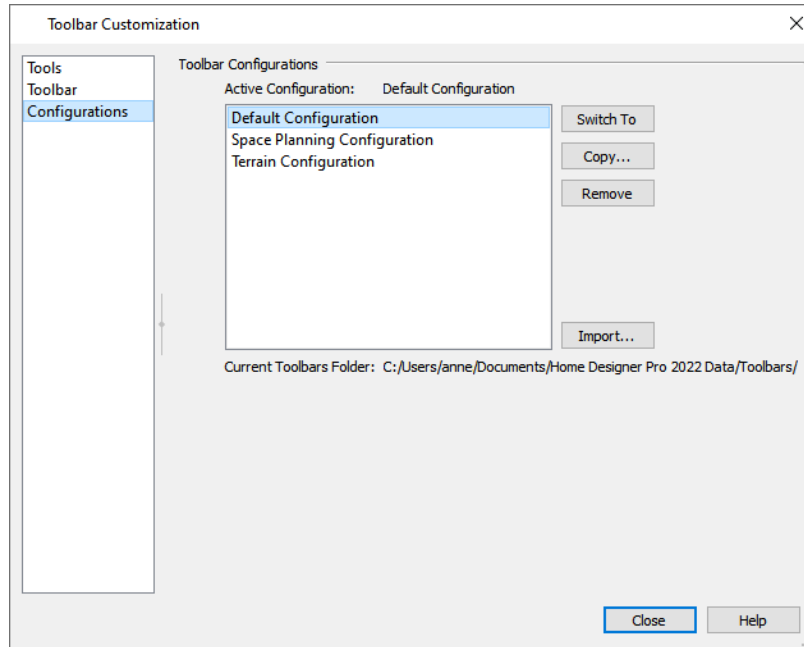



A list of Toolbar Configurations displays here. Select a configuration before clicking the **Remove**, **Copy**, or **Switch To** buttons.

- Click **Switch To** to switch to the selected Toolbar Configuration, making it active. See *To switch toolbar configurations on page 91*.
- Click **Copy** to create a copy of the selected Toolbar Configuration.
- Click **Remove** to remove the selected Toolbar Configuration. This removes the configuration from the list but does not delete the configuration file permanently. If only one configuration is listed, it cannot be deleted.
- The location of the **Current Toolbars Folder** displays below. See *Home Designer Pro Data on page 33*.

Hotkeys

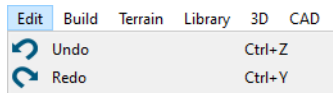
Many Home Designer tools have a keyboard shortcut, or hotkey, associated with them. If such a hotkey exists, it will display to the right of the tool’s name in the menu.



To use a hotkey, simply press the appropriate key or combination of keys on your keyboard instead of selecting the menu item or clicking the toolbar button. For example, press the Ctrl and Z keys at the same time to perform an **Undo** .

Note: If a key or key combination is in use as a system hotkey, it cannot be used as a program hotkey.

CREATE HOTKEY LIST

A list of the hotkeys available to the current program user can be saved in **.html** or **.xhtml** format.

Select **Tools> Toolbars and Hotkeys> Create Hotkey List** to open the Save Hotkey List File dialog, a standard Save dialog, and create a hotkey list that can then be opened in a web browser window and printed, if you wish.

Gamepad Settings Dialog



The Gamepad Settings dialog allows you to specify thumbstick behavior in Home Designer. Select **Tools> Customize Gamepad** to open this dialog. See [Gamepads on page 750](#).

You can also open this dialog by clicking the Gamepad Settings button, which you can add to your toolbars. See [To add a button to a toolbar on page 92](#).

You can also specify whether navigation is centered about the location of the camera or its focal point in the Preferences dialog. See [Render Panel on page 85](#).

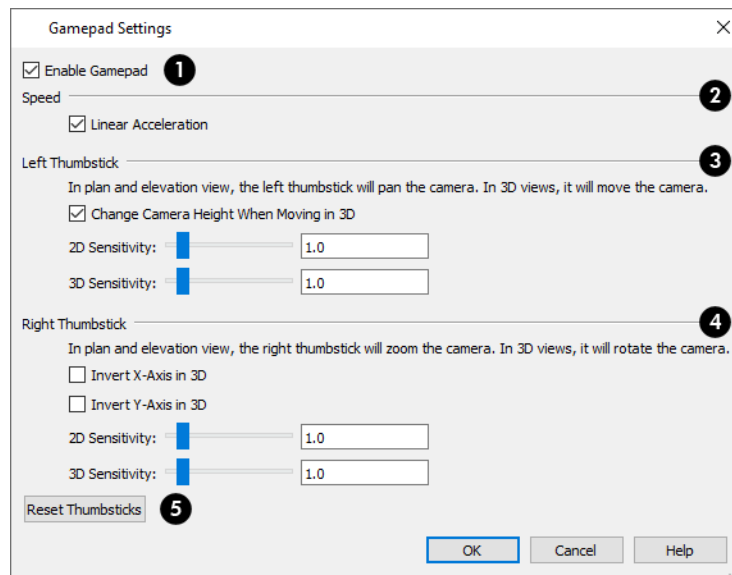

1 Enable Gamepad

Check **Enable Gamepad** to allow Home Designer to recognize a gamepad on your system and enable the other settings in this dialog.

2 Speed

When **Linear Acceleration** is checked, camera acceleration is always directly proportional to the amount the thumbstick is pushed. When unchecked, acceleration is increased on a curve, allowing more precision on the low end, and more speed on the high end.

3 Left Thumbstick

Specify the behavior of the **Left Thumbstick** in 2D and 3D views.

- When **Change Camera Height When Moving in 3D**, the left thumbstick can be used to change the camera height in 3D. Uncheck this to maintain a consistent camera height instead.
- Use the slider bar or text field to specify the **2D Sensitivity**, which controls how quickly the view pans in plan and elevation views.
- Use the slider bar or text field to specify the **3D Sensitivity**, which controls how quickly the camera moves in 3D views.

4 Right Thumbstick

Specify the behavior of the **Right Thumbstick** in 2D and 3D views.

- When **Invert X-Axis in 3D** is unchecked, pushing the right thumbstick to the left rotates the camera to the left. When checked, pushing this thumbstick to the left rotates the camera to the right.
- When **Invert Y-Axis in 3D** is unchecked, pushing the right thumbstick to the up rotates the camera upward. When checked, pushing the thumbstick up rotates the camera downward.
- Use the slider bar or text field to specify the **2D Sensitivity**, which controls how quickly the view zooms in plan and elevation views.
- Use the slider bar or text field to specify the **3D Sensitivity**, which controls how quickly the camera rotates in 3D views.

5 Reset Thumbsticks

Click the **Reset Thumbsticks** button to restore the default Left and Right Thumbsticks settings.

Window and View Tools

Chapter 6

The View and Window Tools let you control how views of your drawing are shown on screen, as well as toggle useful drawing aides on and off.

By default, Pro uses a tabbed document interface. The name of the file and the type of view displays at the top of each view window in its title bar. If the view is saved, its name also displays.

TOPICS

View Windows	102
Plan Views	102
Working in Multiple Views	103
View Tools	105
Zoom Tools	106
Fill Window	107
Panning the Display	107
Closing Views and Files	108

View Windows

In Home Designer Pro, there are several different types of views:

- *Plan Views, see page 102*
- *3D Views, see page 735*
- *Cross Section/Elevation Views, see page 741*
- *Materials Lists, see page 904*
- *Layout, see page 924*

Each view displays in a view window. While multiple views can be open and display on screen, only one view window can be active at any given time. See *Working in Multiple Views on page 103*.

- Plan, 3D, and cross section/elevation views are found in plan files only. Each view window can show the model from a different perspective and display a unique set of information about it, making them useful for a variety of drawing tasks and print requirements.
- Materials Lists are found in plan files only and contain a list of objects found in the model along with their components and information like floor level and counts.
- Each layout file is composed of a single sheet in one view window.

You can specify that any camera, cross section/elevation view, or Materials List be saved. See *Saving 3D Views on page 759*.

When a view is saved, all of its attributes are retained, including the:

- Floor level
- Extents of the view
- Color toggle

VIEW SPECIFICATION DIALOGS

These view types have a specification dialog that allows you to various aspects of its content:

- *Camera Specification Dialogs, see page 760*
- *Cross Section/Elevation Specification Dialogs, see page 765*
- *Materials List Specification Dialog, see page 909*

Plan Views

Plan view is where most drawing and editing is done, and when you open a new plan file, a plan view is active. When an existing plan file is opened, the floor level, view extents, and Color toggle setting that were in use in the active plan view the last time the plan was saved will all be used.

You can create additional plan views for use during the current program session: select **Tools> New Plan View** . Each plan view that you create can show a different floor and have different view extents and Color setting.

NEW PLAN VIEW



To create a new plan view, select **Tools> New Plan View**. An identical copy of the current plan view is created and will become the active view.

ROTATE PLAN VIEW



To rotate everything in a plan view, including all objects on all floors, the Snap and Reference Grids, the plan's Cartesian coordinates, and the drawing sheet, select **Tools> Rotate Plan View** to open the Rotate Plan View dialog. See [3D Drafting on page 11](#).

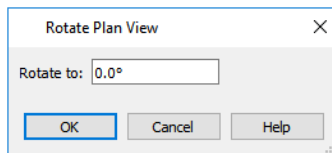

Enter the degrees to rotate the plan view to using decimal units with either positive or negative values. The degrees rotated displays in $\pm 180^\circ$ format. For example, if you enter 270° , it displays as -90° when the dialog is reopened.

Rotate Plan View  rotates a plan relative to its original orientation. For example, entering 90° twice results in a rotation of 90° , not 180° .

Text objects rotate with the plan unless you uncheck **Rotate with Plan** in the Text Specification dialog for each object. See [Rich Text Specification Dialog on page 342](#).

 The Rotate Plan View tool does not rotate objects; it literally rotates only your view of those objects. As a result, it does not alter the orientation of the plan in layout views or on the printed page.

REVERSE PLAN



The **Reverse Plan** tool is a quick way to mirror a plan so that everything on all floors of the entire plan is swapped left to right.

Select **Tools> Reverse Plan** to reflect an entire plan right to left, as though it were flipped about a vertical line.

Reversing a plan rebuilds the entire model and affects views sent to layout.

Working in Multiple Views

Although only one layout file can be open at a time, there is no limit to the number of plan files that can be open, nor is there a limit to the number of view windows that can be open. The name of the file and the type of view is stated at the top of each view window in its title bar as well as in its tab. If the view is saved, its name displays instead of the view type.

By default, Pro uses a tabbed document interface, which means that when more than one view window is open in the program window, each open window will have a tab that displays in a row above the currently active view.

- Each tab states the name of the file, the view type, and the view's name.
- Each tab features an icon indicating its type of view.
- Click on a tab to make it the active view.
- If there is not enough room in the program window to display all tabs, left and right arrow buttons allow you to scroll

through the tabs.

- Tabs can be reordered by clicking and dragging.

There is no limit to the number of 3D view windows that you can have open at a given time; bear in mind, though, that each window demands use of your computer's resources and that you may see poor performance if too many views are open. See [3D Views on page 735](#).

There are several ways to close a view window. See [Closing Views and Files on page 108](#).

TILING VIEWS



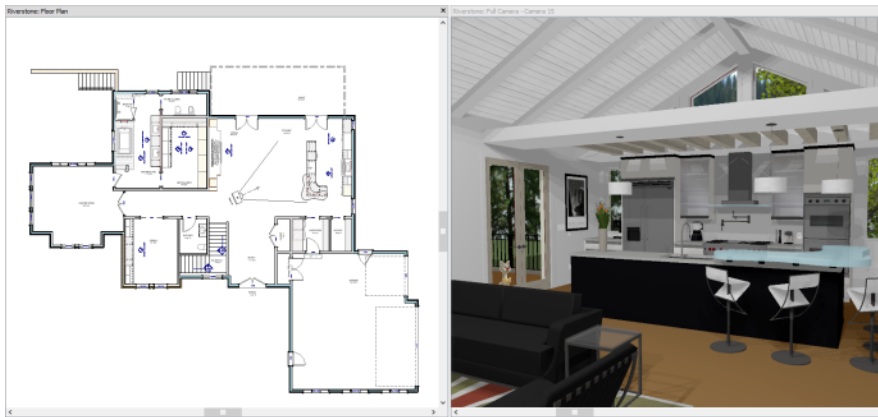

As an alternative to tabbed views, windows can instead be tiled. Tiling allows you to display multiple views in a single Pro window so you can see the results of changes in plan view in 3D or vice versa. It can also be useful for copying objects from one plan to another.



A plan view and camera view Tiled Vertically

There are several ways to create tiled views:

- Click and drag a view window's title bar or tab into the part of the drawing area that you would like it to be. When a highlighted space is created, release the mouse button.
- Select **Window > Tile Horizontally**  to display views in a horizontal orientation, one above the other.
- Select **Window > Tile Vertically**  or press Shift + F6 on the keyboard to display views in a vertical, side by side, orientation.

Views are tiled left to right or top to bottom in the order in which they were last active: the most recent view is on the left or at the top, while least recent is on the right or on the bottom.





- To activate a view, click on its title bar or anywhere in the view window. Note that any changes you make in the active window are reflected in other views as well.
- To end window tiling, select **Window > Tab Windows**. You can also end tiling by double-clicking on the title bar of the program window.

MULTIPLE PROGRAM WINDOWS

To create a second program window, click and drag the title bar or tab of a view window completely out of the current program window: for example, onto a second monitor. A second Pro program window will be created with its own menu and toolbars.

SWAPPING VIEWS

There are a number of ways to switch between open view windows:

- Click on a view window's tab.
- Select **Window> Swap Views**  or press F7 to switch between the two most recent views.
- The **Swap Views**  button toggles between the current view and the view that was current before it.
- Select **Window> Select Next Tab**  or **Window> Select Previous Tab**  to cycle through all open views in the order you prefer.
- In Windows, press the Ctrl + Tab (Next Window) or Ctrl + Shift + Tab (Previous Window) keys to cycle through all open views.
- On a Mac, press the Ctrl + } (Next Window) or Ctrl + Shift + { (Previous Window) keys to cycle through all open views.
- A list of all the views currently open is located at the bottom of the Window menu. Each view is identified by its name and what type of view it is. A check mark is beside the view that is currently active. Select one to go directly to that view.

If more than eight view windows are open, **More Windows** will be the last item in the Window menu. Select this option to open the Select Window dialog:

Select the name of a view in the list and click **OK** to make it the active view.

Note: The Window Menu Tools parent button can be added to the toolbars. See [Toolbar Customization Dialog on page 95](#).

View Tools

The **View Tools** allow you to open and close the program's side windows, as well as toggle a variety of references and drawing aides. Select the **View** menu to access these tools. You can also add the **View Tools** parent button to your toolbars. See [Adding and Removing Buttons on page 92](#).



Refresh Display redraws the current window to clean up extra lines, show missing items, and correct random on-screen effects caused by changes to the model. See [Refresh Display on page 129](#).



Library Browser opens and closes the Library Browser side window. See [The Library on page 668](#).



Tool Palette opens and closes the Tool Palette, which will display related tools. See [Child Tool Palette on page 90](#).



Status Bar displays or suppresses the Status Bar at the bottom of the program window. See [The Status Bar on page 23](#).



Scrollbars displays and suppresses scrollbars on view windows. See [View Windows on page 16](#).









Toolbars displays and hides the program's toolbars. See [Toolbars and Hotkeys on page 89](#).



Color toggles the display of color in the current view. See [Color On/Off on page 129](#).



Crosshairs toggles the use of the blue crosshairs centered on the mouse pointer in most views.

-  **Reference Grid** toggles the display of the Reference Grid in all views in the current plan or layout file. See [Grid Snaps on page 115](#).
-  **Temporary Dimensions** toggles the use of Temporary Dimensions when objects are selected. See [Temporary Dimensions on page 325](#).
-  **Arc Centers and Ends** toggles the display of Arc Centers and Ends in the current view. See [Arc Centers and Ends on page 151](#).
-  **Line Weights** toggles the display of Line Weights in all views in which lines are drawn. See [Line Weights on page 947](#).
-  **Drawing Sheet** toggles the display of the drawing sheet. See [Print Preview on page 947](#).
-  **Watermarks** toggles the display of the current plan or layout file's watermark. See [Watermarks on page 953](#).







Zoom Tools

 **Zoom** is used to magnify any given area on the plan or 3D view. Select **Window > Zoom**, then click and drag a marquee around an area on screen. When you release the mouse, the selected area expands to fill the screen.

Note that in 3D views, using **Zoom** does not reposition the camera. This can lead to inconsistencies between a camera's position and what is actually shown in the view if other methods of zooming are used later. See [Navigating in Camera Views on page 749](#).

When the zoom is complete, whatever tool was active prior to selecting the **Zoom** tool automatically becomes active again. If another zoom is needed, click the **Zoom** tool again.

These additional commands are also found in the **Window** menu:

-  **Zoom In** - Click to zoom in towards the screen center by a factor of two.
-  **Zoom Out** - Click to zoom out from the screen center by a factor of two.
-  **Undo Zoom** - Reverse the last zoom or fill window operation. This option is also found in the contextual menu, as is the **Zoom** tool. See [Menus, Toolbars, and Hotkeys on page 17](#).
-  **Fill Window Selected Objects** - Fits all selected items on screen.
-  **Fill Window Building Only** - Fits all walls and railings on the current floor on screen.
-  **Fill Window** - Fits all visible items on screen. See [Fill Window on page 107](#).

Note: Undo and Redo do not affect zoom.

Zooming with the Mouse Wheel

 Use the mouse wheel to zoom in and out in all view windows. Scrolling the mouse wheel one click up or down zooms in or out, centering on the location of your pointer and changing the zoom by about 10%.

By default, zooming in 3D views changes the camera's position. See [Mouse Scroll Wheel and Trackpad on page 749](#).

Note: Depending on the configuration of your mouse, it may be necessary to hold down the Ctrl key while turning the mouse wheel.

Fill Window



In plan view or a cross section/elevation view, select **Window> Fill Window** or press the **F6** key to view nearly everything on screen that is visible, including the Reference Display. CAD Points are the only objects that are not included when Fill Window is used.

If you are zoomed in so that only a portion of the drawing displays on screen, selecting **Fill Window** zooms out so that the entire view fits on the screen. If you are zoomed out so that the entire drawing is smaller than the screen, selecting **Fill Window** zooms in until the drawing fills the screen.

When the drawing sheet is shown, **Fill Window** zooms to the sheet borders.

FILL WINDOW SELECTED OBJECTS



Window> Fill Window Selected Objects is similar to Fill Window, but zooms in or out so that the current selected object or objects fill the current window. See [Selecting Multiple Objects on page 143](#).

FILL WINDOW BUILDING ONLY



Window> Fill Window Building Only is similar to **Fill Window**, but zooms in or out to so that all walls, railings, and roof planes in the view fill the current window. These objects are included in the extents of the view even if their layers are turned off. Other objects are ignored.

IN 3D VIEWS

The **Fill Window** tools behave slightly differently in perspective and orthographic 3D views. In perspective views, the original zoom factor is restored, while in orthographic views the camera's Field of View is adjusted so that all surfaces in the 3D view are included.

Panning the Display

There are a number of ways to pan the display without changing the zoom factor.

USING THE ARROW KEYS

In plan view, the arrow keys on the keyboard work exactly like clicking the arrow buttons on the scrollbar. They shift the display according to the number of inches defined in the Plan Defaults dialog.

USING THE MOUSE

If you have a wheel mouse, you can pan the display by pressing the middle mouse button, or wheel, and moving the mouse in the direction you would like to pan. When the middle mouse button is held down, the pointer changes to a hand  icon.

In the Mac version of Pro, you can pan using the left mouse button and Option key.

Mouse drivers sometimes have other functions assigned to the wheel and buttons. These override the Pro setting.

USING A MAC TRACKPAD

In the Mac version of Pro, you can two finger drag to pan the display. See [Trackpads on page 14](#).

USING THE PAN WINDOW TOOL



The **Pan Window** tool works much like the mouse wheel method.

- Select **Window > Pan Window**. The pointer changes to a hand icon. Click and drag to pan the window. The program reverts to the previously active tool when you release the mouse button.
- Double-click the **Pan Window** tool and the command remains active.

USING THE SCROLLBARS

One method is to use the scrollbars on the right and bottom edges of the window. See [View Windows on page 16](#).



- Click the end arrow keys on the scrollbars to shift the display in 12" increments.
- The 12" increment is defined in the Plan Defaults dialog under **Inches Scrolled by Arrow Key**. See [General Plan Defaults Dialog on page 56](#).

Closing Views and Files

If a view is still needed, you can swap to a different view without closing it. If, however, a view is no longer needed, it can be closed. There are several ways to close a view window:

- Select **File > Close View** to close the active window.
- Press **Ctrl + W** or **Ctrl + F4** on the keyboard to close the active window.
- Click the **Close** button in the active view's title bar or in any view's tab.
- A tabbed view can be closed by clicking on its tab using the middle mouse button.
- Select **File > Close All 3D Views**  to close all currently open camera view windows instead of just the active window.
- Select **File > Close All Views** to close all currently open view windows instead of just the active window.

If a plan has only one view window open and you try to close it, the program will prompt you to save before closing if there are any unsaved changes. Edited cross section/elevation and saved plan views also prompt you to save before closing. See [Saving Plan and Layout Files on page 37](#).



Although the program warns you if you try to exit without saving, you should get in the habit of saving plan files before exiting.

Even if all view windows are closed, the program can still be open. See [Exiting Home Designer on page 45](#).

Creating Objects

Chapter 7

There are a wide variety of objects in Home Designer that you can use to create complete 3D models and working drawings. Although these objects are sometimes very different from one another, the methods used to create them are similar.

Once an object is created, it can be selected and edited to meet the requirements of your project. The editing characteristics common to most objects are described elsewhere. See *Editing Objects on page 136*.

TOPICS

Architectural vs CAD Objects	111
Defaults and Preferences	111
Snap Behaviors	112
Object Snaps	113
Angle Snaps	114
Grid Snaps	115
Creating Objects	115
Copying and Pasting Objects	117

Architectural vs CAD Objects

There are two broad categories of objects in Home Designer: architectural objects and CAD objects.

CAD objects such as lines, arcs, text, and dimensions are 2D objects that can be created and edited in plan view, cross section/elevation views, and on layout pages but do not display in 3D camera views and overviews. See *The CAD Drawing Tools on page 194*.

In contrast, architectural objects such as walls, cabinets, doors, windows, and stairs display in 2D and 3D views. Architectural objects can be created and edited in 2D and 3D views but not on layout pages.

Some architectural objects, such as custom countertops and slabs, have some behaviors in common with CAD objects and are referred to as CAD-based.

Defaults and Preferences

The ways that objects in the program behave as they are created and edited are affected by a number of default and preference settings. See *Preferences and Default Settings on page 53*.



It is a good idea to be familiar with these options and how they affect both drawing and editing in the program.

SNAP SETTINGS

✚ Select **Edit> Snap Settings** to access the three categories of Snap Settings that determine how objects snap to one another and whether they snap to allowed angles or to points on a grid, as well as object bumping and pushing behaviors.

The available Snap Settings are:



Object Snaps - enables snapping to objects. See *Object Snaps on page 113*.



Angle Snaps - enables snapping at Allowed Angles. See *Angle Snaps on page 114*.



Grid Snaps - enables snapping to the Snap Grid. See *Grid Snaps on page 115*.



Bumping/Pushing - enables bumping and pushing behaviors. See *Bumping/Pushing on page 166*.

EDIT BEHAVIORS

✚ Select **Edit> Edit Behaviors** to access the six global edit behavior modes that determine how dragging the edit handles with the left mouse button affects a selected object and may also affect how objects are drawn.

The available Edit Behaviors are:



Default - provides the most commonly used editing options. See *Default on page 137*.



Alternate - provides an alternative to the Default behaviors that may be more useful in some situations. See *Alternate on page 138*.



Resize - scales an object as you drag a corner handle. See *Resize on page 138*.



Concentric - allows you to resize objects so that the distance moved by each edge is the same as all other edges. See [Concentric on page 139](#).



Fillet - allows you to add a fillet at any corner of an object. See [Fillet on page 140](#).

CONNECT CAD SEGMENTS

Select **Edit> Edit Behaviors> Connect CAD Segments** to toggle the ability to edit the individual segments of polyline-based objects and connected walls. It also affects the ability to snap line- and arc-based objects together as they are drawn to form a polyline. See [Disconnect Edges on page 142](#).

ROTATE/RESIZE ABOUT



Objects can be rotated or resized about either their own centers or the Current CAD point. See [Rotate/Resize About on page 176](#).

Specify which behavior is used by selecting **Edit> Edit Behaviors> Rotate/Resize About Current Point**  or in the Preferences dialog. See [Behaviors Panel on page 76](#).

ARC CREATION MODES



Select **Edit> Arc Creation Modes** to access the five Arc Creation Modes that control how arcs and curved walls are drawn.

The available Arc Creation Modes are:



Free Form Arc - mode allows you to define an arc by clicking and dragging along the desired path. See [Free Form Arc on page 206](#).



Arc About Center - mode allows you to draw an arc by defining the center and then the start and end points. See [Arc About Center on page 207](#).

Snap Behaviors

There are three categories of snap behavior in Home Designer that affect how objects are created and how they can be edited:



Object Snaps, which snap CAD and architectural objects to other objects. See [Object Snaps on page 113](#).



Angle Snaps, which snap objects at specific angles. See [Angle Snaps on page 114](#).



Grid Snaps, which snap objects to points on a grid. See [Grid Snaps on page 115](#).

Snap behaviors can be controlled in the Preferences dialog and in the Plan or Layout Defaults dialogs. See [Snap Properties Panel on page 78](#) and [General Plan Defaults Dialog on page 56](#).

You can select **Edit> Snap Settings**  to quickly turn Object, Angle and Grid Snaps on or off.

To temporarily disable Snap Behaviors and other move restrictions, press the Ctrl key while dragging an edit handle. See [Moving Objects on page 165](#).

HOTKEYS

You can also temporarily enable individual Snap Behaviors during a mouse editing operation using hotkeys. This can be helpful if you wish to use one particular type of snap behavior when you begin an operation, but a different behavior when you end it.

The Snap Behavior hotkeys are listed on the right side of the **Edit> Snap Settings**  submenu.

See *Hotkeys on page 98*.

To use snap behavior hotkeys

1. Select **Edit> Snap Settings**  and toggle off the snap behavior category that you wish to control using hotkeys.
2. Select a tool that you wish to draw with or an object you wish to edit.
3. Begin drawing or editing and hold down the left mouse button without releasing.
4. Press and hold the appropriate key on your keyboard to enable the snap behavior associated with it.
5. When you are finished using the snap behavior, release the hotkey but continue holding down your left mouse button.
6. If you wish, you can press and hold a different hotkey on your keyboard and continue the drawing or editing operation.
7. When you are finished, release the left mouse button.

Object Snaps

 **Object Snaps** allow you to position objects precisely relative to each other; for example, to position lines so that their endpoints meet or roof plane edges so that they are collinear.

Object Snaps can be turned on or off by selecting **Edit> Snap Settings> Object Snaps** , by clicking the toggle button, or in the Preferences dialog. See *Snap Properties Panel on page 78*.

Object Snaps are indicated visually as you create or edit objects. To remove any object snap indicators that are visible on screen, press the 1 (one) key. As you continue drawing or editing, new indicators may appear.

With the exception of **On Object**  snaps, Object Snaps have priority over all other types of snapping in Home Designer.

Bumping/Pushing  overrides Object Snaps, however. See *Bumping/Pushing on page 166*.

OBJECT SNAP LOCATIONS

There are many locations on an object that other objects can snap to. Each type of object snap can be toggled by selecting **Edit> Snap Settings**  or in the Preferences dialog. See *Snap Properties Panel on page 78*.

Regardless of which Object Snaps are active, when multiple objects are selected the selection set's only snap point is its midpoint.

EXTENSION SNAPS

Extension snaps allow you to snap to a point that is not actually on an object. Instead, these snaps locate points that are either collinear to the end of a wall or orthogonal (at a 90° angle) to it.

Extension snaps function when you are drawing or editing walls and create a “sticky point” and blue extension line where the wall being drawn reaches a point that is either collinear or orthogonal to another wall’s end point. See [Creating Walls on page 236](#).

OBJECT SNAPS HOTKEYS

- Hold down the “S” key to temporarily disable Object Snaps.

Angle Snaps

 It is often important that objects be drawn at exact angles. This can be accomplished using **Angle Snaps**. Angle Snaps allow you to draw walls, lines, and other objects at specified Allowed Angles. Angle Snaps also affect the way objects rotate, the radius of arcs, and a variety of other operations.

You can specify whether Angle Snaps use 15° increments or 7.5° increments plus any additional Allowed Angles that you may specify. See [General Plan Defaults Dialog on page 56](#).

Angle Snaps can be turned on or off by selecting **Edit> Snap Settings> Angle Snaps** , by clicking the toggle button, or in the Preferences dialog. See [Snap Properties Panel on page 78](#).

Because drawing at regular angles is extremely important, when Angle Snaps are disabled, the Angle Snaps  icon will display near and follow the pointer. See [Pointer Icons on page 15](#).

ANGLE SNAP SETTINGS

You can change Allowed Angle settings for Angle Snaps in the Plan Defaults or Layout Defaults dialog. See [General Plan Defaults Dialog on page 56](#).

Specify **15 Degree** or **7 ½ Degree** angle snaps. You can also specify **Additional Angles**.

ANGLE SNAPS AND OBJECT SNAPS

Angle Snaps have a higher priority than Grid Snaps and **On Object Snaps** , but a lower priority to all other Object Snaps. If a valid Object Snap exists, the program uses that instead of an Angle Snap.

 Walls are an exception to this snapping prioritization. When walls are drawn or edited, Angle Snaps take higher priority than Object Snaps. See [Creating Walls on page 236](#).

Sometimes both Angle Snaps and Object Snaps apply. For example, suppose a CAD line is drawn at 15° using Angle Snaps and another line is approached. You can draw the new line at 15° using **Intersection Snaps**  to snap to a point on the existing line.

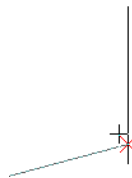

Use Object Snapping and Angle Snapping to draw a line at a 15° angle that intersects and existing line

Now suppose that we don't want the new line to end on the existing line. Hold down the “S” key to temporarily disable Object Snaps, allowing only Angle Snaps.

Grid Snaps



Grid Snaps allow you to snap objects to points on an on-screen grid as they are created, moved, and resized. See [Moving Objects on page 165](#) and [Resizing Objects on page 171](#).

It is recommended that you draw and position the exterior walls of your plan with **Grid Snaps** enabled. Once these walls are in place, you may choose to turn Grid Snaps off to finish the rest of the drawing.

Grid Snaps are turned on and off by selecting **Edit> Snap Settings> Grid Snaps**, by clicking the toggle button, or in the Plan or Layout Defaults dialog.

REFERENCE GRID



In addition to the Snap Grid, the **Reference Grid** is provided to give you a visual sense of scale. It is useful for zooming in and out, or for general layout guidelines, but is not used for snapping. The Reference Grid can be toggled on and off by selecting **View> Reference Grid**. See [View Tools on page 105](#).

The appearance and size of the Snap and Reference Grids can be controlled in the Plan Defaults and Layout Defaults dialogs. See [General Plan Defaults Dialog on page 56](#).

GRID SNAPS AND ANGLE SNAPS

Of the three snap behaviors, Grid Snaps have the lowest priority and are overridden by Angle Snaps and Object Snaps.

When Grid snaps and Angle Snaps are both enabled, objects are drawn and edited using Polar Coordinates. For example, if the grid **Snap Unit** is set to 12" (1 foot), drawing a new wall at an Allowed Angle snaps the wall length to 0", 12", 24", and so on.



To draw a line or wall at an Allowed Angle but with unrestricted length, disable Grid Snaps and leave Angle Snaps on.

Creating Objects

In Home Designer Pro, there are four ways to add new objects to your drawing: by clicking to place an object, by clicking and dragging to draw an object, by entering coordinates, or by importing custom symbols, CAD drawings, pictures or metafiles.

If you create an object using any of these methods and the layer it will go on is either locked or turned off, the program will ask you if you want to unlock or display the layer. Objects can be created on layers that are not set to display, but they cannot be created on locked layers. See [Object Creation and Layers on page 117](#).

While the size of the drawing area in Home Designer is limited only by the resources on your computer, it is best to begin your drawing near the origin, 0,0. The current position of your mouse pointer displays in the Status Bar at the bottom of the program window. See [3D Drafting on page 11](#).

CLICK-TO-CREATE

Many objects, including doors and windows, cabinets, library symbols, text, pictures, and images are created by clicking. Select a library object or one of the drawing tools mentioned above, then click in the drawing area to place the object at that



location.

Continue clicking to place the selected object until another tool is selected.

If you click at a location where there is not enough room for the object to be placed, one of two things may happen:

- Some objects, notably cabinets, doors, and windows, will resize smaller to fit into the space.
- Most objects cannot resize in this manner, so the program will present a warning message indicating that there is not sufficient space at the current location.

When most drawing tools are active or library symbols selected for placement, a preview outline follows your mouse pointer, indicating the size and shape of the object to be created. If your pointer is positioned at a location where the object cannot be placed, this preview outline will not display.

As you move the mouse pointer, the center point of the object's back edge will snap to active snap points when **Grid Snaps**  or **Object Snaps**  are enabled. See *Snap Behaviors on page 112*.

Many architectural objects can be created in plan view or any 3D view. In order to place a stand-alone, click-to-create object in 3D, it is necessary to click near a wall or within the Terrain Perimeter as these objects help orient the new object within the 3D space.

CLICKING AND DRAGGING

Other objects, including walls and railings, straight stairs, and CAD and CAD-based objects are created by clicking and dragging to define either a path or an enclosed area. Select a tool, then click and drag in the drawing area to draw an object between your start and end points.

Continue drawing the selected object until another tool is selected.

You can temporarily slow the movement of the mouse as you drag by holding down the Shift key on your keyboard.

You can cancel any click-and-drag drawing operation before it is completed by pressing the Esc key on your keyboard, or by pressing any two mouse buttons at the same time.

Polyline- and Spline-based objects can be created by snapping multiple Line-, Arc-, and/or Spline-based objects together. These objects will only snap together to form a polyline or spline if they are on the same layer and share identical attributes such as color, line style, and arrow specifications. See *Editing Objects on page 136*.

ENTERING COORDINATES

CAD lines, arcs and points can be created using the Input Line, Input Arc and Input Point dialogs. See *Input Point on page 196*, *Input Line on page 199*, or *Input Arc on page 207*.

AUTO REBUILD

A number of objects, notably foundations, roofs, and framing, can be automatically generated and rebuilt as changes are made to the model. Objects created in this manner can be edited just like other objects; however, the Auto Rebuild functionality will be disabled.

IMPORTING OBJECTS

Custom symbols, CAD drawings, pictures and metafiles can be imported into the program and placed in the drawing area with a click. See *Importing and Exporting on page 827* and *Pictures, Images, and Walkthroughs on page 794*.

CONVERTING OBJECTS

A variety of objects can be created by converting existing CAD objects and many CAD-based objects into another type of object. See [Converting Objects on page 179](#).

OBJECT CREATION AND LAYERS

When it is created, every object is placed on a layer which controls whether and how it displays. See [Layers on page 123](#).

If you try to create an object on a layer that is not set to display in the current view, the program will ask if you want to turn that layer on. See [Message Boxes on page 23](#).

- Click **Yes** to create the object and turn on its layer in the current view.
- Click **No** to create the object but leave its layer turned off in the current view.
- Click **Cancel** to not create the object and leave the layer turned off.

If you try to create an object on a layer that is locked, the program will prompt you to unlock the layer. If you choose to leave the layer locked, the object will not be created. See [Locking Layers on page 125](#).

Similarly, if you try to insert an object into another object that is on a locked layer, nothing will be created. See [Inserted Objects on page 687](#).

Copying and Pasting Objects

New objects can also be created by cutting, copying, and pasting existing objects, either individually or in groups. Objects can be copied from one floor to another, one view window to another, and one file to another. Because copying uses your system's clipboard, some objects can be pasted into other applications, as well.

 Objects created in an Imperial plan or layout should not be pasted into a metric file, or vice versa. See [Units of Measurement on page 34](#).

Objects cannot be pasted into any views that they cannot be created in normally. For example, CAD objects cannot be pasted into a 3D camera view or overview, while Architectural objects cannot be pasted onto a layout page.

Note: Terrain Perimeters can be copied and pasted, but will be pasted as a Standard Polyline which can then be converted into a Terrain Perimeter or other type of polyline. See [Convert Polyline on page 179](#).

There are a number of ways that objects can be cut, copied, and pasted:

CUT, COPY, AND PASTE

The Cut, Copy, and Paste tools allow you to copy a selection to the system clipboard and then paste it into a different view window, onto a different floor level, or even into a different application.



Select **Edit> Cut** or press **Ctrl + X** to remove the selected object(s) from the file and save them in the system clipboard so that the selection can be pasted in a different location in Home Designer or in another application, depending on the type of selection.



Select **Edit> Copy** or press **Ctrl + C** to save a copy of the selected object(s) to the system clipboard while maintaining the original(s). The selection can then be pasted in a different location in Home Designer or in another

application, depending on the type of selection.

 Select **Edit> Paste** or press **Ctrl + V** to enable Paste mode, then left- or right-click in the current view to paste the selected object(s) previously copied to the system clipboard at that location. If pasting from another application, click in the destination view in Home Designer first to make sure it is active.

To Cut, Copy, and Paste

1. Select an object or objects to copy, then:
 - Select **Edit> Cut** or press **Ctrl + X** to remove the original selection from the file and copy it to the system clipboard.
 - Select **Edit> Copy** or press **Ctrl + C** to copy the selection to the clipboard while retaining the original.
2. If you wish to paste the copy in a different view or program window, open that window and click in it to make it active.
3. Select **Edit> Paste** from the menu or press **Ctrl + V**.
4. When pasting in Home Designer, the mouse pointer will display the Copy/Paste  icon. Left- or right-click once to paste a copy of the object at that location.

If the new object(s) are pasted into Home Designer, they will be selected. Objects pasted in 3D views are selected on their top surfaces.

If the selection being pasted consists of text, it is placed in a Text object.

If the selection being pasted is an image, the Paste Image dialog opens.

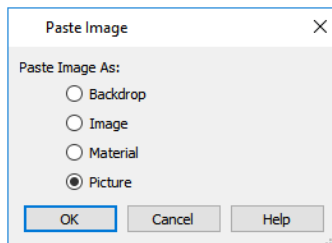

Specify how you would like to paste the selected image:

- Select **Backdrop** to add the image to a new 3D backdrop in the User Catalog in the library, where it will be selected. See [3D Backdrops on page 812](#).
- Select **Image** to add the image to an Image object in the User Catalog in the library, where it will be selected. See [Images on page 795](#).
- Select **Material** to add the image to a new material in the User Catalog in the library, where it will be selected. See [Creating Materials on page 721](#).
- Select **Picture** to display the picture in the current plan view. See [Pictures on page 801](#).

COPY/PASTE



 The **Copy/Paste** edit tool allows you to copy the selected object(s) to the system clipboard and immediately enable the Paste function so that a copy can be made in the current view. Edit handles and a variety of edit tools let you control the location, orientation, and size/shape of the pasted object(s).

To Copy/Paste by clicking

1. Select an object or objects to copy.
2. Click the **Copy/Paste**  edit button. The cursor displays the Copy/Paste $\uparrow\rightarrow\rightarrow$ icon.
3. Left- or right-click once to paste a copy of the selection at that point where you clicked.

The Copy/Paste edit tool can be used in combination with the original selection's edit handles to move, rotate, or reshape the copy relative to the original. The available edit handles will vary depending on the type and number of objects selected. See [Edit Handles on page 21](#).

To Copy/Paste by dragging

1. Select an object or objects to copy.
2. Click the **Copy/Paste**  edit button. The cursor displays the Copy/Paste $\uparrow\rightarrow\rightarrow$ icon.
3. Drag an edit handle:
 - Drag the Move edit handle to position the copy at a new location.
 - Drag a corner handle to create a copy in the same location as the original but with a different shape or size. The result depends on which **Edit Behavior**  you use. See [Defaults, Preferences, and Edit Behaviors on page 137](#).
 - Drag the Rotate handle to create a copy in the same location as the original, but rotated to a different angle.
4. You can resize or position the copy accurately with respect to the original by watching the moved distance in the Status Bar at the bottom of the screen.

The **Copy/Paste**  edit button activates Paste mode in which each available edit tool and handle makes a copy in addition to its primary function and seven new edit buttons display on the Edit Toolbar.



Click the **Sticky Mode** edit button to remain in the current mode and place multiple copies of the selected object (s). See [Sticky Mode on page 120](#), below.



Click the **Paste Hold Position** edit button create a copy of the selection at the same location as the original. See [Paste Hold Position on page 120](#), below.



Click the **Point to Point Move** edit button to make a copy of the selection at a specific location. See [Point to Point Move on page 167](#).



Click the **Center Object** edit button to make a copy of the selection and center it relative to another object. See [Center Object on page 169](#).







Click the **Reflect About Object** edit button to make a copy of the selection reflected about another object. See [Reflect About Object on page 178](#).



Click the **Main Edit Mode** edit button or press the Esc key to return to the selection's main edit toolbar.



To use Copy/Paste with other edit tools

1. Select the object(s) to be copied and click the **Copy/Paste**  edit button.
2. Notice that the options in the Edit Toolbar change and include several tools for moving and centering:
 - Click the **Point to Point Move**  edit button, then click at the start and end points to position the copy at a particular point.

- Click the **Center Object**  edit button, then mouse over the object you want to center the copy relative to and click once when the desired centering axis displays.
 - Click the **Reflect About Object**  edit button, then mouse over the object you want to reflect the copy about and click once when the desired reflection axis displays.
3. An exact copy of the selected object(s) is created and is positioned and oriented based on the actions performed using the second edit tool.

STICKY MODE

 Normally, after an action is performed using the edit tools or handles while in an edit mode such as Paste mode, you return to the Main Edit Mode. Click the **Sticky Mode** edit button to remain in Paste mode and continue pasting copies of the selected object(s).

To exit Paste mode and return to the main edit toolbar for the selected object, click the **Main Edit Mode**  edit button or press the Esc key on your keyboard. If you have not pasted a copy of the selected object and immediately click **Copy/Paste**  after returning to the Main Edit Mode, **Sticky Mode**  is still enabled.

 Sticky Mode is available when the Copy/Paste edit button is clicked.



PASTE HOLD POSITION

 Click the **Paste Hold Position** edit button to create a copy of the selected object(s) at the same location as the original. The copy remains selected so you can perform additional operations.

Because multiple walls, railing and fencing cannot share the same space, the **Paste Hold Position**  edit button is not available for these objects.

When copying between different floors or view windows, you can paste a copy at the same absolute position as the original selection using the **Paste Hold Position** command.

To use Paste Hold Position

1. Select the object(s) to be copied.
2. Click the **Copy/Paste**  edit button.
3. Switch to the desired floor or plan file and select **Edit> Paste> Paste Hold Position** .
4. A copy is placed at the same X, Y coordinates on the new floor or in the new plan as the original's position.

COPY AND PASTE IN PLACE

 Select **Edit> Copy and Paste in Place** to create a copy of the selected object(s) at the same location as the original. The copy remains selected so you can perform additional operations.

Because multiple walls, railings, and fencing cannot share the same space, the **Copy and Paste in Place** command is not available for these objects.

PASTE SPECIAL



The **Paste Special** tool allows you to choose a representation for the selection to be pasted.

Selections can be pasted as:

- Enhanced Windows Metafiles (EMF). See *Metafiles on page 804*.
- Device Independent Bitmaps (BMP). See *Importing Pictures on page 802*.
- Unformatted non-unicode text (TXT).
- File Name (a path to a file). Depending on the file type, it will be either opened or imported (if supported).
- Unformatted text (HTML). Pastes as text.
- Model Objects - Home Designer format, not compatible with other programs.

To use Paste Special

1. Select an object, image, text or file on your computer and copy it.
2. Switch to the desired Home Designer view window and select **Edit> Paste> Paste Special** .
3. In the Paste Special dialog, select the desired representation for the selection and click OK.
4. Click in the drawing area to place the copy at that location.

TRANSFORM/REPLICATE OBJECT

 Objects and groups of objects can be copied and pasted using the Transform Replicate Object dialog. See **...** *Transform/Replicate Object Dialog on page 180*.

Displaying Objects

Chapter 8

The way that objects display is an important in all stages of the design process. There are two primary ways that the display of objects is controlled: Drawing Groups and Layers.

TOPICS

Displaying Objects	<i>123</i>
Layers	<i>123</i>
Layer Attributes	<i>124</i>
Layer Display Options Dialog	<i>126</i>
Layer Sets	<i>127</i>
Drawing Groups	<i>128</i>
Display Toggles	<i>129</i>
Fill Styles	<i>130</i>
Select Color Dialog	<i>134</i>

Displaying Objects

There are two broad categories of objects in Home Designer: architectural objects and CAD objects. See *Architectural vs CAD Objects on page 111*.

CAD objects are two-dimensional and display only in the view in which they were drawn. Architectural objects, on the other hand, are 3D and are represented in 2D and 3D views in different ways.

LAYER SETTINGS

By default, CAD and CAD-based objects use the settings assigned to their layer: including line style, color, and weight. They can be assigned custom line attributes in their specification dialogs. See *Line and Text Styles on page 125*.

In plan view, architectural objects are represented much like CAD objects, using the attributes assigned to their layer. In addition, the edge lines of architectural objects in Vector Views also use these layer settings. See *Vector View on page 785*.

In addition, layers can be used to turn the display of objects on and off in different views. See *Layer Attributes on page 124*.

FILL STYLES

Closed CAD objects can also be assigned a fill style for their interior areas. Fill styles may be a solid color or a pattern, and can be specified as transparent. See *Fill Styles on page 130*.

Many architectural objects can also be assigned a fill style; however, it is only used in plan view. In 3D views, architectural objects are represented using surfaces that have materials assigned to them.

PATTERNS AND TEXTURES

The appearance of architectural objects in 3D views is determined by the materials applied to the objects' surfaces. See *Materials on page 711*.

Material patterns display in Technical Illustration and Vector Views, while textures display in other types of rendered views. See *Rendering Techniques on page 785*.

You can turn the display of patterns on or off in 3D views that use them by selecting **3D> Toggle Patterns** .

Layers

Layers are used to organize and manage the display of all objects in all views. A layer can be thought of as a transparency sheet with objects placed on it for viewing. Nearly all views use multiple layers, like a stack of transparencies put together to show different types of objects.

You can find out which layer an object is on by selecting the object and looking at the Status Bar. And, you can customize how each layer displays in a particular view in the Layer Display Options dialog. See *The Status Bar on page 23* and *Layer Display Options Dialog on page 126*.

Multiple layers are organized into Layer Sets, which allow you to control which objects display in different views. See *Layer Sets on page 127*.



Layer Attributes

The display of objects in different views is controlled by layer sets and layers in the Layer Display Options dialog. See [Layer Display Options Dialog on page 126](#).

IN-USE LAYERS

A layer is considered to be in use in the current plan or layout file if one or more objects are assigned to it; if it is selected in one or more defaults dialogs; or, if it is a system default layer for one or more drawing tools.

In the Layer Display Options dialog, the **Used** column identifies in use layers:

-  Indicates that one or more objects are assigned to the layer.
-  Indicates that there are no objects on the layer, but that it is specified in a defaults dialog.
-  Indicates that the layer is not used elsewhere, but is a system default layer.

Move your mouse pointer over an icon to display a tool tip summarizing where the layer is in use.

PRIMARY AND SECONDARY LAYERS

Every object is placed on a layer which controls whether it displays in a given view. This layer is referred to as the object's primary layer, and you can see its name in the Status Bar when the object is selected. See [The Status Bar on page 23](#).

In addition, some objects have secondary layers which may alter the appearance of objects on the primary layer, but do not control whether the objects display or not.

For example, the primary layer for base cabinets is "Cabinets, Base". In addition, base cabinets have a number of secondary layers that control the display of the countertop, face indicators, door opening indicators, module lines and labels.

Note: If an object's primary layer is turned off, information on its secondary layers will not display - even if those layers are turned on.

All layers with a check in the **Disp** column display when the current layer set is active. Objects that are not displayed cannot be seen or selected. If you try to place or draw an object on a layer that is hidden, the program asks if you want to turn the layer on.

↓









Name	Used	Disp	Lock
Architectural Blocks	S	✓	
Architectural Blocks, Labels	S		
Audio/Video	S	✓	
Auto Dormers	🔒	✓	
Cabinets, Base	🔒	✓	

Some objects are designed to be inserted into another object rather than standing alone. If the display of an object that contains an inserted object is turned off, the inserted object's display will be turned off, as well. For example, if the display of a wall is turned off, any doors and windows in that wall will not display either. See [Inserted Objects on page 687](#).

Only displayed objects are included when DXF/DWG and EMF files are exported, and only displayed objects print.

LINE AND TEXT STYLES

A layer’s **Color**, **Weight**, **Line Style** and **Text Style** attributes determine how an object on that layer appears in plan view and in 3D views using the Vector View rendering technique.

Color	Weight	Line Style	Text Style
	25		Default Text Style
	25		Default Text Style
	10		Default Label Style
	25		Default Text Style

Many objects, including all CAD and text objects, allow you to override these settings for an individual instance without changing its layer. See [Line Style Panel on page 204](#).

EDGE AND PATTERN LINES











In 3D Vector Views, objects are represented using lines to define their surface edges. By default, Edge Lines use the attributes set for the object’s layer, as described above.

Some CAD-based architectural objects, such as Slabs, have line style settings in their specification dialogs; however, these specifications are not used unless **Use Object Settings** is checked in the 3D View Defaults dialog. See [3D View Defaults Dialog on page 739](#).

In addition, a material applied to an object surface may have a pattern associated with it. Pattern line color, weight, and spacing is set in the Define Material dialog. See [Pattern Panel on page 727](#).

LOCKING LAYERS

Objects on layers with a lock icon in the **Lock** column cannot be selected by the user.

Name	Used	Disp	Lock
Roofs, Gutters		<input type="checkbox"/>	
Roofs, Labels		<input type="checkbox"/>	<input type="checkbox"/>
Roofs, Openings		<input checked="" type="checkbox"/>	<input type="checkbox"/>
Roofs, Overhang Area		<input type="checkbox"/>	
Roofs, Ridge Caps		<input type="checkbox"/>	
Roofs, Trim		<input type="checkbox"/>	

New objects cannot be drawn on a locked layer, either. If you lock a layer and then attempt to draw a new object on that layer, a message box will ask you to unlock the layer.

Layers with objects that you need to see as a reference while working, but not select, are good candidates for locking. For example:

- Locking the “Rooms” layer can make it easier to select objects located inside of rooms.
- Locking the “Roof Planes” layer can make it easier to select objects located under the eaves.

Another use for locking layers is to protect them from editing in plans opened by clients or others in select Home Designer programs. See [Opening Chief Architect Plans in Home Designer Programs on page 32](#).



Locking a layer does not prevent objects on that layer from being modified. In addition, most objects can be deleted using the Delete Objects dialog. Objects are also deleted if the floor they are placed on is deleted. See [Deleting Objects on page 187](#).

Layer Display Options Dialog



The Layer Display Options dialog controls the display of layers in the active layer set. From any view except the Materials List, select **Tools> Display Options** to open this dialog.

The Layer Display Options dialog consists of a table that lists all layers and their attributes.

Select **Tools> Display Options** in a layout to open the similar Layout Page Display Options dialog. See [Layout Page Display Options on page 925](#).

To edit the attributes of the Reference Floor Layer Set, click the **Define** button in the Change Floor/Reference dialog. See [The Reference Display](#).

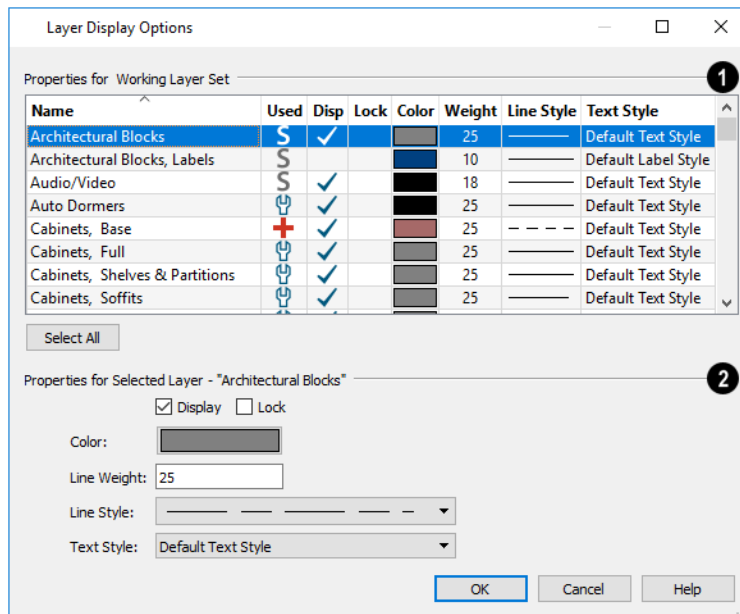

1 Properties for Current Layer Set

The **Properties for Current Layer Set** the layer set that is active in the current view are presented in a table of layers and their attributes. Click a column header to sort all layers in the table by that column. An arrow above a column indicates that it is being used to sort the table, and in which direction it is being sorted.

The **Name** column is sorted alphabetically. Layers are named so that similar object types are listed near one another, and sorting is case sensitive to allow greater control over organization.

- An icon in the **Used** column indicates that the layer is in use. The information in this column can be sorted, but not edited here. See [In-Use Layers on page 124](#).
- A check in the **Disp** column indicates which layers are set to be visible. If a layer is turned off, this column is blank.
- A lock icon  in the **Lock** column indicates which layers are locked, preventing objects on that layer from being selected. See [Locking Layers on page 125](#).
- The **Color** column shows the line color for each layer and can be sorted so that like colors are listed together.

- The **Line Style** column shows the line style for each layer and can be sorted so that like line styles are listed together.
- The **Line Weight** column displays the line weight used by each layer and can be sorted so that like line weights are listed together. See *Line Weights on page 950*.
- The **Text Style** column shows the text style assigned to each layer and can be sorted so that layers using the same style are listed together. See *Text Styles on page 360*.

Layers are selected by clicking on them in the table. Hold down the Shift key or the Ctrl key to select multiple layers at once. Press Ctrl + A or click the **Select All** button to select all layers in the table. When selected, a layer's attributes display and can be edited below.

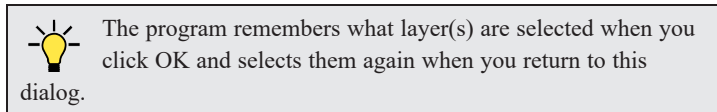

2 Properties for “Selected Layer”

The **Properties for “Selected Layer”** options let you modify the attributes of one or more selected layers. Line Color, Style, and Size affect lines in plan view and surface edge lines in Vector Views. When multiple layers are selected, “No Change” may display for attributes that are not shared by the selected layers.

- To turn off a selected layer, uncheck **Display**. See *Layer Attributes on page 124*.
- To protect the objects on a selected layer from accidental changes, check **Lock**. Items on locked layers can display but cannot be selected. See *Locking Layers on page 125*.
- To change the color of lines on a selected layer, click the **Color** bar to open the Select Color dialog. See *Select Color Dialog on page 134*.
- Specify the default **Line Weight**, or thickness, for objects on the selected layer. See *Line Weights on page 950*.
- To change the **Line Style** of a selected layer, click the drop-down arrow.
- To change the **Text Style** of a selected layer, click the drop-down arrow. See *Text Styles on page 360*.

Note: Not all objects display in all views. For instance, invisible walls do not appear in camera views or materials lists.

Layer Sets

Layer Sets are used to control the layer settings for different views in a plan or layout file. All views associated with a plan file - including views sent to layout - make use of layer sets stored in that **.plan** file.

A layer set consists of a complete list of the layers in the current plan or layout along with the display settings for each layer as set for a particular type of view. These display settings can be modified, and can be different for each type of view. See *Layer Display Options Dialog on page 126*.

Layer sets are file specific, which means that changes made in one plan or layout file have no effect on the settings in other files.

Home Designer uses a different layer set for each type of view of your plan:

- Plan views. See *Plan Views on page 102*.
- Camera views and Overviews. See *3D View Tools on page 740*.
- Cross Section/Elevation views.

- Wall Elevation Views.
- Framing Overviews. See [Framing Overview on page 743](#).
- Reference Floor. See [The Reference Display](#).

While any view is active, select **Tools> Display Options**  to make changes to the layer set used for that view type.

Any changes made to settings in the Layer Display Options dialog for one particular view will affect all views using that same layer set. For example, if you make changes for a camera view, all camera views and overviews in the current plan will be affected. See [Layer Display Options Dialog on page 126](#).

Drawing Groups

Each object in a plan or layout file belongs to a Drawing Group, which influences whether it displays in front of or behind other objects. Drawing Groups control the display of objects in plan view and on the layout page. They also control the display of CAD objects drawn in cross section/elevation views. They do not affect the display of objects in camera views and overviews.

Most categories of objects have their own Drawing Group; however, a few objects are instead placed in the Front or Back Group. Imported pictures, which are placed in the Back Group, are a notable example. A selected object's Drawing Group is reported in the Status Bar. See [The Status Bar on page 23](#).

Within a given Drawing Group, drawing order is determined by the order in which objects are placed. By default, an object will display in front of any objects that were created before it was. For example, if you place a chair and then a table, the table will display in front of the chair; if you instead place a table and then the chair, the chair will display in front.

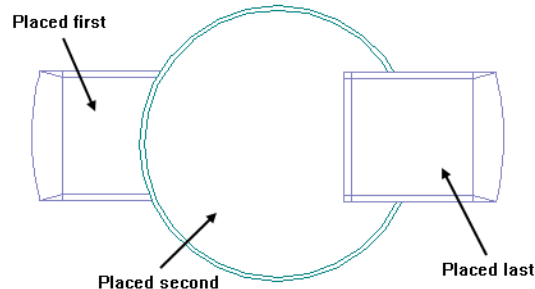

Drawing order also affects how objects are selected. If two objects are positioned so that they overlap one another, and you click at a point that they both share, the frontmost object will become selected first. See [Select Next Object on page 143](#).

DRAWING GROUP EDIT TOOLS

 Once an object has been placed, its position in the drawing order can be modified. To do this, select one or more objects and click the **View Drawing Group Edit Tools** edit button.

There are two options for moving a selection towards the back of the drawing order:



Click the **Send to Back** edit button to move the selected object(s) to the back of the Back Group so it displays behind all other objects.



Click the **Send Backward** edit button to move the selected object(s) to the back of its current Drawing Group. If it is already at the back of its current group, it will be moved to the next group down in the drawing order.

There are two options for moving a selection towards the front of the drawing order:



Click the **Bring to Front** edit button to move the selected object(s) to the front of the Front Group so that it displays in front of all other objects.



Click the **Bring Forward** edit button to move the selected object(s) to the front of its current Drawing Group. If it is already at the front of its current group, it will be moved to the next group up in the drawing order.

SELECT DRAWING GROUP DIALOG

The **Select Drawing Group** edit button reports the Drawing Group number that the selected object(s) is in. When multiple objects are selected, a horizontal line may display instead. Click this button to open the Select Drawing Group dialog.

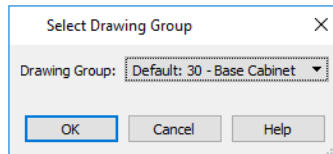

- Select a Drawing Group from the drop-down list to place the selected object(s) into that group. The default group for the selected object is noted as such.
- When multiple objects in different groups are selected, “No Choice” will initially display. You can select “Default: Multiple Values” to return each object to its respective default group.

Display Toggles

There are a number of toggles and tools that can be used to affect the appearance of the on-screen display.

PRINT PREVIEW



Print Preview and its related display toggles allow you to get a sense of what the current view will look like when it is printed. See [Print Preview on page 947](#).

REFRESH DISPLAY



Refresh Display redraws the current window to clean up extra lines, show missing items, and correct random on-screen effects caused by changes to a model. Select **View > Refresh Display** or press the F5 key to refresh the on-screen display.

COLOR ON/OFF





The display of color on-screen can be toggled on and off in any view by selecting **View > Color** or by clicking the toggle button.



- If **Color** is toggled off in any 3D view other than a Vector View, the view will be displayed in grayscale.
- If **Color** is toggled off in any line based view, including plan view, Vector Views, and layout, the view will be displayed either in black and white or grayscale, depending on the **Color Off Is** setting in the Preferences dialog. See [Appearance Panel on page 60](#).

The Color toggle can be set on a view by view basis and can be saved in the Camera Specification and Cross Section/Elevation Specification dialogs. See [Camera Panel on page 760](#) and [Camera Panel on page 766](#).

To display views in grayscale

1. Select **View> Color**  to toggle color off.
2. Select **Edit> Preferences**  to open the Preferences dialog.
3. On the APPEARANCE panel, select **Grayscale** as the **Color Off Is** setting. See *Appearance Panel on page 60*.

To display views in black and white

1. Select **View> Color**  to toggle color off.
2. Select **Edit> Preferences**  to open the Preferences dialog.
3. On the APPEARANCE panel, select **Black and White** as the **Color Off Is** setting.

When **Color**  is toggled off and **Black and White** is specified, all lines appear as black, regardless of their color. Solid fill colors appear as either white or black, depending on which is closer to the actual fill color when Color is turned on. The background remains as defined in the Preferences dialog. See *Colors Panel on page 62*.

You can specify whether cross section/elevations, camera views, and overviews using the Vector View Rendering Technique are generated with colors turned on in the 3D View Defaults dialog. See *3D View Defaults Dialog on page 739*.

You can also print in color, black and white, or grayscale. See *Print View Dialog on page 955*.

ARC CENTERS AND ENDS

 The display of arc center- and endpoints, and the display of circle center points can be toggled by selecting **View> Arc Centers and Ends**, by clicking the toggle button, or in the CAD Defaults dialog. See *Arc Centers and Ends on page 151*.

DELETE SURFACE

 In any 3D view, select **3D> Delete Surface**, then click a surface in the view to temporarily remove the surface from the current view. See *Delete 3D Surface on page 749*.

Fill Styles

Fill styles are CAD-based patterns that can be used to fill the interiors of closed CAD shapes. In plan view, fill styles can also be applied to a variety of architectural objects.

The Fill Styles library contains fill styles that can be applied to objects individually in their specification dialogs, by default in their defaults dialogs, as well as using the **Fill Style Painter** tools.

FILL STYLE EYEDROPPER AND PAINTER TOOLS

 The **Fill Style Eyedropper** tools allows you to load a fill style assigned to an existing object into the Fill Style Painter and apply that fill style to other eligible objects. It is similar to other Eyedropper tools.

Select **Tools> Fill Style Painter** to access the **Fill Style Painter** tools, which are used to apply fill styles to closed CAD objects. In plan view, the Fill Style Painter tools can be used to apply fill styles to a variety of architectural objects, as well.

These tools are similar to other Painter Tools in the program. See *Eyedropper and Painter Tools on page 185*.

 Patterns, which are similar to fill styles, can be used to represent materials in Vector Views. See *Patterns and Textures on page 712*.

IMPORT PATTERNS



Select **File> Import> Import Patterns** to open the Import Custom Patterns file and import a **.pat** file. See *Importing Files on page 42*.

Patterns are imported directly to the User Catalog in the Library Browser. See *The User Catalog on page 677*.

FILL STYLE SPECIFICATION DIALOG

To open the Fill Style Specification dialog, right-click on a fill style in the library and select **Open Object** or right-click on an unlocked library folder and select **New> Fill Style**. See *Using the Contextual Menus on page 673*.

You can also create a new fill style by clicking the **Add New Fill Style**  button in the Select Library Object dialog. See *Select Library Object Dialog on page 688*.

To open the similar Layer Fill Style dialog, click in the Fill column in the Wall Type Definitions or any Material Layers Definition dialog. See *Wall Type Definitions Dialog on page 259* and *Material Layers Definition Dialogs on page 709*.

The Default Framing and Default Header Fill Style dialogs are also similar to this dialog and can be accessed by clicking the **Fill Style** button on the PLAN DISPLAY and OPENINGS panels of the Build Framing dialog. See *Build Framing Dialog on page 613*.

The settings in this dialog are also found on the FILL STYLE panel of specification dialogs for a variety of objects in the program. This panel is not available for Sprinkler Lines or Electrical Connections as these tools cannot be used to form closed shapes.

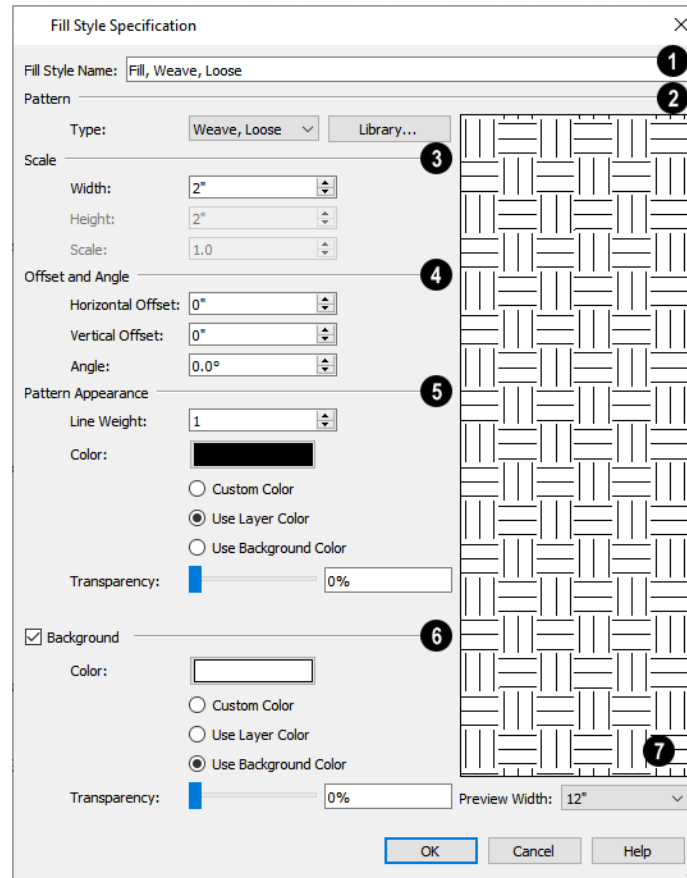

1 Fill Style Name

In the Fill Style dialog only, specify the **Fill Style Name**.

2 Pattern

Select a **Pattern Type** from the drop-down list and specify its characteristics.

- Select “Library” from the list or click the **Library** button to choose a pattern from the library. When a Library fill style is selected, a custom name may display in the list instead of a system default Type. See *Assigned Items on page 687*.

 When a fill style from the library is selected, it is possible for some or all of the settings in this dialog to change.

3 Scale

Specify the fill style’s **Scale**.

- Specify the **Width** of the selected fill pattern. For Concrete and Sand fills, instead adjust the overall **Spacing**. Not available for Solid fill.
- Specify the **Height** of the selected fill pattern. Only available for the Grid fill Types, as well as Herringbone and U’s.

- Specify a **Scale** for the selected fill pattern. Only available when the name of a library fill style from the library is listed as the fill Type, above.

4 Offsets and Angle

Specify the fill's **Offsets and Angle**.

- Specify the **Horizontal** and **Vertical Offsets**. See *Mapping Patterns and Textures on page 722*.
- Specify the **Angle** of the selected fill pattern. Not available for Solid fill.

5 Appearance

Additional **Pattern Appearance** settings control the fill's line weight and color.

- Set the **Line Weight** for the selected fill pattern. Not available for "Solid" fill.
- Specify a custom **Pattern Color** for the lines that make up the fill pattern or Solid fill by clicking the color bar. The Layer Color is used by default. See *Select Color Dialog on page 134*.
- **Custom Color** is selected automatically if you click the color bar above.
- Select **Use Layer Color** to have the fill pattern use the layer color for the pattern lines or solid fill.
- Select **Use Background Color** to use the view's background color for the pattern lines or solid fill.
- Use the **Transparency** slider bar or text field to control how transparent the fill pattern lines are. This setting also affects the transparency of Solid fill colors.

6 Background

Check **Background** to add a solid background color to the fill pattern and enable the settings below. When unchecked, the fill pattern has a transparent background. Not available when "Solid" is the selected Pattern Type.

- Specify a custom **Background Color** by clicking the color bar. The Background Color set in the Preferences dialog is used by default. See *Colors Panel on page 62*.
- **Custom Color** is selected automatically if you click the color bar above.
- Select **Use Layer Color** to have the fill pattern use the layer color for the pattern lines or solid fill.
- Select **Use Background Color** to use the view's background color for the pattern lines or solid fill.
- Use the **Transparency** slider bar or text field to control how transparent the background color is.
- On the FILL STYLE panel only, click the **Add to Library** button to add the fill pattern as it is currently defined to the User Catalog. See *Add to Library on page 681*.

7 Preview

A preview of the selected pattern displays to the right. As changes are made to the settings on this panel, the preview will update.

- Choose a **Preview Width** from the drop-down list. This value controls how large an area the preview represents. The selected value indicates the horizontal width of the preview pane in actual plan inches (mm).

Select Color Dialog

The Select Color dialog can be opened by clicking on the Color bar that can be found in many dialogs throughout the Windows version of the program.

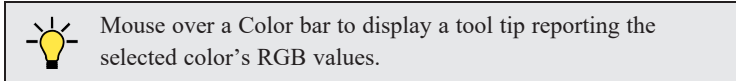

In the Mac version, the standard Colors dialog, or Color Picker, is used instead.

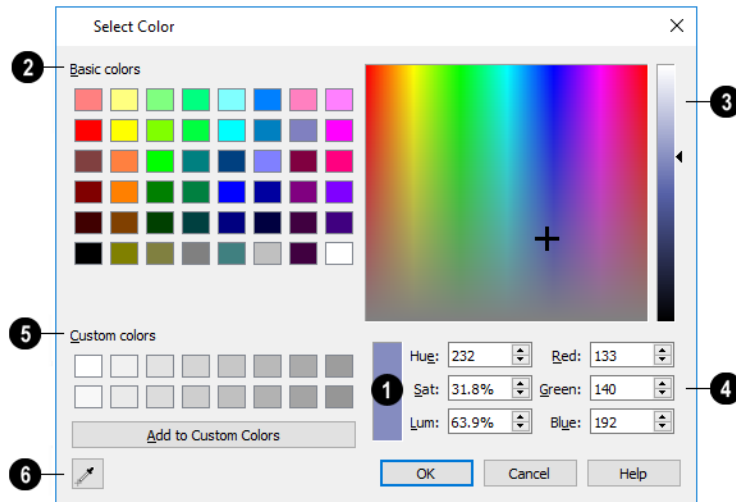

1 Current Color

The currently selected color displays in the rectangle at the lower center of the dialog. There are a number of ways to select a color in this dialog.

2 Basic Colors

Click in any one of the color boxes to select it.

3 Color Spectrum

- Click anywhere in the color spectrum area to select a color. The location of the selected color is identified by crosshairs.
- Click anywhere in the vertical bar or drag the arrow to adjust the selected color's Luminosity and RGB values.

4 Color Definition

- Define a color by specifying its **Hue**, **Saturation**, and **Luminosity** (HSL) or its **Red**, **Green**, and **Blue** (RGB) values.

5 Custom Colors

- Click in one of the **Custom colors** boxes to either select it or to specify it as the box for a new custom color to be defined.
- Click the **Add to Custom Colors** button to add the selected color to the Custom Colors group.

6 Color Chooser Eyedropper

Click this button, then click anywhere on your monitor to select the color displaying at that location.

Click OK to apply the currently selected color to the object's line or fill style, or to the material's pattern color.

Editing Objects

Chapter 9

Just as the methods used to create different objects in Home Designer are similar, the options for moving, rotating, resizing, and otherwise editing them are also alike.

Edit handles allow objects to be resized, relocated, or rotated using the mouse. Edit toolbar buttons and the contextual menus access edit tools relevant to the selected object(s). Most objects have a specification dialog that allows you to edit it in ways that are specific to that type of object.

The editing characteristics common to most objects are described in this chapter. Unique, object-specific editing behaviors and the specification dialogs are covered in their respective chapters.

TOPICS

Defaults, Preferences, and Edit Behaviors	137
Selecting Objects	141
Selecting Multiple Objects	143
Editing Line-Based Objects	145
Editing Arc-Based Objects	147
Editing Open Polyline-Based Objects	151
Editing Closed Polyline-Based Objects	155
Editing Box-Based Objects	158
Editing Spline-Based Objects	160
Editing Circles, Ovals and Ellipses	162
Editing Multiple Objects	164
Moving Objects	165
Aligning Objects	168
Resizing Objects	171
Reshaping Objects	171
Rotating Objects	175
Reflecting Objects	177
Converting Objects	179
Transform/Replicate Object Dialog	180
Edit Area Tools	182
Stretch CAD	184
Eyedropper and Painter Tools	185
Object Painter	187
Deleting Objects	187
Delete Objects Dialog	188
Undo and Redo	191

Defaults, Preferences, and Edit Behaviors

The same defaults and preference settings that affect how objects are drawn also influence how they can be edited. See [Defaults and Preferences on page 111](#).

 In addition, the **Edit Behavior** modes that determine how edit handles affect an object, and may also affect how objects are drawn. The currently active Edit Behavior is a global preference setting, affecting all plan and layout files.

Two of these modes, **Default** and **Alternate**, are useful for most drawing and editing needs and can be considered primary editing modes. Default mode, in particular, accesses the most commonly used behaviors and is the best choice in most circumstances.

When an Edit Behavior other than Default is active, its icon displays near the mouse pointer. For example, when **Connect CAD Segments** is disabled, CAD objects cannot connect to form polylines and the Connect CAD Segments  icon follows the mouse pointer to remind you that this behavior is active. See [Pointer Icons on page 15](#).

Regardless of which Edit Behavior is active, the Default behavior is restored when you close the program.

The other modes, **Resize**, **Concentric**, and **Fillet**, offer special editing behaviors that may be useful only in certain situations and can be considered secondary.

Each edit behavior can be temporarily enabled using the different buttons on your mouse or by pressing the keyboard keys associated with each. See [Using Input Devices on page 13](#) and [Hotkeys on page 98](#).

You can also specify which edit behavior mode is active when the left mouse button is used in the Preferences dialog, by selecting **Edit > Edit Behaviors** , or by clicking the corresponding toggle button, which can be added to your toolbar.

See [Behaviors Panel on page 76](#).

DEFAULT

 The **Default** mode is one of the primary edit behavior modes. It offers access to the most commonly used edit behaviors and should be selected as your preference in most situations.

 When the use of a tool is described in this manual, it is assumed that the Default edit behavior mode is active.

- **Drawing** - Standard click and drag drawing behavior is enabled. See [Creating Objects on page 115](#).
- **Resize/Reshape** - Default allows you to adjust the angle of any corner of a polyline without affecting adjacent corners, changing the object's shape.

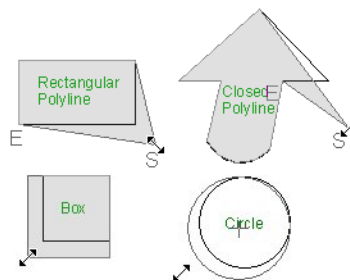

- For box-based objects, the Default mode functions the same as the Alternate mode.



- **Movement** - Default allows you to move objects orthogonal, or at a right angle, to any of their edges.
- **Rotation** - In Default mode, objects snap at Allowed Angles as they are rotated.

You can temporarily enable the **Default**  edit mode when another mode is active by pressing **Alt + Z** or **Alt + /** while performing an edit or drawing operation.

ALTERNATE

Alt The **Alternate** mode is the second primary edit behavior mode. When this mode is active, the Alternate Alt icon displays near the mouse pointer.



Note: Not all commands have an Alternate edit behavior. If a selected tool does not, it will not work when this edit mode is active.

- Alternate allows you to drag an end handle on an open polyline to change it from a line to an arc or vice versa.
- Alternate overrides the **Lock Center**  setting of arc-based objects.
- **Movement** - Alternate allows you to move objects at Allowed Angles when **Angle Snaps**  are enabled, or orthogonal to any of its edges when they are not. See [Angle Snaps on page 114](#).
- **Rotation** - Alternate snaps objects at Allowed Angles as they are rotated.

You can temporarily enable the **Alternate** edit mode when another mode is active by pressing **Alt** or using the right mouse button while performing an edit operation.

- **Drawing** - Standard click and drag drawing behavior is enabled.
- **Resize/Reshape** - Move allows you to move the selected object when any edit handle is used.
- **Movement** - Move mode allows you to move objects at Allowed Angles.
- **Rotation** - In Move mode, objects snap at Allowed Angles as they are rotated.

RESIZE

 The **Resize** edit behavior allows you to rescale an object. As you drag a corner edit handle of an object, you get an exactly scaled version of the original. For example, you can resize an object to 50% of its original size while maintaining the same proportions. When this mode is active, the **Resize**  icon displays near the mouse pointer.

- **Drawing** - Standard click and drag drawing behavior is enabled.
- **Resize/Reshape** - Resize allows you to keep the angle between adjacent edges fixed when a corner handle is moved.

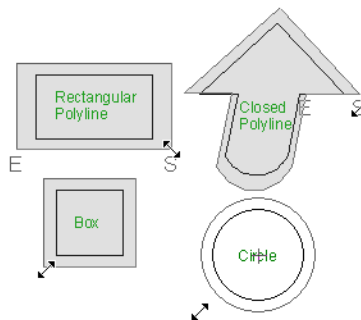



To proportionally resize an object, always drag a corner edit handle and not an edge handle.

- **Movement** - Resize allows you to move an object orthogonal, or at a right angle, to any of its edges.
- **Rotation** - In Resize Mode, objects snap at Allowed Angles as they are rotated.

You can temporarily enable the **Resize** edit mode when another mode is active by pressing **X** or the period key, or using the X2 button on a five-button mouse while performing an edit or drawing operation. See [Using Input Devices on page 13](#).

CONCENTRIC

 The **Concentric** mode allows you to resize objects so that the distance moved by each edge is the same. For example, you can resize an irregularly shaped polyline so that each edge is exactly ten feet in from the original position, which is useful for creating site plans with setbacks. When this mode is active, the Concentric  icon displays near the mouse pointer.

- **Drawing** - Standard click and drag drawing behavior is enabled.
- **Resize/Reshape** - Concentric allows you to resize an irregularly-shaped polyline so that each edge is moved the same distance from its original location.

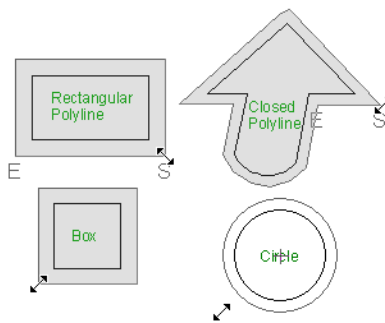

- Concentric mode also allows you to move opposite edges of an object so that each edge is moved the same distance from its original location.

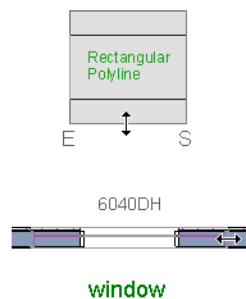

- **Movement** - Concentric mode allows you to move an object orthogonal, or at a right angle, to any of its edges.
- **Rotation** - In Concentric mode, objects snap at Allowed Angles as they are rotated.

In some cases, the Concentric and Resize edit behaviors have the same result, such as when a circle is resized. Usually, though, the two behaviors are different because concentric resizing does not maintain the original ratio between an irregular polyline's edges.

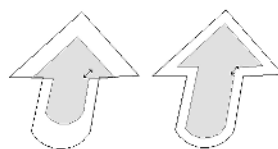



In Concentric mode, objects resize in **Concentric Jump** increments specified in the Preferences dialog. See *Behaviors Panel on page 76*.

When the **Concentric Jump** distance is set at 0", objects resize according to the **Snap Unit** specified in the Plan Defaults dialog. See *Grid Snaps on page 115*.

 To concentrically resize an object with no restrictions, set the Concentric Jump value on the Behaviors panel of the Preferences dialog to zero and turn off Grid Snaps.

You can temporarily enable the **Concentric** edit mode when another mode is active by pressing **C** or the command key, or using the X1 button on a five-button mouse while performing an edit or drawing operation. See *Using Input Devices on page 13*.

FILLET

 The **Fillet** mode allows you to add a fillet, or curve, at any corner of an object. Dragging a corner edit handle adjusts the fillet radius at that corner. When this mode is active, the Fillet  icon displays near the mouse pointer.

- **Drawing** - Standard click and drag drawing behavior is enabled.
- **Resize/Reshape** - Fillet allows you to create a fillet at by dragging a corner edit handle inward.

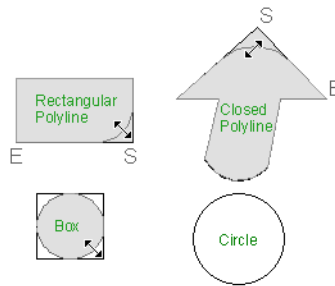

- **Movement** - Move mode allows you to move objects at Allowed Angles.
- **Rotation** - In Move mode, objects snap at Allowed Angles as they are rotated.

The **Fillet** edit behavior adjusts all the corners of a box at once. The radius of each corner is the same.

Fillet does not have an effect on circles, ovals, ellipses or arc segments.

You can temporarily enable the **Fillet** edit mode when another mode is active by pressing **F** while performing an edit or drawing operation.

 To produce fillets or chamfers of an exact radius, use the Fillet Lines or Chamfer Lines edit button. See *Fillet Lines on page 174* and *Chamfer Lines on page 175*.

CONNECT CAD SEGMENTS



 Typically, when two CAD objects share the same properties and Endpoint Snaps are enabled, they can be snapped end-to-end to form a polyline. **Connect CAD Segments** controls whether CAD objects with the same properties can be snapped together to form polylines. It also controls whether spline segments can be snapped together. See *Polylines on page 214* and *Splines on page 219*.

Select **Edit> Edit Behaviors> Connect CAD Segments** to toggle this behavior on or off. You can also turn **Connect CAD Segments** on or off in the Preferences dialog. See *CAD Panel on page 74*.

In addition to CAD objects, **Connect CAD Segments** also affects stairs, ramps, and road objects. See *Stairs, Ramps, and Landings on page 510* and *Roads, Driveways and Sidewalks on page 883*.

When **Connect CAD Segments** is disabled, CAD objects cannot connect to form polylines and the Connect CAD Segments  icon displays near the mouse pointer. See *Pointer Icons on page 15*.

ROTATE/RESIZE ABOUT CURRENT POINT

 Objects can be rotated or resized about either their own centers or the current CAD point. See *The Current Point on page 197*. When this mode is active, the **Rotate/Resize About Current Point**  icon displays near the mouse pointer. See *Rotate/Resize About on page 176*.

Selecting Objects

“Select” refers to selecting an object for editing. An object must be selected before it can be edited. There are a number of ways that objects can be selected:

Groups of objects can also be selected simultaneously. See *Selecting Multiple Objects on page 143*.

In order for an object to be selected, it must be both unlocked and visible in the current view. See *Layers on page 123*.

When an object is selected, it displays edit handles and a selection fill color. See *Colors Panel on page 62*.

In 3D views, a selected object will also display lines representing the selected edge or surface. The size of the edit handles does not change as you zoom in or out and is set in the Preferences dialog. See *Edit Panel on page 75*. To prevent them from stacking on one another, some edit handles may not display as you zoom away from the selected object.

When an object is selected, its edit toolbar also displays, typically at the bottom of the Home Designer program window just above the Status Bar. See *The Edit Toolbar on page 91*.

Information about the selected object or objects will also display in the Status Bar. See *The Status Bar on page 23*.

A selected object remains selected until another object is selected, a different tool is activated, the Esc key on the keyboard is pressed, or any two mouse buttons are pressed at the same time.



SELECT OBJECTS

 With the exception of temporary CAD points, any object created using Home Designer Pro's drawing tools can be selected using the **Select Objects** tool. Select **Edit> Select Objects**, click the toolbar button or press the **Space** bar on your keyboard to activate this tool, then click on an object to select it.

You can also select objects or open context sensitive menus using the right mouse button when any tool is active.

By default, you can select an object by clicking within 12 pixels of it. You can adjust this distance by changing the **Snap Distance** in the Preferences dialog. A lower value, for example, can be helpful for working with small objects but can also make it very difficult to select larger objects. See *Snap Properties Panel on page 78*.

SELECTING SIMILAR OBJECTS

If a tool other than **Select Objects**  is active, you can only select objects of that type using the left mouse button. For example, if the **Straight Exterior Wall**  tool is active, you can only select walls using the left mouse button.

This can be useful for selecting an object when many objects of a different type occupy the same space in plan view.

Objects can be selected using the right mouse button, regardless of which tool is active.

RIGHT-CLICKING

Regardless of which tool is active, you can select an object by right-clicking on it once. When you right-click to select an object a contextual menu also appears, displaying the object's edit tools. You can turn contextual menus on or off in the Preferences dialog. See [Contextual Menus on page 18](#).

If a drawing tool is active and you right-click to select an object, you can unselect it by left-clicking in an empty space in the drawing area. Although a drawing tool is active, it is not used. If you then left-click a second time, the active tool will be used.

SELECTED EDGE

When you click on a polyline- or box-based object, the edge that you click nearest becomes the selected edge and displays an edit handle larger and of a different color than those on other edges. The handle on this edge may also display at the point where you clicked to select it. You can specify the **Selected Edge Handle Fill** color in the Preferences dialog. See [Colors Panel on page 62](#).

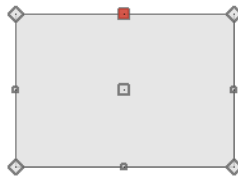

This edge can be edited on the SELECTED LINE or SELECTED ARC panel of the object's specification dialog, as well as using a variety of edit toolbar buttons. It can also be moved using dimensions. See [Moving Objects Using Dimensions on page 332](#), [Line Panel on page 203](#) and [Arc Panel on page 210](#).

The Start and End points of a CAD-based object's selected edge or of a wall can be indicated by an S and an E when the object is selected. These Start and End indicators can be helpful when editing the selected edge in the object's specification dialog, and their display can be turned on and off in the Preferences dialog. See [Edit Panel on page 75](#).



DISCONNECT EDGES



 Polyline-based objects are composed of lines and arcs that are connected end to end. The individual edges of open and closed polylines can be selected and edited independently of the object's other edges when **Disconnect Edges** is in use. Select **CAD> Lines> Disconnect Edges** to enable this ability.

Disconnect Edges also affects terrain paths, but does not affect Walkthrough Paths, Connect Electrical or Sprinkler splines, or closed polyline-based objects such as slabs and roof planes.

To use Disconnect Edges

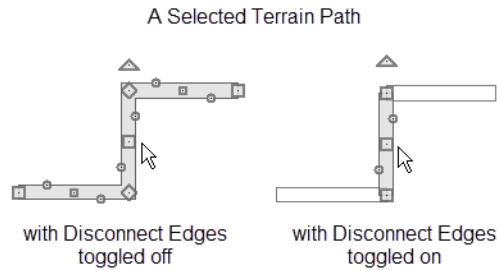
1. Select **CAD> Lines> Disconnect Edges** .
2. Click on an individual edge of an eligible polyline-based object to select it.



3. Notice that it is no longer connected to the rest of the polyline.
4. The individual segment can now be edited entirely independent of its neighbors.
5. Continue clicking on polyline edges to disconnect them from their polyline.
6. When you are finished, click the **Select Objects**  button or activate another tool.
7. To connect the segment to the polyline again, move the end handles so that they snap to the ends of adjacent segments.
8. When **Disconnect Edges**  is used, only edges that you click on are actually affected by it. Any polylines that you do not click on will remain intact.

You can also separate the selected edge of an open or closed polyline from the rest of the polyline by clicking the **Disconnect Selected Edge**  edit button. See [Selected Edge on page 142](#).

SELECTED SIDE

Most architectural objects can be selected in 3D views. When selected, the outline of their bounding box displays, and edit handles are located on the side where you clicked to select the object. The edit handles can be used to move, resize, or rotate the object in different directions, depending on which side is selected.

Groups of objects can be selected by holding down either the Shift or Ctrl key when the **Select Objects**  tool is active and then dragging a marquee around the objects to be selected.

SELECT NEXT OBJECT

 If there is more than one object in a particular space, it may be difficult to select the desired object. When a nearby object is selected, click the **Select Next Object** edit button or press the Tab key until the desired object becomes selected. This function cannot be applied to groups of selected objects.

Selecting Multiple Objects

Multiple objects can be selected and edited in groups. The options available for editing them will vary depending on the type or types of objects selected. See [Editing Multiple Objects on page 164](#).

MARQUEE SELECT

Groups of objects can be selected by holding down either the Shift or Ctrl key when the **Select Objects**  tool is active and then dragging a marquee around the objects to be selected.

When using the marquee-select method, both CAD and architectural objects included in the marquee are selected. To remove an object from the selection set, hold down the Ctrl key and click on it.

If an object is selected and a selection marquee is drawn around it using the Ctrl key, that object becomes deselected. If the Shift key is used instead, the original object remains selected and the other objects are added to the selection set.

The Shift key can be used to marquee-select objects of a similar type when the drawing tool used to create those objects is active.

To marquee-select objects by type

1. Select a drawing tool used to create the type of object you wish to select: for example, the **Hinged Door**  tool.
2. Hold down the Shift key, then click and drag a rectangular selection marquee in the drawing area.
3. When you release the mouse button, objects of the selected drawing tool's type - here, door objects - located in the marquee will be selected.







You can specify whether objects must be totally contained in or intersected by the marquee, or whether an object's center point must be contained in the marquee, in the Preferences dialog or using the **Selection Mode**  buttons, which can be added to your toolbars. See [Edit Panel on page 75](#).

 To make marquee selection easier, you can turn off the display of objects you do not want to include in your selection set. See [Layers on page 123](#).

MARQUEE SELECT SIMILAR

 The **Marquee Select Similar** edit tool lets you group-select objects in the current plan view that are similar to the selected object(s).

To use Marquee Select Similar

1. In plan view, select one or more objects, then click the **Marquee Select Similar**  edit button.
2. The **Restrictive Selection**  toggle controls whether objects are selected by similar type(s) only, or if additional attributes are taken into account.
 - **Restrictive Selection**  is disabled by default, so objects of the same type will be selected.
 - Click the **Restrictive Selection**  edit button to toggle it on and select only objects with additional attributes like materials in common.
3. Click and drag a rectangular selection marquee in the drawing area to select similar objects within its area.
4. Alternatively, click the **Select All Similar**  edit button to select all similar objects in the current view.
5. The **Marquee Select Similar**  tool is not available for all object types. For example, it is not available for wall framing.

SHIFT AND CTRL SELECT

You can select a group of objects by adding them to the selection set one by one. Select an object, hold down either the Shift or Ctrl key, and click additional objects to select them.

More than one type of object can be selected using this method, but the ability to edit the group-selected items is limited to attributes that all selected objects have in common.

To remove an object from a selection set, click on it once more with the Ctrl key pressed.

The Shift and Ctrl keys can be used to select multiple items in a variety of contexts, such as: the Library and Project Browsers, lists in dialog boxes, and files to be imported. They can also be used to marquee-select objects in plan view. See *Marquee Select on page 143*, above.

EDIT AREA

 - The **Edit Area Tools** allow you to define an area of your plan and select the objects within that area for editing. See *Edit Area Tools on page 182*.

Editing Line-Based Objects

Objects are considered line-based when they can be edited similar to CAD lines using their edit handles.

CAD lines, framing members, straight walls and railings, straight stairs, and straight roads are examples of line-based objects.

Most line-based objects can be connected to the ends of other like objects to form polylines or polyline-based objects provided that they have identical attributes such as line color and arrow specifications. See *Editing Open Polyline-Based Objects on page 151* and *Editing Closed Polyline-Based Objects on page 155*.

Some objects, notably walls, have line-based editing behavior only when selected on certain surfaces. See *Editing Walls on page 244*.

Wall openings such as doors and windows have line-based editing behavior in plan view only but cannot be rotated, reversed or converted to an arc. See *Editing Doors on page 371* and *Editing Windows on page 403*.

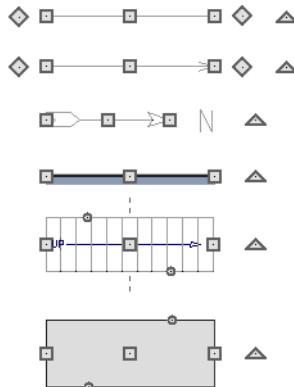

Other objects, such as stairs and roads, have additional edit handles that allow you to concentrically adjust the object's width.

USING THE EDIT HANDLES

When selected, a typical line-based object displays six edit handles: a Move handle, two Extend/Change Angle handles, two Same Line Type handles, and a Rotate handle.

Any action performed using the edit handles can be canceled by pressing the Esc key or any two mouse buttons at the same time.

 The behavior of the edit handles may depend on the currently active Edit Behavior. See *Defaults, Preferences, and Edit Behaviors on page 137*.

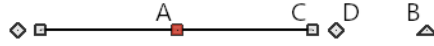

A. Move

- Click and drag the Move handle to move the object according to the currently active **Edit Behavior** . See *Defaults, Preferences, and Edit Behaviors on page 137*.
- Movement may be limited or stopped by other objects or Snap Behaviors. Move restrictions can be overridden by holding down the Ctrl key while dragging. See *Unrestricted Movement on page 166*.

B. Rotate

- The **Rotate** handle is used to rotate the object, either about its center or about the current CAD point. See *Rotating Objects on page 175*.

C. Extend/Change Angle

- Drag a square end handle parallel to the selected line to change its length.
- Drag a square end handle at an angle to the selected line to change its angle. When **Angle Snaps**  are on, the line snaps to Allowed Angles. See *Angle Snaps on page 114*.
- Right-click and drag it to change the adjacent line into an arc, or vice versa. See *Alternate on page 138*.

D. Same Line Type

- Drag a diamond-shaped end handle in any direction to draw a new line that shares the original's color, weight, line style, and layer. See *Same Line Type Edit Handles on page 202*.

Adjust Width

Some line-based objects, such as stairs and roads, have additional handles that allow the width of the object to be adjusted.

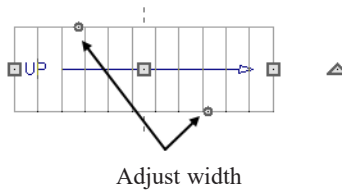

- Click and drag a small, round **Expand** handle to increase or decrease the object's width. By default, objects are resized in 1" increments. This Snap Unit is defined in the Plan Defaults dialog. See *General Plan Defaults Dialog on page 56*.

USING DIMENSIONS

-  Dimensions can be used to position line-based objects relative to other objects. See *Moving Objects Using Dimensions on page 332*.

Dimensions cannot, however, be used to adjust the length of line-based objects, or the width of line-based objects such as stairs.

USING THE SPECIFICATION DIALOG

-  Line-based objects can be edited using their specification dialogs. See *Line Specification Dialog on page 202*.

USING THE EDIT TOOLBAR

A selected line-based object can be edited in a variety of ways using the buttons on the Edit Toolbar.

The following toolbar buttons may display on the Edit Toolbar for a selected line-based object:



Select Next Object selects nearby objects instead of the selected object. See [Selecting Objects on page 141](#).



Open Object opens the specification dialog for the selected object(s). See [Specification Dialogs on page 19](#).



Copy/Paste copies the selected object(s) to the system clipboard so they can be pasted elsewhere. See [Copying and Pasting Objects on page 117](#).



Delete deletes the selected object(s). See [Deleting Objects on page 187](#).



Transform/Replicate Object copies, moves, rotates, resizes, or reflects the selected object(s). See [Transform/Replicate Object Dialog on page 180](#).



Make Parallel/Perpendicular makes the selected object(s) parallel or perpendicular to a straight edge. See [Make Parallel/Perpendicular on page 169](#).



Point to Point Move accurately moves the selected object(s). See [Point to Point Move on page 167](#).



Center Object centers an object along a wall within a room or relative to a cabinet fixture. See [Center Object on page 169](#).



Reflect About Object reflects the selected object(s) about another object. See [Reflecting Objects on page 177](#).



View Drawing Group Edit Tools modifies the selected object's place in the drawing order. See [Drawing Group Edit Tools on page 128](#).



Add Break adds a new corner or pivot point to the selected object. See [Add Break on page 172](#).



Complete Break breaks the selected object into two separate objects. See [Add Break on page 172](#).



Reverse Direction reverses the direction of the selected object(s). See [Reverse Direction on page 178](#).



Convert Polyline converts the object into a special polyline-based object. See [Convert Polyline on page 179](#).



Change Line/Arc changes a line-based object to an arc, or vice versa. See [Change Line/Arc on page 174](#).



Intersect/Join Two Lines joins two non-parallel lines or arcs. See [Intersect/Join Two Lines on page 174](#).



Fillet Lines create an additional arc connecting two non-parallel lines or arcs. See [Fillet Lines on page 174](#).



Chamfer Lines chamfers the corner between adjacent edges. See [Chamfer Lines on page 175](#).

Editing Arc-Based Objects

Objects are considered arc-based when they can be edited similar to CAD arcs using their edit handles.

CAD arcs, curved walls and railings, curved stairs, and curved roads are examples of arc-based objects.

Most arc-based objects can be connected to other like objects to form polylines or polyline-based objects provided that they have identical attributes such as line color and arrow specifications. See [Editing Open Polyline-Based Objects on page 151](#) and [Editing Closed Polyline-Based Objects on page 155](#).

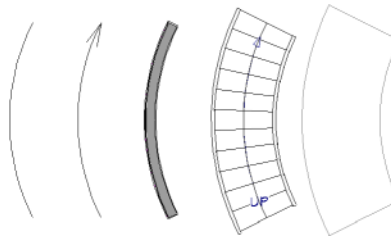

Some objects, notably curved walls, have arc-based editing behavior only when selected on certain surfaces. See [Editing Walls on page 244](#).

Other objects, such as curved stairs and roads, have additional edit handles that allow you to concentrically adjust the object's width.

The currently active **Arc Creation Mode**  determines how an arc-based object is drawn. Once an arc is drawn, the active Arc Creation Mode does not affect it. See [Drawing Arcs - Arc Creation Modes on page 206](#).

USING THE EDIT HANDLES

When selected, a typical arc-based object displays seven edit handles.

Any action performed using the edit handles can be canceled by pressing the Esc key or any two mouse buttons at the same time.

 The behavior of the edit handles may depend on the currently active Edit Behavior. See [Defaults, Preferences, and Edit Behaviors on page 137](#).

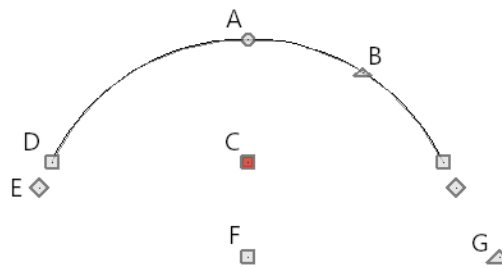

- A. Resize (changes radius)
- B. Reshape (moves center)
- C. Move Chord
- D. Extend (along arc or chord)
- E. Same Line Type
- F. Move Arc Center
- G. Rotate

Move

- Two Move edit handles allow the arc to be relocated without changing its shape. One is located at the center of the chord and the other, at the arc center.
- If you would like to snap one of these center points to another point, use that handle when moving the arc. See [Aligning Arc Centers on page 170](#).

- Click and drag the Move handle to move the object according to the currently active **Edit Behavior** . See *Defaults, Preferences, and Edit Behaviors on page 137*.
- Movement may be limited or stopped by other objects or Snap Behaviors. Move restrictions can be overridden by holding down the Ctrl key while dragging. See *Unrestricted Movement on page 166*.

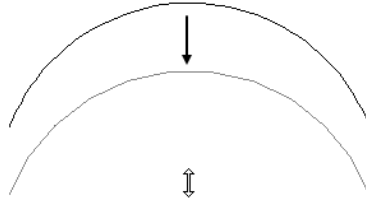

Dragging the Move edit handle downward

Rotate

- The **Rotate** handle is used to rotate the arc, either about its center or about the current CAD point. See *Rotating Objects on page 175*.

Extend

- The end edit handles expand or contract the arc when moved along the arc radius or chord.
- If you follow the path of the arc, the end edit handles allow you to adjust the arc length.
- The angle formed by the center point of the arc and its two endpoints is referred to as the Included Angle. If **Angle Snaps** are on, the Included Angle of the arc, as measured in degrees, can be rotated at Allowed Angles. See *Angle Snaps on page 114*.
- Right-click and drag it to change the adjacent arc into a line, or vice versa. See *Alternate on page 138*.

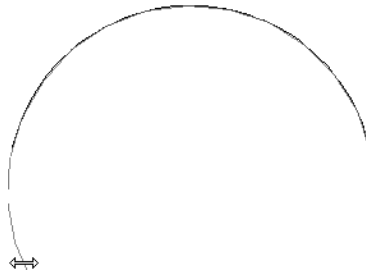

Dragging an End edit handle to lengthen an arc

Resize

- Drag the small, round **Resize** edit handle to change the radius and included angle of the arc while maintaining its center.

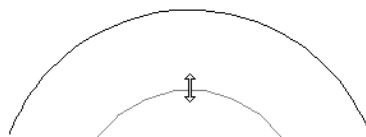

Dragging the Resize edit handle toward the center

Reshape

- Drag the small triangular **Reshape** handle to change the length and location of the center without moving the endpoints.

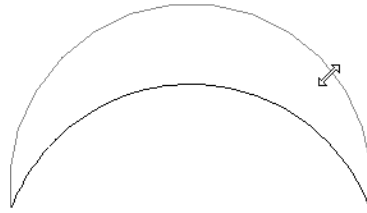

Dragging the Reshape edit handle away from the center

Same Line Type

- Drag a diamond-shaped end handle in any direction to draw a new line that shares the arc's color, weight, line style, and layer. See [Same Line Type Edit Handles on page 202](#).

Adjust Width

Some arc-based objects, such as stairs, have additional handles that allow the width of the object to be adjusted.

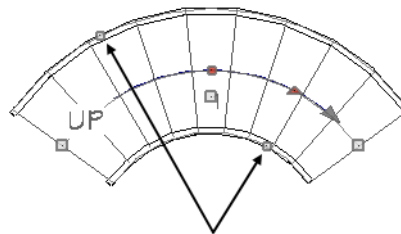

Adjust Width edit handles

- Click and drag a small, round edit handle to increase or decrease the object's width. By default, objects are resized according to the Snap Unit defined in the Plan Defaults dialog. See [General Plan Defaults Dialog on page 56](#).

USING DIMENSIONS

 Dimensions can be used to position arc-based objects. Dimension lines typically locate tangent extension lines and any extension lines that may be parallel to those lines rather than the arc itself. See [Moving Objects Using Dimensions on page 332](#).

USING THE SPECIFICATION DIALOG

 Arc-based objects can be edited using their specification dialogs. See [Arc Specification Dialog on page 209](#).

USING THE EDIT TOOLBAR

A selected arc-based object can be edited in a variety of ways using the buttons on the Edit Toolbar.















The following toolbar buttons may display on the Edit Toolbar for a selected arc-based object:



Select Next Object selects nearby objects instead of the selected object. See [Selecting Objects on page 141](#).



Open Object opens the specification dialog for the selected object(s). See [Specification Dialogs on page 19](#).

-  **Copy/Paste** copies the selected object(s) to the system clipboard so they can be pasted elsewhere. See [Copying and Pasting Objects on page 117](#).
-  **Delete** deletes the selected object(s). See [Deleting Objects on page 187](#).
-  **Transform/Replicate Object** copies, moves, rotates, resizes, or reflects the selected object(s). See [Transform/Replicate Object Dialog on page 180](#).
-  **Point to Point Move** accurately moves the selected object(s). See [Point to Point Move on page 167](#).
-  **Center Object** centers an object along a wall within a room or relative to a cabinet fixture. See [Center Object on page 169](#).
-  **Reflect About Object** reflects the selected object(s) about another object. See [Reflecting Objects on page 177](#).
-  **View Drawing Group Edit Tools** modifies the selected object's place in the drawing order. See [Drawing Group Edit Tools on page 128](#).
-  **Add Break** adds a new corner or pivot point to the selected object. See [Add Break on page 172](#).
-  **Complete Break** breaks the selected object into two separate objects. See [Add Break on page 172](#).
-  **Reverse Direction** reverses the direction of the selected object(s). See [Reverse Direction on page 178](#).
-  **Convert Polyline** converts the object into a special polyline-based object. See [Convert Polyline on page 179](#).
-  **Change Line/Arc** changes an arc-based object to a line, or vice versa. See [Change Line/Arc on page 174](#).
-  **Intersect/Join Two Lines** joins two non-parallel lines or arcs. See [Intersect/Join Two Lines on page 174](#).
-  **Fillet Lines** creates an additional arc connecting two lines. See [Fillet Lines on page 174](#).
-  **Chamfer Lines** creates an additional edge connecting two lines. See [Chamfer Lines on page 175](#).

ARC CENTERS AND ENDS

 When working with arc-based objects or circles, it can be helpful to see their center points. Similarly, when snapping arcs together to form a polyline, seeing their endpoints can be helpful. Select **View > Arc Centers and Ends** to toggle the display of both on the current floor. You can also turn on their display in the CAD Defaults dialog. See [CAD Defaults Dialog on page 193](#).

Arc-based objects can be aligned using their center points. See [Aligning Arc Centers on page 170](#).

Editing Open Polyline-Based Objects

Open polyline-based objects are composed of individual line- and arc-based objects that are connected at their end points but do not form an enclosed area. See [Polylines on page 214](#).

Objects are considered open polyline-based when they can be edited similar to open CAD polylines using their edit handles.

Open CAD polylines, connected walls, stairs, and connected roads are examples of open polyline-based objects.

For information about editing closed polyline-based objects, see [Editing Closed Polyline-Based Objects on page 155](#).

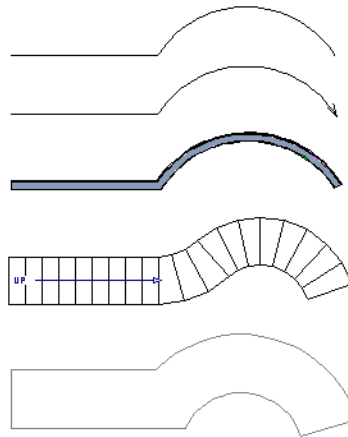

Other objects, such as connected stair and road segments, have additional edit handles that allow you to concentrically adjust the width of all segments of the object.

 If Connect CAD Segments is disabled, clicking on a CAD polyline edge selects the individual edge rather than the entire polyline. See [Disconnect Edges on page 142](#).

USING THE EDIT HANDLES

A polyline can be composed of many segments. See [Polylines on page 214](#).

When selected, an open polyline-based object displays a Move handle, a Rotate handle, a Reshape handle at the intersection of each segment, and an Extend handle at each end.

Each straight, line-based segment also has a Move edit handle along its length.

Each curved, arc-based segment has its own Move handle at the center of its chord, a Resize handle and, if it has an unlocked center, a Reshape handle. See [Editing Arc-Based Objects on page 147](#).

When a polyline is selected, the edge that you click nearest is called the selected edge, and certain operations affect only this edge. The Move handle of the selected edge is larger than that of other edges. It displays along the length of a line segment, or at the center of the chord on an arc segment. See [Selected Edge on page 142](#).

Any action performed using the edit handles can be canceled by pressing the Esc key or any two mouse buttons at the same time.

 The behavior of the edit handles depends on the currently active Edit Behavior. See [Defaults, Preferences, and Edit Behaviors on page 137](#).

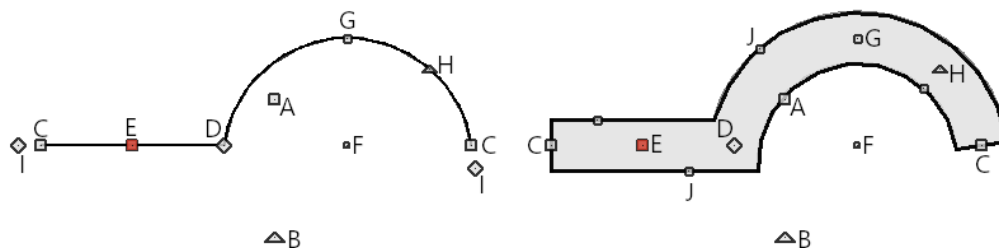

A. Move

- Click and drag the Move handle to move the object according to the currently active **Edit Behavior** .
- Movement may be limited or stopped by other objects or Snap Behaviors. Move restrictions can be overridden by holding down the Ctrl key while dragging. See [Unrestricted Movement on page 166](#).

B. Rotate

- The **Rotate** handle is used to rotate the object, either about its center or about the current CAD point. Its position varies depending on which edge is currently selected. See [Rotating Objects on page 175](#).

C. Extend

- Click and drag an Extend handle to lengthen or shorten the unconnected end of the selected line or arc segment, or to change the radius of the selected arc. See [Editing Arc-Based Objects on page 147](#).
- Right-click and drag it to change the adjacent line into an arc, or vice versa. See [Alternate on page 138](#).

D. Reshape

- Click and drag a Reshape edit handle to change the angle and/or length of the segments on either side of it, or the size of the object, depending on the currently active **Edit Behavior** .

E. Move Line Segment

- The **Move Line Segment** edit handle is found on straight segments of open polylines and moves the straight section according to the currently active **Edit Behavior** . Adjacent segments may extend or contract in their original directions to maintain their connections.

F. Move Arc

- Click and drag the Move Arc edit handle to change the radius and/or chord length or position, depending on the currently active **Edit Behavior**  and whether the arc has a locked center. Adjacent segments may extend, contract, or change angle to maintain their connections.

G. Resize Arc

- Click and drag the Resize Arc edit handle to change the radius, chord length and chord position of the arc segment, depending on the currently active **Edit Behavior**  and whether the arc has a locked center. Adjacent segments may extend, contract, or change angle to maintain their connections.

H. Reshape Arc

- Click and drag the Reshape Arc edit handle to change the radius of the arc without moving its end points. Only available if the arc has an unlocked center.

I. Same Line Type

- Drag a diamond-shaped end handle in any direction to draw a new line that shares the original polyline's color, weight, line style, and layer. See [Same Line Type Edit Handles on page 202](#).

J. Adjust Width

Some open polyline-based objects, such as stairs and roads, have additional handles that allow the width of the object to be adjusted.

- Click and drag a small, round edit handle to increase or decrease the object's width. By default, objects are resized in 1" increments. This Snap Unit is defined in the Plan Defaults dialog. See [General Plan Defaults Dialog on page 56](#).

USING DIMENSIONS

 Dimensions can be used to move or reshape polyline-based objects. See *Moving Objects Using Dimensions* on page 332.

USING THE SPECIFICATION DIALOG

 Open polyline-based objects can be edited using their specification dialogs. See *Polyline Specification Dialog* on page 215.

USING THE EDIT TOOLBAR

A selected open polyline-based object can be edited in a variety of ways using the buttons on the Edit Toolbar.

The following toolbar buttons may display on the Edit Toolbar for a selected open polyline-based object:



Select Next Object selects nearby objects instead of the selected object. See *Selecting Objects* on page 141.



Open Object opens the specification dialog for the selected object(s). See *Specification Dialogs* on page 19.



Copy/Paste copies the selected object(s) to the system clipboard so they can be pasted elsewhere. See *Copying and Pasting Objects* on page 117.



Delete deletes the selected object(s). See *Deleting Objects* on page 187.



Disconnect Selected Edge disconnects the selected edge of the polyline, turning it into a separate object. See *Disconnect Edges* on page 142.



Transform/Replicate Object copies, moves, rotates, resizes, or reflects the selected object(s). See *Transform/Replicate Object Dialog* on page 180.



Make Parallel/Perpendicular makes the selected straight edge parallel or perpendicular to another straight edge. See *Make Parallel/Perpendicular* on page 169. Not available when the selected edge is an arc.



Point to Point Move accurately moves the selected object(s). See *Point to Point Move* on page 167.



Center Object centers an object along a wall within a room or relative to a cabinet fixture. See *Center Object* on page 169.



Reflect About Object reflects the selected object(s) about another object. See *Reflecting Objects* on page 177.



View Drawing Group Edit Tools modifies the selected object's place in the drawing order. See *Drawing Group Edit Tools* on page 128.



Add Break adds a new corner or pivot point to the selected object. See *Add Break* on page 172.



Complete Break breaks the selected object into two separate objects. See *Add Break* on page 172.



Reverse Direction reverses the direction of the selected object(s). See *Reverse Direction* on page 178.



Close Polyline converts the selected open polyline into a closed polyline. See *Close Polyline* on page 155.



Convert Polyline converts the object into a special polyline-based object. See *Convert Polyline* on page 179.



Change Line/Arc changes a line-based polyline edge to an arc, or vice versa. See *Change Line/Arc* on page 174.



Intersect/Join Two Lines joins two a non-parallel lines or arcs. See [Intersect/Join Two Lines on page 174](#).



Fillet Lines creates an arc connecting two non-parallel lines. See [Fillet Lines on page 174](#). Cannot be used if the adjacent edge is an arc.



Chamfer Lines creates a line connecting two non-parallel lines. See [Chamfer Lines on page 175](#).

CLOSE POLYLINE



An open polyline-based object can be converted into a closed polyline using the **Close Polyline** edit tool. This tool adds an edge to the open polyline, connecting its two ends and closing the gap between them.

Close Polyline is not available when **Connect CAD Segments**  is enabled. See [Disconnect Edges on page 142](#).

Editing Closed Polyline-Based Objects

Closed polyline-based objects are composed of individual line- and arc-based objects joined end-to-end and forming an enclosed area. See [Polylines on page 214](#).

Objects are considered closed polyline-based when they can be edited similar to closed CAD polylines using their edit handles.

Closed CAD polylines, slabs and roof planes are examples of closed polyline-based objects.

Some objects, notably walls, have closed polyline-based editing behavior only when they are selected on certain surfaces in 3D views. See [Editing Walls on page 244](#).

For information about editing open polyline-based objects, see [Editing Open Polyline-Based Objects on page 151](#).

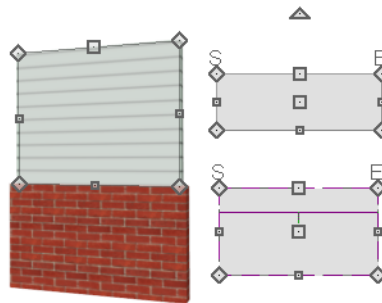

Other objects, such as connected road segments, have additional edit handles that allow you to concentrically adjust the width of all segments of the object.

 If **Connect CAD Segments** is disabled, clicking on a polyline edge selects the individual edge rather than the entire polyline. See [Disconnect Edges on page 142](#).

USING THE EDIT HANDLES

A polyline can be composed of many segments. See [Polylines on page 214](#).

When selected, a closed polyline-based object displays a Move handle, a Rotate handle, and a Reshape handle at the intersection of each segment.

Each straight, line-based segment has a Move edit handle along its length.

Each curved, arc-based segment has its own Move handle at the center of its chord, a Resize handle and, if it has an unlocked center, a Reshape handle. See [Editing Arc-Based Objects on page 147](#).

When a polyline is selected, the edge that you click nearest is called the selected edge, and certain operations affect only this edge. The Move handle of the selected edge is larger than that of other edges. It displays along the length of a line segment, or at the center of the chord on an arc segment. See [Selected Edge on page 142](#).

Any action performed using the edit handles can be canceled by pressing the Esc key or any two mouse buttons at the same time.

 The behavior of the edit handles may depend on the currently active Edit Behavior. See [Defaults, Preferences, and Edit Behaviors on page 137](#).

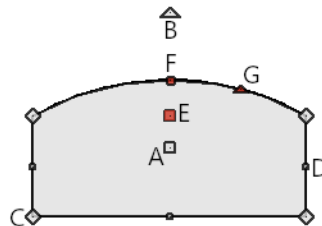

A. Move

- Click and drag the Move handle to move the object according to the currently active **Edit Behavior** .
- Movement may be limited or stopped by other objects or Snap Behaviors. Move restrictions can be overridden by holding down the Ctrl key while dragging. See [Unrestricted Movement on page 166](#).

B. Rotate

- The **Rotate** handle is used to rotate the object, either about its center or about the current CAD point. Its position varies depending on which edge is currently selected. See [Rotating Objects on page 175](#).

C. Reshape

- Click and drag a Reshape edit handle to change the angle and/or length of the segments on either side of it, or the size of the object, depending on the currently active **Edit Behavior** .

D. Move Line Segment

- The **Move Line Segment** edit handle is found on straight segments of closed polylines and moves the straight section according to the currently active **Edit Behavior** . Adjacent segments may extend or contract in their original directions to maintain their connections.

E. Move Arc

- Click and drag the Move Arc edit handle to change the radius and/or chord length or position, depending on the currently active **Edit Behavior**  and whether the arc has a locked center. Adjacent segments may extend, contract, or change angle to maintain their connections.

F. Resize Arc

- Click and drag the Resize Arc edit handle to change the radius, chord length and chord position of the arc segment, depending on the currently active **Edit Behavior**  and whether the arc has a locked center. Adjacent segments may extend, contract, or change angle to maintain their connections.

G. Reshape Arc

- Click and drag the Reshape Arc edit handle to change the radius of the arc without moving its end points. Only available if the arc has an unlocked center.

USING DIMENSIONS



Dimensions can be used to move or reshape closed polyline-based objects. See [Moving Objects Using Dimensions on page 332](#).

USING THE SPECIFICATION DIALOG



Closed polyline-based objects can be edited using their specification dialogs. See [Polyline Specification Dialog on page 215](#).

USING THE EDIT TOOLBAR

A selected closed polyline-based object can be edited in a variety of ways using the buttons on the Edit Toolbar.

The following toolbar buttons may display on the Edit Toolbar for a selected closed polyline-based object:



Select Next Object selects nearby objects instead of the selected object. See [Selecting Objects on page 141](#).



Open Object opens the specification dialog for the selected object(s). See [Specification Dialogs on page 19](#).



Copy/Paste copies the selected object(s) to the system clipboard so they can be pasted elsewhere. See [Copying and Pasting Objects on page 117](#).



Delete deletes the selected object(s). See [Deleting Objects on page 187](#).



Disconnect Selected Edge disconnects the selected edge of the polyline, turning it into a separate object. See [Disconnect Edges on page 142](#).



Transform/Replicate Object copies, moves, rotates, resizes, or reflects the selected object(s). See [Transform/Replicate Object Dialog on page 180](#).



Make Parallel/Perpendicular makes the selected straight edge parallel or perpendicular to another straight edge by either rotating the selected edge or the entire polyline. See [Make Parallel/Perpendicular on page 169](#). Not available when the selected edge is an arc.



Point to Point Move accurately moves the selected object(s). See [Point to Point Move on page 167](#).



Center Object centers an object along a wall within a room or relative to a cabinet fixture. See [Center Object on page 169](#).



Reflect About Object reflect the selected object(s) about another object. See [Reflecting Objects on page 177](#).



View Drawing Group Edit Tools modifies the selected object's place in the drawing order. See [Drawing Group Edit Tools on page 128](#).



Add Break adds a new corner or pivot point to the selected object. See [Add Break on page 172](#).



Complete Break breaks an edge of the selected object into two separate objects. See [Add Break on page 172](#).



Reverse Direction reverses the direction of the selected object(s). See [Reverse Direction on page 178](#).



Convert Polyline converts the object into a special polyline-based object. See *Convert Polyline on page 179*.



Change Line/Arc changes a line-based polyline edge to an arc, or vice versa. See *Change Line/Arc on page 174*.



Intersect/Join Two Lines joins two non-parallel lines or arcs. See *Intersect/Join Two Lines on page 174*.



Fillet Lines creates an arc connecting two non-parallel lines. See *Fillet Lines on page 174*. Cannot be used if the adjacent edge is an arc.



Chamfer Lines creates a straight line between two non-parallel lines. See *Chamfer Lines on page 175*.

Editing Box-Based Objects

Objects are considered box-based when they can be edited similar to CAD boxes using their edit handles.

Box-based objects are similar to closed polyline-based objects, but must always have four sides with right-angled corners.

In addition to the CAD Box tools, Text objects, many library symbols, pictures and images are examples of box-based objects.

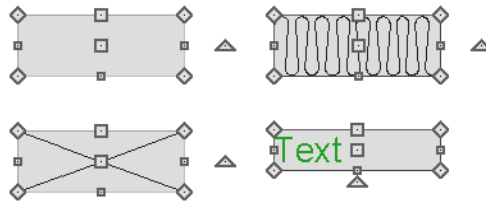



USING THE EDIT HANDLES

When selected, a box-based object displays ten edit handles. Unlike polylines, boxes must always have four sides with right-angled corners.

Any action performed using the edit handles can be canceled by pressing the Esc key or any two mouse buttons at the same time.

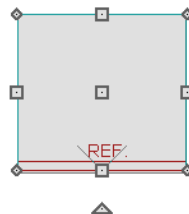
 The behavior of the edit handles may depend on the currently active Edit Behavior. See *Defaults, Preferences, and Edit Behaviors on page 137*.



- Click and drag the Move handle to move the object according to the currently active **Edit Behavior** . See *Defaults, Preferences, and Edit Behaviors on page 137*.

Movement may be limited or stopped by other objects or Snap Behaviors. Move restrictions can be overridden by holding down the Ctrl key while dragging. See *Unrestricted Movement on page 166*.

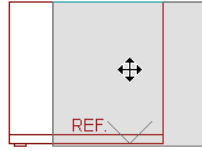

- The four **Resize** handles located at each corner are used to increase or decrease the size of the object.

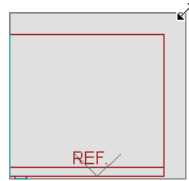

- The four **Extend** handles display along each edge. If you select an object on an edge, the Extend handle displays at the point where you clicked; otherwise, it displays at the center of the edge.

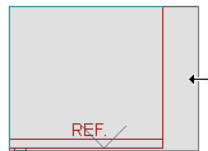

- The triangular **Rotate** handle located near the selected edge of the object is used to rotate it either about its center or the current CAD point. The pointer changes to a circular arrow  when moved over this handle. See *Rotating Objects on page 175*.

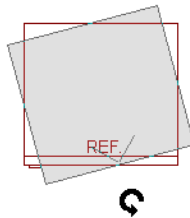

USING DIMENSIONS



Dimensions can be used to move or reshape box-based objects. See *Moving Objects Using Dimensions on page 332*.

USING THE SPECIFICATION DIALOG



Box-based objects can be edited using their specification dialogs. See *Box Specification Dialog on page 218*.

USING THE EDIT TOOLBAR

A selected box-based object can be edited in a variety of ways using the buttons on the Edit Toolbar.

The following toolbar buttons may display on the Edit Toolbar for a selected box-based object:



Select Next Object selects nearby objects instead of the selected object. See *Selecting Objects on page 141*.



Open Object opens the specification dialog for the selected object(s). See *Specification Dialogs on page 19*.



Copy/Paste copies the selected object(s) to the system clipboard so they can be pasted elsewhere. See [Copying and Pasting Objects on page 117](#).



Delete deletes the selected object(s). See [Deleting Objects on page 187](#).



Transform/Replicate Object copies, moves, rotates, resizes, or reflects the selected object(s). See [Transform/Replicate Object Dialog on page 180](#).



Make Parallel/Perpendicular makes the selected straight edge parallel or perpendicular to another straight edge. Not available when the selected edge is an arc. See [Make Parallel/Perpendicular on page 169](#).



Point to Point Move accurately moves the selected object(s). See [Point to Point Move on page 167](#).



Center Object centers an object along a wall within a room or relative to a cabinet fixture. See [Center Object on page 169](#).



Reflect About Object reflects the selected object(s) about another object. See [Reflecting Objects on page 177](#).



View Drawing Group Edit Tools modifies the selected object's place in the drawing order. See [Drawing Group Edit Tools on page 128](#).



Convert Polyline converts the object into a special polyline-based object. See [Convert Polyline on page 179](#).

Editing Spline-Based Objects

A Spline is a curve that passes smoothly through a set of points, or vertices. Splines are typically used in situations where an irregular, free-flowing curve is needed.

Objects are considered spline-based when they can be edited similar to CAD splines using their edit handles. See [Splines on page 219](#).

Sprinkler lines, spline terrain curbs, spline terrain walls and both round and kidney-shaped terrain features are spline-based objects. See [Terrain on page 846](#).



USING THE EDIT HANDLES

When a spline is selected, several different types of handles display.

Any action performed using the edit handles can be canceled by pressing the Esc key or any two mouse buttons at the same time.



The behavior of the edit handles may depend on the currently active Edit Behavior. See [Defaults, Preferences, and Edit Behaviors on page 137](#).

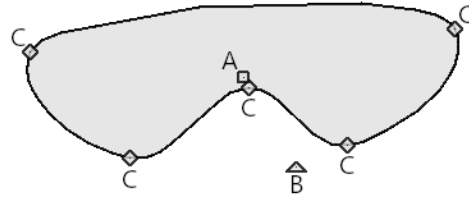

A. Move

- Click and drag the Move handle to move the object according to the currently active **Edit Behavior** . See *Defaults, Preferences, and Edit Behaviors on page 137*.
- Movement may be limited or stopped by other objects or Snap Behaviors. Move restrictions can be overridden by holding down the Ctrl key while dragging. See *Unrestricted Movement on page 166*.

B. Rotate

- Click and drag the Rotate edit handle to rotate the entire spline.

C. Vertex

- The Vertex edit handles display along the spline at each vertex. Click and drag a Vertex edit handle to change the length, angle and curve of adjacent segments without affecting other vertices.

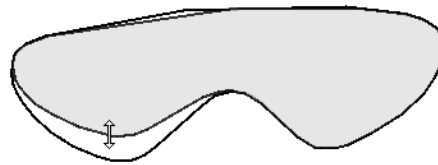

Same Line Type

- Drag a diamond-shaped end handle in any direction to draw a new spline segment that shares the original spline's color, weight, line style, and layer. See *Same Line Type Edit Handles on page 202*.



USING THE SPECIFICATION DIALOG

 Spline-based objects can be edited using their specification dialogs. See *Polyline Specification Dialog on page 215*.

USING THE EDIT TOOLBAR

A selected spline-based object can be edited in a variety of ways using the buttons on the Edit Toolbar.

The following toolbar buttons may display on the Edit Toolbar for a selected spline-based object:













Select Next Object selects nearby objects instead of the selected object. See *Selecting Objects on page 141*.



Open Object opens the specification dialog for the selected object(s). See *Specification Dialogs on page 19*.



Copy/Paste copies the selected object(s) to the system clipboard so they can be pasted elsewhere. See *Copying and Pasting Objects on page 117*.



-  **Delete** deletes the selected object(s). See [Deleting Objects on page 187](#).
-  **Transform/Replicate Object** copies, moves, rotates, resizes, or reflects the selected object(s). See [Transform/Replicate Object Dialog on page 180](#).
-  **Make Parallel/Perpendicular** makes the selected spline edge parallel or perpendicular to another straight edge. See [Make Parallel/Perpendicular on page 169](#).
-  **Point to Point Move** accurately moves the selected object(s). See [Point to Point Move on page 167](#).
-  **Center Object** centers an object along a wall within a room or relative to a cabinet fixture. See [Center Object on page 169](#).
-  **Reflect About Object** reflects the selected object(s) about another object. See [Reflecting Objects on page 177](#).
-  **View Drawing Group Edit Tools** modifies the selected object's place in the drawing order. See [Drawing Group Edit Tools on page 128](#).
-  **Add Break** adds a new corner or pivot point to the selected object. See [Add Break on page 172](#).
-  **Complete Break** breaks an edge of the selected object into two separate objects. See [Add Break on page 172](#).
-  **Reverse Direction** reverses the direction of the selected object(s). See [Reverse Direction on page 178](#).
-  **Convert Polyline** converts the object into a special polyline-based object. See [Convert Polyline on page 179](#).

Editing Circles, Ovals and Ellipses

 Objects created using the **Circle Tools** are unusual in that no architectural objects share their functionalities.

USING THE EDIT HANDLES

When selected, circles, ovals and ellipses display eleven edit handles.

Unlike **Ovals**  and **Ellipses** , a **Circle**  cannot be edited into any other shapes; it can only be a circle.

Any action performed using the edit handles can be canceled by pressing the Esc key or any two mouse buttons at the same time.

 The behavior of the edit handles may depend on the currently active Edit Behavior. See [Defaults, Preferences, and Edit Behaviors on page 137](#).

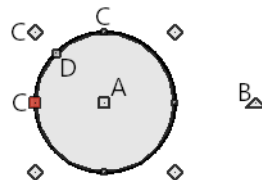

- A. Move
- B. Rotate
- C. Reshape
- D. Concentric Resize

Move

- Click and drag the Move handle to move the object according to the currently active **Edit Behavior** . See *Defaults, Preferences, and Edit Behaviors on page 137*.
- Movement may be limited or stopped by other objects or Snap Behaviors. Move restrictions can be overridden by holding down the Ctrl key while dragging. See *Unrestricted Movement on page 166*.

Rotate

- Click and drag the Rotate handle of an oval or ellipse to change its orientation.

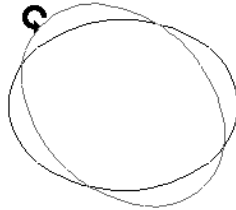

Reshape

- The eight edit handles beyond the perimeter are Reshape edit handles. Move them in or out to resize and reshape an oval or ellipse.

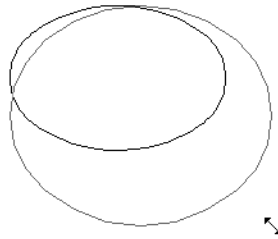

- Unlike ovals and ellipses, circles cannot be reshaped. When a Reshape handle is dragged on a circle, it is only resized.

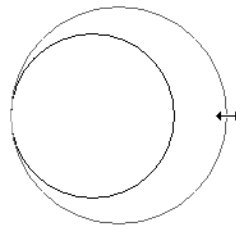

Concentric Resize

- The Concentric Resize edit handle displays on the perimeter of a circle between a corner Reshape handle and the center. Click and drag this handle to resize the circle without moving its center point.

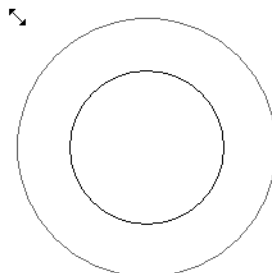

USING DIMENSIONS



Dimensions can be used to move or resize circle-based objects. See [Moving Objects Using Dimensions on page 332](#).

USING THE SPECIFICATION DIALOG



Circles, ovals and ellipses can be edited using their specification dialogs. See [Circle/Oval/Ellipse Specification Dialog on page 213](#).

USING THE EDIT TOOLBAR

A selected circle, oval or ellipse can be edited in a variety of ways using the buttons on the Edit Toolbar.

The following toolbar buttons may display on the Edit Toolbar for a selected circle, oval or ellipse:



Select Next Object selects nearby objects instead of the selected object. See [Selecting Objects on page 141](#).



Open Object opens the specification dialog for the selected object(s). See [Specification Dialogs on page 19](#).



Copy/Paste copies the selected object(s) to the system clipboard so they can be pasted elsewhere. See [Copying and Pasting Objects on page 117](#).



Delete deletes the selected object(s). See [Deleting Objects on page 187](#).



Transform/Replicate Object copies, moves, rotates, resizes, or reflects the selected object(s). See [Transform/Replicate Object Dialog on page 180](#).



Make Parallel/Perpendicular makes the selected edge parallel or perpendicular to another straight edge. See [Make Parallel/Perpendicular on page 169](#).



Point to Point Move accurately moves the selected object(s). See [Point to Point Move on page 167](#).



Center Object centers an object along a wall within a room or relative to a cabinet fixture. See [Center Object on page 169](#).



Reflect About Object reflects the selected object(s) about another object. See [Reflecting Objects on page 177](#).



View Drawing Group Edit Tools modifies the selected object's place in the drawing order. See [Drawing Group Edit Tools on page 128](#).



Convert Polyline converts the object into a special polyline-based object. See [Convert Polyline on page 179](#).

Editing Multiple Objects

There are a couple of options for accurately and efficiently editing multiple objects at once. See [Selecting Multiple Objects on page 143](#).

DYNAMIC DEFAULTS

Dynamic defaults are a useful way to apply certain attributes to multiple objects of the same type throughout a plan. They are found in the defaults dialogs for a variety of different architectural objects, and when these default values are changed, all objects that are set to use them throughout the current plan will update automatically. Dynamic defaults are particularly valuable for applying critical defaults like ceiling heights and floor structure. See [Dynamic Defaults on page 55](#).

IN THE SPECIFICATION DIALOG

When multiple objects are selected, the **Open Object** edit button is often available. The settings available in a shared specification dialog will vary, depending on the types of objects that are selected. If the objects are of the same type, their shared specification dialog will have many of the settings that their individual specification dialogs have; if they are not similar, the dialog may have only a few settings. When multiple objects are selected, their shared specification dialog may also have settings in a “No Change” state. See [Specification Dialogs on page 19](#).

USING THE EDIT TOOLBAR

Group-selected objects can also be edited using the buttons on edit toolbar. The available tools will vary, depending on which types of objects are selected. See [The Edit Toolbar on page 91](#).

Moving Objects

Objects can be moved using the edit handles as well as a variety of edit tools. Multiple selected objects can also be moved as a group. See [Selecting Objects on page 141](#).

USING THE EDIT HANDLES



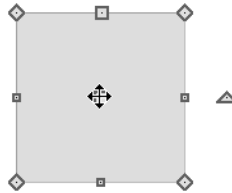



Select an object, then click the **Move** edit handle and drag it to a new location. When your pointer is over the Move handle, it displays a four-headed arrow .



As an object is moved, it jumps at set increments when **Grid Snaps**  are enabled. See [Grid Snaps on page 115](#).

When **Object Snaps**  are enabled, a selected object snaps to its original location if it passes over that location while being moved.

The behavior of the Move edit handle varies depending on the currently active **Edit Behavior** . See [Defaults, Preferences, and Edit Behaviors on page 137](#).

- If the **Default** , **Resize** , **Concentric**  or **Fillet**  edit behavior is active, the object moves orthogonal, or at a right angle to, any of its edges.
- If the **Alternate** **Alt**  edit behavior is active, the selected object(s) can be moved at Allowed Angles if **Angle Snaps**  are enabled, or orthogonal to any of its edges if they are not. See [Alternate on page 138](#).

You can temporarily slow the movement of your mouse as you drag an edit handle by holding down the Shift key on your keyboard.

BUMPING/PUSHING

 When **Edit> Snap Settings> Bumping/Pushing** is enabled, architectural objects will bump into and can push one another as they are moved. This setting also affects CAD and CAD-based objects with **CAD Stops Move** and/or **Wall Stops Move** enabled. See [Line Style Panel on page 204](#).

When an object bumps into another object while it is being moved, it stops. If you do not release the mouse button and continue to drag, however, the selected object resumes movement and continues past the obstructing object.

Instead of dragging through and past obstructing objects, you can instead push them. To do this, bump an object into an obstructing object and release the mouse button. Then, click and drag the Move edit handle a second time in the same direction.

Walls, wall openings, cabinets, furnishings and fixtures, and CAD and CAD-based objects are examples of objects that can bump into as well as push other objects.

By default, **Bumping/Pushing**  does not affect objects moved using dimensions. See [Moving Objects Using Dimensions on page 332](#).

The **Maximum Bump Distance**, which is the distance you must drag to override bumping, is set in the Preferences dialog. **Bumping/Pushing for Type-in Movement** can also be enabled there. See [Snap Properties Panel on page 78](#).

Certain types of objects, notably roof planes, and objects on locked layers can be bumped but cannot be pushed. See [Layer Display Options Dialog on page 126](#).

CAD STOPS MOVE/WALL STOPS MOVE

CAD and CAD-based objects can be set to stop at other CAD objects and/or at walls as they are being moved. See [Line Style Panel on page 204](#).

Some objects, such as cross boxes, framing members and insulation, are automatically set to stop when moved against other CAD objects.

CAD Stops Move and **Wall Stops Move** do not function if **Bumping/Pushing**  is turned off.

UNRESTRICTED MOVEMENT

Many objects have restrictions placed on their movement by their own properties or specification settings. Architectural objects, for example, bump into other 3D objects as they are being moved when **Bumping/Pushing**  is enabled.

CAD-based objects can be set to stop at other CAD objects or at walls. See [Line Style Panel on page 204](#).

Other move restrictions are activated by the **Snap Settings** . See [Snap Behaviors on page 112](#).

These restrictions can be overridden when necessary by holding down the Ctrl key while dragging to move an object.

To move an object freely

1. Select the object.
2. Hold down the Ctrl key.
3. Click the Move edit handle and drag it to the new location.

You can also press the Ctrl key while dragging an object's Move handle to override move restrictions.

NUDGING

You can use the arrow keys on your keyboard to move a selected object or objects by single **Snap Grid** increments in 2D and 3D views. This is referred to as nudging. See [Grid Snaps on page 115](#).

In Plan View

To nudge an object in plan view, select it and press any of the four arrow keys: Up, Down, Left, or Right. These directions are relative to the Snap Grid: if **Rotate Plan View**  is used to rotate plan view, the definitions of up, down, left, and right are affected. See [Rotate Plan View on page 103](#).

In 3D Views

In 3D views, nudging is relative to the selected surface. If, for example, you select the front of a cabinet in 3D and nudge it to the left, it will move to the left in plan view. If you instead select the back of a cabinet in 3D and nudge it to the left, it will move to the right in plan view.

When multiple objects are selected, the surface that was clicked on last is considered the selected surface. When nudged, all selected objects will move relative to that surface. See [Shift and Ctrl Select on page 144](#).

If an object is rotated, the directions that it can be nudged in 2D are not affected; however, in 3D, they are. If, for example, a cabinet is rotated 45°, it will nudge to the left as defined by the Snap Grid in plan view. When nudged in 3D, however, it will move at a 45° angle to the Snap Grid: or parallel to the selected surface.





POINT TO POINT MOVE



The **Point to Point Move** edit button allows a selected object or group of objects to be accurately moved.

The Point to Point Move tool is often most effective when used in combination with Object Snaps. Bear in mind that it is also affected by Grid Snaps, and that in some situations you may want to toggle snaps off. See [Snap Behaviors on page 112](#).

To use Point to Point Move

1. Select one or more objects that you would like to move, then click the **Point to Point Move**  edit button.
2. A temporary CAD point  preview follows the mouse pointer, which displays the Point A  icon. Click on a point that you want to accurately reposition: a temporary point is placed at that location.
3. An extension line extends from Point A to the mouse pointer, which now displays the Point B  icon and is followed by another temporary point preview.
4. Click on the point in the plan where you would like the selected point to be relocated when it is moved.
5. The selected object(s) are moved so that they maintain their position relative to the point and both temporary points are deleted.

To retain a copy of the selected object(s) in the original location, the **Copy/Paste**  edit button before clicking the **Point to Point Move** button. See [To use Copy/Paste with other edit tools on page 119](#).

Point to Point Move can also be used with the **Edit Area**  tools. See [Edit Area Tools on page 182](#).

USING CENTER OBJECT



The **Center Object** edit button allows you to move walls, cabinets and other objects so that they are centered along a wall within a room or relative to a window or cabinet. See [Center Object on page 169](#).

MOVE TO FRAMING REFERENCE



Framing members can be positioned relative to a Framing Reference using the **Move to Framing Reference** edit tool. See [Framing Reference Markers on page 628](#).

USING DIMENSIONS



- Objects or the selected edges of some objects can be moved using dimensions. See [Moving Objects Using Dimensions on page 332](#).

When **Bumping/Pushing for Type-in Movement** is checked in the Preferences dialog, adjacent objects can be pushed when an object is moved using dimensions.

Note: By default, objects moved using dimensions are not subject to Bumping/Pushing. See [Bumping/Pushing on page 166](#).

USING THE TRANSFORM/REPLICATE OBJECT DIALOG



- Objects and groups of objects can be moved relative to themselves or an absolute location using the Transform
 - Replicate Object dialog. See [Transform/Replicate Object Dialog on page 180](#).

Aligning Objects

It is often important to align objects such as text boxes, roof plane edges, or walls, or to align objects on different floors. There are several methods to choose from.

USING THE CROSSHAIRS

Objects can be aligned by eye using the mouse pointer crosshairs as a reference. This method can help you draw, place and edit objects quickly, easily, and with reasonable accuracy, but is not necessarily as accurate as some of the other approaches described here. See [Crosshairs on page 15](#).

The mouse pointer crosshairs can be turned on and off and their size and aperture set in the Preferences dialog. See [Edit Panel on page 75](#).

USING SNAP SETTINGS



- With **Object Snaps** on, you can snap the edge of a selected object to that of another. Select an edge of an object. Drag it to the edge of another object to reveal an Object Snap point, then release the mouse.



- With **Grid Snaps** on and **Angle Snaps** off, select the left side of the object, and drag from the center move handle. This snaps the selected side to the grid.

When both **Grid Snaps** and **Angle Snaps** on, objects snap at increments equal to the **Snap unit** specified in the Plan Defaults dialog rather than onto the grid itself. This does not align objects to the grid unless they were already snapped to the grid. See [Snap Behaviors on page 112](#).

USING DIMENSIONS



- Create a temporary or manual dimension relative to an object such as a wall or line, and relocate the objects to the same dimension. See [Moving Objects Using Dimensions on page 332](#).



Text objects can be aligned using settings in the Text Specification dialog. See [Aligning Text on page 349](#).

CAD STOPS MOVE/WALL STOPS MOVE

CAD and CAD-based objects can be aligned using another CAD object or a wall as a guide. Check the **CAD Stops Move** and/or **Wall Stops Move** boxes in the objects' specification dialogs, then move them until they bump into the CAD object or wall that you wish to use as a guide for alignment. See [Line Style Panel on page 204](#).

MAKE PARALLEL/PERPENDICULAR



The **Make Parallel/Perpendicular** edit button allows you to make a selected object parallel or perpendicular to any straight line or edge.

If you select an edge of a polyline-based object, adjacent edges extend or contract to maintain contact, but other edges remain unchanged. The selected edge rotates about its endpoint if selected near the end, or about its center if you click within its middle third.

A few objects, such as camera symbols, are not eligible to be used as an axis for the **Make Parallel/Perpendicular** tool.

To use Make Parallel/Perpendicular

1. Select an object such as a roof plane on the edge that you would like to make parallel or perpendicular to another object.
 - Click near the center of the edge to rotate it about the center.
 - Click near an end to rotate the edge about that end.
2. Click the **Make Parallel/Perpendicular**  edit button.
3. Click on a straight edge of an eligible object such as a wall.
4. If the first object is within 45° of parallel to the second object, it is made parallel. Otherwise, it is made perpendicular to the second object.

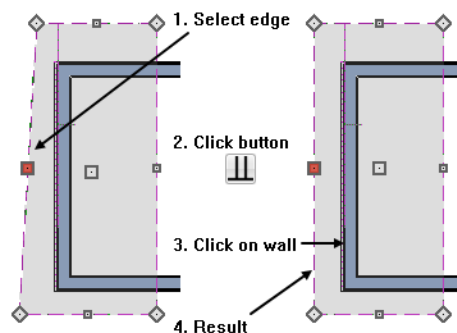

You can also make the selected edge parallel by rotating the entire object. See [Make Parallel/Perpendicular with Polyline-Based Objects on page 177](#).

CENTER OBJECT



The **Center Object** edit button can be used to center a variety of objects either relative to another object. Center Object can be used to center architectural objects in plan view, cross section/elevation, and 3D views. It can also be used to center CAD objects in plan view, cross section/elevation views, and layout.

A few objects, such as camera symbols, are not eligible to be used as a centering axis.

To center an object

1. Select an object.
2. Click the **Center Object**  edit button.
3. Move the mouse pointer over the object you would like to center the selected object relative to.
 - As the pointer passes over an eligible object, it becomes highlighted and a dashed centering axis line displays.
4. When the desired centering axis displays, click once to center the selected object along that axis line.

To center an object in a room

1. Select an object such a cabinet.
2. Click the **Center Object**  edit button.
3. Move the mouse pointer in the room that you would like to center the selected object relative to.
 - As you move the pointer, a centering axis will display along the wall it is closest to.
 - The selected object does not have to be inside a room in order to be centered relative to that room.
4. When a centering axis displays along the correct wall, click once.
5. The object is moved perpendicular to the centering axis.
 - As you move the pointer, a centering axis will display along the wall it is closest to.
 - The selected object does not have to be inside a room in order to be centered relative to that room.
6. When a centering axis displays along the correct wall, click once.
7. The object is moved perpendicular to the centering axis.

If you click outside an exterior wall instead of clicking inside, the selected object is centered along the edge of the Exterior Room. See [The Exterior Room on page 285](#).



To retain a copy of the selected object(s) in the original location, the **Copy/Paste**  edit button before clicking the **Center Object** button. See [To use Copy/Paste with other edit tools on page 119](#).

ALIGNING ARC CENTERS

The center points of circles and arc-based objects can be aligned, even if the objects are on different floors, when the Reference Display is turned on and **Arc Centers and Ends**  is toggled on. Note that Arc Centers and Ends is a floor-specific toggle. See [The Reference Display](#) and [Arc Centers and Ends on page 151](#).

To align center points easily, it is helpful to turn on **Object Snaps**  and turn off **Angle Snaps** . See [Object Snaps on page 113](#) and [Angle Snaps on page 114](#).

ALIGNING OBJECTS ON DIFFERENT FLOORS

Objects on different floors can be aligned with one another using **Object Snaps**  and the **Reference Display** . See [Object Snaps on page 113](#) and [The Reference Display](#).

Resizing Objects

Objects can be resized using the edit handles, specification dialogs, and the Transform/Replicate Object dialog.

USING THE EDIT HANDLES

Depending on the currently active **Edit Behavior** , the end, corner and/or side edit handles can be used to resize a selected object. See *Defaults, Preferences, and Edit Behaviors on page 137*.

When the **Concentric**  edit behavior is active, dragging an object's corner or end handle resizes it according to the **Concentric Jump** value set in the Preferences dialog. See *Concentric on page 139*.

Objects can be resized about either their center points or the current CAD point. See *Rotate/Resize About on page 176*.

To override any movement restrictions caused by snap settings or the presence of other objects, press the Ctrl key while dragging an edit handle.

As an object is resized, any dimensions indicating its size will update to reflect your changes. You can use dimensions as references to help you achieve the correct size for most objects.

You can temporarily slow the movement of your mouse as you drag an edit handle by holding down the Shift key on your keyboard.

USING THE SPECIFICATION DIALOG



Most objects can be accurately resized in their specification dialogs. See *Specification Dialogs on page 19*.

USING DIMENSIONS



Many objects can be resized by selecting an edge and then moving that edge using dimensions. See *Moving Objects Using Dimensions on page 332*.

Walls can also be resized using dimensions; however, it is important to understand that the selected edges of other objects cannot be resized using dimensions - they can only be moved. To resize an edge, select an adjacent edge and move that edge instead.

USING THE TRANSFORM/REPLICATE OBJECT DIALOG



Most objects can be resized about either their centers or an absolute point using the Transform Replicate Object dialog. See *Transform/Replicate Object Dialog on page 180*.

Reshaping Objects

There is a variety of ways to reshape objects using the edit handles, specification dialogs and edit toolbar buttons.

Some objects, notably circles and box-based objects, cannot be reshaped - only resized. See *Resizing Objects on page 171*.

USING THE EDIT HANDLES

Depending on the **Edit Behavior**  in use, the end, corner and/or side edit handles can be used to reshape a selected object. See *Defaults, Preferences, and Edit Behaviors on page 137*.

When a line-based, arc-based, or open polyline-based object is selected, you can right-click and drag an end handle to change a line into an arc or vice versa. This behavior does not apply to closed polylines.

To override any movement restrictions caused by snap settings or the presence of other objects, press the Ctrl key while dragging an edit handle.

You can temporarily slow the movement of your mouse as you drag an edit handle by holding down the Shift key on your keyboard.

USING THE SPECIFICATION DIALOG

 A variety of CAD and CAD-based objects can be reshaped by editing values on either the **SELECTED LINE** or **SELECTED ARC** panel of their specification dialogs. See *Polyline Specification Dialog on page 215*.

USING DIMENSIONS

 Both temporary and manually drawn dimensions can be used to increase or decrease the distance between the edge a line- or polyline-based object and another, parallel edge or line. See *Moving Objects Using Dimensions on page 332*.

Angular Dimensions  can be used to adjust the angle where two polyline segments meet. See *Using Angular Dimensions on page 176*.





ADD BREAK



 The **Add Break** edit tool can be used to break an individual line-, arc-, or spline-based object into two segments. The edges of a polyline-based object can also be broken.

Note: The Add Break edit button is not available for box-based objects, objects created with the Circle Tools, North Pointers, Sun Angles, Joist Direction Lines, or some architectural objects such as stairs and trusses.

There are two types of breaks: partial and complete. A partial break creates a new corner or pivot point between two connected segments, while a complete break actually severs an edge into two disconnected segments.

To create a partial break

1. Select the object, object edge, or the centerline of the object that you want to add a pivot point or corner to.
2. Click the **Add Break**  edit button once or press the 3 key.
3. If you would like to create more than one break, click the **Sticky Mode**  edit button.
4. If you would like to move the edges of the object as you add breaks, click the **Edge Edit Handles**  edit button to toggle on their display.
5. If you want, you can click the **Corner Edit Handles**  edit button to toggle off their display.

6. Click the edge to create a new corner edit handle at that location and two separate edges on either side of that handle.
7. If you enabled **Sticky Mode** , continue clicking to place additional breaks.
8. Click the **Main Edit Mode**  edit button or press the Esc key to return to the selected object's main edit toolbar.







If you click and drag one of the edit handles on either side of the partial break, the edge moves at a right angle to itself and another edge forms, connecting the moved edge with the one on the other side that does not move.

You can remove an edge from a polyline-based object by clicking and dragging a corner handle until it snaps to an adjacent corner handle.

When a complete break is created, the object or edge is totally severed at that point.

With the exception of framing members, complete breaks cannot be created on CAD-based architectural objects. In the case of framing members, only complete breaks can be created.

To create a complete break

1. Click the object, object edge, or object centerline that you want to break into two segments.
2. Click the **Add Break**  edit button.
3. Click the **Complete Break**  edit button.
4. If you would like to create more than one complete break, click the **Sticky Mode**  edit button.
5. If you would like to move the edges of the object as you add breaks, click the **Edge Edit Handles**  edit button to toggle on their display
6. If you want, you can click the **Corner Edit Handles**  edit button to toggle off their display.
7. Click on an edge to create a complete break at that location.
8. If you enabled **Sticky Mode** , continue clicking to place additional breaks.
9. Click the **Main Edit Mode**  edit button or press the Esc key to return to the selected object's main edit toolbar.

The edge that you clicked on will be divided into two separate sections, one of which will be selected. You can now move or edit the selected edge completely independent of the object or edge on the other side of the break. Click on the other edge to select it instead.

When **Object Snaps**  are enabled, breaks can be placed at snap locations such as midpoints. See [Object Snaps on page 113](#).

To remove a break from an edge

1. Make sure that **Object Snaps**  are enabled. See [Object Snaps on page 113](#).
2. Select the object that has a break that you want to remove.
3. Click on the corner edit handle associated with the break that you want to remove and drag it to an adjacent corner handle.

- When you see an **Endpoint**  snap indicator, release the mouse button. The handle that you selected will be removed.

CHANGE LINE/ARC

 Select an individual line-based or arc-based object or a segment of a polyline-based object and click the **Change Line/Arc** edit button to convert the selected segment from a line to an arc or vice versa.

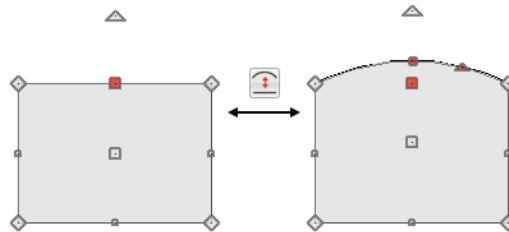

USING MAKE PARALLEL/PERPENDICULAR

 The **Make Parallel** edit button can be used to reshape a polyline by making a selected edge parallel or perpendicular to another straight edge. See [Make Parallel/Perpendicular on page 169](#).

INTERSECT/JOIN TWO LINES

 The **Intersect/Join Two Lines** edit tool allows you to connect two non-parallel line- and/or arc-based objects or to join two edges of an open or closed polyline-based object. The lines or edges will shorten or lengthen as need to intersect at a point and join. If one or more edges exists between the two polyline edges, they will be removed.

To use Intersect/Join Two Lines

- Click on a line, arc, or polyline segment that you would like to connect to another line or segment.
- Click the **Intersect/Join Two Lines**  edit button.
- Click on the other line or polyline edge.
- If there are intervening polyline edges, a message will confirm that you would like them to be removed. Click **Yes**.

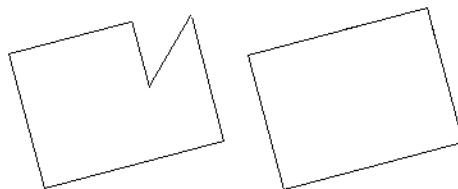



FILLET LINES



 The **Fillet Lines** edit tool allows you to replace the angled corner where two polyline edges meet with an arc or to join two non-parallel line-based objects with an arc.

If one or both of the two objects is an arc, both will extend or contract as needed to become connected. No additional arc is created.

To use Fillet Lines

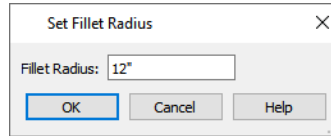
1. Click on a line or polyline segment that you would like to connect to another line or segment with a fillet, or arc.
2. Click the **Fillet Lines**  edit button, then click the **Fillet Radius**  edit button.
3. In the Set Fillet Radius dialog, specify the desired **Fillet Radius** and click OK. If this value is 0, no fillet will be created.



4. To apply a fillet to more than one corner of the selected polyline, click the **Sticky Mode**  edit button.
5. Click on the line or polyline segment that you want the selected line or edge to connect to with a fillet.
6. If you enabled **Sticky Mode** , continue clicking on edges to create additional fillets.
7. Click the **Main Edit Mode**  edit button or press the Esc key to return to the selected object's main edit toolbar.

Once two lines are filleted, the arc between them can be edited. See [Editing Arc-Based Objects on page 147](#).

CHAMFER LINES

 The **Chamfer Lines** edit tool allows you to create a straight corner bevel of a specified size connecting any two non-parallel lines or polyline edges. It can also be used to extend an arc so that it joins to another arc or line.

If one or both of the two objects is an arc, both will extend or contract as needed to become connected. No additional chamfer is created.

The **Chamfer Lines** edit tool is used much the way the **Fillet Lines** edit tool is. See [To use Fillet Lines on page 175](#).

 The Fillet Lines and Chamfer Lines edit tools can also be used the same way as the Intersect/Join Two Lines tool to join lines and polyline edges and remove any intervening polyline edges.

USING CLOSE POLYLINE

 An open polyline-based object can be converted into a closed polyline using the **Close Polyline** edit tool. See [Close Polyline on page 155](#).

SIMPLIFY POLYLINE

 The **Simplify Polyline** edit button is available for an open or closed polyline or polyline-based object with a segment that is unusually short and can cause problems when editing the polyline's shape. Click this edit button to remove the segment.

Rotating Objects

Objects can be rotated using the edit handles as well as a variety of edit tools. Multiple selected objects can also be rotated as a group. See [Selecting Objects on page 141](#).

By default, an object or group of objects rotate about the center point of the selection set. You can instead specify that objects rotate about the current CAD point. See [The Current Point on page 197](#).

USING THE EDIT HANDLES

Select an object, then click the triangular **Rotate** edit handle and drag it in any direction. When your pointer is over the Rotate handle, it displays a curved arrow .

The angles of line-based objects can also be changed by dragging an end handle in a direction other than parallel to the object. The object rotates about the opposite end point. See [Editing Line-Based Objects on page 145](#).

When **Angle Snaps**  are enabled, objects snap to Allowed Angles as specified in the Plan Defaults dialog as they are rotated. See [Angle Snaps on page 114](#).

To override any movement restrictions caused by snap settings or the presence of other objects, press the Ctrl key while dragging an edit handle.

You can temporarily slow the movement of your mouse as you drag an edit handle by holding down the Shift key on your keyboard.

USING THE SPECIFICATION DIALOG

 The exact angle of some objects such as lines, arcs, walls and the selected edges of polylines can be specified on either the GENERAL panel, SELECTED LINE panel, or SELECTED ARC panel of that object's specification dialog. See [Polyline Specification Dialog on page 215](#).

ROTATE/RESIZE ABOUT

 Objects can be rotated about either their own centers or the current CAD point. See [The Current Point on page 197](#).

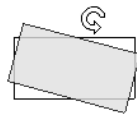

Rotate About Object Center



Rotate About Object Center

You can specify which behavior is used by selecting **Edit> Edit Behaviors> Rotate/Resize About Current Point** .

When this option is selected, objects rotate about the current CAD point; when it is not selected, object rotate about their centers.

The Rotate/Resize About behavior can also be specified in the Preferences dialog. See [Behaviors Panel on page 76](#).

USING ANGULAR DIMENSIONS

 **Angular Dimensions** are useful for adjusting the angles of a variety of objects with straight edges. See [Angular Dimensions on page 324](#).

To change an angular dimension

1. Draw an **Angular Dimension**  between the objects you want to move.
 - Begin and end as close as possible to the two objects you wish to locate.

2. Select the edge that you want to move.
3. Click the dimension value to open the Set Angular Dimension dialog.
 - The **Previous Value** is indicated degrees, minutes and seconds.

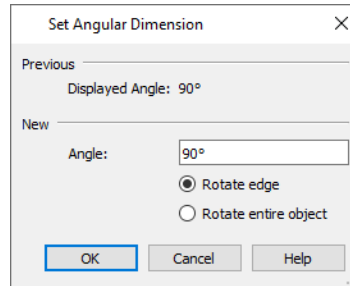

4. Enter a value in the **New Value** field.
5. Select **Rotate Edge** to move the selected edge when OK is clicked or select **Rotate entire polyline** to rotate the entire object the selected edge is a part of, maintaining the Previous Value of the angle.
6. Click **OK** to apply the change.

When an entire polyline is rotated using the Set Angular Dimension dialog, it rotates around the vertex of the angle.

MAKE PARALLEL/PERPENDICULAR WITH POLYLINE-BASED OBJECTS

 The **Make Parallel/Perpendicular** edit button usually adjusts the angle of a selected polyline edge. See [Make Parallel/Perpendicular on page 169](#).

To rotate the entire polyline instead, double-click the **Make Parallel**  edit button to open the Make Parallel dialog.

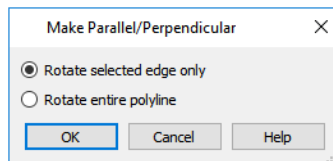

Choose to either **Rotate Selected Edge Only**, or **Rotate Entire Polyline**. This setting is global, affecting all files, and is retained during the current program session.

Polylines rotate according to the current **Rotate/Resize About** setting. See [Behaviors Panel on page 76](#).

USING THE TRANSFORM/REPLICATE OBJECT DIALOG

 Objects and groups of objects can be rotated to a relative or absolute angle using the Transform Replicate Object dialog. See [Transform/Replicate Object Dialog on page 180](#).

Reflecting Objects

There are several ways to reflect an object, group of objects, or an entire plan about an axis or another object. Either the original object(s) or copies of the original(s) can be reflected.

REFLECT ABOUT OBJECT





A selected object or objects can be reflected about another object, regardless of its angle, using the **Reflect About Object** edit tool.

Line-based objects are often used for reflecting a selection, but most objects have an axis that can be used.



- When an open or closed polyline-based object is used as the reflective object, the edge that is clicked on acts as the axis.
- When a circle or box-based object such as a CAD box or cabinet is used as the reflective object, the axis runs down the center of the object from back to front.
- In 3D views, architectural objects can only be reflected about a vertical axis - not a horizontal axis.
- A few objects, such as camera symbols, are not eligible to be used as a reflective object.

To use Reflect About Object

1. Draw a CAD line to act as the reflection line.
2. Select the object(s) to be reflected.
3. Click the **Reflect About Object**  edit button.
4. Click the CAD line to reflect the selection about the line.
5. The selection is reflected around the CAD line, and the original is no longer there.

To retain a copy of the selected object(s) in the original location, click the **Copy/Paste**  edit button before clicking the **Reflect About Object** button. See *To use Copy/Paste with other edit tools on page 119*.

USING TRANSFORM/REPLICATE OBJECT

 Objects and groups of objects can also be reflected horizontally or vertically using the Transform Replicate Object  dialog. See *Transform/Replicate Object Dialog on page 180*.

REVERSE DIRECTION

 Select a line-based, arc-based, open spline-based, or open polyline-based object and click the **Reverse Direction** edit button to reverse its direction. Not available for Terrain Path objects.

Reversing an object's direction switches its Start and End points and can be useful with certain line styles or if the selected object has an arrow at one end. The **Reverse Direction** tool also reverses the direction in which a selected Walkthrough Path is recorded. See *Walkthrough Paths on page 815*.

REVERSE PLAN



The **Reverse Plan** tool reflects architectural and CAD objects on all floors of an entire plan, as though they were flipped about a vertical line. See *Reverse Plan on page 103*.

Note: Reverse Plan does not affect the Terrain objects. See *Terrain on page 846*.

Converting Objects

CAD objects and many CAD-based objects can be converted into a variety of other types of objects.

CONVERT POLYLINE



The **Convert Polyline** edit tool lets you to turn CAD objects into CAD-based architectural objects such as countertops and stair landings, special polylines such as Materials List Polylines, and a variety of slab, hole and terrain objects.

To convert a CAD object into one of these 3D objects, select the object in plan view and click the **Convert Polyline**  edit button to open the Convert Polyline dialog.

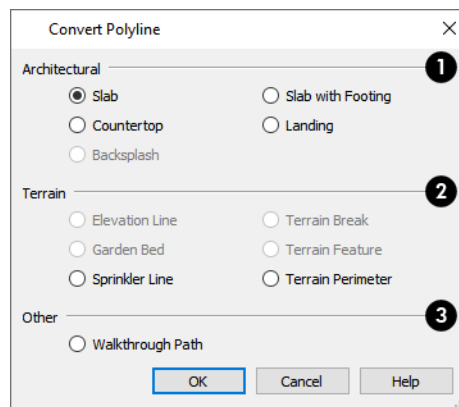

Click the radio button beside one of the objects in this dialog, then click OK.

1 Architectural

The **Architectural** settings are only available if the selected polyline is closed. See [Polylines on page 214](#).

- **Slab** and **Slab with Footing** - See [The Slab Tools on page 493](#).
- **Countertop** - See [Countertops on page 437](#).
- **Landing** - Not available if the polyline is a spline. See [Landings on page 521](#).
- **Backsplash** - Only available in cross section/elevation views. See [Custom Backsplashes on page 439](#).

2 Terrain

Most of the **Terrain** options are only available when a Terrain Perimeter is present.

- **Elevation Line** - See *Elevation Lines on page 851*.
- **Garden Bed** - Only available when the selected object is a closed polyline. See *Terrain Feature Tools on page 855*.
- **Sprinkler Line** - See *Sprinkler Tools on page 897*.
- **Terrain Break** - See *Elevation Data Tools on page 849*.
- **Terrain Feature** - Only available when the selected object is a closed polyline. See *Terrain Feature Tools on page 855*.
- **Terrain Perimeter** - See *Terrain Perimeter on page 847*. This option is only available when: the polyline is closed, a terrain perimeter does not yet exist, and only one polyline is currently selected.

3 Other

- **Walkthrough Path** - See *Walkthrough Paths on page 815*.

Click **OK** to convert the object or objects.

The specification dialog appropriate to the newly converted object opens, allowing you to specify its height, material and other information.

CONVERT TO PLAIN POLYLINE



Click the **Convert to Plain Polyline** edit button to convert a special polyline-based object to a plain 2D CAD polyline. See *Polylines on page 214*.

After a special polyline is converted into a plain polyline, it can be converted into a special polyline of the same or different type.

Bear in mind that some special polylines can only be converted to a plain polyline in the view type that they were created in. If a special polyline is selected and converted in a 3D view, the resulting plain polyline will be created in plan view.

Transform/Replicate Object Dialog

-  Select any object or group of objects and click the **Transform/Replicate Object** edit button to open the
- Transform/Replicate Object dialog.

If multiple options are selected in the Transform/Replicate Object dialog, they are performed in the order they appear in the dialog, from top to bottom.



Always double-check values entered in the Transform/Replicate Object dialog. Large offset values, resize factors, or numbers of copies can result in objects that are time-consuming to create or may be off the screen.

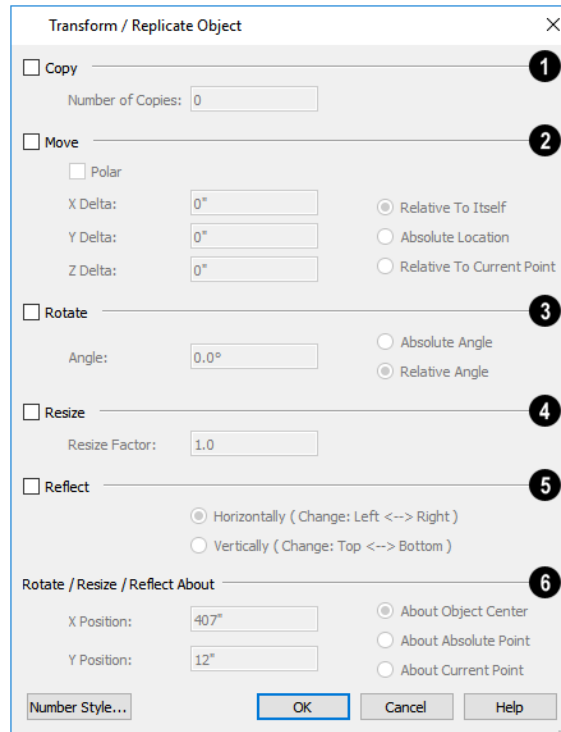

1 Copy

Check **Copy**, then specify the **Number of Copies** to make.

2 Move

Check **Move**, then specify how far or where to move the object(s).

- Select **Relative to Itself** to move the object relative to its current position, then specify the **X Delta**, **Y Delta** and **Z Delta** values, which are the object's changes in position along each axis.
- Select **Absolute Location** to move the object to an absolute location. You can either specify its **X** and **Y Position**, or **Angle** and **Distance**, if **Polar** is checked.
- Select **Relative to Current Point** to move the object relative to the current CAD point. See *Point Tools on page 195*. You can either specify its **X Delta** and **Y Delta**, or **Angle** and **Distance**, if **Polar** is checked.

 When a CAD-based object is moved to a new floor, only its display in plan view is moved - its physical location in the model remains unchanged. See *Architectural vs CAD Objects on page 111*.

3 Rotate

Select this option, then specify the **Angle** to rotate the object(s).

- Select **Absolute Angle** to rotate the object relative to an imaginary horizontal line drawn in the positive X direction from the origin. See *3D Drafting on page 11*.
- Select **Relative Angle** to rotate the object the specified angle relative to its current orientation.

You can also specify the point the selected object(s) rotate about, below.

4 Resize

Specify the **Resize Factor** in decimals. A resize factor of 2 doubles the size of the object, while a resize factor of 0.5 halves the object's size. Not available for all objects, including line- and arc-based objects and Primitives.

You can also specify the point the selected object(s) is resized about, below.

5 Reflect

Select this option, then specify which axis to reflect about.

- **Horizontally** - Select this option to reflect the object horizontally.
- **Vertically** - Select this option to reflect the object vertically.

You can also specify the point the selected object(s) is reflected about, below.

6 Rotate/Resize/Reflect About

This section is enabled when the **Rotate**, **Resize** and/or **Reflect** functions are selected.

- **X Position** - Specify the X coordinate of the point to perform the selected edit function(s) about when **About Absolute Point** is selected.
- **Y Position** - Specify the Y coordinate of the point to perform the selected edit function(s) about when **About Absolute Point** is selected.
- **About Object Center** - Select this option to perform the selected edit function(s) about the object's center.
- **About Absolute Point** - Select this option to perform the selected edit function(s) about the specified point.
- **About Current Point** - Select this option to perform the selected edit function(s) about the current CAD point.

Edit Area Tools

 The **Edit Area Tools** allow you to quickly define an area of your plan and select the objects in that area. Once selected, they can then be repositioned, copied or deleted. Select **Edit > Edit Area** to access the **Edit Area Tools**.

Unlike other selection methods, the **Edit Area Tools** cut walls, railing and fencing where the selection marquee intersects them, allowing you to edit only the selected portion of these objects.

Some objects, such as cabinets, are included in the selection only if more than half of the object is contained within the marquee.

Camera and cross-section/elevation symbols are included in the selection and can be moved with it. While cameras can also be rotated as well as copied, cross section/elevations cannot. See [Editing 3D Views on page 754](#).

A few objects, notably CAD points, are not affected by the **Edit Area Tools**.



The Edit Area tools can cause wide-spread changes across an entire plan and should always be used with caution.

EDIT AREA

 Select **Edit > Edit Area > Edit Area** and draw a rectangular marquee around the area of the plan to be edited.

Edit Area affects all objects included in the selection marquee that are located on the current floor, regardless of whether they are displaying in plan view or not.

EDIT AREA VISIBLE



Select **Edit > Edit Area > Edit Area Visible** and draw a marquee around the area of the plan to be edited.

Edit Area Visible only affects visible objects included in the selection marquee: objects not currently displayed in plan view are unaffected.

EDIT AREA (ALL FLOORS)



Select **Edit > Edit Area > Edit Area (All Floors)** and draw a marquee around the area of the plan to be edited.

Edit Area (All Floors) affects all objects on all floors of the plan that are included in the selection marquee, regardless of whether they display in plan view.

EDIT AREA (ALL FLOORS) VISIBLE



Select **Edit > Edit Area > Edit Area (All Floors) Visible** and draw a marquee around the area of the plan to be edited.

Edit Area (All Floors) Visible affects all visible objects on all floors of the plan that are included in the selection marquee. Objects not currently displaying in plan view are not affected.

EDIT AREA POLYLINE

If a rectangular marquee's shape does not allow you to define an area precisely, use a closed polyline instead.

Select a polyline that defines the desired area in plan view and then select one of the **Edit Area Tools** . The polyline becomes temporarily highlighted and acts as an Edit Area marquee.

USING THE EDIT HANDLES

An Edit Area marquee displays edit handles that are similar to those of a closed polyline. See *Using the Edit Handles on page 155*.

- Click the **Move** edit handle to move the entire selection set. See *Moving Objects on page 165*.
- Click the **Rotate** edit handle to rotate the entire selection set. See *Rotating Objects on page 175*.
- Click and drag the **Reshape** and **Resize** edit handles at each corner and along each edge to adjust the size and shape of the marquee. See *Using the Edit Handles on page 155*.

Adjusting the size or shape of an Edit Area marquee may change which objects are included in the selection set but does not otherwise affect those objects.

USING THE EDIT TOOLBAR

A selected Edit Area marquee and/or the objects within it can be edited in a variety of ways using the buttons on the Edit Toolbar. See *Using the Edit Toolbar on page 157*.

The following toolbar buttons may display on the Edit Toolbar for an Edit Area marquee:



Copy/Paste copies the selection set to the system clipboard so it can be pasted elsewhere. See *Copying and Pasting Objects on page 117*.



Delete deletes the selection set. See [Deleting Objects on page 187](#).



Transform/Replicate Object copies, moves, rotates, resizes, or reflects the selection set. See [Transform/Replicate Object Dialog on page 180](#).



Make Parallel/Perpendicular rotates the Edit Area marquee and the selection set so that the selected marquee edge is parallel or perpendicular to another straight edge. See [Make Parallel/Perpendicular on page 169](#).



Point to Point Move accurately moves the selection between two points. See [Point to Point Move on page 167](#).



Center Object centers the selection relative to another object. See [Center Object on page 169](#).



Reflect About Object reflects the selection set about another object. See [Reflecting Objects on page 177](#).



Allowed Angles opens the Place at Allowed Angles dialog.

PLACE AT ALLOWED ANGLES DIALOG



If more than one percent of the straight walls included in an Edit Area marquee are not at an Allowed Angle, the **Allowed Angles** edit button displays.

Click the **Allowed Angles** edit button to display the Place at Allowed Angles dialog.

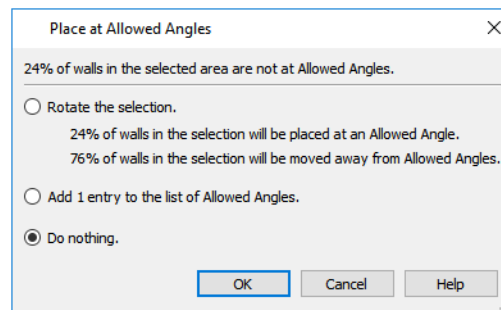

Select the first option and click **OK** to rotate the plan so that the largest group of off-angle walls move to an Allowed Angle. This may place this largest group at Allowed Angles, but has two disadvantages.

- First, other groups of off angle walls remain off angle.
- Second, any walls that were at an allowed angle before this action will move to an off angle. The dialog shows how much (weighted by length) of the selected walls are in each category.

Select the second option and click **OK** to add new entries to the Allowed Angles list and allow new walls to be placed at these angles. Walls already at Allowed Angles remain so. See [Angle Snaps on page 114](#).

Select the third option and click **OK** to do nothing, which is the same as clicking **Cancel**.

You may want to rotate the majority of the walls to one of the normal allowed angles. Then, use an **Edit Area**  tool to select everything again and select the second option to provide new angle entries to cover the remaining walls.

Stretch CAD



The **Stretch CAD** tool allows you to reshape or move a variety of CAD-based objects using a temporary closed

polyline.

To use the Stretch CAD tool

1. Select **Edit> Stretch CAD** .
2. Click and drag to draw a rectangular polyline through the CAD objects that you would like to stretch.
3. You can edit the shape of the Stretch CAD polyline so that it intersects the objects you want to stretch along the desired planes. See [Editing Closed Polyline-Based Objects on page 155](#).
 - An edge of the polyline must extend through each of the objects that you would like to stretch.
 - The opposite polyline edge should be located outside of those objects.
4. When the Stretch CAD polyline's shape and position meet your needs, click and drag its Move edit handle.
5. As you drag, intersected objects will either stretch, contract, or move.
 - An edge of the polyline must extend through each of the objects that you would like to stretch.
 - The opposite polyline edge should be located outside of those objects.
1. When the Stretch CAD polyline's shape and position meet your needs, click and drag its Move edit handle.
2. As you drag, intersected objects will either stretch, contract, or move.

Not all CAD-based objects can be reshaped using the **Stretch CAD**  tool:

- Road and Text objects are examples of objects that can be moved but not reshaped by this tool.
- Stairs, Ramps, and Sun Shadows are examples of objects that are not affected by this tool at all.

Eyedropper and Painter Tools

There are a number of tools in Home Designer that allow you to apply attributes to objects by clicking on them.

- The Eyedropper tools allow you to load attributes from one object and apply them to other objects.
- The Painter tools allow you to apply attributes to one or more objects. Depending on the tool, attributes may be loaded from another object using an Eyedropper tool or selected from a dialog.
- Some object attributes can also be replaced directly from the library. See [To replace an inserted object on page 689](#).

Attributes cannot be either loaded from or painted onto objects on locked layers or on layers that are not set to display. They can be used to modify automatically generated objects such as roof planes and framing; however, the associated Auto Rebuild function will be turned off. See [Auto Rebuild on page 116](#).

EYEDROPPER TOOLS

The Eyedropper tools allow you to select attributes from one object and apply them to other objects. There are three Eyedropper tools in the program:



Material Eyedropper, see [Material Eyedropper on page 714](#)





Object Eyedropper, see [Object Eyedropper on page 187](#)





Fill Style Eyedropper, see [Fill Style Eyedropper and Painter Tools on page 130](#)

To use an eyedropper tool

1. Select the Eyedropper tool that you want to use and notice that the mouse pointer displays an eyedropper  icon.
2. Move the mouse pointer over an object in the current view. If the object is eligible for use with the selected Eyedropper:
 - It will become highlighted in the view.
 - The left side of the Status bar will report information about that object or the attribute that the Eyedropper can load from it.
3. Click once to load the object's attributes so they can be applied to other, similar objects.
4. Notice that your mouse pointer now displays a spray can  icon. This means that the Painter tool associated with the selected Eyedropper is now active.
5. Depending on the tool in use, additional buttons may now display on the Edit Toolbar. Select the option or options that you need:
 - The **Painter Mode** buttons. See *Painter Modes on page 187*, below.
 - **Blend Colors with Materials**. See *Material Painter Tools on page 713*.
6. Move your mouse pointer over an object that is similar to the one selected in step 2. If it is eligible to receive the loaded attribute(s):
 - It will become highlighted in the view.
 - The left side of the Status bar will report information about the attribute to be painted or loaded.
7. Click on an eligible object to apply attributes to it as well as to any other identical objects, depending on which Painter Mode is active.
8. Continue clicking to apply attributes until the Esc key is pressed or another tool is activated.

PAINTER TOOLS

The Painter Tools let you apply attributes to a wide variety of objects by clicking on them. When a Painter tool is active, the mouse pointer will display a spray can  icon. There are a number of ways to load attributes into a Painter tool.

- Click on an object using any Eyedropper tool to load its attribute(s). The associated Painter tool will become active, ready to paint the loaded attributes.
- Select a material or fill style in the Library Browser and move the mouse pointer into the current view window. If that item can be applied in the current view type, the associated Painter will be active and you can apply the selection to eligible objects in that view.
- When you select the **Material Painter**  tool, the Select Material dialog will open, allowing you to choose a material from the library. See *Select Material/Library Object Dialog on page 717*.
- When you select the **Fill Style Painter**  tool, the Select Library Object dialog will open, allowing you to choose a fill style from the library. See *Select Library Object Dialog on page 688*.

Once a Painter tool is loaded, simply click on an object to apply the selected attributes. See *To use the Material Painter tool on page 714*.

PAINTER MODES

There are five Painter Modes that control how broadly or narrowly a selected Painter tool will apply an attribute or attributes to objects in the current plan. These modes are listed in the same submenu as the associated Eyedropper and/or Painter tool. When a Painter tool is active, they are also found on the Edit Toolbar. In both locations, a small check mark will display at the lower left of the active Mode's button icon.



Depending on the type of object attributes have been loaded from, not all Object Painter Modes may be available.

Rather than modify instances of an object type, the Material Painter Modes replace instances of a material based on the selected scope.



Object Mode applies attributes to or replaces a material on individual target objects, one at a time. All instances of the original material on a target object are replaced by the one being painted.



Marquee Mode is available in plan view for the Fill Style Painter and Object Painter tools. To use this mode, click and drag a marquee around the objects you would like to paint instead of clicking on them.



Room Mode applies attributes to a target object as well as all instances of that object type in the same room with a single click. All instances of the original material throughout the room are replaced by the one being painted.



Floor Mode applies attributes to a target object as well as all instances of that object type on the same floor with a single click. All instances of the original material on the current floor are replaced by the one being painted.



Plan Mode applies attributes to a target object as well as all instances of that object type in the entire plan with a single click. All instances of the original material throughout the plan are replaced by the one being painted.



An additional mode, the **Component Mode**, is only available for the Material Painter and Adjust Material Definition tools. See *Material Painter Modes on page 714* and *Adjust Material Definition on page 719*.

Home Designer will remember your Painter Mode selection until you quit the program. The next time you launch the program, Object Mode will be active.

Object Painter

A variety of attributes can be copied from one object to another using the Object Painter tools.

OBJECT EYEDROPPER





Select **Tools > Object Painter > Object Eyedropper** to apply the attributes of one object to other objects. The Object Eyedropper functions like other Eyedropper tools. See *To use an eyedropper tool on page 186*.

When the Object Painter is active, you can choose a Painter Mode to control how broadly or narrowly the selected attributes are applied to other objects. See *Painter Modes on page 187*.

Deleting Objects

Objects can be deleted in a variety of ways:

- Select an object or group of objects, then click the **Delete**  edit button, select **Edit> Delete**  from the menu, or press the either the Delete or Backspace key on your keyboard.
- Entire categories of objects can be deleted using the Delete Objects dialog.
- Objects are deleted if the floor they are placed on is deleted. See [Deleting Floors on page 506](#).

If an object has a line with arrow attached to it, the line with arrow is deleted if the object is deleted. To prevent the arrow from being deleted, drag the attached end away from the object before deleting it.

A variety of objects in the program can be generated automatically, including roofs, the foundation, and framing. Automatically generated objects cannot be deleted unless the automatic creation option is disabled.



Objects such as roofs, framing, and Auto Exterior Dimensions that are set to automatically rebuild or refresh cannot be deleted while that behavior is enabled. Automatically generated objects cannot be deleted unless the automatic creation option is disabled.



Although objects on locked layers cannot be selected, most can nevertheless be deleted using the Delete Objects dialog.

DELETING POLYLINE EDGES

There are number of different ways to delete individual edges of polyline-based objects:

- Select **Connect CAD Segments** . Select the edge and delete. See [Disconnect Edges on page 142](#).
- Drag a corner handle until it overlaps an adjacent corner handle to remove the edge between them and merge them into a single handle.
- Create a complete break at both ends. Select the edge and delete. See [To create a complete break on page 173](#).
- The **Fillet Lines**  and **Chamfer Lines**  tools can be used to delete polyline edges. See [Reshaping Objects on page 171](#).

DELETE SURFACE



In any 3D view, select **3D> Delete Surface**, then click a surface in the view to temporarily remove the surface from the current view without permanently affecting the object. See [Delete 3D Surface on page 749](#).

Delete Objects Dialog



The Delete Objects dialog lets you delete categories of objects in a plan or layout file. Select **Edit> Delete Objects** to access this dialog. The settings in the dialog vary depending on whether a plan or a layout file is active:

IN PLAN VIEWS

The Delete Objects dialog only deletes objects in plan view - it does not delete CAD objects or plant schedules drawn in cross section/elevation views. If this dialog is opened while a camera view is active, CAD objects and plant schedules cannot be deleted.

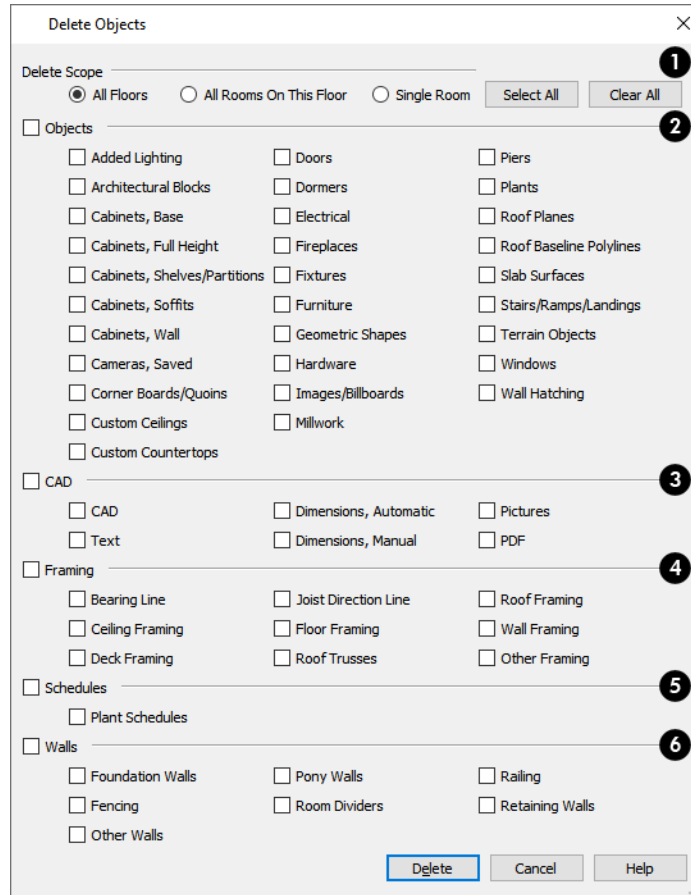

1 Delete Scope

- Choose **All Floors** to delete objects on all floors in the current plan.
- Choose **All Rooms on This Floor** to delete objects in all rooms on the current floor.
- Choose **Single Room** to delete objects only in rooms on the current floor that you specify.
- Click the **Select All** button to check all boxes below.
- Click the **Clear All** button to uncheck all boxes.

2 Objects

Specify which types of architectural **Objects** you want to delete.

3 CAD

Specify which types of **CAD** objects you want to delete. See *CAD Objects on page 192*.

4 Framing

Specify which types of **Framing** objects you want to delete. See *Framing on page 605*.

5 Plant Schedules

Specify whether or not to delete **Plant Schedules**. See *Plant Schedules on page 898*.

6 Walls

Specify which kinds of **Walls** you want to delete. See *Walls, Railings, and Fencing on page 222*.

To use the Delete Objects dialog

1. Specify the **Delete Scope** as **Single Room**, **All Rooms On This Floor**, or **All Floors**.
2. Click **Select All** to check all the boxes or **Clear All** to uncheck all boxes.
3. Check the box for each category of objects you want to delete.
 - Check the box beside any heading to select all of the categories within it; clear the box beside a heading to deselect all of its categories.
4. Check the box for each subcategory of objects that you want to delete.
 - If “Roof Planes” cannot be selected, they may be locked. See *Editing Roof and Ceiling Planes on page 573*.
5. When the scope is set to **Single Room**:
 - Move your cursor into the drawing area and click in a room of the plan to delete objects of the selected type within that room without closing the dialog.
 - Only objects with their center point located in the room are deleted.
 - Continue clicking on rooms or choose a different Delete Scope.
 - Click **Done** when all selections have been deleted.

Note: If you click in or try to switch to a view window other than the active view, the Delete Objects dialog will close.

6. If you select **All Rooms On This Floor** or **All Floors**, you do not need to click in plan view. The **Delete** button becomes available, and clicking it closes the dialog and deletes the specified objects.

IN LAYOUT

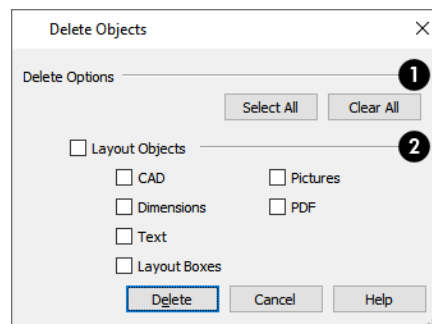

1 Delete Options

- Click the **Select All** button to check all boxes below.
- Click the **Clear All** button to uncheck all boxes.

2 Layout Objects

Specify which types of objects that you want to delete. See *On the Layout Page on page 926*.

Undo and Redo



The **Undo** and **Redo** commands allow you to both undo the last action performed, as well as redo actions that were recently Undone.

Undo files are stored in the Undo Directory, which can be specified in the Preferences dialog. See [Folders Panel on page 69](#).

The 50 most recent actions can be Undone or Redone, depending on your settings in the Preferences dialog. See [General Panel on page 66](#). Actions that can be Undone and Redone include creating, editing, and deleting objects.

The maximum number of Undo files is specified in the **Maximum Undos** value in the Preference settings. If you have **Undo** enabled, be sure to define a directory on a hard drive with enough space for these files.

To Undo an action, select **Edit> Undo**, click the **Undo**  button, or press Ctrl + Z on your keyboard.

The Redo command is only available after Undo has been used. To Redo an Undone action, select **Edit> Redo**, click the **Redo**  button or press Ctrl + Y on your keyboard.

It is important to note that **Undo** and **Redo** do not affect all actions in the program, including:

- Save and Save As. See [Saving Plan and Layout Files on page 37](#).
- Changes made in the Library Browser. See [The Library Browser on page 669](#).
- Changes made in a dialog while the dialog box is open. See [Dialogs on page 18](#).
- Changes made to lights using the Adjust Lights dialog. See [Adjust Lights Dialog on page 775](#).
- Changes made to the display by panning the display or zooming in or out. See [Zoom Tools on page 106](#).
- Changes made to the position of a camera, or its Rendering Technique. See [Editing 3D Views on page 754](#).

CAD Objects

Chapter 10

The CAD tools allow you to add details to 2D views of your design to create complete working drawings.

CAD objects do not affect 3D objects or display in camera views or overviews, but they can be used to add details to layout pages, plan views and cross section/elevation views.

CAD polylines can be converted to 3D objects such as countertops and terrain data, and shown in 3D views. See [Convert Polyline on page 179](#).

CAD objects are edited much like other objects in Home Designer. See [Editing Objects on page 136](#).

TOPICS

CAD Defaults and Preferences	193
The CAD Drawing Tools	194
Point Tools	195
Line Tools	199
Line Specification Dialog	202
Drawing Arcs - Arc Creation Modes	206
Arc Tools	207
Arc Specification Dialog	209
Circle Tools	212
Circle/Oval/Ellipse Specification Dialog	213
Polylines	214
Polyline Specification Dialog	215
Box Tools	217
Box Specification Dialog	218
Splines	219
Displaying CAD Objects	220

CAD Defaults and Preferences



CAD Defaults can be accessed by selecting **Edit> Default Settings** from the menu and expanding the CAD category.



The behavior and appearance of CAD objects are also affected by settings on the CAD, LINE PROPERTIES, SUN ANGLE, BEHAVIORS, and SNAP PROPERTIES panels of the Preferences dialog. Unlike default settings, preference settings are global, affecting all plan and layout files. See *Preferences Dialog on page 59*.

CAD DEFAULTS DIALOG



The settings in the CAD Defaults dialog control the basic appearance of CAD objects. This dialog can also be opened by clicking the **CAD Defaults** button, which can be added to the toolbars. See *To add a button to a toolbar on page 92*.

Each plan file has multiple CAD Defaults dialogs: one affecting plan view and one for every cross section/elevation view. Each layout file has its own CAD Defaults, as well. The CAD Defaults associated with a given view can be accessed by opening the CAD Defaults dialog while that view is active.

The CAD Defaults dialog cannot be opened when a camera view or overview is active.

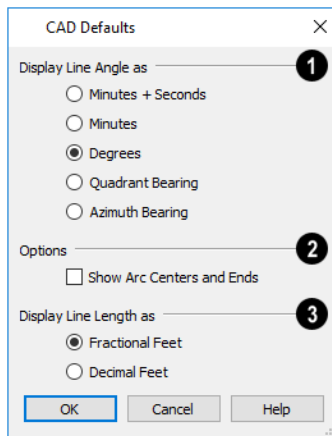

1 Display Line Angles as

Specify the format to use when **Show Angle** is checked in an object's specification dialog. See *Line Style Panel on page 204*.

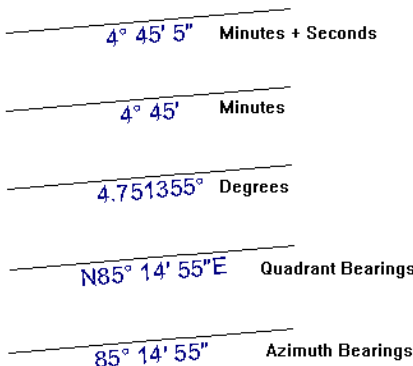

Line angles can be displayed using three basic methods:

- **Degrees/Minutes/Bearings** - Measured counterclockwise from a line drawn horizontally to the right of the angle's vertex. Useful for most drawing tasks. Select the level of accuracy that you require.
- **Quadrant Bearings** - Measured from a vertical line representing North/ South, Quadrant Bearings use directional bearings in their measurements. Useful for site drawings.
- **Azimuth Bearings** - Measured from a line drawn straight up from the angle's vertex (i.e., North on a site plan). Useful for site drawings, Azimuth Bearings use degrees, minutes, and seconds in their measurements.



Line length and angle indicators use the Text Style of the layer that their object is on. See [Text Styles on page 360](#).

2 Options

Select any combination of the available **Options**.

- Check **Show Arc Centers and Ends**  to show arc centers and ends on the current floor. Ends display as small lines where arcs connect to one another. Centers also acts as snap points. See [Arc Centers and Ends on page 151](#).

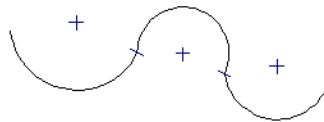

Show Arc Centers and Ends

3 Display Line Length As

Specify whether to **Display Line Length as** either **Fractional** or **Decimal Feet**. This controls the appearance of line length indicators, which only display when **Show Length** is checked in an object's specification dialog. See [Line Style Panel on page 204](#).





The CAD Drawing Tools

The following CAD Tools are available in the CAD menu and the toolbars.

POINT TOOLS



Select **CAD> Points** to access the Point Tools.

The **Place Point** , **Input Point** , **Point Marker** , and **Delete Temporary Points**  tools can be used to create or remove snap points for a variety of purposes. See [Point Tools on page 195](#).

LINE TOOLS



Select **CAD> Line** to access the Line Tools.

The **Draw Line** , **Input Line** , **Line With Arrow** , **Sun Angle** , and the **North Pointer**  allow you to create various types of lines. See [Line Tools on page 199](#).





ARC TOOLS

 Select **CAD > Arcs** to access the Arc Tools.

The **Draw Arc** , **Input Arc** , and the **Arc With Arrow**  tools allow you to create arcs. See *Arc Tools on page 207*.





BOX TOOLS

 Choose **CAD > Boxes** to access the Box Tools.

The **Rectangular Polyline** , **Box** , **Cross Box** , and **Insulation**  tools allow you to create a variety of polyline and box objects. See *Box Tools on page 217*.

CIRCLE TOOLS

 Select **CAD > Circles** to access the Circle Tools.

The **Circle** , **Circle About Center** , **Oval** , and the **Ellipse**  tools are discussed in detail later in this chapter. See *Circle Tools on page 212*.

SPLINE

 A Spline is a curve that passes smoothly through a set of points. Select **CAD > Spline** to draw connected line segments that form a spline. See *Splines on page 219*.

Once created, a spline can be selected and edited. See *Editing Spline-Based Objects on page 160* and *Polyline Specification Dialog on page 215*.

DIMENSION TOOLS





 Select **CAD > Dimensions** to access the Dimension Tools. The **Dimension Tools** can be used with CAD and architectural objects and are discussed in their own chapter. See *Dimensions on page 311*.

TEXT TOOLS

T Select **CAD > Text** to access the Text Tools. The Text Tools are discussed in their own chapter. See *Text, Callouts, and Markers on page 337*.

Point Tools

Select **CAD > Points**  to access the Point Tools.

Temporary points created using the **Place Point**  and **Input Point**  tools and permanent **Point Markers**  can be used with **Object Snaps**  to accurately position a variety of objects. See *Object Snaps on page 113*.

The size of temporary points is specified in the Preferences dialog. See *Snap Properties Panel on page 78*.

PLACE POINT

✕ Select **CAD> Points> Place Point**, then click in the drawing area to place a temporary CAD point at that location. Temporary CAD points can be used for a variety of purposes: for example, as an anchor for snapping objects to a precise location. The Current CAD Point can be used for additional tasks. See [The Current Point on page 197](#).

INPUT POINT

✕ Temporary CAD points can be placed with precision by entering coordinates. See [3D Drafting on page 11](#).

To use the Input Point tool

1. Select **CAD> Points> Input Point**  to open the New CAD Point dialog.
2. Select a **Location** option, and enter the desired location of the point.
3. Click **OK** to close the dialog and create the new point. The new point becomes the Current Point and is highlighted. See [The Current Point on page 197](#).
4. Alternatively, click **Next** to create the new point but remain in the New CAD Point dialog and create additional points. As each is created, it becomes the Current Point.

NEW CAD POINT DIALOG

1 Current Point

The location of the **Current Point** displays here. If no CAD points are present, the origin (0, 0) displays. See [The Current Point on page 197](#).

2 New Point

Specify the location of the **New Point**.

- **Absolute Location** - Define the point in **X Position** (horizontal) and **Y Position** (vertical) coordinates, relative to the origin at (0,0).
- **Relative to Current Point** - Define the new point in **X** and **Y** coordinates that are relative to the Current Point, as though that point was at (0,0). Only available when a Current Point exists.

- Check **Polar** to define the new point by its **Distance** and **Angle** from the Current Point rather than in X and Y coordinates. This is helpful when creating a plot plan. See [Plot Plans on page 848](#).

The position of the New Point is defined here. The options available depend on the method chosen to define it, above.

- **X Position** and **Y Position** coordinates relative to (0,0) are entered if the Absolute Location method is specified.
- **X Position** and **Y Position** coordinates relative to the Current Point are entered if the Relative to Current Point method is specified.
- **Distance** and **Angle** from the Current Point are entered if the Relative to Current Point: Polar method is specified.
- Click **Next** to create the new point without exiting the dialog so you can input data for the next point. The newly created point becomes the Current Point.



POINT MARKERS

 Use a permanent **Point Marker** as a snap point for dimension lines and other CAD objects. Select **CAD> Points> Point Marker** and click in the view to place a permanent point marker. Point markers display as a simple cross, with or without a text label. They can be opened for specification and modified to include a label or alter their attributes.

You can also place Point Markers using the **Marker**  tool, which lets you specify the marker label and type. See [Markers on page 357](#).

Point Markers are also created when the **Point to Point Dimension**  tool is used, or when a dimension line is copied and pasted independent of the objects it locates. See [Point to Point Dimensions on page 325](#).

DELETE TEMPORARY POINTS

 All temporary points in the current view can be deleted at once using **CAD> Points> Delete Temporary Points**. In plan view, Delete Temporary Points will delete all temporary points on all floors.

You can also press the **Delete** key when nothing is selected to delete the points one by one; however, **Delete Temporary Points**  can save time when there are many points.

THE CURRENT POINT

In any view and on any floor, there may be multiple temporary CAD points. The Current Point is either the most recently created or most recently selected temporary CAD point. The Current Point has a variety of uses:

- As the starting point for objects as they are drawn by entering data. See [Entering Coordinates on page 116](#).
- As the point about which objects are rotated. See [Rotating Objects on page 175](#).
- To indicate the points at which roof planes can join. See [To find roof plane intersection points on page 577](#).

When multiple temporary points are on-screen, the Current CAD Point is highlighted so it can be easily identified.



To delete the Current Point

1. Make sure no other objects are selected by clicking the **Select Objects**  button. You can also press the Esc key to deselect any selected objects.
2. Press the Delete key on the keyboard to delete the Current Point. The temporary point created prior to this one becomes the new Current Point.
3. If you continue pressing the Delete key, temporary points will be deleted in the reverse order that they were created.

MOVE POINT DIALOG

A CAD Point can be repositioned relative to itself, another point, or a CAD object such as a line using the Move Point dialog. When a Point is moved, it becomes the Current Point.

For example, you can locate the point exactly one-quarter the distance along a given line, or exactly 6 inches from one end. This new location can then be used for the start point of a new line or other purpose.

To reposition a CAD Point, double-click on it using the **Select Objects**  tool. That point becomes the Current Point, and the Move Point dialog opens.

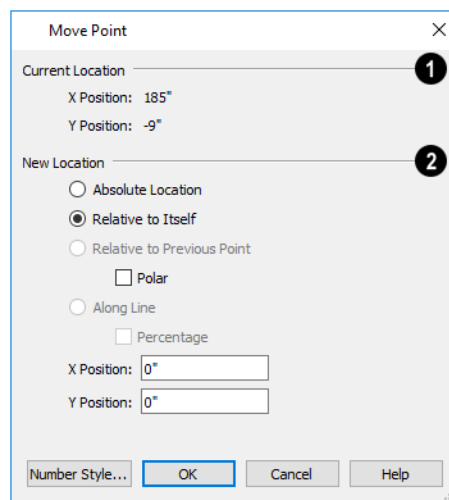

1 Current Location

The **Current Location** of the selected point displays at the top of the dialog for reference.

2 New Location

Specify the **New Location** of the point.

- **Absolute Location** - Define the new location in **X** (horizontal) and **Y** (vertical) **Position** coordinates, relative to the origin at (0,0).
- **Relative to Itself** - Define the new location in **X** and **Y Position** coordinates relative to the current location, as though that point were the origin.
- **Relative to Previous Point** - Define the new location relative to the point that was the Current Point prior to this one, as though that point was the origin. Only available if the selected point is located on a CAD object.

- Check **Polar** to define the new location's **Distance** and **Angle** from the previous point instead of using X and Y coordinates. Only available if Relative to Itself or to Previous Point is selected above.
- **Along Line** - Define the new location relative to the edge of a nearby CAD object. This option is enabled only when the point is located near a CAD object and refers to the end nearest to the point's original location.
- Check **Percentage (%)** to specify the Along Line value as a percentage of the total line or arc length rather than as a distance. 0% moves the point to the closest end of the nearest edge, 50% to the midpoint, and 100% to the other end. Negative numbers and percentages greater than 100 are allowed.
- Specify the new position of the point here. The options here depend on the method chosen to define the New Location.
- **X Position** and **Y Position** coordinates are entered if the Absolute Location method is specified or if either Relative method is used with Polar unchecked.
- **Distance** and **Angle** are entered if either Relative method is specified when Polar is checked.
- **From Edge** - When the Along Line method is used, specify the distance of the point's New Location to the end of the CAD object's edge that it was originally closest to. When **Percentage (%)** is checked, enter this value as a percentage instead.

If the point is near an arc, **Along Line** is measured along the curve.

If the point is near a box or polyline, **Along Line** is measured along the nearest side just as it does with an individual line or arc.



If the point is near an oval or circle, **Along Line** is measured along an (invisible) axis line that the item was originally drawn along.



Click the Number Style button to change the units used in dialogs. See [Dialog Number/Angle Style Dialog on page 87](#).

Line Tools

 Select **CAD> Draw Lines** to access the Line Tools.

If **Object Snaps**  and **Connect CAD Segments**  are enabled, you can connect the ends of multiple lines and/or arcs to form a single entity called a polyline. See [Polylines on page 214](#).

DRAW LINE



 Select **CAD> Lines> Draw Line**, then click and drag from beginning to end.

INPUT LINE

 CAD lines can also be created using absolute values entered with the keyboard by selecting **CAD> Lines> Input Line**. This method is slower but more precise than using the mouse and is ideal when the desired length and angle of each line is known, such as with property lines.

Before any line is drawn using this method, a starting point must be defined. If a starting point has not been defined, Home Designer Pro assumes a starting point of 0,0.

To use the Input Line tool

1. Select **CAD> Points> Place Point** , then click the screen to place a CAD point. This is the Current Point, and is the start point for the new line. See *The Current Point on page 197*.
2. Select **CAD> Lines> Input Line**  to open the New CAD Line dialog. This dialog can also be opened by double-clicking the **Line Tools**  parent button.
3. If necessary, specify the start point.
4. Specify the method used to define the location of the End Point, then define the End Point.
5. Click **OK** to close the dialog and draw the line, or click **Next** to draw the line but remain in the New CAD Line dialog and draw additional lines.

Note: If you accidentally click OK instead of Next and need to continue drawing a polyline using the New CAD Line dialog, select the Input Line tool again and continue.

NEW CAD LINE DIALOG

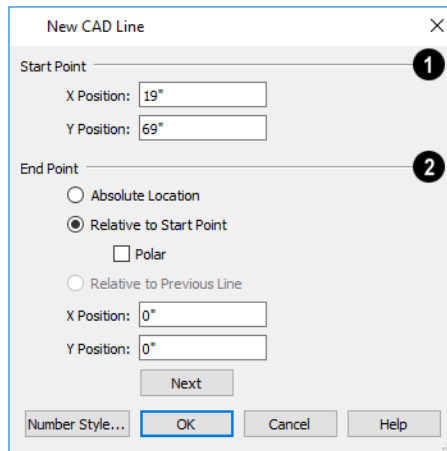

1 Start Point

The **X Position** (horizontal) and **Y Position** (vertical) coordinates of the start point for the new line display here. They can also be changed, if you wish.

2 End Point

The new line’s **End Point** is defined here. Begin by specifying how you want to define the line **End Point Location**.

- **Absolute Location** - Define the end point of the new line in **X Position** (horizontal) and **Y Position** (vertical) coordinates, relative to (0,0).
- **Relative to Start Point** - Define the end point of the new line in **X** and **Y** coordinates that are relative to the line’s Start Point, as though it were at (0,0).
- Check **Polar** to define the End Point of the new line by its **Distance** and **Angle** from the Start Point rather than in **X** and **Y** coordinates. This is helpful when creating a plot plan. See *Plot Plans on page 848*.

- **Relative to Previous Line** - Define the End Point of the new line by its **Distance** and **Angle** relative to the end of the last line drawn, as though that line's angle were at 0° and its End Point, at (0,0).
- **X Position** (horizontal) and **Y Position** (vertical) coordinates relative to (0,0) are entered if the Absolute Location method is specified.
- **X Position** (horizontal) and **Y Position** (vertical) coordinates relative to the start point are entered if the Relative to Start Point method is specified.
- **Distance** and **Angle** from the start point are entered if the Relative to Start Point: Polar method is specified.
- **Distance** and **Angle** from the start point are entered if the Relative to Previous Line method is specified.
- Click **Next** to create the line without exiting the dialog so you can input data for the next line. The start point of the next line is the end point of this line.



Click the Number Style button to change the units used in dialogs. See [Dialog Number/Angle Style Dialog on page 87](#).

To enter an angle in bearings

1. While not required, you may want to select **Quadrant** or **Azimuth Bearings** in the Dialog Number/Angle Style dialog.
2. For Quadrant Bearings, begin by typing *N* or *S* (for North or South).
3. Next, type the number of degrees followed by either a letter d or a space.
4. Type the number of minutes followed by either a ' or a space.
5. Type the number of seconds followed by either a " or a space.
6. Finally, for Quadrant Bearings, type either *E* or *W* (for East or West).

Following are some examples of Quadrant Bearings. It is not necessary to capitalize the letters. Spaces after each value are optional.

- N 20d 30' E
- S 45' W
- N 89d 48' 30" W
- N 90' E

ENTER COORDINATES

Similar to **Input Line**, lines can also be specified by pressing the Tab key on the keyboard when a line is in the process of being drawn. This opens the Enter Coordinates dialog. See [Entering Coordinates on page 116](#).

LINE WITH ARROW

 Create a line or polyline with an arrow on one or both ends by selecting **CAD> Lines> Line With Arrow**, then clicking and dragging in the drawing area. The initial attributes of the line's arrow are set in the Arrow Defaults dialog. See [Arrow Defaults on page 338](#).

As with other lines, lines with arrows can be edited after they are created and connected to form polylines provided that they share the same style attributes. See [Editing Line-Based Objects on page 145](#) and [Line Specification Dialog on page 202](#).

You can also create arcs with arrowheads. See [Arc with Arrow on page 209](#).

 If either end of a Line with Arrow is snapped to an object, it maintains its connection if that object is moved. See [Text Arrows on page 352](#).

SUN ANGLE

 **Sun Angles** let you specify the date, time, latitude, and longitude that the program uses when calculating the angle of the Generic Sun as well as the direction and length of sun shadows. See [Sun Angles and Shadows on page 778](#).

NORTH POINTER

 The **North Pointer** tool is used to define the direction of true north in a plan. The direction of north does not affect the orientation of the Snap and Reference grids, but it does determine the direction of bearing information as well as how shadows and conditioned area totals are calculated. See [North Pointer on page 778](#).

If a **North Pointer** is not used, north is assumed to be straight up on screen in plan view.

DISCONNECT EDGES

 Select **CAD> Lines> Disconnect Edges**, then click on the edge of a polyline-based object to disconnect that edge from the rest of the polyline. See [Disconnect Edges on page 142](#).

When **Connect CAD Segments** is toggled off, CAD objects will not join to form a single polyline, either as they are drawn or when edited. See [Polylines on page 214](#).

SAME LINE TYPE EDIT HANDLES

A new CAD line can also be drawn using the Same Line Type edit handles on an existing CAD object. The start point of the new line is located at one end of the existing object and shares its line color, weight, style, and its layer. If the object has an arrow, its attributes are also inherited. See [Line Style Panel on page 204](#) and [Arrow Panel on page 205](#).

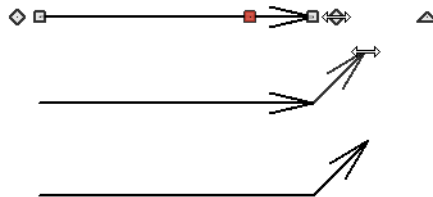

The Same Line Type edit handles are available for CAD lines, arcs, open polylines, and splines, but not for closed CAD shapes or CAD-based architectural objects. They can be turned off in the Preferences dialog if you wish. See [CAD Panel on page 74](#).

When **Connect CAD Segments** is disabled, the new CAD line will snap to the existing object, forming an open polyline or spline. When **Connect CAD Segments** is enabled, on the other hand, the two will remain separate objects.

Line Specification Dialog

 Select a CAD Line, Line With Arrow, or Text Line With Arrow and click the **Open Object** edit button to open the Line Specification dialog.

The settings on the panels in this dialog are found in the specification and defaults dialogs for a variety of different objects in the program.

The Line Specification dialog has the following panels:

LINE PANEL

The information on the LINE panel of the Line Specification dialog is similar to that found on the SELECTED LINE panels of various specification dialogs in the program.

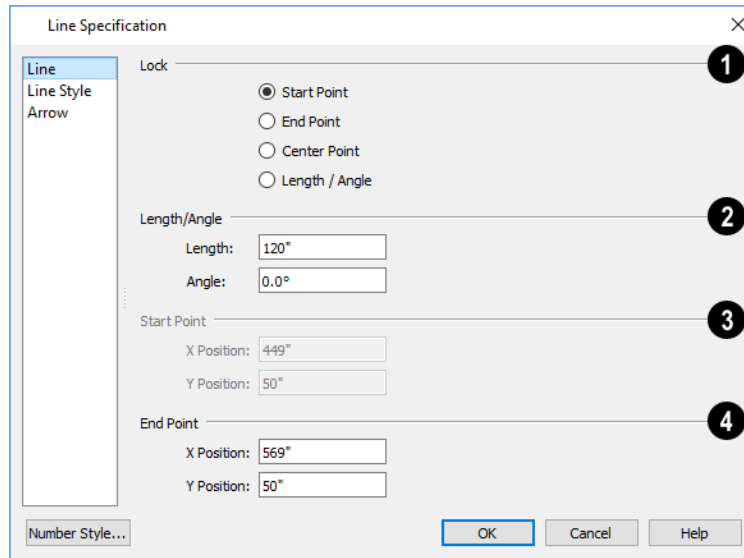

1 Lock

These lock options control how changing properties on this dialog affect the line.

- Select **Start** to keep the start of the line fixed when changing the length, angle, and end.
- Select **End** to keep the end of the line fixed when changing the length, angle, and start.
- Select **Center** to keep the center of the line fixed. Changing the length of the line moves the start and end of the line equally. Changing the angle rotates the line around the center.
- Select **Length/Angle** to keep the length and angle of the line segment fixed. Moving the start or end moves the other end so the length and angle of the line do not change.

When editing a polyline, moving the Start of a line segment moves the end of the previous connected line, if there is one. Similarly, moving the End of a line segment moves the start of the next connected line, if there is one.

2 Length/Angle

Specify the **Length** and **Angle** of the selected line.

3 Start Point

Specify the X and Y coordinates of the line's **Start Point**. Not available when the Start or Center Point is locked.

4 End Point

Specify the X and Y coordinates of the line's **End Point**. Not available when the Center or End Point is locked.

The format used here can be changed by clicking the **Number Style** button. See *Dialog Number/Angle Style Dialog on page 87*.

LINE STYLE PANEL

The LINE STYLE panel is found in the specification dialogs for many different objects. The settings here control the appearance of the lines and/or arcs that make up an object. Depending on the type of object selected, some settings may not be available. The available settings vary slightly depending on whether the object was drawn in a plan or a layout file.

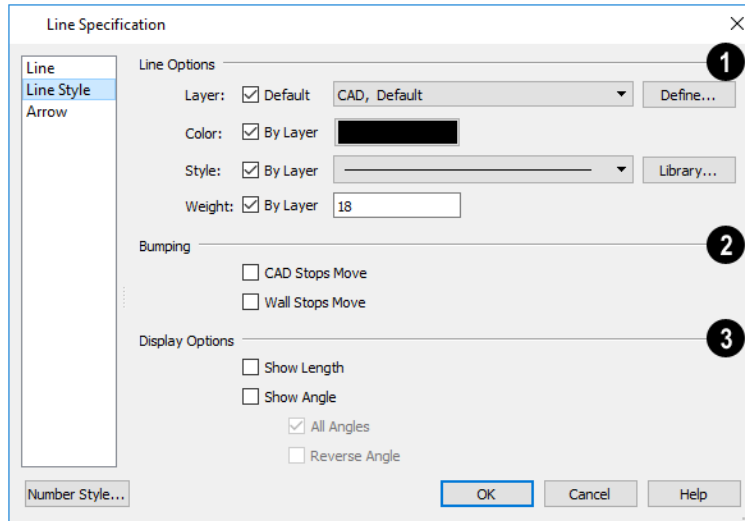

1 Line Options

- Check **Show Border** to display a border around the selected Picture file. Not available for other object types. See [Pictures on page 801](#).
- Specify the line **Color** used to represent the selected object. Check **By Layer** to use the color assigned to the object's layer or click the Color bar to select a different color. See [Select Color Dialog on page 134](#).

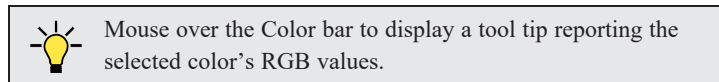

- Specify the line **Style** used to represent the selected object. Check **By Layer** to use the line style assigned to the object's layer or click the drop-down list to select a different style.
- Define the **Line Weight** or check **By Layer** to use the **Line Weight** assigned to the object's layer. See [Line Weights on page 950](#).

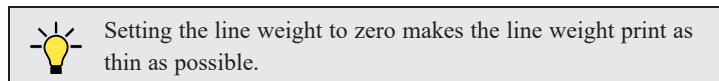

2 Bumping

Specify the desired **Bumping** behaviors for the selected object(s). These options only function when **Bumping/Pushing** is enabled. See [Bumping/Pushing on page 166](#).

- Check **CAD Stops Move** to bump the selected object into other CAD or CAD-based objects as it is moved, and/or to push the other object(s).
- Check **Wall Stops Move** to stop the selected object when it bumps into a wall. Walls cannot be pushed by other objects. Not available in layout files.

3 Display Options

Select the desired **Display Options**. These options not available for CAD Box- or CAD Circle-based objects, or for North Pointers, or Sun Angles.

- Check **Show Length** to show the length of each line centered above the line.
- Check **Show Angle** to show the angle of each line centered below the line. If the object is an arc, it's radius will also display.

The **Length** and **Angle** formats are specified in the CAD Defaults dialog. See *CAD Defaults Dialog on page 193*.

- Uncheck **All Angles** to show only those angles that are neither horizontal nor vertical. This is automatically checked when **Show Angle** is checked.
- Check **Reverse Angle** to reverse the angle by 180°. This may be helpful when showing a line's bearing, since the direction a line is drawn from start point to end point defines its bearing.

An additional **Display Options** setting is available In the Picture File, Metafile, and PDF File Box Specification dialogs. See *Pictures, Images, and Walkthroughs on page 794*.

- Check **Show Outline** to display the selected object's border polyline.

ARROW PANEL

The ARROW panel is available for any line, arc, open polyline, or spline that can have an arrow: including dimension lines. The defaults for arrows are set in the Arrow Defaults dialog. See *CAD Defaults and Preferences on page 193* and *Dimension Defaults Dialog on page 313*.

A line, polyline, or spline with an arrow can be attached to other objects. It attaches to a closed polyline-based object along its edges, but can attach to an architectural object anywhere within its 2D symbol in plan view. If an arrow is attached to another object, deleting that object will also delete the arrow.

Some objects, notably Joist Direction Lines, do not have the Attach or Auto Position settings. Other objects, including closed polylines, Sprinkler Lines and Electrical connections are examples of objects that cannot have arrows at all.

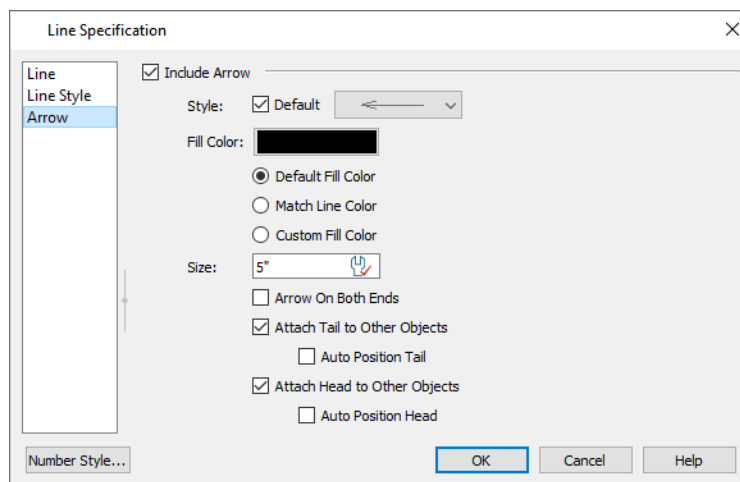

- Check **Include Arrow** to apply an arrow to the tail end of the selected object and enable the settings that follow.
- Select an arrowhead **Style** from the drop-down list or check **Default** to use the default arrowhead. Note that arrows with a white center have a transparent fill.

- The arrowhead's **Fill Color** displays in the Color bar. Click the bar to specify a custom color. See [Select Color Dialog on page 134](#).
- Select **Default Fill Color** to use the fill color specified in the Arrow Defaults dialog.
- Select **Match Line Color** to use the color specified on the LINE STYLE panel. See [Line Style Panel on page 204](#).
- **Custom Color** is selected automatically if you click the Color bar above.
- Specify the arrowhead's **Size**, measured from its front to its back.
- Check **Arrow on Both Ends** to place an arrowhead on both ends of the selected object.
- When **Attach Tail to Other Objects** is checked, the tail end of the arrow will attach to another object when snapped to it, and will maintain its attachment if the object is moved. When this is checked and the arrow is selected, its tail end edit handle will display the Selected Edge Handle Fill color.
- Check **Auto Position Tail** to have the tail end update its position on the object it is attached to if either object is moved. See [Auto Position Arrows on page 353](#).
- When **Attach Head to Other Objects** is checked, the head of the arrow will attach to another object when snapped to it, and will maintain its attachment if the object is moved. When this is checked and the arrow is selected, its arrow end edit handle will display the Selected Edge Handle Fill color.
- Check **Auto Position Head** to have the arrow end update its position on the object it is snapped to if either object is moved.

Drawing Arcs - Arc Creation Modes

There are two Arc Creation Modes that control how arcs and arc-based objects are drawn. Select **Edit> Arc Creation Modes** to select a mode.

The program remembers the last creation mode used between sessions. Once drawn, all arcs are edited similarly. See [Editing Arc-Based Objects on page 147](#).

Before deciding which Arc Tool or Arc Creation Mode is best for the project at hand, it is helpful to be familiar with the different components that make up an arc.

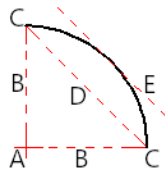

- A. **Center** - the point the arc is drawn about.
- B. **Radius** - the distance from the center to the arc.
- C. **Start / End** - where the arc begins and ends.
- D. **Chord** - the straight line between the start and end point.
- E. **Tangent** - a straight line that intersects an arc and is perpendicular to the radius of the arc at that point.

FREE FORM ARC

Free Form Arc mode allows you to define an arc by clicking and dragging along the desired path.

To draw a Free Form arc

1. Select **CAD> Arcs> Draw Arc** , then click at the arc's start point.
2. Move the pointer along the desired curve while dragging to curve the arc.
3. Release the mouse button at the end point to complete the arc.

ARC ABOUT CENTER

 **Arc About Center** mode allows you to draw an arc by defining the center and then the start and end points.

To draw an Arc About Center

1. Select **CAD> Arcs> Draw Arc** , then click once to define the center point.
2. Click and drag from the start point of the arc to its end point.
3. Or, click and drag an arc. The Current Point is used as the center. See [The Current Point on page 197](#).

Arc Tools

 Select **CAD> Arcs** to display the submenu of Arc Tools.



DRAW ARC

 The method used to draw an arc using **Draw Arc** depends on which Arc Creation Mode is currently active. Once drawn, an arc can be edited. See [Editing Arc-Based Objects on page 147](#).

INPUT ARC

 An arc can be drawn to exact specifications using the New CAD Arc dialog.

To use the Input Arc tool

1. Select **CAD> Points> Place Point** , then click the screen to place a CAD point. This is the Current Point, and will be the start point for the new arc. See [The Current Point on page 197](#).
2. Select **CAD> Lines> Input Arc**  to open the New CAD Arc dialog.
The New CAD Arc dialog can also be opened by double-clicking the **Arc Tools**  parent button.
3. If necessary, specify the Start Point.
4. Specify the method used to define the arc's Direction, then define its angle.
5. Define the arc's Radius. In order to create an arc, a value greater than 0 must be specified.
6. Define the arc's Extension, or length, using one of the three methods. In order to create an arc, one of these values must be greater than 0, and only one method should be used.
7. Click **OK** to close the dialog and draw the arc.

NEW CAD ARC DIALOG

1 Start Point

The **X Position** (horizontal) and **Y Position** (vertical) coordinates of the **Start Point** for the new arc display here. They can also be changed, if you wish.

2 Direction

Specify how you want to define the arc's **Direction**, then specify its angle.

- The **Start Direction** defines the angle of the tangent from the arc's start point.
- The **Chord Direction** defines the angle of the arc's chord from the start point.

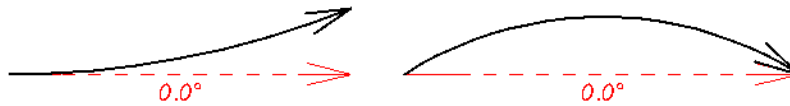

Start Direction at 0° vs Chord Direction at 0°

3 Curve

- Define the arc's **Radius**.
- Select the direction that the arc curves: either to the **Right/Clockwise** or to the **Left/Counterclockwise**.

4 Length

Control the length of the arc by defining one of these:

- A. **Arc Angle** - the arc's central angle as measured between the radii of both start and end points.
- B. **Arc Length** - the length of the arc along its curve from one endpoint to the other.
- C. **Chord Length** - the linear distance between start and end point.

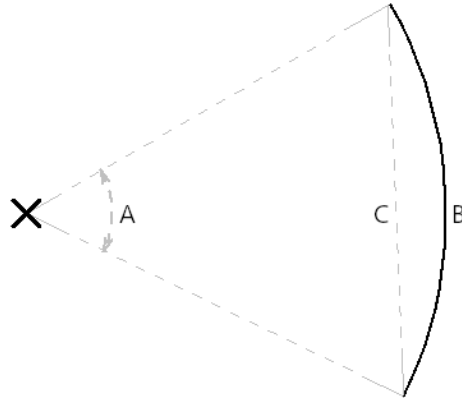

 Click the Number Style button to change the units used in dialogs. See [Dialog Number/Angle Style Dialog on page 87](#).

ARC WITH ARROW

 You can create an arc with an arrow on one or both ends, using the **Arc With Arrow** tool. Draw an **Arc With Arrow** like a regular arc. When you release the mouse button, the arc has an arrowhead at the end. The default attributes of the arrow are determined by the settings in the Arrow Defaults dialog. See [Arrow Defaults on page 338](#).

As with regular arcs, arcs with arrows can be edited after they are created. See [Editing Arc-Based Objects on page 147](#) and [Arc Specification Dialog on page 209](#).

Continue to draw connected lines and arcs to form a polyline with an arrowhead at the end. The arrowheads display only at the free ends, not where the lines connect. See [Polylines on page 214](#).

Lines with arrowheads can also be created. See [Line With Arrow on page 201](#).

 A line can be converted to an arc or vice versa by selecting the line, pressing and holding down the Alt key, then using the edit handle at either end to bend the line.

Arc Specification Dialog

 Select an arc and click the **Open Object** edit button to open the Arc Specification dialog.

The settings on the ARC panel are also found on the SELECTED ARC panels for many objects.

ARC PANEL

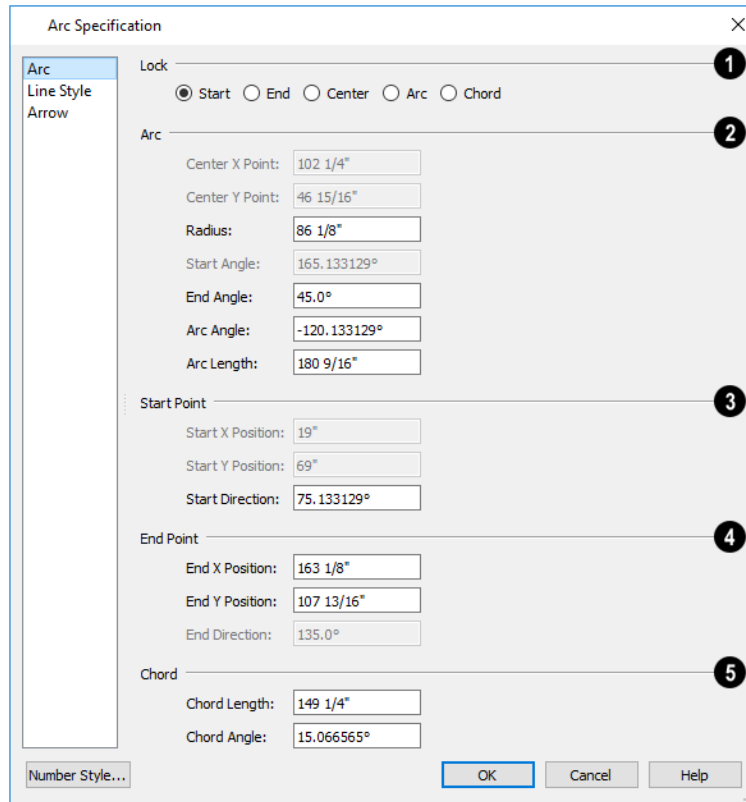

1 Lock

These options control how changing properties in this dialog affects the arc.

- **Start** - Select this option to keep the start fixed when changing the arc, chord, or end.
- **End** - Select this option to keep the end fixed when changing the arc, chord, or start.
- **Center** - Select this option to keep the center of the arc fixed when changing the arc.
- **Arc** - Select this option to keep the arc fixed when changing the arc location.
- **Chord** - Select this option to keep the arc chord fixed when changing the arc radius.

2 Arc

These parameters define the arc. Various controls are disabled depending on what lock option is used.

- **Center X Point** - Specify the X coordinate for the center of the arc.
- **Center Y Point** - Specify the Y coordinate for the center of the arc.
- **Radius** - The distance between the center of the arc and the arc surface.

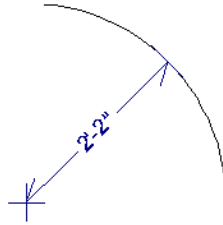

- **Start Angle** - Specify the angle that a line drawn from the arc center to the arc start makes with a horizontal line to the right.
- **End Angle** - Specify the angle that a line drawn from the arc center to the arc end makes with a horizontal line to the right.
- **Arc Angle** - The angle between the center of the arc and each end.

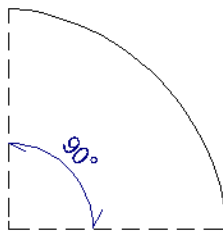

- **Arc Length** - The length of the arc along the curve.

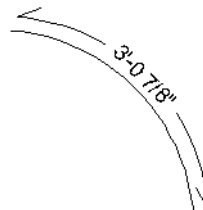

- Uncheck **Automatic Facet Angle** to specify the **Facet Angle**, which is the angle at which the surfaces of a curved 3D object are broken in 3D views. The default value is 7.5°; a smaller value produces a smoother curve while a larger value may generate more quickly in 3D views. These settings are only available on the SELECTED ARC panel for some CAD-based architectural objects such as Slabs. See *Architectural vs CAD Objects on page 111*.

3 Start Point

These values define the start point of the arc. The Position settings are disabled when the Start is locked.

- **Start X Position** - Specify the X coordinate for the beginning of the arc.
- **Start Y Position** - Specify the Y coordinate for the beginning of the arc.
- **Start Direction** - Specify the angle of a tangent line at the start of the arc.

4 End

These values define the end point of the arc. The Position settings are disabled when the End is locked.

- **End X Position** - Specify the X coordinate for the end of the arc.
- **End Y Position** - Specify the Y coordinate for the end of the arc.
- **End Direction** - Specify the angle of a tangent line at the end of the arc.

5 Chord

These values define the chord of the arc.

- **Chord Length** - The straight line distance between the two ends of the arc.

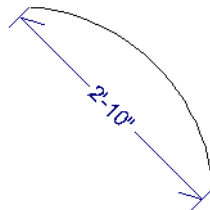

- **Chord Angle** - Specify the angle of the chord (the imaginary straight line going from the start of the arc to the end of the arc).

LINE STYLE PANEL

For information about the LINE STYLE panel, see [Line Style Panel on page 204](#).

ARROW PANEL

For information about the ARROW panel, see [Arrow Panel on page 205](#).

Circle Tools

- Select **CAD > Circles** to access the Circle Tools.

CIRCLE



Draw a **Circle** by dragging across the diameter. If a small circle is needed, draw a larger circle and then resize it.

Use the Circle Specification dialog to accurately define size, position and other attributes. See [Circle/Oval/Ellipse Specification Dialog on page 213](#).

DRAW CIRCLE ABOUT CENTER

- ⊕ Select **CAD > Circles > Circle About Center** to create a circle by dragging the radius out from the center point.

To draw a Circle About Center

1. Click the **Circle About Center**  tool.
2. Click the screen to define the center.
3. Drag the radial distance and release the mouse button. If you are using **Object Snaps** , both the center point and the radius snap to any appropriate nearby CAD object, intersection or point.

OVAL

 An **Oval** is a four-arc approximation of an ellipse. To draw an oval, select **CAD> Circles> Oval**, then click and drag at an angle to define the oval's maximum height and width.

Once an oval is created, it can be edited. See [Editing Circles, Ovals and Ellipses on page 162](#) and [Circle/Oval/Ellipse Specification Dialog on page 213](#).

ELLIPSE

 An **Ellipse** is a set of points with a constant combined distance from two points called foci. An ellipse looks like a stretched circle, or a circular surface viewed at an angle. To draw an ellipse, select **CAD> Circles> Ellipse** and drag at an angle to define its maximum height and width.

Once an ellipse is created, it can be edited. See [Editing Circles, Ovals and Ellipses on page 162](#) and [Circle/Oval/Ellipse Specification Dialog on page 213](#).

Circle/Oval/Ellipse Specification Dialog

Select a circle, oval or ellipse and click the **Open Object**  edit button to open the CAD Circle, Oval or Ellipse Specification dialog.

The CAD Circle, Oval, and Ellipse Specification dialogs are almost exactly the same. The Oval and Ellipse Specification dialogs have an additional setting for **Angle** on the GENERAL panel.

GENERAL PANEL

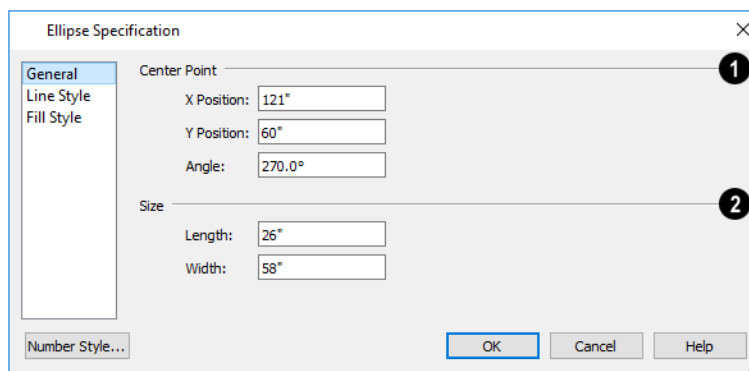

1 Center Point

Specify the position of the circle, oval or ellipse's **Center Point**.

- Specify the **X Position** and **Y Position** of the center of the circle, oval or ellipse.
- Specify an oval or ellipse's **Angle**. Not available for circles.

2 Size

Specify the **Length** and **Width** of an oval or ellipse, or the **Diameter** and **Radius** of a circle.

LINE STYLE PANEL



For information about the LINE STYLE panel, see [Line Style Panel on page 204](#).

FILL STYLE PANEL

For information about settings on this panel, see [Fill Style Specification Dialog on page 131](#).

Polylines

 A polyline consists of two or more line and/or arc segments that are attached at their endpoints. Select **CAD> Boxes> Rectangular Polyline**, then click and drag from corner to corner to create a rectangular-shaped, closed polyline. A closed polyline measuring 2'x 2' (600 mm x 600 mm) can also be created by clicking once while the **Rectangular Polyline** tool is active.

When **Object Snaps**  and **Connect CAD Segments**  are enabled, you can also create a polyline by drawing lines and/or arcs end-to-end, allowing the end of each new object to snap to the end of the previous one. See [Defaults, Preferences, and Edit Behaviors on page 137](#).

Line- and arc-based objects will only snap together to form a polyline if they are on the same layer and share identical attributes such as color, line style, and arrow specifications.

If one end of the polyline is connected to the other, it becomes a closed polyline. Closed polylines can be adjusted in a variety of ways that open polylines cannot. For example, closed polylines can be assigned a fill pattern and/or turned into special 3D objects such as slabs or countertops that display in 3D views.

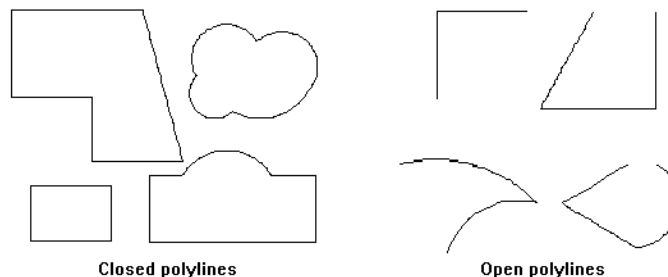

Lines and polylines can be distinguished by the edit handles that display when you select each. A line displays an edit handle at each end and one in the middle. If more than three edit handles display, the object is a polyline.



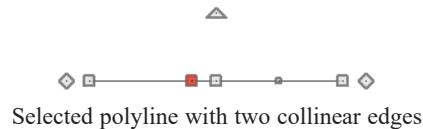

Selected line

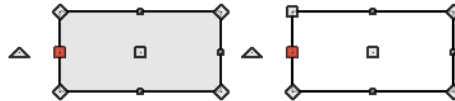

Lines that appear connected to a polyline may prove to be unconnected when selected.

For example, the two polylines in the following image appear identical until their left edges are selected. The entire polyline on the left is highlighted, showing it is a closed polyline. The polyline on the right, however reveals that its left edge is not fully attached. In contrast, the left edge of the polyline on the left is part of the larger polyline unit.



The **Close Polyline**  edit tool can be used to connect the edges of an open polyline. This tool adds a segment between the two open ends, closing the gap between them. See [Close Polyline on page 155](#).

Polylines can be copied, moved, reshaped, or resized as a single unit. Additionally, the individual segments can be edited. See [Disconnect Edges on page 142](#).

Once created, polylines can be edited in a variety of ways. See [Editing Open Polyline-Based Objects on page 151](#) and [Editing Closed Polyline-Based Objects on page 155](#).

Polyline Specification Dialog

 Select an open polyline, closed polyline, spline, Sprinkler Line polyline, or Electrical connection and click the **Open Object** edit button to open the Polyline Specification dialog.

The information on the FILL STYLE panel of the Polyline Specification dialog is similar to that for many other objects in the program. See [Fill Style Specification Dialog on page 131](#).

The panels that are available in the Polyline Specification dialog will vary, depending on the attributes of the selected polyline as well as those of its selected edge.

POLYLINE PANEL

The POLYLINE panel is found in the specification dialogs for a variety of objects throughout the program. It states:

- The total number of **Polylines** or **Holes Selected**;
- The **Length** of an open polyline;
- The **Perimeter** of a closed polyline;
- The **Area** of a closed polyline;
- The **Volume** of a closed polyline;
- The **Number of Lines** that form an open polyline or the perimeter of a closed polyline or polyline hole;
- The **Number of Holes** located inside of a closed polyline;
- The **Hole Perimeter** is the total length of the perimeter(s) of any holes inside of a closed polyline;
- The **Hole Area** is the total area of the holes inside of a closed polyline.

If the polyline is not closed, the Area and Volume are described as “Not closed”. The Volume of a 2D polyline will always be 0, even if it is closed.

If multiple objects of the same type are selected, the combined totals of these values are stated.

SPLINE PANEL

The SPLINE panel has a single option and is only available when the selected object is a spline. See *Splines on page 219*.

New Segment Angle:

- **New Segment Angle** - Specify the angle between line segments that are used to draw the spline. Specifying a smaller angle makes the spline smoother. Specify a larger angle to draw the spline faster.

SELECTED LINE PANEL

The SELECTED LINE panel is available when the selected edge of the polyline is a line as opposed to an arc and is not available if the selected object is a spline. See *Editing Line-Based Objects on page 145*.

Moving the Start of a line segment moves the end of the previous connected line, if there is one. Similarly, moving the End of a line segment moves the start of the next connected line, if there is one.

This panel is similar to the LINE panel of the Line Specification dialog. See *Line Panel on page 203*.

SELECTED ARC PANEL

The SELECTED ARC panel is available when the selected segment of the polyline is an arc as opposed to a line. It is not available if the selected object is a spline.

This panel is similar to the ARC panel of the Arc Specification dialog. See *Arc Panel on page 210*.

LINE STYLE PANEL

This panel is similar to the LINE STYLE panel in the Line Specification dialog. See *Line Style Panel on page 204*.

FILL STYLE PANEL

The FILL STYLE panel is found in the specification dialogs for a variety of objects in the program. See *Fill Style Specification Dialog on page 131*.

ARROW PANEL

The ARROW panel is available for most open polylines and splines and is similar to the ARROW panel of the Line Specification dialog. See *Arrow Panel on page 205*.

The ARROW panel is not available for closed polylines, Sprinkler Lines, or Electrical Connections.

COMPONENTS PANEL

The COMPONENTS panel is available for a selected Sprinkler Line or Sprinkler Spline. See *Sprinkler Tools on page 897*.

The information on this panel can be used in the materials list. See *Components Panel on page 921*.

Box Tools

 Select **CAD> Boxes** to access the Box Tools.

RECTANGULAR POLYLINE

 A **Rectangular Polyline** can be created in either of two ways:

- Click in the drawing area to place a 24" x 24" square polyline at that location.
- Click and drag from corner to corner to draw a rectangle of any size.

CAD polylines can also be created by connecting CAD lines and/or arcs. See [Polylines on page 214](#).

Once created, a rectangular polyline can be edited into any shape or converted to a 3D object. See [Editing Closed Polyline-Based Objects on page 155](#).

BOX

 Select **CAD> Boxes> Box** to draw a 2D rectangular polygon shape. CAD Boxes are drawn from corner to corner, forming a rectangle.

The sides of a Box can be resized, but unlike a polyline, a Box always has four 90° corners. See [Editing Box-Based Objects on page 158](#) and [Box Specification Dialog on page 218](#).

CROSS BOX

 Use the **Cross Box** tool to create a 2D box with an X-shaped cross in the interior to represent framing in a cross section detail.

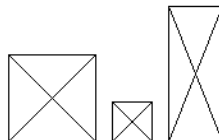

In cross section/elevation views, Cross Boxes are used to represent joists and rafters members that are perpendicular to and cut by the camera's clip plane. See [Cross Section/Elevation Views on page 744](#).

BLOCKING BOX

 Use the **Blocking Box** tool to create a 2D box with a diagonal line in the interior to represent blocking or bridging in a cross section detail.



INSULATION

 Use the **Insulation** tool to draw insulation in cross section details. Insulation Boxes are like 2D boxes and Cross Boxes; however, unlike these other types of boxes, Insulation Boxes do not have perimeter lines: only the curves of the insulation pattern.

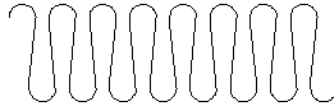

Box Specification Dialog

 Select a CAD box, a framing box, a Cross box, a Blocking box, or an Insulation box and click the **Open Object** edit button to open the Box Specification dialog. See [Box Tools on page 217](#).

GENERAL PANEL

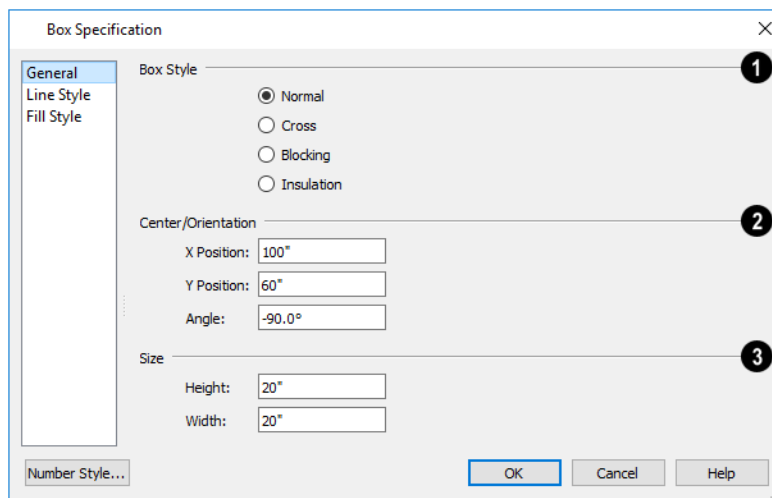

1 Box Style

Specify a **Box Style**. Select **Normal** to specify a normal box, **Cross** to specify a cross box, or **Insulation** to specify an insulation box. If multiple CAD boxes are selected, “No Change” may display.

2 Position

Define the **Position** of the box.

- Specify the **X Position** and **Y Position** of the center of the box.
- Specify the **Angle** of the box.

3 Size

Define the **Size** of the box by specifying its **Height** and **Width**.

LINE STYLE PANEL

For information about the LINE STYLE panel, see [Line Panel on page 203](#).

FILL STYLE PANEL



For information about the FILL STYLE panel, see [Fill Style Specification Dialog on page 131](#).

Splines

 A Spline is a curve that passes smoothly through a set of points. Splines are typically used in situations where there is an irregular curve. A contour line is a typical example. Splines are useful wherever a free-flowing curve is needed.

Once created, splines can be selected and edited. See [Editing Spline-Based Objects on page 160](#) and [Polyline Specification Dialog on page 215](#).

To use the Spline tool

1. Select **CAD> Spline** .
2. Click and drag to draw the first spline segment just as you would a line. A single spline segment looks identical to a line, in fact. You may need to turn off **Angle Snaps**  to draw freely.

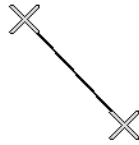

Spline line drawn between two points

3. Draw the second segment from the end of the first at a different angle. **Object Snaps**  should be on to assure that new segments attach correctly to the ends of previous segments.



Spline polyline drawn between three points

4. As soon as two straight spline segments connect end-to-end, the straight segments become a curve that passes through the endpoints defined by the original segments. Each point is called a vertex.
5. Draw a few more segments, connecting each to the free end of a previously drawn segment.

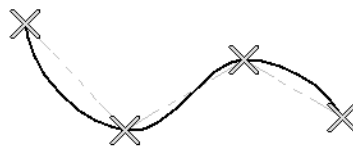

Spline polyline drawn between four points

6. Notice as additional segments are drawn that the spline changes the curvature of the previous segment to create a continuous curve between the last three points.

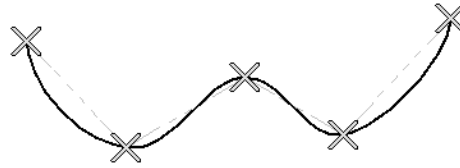

Spline polyline drawn between five points

7. Form a closed spline by drawing a segment between its two free ends.

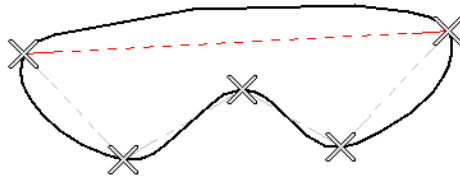

Draw additional segment to close polyline

8. The result is an irregular curve that flows smoothly through each vertex.

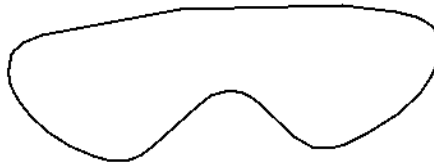

Spline-based objects will only snap together to form a single spline if they share identical attributes such as color, line style, and arrow specifications.

Note: Spline-based objects with the same properties will only snap together when Connect CAD Segments is enabled. See [Connect CAD Segments on page 140](#).

Displaying CAD Objects

As with architectural objects, the display of CAD objects is controlled in the Layer Display Options dialog. See [Layer Display Options Dialog on page 126](#).

CAD objects can be drawn in plan views, layout, and cross section/elevation views. They are 2D objects only, though, so they cannot be seen in any view other than the one they are drawn in and are never visible in camera views or overviews. See [Architectural vs CAD Objects on page 111](#).

DRAWING GROUPS

Each object in a plan or layout file is included in a Drawing Group, which influences whether it displays in front of or behind other objects. By default, all CAD objects are placed in the same Drawing Group. Their drawing order relative to one another is based on the order in which they were placed: an object will display in front of any objects that were created before it was.

Once created, however, the drawing order of CAD objects can be customized. See [Drawing Groups on page 128](#).

SHOW LENGTH AND ANGLE

You can specify that line segment length and angle display along a CAD line, CAD arc, or along each segment of a CAD polyline. If the segment is an arc, its radius also displays. See *Line Style Panel on page 204*.

The format of the length and angle can be specified in the CAD Defaults dialog. See *CAD Defaults Dialog on page 193*.

Line length and angle indicators use the Text Style assigned to the layer that their CAD object is on. See *Text Styles on page 360*.

ENDCAPS

Dashed lines often display endcaps, which are dashes of a particular length. You can specify the Printed Length of endcaps in the Preferences dialog. See *CAD Panel on page 74*.

LINE STYLES

A selection of line styles is available for you to apply to CAD and some architectural and terrain objects. See *Line Style Panel on page 204*.

FILL STYLES

A selection of fill styles can be applied to closed CAD and CAD-based architectural objects. See *Fill Styles on page 130*.

Walls, Railings, and Fencing

Chapter 11

To draw a wall, select one of the *Wall Tools on page 226*, then click and drag in a line to the approximate length that you want. When you enclose an area with walls, a room is created, complete with floor and ceiling. The *Door Tools on page 367* and *Window Tools on page 394* can be used to add openings, while *Dimensions on page 311* are used to position walls and openings with accuracy.

Walls are the single most important structural component in Home Designer. They define *Rooms on page 279*, are used to create *Foundations on page 481*, and even influence how *Roofs on page 556* are built. It is helpful to understand how Wall Type Definitions, wall connections, and wall alignment all affect your design.

TOPICS

Wall, Railing, and Fencing Defaults	223
Wall Tools	226
Railing and Deck Tools	227
Fencing Tools	230
Exterior and Interior Walls	230
Foundation Walls	231
Pony Walls	232
Room Dividers and Invisible Walls	233
Polygon Shaped Decks	234
Wall Hatching	235
Creating Walls	236
Connecting Walls	238
Displaying Walls	240
Measuring Walls	242
Editing Walls	244
Edit Handles for Walls	247
Editing Straight/Curved Wall Combinations	249
Aligning Walls	249
Roof Directives in Walls	252
Attic Walls	254
Stepped and Raked Walls	255
Wall Type Definitions	256
Wall Type Definitions Dialog	259
Wall Specification Dialog	262
Railing and Fencing Specification Dialogs	274
Wall Hatching Specification Dialog	278

Wall, Railing, and Fencing Defaults

 There are several defaults dialogs for walls. Default Settings can be accessed by selecting **Edit > Default Settings**. Click the arrow next to “Walls” to display the walls sub-headings. Select a subheading and click the **Edit** button to open the Wall Defaults dialog associated with your selection:

The defaults dialog for each wall tool can also be accessed by double-clicking the tool’s toolbar button.

The settings in the various wall defaults dialogs determine what wall types are drawn when the different wall tools are used. It is a good idea to be familiar with these settings and how they relate to your style of building. See [Wall Type Definitions on page 256](#).

GENERAL WALL DEFAULTS

 The General Wall Defaults dialog controls the general behavior and display attributes of all walls, railings and fencing.

For quick access, the **General Wall Defaults**  button can be added to the toolbar or you can press Alt+Q on your keyboard.

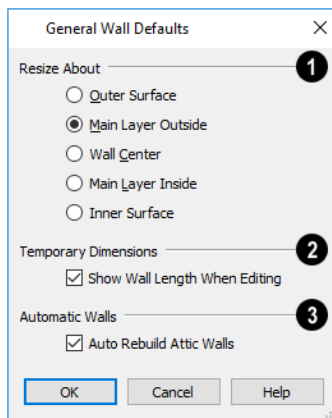

1 Resize About

These radio buttons determine what part of a wall retains its position when its wall type or wall type definition is changed. See [Resize About on page 249](#).

The **Resize About** location is also where any snap points will be located along a wall as it is drawn or connected to other walls, and is where a wall's length is measured.

- **Outer Surface** - Snap to and resize about the exterior surface. When a wall is resized, its exterior surface does not move.
- **Main Layer Outside** - Snap to and resize about the outer line of the Main Layer. When a wall is resized, the outer line of its Main Layer does not move.
- **Wall Center** - Snap to and resize about the center line. When a wall is resized, its center line does not move, but wall layers on either side may.
- **Main Layer Inside** - Snap to and resize about the inner line of the Main Layer. When a wall is resized, the inner line of its Main Layer does not move.
- **Inside Surface** - Snap to and resize about the interior surface. When a wall is resized, its interior surface does not move.

Note: In most circumstances, it is recommended that you Resize About the Main Layer Outside to avoid unexpected results.

2 Temporary Dimensions

Check **Show Wall Length When Editing** to display a temporary length dimension when a wall is drawn or edited. Wall length only displays when **Temporary Dimensions**  are on. See [Temporary Dimensions on page 325](#).

3 Automatic Walls

- Uncheck **Auto Rebuild Attic Walls** to prevent Attic walls from automatically generating when the model changes. When checked, Attic Walls are automatically generated. See [Attic Walls on page 254](#).



EXTERIOR AND INTERIOR WALL DEFAULTS DIALOGS

Specify the initial attributes of walls drawn using the **Exterior**  and **Interior Wall**  tools in the Exterior and Interior Wall Defaults dialogs. See [Wall Tools on page 226](#).

The panels in this dialog are the same as their respective panels in the Wall Specification dialog. See [Wall Specification Dialog on page 262](#).

FOUNDATION WALL DEFAULTS

Specify the initial attributes of walls created by the **Foundation Wall**  tool when it is either used manually or when a stem wall or pier foundation is generated in the Foundation Wall Defaults dialog. See [Foundation Walls on page 231](#).

The Foundation Wall Defaults dialog also controls the wall type drawn by the **Retaining Wall**  tool. Unlike other walls, **Retaining Walls**  are used to modify your terrain rather than build a structure. See [Terrain Wall and Curb Tools on page 858](#).

Footing size and other information used when building stem wall or pier foundations is also specified here. For more information, see [Foundation Defaults Dialog on page 482](#).

The panels in this dialog are the same as their respective panels in the Wall Specification dialog. See [Wall Specification Dialog on page 262](#).

PONY WALL DEFAULTS

Specify the initial attributes of walls drawn using the **Pony Wall**  tool. See [Pony Walls on page 232](#).

The **Display in Plan** and **Display of Openings in Non-Displayed Parts of Walls** settings on the WALL TYPES panel of the Pony Wall Defaults dialog are static in views sent to layout. See [Keeping Layout Views Current on page 929](#).

The panels in this dialog are the same as those in the Wall Specification dialog. See [Wall Specification Dialog on page 262](#).

RAILING AND DECK RAILING DEFAULTS

Specify the types of railings created when the Railing and Deck Railing tools are used. See [Railing and Deck Tools on page 227](#).

Note: By default, Railings and Deck Railings are drawn using two separate wall types: “Interior Railing” and “Deck Railing/Fence”. See [Wall Type Definitions on page 256](#).

The panels in these dialogs are the same as their respective panels in the Wall Specification dialog. See [Wall Specification Dialog on page 262](#).

GLASS WALL DEFAULTS

Specify the initial attributes of walls drawn using the **Straight Glass Wall**  tool. See [Glass Walls and Half-Walls on page 227](#).



The panels in this dialog are the same as their respective panels in the Wall Specification dialog. See [Wall Specification Dialog on page 262](#).

GLASS PONY WALL DEFAULTS

Specify the initial attributes of walls drawn using the **Straight Glass Pony Wall**  tool. See [Glass Walls and Half-Walls on page 227](#).

The panels in this dialog are the same as their respective panels in the Wall Specification dialog. See [Wall Specification Dialog on page 262](#).

HALF-WALL DEFAULTS

Specify the attributes of a solid railing drawn using either the **Straight Half Wall**  or **Curved Half Wall**  tool. See [Glass Walls and Half-Walls on page 227](#).

The panels in this dialog are the same as their respective panels in the Wall Specification dialog. See [Wall Specification Dialog on page 262](#).

FENCING DEFAULTS

Specify the initial attributes of walls drawn using either of the **Fencing Tools** . See [Fencing Tools on page 230](#).

The panels in this dialog are the same as their respective panels in the Wall Specification dialog. See [Wall Specification Dialog on page 262](#).

ROOM DIVIDER DEFAULTS

Specify the initial attributes of walls drawn using the **Room Divider**  tool. See [Room Dividers and Invisible Walls on page 233](#).

The panels in this dialog are the same as their respective panels in the Wall Specification dialog. See [Wall Specification Dialog on page 262](#).

WALL HATCHING DEFAULTS

Specify the initial attributes of **Wall Hatching**  tool. See [Wall Hatching on page 235](#).

The panels in this dialog are the same as their respective panels in the Wall Hatching Specification dialog. See [Wall Hatching Specification Dialog on page 278](#).

Wall Tools



Select **Build> Wall** to access the Wall Tools. The type of wall drawn by each wall tool is specified in its corresponding defaults dialog.



The **Curved Wall** tools are similar to their corresponding **Straight Wall Tools**. Select **Build> Wall** to access these tools as well.

EXTERIOR WALLS



The **Exterior Wall** and **Curved Exterior Wall** tools draw walls using the default wall type specified for exterior walls in the Exterior/Interior Wall Defaults dialog. See [Exterior and Interior Walls on page 230](#).

INTERIOR WALLS



The **Interior Wall** and **Curved Interior Wall** tools draw walls using the wall type specified for interior walls. The interior wall type is defined in the Exterior/Interior Wall Defaults dialog.

Note: Whether a wall is recognized as an exterior or interior wall by the program is determined by its position in the model, not by the tool used to draw it. See [Exterior and Interior Walls on page 230](#).

FOUNDATION WALLS



The **Foundation Wall** and **Curved Foundation Wall** tools draw foundation walls according to the information specified in the Foundation Defaults dialog. Foundation walls normally have a footing and can be drawn on any floor of the model, not just the foundation floor. See [Foundation Walls on page 231](#).

PONY WALLS





A **Pony Wall**, also called a split wall, is defined as a wall with two separate wall types, one for the upper portion and another for the lower portion.

The **Pony Wall** and **Curved Pony Wall** tools draw pony walls using the information specified in the Pony Wall Defaults dialog. You can also convert a normal wall into a pony wall and vice versa in the Wall Specification dialog. See [Pony Walls on page 232](#).

GLASS WALLS AND HALF-WALLS

 The **Straight Glass Wall** tool creates single-layer glass walls that do not cut the surfaces of the floor, ceiling, or adjacent walls. The wall type and other attributes of glass walls drawn with this tool are defined in the Straight Glass Wall Defaults dialog. See [Glass Wall Defaults on page 225](#) and [Partition Walls on page 239](#).

 The **Straight Glass Pony Wall** tool creates a pony wall with a glass upper partition. The height and other attributes of walls drawn with this tool are defined in the Straight Glass Pony Wall Defaults dialogs. See [Glass Pony Wall Defaults on page 225](#).

  The **Half-Wall** and **Curved Half-Wall** tools create solid railings: walls that are 36" (900 mm) high topped with a handrail. The height and other attributes of solid railings drawn with this tool are defined in the Half-Wall Defaults dialog. See [Half-Wall Defaults on page 225](#).

ROOM DIVIDERS

 **Room Dividers** are Invisible walls with a thickness of 0" (mm) that are used to define separate room areas in a plan. They can display in plan view but not in 3D views. See [Room Dividers and Invisible Walls on page 233](#).

WALL HATCHING

 The **Wall Hatching** tool applies a hatch pattern to a wall that displays in plan views. You must click the wall that you want to apply the hatch pattern to. You can then select the hatch and resize it if you want to only hatch a portion of a wall. See [Wall Hatching on page 235](#).

FIX WALL CONNECTIONS

 The **Fix Wall Connections** tool connects walls whose ends are within a few inches of each other but are not connected. See [Fix Wall Connections on page 239](#).

WALL BREAK

 The legacy **Wall Break** tool divides walls into separate segments. It is similar to the Break edit tool, but can be used to modify multiple walls without having to select them first. The Wall Break tool has been deprecated but can be activated using the hotkey Ctrl + B. In addition, it may be available if legacy toolbars have been migrated into Version 2022. It can also be added to the toolbars. See [Add Break on page 172](#).

DEFINE WALL TYPES

 The **Define Wall Types** tool opens the Wall Type Definitions dialog, where wall types can be created, copied and edited. See [Wall Type Definitions Dialog on page 259](#).

Railing and Deck Tools

 Railings are a special type of wall that have a specified height rather than building all the way to a room's ceiling height. Select **Build> Railing and Deck** to access the Railing and Deck Tools. Railings are typically used to define

interior spaces, while the various Deck tools are used to define exterior Deck rooms.

With the exception of the Polygon Shaped Deck tool, each of the tools in this family have both Straight and Curved versions, and are created and edited just like walls. See [Creating Walls on page 236](#).

To create a break in a railing for a stairway or other access, use a **Doorway** . This keeps the railing continuous and maintains room definition. See [Room Definition on page 280](#).

When first drawn, railings are specified as **No Locate**, which prevents **Auto Exterior Dimensions**  from locating them. This attribute may also be helpful if you do not want a railing to divide an area into two separate rooms. See [General Panel on page 262](#).

The attributes for railings when they are first drawn are defined in the Railing Defaults dialog. See [Railing and Deck Railing Defaults on page 225](#).

RAILINGS



The **Railing** and **Curved Railing** tools create railings that are primarily used to define interior spaces. The style and height of railings drawn with this tool are defined in Railing Defaults dialog. See [Railing and Deck Railing Defaults on page 225](#).

Railings are ideal for a number of tasks:

- Creating changes in floor and/or ceiling height. See [Floor and Ceiling Heights on page 293](#).
- Creating stairwells. See [Creating a Stairwell on page 535](#).



DECK RAILING



The **Straight Deck Railing** and **Curved Deck Railing** tools draw decks, complete with framing and bounded by a railing. If a foundation level exists, supports for the deck are also created. See [Decks on page 292](#).

When a room is defined using deck railing, its **Room Type** is automatically set to “Deck”. See [Decks on page 292](#).

DECK EDGES



The **Straight Deck Edge** and **Curved Deck Edge** draw decks complete with framing, but without a railing. No deck supports are created.



POLYGON SHAPED DECK

 The **Polygon Shaped Deck** tool opens the New Polygon Shaped Deck dialog, where you can specify the exact size and number of sides of a new polygonal deck room and then click in plan view to create that deck room. See *Polygon Shaped Decks on page 234*.

RAILING TYPES

A variety of railing types can be specified in the Railing and Deck Railing Specification dialogs. See *Rail Style Panel on page 274*. Available types include:

- **Baluster** creates railings composed of newel posts, balusters, a railing, and an optional bottom rail.
- **Solid** produces a framed railing wall, or Half Wall. See *Glass Walls and Half-Walls on page 227*.
- If **Panels** is selected, you can choose a panel style such as cable, glass, or ironwork from the library. See *Newels/Balusters Panel on page 276*.

By default, newels and balusters do not display in plan view, but their display can be turned on. See *Newels/Balusters Panel on page 276*.

WALL TYPES AND RAILINGS

Just like regular walls, railings are assigned a wall type: “Interior Railing”. This wall type has three layers: a framing layer in the middle and a layer of drywall on each side. See *Wall Type Definitions on page 256*.

You can use a different wall type definition for railings if you wish, but bear in mind that this wall type definition determines several important things:

- The railing’s appearance in plan view. See *Displaying Walls on page 240*.
- The actual thickness of Solid railings in 3D views.
- The extent of the floor platform, if a platform edge is defined by the railing is defined by the outer surface of the wall type. See *Floor and Ceiling Platforms on page 295*.
- If the railing is used to create a change in floor height, this wall type controls the structure and position of the partial wall built beneath the railing, if one is required. See *Floor and Ceiling Heights on page 293*.

If the railing is a type other than Solid, its sizing is specified on the NEWELS/BALUSTERS panel of the Railing Specification dialog, and the railing is centered along the width of the wall type. This will not be evident in plan view unless newels and balusters are set to display.

Deck Railing is also assigned a wall type: “Deck Railing/Fencing”. This wall type has a single framing layer and is recommended for use only with deck railing and fencing.

RAILINGS OVER WALLS

To produce a railing over a solid wall, specify it as both a Railing and a Pony Wall. See [Pony Walls on page 232](#).

To create a solid glass partition over a partial-height wall, specify the “Glass Shower” wall type as the Upper Wall.



To create a glass panel above a half wall

1. Draw a **Half Wall**  and open its specification dialog.
2. On the WALL TYPES panel of the Railing Specification dialog, check the box beside **Pony Wall**.
3. On the RAIL STYLE panel, select **Panel** and uncheck **Include Top Rail**, **Include Bottom Rail**, and **Raise Bottom**.
4. On the NEWELS/BALUSTERS panel, select “Solid” and adjust the Newels/Posts **Width** and **Spacing** values to meet your needs.
5. On the MATERIALS panel, specify a glass material for the Panel component.

Fencing Tools

Fencing is a special type of wall that is designed to follow the terrain rather than define a room with a flat floor platform.

 Select **Build> Fencing** or click the **Fencing Tools** to access the fencing tools. Fencing automatically follows the shape of the terrain. You can choose to have the fencing follow the terrain smoothly or to have each segment step as it follows the terrain. See [Rail Style Panel on page 274](#).

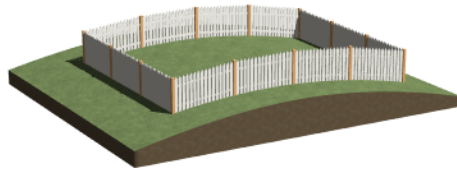

  The **Fencing** and **Curved Fencing** tools are used to draw fences, which are similar to railings but by default do not define room areas. Fencing is created and edited much like walls and railings, and normally used outside of a building and follows the shape of the terrain. See [Terrain on page 846](#).



Define the default fence style in the Fencing Defaults dialog. See [Fencing Defaults on page 225](#).

Exterior and Interior Walls

  Most walls are drawn using either the **Straight Exterior Wall** and **Straight Interior Wall** tools.

  Exterior and interior walls can also be drawn using the **Curved Exterior Wall** and **Curved Interior Wall** tools.

The only difference between the Exterior and Interior Wall Tools is the wall type used: Exterior Walls use a wall type set up to model a wall with siding, while Interior Walls model interior walls with sheetrock. See [Wall Type Definitions on page 256](#).

To draw a wall using a different wall type, you can change the default wall type for either tool in the Exterior and Interior Wall Defaults dialogs. You can also draw a wall using the default type and then change the wall type in the Wall Specification dialog. See [Wall Types Panel on page 270](#).

Whether a wall is recognized by the program as an actual exterior or interior wall is based on its position in the model, not by which tool you used to draw the wall.

- Any wall or wall segment that is entirely surrounded by interior room areas is considered to be an interior wall.
- Any wall or wall segment that defines an exterior room or is exposed to the outside of the building is considered to be an exterior wall. See [Room Types on page 282](#).

If a Framed wall separates an interior room area from an exterior room, hybrid room, or the outside of the building, it will have insulation counted for it in the Materials List. See [In the Materials List on page 242](#).

Foundation Walls



Foundation walls are similar to the interior and exterior walls but also have a footing. Foundation walls can either be created automatically when a foundation floor is created or manually by drawing them using the

Straight or **Curved Foundation Wall** tool. See [Building a Foundation on page 485](#).



The initial foundation wall type and footing size are specified in the Foundation Wall Defaults dialog. These values can be changed for individual walls in the Wall Specification dialog. See [Wall Specification Dialog on page 262](#).

You can draw a foundation wall on any floor of a plan, not just on the foundation level. Any wall can be specified as a foundation wall, regardless of the tool used to draw it. See [Foundation Panel on page 268](#).

Foundation walls are placed on the “Walls, Foundation” layer. In plan view, foundation wall footings are placed on the “Footings” layer; in 3D views, they are on the “Walls, Foundation” layer. See [Displaying Walls on page 240](#).

SLAB FOOTINGS

When a monolithic slab foundation is created, the slabs are defined by specially defined foundation walls that have footing widths equal to that of the wall type - by default, 16” (350 mm). For Garage curbs, the footings should be wider than the wall type. See [Foundation Panel on page 268](#).

Rooms defined by Slab Footings will have a Ceiling Height of 0 and a Monolithic Slab Foundation. See [Structure Panel on page 302](#).

BRICK LEDGES

Brick ledges can be produced in monolithic slab, stem wall, and grade beam foundations. They do not extend under door openings in monolithic slab foundations.

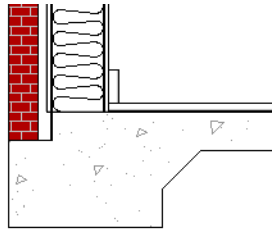

Brick ledges are represented in plan view:

- In stem wall and grade beam foundations, brick ledge lines are on the “Slabs” layer.
- In monolithic slab foundations, they are on the “Walls, Foundation” layer.

See *In Plan View on page 240*.

In order for a brick ledge to be produced, the foundation wall material directly under the brick ledge must be the “Concrete” Structure Type and the wall material that drops into the brick ledge must be the “Masonry” Type. See *Material Structure Types on page 724*.

Additional settings that control whether a brick ledge is produced as well as its size are found in the Wall Type Definition of the wall that is located above the brick ledge. See *Wall Type Definitions on page 256*.

- The width of the ledge is equal to that of the Exterior Layers of the wall type.
- The **Build Platform to Exterior of Layer** setting cannot be the wall type’s exterior layer.

If the floor platform inside of a brick ledge is hung on the foundation wall, **Subflooring to Wall Interior** must be checked in the Wall Specification dialog in order for a brick ledge to generate. See *Structure Panel on page 264*.

Pony Walls



A **Pony Wall**, sometimes called a split wall, is a wall with two separate wall types, one above the other.

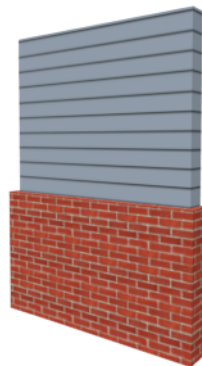

Walls drawn using the **Pony Wall**  tool are created using the wall types and other information specified in the Pony Wall Defaults dialog. See *Pony Wall Defaults on page 225*.

Most pony walls combine two exterior or two interior wall types; however, a pony wall can also produce an individual wall to be an exterior wall near its top and an interior wall near its bottom. See *Exterior/Interior Pony Walls on page 253*.

When a pony wall is also specified as a Railing, its upper wall is replaced by a railing. See *Wall Types and Railings on page 229*.



You can also convert a normal wall into a pony wall and vice versa in the Wall Specification dialog. See [Wall Types Panel on page 270](#).

The height where the upper portion meets the lower can be adjusted in 3D views using the wall's edit handles as well as in the Wall Specification dialog. The upper and lower sections of a pony wall are linked, so if either portion is modified along the division between the two, the other portion of the pony wall adjusts to match. See [Stepped and Raked Walls on page 255](#).

DISPLAYING PONY WALLS

You can specify whether the upper and lower portion of pony walls displays in plan view in the Pony Wall Defaults dialog. This **Display in Plan** option can also be set for individual walls in the Wall Specification dialog. See [Wall Types Panel on page 270](#).

Just as with other walls, the appearance of the portion of a pony wall that displays in plan view can be controlled. See [Displaying Walls on page 240](#).

Only the portion of a pony wall that displays can be snapped to; however, regardless of what part is displaying, the upper wall will be used to **Align with Wall Above** , and the lower part will be used to **Align with Wall Below** . See [Editing Walls on page 244](#) and [Aligning Walls on page 249](#).

By default, when a door or window is located entirely in one part of a pony wall, and that part is not displayed in plan view, the opening's outline is shown but the wall's layer lines and fill drawn through it. You can instead display openings in the non-displayed parts of pony walls the same as in the displayed parts, or not at all. See [Pony Wall Defaults on page 225](#).

If a window or door is completely contained by one part of a pony wall, it will display in plan view if the other part of the pony wall is shown; but the wall's layer fill pattern or Wall Hatching fill pattern will display over it.

The **Display in Plan** and **Display of Openings in Non-Displayed Parts of Walls** settings on the WALL TYPES panel of the Pony Wall Defaults are static in views sent to layout. See [Keeping Layout Views Current on page 929](#).

CHANGING WALL TYPES

The default upper and lower parts of a Pony Wall can be specified in the Pony Wall Defaults dialog. See [Pony Wall Defaults on page 225](#).

The upper and lower parts of a Pony Wall can be redefined as different wall types in the Wall Specification dialog. See [Wall Types Panel on page 270](#).

Room Dividers and Invisible Walls

 The **Room Divider** tool is used to define separate room areas in a plan; typically, by dividing a large room area into two or more smaller areas. See [Room Definition on page 280](#).

Common uses for Room Dividers include dividing areas of an open floor plan into areas with different purposes.

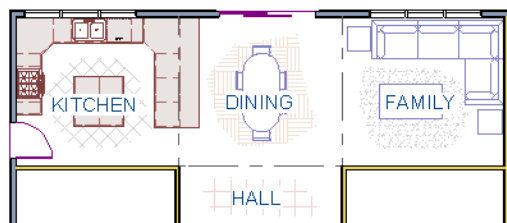



Room Dividers can also be used to define areas with different floor or ceiling materials or heights.

Room Dividers  are drawn using the attributes specified in the Room Divider Defaults dialog; which means they are simply walls that are specified as Invisible and have a single layer of an “Air Gap” material with a thickness of 0” (mm).

If a zero-thickness **Room Divider**  separates two rooms with different floor and/or ceiling heights, its wall type will be changed to the current plan’s default Interior Wall so that the platform step created by the height difference can be enclosed. See *Floor and Ceiling Platforms on page 295*.

INVISIBLE WALLS

Any wall, regardless of its wall type or thickness, can also be specified as Invisible - or vie versa - in the Wall Specification dialog or by clicking the **Make Wall(s) Invisible**  or **Make Wall(s) Visible**  edit button. See *General Panel on page 262*.

Room Dividers are placed on the “Walls, Invisible” layer, as are walls that are specified as Invisible. See *Room Divider Defaults on page 226*.

Walls specified as Invisible can display in plan view but not in 3D views or the Materials List. See *Displaying Walls on page 240*.

It is not possible to place doors or windows into an Invisible wall; however, if a wall with openings in it is specified as Invisible, any openings in it will remain.

IMPORTANT NOTES ON INVISIBLE WALLS

- Floor, wall and ceiling areas are calculated separately for rooms divided by Invisible walls.
- Invisible walls are ignored by the **Auto Place Outlets**  tool; it functions as though they were not present.
- Cabinets, fixtures and furniture can be moved freely through Invisible walls.
- Invisible walls can be drawn through a cabinet to attach to the wall behind.
- Room Dividers are automatically generated to connect “island” rooms to the larger structure around them. See *Room Definition on page 280*.

Polygon Shaped Decks

 Select **Build> Railing and Deck> Polygon Shaped Deck** to open the New Polygon Shaped Deck dialog and create a polygon shaped deck with regular sides.

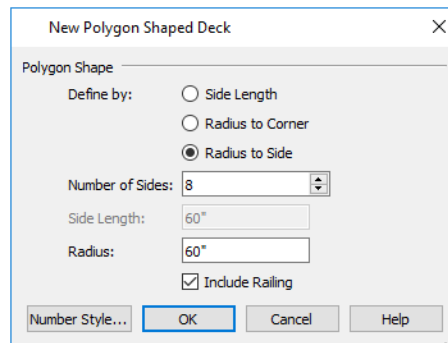

The settings in this dialog are saved between program sessions.

To create a polygon shaped deck

1. Click the radio button beside an option to specify whether you want to **Define Polygon by Side Length, Radius to Corner** or **Radius to Side**.
2. Specify the desired **Number of Sides**.
3. Specify the desired **Side Length** or,
4. Specify the desired **Radius**.
5. Uncheck **Include Railing** to produce a deck platform defined by Deck Edges. This option is not available in the New Polygon Shaped Room dialog.
6. Click **OK**, then click once in plan view to create the specified polygon shaped deck.

Wall Hatching



The **Wall Hatching** tool can be used to fill wall segments with a single hatch pattern in plan view. To apply wall hatching, select **Build > Wall > Wall Hatching**, then click on a wall. The hatch pattern covers the entire length and width of the wall segment.

Note: The Wall Hatching tool cannot be used to apply a hatch pattern to Invisible Walls or to walls on a locked layer. See [Room Dividers and Invisible Walls on page 233](#) and [Locking Layers on page 125](#).

Wall Hatching places a hatch pattern across all layers of the selected wall layers displaying in the current view, covering any fill styles specified for that wall type. When wall hatching is applied to a railing, or when the “Walls, Main Layer Only” layer is turned on, wall hatching only displays in the Main Layer(s). See [The Main Layer on page 257](#).



In many cases, it is preferable to create a wall type definition rather than use the **Wall Hatching** tool because multiple fill styles can be used. See [Wall Type Definitions Dialog on page 259](#).

Wall hatching can be selected, edited and deleted much like other line-based objects. See [Editing Line-Based Objects on page 145](#).

The initial appearance of wall hatching can be specified in the Wall Hatching Defaults dialog. Once created, the wall hatch pattern and its line weight can be customized in the Wall Hatching Specification dialog. See [Wall Hatching Specification Dialog on page 278](#).

If you use the **Wall Hatching** tool to apply a hatch pattern to a wall that has been divided into multiple segments using the **Add Break**  edit tool, the pattern is only applied to the segment that you clicked on. See [Add Break on page 172](#).

Like doors and windows, wall hatching must be placed within a single wall segment but can be edited to extend across multiple collinear wall segments after it is created. Unlike doors and windows, only the midpoint of Wall Hatching can be located by dimension lines.

If three or more wall hatching objects occupy the same space in a wall, a Caution  symbol will display at the problem location in plan view. Click on the Caution  symbol that displays over the wall to open a contextual menu, then select **Delete** to delete a duplicate wall hatching. When no more Caution symbols remain, you should then confirm that the remaining two wall hatching objects meet your needs and delete any that are unnecessary.

When editing or deleting wall hatching, make sure that it is selected rather than the wall by noting that “Wall Hatching” displays in the Status Bar. See [The Status Bar on page 23](#).

Creating Walls



Walls, railings, and fencing are drawn similar to the way CAD lines are drawn: select a Wall Tool and then click and drag from end to end in the drawing area by clicking and dragging from end to end. Walls can be drawn in plan view, camera views, and overviews. See [Line Tools on page 199](#).

There are several other ways that walls can be created in Home Designer:

- Exterior walls can be generated automatically when a new floor is built by using another floor as a model. See [Adding Floors on page 503](#).
- Foundation walls are created when a foundation is automatically generated on Floor 0. See [Foundations on page 481](#).
- Attic walls are generated automatically when the program perceives a gap between a wall that defines a room and the roof above. See [Attic Walls on page 254](#).
- The **Space Planning Assistant** creates room boxes which can be arranged and then converted into walls. See [Space Planning on page 47](#).



DRAWING WALLS

Drawing walls to create a floor plan is simple if you keep a few things in mind:

- Draw exterior walls first to define the building's footprint, then draw the interior walls after the perimeter is in place.
- It is easiest to draw walls at the approximate location and length needed and then move or resize them precisely using dimensions later. See [Moving Objects Using Dimensions on page 332](#).
- When drawing and positioning exterior walls, make sure **Grid Snaps**  are enabled. Once these walls are in place, you may prefer to turn Grid Snaps off to draw and position interior walls and other objects. See [Grid Snaps on page 115](#).
- If you wish to input wall lengths as you draw, make sure your General Wall Defaults are set to **Resize About Outer Surface**. See [Entering Wall Lengths and Angles on page 237](#).
- As walls are drawn, “sticky” points and extension lines identify points that are either collinear or orthogonal to the end points of other walls, making alignment easier. See [Extension Snaps on page 113](#).
- When walls enclose an area to form a room, the program will orient all exterior walls so that the siding material faces outward. See [Wall Type Definitions on page 256](#).
- To flip the layers of a wall after it is drawn, select it and click the **Reverse Layers**  edit button. See [Editing Walls on page 244](#).
- Initial wall heights are determined by the default floor and ceiling heights of the current floor. See [Floor Defaults Dialog on page 502](#).

WALL ANGLES

With very few exceptions, walls should be drawn and edited with **Angle Snaps**  enabled. Walls that are drawn at irregular angles can result in wall connection, alignment, and room definition problems.

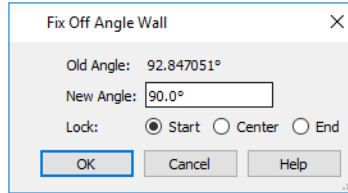

If a wall is drawn at an off angle, the **Off Angle Wall**  icon will follow the mouse pointer and a Caution  symbol will display over the problem wall in plan view. See [Pointer Icons on page 15](#).

To correct the wall's angle, click on the Caution  symbol that displays over the wall and select **Fix Off Angle Wall** from the contextual menu. In the Fix Off Angle Wall dialog:



- The **Old Angle** is stated for reference.
- Enter a **New Angle** in the text field.
- Specify whether to **Lock** the **Start**, **Center**, or **End** point of the wall when its angle is changed.

There are several other ways to fix a selected wall if it has been drawn at an off angle:

- Click the **Open Object**  edit button and specify the correct angle. See *General Panel on page 262*.
- Click and drag an end edit handle until the wall snaps to an Allowed Angle. See *Angle Snaps on page 114*.
- If the wall in question should be aligned with a wall directly above or below it, click the **Align with Wall Above**  or **Align with Wall Below**  edit button. See *Aligning Walls on page 249*.

You can also suppress the Caution symbol by specifying the needed angle in the wall's specification dialog or adding that angle to the list of Allowed Angles. See *General Plan Defaults Dialog on page 56*.

Although not recommended unless the walls in question are Fencing, Terrain Walls, and/or Retaining Walls, you can choose to **Ignore Off Angle Wall** or **Ignore All Off Angle Walls** by clicking on the Caution  symbol that displays over an off angle wall. See *Fencing Tools on page 230* and *Terrain Wall and Curb Tools on page 858*.

WALL POSITIONING

The recommended method of drawing walls is to draw them at their approximate location and length, then move them into position with accuracy using dimensions. To make this task quick and efficient:

- Notice the temporary wall that displays as you draw. Its length and angle display in the Status Bar at the bottom of the window and adjust as you move the mouse. Release the mouse button to draw the wall at the displayed length and angle. See *The Status Bar on page 23*.
- Use Snaps to help ensure proper wall alignment and orientation. See *Snap Behaviors on page 112*.

Once walls are drawn, they can be accurately dimensioned and moved as needed. See *Measuring Walls on page 242*.

ENTERING WALL LENGTHS AND ANGLES

The fastest way to draw walls is to draw them at their approximate position and length, and then move or resize them accurately using dimensions. See *Using Dimensions on page 245*.

For those that wish to enter walls' lengths and angles as they are drawn, first select **Resize About Outer Surface** in the General Wall Defaults dialog. See *Resize About on page 249*.

Then draw a wall, select it, and specify its **Length** and **Angle** in the Wall Specification dialog. Draw a second wall and specify its length and angle, and so on. See *General Panel on page 262*.

WALL OPENINGS

To create a door or doorway, do not draw wall sections with a gap between them. Walls should be drawn to completely enclose rooms, and then door and window objects should be placed in the walls to create openings later. See *Doors on page 365* and *Windows on page 393*.

TEMPORARY DIMENSIONS

 Temporary dimensions will display along the length of a wall as it is drawn when **Temporary Dimensions** are toggled on and **Show Wall Length When Editing** is checked in the General Wall Defaults dialog. See [Temporary Dimensions on page 325](#) and [General Wall Defaults on page 223](#).

DRAWING CURVED WALLS

Drawing a curved wall, curved railing, or curved fence is similar to drawing a CAD arc. See [Arc Tools on page 207](#).

As with CAD arcs, the method used to draw a curved wall depends on which **Arc Creation Mode**  is currently active. See [Drawing Arcs - Arc Creation Modes on page 206](#).

A straight wall can also be converted into a curved wall and vice versa using the **Change Line/Arc**  edit button. See [Change Line/Arc on page 174](#).

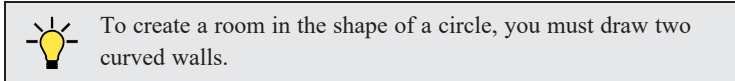

A curved wall always has a center point. The center displays as a small cross when **Show Arc Centers and Ends**  is enabled. See [Arc Centers and Ends on page 151](#).

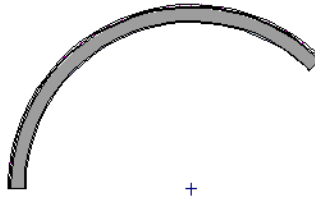

The radius of a curved wall is measured from the center to a surface or layer of the wall. The radius can be defined in the Wall Specification dialog. You may elect to define the radius to the exterior or interior wall layers. See [General Panel on page 262](#).

SPACE PLANNING ASSISTANT

 The **Space Planning Assistant Tools** allow you to place and arrange room boxes that can then be converted into a fully editable house plan, including walls. See [Space Planning on page 47](#).

WALL FRAMING

Once walls have been drawn, they can be framed. For best results, avoid generating framing until your model is in its final form. See [Wall Framing on page 606](#).

Connecting Walls

When walls are drawn sufficiently close to one another, they will snap together to form an intersection. This snapping occurs when the walls' center lines are within a distance defined by the larger of the two walls' widths and will occur even when **Object Snaps**  are turned off. See [Object Snaps on page 113](#).

If the two walls in question have identical specifications and are collinear, they will merge to become a single wall. See [Aligning Collinear Walls on page 250](#).

When three or more walls connect to form a completely enclosed area, that area defines a room. See [Rooms on page 279](#).

When walls snap together to form an intersection and **Object Snaps**  are enabled, the program joins them at their **Resize About** line, which is specified in the General Wall Defaults dialog. See [Aligning Walls on page 249](#).

- The wall that is being drawn or edited will move, lengthen, or shorten slightly to meet the other wall.
- The other wall will not move; however, its length may be affected.

WALL INTERSECTIONS

Any time two walls intersect, one wall will build through the other. You can turn on the display of the “Walls, Thru Wall Lines” layer in plan view to see which walls build through and which do not. See [Layer Attributes on page 124](#).



When a wall builds through another wall, it will extend into the intersected wall until it meets the interior surface of that wall’s Main Layer. See [The Main Layer on page 257](#).

PARTITION WALLS

By default, walls not only build to an intersecting wall’s Main Layer, they also build through the finish layers of the floor below and the ceiling above to reach the structural layers.

In some situations, though, this is not desirable: for example, glass shower walls are typically installed against the surfaces of walls, floors and ceilings rather than building into them. To achieve this, use the “Glass Shower” wall type. See [Glass Walls and Half-Walls on page 227](#).

FIX WALL CONNECTIONS

 Occasionally, intersecting walls may not properly connect. When this is the case and the connection in question is on the current floor, a Caution  symbol will display at the problem location in plan view and the Connect Walls  icon will follow your mouse pointer.

Click on the Caution  symbol that displays over the wall to open a contextual menu:

- Select **Delete** to delete the wall.
- Select **Ignore Unconnected Wall** to leave the wall unchanged and suppress the Caution symbol.

To correct wall connections throughout the current plan, select **Build> Walls> Fix Wall Connections** .

Alternatively, you can fix an individual wall connection using the **Connect Walls**  edit tool.

To use the Connect Walls edit tool

1. Select a wall.
2. Click the **Connect Walls**  edit button.
3. Click on a wall that you want to connect to the selected wall.
 - If the unconnected wall ends are sufficiently close to one another, the tool connects them.
 - If the separation is too great, extend one towards the other and try again.

REMOVING WALL BREAKS

The **Add Break**  edit tool allows you to break a wall into two or more separate wall segments. See [Add Break on page 172](#).

To merge two collinear walls separated by a break, select one of the segments, then click the end edit handle located at the break and drag it a few plan inches (mm) away from the break.

If the two walls do not merge, either the walls are not collinear or their specifications are not identical. You can open the Wall Specification dialog for each wall and determine how they differ. See [Wall Specification Dialog on page 262](#).

Displaying Walls



While the structure and appearance of each wall type is controlled in the Wall Type Definitions dialog, the display of walls in all views is controlled in the Layer Display Options dialog. See [Layer Attributes on page 124](#).

If a “Walls” layer is turned off in plan view, any doors and windows placed in walls on that layer will not display, either. See [Displaying Doors on page 369](#) and [Displaying Windows on page 401](#).

IN PLAN VIEW

The appearance of each wall type, including line weights and colors and wall layer fill styles, is specified in the Wall Type Definitions dialog. See [Wall Type Definitions Dialog on page 259](#).

There are also several options for controlling how walls are displayed in plan view. In the Layer Display Options dialog, you can specify whether or not various types of walls display. Walls are placed on layers with “Walls” at the beginning of the layer name, such as “Walls, Normal”.

The display of the wall layers specified in the Wall Type Definitions dialog can be controlled. If you turn off the display of the layer called “Walls, Layers”, wall types display with two lines representing the inside and outside surfaces.

In addition, you can turn off the display of non-structural layers and show only the walls’ Main Layers by turning on the display of the “Walls, Main Layer Only” layer. This allows you to create both fully configured walls and framing layouts. The “Walls, Main Layer Only” layer affects the display of walls in plan view only. See [The Main Layer on page 257](#).

The “Walls, Thru Wall Lines” layer controls the display of lines indicating which walls build through at wall intersections.

Note: In plan view, railings not specified as Solid display their Main Layer regardless of whether “Walls, Layers” or “Walls, Main Layer Only” is turned on. See [Wall Types and Railings on page 229](#).





Either the upper or lower portion of a Pony Wall can display in plan view. Only the portion that displays can be snapped to or aligned with walls above or below. See [Pony Walls on page 232](#).

Foundation Walls have footings that display in plan view as long as the “Footings” layer is turned on. Brick ledge lines can also display. See [Displaying Foundations on page 487](#).

It is sometimes helpful to display the walls from a floor other than the current floor. To do this, select and display a reference floor. See [The Reference Display](#). You can also specify which layers are included in the Reference Display Layer Set in the Layer Display Options dialog.

NOTIFICATION ICONS

Occasionally, the program may detect a problem with one or more walls in a plan. When this is the case, notification icons will display on the floor where the problem has occurred:

- If a wall is drawn at an off angle, the **Off Angle Wall**  icon will follow the mouse pointer and a Caution  symbol will display over the problem wall in plan view.
- If there is a problem with a wall connection, the **Connect Walls**  icon will follow the mouse pointer and a Caution  symbol will display at the problem location.

The recommended response to either situation is to fix the problem, although you can choose to ignore it if you prefer. See [Wall Angles on page 236](#) and [Fix Wall Connections on page 239](#).

If an issue has been ignored, notification icons for it will not display. Select **Tools> Checks> Reset Notification Icons** to display any suppressed notifications so that any wall angle or connection problems can be corrected.

IN 3D VIEWS

As in plan view, the display of walls can be controlled by layer in the Layer Display Options dialog.

Each layer of a wall is generated when you create a 3D view. You can see the different layers in 3D using the **Delete Surface**  tool. See [Delete 3D Surface on page 749](#).

A wall's framing layer displays as a solid layer rather than studs and plates until wall framing is built. See [Framing on page 605](#). Wall framing is placed on the "Framing, Wall" layer.

When a camera is located on the exterior of a structure, you can select **3D> Camera View Options> Hide Camera-Facing Exterior Walls** , allowing the interior to be seen as you rotate around the model. Interior walls set as Attic walls are also hidden when this setting is active.

While most architectural objects in the program can display in both floor plan and 3D views, a few cannot. Invisible walls and Wall Hatching are examples of objects that do not display in 3D.

Unlike in plan view, doors and windows placed in a wall can display in 3D views even if the wall's layer is turned off. See [3D View Defaults Dialog on page 739](#).

WALL LABELS

Wall labels are located on the "Walls, Layers" layer and can be set to display in plan views. See [Label Panel on page 363](#).

Walls do not have Automatic Labels by default; however, custom labels can be assigned to any wall in the Wall Specification and Defaults dialogs.

WALL MATERIALS

There are several ways that materials can be assigned to walls, depending on how the walls and the rooms they define have been defined. See [Rooms on page 279](#).

When you draw a wall, it uses the materials specified in its wall type definition. See [Wall Type Definitions on page 256](#).

You can change the surface material of an individual wall in the Wall Specification dialog. If you select "Use Default" as the material and the wall is used to define a room, the program refers to the material specified in the Room Specification dialog. See [Wall Specification Dialog on page 262](#).

You can also change a room's wall material in the Room Specification dialog. See [Materials Panel on page 716](#). To restore the default Wall Type material, select **Use Default** in the Select Material dialog. See [Select Material/Library Object Dialog on page 717](#).

Wall materials can also be changed using the **Material Painter**  tool, but bear in mind that depending on which Material Painter Mode is in use, only a portion of the wall may be painted and that the entire room may be affected rather than the individual wall. See [Material Painter and Walls on page 715](#).

When neither the wall nor the room has a material assigned to it, the program refers to the general material for walls in the Material Defaults dialog. See [Material Defaults on page 712](#).

Note: Wall materials that are specified on the Materials panel of either the Wall or Room Specification dialog are not calculated in the Materials List.

IN THE MATERIALS LIST

The materials that make up wall assemblies are listed under different Categories in the Materials List:

- **Siding** - Lists all materials located outside of each wall's Main Layer, such as siding, sheathing, and housewrap.
- **Framing** - Lists the framing material(s) for all walls as well as railings specified as Solid. Non-framed walls' Main Layer materials are also listed here when those walls are not specified as Foundation. Wall framing, including studs, plates, and headers, is only counted when a framing material has been assigned to a wall type and wall framing has been built. See [Framing on page 605](#).
- **Insulation** - Insulation is calculated for all exterior walls are not defined as Railings, and have one or more Framing layers. Insulation thickness is equal to that of the framing layer. See [Exterior and Interior Walls on page 230](#).
- **Wallboard** - Lists all materials located inside of each wall's Main Layer, such as drywall. Includes all materials aside from framing, concrete, and rebar in walls that do not define rooms.

Does not include Wall Coverings or materials specified in either the Room or Wall Specification dialog. See [Materials Panel on page 273](#).

- **Interior Trim** - Lists base, crown and chair rail moldings, and Wall Covering materials specified in the Wall and Room Specification dialogs. See [Wall Covering Panel on page 272](#).
- **Foundation** - Lists the concrete and rebar for all walls specified as Foundation as well as their footings. See [Foundation Walls on page 231](#).
- **General** - Reports the thickness of glass wall materials and their total lengths.

With the exception of wallboard, windows and doors are taken into account in the calculation of these totals.

Wall framing members can be reported in a Materials List using one of four methods: Linear Length, Buy List, Cut List, or Mixed Reporting. See [Structural Member Reporting on page 907](#).

Measuring Walls

Accurate wall measurements are an essential aspect of any drawing, and can be achieved by following two basic rules:

- Be aware of what part of a wall assembly dimensions are locating;
- Position walls using dimensions rather than edit handles or edit tools.

These rules can easily be met when you keep the following recommendations in mind.

For information about changing the value reported in a dimension line label, see [Using Dimensions on page 245](#).

DIMENSION DEFAULTS

Manually-drawn and automatic dimensions can be set to locate walls at their Dimension Layers or at their surfaces. Before drawing dimensions - and particularly, before using them to move your walls into position - make sure that all of your Dimension Defaults are set up to meet your needs. See [Dimension Preferences and Defaults on page 312](#).

If a wall is specified as Invisible, dimensions will locate it at its centerline regardless of its Wall Type Definition or your Dimension Defaults settings. If the Invisible wall divides rooms with different floor heights, dimensions will locate the edge of the wall facing the room where the floor is lower.

Be aware, too, that the wall length dimension that displays when a wall is selected as well as the **Length** specification in the Wall Specification dialog do not inherit their settings from the Dimension Defaults. Instead, they follow the **Resize About** line. See [Resize About on page 249](#).

EDIT DIMENSION LINES

Once a dimension line has been drawn, its extension lines can be edited to locate a number of locations on a wall assembly:

- The exterior surface
- The Wall Dimension Layer's exterior
- The center line of the wall assembly
- The Main Layer's center line
- The Main Layer's interior
- The interior surface

Dimension lines that are drawn through a wall can also be set to measure and report the widths of walls, or to suppress that information. See [Dimension Panel on page 335](#).

See [Editing Extension Lines on page 329](#).

MOVING WALLS USING DIMENSIONS

By far, the most precise method of positioning walls is using dimension lines. To produce accurate measurements, remember to:

- Be aware of what part of your walls is being located by each type of dimension.
- Avoid specifying dimension values with greater accuracy than your dimensions are set to display. See [Format Panel on page 320](#).

See [Using Dimensions on page 245](#).

Remember that the temporary wall length dimension that displays when a wall is selected may be set to locate a different part of the wall assembly than other dimension lines. See [Wall Length on page 247](#).

USE OBJECT, ANGLE AND GRID SNAPS

Object Snaps, Angle Snaps, and Grid Snaps make it easier to align walls when they are being drawn as well as when they are edited. See [Snap Behaviors on page 112](#).

Object Snaps  help to ensure consistent wall connections and are particularly helpful when aligning collinear walls.

When **Grid Snaps**  are enabled, walls are drawn on a regularly spaced grid, which helps avoid inaccurate wall placement. This can become particularly important if you forego positioning walls using dimensions in favor of using edit handles to move them.

 Using Grid Snaps is recommended when you are laying out exterior shell walls, but may be inconvenient when positioning interior walls or other objects.

Angle Snaps  make it easy to accurately draw walls at regular angles, ensuring walls that are truly parallel or perpendicular to one another and separated by consistent distances.

NO LOCATE

If a wall is specified as **No Locate** in the Wall Specification dialog, it will be ignored by **Auto Exterior Dimensions**  in plan view, as will any doors or windows placed in it. See [Dimensions on page 311](#).

By default, **Railings**, **Deck Railings**, and **Room Dividers** are specified as No Locate. See [General Panel on page 262](#).

If a wall is on its default layer and is specified as **No Locate**, it will be moved to the “Walls, No Locate” layer. If this box is later unchecked, the wall will return to its default layer. If a wall is on a non-default layer, it will remain there. See [Displaying Walls on page 240](#).

Once a dimension line has been created, it can be edited so that it locates a No Locate wall or railing that is perpendicular to it. See [Editing Dimension Lines on page 328](#).



Editing Walls

Walls can be selected in all views. When a wall is selected, it displays edit handles and an edit toolbar that can be used to modify it in various ways. When a wall is selected, temporary dimensions may also display. See [Temporary Dimensions on page 325](#).

The ways in which a wall can be edited depend on the current view and which edge is selected. See [Selecting Objects on page 141](#).

SELECTING WALLS

Like other objects, walls can be selected in a variety of ways. See [Selecting Objects on page 141](#).

In plan view, if wall hatching has been applied to a wall using the **Wall Hatching**  tool, it is possible that the hatching may be selected first. If it is, click **Select Next Object**  to select the wall itself. See [Wall Hatching on page 235](#).

- When **Select Room Before Wall in 3D** is checked in the Preferences dialog and you click on a wall in a cross section/elevation or camera view, the room defined by that side of the wall will become selected instead of the wall. See [Appearance Panel on page 60](#) and [Selecting Rooms on page 284](#).

When this is the case, you can select the wall by clicking the **Select Next Object**  edit button or pressing the Tab key.

- In plan views, the **Edit Area**  tools allow you to select only part of a wall or walls. See [Edit Area Tools on page 182](#).

- In a Framing Overview or other 3D view in which wall framing can be seen, select a wall framing member and click the **Find Wall**  edit button to switch to a plan view in which the wall associated with the selected framing is selected. A wall selected in this manner can then be edited even when its layer is turned off and/or locked. See [Locking Layers on page 125](#).

USING THE EDIT HANDLES

A selected wall can be modified in a variety of ways using its edit handles in any view. The handles that are available will depend on the current view type. See [Edit Handles for Walls on page 247](#).

IN THE SPECIFICATION DIALOG

 The appearance and structure of walls can be customized in the Wall Specification dialog. See [Wall Specification Dialog on page 262](#).



The characteristics of the roof directly above a selected wall can also be specified in the Wall Specification dialog. See [Roof Panel on page 266](#).

USING THE EDIT TOOLS

A selected wall or walls can be edited in a variety of ways using the buttons on the Edit Toolbar. See [The Edit Toolbar on page 91](#).

REVERSE LAYERS

 When walls enclose an area to form a room, the program will orient all exterior walls so that the siding material faces outward. When needed, you can click the **Reverse Layers** edit button to flip the orientation of the interior and exterior layers of a selected wall. Its wall type definition is not affected by this change. See [Interior and Exterior Surfaces on page 258](#).

When a wall has **Lower Wall Type if Split By Butting Roof** checked in its specification dialog and its interior wall layers are oriented to face adjacent roof planes, a Caution  symbol will display at the problem location in plan view and the Reverse Layers  icon will follow your mouse pointer. See [Roof Panel on page 266](#).

Click on the Caution  symbol that displays over the wall to open a contextual menu:







- Select **Reverse Layers** to flip the wall's interior and exterior layers.
- Select **Ignore Reversed Wall** to leave the wall unchanged and suppress the Caution symbol.

USING DIMENSIONS

 Automatic, manually-drawn, and temporary dimension lines can be used to both resize and move walls with accuracy.

- Select a wall, then click on a dimension line that locates it and type in the value that you need. See [Moving Objects Using Dimensions on page 332](#).

When a wall is resized using dimensions, the inline text field used to edit the dimension will have three unique buttons:

- Horizontal walls have **Move Left End** , **Move Both Ends** , and **Move Right End** .
- Vertical walls have **Move Top End** , **Move Both Ends** , and **Move Bottom End** .

Note: If only one of these buttons is available, the wall end that the button references is the only part of the selected wall that the dimension line actually locates, and only that end can be moved using the selected dimension.

Choose the option that you want to use before pressing the Enter key.



If both ends of the selected wall intersect walls that are not parallel to one another, a fourth option will be available: **Move Along Rails** . When this option is used, the selected wall both resizes and changes position so that it remains connected to the other walls when you press the Enter key.

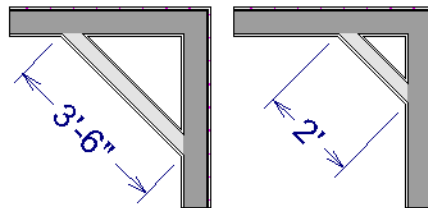

Depending on your Dimension Defaults settings, manual and/or automatic dimension lines may locate wall surfaces or wall dimension lines. See [Locate Manual Panel on page 315](#).

Dimensions can be set to locate **Wall Steps** in elevation views. Steps in foundation walls in plan views can also be located. Wall steps cannot be moved using dimensions, however. See [Stepped Walls and Footings on page 255](#).

 Dimension Defaults can have a significant effect on wall position. It is recommended that you review these settings and make sure that they meet your needs.

WALL THICKNESS

The initial thickness of a wall is determined by its wall type definition. You can change a wall's thickness by modifying its wall type. If you do this, all instances of the wall type used in the plan will be affected - not just an individual object. See [Wall Type Definitions on page 256](#).

You can also specify a selected wall's thickness in its Wall Specification dialog. See [General Panel on page 262](#).

If a selected wall's thickness is changed:

- A copy of the wall's wall type is created with the same name but appended with a number equal to the thickness of the Main Layers, and that new type is assigned to the wall. See [The Main Layer on page 257](#).
- The change in thickness will be applied to new wall type's innermost Main Layer.
- The Main Layer must be at least 1/16" thick, and the wall's thickness cannot be less than the original wall type's total thickness minus the thickness of its Main Layer.

If a wall type's thickness is modified, the wall will resize about the **Resize About** line specified in the General Wall Defaults dialog. In some instances, the wall may appear to move as a result of changes made to the thicknesses of its layers. See [General Wall Defaults on page 223](#).

WALL HEIGHTS

The height of a wall is controlled by the ceiling height of the room(s) it defines. If the ceiling or floor height of a room is changed, the height of the walls that define it also change.

- The initial ceiling height for all rooms on a floor is set in the Floor Defaults dialog for that floor. See [Floor Level Defaults on page 281](#). Whenever possible, it is best to set all ceiling heights using the default.
- The ceiling height of a single room can be set in its Room Specification dialog. See [General Panel on page 300](#).
- The default Floor and Ceiling Heights for a given floor can be adjusted by editing the top and/or bottom edges of the Exterior Room in a 3D view. See [The Exterior Room on page 285](#).
- The top or bottom edge of any wall can be adjusted independent of floor or ceiling heights using the mouse in Cross Section/Elevation and 3D views. Top and bottom edges can also be stepped and raked. See [Stepped and Raked Walls on page 255](#).
- The top height of a selected Railing can also be edited in Cross Section/Elevation and 3D views. The bottom height, however, cannot. See [Railing and Deck Tools on page 227](#).
- The edge dividing an upper and lower pony wall can be edited in Cross Section/Elevation and 3D views. In addition, its height can be defined in the Wall Specification dialog. See [Wall Types Panel on page 270](#).

WALL LENGTH

Wall length can be modified in several different ways:

- Using dimensions. See [Measuring Walls on page 242](#).
- In the Wall Specification dialog. See [General Panel on page 262](#).
- Using the **Add Break**  edit tool to divide a selected wall into two segments. See [Add Break on page 172](#).
- By dragging the end edit handles. See [Editing Line-Based Objects on page 145](#) and [Editing Arc-Based Objects on page 147](#).

Bear in mind that if you try to resize a wall by a small amount using one of its edit handles and that wall is connected to another wall at that end, its length will not change because its end will snap back to the existing intersection. See [Connecting Walls on page 238](#).

The most accurate way to specify wall length is using dimensions. By default, wall length is measured at the outside edge of the Main Layer. You can instead specify that manual and/or automatic dimension lines locate surfaces in the Dimension Defaults dialogs. See [Dimension Preferences and Defaults on page 312](#).

Be aware that the wall length dimension that displays when a wall is selected as well as the **Length** specification in the Wall Specification dialog do not inherit their settings from the Dimension Defaults. Instead, they follow the **Resize About** line. See [Resize About on page 249](#).

Note: By default, dimensions and the Resize About line all use the exterior edge of the Main Layer. When Resize About is set to use a different location, dimension lines may not agree with a wall's length specification. See [Measuring Walls on page 242](#).

Edit Handles for Walls

Walls can be edited extensively using their edit handles. Depending on the type of view, a wall displays a different set of edit handles when selected.

Moving a wall in any view will move any cabinets attached to that wall, as well.

IN PLAN VIEW

In plan view, straight and curved walls can be edited like other line- and arc-based objects. See [Editing Line-Based Objects on page 145](#) and [Editing Arc-Based Objects on page 147](#).

In addition:

- A wall's edit handles display along its **Resize About** line. See [Resize About on page 249](#).
- A wall can only be moved perpendicular to itself or, in the case of curved walls, perpendicular to its chord using the Move edit handle. To move a wall at Allowed Angles, use the **Alternate**  Edit Behavior. See [Alternate on page 138](#).

IN CAMERA VIEWS

The edit handles that are available for a selected wall in a camera view depends whether the wall is selected on its interior or exterior surface or on its top or bottom edge.

- In a cross section/elevation view, the top and bottom edges of straight and curved walls can be edited like closed polylines. See [Editing Closed Polyline-Based Objects on page 155](#). Only the top and bottom edges of walls can be broken, angled, or curved: the side edges cannot.
- In a camera view or overview, click on an interior or exterior surface to display the same edit handles as in an elevation view: one at each corner and one on the top and bottom edges.
- In a camera view or overview, click on the top surface of a wall to display the same edit handles as in plan view, allowing you to rotate, move, and extend or shorten the length of the wall.
- The footings of Foundation Walls and Slab Footings can be selected in 3D views and edited using the edit handles. See [Footing Width and Height on page 489](#).

SAME WALL TYPE EDIT HANDLES

 The **Same Wall Type** edit handles allow you to draw a new wall extending out from either end of a selected wall and with identical properties as that wall. These edit handles are enabled globally in the Preferences dialog. If you prefer, you can disable them globally and enable them only as needed by selecting a wall and clicking the **Same Wall Type** edit button. See [Architectural Panel on page 73](#).

When the Same Wall Type edit handles are enabled, two edit handles display just beyond a selected wall's Extend edit handles in plan view or when the top edge of the wall is selected in a 3D view.

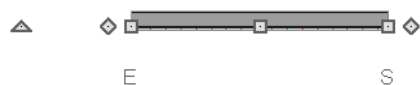

Click and drag a Same Wall Type edit handle at any angle to draw a new wall segment of the same type as the selected wall.

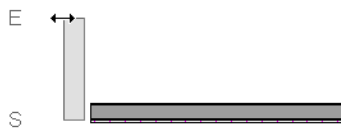

Editing Straight/Curved Wall Combinations

If you move a straight wall connected to a curved wall with a locked center and the connection cannot be maintained without changing the center of the arc, the walls lose their connection.

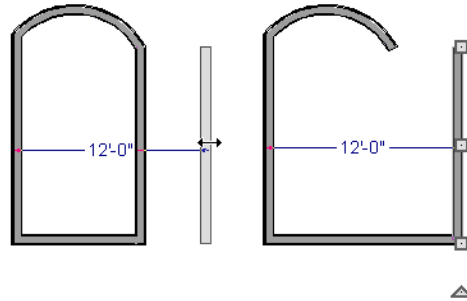

When an Extend edit handle of a curved wall with a locked center is dragged with the **Alternate** Edit Behavior active, the locked center setting will be overridden. See *Defaults, Preferences, and Edit Behaviors on page 137*.

If you move a straight wall connected to a curved wall with a locked center, the curved wall extends along its curve and the straight wall will either lengthen or shorten as needed to stay connected to the curved wall.

If the connection between the straight and curved wall cannot be maintained because of the curved wall's radius, it will be broken.

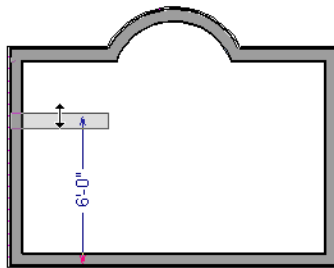

Aligning Walls

Wall alignment refers to the way wall segments line up with one another, either on the same floor or on the floor above or below. Walls may need to be aligned in a variety of situations.

To make alignment easier when drawing or resizing walls, “sticky” points and extension lines identify points that are either collinear or orthogonal to the end points of other walls. See *Extension Snaps on page 113*.

RESIZE ABOUT

The **Resize About** line specified in the General Wall Defaults dialog controls two important aspects of wall alignment:

- What part of a wall retains its position when its wall type or wall type definition is changed. See *Wall Type Definitions on page 256*.
- Where walls snap together to form an intersection. See *Connecting Walls on page 238*.

See *General Wall Defaults on page 223*.

The **Resize About** line is the line along which a selected wall's length is measured in the Wall Specification dialog. See *Wall Length on page 247*.

The **Resize About** line is also the line along which a selected wall's edit handles display, and is the line along which any snap points will be located. See *Editing Walls on page 244*.

ALIGNING COLLINEAR WALLS

Collinear walls are parallel walls connected end to end and drawn on the same floor. When collinear walls join end-to-end, the walls snap together. If these walls have the same wall type and identical specifications, and if **Object Snaps**  are enabled, they will merge to become a single wall segment.

CREATING A NOOK

Walls can be aligned across an opening such as a nook, so that they are collinear, using the **Add Break**  edit tool.

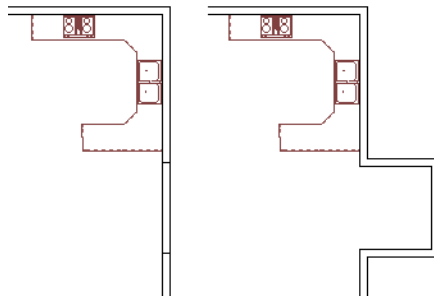

To align walls across a gap

1. Select a wall to build a nook into and click the **Add Break**  edit button.
2. Click at a point on the wall close to one side of the nook area. Do not worry about exact placement right now.
3. Click again near the other side of the nook. Two short lines at each location where you clicked indicate Breaks in the walls.



4. Right-click the middle section of the wall to select the wall section.
5. Click the middle Move handle and drag the wall outward.
6. Draw side walls to connect the wall back to the rest of the house.
7. Move these short walls using dimensions to accurately size the nook.



ALIGNING WALLS BETWEEN FLOORS

  Walls can be aligned between floors by clicking the **Align With Wall Above** and **Align With Wall Below** edit buttons.



By default, walls on different floors are aligned by the outer edges of their Main Layers. See *The Main Layer on page 257*.

 In order for these edit tools to be available, the areas of the walls in question must be partially aligned, or overlapping.

To align walls between floors

1. Select a wall that you want to align with another wall either above or below it.
2. If the wall is above or below the other wall along only part of its length, you must click on it along that part. Select **Tools> Floor/Reference Display> Reference Display On**  to help make sure you click on the correct part of the wall.
3. When you have selected the wall at the desired location, click either the **Align With Wall Above**  or **Align With Wall Below**  edit button.

ALIGNING CURVED WALLS BETWEEN FLOORS

Curved walls are aligned between floors using the same technique to align straight walls. If the centers and radii of the walls are within a few inches of each other, the **Align With Wall Above**  and **Align With Wall Below**  edit buttons are enabled for the selected wall. The selected curved wall will take on the radius and center of the referenced wall when the walls are aligned.

ALIGNING PONY WALLS BETWEEN FLOORS

When aligning a pony wall with either the wall above or below:



Align With Wall Below will always align the lower pony wall with the wall below, as specified in the lower pony wall's Wall Type Definition. See [Wall Type Definitions on page 256](#).



Align With Wall Above will always align the upper pony wall with the wall above, as specified in the upper pony wall's Wall Type Definition.

ALIGNING FOUNDATION WALLS

By default, foundation walls and slab footings will align with walls on the floor above along the outside surface of the Main Layer of both wall types. See [Wall Type Definitions on page 256](#).

If there is only one layer for both the stem wall and the first floor wall above it, the exterior surfaces of the walls align. The footing is centered on the stem wall.

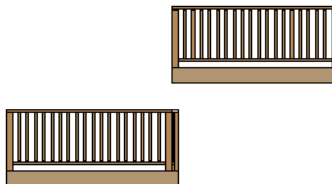

ALIGNING RAILINGS ON DIFFERENT PLATFORMS

Two collinear Railings or Deck Railings on the same floor can be aligned one above the other when they define rooms with different floor heights.



To align railing on different platforms

1. Click and drag to draw a Railing or Deck Railing that divides a room such as a deck in two.
2. Click the **Select Objects**  button, then click in one of the room areas.



3. Click the **Open Object**  edit button, and on the GENERAL panel of the Room Specification dialog:
 - Specify a **Floor Height** that differs from that of the other by at least the height of the railing, then click OK.
 - The default railing height is 36", so for best results the Floor Height should be changed by at least this amount.
4. Click on the railing drawn in step 1, then click the **Open Object**  edit button. On the RAIL STYLE panel of the Railing or Deck Railing Specification dialog, check **Generate on Low Platform**. See *Rail Style Panel on page 274*.
5. Click and drag a second railing parallel to the one drawn in step 1.
6. Select this second railing and click the **Open Object**  edit button. On the GENERAL panel of the Railing or Deck Railing Specification dialog, check the box beside **No Room Def** and click OK.
7. With the railing still selected, Ctrl + drag it into the same position as the first railing. See *To move an object freely on page 166*.

Roof Directives in Walls

To automatically generate a roof plane using values other than the defaults or to not generate a roof plane bearing on a particular wall (as for a gable or the sides of a shed roof), you can change the settings in the Wall Specification dialog. See *Roof Panel on page 266*.

HIP, GABLE, AND SHED ROOFS

By default, the program will produce a roof plane over each exterior wall to create a hip roof. You can instead specify a gable or shed roof above the selected wall.

- Check **Full Gable Wall** to create a gable with a ridge centered above the selected wall(s).
- Check **High Shed/Gable Wall** for the side walls or the wall under the high side of a shed roof.
- You can also select a wall and click the **Change to Gable Wall(s)**  edit button, or change it back by clicking the **Change to Hip Wall(s)**  edit button.

PITCH

The default pitch for roof planes is set in the Build Roof dialog. However, any exterior wall can define the pitch of the roof plane built above it.

You can also specify a second, upper pitch above a given wall. Mansard, gambrel, gull wing and half-hip are examples of roof styles that use two pitches.

OVERHANGS AND ROOF RETURNS

You can specify the overhang of the roof plane to be generated above the selected wall. This setting only takes effect when Same Height at Exterior Walls is unchecked in the Build Roof dialog, which is also where the default Overhang value is set.

Check **Auto Roof Return** to generate roof returns on the selected wall. In most cases, roof returns only generate on Full Gable Walls. See *Roof Returns on page 601*.

EXTEND SLOPE DOWNWARD

Check **Extend Slope Downward** to extend the roof plane downward over a bump out, instead of creating additional roof planes. The two connecting walls that create the bump out must be Full Gable walls.

In the following image, the bearing wall of the bump out has **Extend Slope Downward** checked. The two short side walls are **Full Gable Walls**.

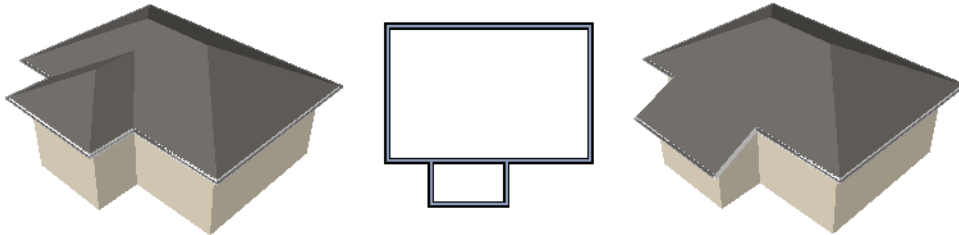

CLERESTORY AND DORMER WALLS

Occasionally, walls are built between two roof planes rather than between a roof plane and a floor platform. Common examples include clerestory walls and the side, or the cheek, walls of floating dormers.

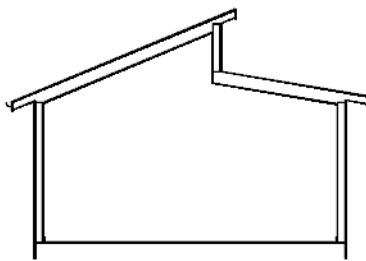

Check **Roof Cuts Wall at Bottom** to have the bottom of the selected wall clipped by the roof plane below, as where a floating dormer wall meets the main roof plane.

EXTERIOR/INTERIOR PONY WALLS

It's not uncommon for an individual wall to be an exterior wall near its top, and an interior wall near its bottom.

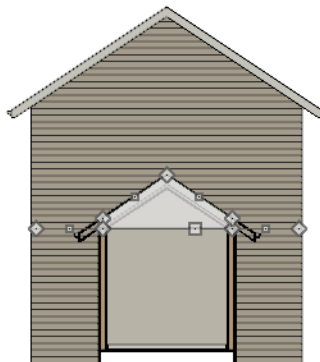

Check **Lower Wall Type If Split By Butting Roof** to achieve this. When this option is checked, the selected wall is specified as a pony wall and a second, lower wall type can be specified. Unlike with other pony walls, the change in wall type occurs wherever a roof plane builds to the exterior of the wall. See [Pony Walls on page 232](#).

Attic Walls

In Home Designer, walls are built between the floor and ceiling platforms of the current floor. See [Floor and Ceiling Heights on page 293](#). When the program detects an open space between a wall and the roof plane above it, it automatically creates an Attic Wall on the floor above that wall to fill in the gap.

Attic Walls are typically found above Full Gable Walls, forming a gable or closing the top portion of a side wall of a shed roof. They are also generated above all exterior walls when the **Raise Off Plate** value in the Build Roof dialog is 3" (175 mm) or greater. See [Build Roof Dialog on page 562](#).

Attic Walls are often found on the Attic floor, but can be generated on other floors, as well. See [The Attic Floor on page 509](#).

Attic Walls are specified as such in the Wall Specification dialog; if automatically generated, that will be noted as well. If needed, you can specify a regular wall as an Attic Wall. If you specify a wall as an Attic Wall, it will be moved to the "Walls, Attic" layer. See [General Panel on page 262](#).

When you **Rebuild Walls/Floors/Ceilings** , all automatically generated Attic Walls in the plan are deleted and rebuilt.

REMOVING ATTIC WALLS

Occasionally, the program will generate an Attic Wall where one is not wanted. There are several ways to address this:

- Turn off the display of the "Walls, Attic" layer.
- Specify the Attic Wall as **Invisible**. See [Room Dividers and Invisible Walls on page 233](#).
- Some interior Attic Walls can be suppressed by specifying space they enclose as a **Shelf Ceiling**. See [Shelf Ceilings on page 295](#).
- Select the Attic Wall and **Delete**  it. The program will specify the wall as Invisible automatically. If you delete this Invisible wall, a new Attic Wall will be created.
- Combine the Attic Wall with the wall below. To do this, select **Combine with Above Wall** in the Wall Specification dialog for the wall below. See [Roof Panel on page 266](#).



KNEE WALLS

Knee Walls are a bit like Attic Walls in that they are not meant to generate to full ceiling height. Instead, they build upward until they encounter a roof plane. Unlike Attic Walls, however, Knee Walls are used in the interior of a structure, typically to separate unused areas from rooms on the upper floor of a story-and-a-half structure. See [Room Types on page 282](#).

Home Designer does not specify walls as Knee Walls automatically. If an interior wall is drawn in a location where the roof is lower than the ceiling height, you should specify it as a Knee Wall in the Wall Specification dialog. See [Roof Panel on page 266](#).

For best results, Knee Walls should be drawn perpendicular to the pitch of the roof and should intersect with Full Gable Walls on each end.

Stepped and Raked Walls

Stepped and raked walls can be created using the **Add Break**  edit tool and the wall's edit handles in any 3D or cross section/elevation view. In many cases, working in a **Back Clipped Cross Section**  is easiest and allows the greatest accuracy.





When you try to select a wall in a 3D view, the interior or exterior room that it defines may be selected first. Click the Select Next Object edit button to select the wall itself. See [Selecting Walls on page 244](#).

STEPPED WALLS AND FOOTINGS

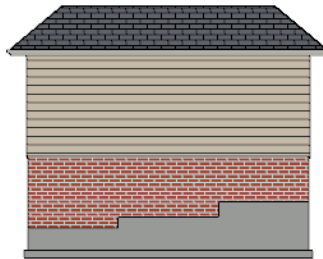
A typical example of stepped walls is a stepped foundation with pony walls. In the illustration below, the lower part of the pony wall is the concrete wall with footing, and the upper part of the pony wall is a framed wall with brick siding built to the first floor platform. See [Pony Walls on page 232](#).



To add a step to a wall

1. Select the wall in a **Back Clipped Cross Section**  view.
2. Click the **Add Break**  tool, then click the top or bottom edge of the wall to place the break.
3. In addition to the corner handles, two handles display along the broken edge.
4. Select one of these two handles, and drag up or down.
5. A square step is created.

The vertical edges of a wall cannot be broken, although they can be raked as well as moved side to side.

By default, a stepped foundation wall displays an “S” symbol at the location of each step in plan view. The display of this “S” is controlled in the Foundation Defaults dialog. See [Foundation Defaults on page 482](#).



Steps in walls can be located by dimensions in elevation views when **Wall Steps** is checked in the Dimension Defaults dialog. In addition, steps in foundation walls can be located in plan view. Wall steps cannot be moved using dimensions, however. See [Locate Manual Panel on page 315](#).

RAKED WALLS

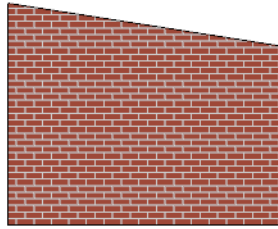
A raked wall has an angled top or bottom edge.



To create a simple raked wall

1. Select the wall in Cross Section/Elevation or 3D view.
2. Click one of the corner edit handles and drag that handle either up or down.
3. To rake a wall at a specific angle, you can:
 - Use **Angle Snaps**  and Allowed Angles. See [Angle Snaps on page 114](#).
 - Draw a **CAD Line**  at the desired angle and use the **Make Parallel/Perpendicular**  edit tool. See [Make Parallel/Perpendicular on page 169](#).

COMPOUND RAKED WALLS

A compound raked wall is a wall that has a top or bottom edge with multiple angles.

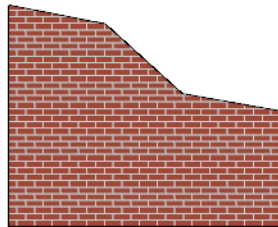

To create a compound raked wall

1. Select the wall in Cross Section/Elevation or 3D view.
2. Use the **Add Break**  tool to add breaks to the wall edge, as for a stepped wall.
3. Select a segment of the edge and adjust its angle, as for a raked wall.

Wall Type Definitions

Every wall drawn in a plan is assigned a wall type, and its Wall Type Definition determines its structure, its appearance in plan view, and its default materials. Wall types can be viewed, edited, and created in the Wall Type Definitions dialog. See [Wall Type Definitions Dialog on page 259](#).

Wall types typically have multiple layers, each representing a different material. All of these layers can be calculated in the Materials List. The materials assigned to the surface layers of the wall type definition also determine the wall's appearance in 3D views. See [Materials Lists on page 904](#).

You can specify the default wall type that is drawn by each Wall Tool and can specify the wall type of any wall after it is drawn in the Wall Specification dialog. See [Wall, Railing, and Fencing Defaults on page 223](#) and [Wall Types Panel on page 270](#).

THE MAIN LAYER

In most circumstances, each wall type's Main Layer should be specified as the structural layer. A wall type is considered to be:

- “Framed” if it has a Main Layer with the “Framing” or “Steel Framing” Material Structure Type;
- “Concrete” if it has a Main Layer with the “Concrete” Material Structure Type;
- “Masonry” if it has a Main Layer with a “Masonry” Material Structure Type.

See [Materials and the Materials List on page 723](#).

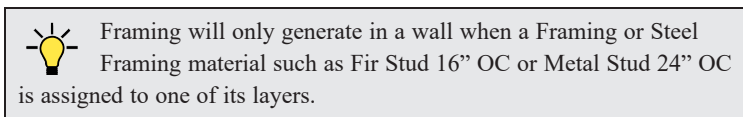

- The Main Layer determines many things in addition, including:
- Floor and ceiling platforms and automatically built foundation walls normally build to the outer edge of the Main Layer.
- The Main Layers of exterior walls build through slab floors while interior wall layers stop at the slab surface.
- At intersections, walls join at the interior surfaces of their Main Layers. See [Connecting Walls on page 238](#).
- Windows are placed relative to the outer surface of the outermost Main Layer.
- Exterior walls on different floors are aligned by the exterior edges of their outermost Main Layer.
- Roof baselines are placed at the outer edge of the outermost Main Layer when roofs are automatically generated. See [The Baseline on page 570](#).
- Roof baselines and gable/roof lines that are manually drawn snap to the outermost edge of the Main Layer.
- By default, walls resize about the exterior surface of their Main Layers when their thickness, wall type, or Wall Type Definition is changed. See [Resize About on page 249](#).
- **Object Snaps**  locate the interior and exterior edges of a wall's Main Layers. See [Object Snaps on page 113](#).
- The Sheathing Layer that windows and doors may be recessed to is the layer located just outside the outer Main Layer.

All of this information is reliant on the Main Layer, so creating your wall type definitions accurately beforehand and specifying the Main Layer correctly is very important.

MULTIPLE MAIN LAYERS

In standard light frame construction, walls build to one another's framing layers, and floor and ceiling platforms are built to bear over the wall framing; however, some building techniques configure these components in other ways. You can control how walls of a given type are intersected, and also where platforms build to, by specifying multiple Main Layers.

- By default, when multiple Main Layers are specified:
- Intersecting walls build to the interior surface of the innermost Main Layer.
- Floor platforms build to the exterior surface of the outermost Main Layer.
- A selected wall's edit handles display along the exterior of the outermost Main Layer.
- The exterior surface of the outermost Main Layer is the Dimension Layer.



See [Wall Type Definitions Dialog on page 259](#).

THE DIMENSION LAYER

Dimension Defaults can be set to locate walls at their surfaces or at the exterior line of their Wall Dimension Layer. See [Locate Manual Panel on page 315](#).

For installed wall types, the default Wall Dimension layer is the Main Layer; however, this can be changed in the Wall Type Definitions dialog. In addition to the Wall Dimension Layer, dimensions can locate the inside surface of the Main Layer, as well.

Whether Surface or Wall Dimension Layer is selected on the LOCATE OBJECTS panel of the Dimension Defaults dialog determines a number of aspects related to how dimensions locate walls:

- How Auto Exterior and Manual Dimensions measure the lengths of walls.
- Where both Manual and Automatic Reach are measured from.
- Where Extension line lengths and their Gap From Marked Object are measured from.
- Where First Line Offset for **Auto Exterior Dimensions**  is measured from.
- How the minimum enclosed area required by **Auto Exterior Dimensions**  is measured.

The settings on the LOCATE OBJECTS panel control how dimensions initially locate walls. Once a dimension line has been created, you can move its extension lines or add new extensions to locate other points along a wall's assembly. See [Measuring Walls on page 242](#).

INTERIOR AND EXTERIOR SURFACES

Every wall has an interior and exterior surface - including walls in a plan that are recognized by the program as being interior walls. See [Exterior and Interior Walls on page 230](#).

Having separate designations for a wall's two sides serves a couple of purposes:

- It allows the program to orient each wall's exterior side toward the outside of a structure. See [Creating Walls on page 236](#).
- It allows you to specify different materials for each side's surface in the Wall Specification dialog. See [Materials Panel on page 273](#).

In the Wall Type Definitions dialog, the exterior surface is shown at the top of the Wall Layers table. In plan view, you can identify a selected wall's exterior surface by the location of its edit handles, which display on the exterior of the Main Layer by default. See [Resize About on page 249](#).

LEGACY WALL TYPES

In Home Designer Pro version 9 and prior, generic, single-layer wall types were used as the default for railings, deck railings and fencing.

- In Home Designer Pro 8 and prior, there were two such wall types: "Default (wood frame 16"OC)" and "Default (concrete)".
- In Home Designer Pro 9, these two wall types were replaced by one named "Adjustable Thickness Wall".

When plans that include either of these wall types - in the drawing itself or set as a default - are opened in Home Designer Pro 2022, the legacy wall type is replaced by a new wall type named "Wall-X", where X is the thickness of the wall's Main Layer, rounded up. There are a few exceptions:

- If legacy wall types with the same thickness but different materials are found, they use the same naming convention appended with an additional _X.

- If a wall using a legacy wall type is specified as a Foundation wall, the resulting wall type will be named “Foundation Wall-X”.
- If a legacy wall type has the same attributes as a wall type installed with Home Designer Pro 2022, such as 8” Concrete Stem Wall, it will be replaced by that wall type.

Unless a wall is specified as a Foundation wall, Deck Railing, or Fencing, it will be treated as a framed wall and its new wall type will acquire two additional 1/2” (13 mm) thick wall layers: an interior and an exterior layer. These new layers will use the interior and exterior materials of the original wall. The wall’s original layer will maintain its original thickness, acquire a framing material, and will become the new wall type’s Main Layer.

Foundation, Deck Railing, and Fencing wall types converted in this manner will continue to have only one layer.

Wall Type Definitions Dialog

 The Wall Type Definitions dialog is used to define new wall types and redefine existing wall types in the current plan file. Select **Build> Wall> Define Wall Types** to open this dialog.

You can also click the **Define** button on the WALL TYPES panel of the Wall Specification dialog or in most Wall Defaults dialogs. See [Wall Types Panel on page 270](#).

Changes made to an existing wall type definition affect all walls in the current plan using that wall type. Walls in other plan files are unaffected.

If changes to a wall type affect its thickness, the position of any walls in the plan using that wall type may be affected. See [General Wall Defaults on page 223](#).

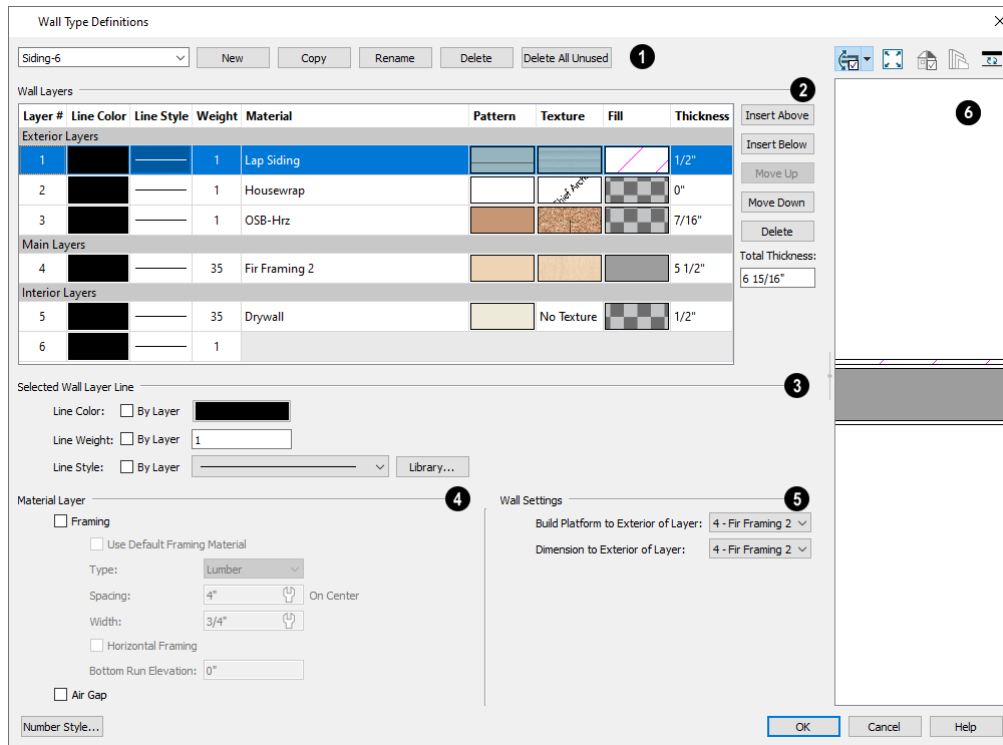

1 Wall Types

Manage the list of wall types available in the current plan. See [Wall Type Definitions on page 256](#).

- Click the drop-down list to display all wall types in the current plan. Select a wall type from the list to display its definition. You can rename a wall type by typing in a new name. Note that wall type names in a plan must be unique.
- To create a new wall type, click **New** to define a new wall type from scratch or click **Copy** to copy the current wall type. A copied wall type can then be renamed and redefined.
- Click **Rename** to rename an existing wall type, or simply click on its name and type a new name.
- To remove a wall type from the current plan, select it and click **Delete**. Wall types that are in use or set as plan defaults cannot be deleted.
- To remove all wall types that are not in use or set as a default from the current plan, click **Delete All Unused**.

2 Wall Layers

The selected wall type's **Wall Layers** are listed here. Wall layers are listed from exterior at the top to interior at the bottom. The last item listed is the interior surface line rather than a true layer.

- The list is divided into three sections: Exterior, Main, and Interior Layers. To move a layer from one section to another, use the Move Up and Move Down buttons to the right.
- A wall type's thickest structural layer is typically set as the Main Layer; however, multiple Main Layers can be specified. See [The Main Layer on page 257](#).
- Click in either the **Pattern** or **Texture** column to open the Select Material dialog and choose a material for the selected wall layer. See [Select Material/Library Object Dialog on page 717](#).
- Click in the **Fill** column to open the Layer Fill Style dialog and specify a fill style for the selected wall layer. See [Fill Styles on page 130](#).

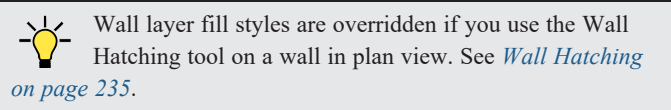

- Click in the **Thickness** column to type the selected layer's thickness, or depth. Very thin layers can be created, but for best results, avoid using a thickness of 0. For very small values, it can be helpful to temporarily change the dialog number format: click the Number Style button.

The buttons to the right of the table allow you to reorganize the wall type definition's layers.

- Click the **Insert Above** button to create a new layer directly above, or outside, the selected layer in the wall type definition. The new layer is a copy of the original.
- Click the **Insert Below** button to create a new layer directly below, or inside, the selected layer in the wall type definition. The new layer is a copy of the original.
- Click the **Move Up** button to swap the selected layer's position with that of the layer immediately outside of it or to move it into the layer section directly outside of it. Not available for the outer-most layer or for a single Main Layer.
- Click the **Move Down** button to swap the selected layer's position with that of the layer immediately inside of it or to move it into the layer section directly inside of it. Not available for the inner-most layer or for a single Main Layer.
- Click **Delete** to remove the selected layer from the wall type definition.

- The **Total Thickness** of the wall assembly displays here. If you change this value, the thickness of the Main Layer automatically updates to account for the difference.

3 Selected Wall Layer Line

Specify the attributes of the **Selected Wall Layer Line**, which is the line defining the selected layer's exterior.

- Define the **Color**, **Style**, and **Weight** for the selected Wall Line.
- Check **By Layer** if you want the line to assume the attributes of the wall's layer as defined in the Layer Display Options dialog. See *Layer Attributes on page 124*.

4 Material Layer

Specify whether the selected wall layer has special **Material Layer** attributes.

- Check **Framing** to produce framing in the selected layer when wall framing is generated. See *Framing Defaults on page 606*.
- Check **Use Default Framing Material** to apply the default framing material set in the Build Framing dialog to the selected wall layer. See *Materials Panel on page 628*.
- Select the framing **Type** from the drop-down list. See *Displaying Framing on page 632*.
- Specify the on-center **Spacing** of the framing in the selected layer. The default value is set in the Build Framing dialog. See *Wall Panel on page 618*.
- Specify the **Width** of the framing in the selected layer. The default value is set in the Build Framing dialog.
- Check **Horizontal Framing** to produce framing that runs horizontally instead of vertically, sometimes referred to as girts.
- When Horizontal Framing is checked, specify the **Bottom Run Elevation**. This value is absolute, measured from the center of the lowest horizontal framing member relative to zero, the default top height of the subflooring on Floor 1. For horizontal framing on Floor 0, enter the absolute elevation of the bottom run on that floor. See *Floor 1 Default Height on page 281*.
- Check **Air Gap** to prevent the selected layer from displaying in 3D views or being calculated in the Materials List.

5 Wall Settings



- **Build Platform to Exterior of Layer** - Select a wall layer from the drop-down list to build floor and ceiling platforms to. By default, the exterior side of the outermost Main Layer is selected.

Note: If Build Platform to Exterior of Layer is set to the exterior wall layer, no siding material will generate to cover the floor platform.

- **Dimension to Exterior of Layer** - Select the wall type's Dimension Layer from the drop-down list. By default, the outermost Main Layer is selected. This setting does not affect Interior Dimensions. See *The Dimension Layer on page 258*.

6 Preview

A preview of the selected wall type definition displays here. See [Dialog Preview Panes on page 20](#).

- When the selected preview type is a 3D view, a gap is shown between each of the wall layers in the preview. Click the **Explode Layers**  button remove or restore these gaps.
- When Plan View is the selected preview type, click the **Line Weights**  button to toggle the display of the wall layer and pattern line weights, or thicknesses. See [Line Weights on page 950](#).

Wall Specification Dialog

To open the Wall Specification dialog, select a wall or group of walls and click the **Open Object** edit button.

The panels of the Wall Specification dialog are also found in the Railing, Deck Railing, and Fencing Specification dialogs. See [Railing and Fencing Specification Dialogs on page 274](#).

The settings in this dialog are also similar to those in the various Wall Defaults dialogs. The settings in these defaults dialogs determine the initial characteristics of railings, deck railings and fencing when they are first drawn. See [Wall, Railing, and Fencing Defaults on page 223](#).

The Wall Specification dialog has the following panels:

GENERAL PANEL

The settings on the GENERAL panel determine the basic use of the selected wall, as well as its length, angle, and other attributes.

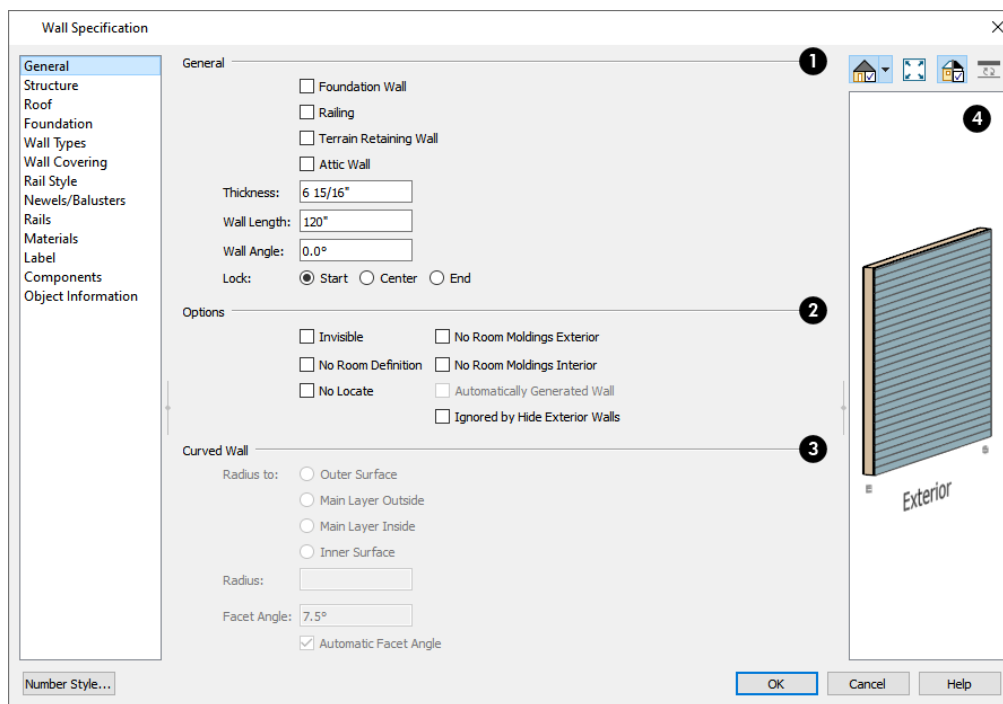



1 General

Specify **General** properties of the selected wall(s) or railing(s).

- Check **Foundation Wall** to specify the selected wall as a foundation wall. More foundation wall settings are available on the FOUNDATION panel. See *Foundation Walls on page 231*.
- Check **Railing** to specify the selected wall as a railing. More railing settings are found on the RAILING, NEWELS/BALUSTERS, and RAILS panels. See *Railing and Fencing Specification Dialogs on page 274*.
- Check **Terrain Retaining Wall** to treat the selected wall as a terrain retaining wall. See *Retaining Walls on page 859*.
- Check **Attic Wall** to prevent the selected wall from extending through the roof above. See *Attic Walls on page 254*.
- The **Thickness** of the selected wall displays and can be changed here. If the wall is a Post to Overhead Beam railing, this setting also affects the width of the beam. See *Wall Thickness on page 246*.
- **Wall Angle** - The current absolute angle of the wall in plan view is shown. If you type in a new angle, the wall rotates about its locked point and any walls attached to it will not move. If the selected wall is curved, this value describes the angle of the chord and cannot be modified. See *3D Drafting on page 11*.
- **Wall Length** - The current length, as measured along the **Resize About** line, is shown. If you type a new length, the wall will extend or contract according to how it is locked. Any walls attached to the selected wall will not move. If the selected wall is curved, this value cannot be modified. See *Resize About on page 249*.
- Select a radio button to **Lock** the selected straight wall at its Start, End or Center. When the **Wall Angle** or **Wall Length** of the selected wall is changed, this point along the wall does not move. Not available for curved walls.

2 Options

- Check **Invisible** to specify the wall as invisible. Invisible walls can display in plan view but not in 3D views or the Materials List. **Room Dividers**  are invisible by default. See *Room Dividers and Invisible Walls on page 233*.
- Check **No Room Definition** to display the wall in floor plan and/or 3D views but not create room definition. See *Room Definition on page 280*.
- Check **No Locate** to prevent **Auto Exterior Dimensions**  from locating the wall in plan view. See *No Locate on page 244*.
- Check **No Room Moldings Exterior** to prevent any room moldings from generating along the Exterior side of the selected wall. See *Room Moldings on page 300*.
- Check **No Room Moldings Interior** to prevent any room moldings from generating along the Interior side of the selected wall.
- **Automatically Generated Wall** displays for reference and is checked whenever the selected wall was generated by the program. Typically, automatic walls are also Attic walls.
- Check **Ignored by Hide Exterior Walls** to prevent the selected wall from being hidden in 3D views when the Hide Camera-Facing Exterior Walls option is in use. See *Hide Camera-Facing Exterior Walls on page 771*.

3 Curved Wall

The **Curved Wall** settings control the definition of a selected curved wall's radius and are only available when the selected wall is curved.

- Select **Outer Surface** to measure the selected wall's radius from its center point to its outer surface.
- Select **Main Layer Outside** to measure the radius from the wall's center point to the outside of its Main Layer. See [The Main Layer on page 257](#).
- Select **Main Layer Inside** to measure the radius from the wall's center point to the inside of its Main Layer.
- Select **Inner Surface** to measure the radius from the wall's center point to its inner surface.
- Specify the selected wall's **Radius**, as defined by the radio button selected above.

4 Preview

A preview of the selected wall, including any doors or windows inserted into it, displays on the right. If the selected wall is specified as Invisible, its plan view will display here by default. See [Dialog Preview Panes on page 20](#).

STRUCTURE PANEL

The settings on the STRUCTURE panel control the height and other structural attributes of the selected wall(s).

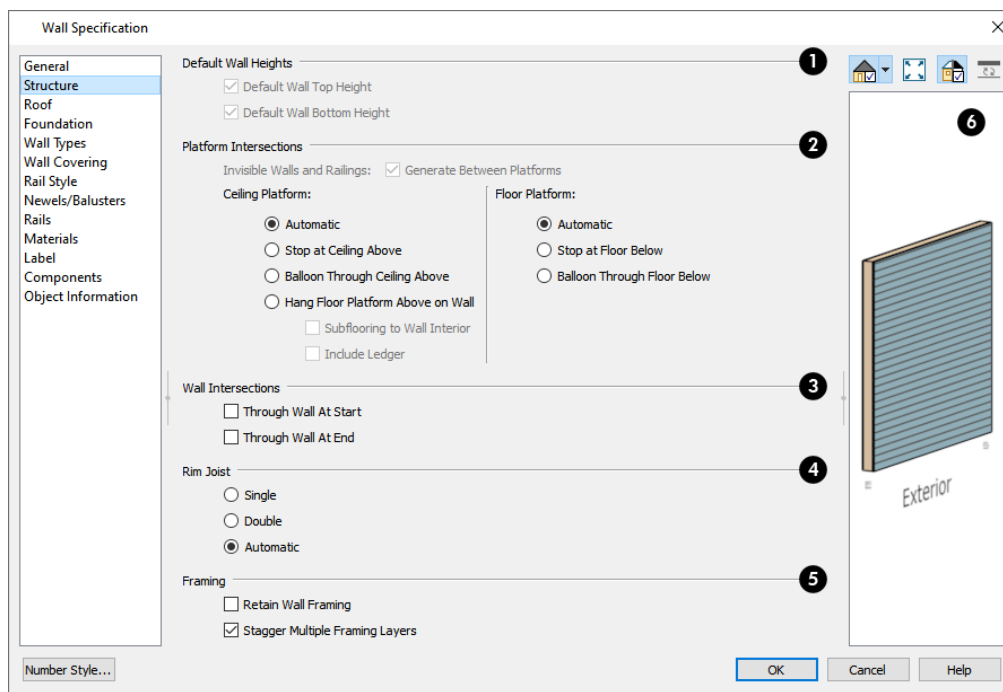

1 Default Wall Heights

The **Default Wall Heights** settings allow you to reset a wall's default top and bottom heights if they have been manually edited. See [Wall Heights on page 246](#).

- **Default Wall Top Height** and **Default Wall Bottom Height** are only enabled if the selected wall's top and/or bottom height has been edited. Check these boxes to restore the default heights.

2 Platform Intersections

These settings control the relationship between the selected wall and the **Ceiling Platform** above and the **Floor Platform** below it. They only take effect when the selected wall is positioned at a platform edge, such as at the exterior of a building or Open Below room. See [Floor and Ceiling Platforms on page 295](#).

- Check **Generate Between Platforms** to fill in the gap between floor and/or ceiling platforms when the selected railing or invisible wall separates rooms with different floor and/or ceiling heights. When unchecked, this gap is not closed. Only available for railings, Invisible railings, and Invisible walls, this setting has no effect when the selected wall type has only one layer.

The **Ceiling Platform** settings control how the selected wall's top plates are generated.

- Select **Automatic** to set the wall's top plates under the ceiling above if there is a floor/ceiling platform above, or to balloon frame the wall if there is not a platform above.
- Select **Stop at Ceiling Above** to have the top of the wall top at the bottom of the ceiling platform above, as is typical in light frame construction.
- Select **Balloon Through Ceiling Above** to have the top of the wall go past the ceiling platform. If there is a framed wall directly above, the framing will continue upward to that wall's top plate. The two walls remain separate objects on different floors, however, unless the wall above is an Attic Wall. This setting does not affect interior walls.
- Select **Hang Floor Platform Above on Wall** to produce a platform that hangs on the inside of the selected wall rather than bearing on top of it. When checked, the two options that follow are available.
- Select **Subflooring to Interior Wall** to hang the platform on the inside surface of the wall. When unchecked, the platform builds to the inside surface of the wall's Main Layer. See [The Main Layer on page 257](#).
- Select **Include Ledger** to hang the platform from a ledger board attached to the wall. When unchecked, no ledger is created when platform framing is generated. See [Floor and Ceiling Framing on page 606](#).

The **Floor Platform** settings control how the selected wall's bottom plate is generated.

- Select **Automatic** to set the wall's bottom plate on top of the floor platform below, or to balloon frame the wall if there is not a platform below.
- Select **Stop at Floor Below** to have the bottom of the wall stop at the top surface of the floor platform, as is typical in light frame construction.
- Select **Balloon Through Floor Below** to have the bottom of the wall go through the floor platform below. If the selected wall is framed and there is a framed wall directly below, the studs of the wall below will extend up produce balloon framing. If the wall below is set to Stop at Ceiling Above, the selected wall's bottom plates will rest on that wall's top plates. This setting does not affect interior walls.

Note: Whether a wall is a framed or concrete type is determined by the material assigned to its Main Layer. See [Wall Type Definitions Dialog on page 259](#).

3 Wall Intersection

The **Wall Intersection** settings control whether the selected wall builds through wall corners at its Start and End points. The display of **Start and End Indicators** can be turned on or off in the Preferences dialog. See [Edit Panel on page 75](#).

- Select **Through Wall at Start** to build the wall through the wall corner located at its start point.
- Select **Through Wall at End** to build the wall through the wall corner located at its end point.

- When neither box is checked, the program will determine whether the wall builds through the corners at each of its endpoints.

4 Rim Joists

Specify the number of **Rim Joists** for the floor platform below the selected wall(s). See [Framing on page 605](#).

- Select **Single** or **Double** to generate one or two rim joists, respectively.
- Select **Automatic** to generate two rim joists if there is no wall below the selected wall, and one rim joist when there is a wall below. Automatic produces a single rim joist for Deck Railing.

5 Framing

Check **Retain Wall Framing** to preserve the framing of the selected wall when the wall framing is globally rebuilt. See [Keeping Framing Current on page 635](#).

6 Preview

A preview of the selected wall, including any doors or windows inserted into it, displays on the right. See [Dialog Preview Panes on page 20](#).

ROOF PANEL

Any automatically generated roof style other than a hip requires roof information to be defined in the exterior walls. On the ROOF panel, you can specify how the selected wall interacts with the roof plan, defining the portion of the roof plan that bears on it. See [Automatic vs. Manual Roofs on page 557](#).

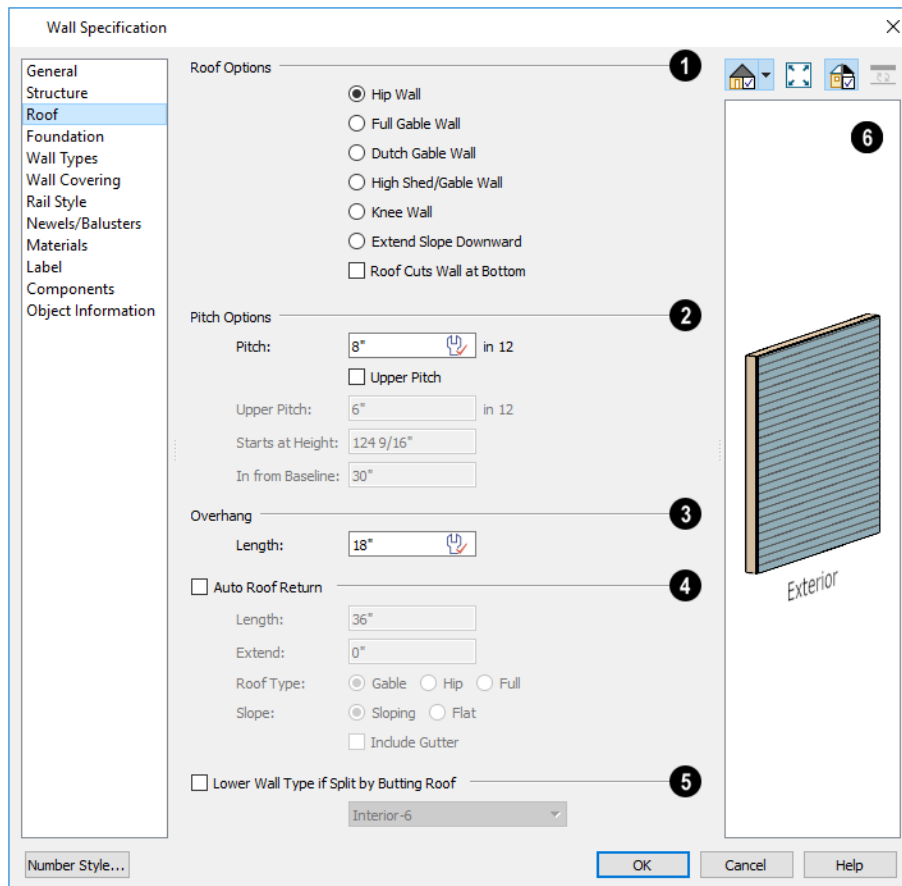

1 Roof Options

Specify the shape of the wall relative to the roof.

- Check **Full Gable Wall** to create a gable end over the selected wall.
- Check **Dutch Gable Wall** to create a small gable part way up a hip roof. Use the Pitch Options below to specify the location of the gable.
- Check **High Shed/Gable Wall** to specify the selected wall as the high end of a shed roof.
- Check **Knee Wall** to define the selected interior wall as a knee wall. Only an interior wall can be defined as a knee wall. A knee wall's height is defined by the roof above, not the ceiling height. See [Knee Walls on page 254](#).
- Check **Extend Slope Downward** to continue a roof down over a bump out in an exterior wall. See [Extend Slope Downward on page 253](#).
- Check **Roof Cuts Wall at Bottom** to prevent the portion of a selected wall located below an intersecting roof plane from building.
- **Combine with Above Wall** is only available when a selected wall has an Attic wall above it. Check this box to balloon frame the two walls when automatic framing is built. The two walls remain separate objects. See [Attic Walls on page 254](#).

2 Pitch Options

Specify the pitch or pitches of the roof plane(s) above the selected wall.

- Enter a value to define the **Pitch** of the roof plane bearing on the selected wall.
- Check **Upper Pitch** to create a roof with two pitches or, if the selected wall is a Full Gable Wall, a half hip condition.
- Enter the **Pitch** of the second, upper roof.
- Specify the **Height** that the Upper Pitch **Starts at**, or define the distance **In from Baseline** that the second pitch begins. The two values are dynamic. Press the Tab key to update the relative numbers. These settings are also used to position a Dutch Gable Wall.

3 Overhang Length

Specify the **Overhang Length**, which is the horizontal distance from the baseline to the eave. See [The Baseline on page 570](#).

4 Auto Roof Return

Check **Auto Roof Return** to generate roof returns on the selected wall. In most cases, roof returns only work for Full Gable Walls. See [Roof Returns on page 601](#).

- Specify the horizontal **Length** of the roof return in inches (mm).
- Enter a value in inches (mm) to **Extend** the roof returns past the overhang.
- Specify a **Gable**, **Hip**, or **Full** roof return.
- Specify a **Sloping** or **Flat** roof return.
- Check the box to **Include Gutters** on the roof returns.

5 Lower Wall Type if Split by Butting Roof

Check **Lower Wall Type if Split by Butting Roof** to specify the wall type for any portion of the selected wall located beneath an adjacent, abutting roof plane, should one be present. A wall affected by this setting is specified as a Pony Wall and the upper wall is defined on the WALL TYPES panel. See *Exterior/Interior Pony Walls on page 253*.

6 Preview

A preview of the selected wall, including any doors or windows inserted into it, displays on the right. See *Dialog Preview Panes on page 20*.

FOUNDATION PANEL

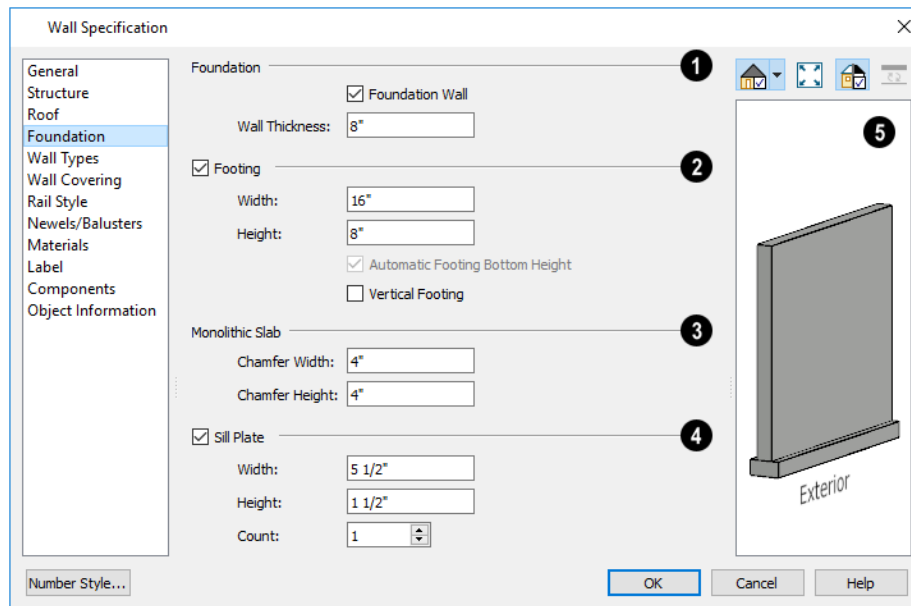

1 Foundation

Specify the **Foundation** properties of the selected wall(s).

- Check **Foundation Wall** to specify the selected wall as a foundation wall and enable additional settings on this panel. This box is checked by default for automatically generated foundation walls as well as walls drawn with the **Foundation Wall tool** .

Note: Rooms defined by walls drawn using the Slab Footing tool will have a Ceiling Height of 0 and a Monolithic Slab Foundation. Rooms defined by walls that are later specified as Slab Footings will not unless the room is on Floor 0 and the plan has a Monolithic Slab foundation specified.

- The **Thickness** of the selected wall displays and can be changed here.

2 Footing

Check **Footing** to assign a concrete footing to the selected wall(s) and enable the settings below. Only available when Foundation Wall is checked, above.

- Specify the **Width** and **Height** of the footing below the selected foundation wall(s). The **Height** value will be unavailable if the bottom height of the footing has been edited. See *Stepped Foundations on page 492*.
- Check **Automatic Footing Bottom Height** to restore the default height of the selected wall's footing. Only available when the footing bottom height has been edited.
- Check **Vertical Footing** to generate footings that run up and down along any steps in the foundation wall's bottom height.

3 Monolithic Slab

Specify how **Monolithic Slab** footings generate. These settings apply only when the selected wall defines the side of a Monolithic Slab. See *Foundations on page 481*.

- Specify the **Chamfer Width** and **Height**, which define the angled corners where the footing meets the underside of the slab.

4 Sill Plate

Check **Sill Plate** to reserve space for one or more sill plates, or mud sills between the selected foundation stem wall or grade beam and the floor platform or framed wall that bears on it. Sill plates are generated when the floor framing is generated. See *Sill Plates on page 607*.

- Specify the **Width** and **Height** of the treated sill plates. If the Height is set to zero, no sill plates are produced. Not available if **Monolithic Slab** is the selected **Foundation Type**.
- Specify the **Count**, which is the number of sill plates stacked vertically on each stem wall or grade beam.

5 Preview

A preview of the selected wall, including any doors or windows inserted into it, displays on the right. See *Dialog Preview Panes on page 20*.

WALL TYPES PANEL

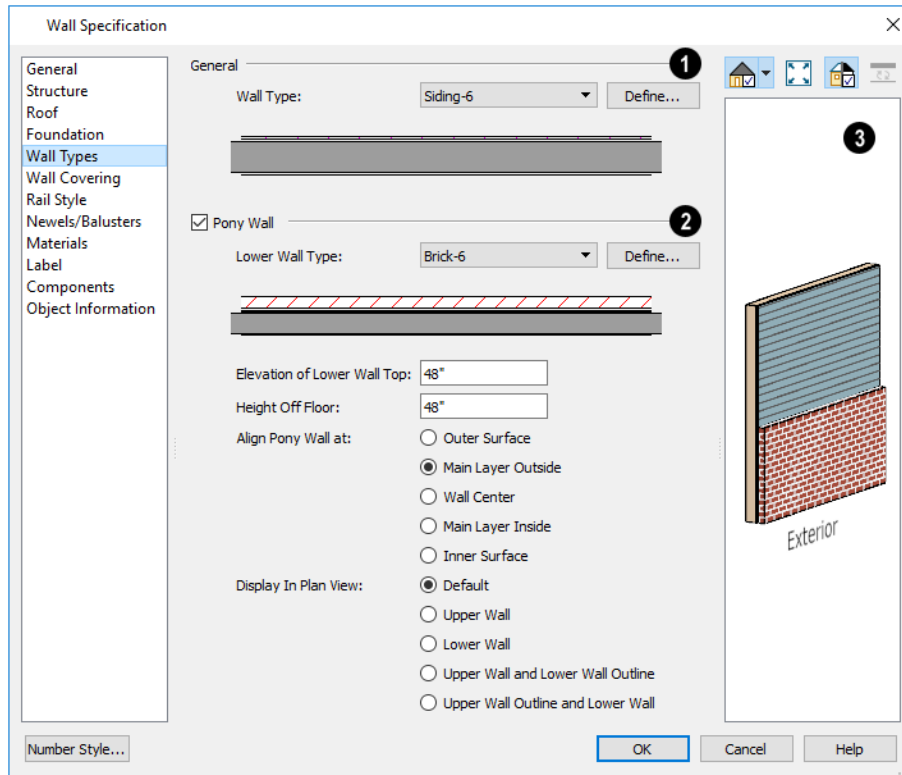

1 Wall Type

Choose the selected wall's **Wall Type** from the drop-down list of all currently available types. A preview of the selected wall type displays below the drop-down list.

- Click the **Define** button to open the Wall Type Definitions dialog to create or modify existing wall types. See *Wall Type Definitions Dialog on page 259*.

2 Pony Wall

Check **Pony Wall** to specify the selected wall as a pony wall having different wall types on its upper and lower portions. See [Pony Walls on page 232](#).

If the selected wall is a Foundation Wall, its initial wall type will become the Lower Wall Type. For all other walls, the initial wall type will be the upper Wall Type.

- Select the **Lower Wall Type**, the wall type of the lower portion of the pony wall, from the drop-down list. A preview of the selected wall type displays directly below.
- Click the **Define** button to open the Wall Type Definitions dialog.

Specify the height of the division between the upper and lower walls. These two settings are dynamic: if one is changed, the other will update accordingly.

- Specify the **Elevation of Lower Wall Top**, which is the division between the upper and lower walls. If the top of the lower pony wall is stepped or raked, this value will be “No Change”. This is an absolute value: regardless of the wall’s location, it is always measured from 0” (mm) - the default floor height for Floor 1. See [Floor Defaults Dialog on page 502](#).
- Specify the **Height Off Floor** of the division between the upper and lower walls. This value is measured from the floor height of the room(s) defined by the selected wall. If the wall defines rooms with different floor heights, “No change” will display.

Align Pony Walls - Specify how the layers of the selected wall’s Upper and Lower portions align.

- Select **Outer Surface** to align wall types at their outer surfaces.
- Select **Main Layer Outside** to align wall types at the exterior edge of their main layers.
- Select **Wall Center** to align the centers of the main layers of both wall types.
- Select **Main Layer Inside** to align the wall types at the interior side of their main layers.
- Select **Inner Surface** to align wall types at their interior surfaces.
- **No Change** is used by default when multiple pony walls with different alignment settings are selected. Choose this to leave the alignment as it was when the dialog was opened.

Specify which part of the pony wall you would like to **Display in Plan View**. See [Displaying Pony Walls on page 233](#).

- Select **Default** to display the portion of the pony wall specified in the Pony Wall Defaults dialog.
- Select **Upper Wall** to display the upper portion of this pony wall in plan view regardless of the default setting.
- Select **Lower Wall** to display the lower portion of this pony wall in plan view regardless of the default setting.
- When walls are group-selected, choose **No Change** to allow each wall in the selection set to maintain its own setting.

In the Pony Wall Defaults dialog only, specify the **Display of Openings in Non-Displayed Parts of Walls**. This controls how doors and windows display in plan view when they are located entirely in the part of a pony wall that is not visible.

- Select **Outline** to display the lines associated with openings but draw the wall layers’ lines and fill through them.
- Select **Always** to display doors and windows the same regardless of where they are located: drawing their outlines and preventing wall layers from drawing through them.
- Select **Hide** to not draw door and window outlines at all, so they cannot be seen.

Note: The Display of Openings in Non-Displayed Parts of Walls as well as the default Display in Plan View settings become permanent parts of views sent to layout. See *Keeping Layout Views Current on page 929*.

3 Preview

A preview of the selected wall, including any doors or windows inserted into it, displays on the right. See *Dialog Preview Panes on page 20*.

WALL COVERING PANEL

The WALL COVERING panel is also available in the Room Specification dialog. See *Room Specification Dialog on page 300*.

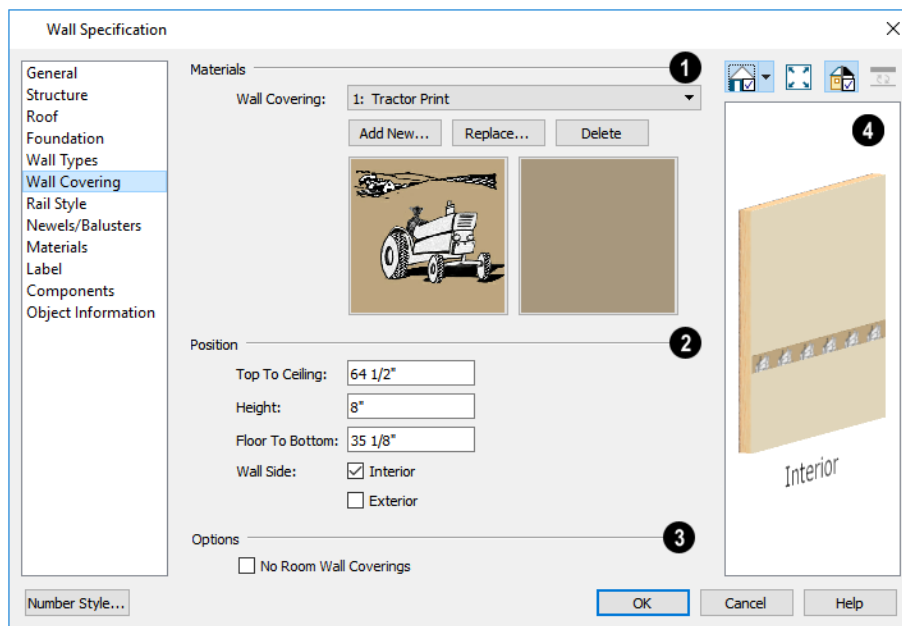

1 Materials

All wall covering materials applied to the selected wall are listed here. Select one from the drop-down list to edit its position or remove it from the wall.

- Click **Add New** to apply a new wall covering to the selected wall. See *Select Library Object Dialog on page 688*.
- Click **Replace** to replace the current wall covering with a new one from the library.
- Click **Delete** to remove the current wall covering from the selected wall.

Preview panes showing the current wall covering display the row of buttons.

2 Position

Specify the **Position** of the selected wall covering.

- Enter the heights of the current wall covering's **Top To Ceiling** and **Floor To Bottom**. The wall covering's **Height** from its top edge to its bottom edge can also be specified.

- Check **Interior** and/or **Exterior** to apply the wall covering to the inside and/or outside of the selected wall. Interior is checked by default. Not available for rooms. See *Wall Type Definitions on page 256*.

3 Options

Check **No Room Wall Coverings** to prevent any wall coverings assigned to rooms from generating on the selected wall.

4 Preview

Most wall coverings are best previewed using the Standard Rendering Technique. See *Dialog Preview Panes on page 20*.

RAIL STYLE PANEL

The settings on the RAIL STYLE panel are only available for Railings, Half Walls, Deck Railings, and Fencing. See *Rail Style Panel on page 274*.

NEWELS/BALUSTERS PANEL

The settings on the NEWELS/BALUSTERS panel are only available for Railings, Half Walls, Deck Railings, and Fencing. See *Newels/Balusters Panel on page 276*.

RAILS PANEL

The settings on the RAILS panel are used to specify the style and size of the horizontal components of a selected Railing, Deck Railing, or Fence. See *Railing and Deck Tools on page 227*.

A similar panel is also found in the Staircase and Ramp Specification dialogs and has additional settings for handrails at walls. See *Rails Panel on page 549*.

The settings on this panel are like those on the MOLDINGS panel found in a variety of dialogs in the program. See *Moldings Panel on page 665*.

MATERIALS PANEL

All walls - including interior walls, railings and fencing - have an “Exterior Wall Surface” and an “Interior Wall Surface”. See *Interior and Exterior Surfaces on page 258*.

The materials specified on the MATERIALS panel affect the appearance of walls and Solid Railings in 3D views but are not calculated in the Materials List. See *Materials Lists on page 904*.

For most railing types, the “Exterior Wall Surface” component only affects the appearance of the floor platform under the railing and the “Interior Wall Surface” component is not used. For fencing, neither material component is used.

LABEL PANEL

Wall labels display in plan view when the “Walls, Labels” layer is turned on and use the Text Style assigned to that layer. See *Wall Labels on page 241*.

For information about the settings on this panel, see *Label Panel on page 363*.

COMPONENTS PANEL

The information on the COMPONENTS panel can be used in the materials list. For more information, see *Components Panel on page 921*.

OBJECT INFORMATION PANEL

The information entered on the OBJECT INFORMATION panel can be used in the materials list. For more information, see [Object Information Panel on page 922](#).

Railing and Fencing Specification Dialogs

To open the Railing or Fencing Specification dialog, select a railing or fencing, or a group of railings or fencing, and click the **Open Object** edit button.



The Railing and Fencing Specification dialogs are the same as the Wall Specification dialog, but have three panels that apply only to Railings, Half Walls, Deck Railings, and Fencing. See [Wall Specification Dialog on page 262](#).

The RAILS panel is similar to the HANDRAIL panel found in the Staircase and Ramp Specification dialogs. See [Stairs, Ramps, and Landings on page 510](#).

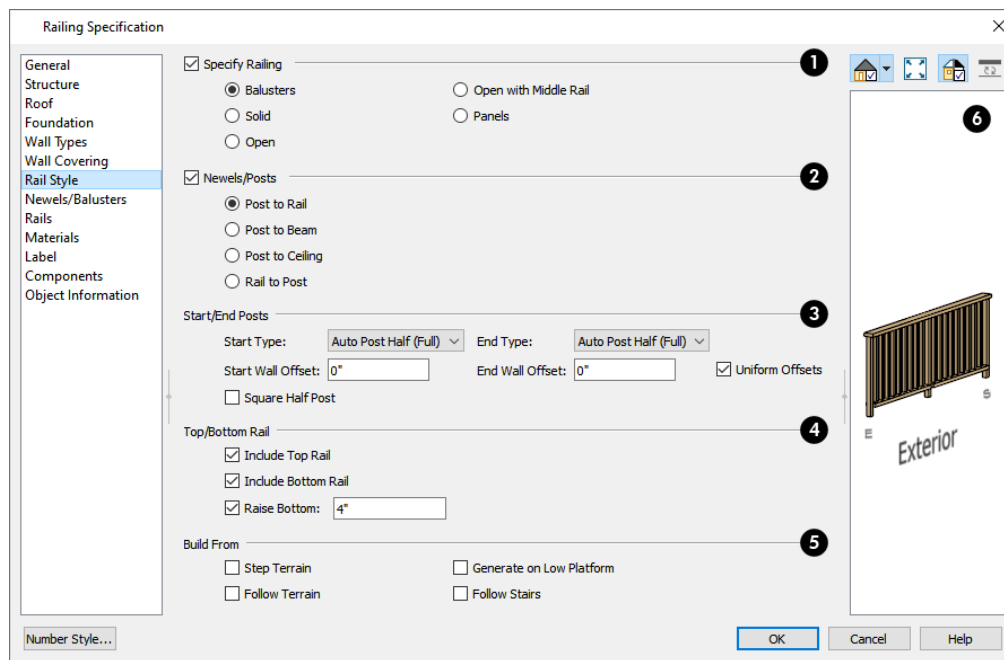
RAIL STYLE PANEL



1 Specify Railing

Check **Specify Railing** to specify the selected wall as a railing and enable the other options on this panel. Railings drawn using the **Railing**  or **Deck Railing**  tools have this checked by default.

Select the radio button for the desired **Railing Type**:

- Select **Balusters** to create regularly spaced balusters between larger newel posts.
- Select **Solid** to create a solid railing or Half Wall. Not available if the selected railing is also a Pony Wall. See [Pony Walls on page 232](#).

- Select **Open** to create a railing with only newel posts and top and bottom rails.
- Select **Open with Middle Rail** to create a railing with newel posts and top, bottom, and middle rails.
- Select **Panels** to create a railing composed of panels, then click the **Library** button to select a panel style from the Library Browser. See *Select Library Object Dialog on page 688*. You can specify the panel style on the NEWELS/BALUSTERS panel. See *Newels/Balusters Panel on page 276*.

2 Newels/Posts

Check **Newels/Posts** to assign these to the selected railing, then specify their properties.

- Select **Post to Rail** to create newel posts from the floor to the top rail. This option is selected by default.
- Select **Post to Beam** to create newel posts from floor to a beam placed just under the ceiling height. The beam's width is based on the Thickness of the selected railing wall.
- Select **Post to Ceiling** to extend the newel posts to the ceiling.
- Select **Rail to Post** to produce newel posts of the Height specified on the NEWELS/BALUSTERS panel, with rails that build to the sides of the newels.

3 Start/End Posts

If either the Start or End of the selected railing is connected to another railing, the settings associated with that end will not be available. These options are not available at all when **Newels/Posts** is unchecked above.

- Select the **Type** of post at the railing's **Start** and **End** points: "Full Post", "Half Post", or "None." The "Auto Post" options place either a Half post or None if the railing intersects a wall and a Full post otherwise: the currently applicable Type is indicated in parentheses. A Full Post is always placed where railings meet at a corner.
- Specify the **Start** and **End Wall Offsets**, which are the distances between the railing's half posts and the intersecting wall.
- Check **Uniform Offsets** to apply the same offset to both ends of the railing.
- Check **Square Half Post** to use a square half post where the railing intersects a wall instead of the post Type specified on the NEWELS/BALUSTERS panel. This only applies when a railing end is set to have a Half Post.

4 Top/Bottom Rail

These options control the placement of the top and bottom rail, or shoe.

- Uncheck **Include Top Rail** to eliminate the top rail.
- Uncheck **Include Bottom Rail** to eliminate the bottom rail and extend the balusters to the floor. Not available for Solid railings.
- Check **Raise Bottom**, then specify the **Floor to Bottom** distance, measured up from the floor platform to the bottom rail or panel.

5 Build From

Specify where the selected railing or fencing should **Build From**. With the exception of Follow Stairs, these settings are not available for Solid railings.

- Check **Step Terrain** to have the railing or fencing follow the terrain in horizontal steps between each newel post. Not available if the selected railing is a Pony Wall.
- Check **Follow Terrain** to have the railing or fencing follow the terrain smoothly. Not available if the selected railing is a Solid or a Pony Wall.
- Check **Generate on Low Platform** to build the selected railing on the lower floor platform when the railing defines two room areas with different floor heights. See [Aligning Railings on Different Platforms on page 251](#).
- Check **Follow Stairs** to have the railing or fencing follow the rise of stairs drawn in the same location. See [Inset or Middle Railing on page 534](#) for more information.

6 Preview

A preview of the selected railing or fence, including any doorways or gates inserted into it, displays on the right. See [Dialog Preview Panes on page 20](#).

NEWELS/BALUSTERS PANEL

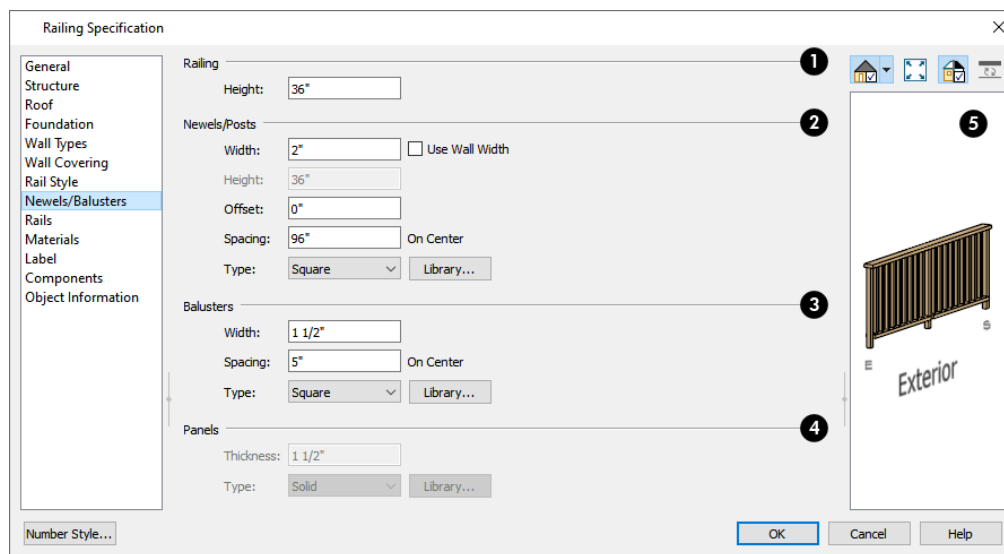

1 Railing

Specify the height of the railing.

- For interior railings, the **Railing Height** is measured from the height of the floor finish. See [Floor and Ceiling Platform Definitions on page 296](#).

2 Newels/Posts

Specify the characteristics of the selected railing's newel posts.

- Specify the **Width** of each newel at its widest point.
- Check **Use Wall Width** to assign the width of the wall type assigned to the selected railing to its newels.
- Specify the **Height**, which is the height from the floor or ground to the top of the newel. Not available if Post to Rail, Post to Overhead Beam or Post to Ceiling is selected on the RAIL STYLE panel. See [Rail Style Panel on page 274](#).
- Specify the **Offset**, which is the amount each newel is offset from the center of the railing. Use this to create a fence with the newels on one side of the fence boards.
- Specify the on-center **Spacing** of the newel posts.
- **Type** - Select Square, Round, or Library newels.

Note: Selecting Library from the drop-down list is the same as clicking the Library button to the immediate right and allows you to select a symbol from the library. See [Select Library Object Dialog on page 688](#).

3 Balusters

These settings are only available when the railing type is "Balusters" on the RAIL STYLE panel.

- Specify the **Width** or diameter of each baluster at its widest point.
- Specify the on-center **Spacing** of the balusters.
- **Type** - Select Square, Round, or Library balusters.

4 Panels

These settings are only available when the railing type is specified as Panels on the RAIL STYLE panel.

- Specify the panel's **Thickness**.
- Select "Solid" or "Library" from the **Panel Type** drop-down list.

 You can also apply newels, balusters, and panels onto a railing directly from the Library Browser. See [Inserted Objects on page 687](#).

5 Preview

A preview of the selected railing or fence, including any doorways or gates inserted into it, displays on the right. See [Dialog Preview Panes on page 20](#).

RAILS PANEL

The settings on the RAILS panel are used to specify the style and size of the horizontal components of a selected Railing, Deck Railing, or Fence. See [Railing and Deck Tools on page 227](#).

A similar panel is also found in the Staircase and Ramp Specification dialogs and has additional settings for handrails at walls. See [Rails Panel on page 549](#).

The settings on this panel are like those on the MOLDINGS panel found in a variety of dialogs in the program. See [Moldings Panel on page 665](#).

Wall Hatching Specification Dialog



To open the Wall Hatching Specification dialog, select a Wall Hatching and click the **Open Object** edit button. The settings in this dialog are also found in the Wall Hatching Defaults dialog. See [Wall Hatching on page 235](#).

FILL STYLE PANEL

The FILL STYLE panel is found in the specification dialogs for many different objects. See [Fill Style Specification Dialog on page 131](#).

LABEL PANEL

Wall Hatching labels display in plan view when the "Walls, Labels" layer is turned on and use the Text Style assigned to that layer. The Automatic Label for wall hatching is blank, but you can specify a custom label. For information about the settings on this panel, see [Label Panel on page 363](#).

Rooms

Chapter 12

Rooms are created when walls are drawn to enclose an area. When a room is defined in this way, it automatically receives both a floor and ceiling as well as features like moldings and finish materials that can be seen in 3D Views.

Rooms can be selected and edited. Each room can be assigned a Room Type with predefined characteristics. For example, a room defined as a Deck is assigned certain attributes that are different from a Kitchen.

TOPICS

Room Definition	280
Floor and Room Defaults	280
Room Types	282
Displaying Rooms	284
Selecting Rooms	284
Editing Rooms	286
Room Labels	288
Room Label Specification Dialog	290
Decks	292
Floor and Ceiling Heights	293
Floor and Ceiling Platforms	295
Special Ceilings	297
Room Moldings	300
Room Specification Dialog	300

Room Definition

A room is a totally enclosed area defined by any combination of joined walls or railings, visible or invisible. To be recognized as a room by Home Designer, a room must have an unbroken perimeter.

Unless otherwise specified, rooms generate floor and ceiling platforms automatically. Most rooms are also automatically covered by the roof when one is built. There are exceptions to this, such as rooms defined as Decks. See *Room Types on page 282*.

If a room is drawn within a larger structure and none of its walls connect to the exterior walls, either directly or indirectly by connecting to walls that do, it is referred to as an “island” room. The program will connect such a room to the larger structure with an Invisible Wall. See *Room Dividers and Invisible Walls on page 233*.

Room definition disappears if part or all of a surrounding wall is deleted. It is a good idea to finalize the position of walls before specifying Room Types or defining room attributes such as floor or ceiling height.

SUBDIVIDING ROOMS

When a room area is first defined, it inherits its characteristics from the Floor Defaults dialog for that floor. If the room is then specified as a particular type, it may inherit properties from the Room Defaults dialog associated with its type. See *Floor and Room Defaults on page 280*.

If a new room is created by subdividing a larger room, it inherits its characteristics from that larger room - including any non-default settings.

If two rooms are separated by an Invisible wall, their interior areas will be measured from the wall’s centerline and characteristics like the floor finish materials and moldings will break along that line.

- If the two rooms have different floor heights, the break will occur at the wall edge that faces the room where the floor is lower.
- If the two rooms have different ceiling heights, the break will occur at the wall edge that faces the room where the ceiling is higher.

COPYING AND PASTING ROOMS

A room can be copied into the same or a different plan by copying and pasting the walls that define it. Rooms copied in this manner retain their size and shape, as well as any finish materials assigned to the walls. See *Copying and Pasting Objects on page 117*.

If you want to retain the room’s Type and other specifications, copy and paste it and the walls that define it using the **Edit Area**  tools. See *Edit Area Tools on page 182*.

Floor and Room Defaults

 Select **Edit > Default Settings** to open the Default Settings dialog, then click the arrow to the left of “Floors and Rooms” to expand the category. Here, you can access several defaults dialogs which directly affect rooms. Select a line item and click the **Edit** button to open the defaults dialog associated with it.

FLOOR LEVEL DEFAULTS

Many important default values that affect rooms are specified in the Floor Defaults dialog for each floor in a plan. This dialog controls important information that the program uses to create a 3D model - particularly floor and ceiling heights and materials. Moldings can also be specified in the Floor Defaults dialog.

Only the defaults for Floor 1 can be set ahead of time. The program uses the settings from Floor 1 to create subsequent floors. Once a new floor is created, its floor defaults can be changed. See [Floor Defaults Dialog on page 502](#).



The Floor Defaults dialog for the current floor can also be opened by clicking the **Floor Defaults** button, which can be added to the toolbars. See [Adding and Removing Buttons on page 92](#).

FLOOR 1 DEFAULT HEIGHT

Home Designer always defines the default height of Floor 1 at 0'-0". This height value is measured from the top of the subfloor and is the constant by which the heights of structural elements in the program like walls, floors, and ceilings are measured. The heights of architectural objects can be measured relative to this absolute height, as well. As such, this default cannot be changed.

FLOOR/CEILING PLATFORM DEFAULTS

Floor and **Ceiling Structure** and **Finish** definitions assigned to rooms have a hierarchy of dynamic defaults. See [Dynamic Defaults on page 55](#).

- The plan-wide defaults for platforms are set in the Floor/Ceiling Platform Defaults dialog.
- The plan-wide defaults can be overridden for each floor level in the Floor Defaults dialogs.
- Floor-wide platform defaults can be overridden in the Room Type Defaults dialogs.
- The platform defaults for Room Types can be overridden for individual rooms in the Room Specification dialog. See [Structure Panel on page 302](#).

See [Floor and Ceiling Platforms on page 295](#).

ROOM TYPE DEFAULTS



The Room Types dialog can also be opened by clicking the **Room Types** button, which can be added to the toolbars.

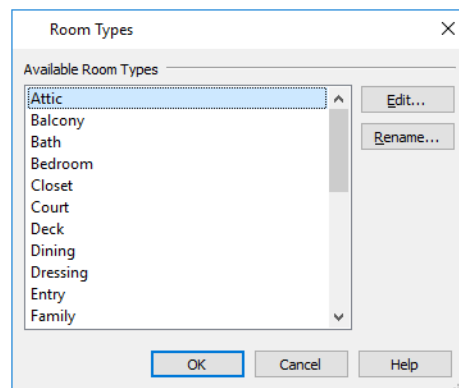

Select an **Available Room Type** from the list, then:

- Click the **Edit** button to modify the selected Room Type in the Room Type Defaults dialog.
- Click the **Rename** button to specify a new Name for the selected Room Type.

The settings in the Room Type Defaults dialogs allow you to specify the following for each Room Type:

- The **Name**, as used in its default Room Label
- Inclusion in the **Living Area**. See [Living Area on page 289](#).
- **Ceiling Structure** and **Finish**. See [Floor and Ceiling Platforms on page 295](#).
- **Floor Structure** and **Finish**.
- **Framing** and **Supports** for Deck rooms. See [Decks on page 292](#).
- **Moldings**. See [Room Moldings on page 300](#).
- **Components** information for use in the Materials List. See [Components Panel on page 921](#).

These settings are also found in the Room Specification dialog. See [General Panel on page 300](#), [Structure Panel on page 302](#), [Deck Panel on page 306](#), and [Deck Support Panel on page 308](#).

ROOM LABEL DEFAULTS

The Room Label Defaults dialog allows you to specify the initial appearance of room labels. This dialog is also accessed by expanding the “Rooms” category in the Default Settings dialog. See [Room Labels on page 288](#).

The options on most panels of the Room Label Defaults dialog are similar to those in the Text Specification dialog.

Any text added to the Room Label Defaults dialog displays in all subsequently created room labels, after the Room Name. Changes made to default settings do not alter existing room labels. To update existing labels so that they reflect changes made to the defaults, delete and replace them. See [Editing Room Labels on page 289](#).

Room Types

Room Types are used to quickly apply useful structural, functional, and appearance properties to different kinds of rooms. For example, a room assigned the “Garage” Room Type will receive concrete curbs under its walls when the Foundation is built, while a “Kitchen” will get GFCI Outlets when the Auto Place Outlet tool is used.

When a room is first created by enclosing an area with walls, it is assigned a generic room type of “Unspecified.” Once a room is created, though, it can be assigned a **Room Type** in the Room Specification dialog. See [General Panel on page 300](#).

A selection of pre-defined Room Types is available for use. See [Room Type Defaults on page 281](#).

ROOM TYPE DEFAULTS

Each Room Type is composed of two sets of characteristics: those set by the program, and those that are directly editable.

Characteristics set by the program are grouped together based on typical requirements for different types of rooms. These non-editable sets of properties is referred to as Room Functions.

Characteristics of a Room Type that can be modified include the default room Name, whether it is included in the Living Area, and the floor structure, finish, and deck supports. See [Room Type Defaults on page 281](#).

When you specify that a room be a certain Room Type, all of the characteristics associated with that Room Type are assigned to the room, overriding existing settings. After you specify a Room Type, though, various settings can be customized.

ROOM TYPES

There are three broad categories of room Types: Interior, Exterior and Hybrid.

- **Interior** - Most room Types are Interior.
- **Exterior** - Balcony, Court, Deck.
- **Hybrid** - Attic, Crawl Space, Garage, Open Below, Porch, Slab.

EFFECTS OF ROOM TYPES

Home Designer applies specific properties to rooms depending on the assigned Room Type.

Living and Conditioned Areas

- All interior type rooms are included in Living Area calculations by default; exterior and hybrid type rooms are not.
- All interior type rooms are included in Conditioned Area calculations by default. Open Below rooms are also included; however, exterior and other hybrid type rooms are not. See [Exported Envelope Data](#).

Ceilings and Roofs

- Interior rooms have a flat ceiling and are set to generate a roof above them.
- Exterior rooms are assumed to be open to the outside and do not have a flat ceiling or generate a roof above them.
- Attic rooms do not receive a ceiling and are ignored by the program's automatic roof generator.
- Garage, Slabs, and Porches are treated like exterior rooms in all cases except that they generate a ceiling and a roof above them by default.





Floors and Foundations





- A room's default floor structure and finish definitions are determined by its Room Type. See [Room Type Defaults on page 281](#).
- Open Below and Crawl Space rooms have no floor platform and influence how adjacent walls are framed. Stairwells are created using the Open Below Room Type.
- Garages have a foundation under them as defined by the Foundation Defaults dialog with a concrete slab at the top of stem wall or grade beam.
- The floor in Garage and Slab rooms display in 3D on Floor 0, not the first floor. See [Garages on page 490](#).
- Defining a room as Slab causes the floor platform thickness to equal the slab thickness value in the Foundation Defaults dialog.
- Deck rooms do not generate foundations. See [Decks on page 292](#).

Doors and Windows

- A window placed in a wall between an exterior room and an interior room always faces out toward the exterior.
- Doors placed between interior and exterior type rooms inherit their settings from the Exterior Defaults for the door tool, if hinged or sliding; they display threshold lines and are considered Exterior. See [Interior vs Exterior Doors on page 366](#).
- Doors placed between interior type rooms do not display thresholds and are considered Interior.
- Crawl Spaces and Open Below rooms are treated as interior rooms for window and door placement. All other hybrid type rooms are treated as interior.

Electrical

- An electrical object placed on the wall of an exterior room using the **Light** , **Switch** , **110V Outlet**  or **220V Outlet**  tool will automatically be a waterproof or outdoor type fixture, as specified in the Electrical Defaults dialog. See [Electrical Defaults Dialog on page 469](#).

- The **Auto Place Outlets**  tool adds outlets automatically to all interior rooms. In Bath rooms, only one outlet over each sink is added. See [Auto Place Outlets on page 472](#).
- **Auto Place Outlets**  places GFCI outlets in Kitchens and Baths.
- **Auto Place Outlets**  places fewer outlets in hybrid type rooms.
- **Auto Place Outlets**  does not place outlets in exterior type rooms, Porches or Open Below rooms.

Plan Check

- **Plan Check**  uses Room Types and their characteristics for basic plan checking. For example, a closet does not need a smoke detector but a bedroom does. See [Plan Check on page 50](#).

Displaying Rooms

Unlike most things in Home Designer, a room is not an individual object. Rather, a room is a space defined by the walls that enclose it.

IN PLAN VIEWS

Rooms typically display a transparent fill in plan view. You can, however, specify a solid color or fill pattern for all the rooms on an entire floor in the Floor Defaults dialog, or for individual rooms in the Room Specification dialog. See [Fill Style Panel on page 310](#).

In order for room fill styles to display, the “Rooms” layer must be turned on. See [Layer Attributes on page 124](#).

Room labels that include the room’s name as well as its size and other information can be set to display in plan view. See [Room Labels on page 288](#).

IN 3D VIEWS

Rooms can be viewed in views created by any of the 3D view tools. The **Dollhouse View** tool s can be used to see all rooms on the current floor without their ceilings. See [Creating Overviews on page 742](#).



IN THE MATERIALS LIST

 The contents of a room, including furnishings and floor and ceiling materials can be calculated using the **Calculate in Room** tool. See [Calculate Materials in Room on page 905](#).

The **Calculate Materials From Selection** edit tool creates a Materials List that calculates the finish materials in a selected room or rooms. Room moldings and wall, floor, and ceiling finish materials are counted, as is subflooring; but doors, windows, and structural materials like framing and other structural materials are not.

Selecting Rooms

Room definition is established when a room is completely enclosed by walls. You can confirm that a room has room definition by using the **Select Objects**  tool to select it. When a fully-enclosed room is selected, its interior space becomes highlighted. See [Selecting Objects on page 141](#).

Rooms can be group-selected using the Shift or Ctrl key. They can also be marquee-selected using the **Marquee Select Similar**  edit tool. To select rooms of a particular type, use the **Restrictive Selection**  option. See [Selecting Multiple Objects on page 143](#).



Although rooms may be visible, if the “Rooms” layer is locked in the current view, it will not be possible to select a room. See [Locking Layers on page 125](#).



Note: The selection color can be specified in the Preferences dialog. See [Colors Panel on page 62](#).

THE EXTERIOR ROOM

Each floor level of a plan has an Exterior Room, which allows you to control its exterior wall coverings and materials in the Exterior Room Specification dialog. See [Room Specification Dialog on page 300](#).

To select the Exterior Room in plan view, click just outside an exterior wall using the **Select Objects**  tool. If a wall or other object becomes selected instead, click the **Select Next Object**  edit button or press the Tab key until the Exterior Room becomes selected. The Status Bar indicates which object is currently selected. See [The Status Bar on page 23](#).





When it is selected, a highlighted band around the plan’s exterior displays.

IN 3D VIEWS

A room can be selected in a 3D view by clicking on an empty space on its floor or a wall surface while the **Select Objects**  tool is active.

If you select a wall or other object instead of the room, click **Select Next Object**  edit button or press the Tab key until the room becomes selected.

In exterior camera views and overviews, the Exterior Room for each floor can be selected by clicking on the exterior surface of an exterior wall using the **Select Objects**  tool and then clicking the **Select Next Object**  edit button.

SELECT ROOM BEFORE WALL IN 3D

By default, when you click on a wall surface in a 3D view, the individual wall will become selected. If you prefer to always select the room first instead of the wall, check **Select Room Before Wall in 3D** in the Preferences dialog. See *Architectural Panel on page 73*.

Editing Rooms

A room's structure and appearance can be modified using its edit tools and specification dialog. Rooms can be selected in all views, and the ways in which they can be edited depend somewhat on the current view. See *Selecting Rooms on page 284*.

IN 3D VIEWS

The top and bottom heights of individual walls, the floor and ceiling heights of individual rooms, and the floor and ceiling heights for an entire floor level can be edited using edit handles in 3D views. Lowered ceilings cannot be edited in 3D. See *3D Views on page 735*. See *The Exterior Room on page 285*.

The default floor and ceiling heights for an entire floor level can be edited by selecting the Exterior Room. See *The Exterior Room on page 285* and *Floor and Room Defaults on page 280*.

To change default ceiling heights in 3D

1. Create a 3D or Cross Section/Elevation view of the exterior of your plan.
2. Click on the exterior surface of a wall, then click the **Select Next Object**  edit button.
3. When the Exterior Room is selected in 3D:
 - The wall that you clicked on remains highlighted and an edit handle displays along its top edge.
 - When the wall is on any floor other than Floor 1, an edit handle also displays along its bottom edge.
 - A bounding box displays around each wall of the selected floor level.
 - The Status Bar says "Exterior Room". See *The Status Bar on page 23*.
 - A temporary dimension will display, measuring from the floor's default rough floor to default rough ceiling. See *Temporary Dimensions on page 325*.
4. Click and drag the edit handle on the top wall edge to adjust the default ceiling height, or the edit handle on the bottom edge to adjust the default floor height.
5. As you drag a handle, notice that the entire floor level is affected.
 - The wall that you clicked on remains highlighted and an edit handle displays along its top edge.
 - When the wall is on any floor other than Floor 1, an edit handle also displays along its bottom edge.
 - A bounding box displays around each wall of the selected floor level.
 - The Status Bar says "Exterior Room". See *The Status Bar on page 23*.

- A temporary dimension will display, measuring from the floor's default rough floor to default rough ceiling. See [Temporary Dimensions on page 325](#).
1. Click and drag the edit handle on the top wall edge to adjust the default ceiling height, or the edit handle on the bottom edge to adjust the default floor height.
 2. As you drag a handle, notice that the entire floor level is affected.

Note: Any rooms that do not update when the default floor or ceiling height is changed are not using the default values. To use the default values for a specific room, check Default for any of the room height values in its specification dialog. See [General Panel on page 300](#).

To adjust room heights in 3D

1. Create a 3D or Cross Section/Elevation view of your plan.
2. Click on the surface of a wall that faces a room to select it, then click the **Select Next Object**  edit button.
3. When a room is selected in 3D:
 - The wall that you clicked on remains highlighted and an edit handle displays along its top and bottom edges.
 - The Status Bar says "Room".
 - A temporary dimension will display in cross section/elevation views, and measure from the room's rough floor to rough ceiling.
4. Click and drag the edit handle on the top wall edge to adjust the room ceiling height, or the handle on the bottom edge to adjust its floor height. Temporary dimensions display.
5. As you drag a handle, notice that all walls defining that room are affected.

To adjust the height of a wall in 3D

1. Create a 3D or cross section/elevation view of your plan.
2. Click on a surface of the wall to select it.
3. Click and drag the edit handles along its top and bottom surfaces. See [Wall Heights on page 246](#).

Room materials such as floor, ceiling, and wall materials can be changed in 3D views using the **Material Painter** . See [Material Painter Tools on page 713](#).

Room moldings can be replaced directly from the library in 3D views, as well. See [Replace From Library on page 689](#).

IN THE SPECIFICATION DIALOG

 Floor and ceiling heights, moldings, wall coverings, and materials can all be specified in the Room Specification dialog. See [Room Specification Dialog on page 300](#).

USING THE EDIT TOOLS

A variety of options are available on the Edit Toolbar for a selected room. See [The Edit Toolbar on page 91](#).



Calculate Materials for Room creates a materials list of the contents of the selected room, not including walls. See [Calculate Materials in Room on page 905](#).



Auto Interior Dimensions edit button to generate interior dimensions that measure each wall defining the selected room(s). See [Auto Interior Dimensions on page 326](#).

Room Labels

A label can display in plan view for any area defined as a room. There are two parts to each room label:

- The Room Name, which is set in the Room Specification dialog.
- The room size, which can be reported as dimensions and/or an area and is determined by the configuration of the walls that define the room.



Room labels can move or even disappear when room entries are revalidated.

CUSTOM ROOM NAMES

The Room Names that display in room labels are based on the Room Types assigned in the Room Specification dialog. See [Room Types on page 282](#).

You can, however create a custom name for a selected room, also in the Room Specification dialog. See [General Panel on page 300](#).

Before creating a custom Room Name, assign the Room Type most similar to the room's actual use. For example, if you wish to name a room "Guest Room", begin by specifying it as a "Bedroom" since these rooms have similar uses.

You can assign a custom Room Name, move a room label or even delete it without affecting the Room Type.

ROOM LABEL DEFAULTS



The initial settings that control the size, font, color and other aspects of room label appearance are controlled in the Room Label Defaults dialog. See [Room Label Defaults on page 282](#).

You can also add additional text to the default room label if you wish. This text will appear in the labels for all rooms.

DISPLAYING ROOM LABELS

The display of room labels is controlled in the Layer Display Options dialog. Room labels are placed on the "Rooms, Labels" layer and use the Text Style assigned to that layer. See [Layer Display Options Dialog on page 126](#).

You can specify how the area of rooms is reported by the program by turning on the display of one or more of these layers:

- **Rooms, Standard Area** is measured from the center of interior walls that define the room and from either the outside surface or outside of the Main Layer of exterior walls, depending on the **Living Area to** setting in the General Plan Defaults dialog. It is rounded to the nearest square foot or mm and does not include the area within bay, box and bow windows. See [Exterior and Interior Walls on page 230](#) and [General Plan Defaults Dialog on page 56](#).
- **Rooms, Interior Area** is measured from the inner surfaces of all the room's walls.
- **Rooms, Interior Dimensions** is also measured from the inner surfaces of the room walls.

The display of room labels can also be controlled on a room by room basis in the Room Specification dialog. See [General Panel on page 300](#).

EDITING ROOM LABELS

Room labels are similar to simple **Text**  objects and can be moved and resized much like any other text object. You can also modify a room label's Text Style and other attributes in the Room Label Specification dialog. See [Room Label Specification Dialog on page 290](#).

The text of a room label cannot be modified in its specification dialog, however. The Room Name can only be specified in the Room Specification dialog and additional text can only be added in the Room Label Defaults dialog.

If you delete a room label, the Room Type and Room Name remain unchanged in the Room Specification dialog. To restore the label, check the **Show Room Label** check box on the GENERAL panel of that dialog.

If you wish to further customize an individual room's label by adding text, uncheck **Show Room Label** in the Room Specification dialog and create your own label using a Text object. See [The Text Tools on page 340](#).

ROOM AREA

Unlike the rest of a room label, the room area and dimensions are not standard text entries and cannot be edited or changed. The room area moves, resizes and rotates with the rest of the room label, but you can turn the area and dimensions on or off separately in the Layer Display Options dialog. See [Displaying Rooms on page 284](#).

All three area formats measure the room's size at floor level. The Interior Area room area calculation includes the areas within bay, box or bow windows, while the Standard Area and Interior Dimensions calculations do not.

LIVING AREA

The Living Area label is an automatically generated Text object that reports the area of the current floor specified as living space. By default, interior type rooms are defined as part of the Living Area, while exterior and hybrid type rooms are not. In addition, rooms with a Rough Ceiling height that is less than 48" (1200 mm) are excluded from the Living Area by default. See [Room Types on page 282](#).

Regardless of its Room Type, you can specify whether any room is included in the Living Area Calculation in the Room Specification dialog. See [General Panel on page 300](#).

A Living Area label is created as soon as a room area is defined by walls and/or railings and is recalculated every time you add, remove, resize, or redefine a room or when you **Rebuild Walls/Floors/Ceilings** . If multiple buildings are created, each will have its own Living Area label. If none of a structure's rooms are included in the Living Area Calculation, however, no Living Area label will display for it.

Each Living Area label can be edited in its specification dialog. Bear in mind, though, that if a new floor is added, any existing Living Area labels will be deleted and replaced. See [Room Label Specification Dialog on page 290](#).

Living Area labels are placed on the "Room Labels" layer. To turn off the display of all Living Area labels in a plan without affecting individual room labels, you can uncheck **Show Living Area Label** in the General Plan Defaults dialog. See [General Plan Defaults Dialog on page 56](#).

Living Area labels cannot be deleted: if you select one and click the **Delete**  edit button, **Show Living Area Label** in the General Plan Defaults dialog will become unchecked.

LIVING AREA VS. FOOTPRINT

The Living Area should not be mistaken for the footprint of a house. Only true livable areas are included in the Living Area calculation. By default, exterior and hybrid room types such as Garage, Deck, and Porch are not included. Neither is any room labeled Open Below or Attic. See [Room Types on page 282](#).

Regardless of its room type, you can specify whether a room is included in the Living Area calculation in the Room Specification dialog. See [General Panel on page 300](#).

Living Area is measured from either the outside surface or the outer surface of the Main Layer of exterior walls. See [Wall Type Definitions on page 256](#).

Room Label Specification Dialog

 The Room Label Specification dialog opens if you select a Room Label or Living Area Label and click the **Open Object** edit button. See [Room Labels on page 288](#).

A similar Text Specification dialog is available for simple **Text** objects in legacy plan or layout files created in Version 8 or prior. See [Compatibility with Other Programs on page 32](#).

Note: Rich Text objects have a different specification dialog. See [Rich Text Specification Dialog on page 342](#).

TEXT PANEL

The settings on the TEXT panel allow you to type the selected Living Area Label's content. Text cannot be added to a selected room's label, however.

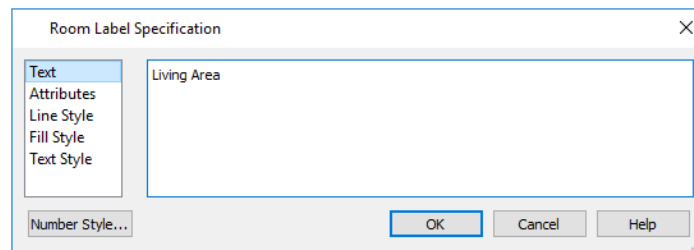

Text Entry

- Enter text in the Text Entry field. This field is available for the Living Area but not for a selected room's label. See [Room Labels on page 288](#).
- Depending on the current **Preferences**  settings, pressing the Enter key either forces a new line in the text box or closes the dialog. A carriage return can also be added by typing Shift + Enter or Ctrl + Enter. See [Text Panel on page 66](#).
- Text automatically wraps to a new line without requiring a hard return.
- Tabs can be added to the text by pressing the Tab key.

ATTRIBUTES PANEL

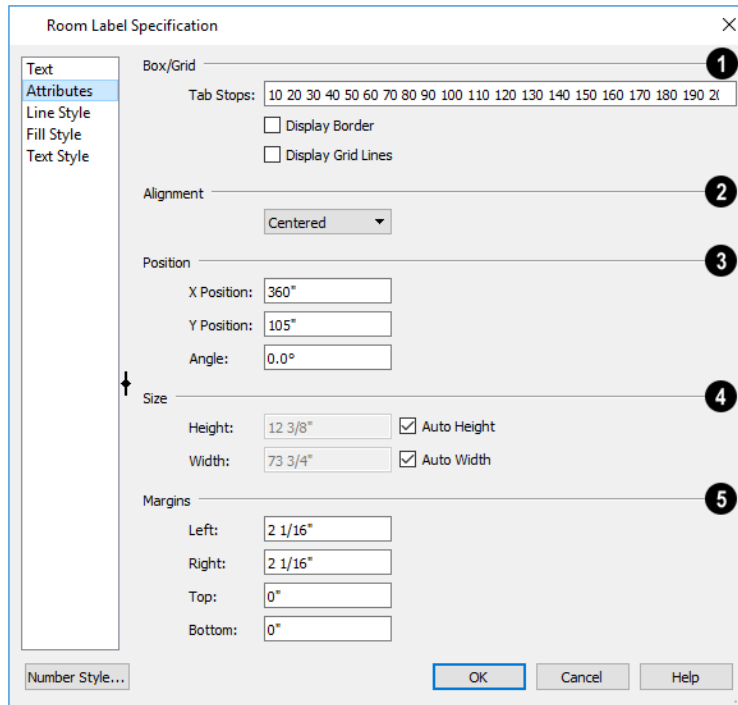

1 Box/Grid

- Specify the positions of the selected text object's **Tab Stops**.
- In the text field, specify the number of spaces from the left edge of the text box where each new column begins. The first column always starts at 0 and is not listed.
- Check **Display Border** to turn on the display of a border polyline around the selected object.
- Check **Display Grid Lines** to turn on the display of the grid formed by the specified rows and columns.

2 Alignment

- Select "Left", "Centered", "Right", or "Justified" from the drop-down list.

3 Origin/Angle

- Specify the **X Position** and **Y Position** of the selected object relative to the origin. See *3D Drafting on page 11*.
- Specify the **Angle** of the selected text object. The default value is 0°.

4 Size

- Specify the **Height** of the selected text object(s) or check **Auto Height** to automatically adjust its height to match its contents.
- Specify the **Width** to of the selected text object(s) or check **Auto Width** to automatically adjust its width to match its contents. When Auto Width is used, text extends in a single line rather than wrap.
- Specifying a Height and/or Width of 0 sizes the text box as small as the text within it allows without turning on the Automatic behavior.

5 Margins

- A default **Left** and **Right** margin is applied. **Top** and **Bottom** margins are measured relative to the line height and may not extend to the text box completely when given a value of 0.

Preview

A preview of the selected text object displays on the right. Not available for Room Labels.

LINE STYLE PANEL

The LINE STYLE panel is found in the specification dialogs for many different objects. For more information, see [Line Style Panel on page 204](#).

FILL STYLE PANEL

For information about the [Fill Style Specification Dialog on page 131](#).

TEXT STYLE PANEL

The TEXT STYLE panel is available for a number of objects in the program and control the appearance of the selected object's text. See [Text Style Panel on page 361](#).

Decks

A Deck room is an exterior-type room that uses deck planking and framing to create a floor platform rather than using a floor finish that spans the entire room area. See [Floor and Ceiling Platform Definitions on page 296](#).

The default settings for deck planking and framing are set in the Deck Room Defaults dialog. See [Room Type Defaults on page 281](#).

To draw a deck, select **Build> Railing and Deck> Straight Deck Railing** , then click and drag to draw a railing. Once room definition is established, the area defined by the railing can be assigned the “Deck” room type.

- To create a deck without a railing, use one of the **Deck Edge** tools. See [Fencing Tools on page 230](#).
- You can also create a regular, polygon-shaped deck using the **Polygon Shaped Deck**  tool. See [Polygon Shaped Deck on page 229](#).

A room does not have to be defined by Deck Railing to be specified as a “Deck.” See [Room Types on page 282](#). You can also define a room as a “Deck” in the Room Specification dialog. See [General Panel on page 300](#).

By default, decks do not have roofs. If you want a roof over a deck, check **Roof Over This Room** in the Room Specification dialog. See [Structure Panel on page 302](#).

To give the roof a visible means of support, you can select the **Post to Beam** option in the Wall Specification dialog. See [Rail Style Panel on page 274](#).

Openings in deck railings can be created using **Doorways** . See [Openings in Railings on page 377](#).

DECK FRAMING AND PLANKING

When a Deck room is created, the floor platform is modeled using joists, beams, posts, and planking as specified in the Deck Room Defaults dialog. See [Structure Panel on page 302](#), [Deck Panel on page 306](#), and [Deck Support Panel on page 308](#).

- If a floor level is present below the one that the Deck room is created on, the framing will be created there. If needed, beams may be generated with posts beneath them, if specified. When terrain is present, the posts will have footings, again, if specified.
- If a floor level is not present below the Deck, framing will be generated on the same floor as the room. Beams may be created but posts will not.
- Deck framing, planking, posts, and beams are placed on their own layers with names that begin with “Framing, Deck”: for example, “Framing, Deck Posts”. These layers are often turned off in plan view but are typically turned on in 3D views. See [Displaying Framing on page 632](#).

If standard floor framing is present when a room is specified as a Deck, that framing is deleted and replaced with deck framing.

If changes are later made to the settings on the DECK panel of the Room Specification dialog, the deck framing and planking will be automatically rebuilt in response. To prevent this from happening, uncheck **Automatic Deck Framing**.

Once created, the individual planking and framing objects generated for a Deck room can be selected and edited like other framing objects, provided that **Automatic Deck Framing** is turned off. See [Editing Framing on page 634](#).

To rebuild a deck’s framing and remove any changes you may have made to individual deck framing or planks, select the Deck room and click the **Build Deck Framing**  edit button.

If you delete a Deck room, its deck framing and planking will be automatically deleted, as well. To prevent this from happening, check **Keep Deck Framing After Deck Room is Deleted**. See [Deck Panel on page 306](#).

The structural materials for a selected deck can be calculated in a Materials List by clicking the **Calculate Structural Materials for Deck** edit button. See [Materials Lists on page 904](#).

Floor and Ceiling Heights

Default floor and ceiling heights are defined in the Floor Defaults dialog for each floor, including the foundation. Use the Floor Defaults dialog to change these values on a floor-by-floor basis. See [Floor and Room Defaults on page 280](#).

Use the Room Specification dialog to set floor heights on a room-by-room basis. See [Room Specification Dialog on page 300](#).

Different rooms on the same floor can have unique floor and ceiling heights, allowing you to create:

- Split levels and bi-levels
- Sunken living rooms and garages
- Cathedral, vaulted, and coffered ceilings.



In 3D views, you can adjust the default floor and ceiling height for the entire floor, the floor and ceiling height for an individual room, or the top and bottom heights of an individual wall. See [In 3D Views on page 286](#).

In order to raise or lower an area's floor or ceiling height, you must give it a room definition. To create room definition without enclosing an area with solid walls, use **Railings** .

Invisible walls and railings will fill in the vertical space between floor platforms of different heights as long as **Generate Between Platforms** is checked in their specification dialog. See [General Panel on page 262](#).

Ceiling and floor heights are interrelated. Changing the floor height in one room can affect ceiling heights of the rooms below.

- If a room's floor is lowered, its ceiling height is increased while the ceiling below that room drops.
- If the floor is raised, the ceiling height decreases while the ceiling below that room is raised.

If the rooms above a particular room have more than one floor height, the room's ceiling is stepped.

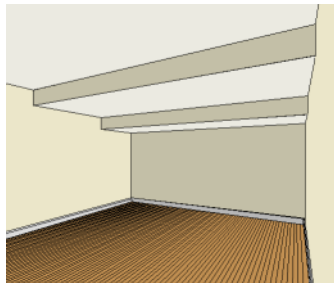

In a situation like this, a Lowered Ceiling can be used to cover "steps" made by different floor heights on the floor above. See [General Panel on page 300](#).

DROPPED CEILINGS AND RAISED FLOORS

The structure of a dropped, or suspended, ceiling can be specified in the Ceiling Finish dialog either for a room or the defaults for a floor. See [Floor and Ceiling Platform Definitions on page 296](#).

To create a framed dropped ceiling

1. Select a room and click the **Open Object**  edit button.
2. On the STRUCTURE panel of the Room Specification dialog, click the **Ceiling Finish** button. See [Structure Panel on page 302](#).

3. In the **Ceiling Finish** dialog:

- Check **Frame Lowered Ceiling**.
- Specify the depth of the **Air Gap**, or the distance between the bottom of the ceiling platform and the top of the lowered ceiling framing.
- Specify the **Framing Thickness**, which is the depth of the framing layer.

A dropped ceiling composed of a metal grid requires only two layers: one for the plenum and one for the tiles. To achieve this, set the Framing Thickness to 0” (mm).

SHELF CEILINGS

In rooms with high or vaulted ceilings, it is possible to have a smaller room such as a closet that has a flat, lower ceiling. By default, the area above the flat ceiling will be enclosed by automatically-generated Attic walls. See [Attic Walls on page 254](#).

If you prefer, you can specify that these Attic walls be suppressed and an open space be created instead. This condition is referred to as a **Shelf Ceiling**, or plant shelf, and can be specified in the Room Specification dialog of the room with the lower flat ceiling. See [Structure Panel on page 302](#).

SPLIT LEVELS

A split level can be created by raising or lowering the floor and ceiling heights of various areas of the plan.

In the following example, the lowest floor height is 0, the next is 24, and the next is 48 inches. The ceiling height in each room is set at 109 inches. See [Split Levels on page 507](#).

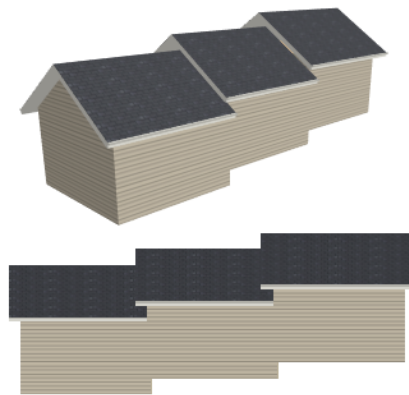

Floor and Ceiling Platforms

In many ways, rooms in Home Designer are defined by the floor platforms below them and the floor and/or ceiling platforms above.

All floor and ceiling platform and finish materials are used for the calculation of the materials list. See [Materials Lists on page 904](#).

FLOOR VS CEILING PLATFORMS

Floor and ceiling platforms are not the same thing in Home Designer. Floor platforms have living space above them and are designed to be weight-bearing. Ceiling platforms, on the other hand, have living space below them but not above them.

They are not designed to bear weight and are typically less strong - and less thick - than floor platforms.

FLOOR AND CEILING PLATFORM DEFINITIONS

Floor and ceiling platforms are made up of layers of different materials such as framing, subflooring, drywall, and finish materials.

Floor and ceiling platform definitions play a role in determining floor and ceiling heights. Floor and ceiling finishes can be used to create dropped ceilings. See [Floor and Ceiling Heights on page 293](#).

- You can specify the composition of the default floor and ceiling platforms for an entire plan in the Floor/Ceiling Platform Defaults dialog. The settings in this dialog are also found in the Room Specification dialog. See [Structure Panel on page 302](#).
- Floor and ceiling platforms can be customized on a floor-by-floor basis in the Floor Defaults dialog. See [Floor Level Defaults on page 281](#).
- Floor and ceiling platforms can also be customized for individual rooms in the Room Specification dialog. See [Structure Panel on page 302](#).

Regardless of how they are accessed, floor and ceiling structure are defined in the Floor and Ceiling Structure Definition dialogs. See [Material Layers Definition Dialogs on page 709](#).

In addition to the structural layers of a platform, floors and ceilings also have a finish layer. You can specify floor and ceiling finish materials for an entire floor or individual room on the MATERIALS panel of either the Floor Defaults or Room Specification dialog. See [Materials Panel on page 716](#).

In addition to the structural layers of a platform, floors and ceilings typically have one or more finish layers. You can specify floor and ceiling finish materials for an entire floor or individual room much the way you can structural layers: by clicking the **Floor Finish** and/or **Ceiling Finish** button on the STRUCTURE panel of either the Floor Defaults or Room Specification dialog to open the Floor or Ceiling Finish Definition dialog.

FLOOR AND CEILING FINISHES AND THE MATERIAL PAINTER

 If you use the **Material Painter** to change a room's floor or ceiling finish material, it will add that material to the room's Floor or Ceiling Finish Definition. Changes to a Deck room's planking or framing will affect its Floor Structure Definition. See [Material Painter Tools on page 713](#).

When the Material Painter is used to add a floor or ceiling finish material in a room where one does not currently exist, a new finish layer is created and the material Depth is used as its Thickness. See [Materials List Panel on page 733](#).

STEPPED FLOOR AND CEILING PLATFORMS

Each floor has default floor and ceiling heights. You can, however, use the Room Specification dialog to specify floor and ceiling heights on a room by room basis to create stepped floors and ceilings. See [Structure Panel on page 302](#).

If you require a single floor platform with a uniform height and thickness but different ceiling heights for the rooms below, specify a lowered ceiling using the Ceiling Finish Specification dialog. See [Lowered Ceilings on page 297](#).

Either way, by default, any gap between floor and ceiling platforms that step at a railing or invisible wall is closed off by a short section of solid wall. If you require a gap between the platforms, either select a single-layer wall type or uncheck **Generate Between Platforms** in the Wall or Railing Specification dialog. See [General Panel on page 262](#).

PLATFORM EDGES

Typically, floor and ceiling platforms are built so that they bear on top of walls. The edges of the platform structures extend through exterior walls to the layer of the wall type definition with the **Build Platform to This Line** setting. See [Wall Type](#)

Definitions on page 256.

- For framed walls, the **Build Platform to This Line** layer is set as the outside of the wall's Main Layer,
- For concrete walls, it's the inside of the wall's Main Layer.
- The platforms of rooms with raised floors and/or lowered ceilings build in the same manner: to the **Build Platform to This Line** layer of the wall type assigned to the railing or invisible wall defining the room. See *Floor and Ceiling Heights on page 293.*

For a given wall type, you can specify a different **Build Platform to This Line** wall layer surface provided that it is on the exterior side of the Main Layer.

In addition, you can specify that individual walls build through floor and ceiling platforms in the Wall Specification dialog. See *General Panel on page 262.*

Special Ceilings

By default, the program builds a flat ceiling platform on top the wall plates of a room. More varied and complex ceilings are made using settings in the Room Specification dialog and the **Ceiling Plane**  tool. Ceiling planes are drawn and can be edited much like roof planes. See *Ceiling Planes on page 586.*

LOWERED CEILINGS

If you require uniform top plate heights and a single floor platform with a uniform height and thickness but different ceiling heights for the rooms below, specify a lowered ceiling. You can define a lowered or dropped ceiling in a room without affecting the top height of the walls by specifying the lowered ceiling framing as a layer in the Ceiling Finish Definition. See *Floor and Ceiling Platforms on page 295.*

In the following illustration, the default ceiling height for the entire first floor is 120", and the room on the right has a ceiling finish lowered to 96".

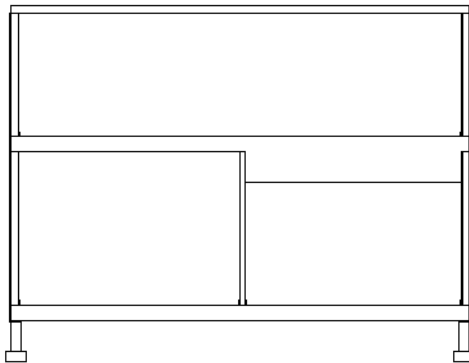

When a Soffit is positioned against the ceiling in a room, the Ceiling Finish layers located directly above it - including any lowered ceiling framing - will not generate. See *Placing Soffits on page 703.*

To create a lowered ceiling

1. Select the room in which you would like to specify a lowered ceiling.
2. Click the **Open Object**  edit button to open the Room Specification dialog.

3. On the STRUCTURE panel, click the **Ceiling Finish** button to open the Ceiling Finish dialog. See *Material Layers Definition Dialogs on page 709*.
 - Check **Frame Lowered Ceiling**.
 - Specify the **Air Gap**, which is the distance between the bottom of the platform above and the top of the lowered ceiling framing.
 - Specify the **Framing Thickness**, which is the depth of the lowered ceiling joists.
4. When you are finished, click OK to close the Ceiling Finish Definition dialog.
5. On the Structure panel, notice that the preview diagram represents the Finished Ceiling height (F).

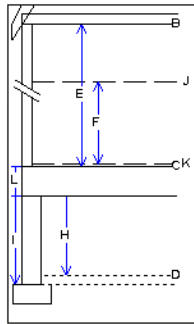

VAULTED AND CATHEDRAL CEILINGS

A cathedral ceiling has the same pitch as the roof and is created using the underside of the roof above the room. A vaulted ceiling typically has a different pitch from that of the roof and is often framed using scissor trusses. See *Scissors Trusses on page 651*.

To create a cathedral ceiling

1. Build a roof for your plan. See *Roofs on page 556*.
2. Select the room and open the Room Specification dialog. See *Room Specification Dialog on page 300*.
3. On the STRUCTURE panel, uncheck **Flat Ceiling Over This Room**.

By default, cathedrals ceiling use the ceiling material set in the Room Specification dialog. If you require a different material on a given roof plane, uncheck **Use Room Ceiling Finish** in the Roof Plane Specification dialog. See *Options Panel on page 581*.

To create a vaulted ceiling

1. To create a ceiling pitch different from the roof's, select **Build> Roof> Ceiling Plane**  and draw ceiling planes. See *Ceiling Planes on page 586*.
2. Select each ceiling plane and specify its pitch. See *Ceiling Plane Specification Dialog on page 587*.

TRAY CEILINGS

A tray ceiling is an area within a ceiling that is raised and has either vertical or sloping sides. A standard tray ceiling can be easily created by placing Soffits around the perimeter of the room. An angled tray ceiling can be created using the underside of roof planes above.

To create an automatic angled tray ceiling

1. In the Room Specification dialog, make sure that **Flat Ceiling Over this Room** is checked, then specify the desired height of the walls as the **Ceiling Height**. See [Structure Panel on page 302](#).
2. Make sure that **Auto Rebuild Roofs** is unchecked, then build the roof. See [Build Roof Dialog on page 562](#).
3. Change the **Ceiling Height** of the room to the desired height of the flat ceiling surface in its center.

In plan view, dashed lines indicate where the ceiling changes from sloped to flat. These lines are located on the “Ceiling Break Lines” layer in the Display Options dialog. See [Layer Display Options Dialog on page 126](#).

If the roof is rebuilt after the ceiling height is adjusted upward, the new roof will be raised to match the new ceiling height and a tray ceiling will not be created.

In the following example, a hip roof is built on 8' (2400 mm) ceilings. After the roof is built, the Ceiling Height is raised to 10' (3000 mm). The resulting ceiling follows the roof pitch for 2' (600 mm), then becomes a flat ceiling.

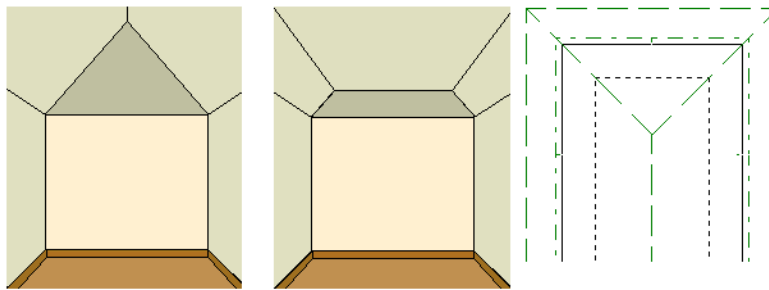

CANTILEVER UNDERSIDES

Occasionally, a room will cantilever out past an exterior wall. You can specify the surface material of the underside of a cantilever on the MATERIALS panel of the Room Specification dialog. For no material, select “No Material” from the Plan Materials dialog. See [Room Specification Dialog on page 300](#).

OTHER SPECIAL CEILINGS

Soffits  can be used in various ways to enhance the 3D model. Soffits’ ability to follow the slope of the roof offers unlimited possibilities, such as exposed beams or trusses and coffered ceilings. See [Special Applications for Soffits on page 704](#).



Framing members and locked roof trusses can also be used for similar purposes.

Room Moldings

Base molding, chair rail, and crown moldings can be applied to rooms on a floor by floor basis in the Floor Defaults dialogs, to different room types in the Room Type Defaults dialogs, and to individual rooms in the Room Specification dialog. See *Floor and Room Defaults on page 280* and *Room Specification Dialog on page 300*.

By default, Home Designer does not automatically add room moldings to exterior or hybrid room types. Baseboards and chair rails are not automatically added to Open Below rooms, either; however, crown molding is if it is specified in the defaults for the room's floor. See *Room Types on page 282*.

Base molding and chair rail heights are both offset from the floor, while crown molding is offset from the ceiling. For additional information, see *Applying Moldings on page 665*.

By default, room moldings are suppressed behind cabinets placed against a wall. You can prevent this from occurring by checking **Suppress Adjacent Room Moldings** in the Cabinet Specification dialog. See *General Panel on page 451*.

Suppress Adjacent Room Moldings is also an option for in the Architectural Block Specification dialog. See *General Panel on page 699*.

Room Moldings can be suppressed along an individual wall by checking **No Room Molding** in the Wall Specification dialog. See *General Panel on page 262*.

Room Specification Dialog

 The Room Specification dialog controls the structural characteristics and appearance of a selected room. To open the Room Specification dialog, select one or more rooms and click the **Open Object** edit button. See *Selecting Rooms on page 284*.

Some of the panels in this dialog are also found in the Exterior Room Specification dialog as well as in the Floor, Floor/Ceiling Platform, and Room Type Defaults dialogs. See *Floor and Room Defaults on page 280*.

The Room Specification dialog has the following panels:

Some values in this dialog are dynamic. A value with Default specified references the Floor Defaults dialog. To return a value to the default, replace the check mark. See *Dynamic Defaults on page 55*.

The settings in this dialog are similar to those in the Floor Defaults dialog, but affect only the selected room. See *Floor Defaults Dialog on page 502*.

If multiple rooms are selected, not all of the settings in this dialog will be available. See *Selecting Objects on page 141*.

GENERAL PANEL

The GENERAL panel is also available in the Room Type Defaults dialogs. See *Floor and Room Defaults on page 280*.

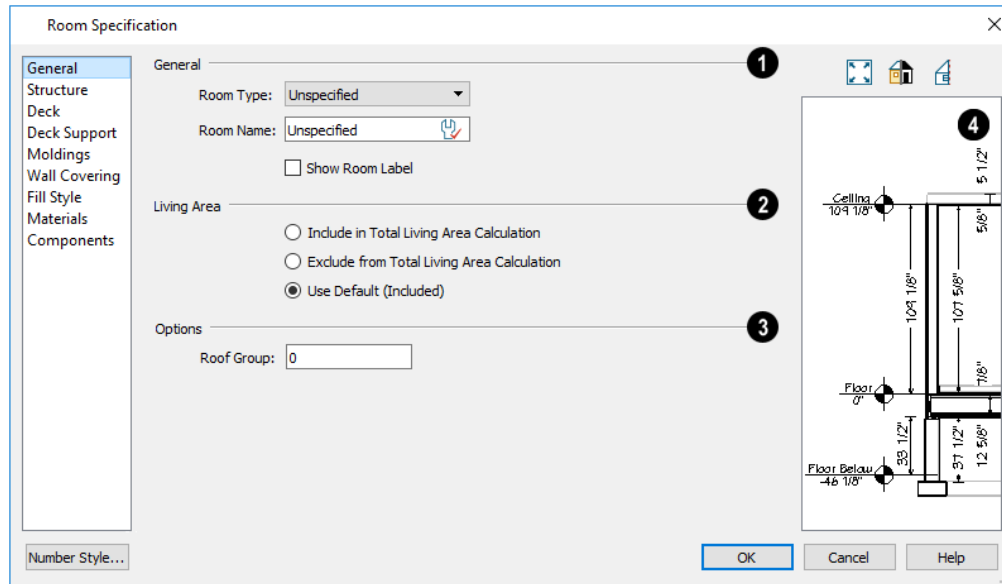

1 General

Specify the Room Type and the appearance of the Room Label

- Select the **Room Type** from the drop-down list. Changing the Room Type can affect settings throughout the dialog. See [Room Types on page 282](#).
- Click the **Define** button to open the Room Types dialog where you can customize the settings of the selected Room Type.
- In the Room Type Defaults dialog only, the **Function** of the selected room type displays for reference. See [Room Types on page 282](#).
- If you wish to use a custom name in the room’s label, type the desired **Room Name** in the text field.
- Check **Show Room Label** to display the room label in plan view. See [Room Labels on page 288](#). Show Room Label is unchecked automatically if you select “Unspecified” as the Room Type, and checked automatically if you select any other Room Type; however, you can turn this behavior off if you wish in the Preferences dialog. See [Architectural Panel on page 73](#).

2 Living Area

See [Living Area on page 289](#).

- Select **Include in Total Living Area Calculation** to include the room in the Living Area regardless of its Room Type.
- Select **Exclude from Total Living Area Calculation** to exclude the room from the Living Area regardless of its Room Type.
- Select **Use Default for Room Type (Included/Excluded)** to base the selected room’s inclusion in the Living Area on its Room Type. The default for the selected Room Type is stated in parentheses.

3 Options

- Specify the **Roof Group** of the selected room. Change this value to control how the program combines the selected room's roof system with that of the rest of the building when automatic roofs are built. This value is nearly always left at zero. Not available in the Room Type Defaults dialogs. See *Roof Groups on page 560*.

4 Preview

The preview on the right side of this dialog features a cross section diagram showing the relationships between the room's heights and platform thicknesses.

- If present, the floors above and below the selected room are also shown. The left side of the floor above is offset for clarity.
- The height and thickness values shown in this diagram are set on the *Structure Panel on page 302*.

STRUCTURE PANEL

Some settings on the STRUCTURE panel are also found in the Floor, Floor/Ceiling Platform, and Room Type Defaults dialogs.

In the Floor/Ceiling Platform and Room Type Defaults dialogs, only the **Floor** and **Ceiling** settings are available. See *Floor and Room Defaults on page 280*.

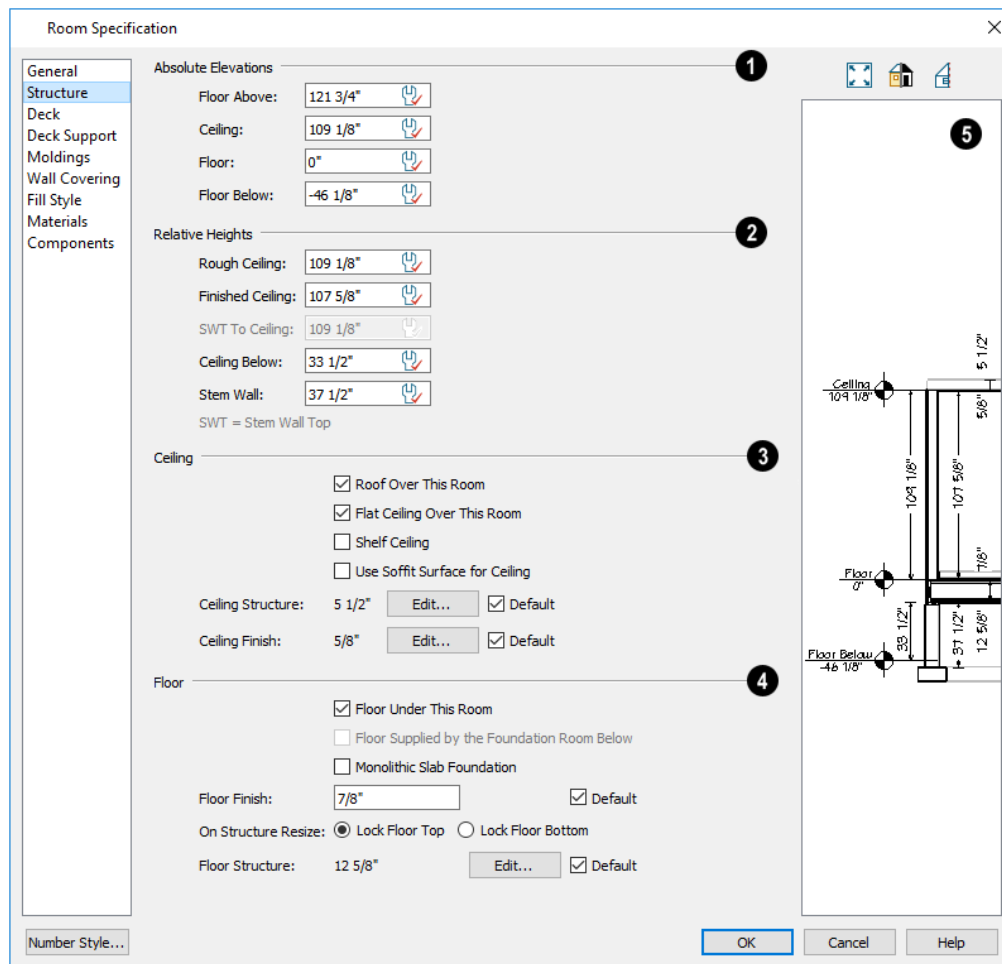

Active Defaults  icons in the Elevation and Height fields, as well as Default check boxes next to the Structure and Finish fields indicate that these settings are Dynamic Defaults. See [Dynamic Defaults on page 55](#).

Note: Many of the settings on this panel are interdependent. For example, if the Ceiling Structure thickness is modified, the Absolute Ceiling and Rough Ceiling heights will change in response.

1 Absolute Elevations

These height values are measured from zero, which is the default top height of the subflooring on Floor 1. See [Floor and Ceiling Heights on page 293](#).

- The **Floor Above** height displays here for reference. If multiple rooms with differing floor heights exist directly above, “No Change” will display.
- Specify the **Ceiling** height of the selected room, as measured from zero to the bottom of the ceiling framing. Not available in the Room or Floor Defaults dialog or if multiple floor heights are specified above the selected room.
- Specify the **Floor** height, as measured from zero to the top of the subfloor.

Note: The default floor height for Floor 1 is 0. It can be modified in the Room Specification dialog, but not in the Floor 1 Defaults dialog. See [Floor and Room Defaults on page 280](#).

- If a room is defined directly beneath the selected room on the floor below, additional settings may be available.
- Specify the **Floor Below** height, which is the subfloor height of the room directly below where you clicked to select the currently selected room. If there are multiple rooms with differing floor heights located below, this value may change depending on where you click.
- If the selected room is directly above a Garage and there is a foundation present, you can specify the **SWT Below** height, which is the top height of the concrete stem walls around the perimeter of the garage.

2 Relative Heights

These height values are measured from surfaces within the selected room or the room below.

- Specify the **Rough Ceiling** height, as measured from the subfloor surface to the bottom of the ceiling framing. Not available if multiple floor heights are specified directly above the selected room.
- Specify the **Finished Ceiling** height, as measured from the finished floor surface to the finished ceiling surface. Not available if multiple floor heights are specified directly above the selected room.
- Specify the distance from the **Stem Wall Top to Ceiling**. Only available when **Floor for this Room is Supplied by the Foundation ‘Room’ from the Floor Below** is checked, below.
- Specify the **Floor to Stem Wall Top** for rooms with **Floor for this Room is Supplied by the Foundation ‘Room’ from the Floor Below** specified.
- Specify the **Ceiling Below** height, which is the height of the ceiling of the room below, as measured from that room’s subfloor to rough ceiling surfaces. Not available when Auto Rebuild Foundation is enabled or if there is no room below the selected room. See [Rebuilding Foundations on page 488](#).
- Specify the **Stem Wall** height, which is measured from the top of the foundation wall footing to the top of the treated sill plate, if one is specified. Only available if the selected room or the room below it is defined by foundation walls.

3 Ceiling

Only the Ceiling Finish and Structure settings are available in the Room Type Defaults dialogs.

- If **Roof Over This Room** is checked, a roof automatically generates over the room. If unchecked, no roof generates.

If this option is unchecked and a roof plane is manually drawn over this room, its structure will be that of an eave rather than a regular roof. See [Roof Panel on page 624](#).

- If **Flat Ceiling Over This Room** is checked, the room has a flat ceiling. If unchecked, the ceiling follows the underside of the roof or manually drawn ceiling planes.
- Check **Shelf Ceiling** to prevent Attic Walls from generating over the interior walls that define the selected room. When unchecked, interior Attic Walls will generate if surrounding rooms have higher ceilings than the selected room. See [Shelf Ceilings on page 295](#).
- Check **Use Soffit Surface for Ceiling** to frame the roof over the selected room using the framing defaults for fascia rather than for rafters.
- The **Ceiling Structure** depth displays here for reference. Click the **Edit** button to open the Ceiling Structure Definition dialog and define the layers of materials that form the ceiling platform. Check **Default** to use the Ceiling Structure Definition set in the current floor's Floor Defaults dialog. Not available for rooms on Floor 0. See [Material Layers Definition Dialogs on page 709](#).
- The **Ceiling Finish** depth displays here for reference. Click the **Edit** button to open the Ceiling Finish dialog and define the layers of materials that form the finished ceiling surface. Check **Default** to use the Ceiling Finish set in the current floor's Floor Defaults dialog. See [Ceiling Finish Dialog on page 306](#).
- Check the **Default** box to the right of either button to restore the default structure and/or finish. See [Floor/Ceiling Platform Defaults on page 281](#).

4 Floor

Only the Floor Finish, Structure, and On Structure Resize settings are available in the Room Type Defaults dialogs.

- When **Floor Under This Room** is checked, the room has a floor platform as specified below.
- If **Floor Supplied by the Foundation Room Below** is checked, the floor platform for this room is a slab located on the floor below and cannot be edited here.
- If **Monolithic Slab Foundation** is checked, the current Floor Structure will be replaced by a single 4” (100 mm) layer of concrete with footings that can be seen in camera views only. When a stem wall or grade beam foundation is generated, a slab will be created beneath the selected room.



If the selected room has a living space located anywhere beneath it, avoid checking Monolithic Slab Foundation.

- Specify the thickness of the **Floor Finish** layer. Check **Default** to use the default Floor Finish thickness set in the current floor’s Floor Defaults dialog.
- Specify which part of the floor platform moves **On Structure Resize**. Select **Lock Floor Top** to keep the top of the floor structure at the same height and raise or lower its bottom when the platform depth is changed. Select **Lock Floor Bottom** to keep the bottom of the floor structure at the same height and raise or lower the top when the depth is changed.
- The **Floor Structure** depth displays here for reference. Click the **Edit** button to open the Floor Structure Definition dialog and define the layers of materials that form the floor platform. Check **Default** to use the Floor Structure Definition set in the current floor level’s Floor Defaults dialog. See *Material Layers Definition Dialogs on page 709*.
- If the selected room is a Deck, the Floor Structure button will be labeled **Planks, Joists** instead. See *Decks on page 292*.
- Check the **Default** box to the right of either button to restore the default structure and/or finish. See *Floor/Ceiling Platform Defaults on page 281*.

Note: The default floor and ceiling platform and finish definitions for rooms are set in the current floor’s Floor Defaults dialog. In the Floor Defaults dialog, the defaults are drawn from the Room Defaults dialog. See *Floor and Room Defaults on page 280*.

5 Preview

The preview on the right side of this dialog features a cross section diagram showing the relationships between the room's heights and platform thicknesses.

- If present, the floors above and below the selected room are also shown. The left side of the floor above is offset for clarity.
- The callout or dimension line associated with selected height or thickness value will be highlighted in the preview, as will any height or thickness value that you move your mouse point over.
- The font used by the callouts and dimensions is set in the Dimension Defaults dialog, while the unit of measurement is specified in the Dialog Number/Angle Style dialog. See [Dimension Defaults Dialog on page 313](#) and [Dialog Number/Angle Style Dialog on page 87](#).
- What appears in both the diagram and in the settings on the STRUCTURE panel may be affected by the location where you clicked to select the room. For example:
- If the selected room is located above two rooms with different structural settings, the position of the pointer relative to these two lower rooms determines which of them displays as the floor below.
- If the selected room is located below two rooms with different floor heights, its absolute and relative ceiling height settings will be disabled.

CEILING FINISH DIALOG

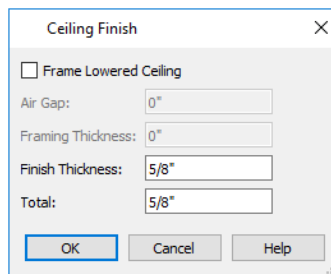

- Check **Frame Lowered Ceiling** to enable the two settings that follow.
- Specify the **Air Gap**, which is the vertical distance between the lowered ceiling framing and the framing of the platform above it.
- Specify the **Framing Thickness**, which is the vertical depth of the framing of the lowered ceiling.
- Specify the **Finish Thickness**, which is the vertical depth of the ceiling finish material.
- The **Total** thickness of the Ceiling Finish Definition displays for reference.

DECK PANEL

The options on the DECK panel are only available for rooms designated as Decks, and control how deck planking and joists are generated. See [Deck Framing and Planking on page 293](#).

The settings on this panel are also found in the Deck Room Defaults dialog, but affect the selected Deck room(s) only rather than Decks as they are initially created. See [Room Type Defaults on page 281](#).

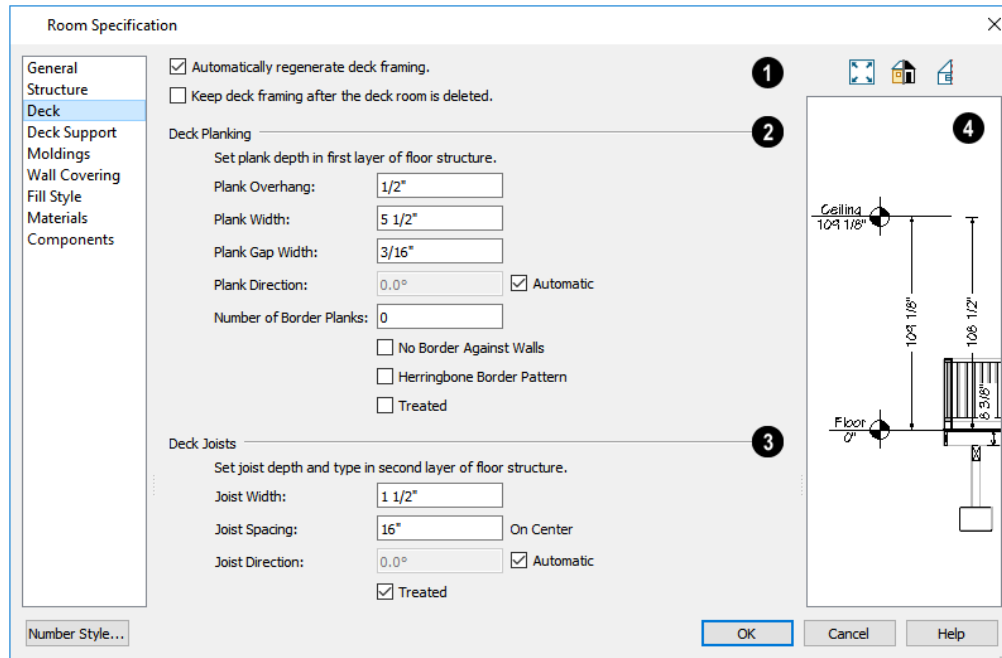

1 Automatic Deck Framing

- Check **Automatic Deck Framing** to generate planking and support framing for the deck that updates as changes are made to the deck. See [Decks on page 292](#).
- Check **Keep Deck Framing After Deck Room is Deleted** to retain the automatically generated framing and planking when the selected deck room is deleted. When this box is unchecked, the framing is automatically removed if the room is deleted.

2 Deck Planking

- Specify how far the deck planking **Overhangs** the rim joists.
- Specify the **Plank Width** of the deck planking.
- Specify the **Plank Gap Width**, which is the distance between individual planks.
- If you want to enter a **Plank Direction**, remove the check mark from **Automatic**. Enter the direction as degrees.
- Specify the **Number of Border Planks**. These are planks that follow the outside edge of the deck and may not be parallel with the rest of the planking. Border planks generate as long as the length of an inside edge is greater than 0". They do not generate on curved deck edges.

Note: Planking thickness and joist depth are specified in the Floor Structure Definition dialog. See [Floor and Ceiling Platform Definitions on page 296](#).

- Check **No Border Against Walls** to prevent border planking from being generated along any walls defining the deck.
- Check **Herringbone** to produce a herringbone pattern where the border planks meet.
- Check **Treated** to specify that the deck planking is counted as treated in the Materials List.

3 Deck Joists

- Enter the **Width** of the joists that support the deck.
- Specify the **Spacing** between joists, as measured from joist center to joist center.
- If you want to specify joist **Direction**, uncheck **Automatic** and enter the direction in degrees. When checked, joists are run in the direction that results in the shortest spans.
- Check **Treated** to specify that the deck joists are counted as treated in the Materials List.

4 Preview

The preview on the right side of this dialog features a cross section diagram showing the relationships between the room's heights and platform thicknesses.

- If present, the floors above and below the selected room are also shown. The left side of the floor above is offset for clarity.
- The height and thickness values shown in this diagram are set on the *Structure Panel on page 302*.

DECK SUPPORT PANEL

The options on the DECK SUPPORT panel are only available for Deck rooms and control how deck beams and posts are generated. See *Deck Framing and Planking on page 293*.

The settings on this panel are also found in the Deck Room Defaults dialog, but affect the selected Deck room(s) only rather than Decks as they are initially created. See *Room Type Defaults on page 281*.

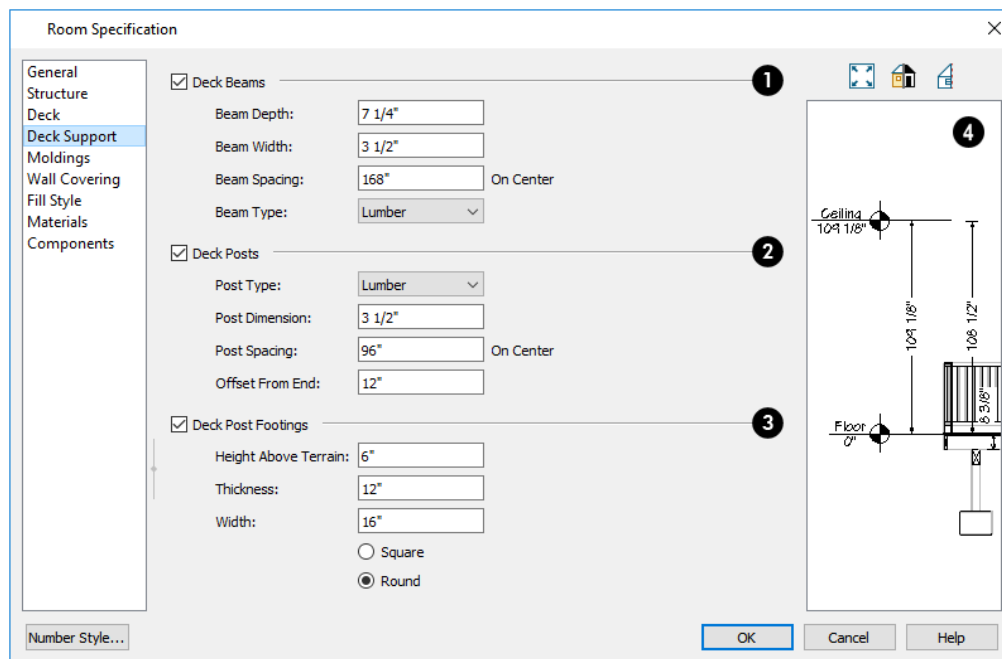

1 Deck Beams

Specify the configuration of the beams under the selected Deck room.

- Uncheck **Deck Beams** to prevent the automatic generation of support beams under the selected Deck room.
- Specify the vertical **Beam Depth**.
- Specify the horizontal **Beam Width**, or thickness.
- Specify the maximum on-center **Beam Spacing**. Beams may be positioned closer than this value, but not further apart.

2 Deck Posts

Specify the configuration of the posts under the selected Deck room.

- Uncheck **Deck Posts** to prevent the automatic generation of support posts under the selected Deck room.
- Select a **Post Type** from the drop-down list. See *Framing Materials and Types on page 633*.
- Specify the **Post Dimension**, which is both the width and depth of the posts.
- Specify the maximum **Post Spacing**. Posts may be positioned closer together than this value, but not further apart.
- Specify the **Offset from End**, which is the distance from the outermost beam to the edge of the deck platform. For railings directly over the outside of the beam, set this value to 0.

3 Deck Post Footings

These settings are not available if Deck Posts is unchecked, above.

- Uncheck **Deck Post Footings** to prevent the automatic generation of footings under the selected Deck room's posts.
- Specify the footings' **Height Above Terrain**. See *Foundations and the Terrain on page 491*.
- Specify the footings' **Thickness** and **Width**.
- Specify whether the footings are **Square** or **Round** in shape.

4 Preview

The preview on the right side of this dialog features a cross section diagram showing the relationships between the room's heights and platform thicknesses.

- If present, the floors above and below the selected room are also shown. The left side of the floor above is offset for clarity.
- The height and thickness values shown in this diagram are set on the *Structure Panel on page 302*.

MOLDINGS PANEL

Chair rail, crown and base moldings can be assigned to one or more selected rooms on the MOLDINGS panel. Moldings are placed on a room's wall surfaces and continue around the surface of any soffit that is attached to the wall at the molding height.

The settings on this panel are also similar to those found in the Floor Defaults dialog, but affect only the selected room instead of all rooms on the current floor.

The settings on this panel are similar to those found in other specification dialogs throughout the program. See *Moldings Panel on page 665*.

WALL COVERING PANEL

The settings on the WALL COVERING panel of the Room Specification dialog are the same as those on the same panel of the Wall Specification dialog. When a wall covering is assigned in the Room Specification dialog, it is applied to all walls in the selected room only. See *Wall Covering Panel on page 272*.

FILL STYLE PANEL

The settings on the FILL STYLE panel affect the appearance of the room in plan view. This panel is also found in the Floor Defaults dialog. For more information, see *Fill Style Specification Dialog on page 131*.

MATERIALS PANEL

The settings on this panel affect the appearance of a selected room's walls, floor, ceiling, and moldings in 3D views. See *Materials Panel on page 716*.

Default molding and ceiling and floor covering materials can be set on this panel in the Floor Defaults and Room Defaults dialogs.

COMPONENTS PANEL

The information on the COMPONENTS panel can be used in the materials list. For more information, see *Components Panel on page 921*.

Dimensions

Chapter 13

Home Designer provides a variety of dimensioning tools for measuring walls, doors, windows, and many other objects in various 2D and 3D views.

Dimensions can be used to accurately position objects relative to other objects. In addition, dimension lines and extensions can be selected and customized.

TOPICS

Compatibility With Previous Versions	312
Dimension Preferences and Defaults	312
Dimension Defaults Dialog	313
The Manually Drawn Dimension Tools	323
Automatic Dimensions	325
Displaying Dimension Lines	326
Selecting Dimension Lines	327
Editing Dimension Lines	328
Editing Extension Lines	329
Moving Objects Using Dimensions	332
Dimension Line Specification Dialog	334

Compatibility With Previous Versions

Dimensions function differently in Versions 6 and later of Home Designer than they did in their predecessor, Chief Architect Home Edition 5. Being familiar with these changes is helpful if you have plans that were originally created in these legacy program versions.

EXTENSION LINES

In Home Edition 5, extension lines had two modes: normal and short. Version 6 and later offer full control over extension lines. If **Legacy Compatible Extensions** is checked, you do not have this control. See [Extensions Panel on page 321](#).

ACCURACY

When the model is drawn with greater accuracy than dimensions are set to display, rounding may be required. The **Rounding Method** in the Dimension Defaults dialog controls how Home Designer Pro handles dimensions that require rounding. See [General Panel on page 313](#).

In Chief Architect Home Edition 5 and prior, dimensions used Distance Rounding, which shows the distance between equally spaced objects correctly, but dimension runs are not always accurate when added.

In Versions 6 and later, dimensions use Grid Rounding, which always add up dimension runs correctly, but individual distances may be inaccurate in order to achieve this.

Dimensioning the same object using these two rounding methods will obtain the same results as long as objects are placed with the same accuracy as the precision of the dimension lines. If an object is placed using more precision than the dimensions, results may vary between methods.

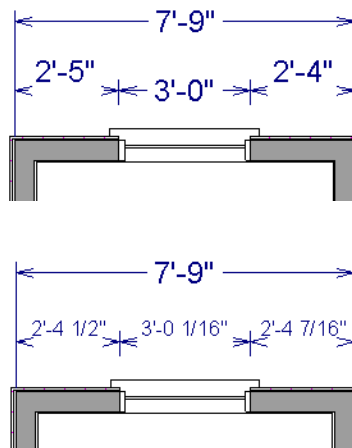

A good approach to accurate dimensioning is to turn on the accuracy indicators and position objects so that the inaccuracy indicators do not display.

Dimension Preferences and Defaults

There are a number of defaults settings as well as options in the Preferences dialog that affect dimensions.

PREFERENCES



All plan and layout files save measurements in either Imperial or metric units. The type of unit used is determined when the file is first created and cannot be changed later. See [Creating a New Plan or Layout on page 34](#).

You can specify either metric or Imperial files to be used as the templates whenever you open a new, blank plan or layout file in the Preferences dialog. See [New Plans Panel on page 71](#).

You can also specify the minimum on-screen display size for dimension numbers in the Preferences dialog. See [Appearance Panel on page 60](#).

DEFAULT SETTINGS



Select **Edit> Default Settings** to open the Default Settings dialog, then select "Dimension" and click the Edit button.

The Dimension Defaults dialog can also be accessed by double-clicking the **Dimension Tools**  parent button. See [Dimension Defaults Dialog on page 313](#).

When **Angle Snaps**  are enabled, dimensions can be drawn at the **Allowed Angles** set in the General Plan Defaults dialog. Regardless of their angles, however, dimensions will only locate objects that are parallel to one another. See [General Plan Defaults Dialog on page 56](#).

When a Marker is created in association with a manually drawn dimension, the Marker will inherit its initial settings from the Marker Defaults dialog. See [Markers on page 357](#).

Dimension Defaults Dialog



Select **Edit> Default Settings**, expand the "Dimension" category, select "Dimensions", and click the **Edit** button to open the Dimension Defaults dialog.

You can also double-click the **Dimension Tools**  parent button to open this dialog.

The settings in this dialog are dynamic defaults, which means that any changes made here may affect existing dimension lines in the drawing that are using default values. See [Dynamic Defaults on page 55](#).

GENERAL PANEL

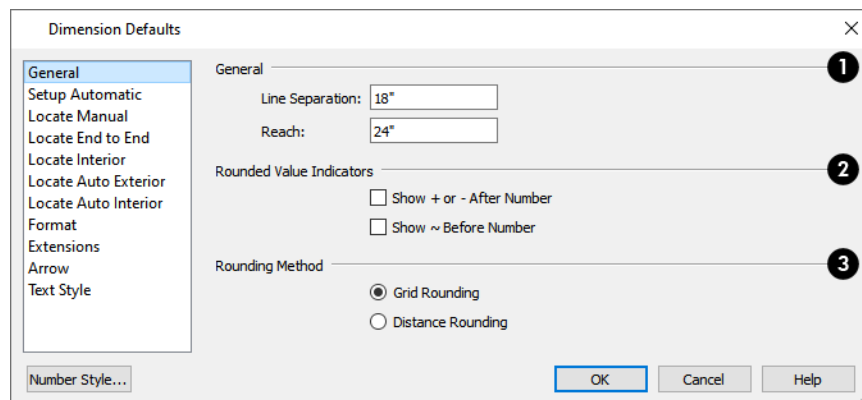

1 General

- Specify the **Line Separation**, which is the distance between Baseline Dimension lines in plan inches (mm). This value should always be greater than the Character Height. See [Text Style Panel on page 323](#).
- Specify how far manually drawn dimension lines **Reach** to locate walls and/or objects specified on the LOCATE panels. The default is 24" (450 mm) in plan files and 1" (10 mm) in layout. See [Locate Manual Panel on page 315](#).

2 Rounded Value Indicators

Specify the use and appearance of **Rounded Value Indicators**, which can display when the degree of accuracy in use is not sufficient to describe a dimension's true value.

- Check **+ or - After Number** to indicate that the actual dimension value is higher or lower than the value shown.
- Check **~ Before Number** to indicate dimension values that are not accurate with the ~ symbol.

3 Rounding Method

Specify the **Rounding Method** used for dimension values.

- **Grid Rounding** ensures that the sum of the parts of a dimension line add up to the whole distance. To produce this result, some sections may not be rounded accurately. This is the recommended rounding method and is selected by default.
- **Distance Rounding** addresses each section of a dimension line individually, which could result in the sum of these sections not being equal to the whole. This option is available for legacy purposes only and is not recommended. See [Compatibility With Previous Versions on page 312](#).

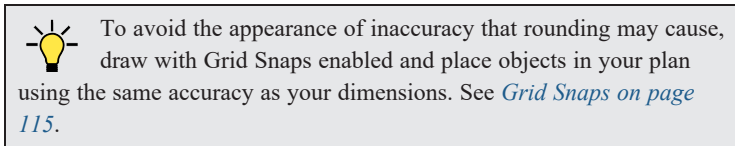

SETUP AUTOMATIC PANEL

The settings on the SETUP AUTOMATIC panel affect how Auto Exterior and Auto Interior Dimensions are created.

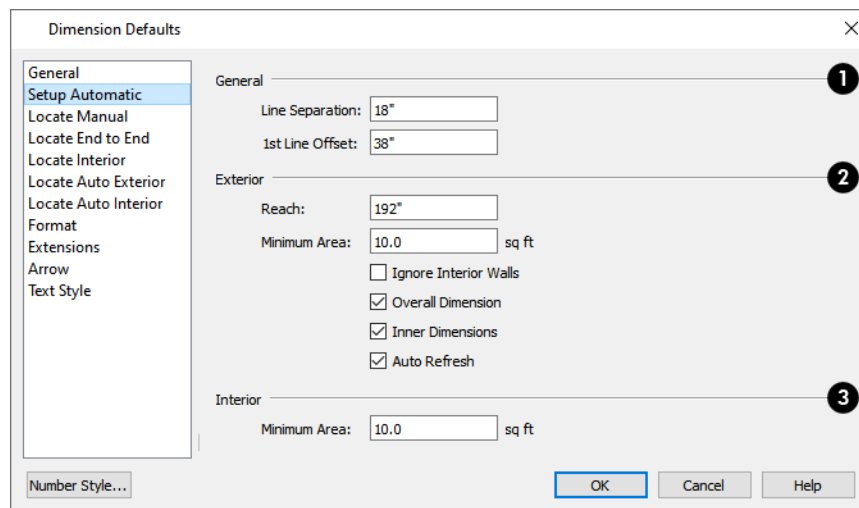

1 General

- Specify the **Line Separation**, which is the distance between Auto Exterior Dimension lines in plan inches (mm). This value should always be greater than the Character Height used by the label. If two formats are used, it should be at least twice the Character Height. See *Dimension Labels on page 327*.
- Specify the **1st Line Offset**, which is the distance between each wall and the nearest Automatic Dimension line that measures its length in plan inches (mm).

2 Exterior

These settings control how Auto Exterior Dimensions generate.

- Specify how far Auto Exterior Dimensions **Reach** to locate objects set back from exterior walls. If exterior walls are set back further than this distance, additional dimension lines are produced to locate the set-back walls.
- Specify the **Minimum Area**, which is the minimum area defined as a room needed for Auto Exterior Dimensions to generate.
- Check **Ignore Interior Walls** to prevent interior walls that intersect exterior walls from being located by Auto Exterior Dimensions.
- When **Overall Dimension** is checked, a dimension line reporting the overall length of each side of the structure is created.
- When **Inner Dimension** is checked, up to three rows of Auto Exterior Dimensions per exterior wall are generated. Uncheck this box to suppress these inner dimension strings.
- Check **Auto Refresh** to delete and replace Auto Exterior Dimensions whenever a change is made to the model that affects them.

3 Interior

These settings control how Auto Interior Dimensions generate.

- Specify the **Minimum Area**, which is the minimum area defined as a room needed for Auto Interior Dimensions to generate.
- When **Overall Dimension** is checked and a room's **Auto Interior Dimensions**  locate objects in addition to its walls, an overall dimension for each wall is also generated.

LOCATE MANUAL PANEL

The settings on the MANUAL panel specify how and whether or not **Manual Dimensions**  locate specific types of objects.

Changes made on this panel only affect new dimension lines as they are drawn, not those already drawn. Once created, a dimension line's extensions can be edited so that they locate objects in ways not specified here. See *Editing Extension Lines on page 329*.

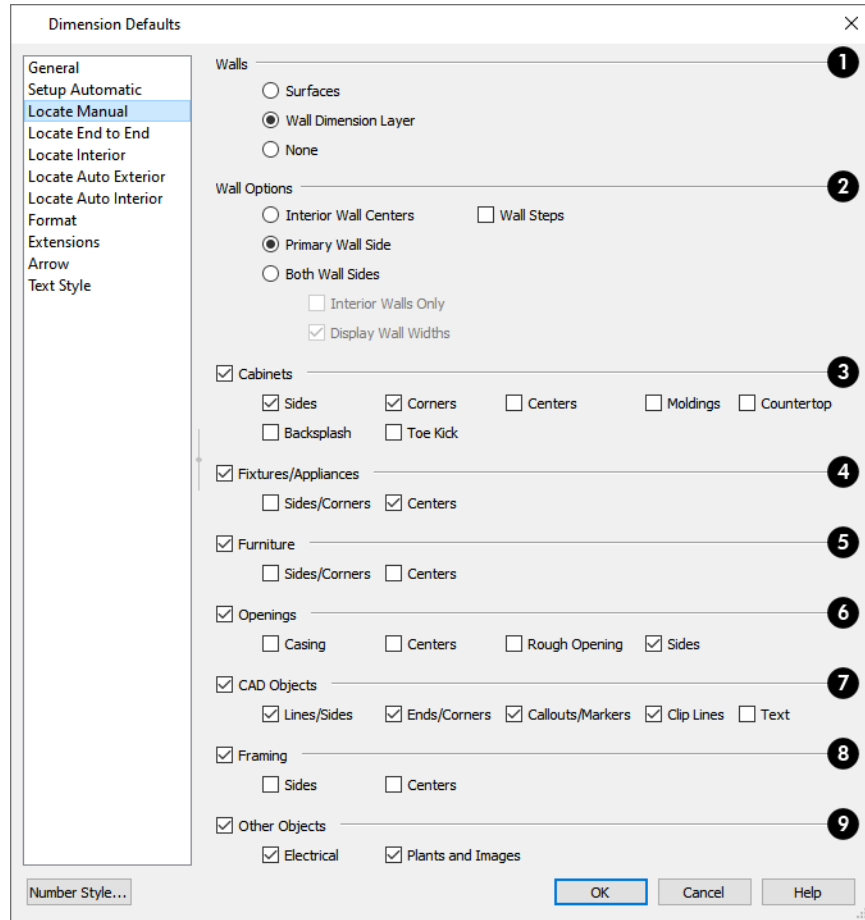

In the Dimension Defaults dialog for a layout file, only the **CAD Objects** settings on this panel is available.

1 Walls

Specify the marked location in wall assemblies referred to by Extension Lines as well as the Reach and 1st Line Offset settings. See [The Dimension Layer on page 258](#).

- Select **Surfaces** to locate exterior walls by outer surface and interior walls by one of their surfaces.
- Select **Wall Dimension Layer** to locate walls at the Dimension Layer. A wall’s Dimension Layer is specified in its wall type. See [Wall Type Definitions Dialog on page 259](#).
- Select **None** to prevent Manual End to End Dimensions from locating walls.

2 Wall Options

These settings only apply to interior walls drawn perpendicular to the exterior walls they intersect. Not available for Interior Dimensions.

- Select **Interior Wall Centers** to have dimension lines locate the centers of interior walls. If Wall Dimension Layer is selected above, dimensions locate interior walls at the center of their Main Layers. See *The Main Layer on page 257*.
- Select **Primary Wall Side** to have dimension lines locate one side of interior walls.
- Select **Both Wall Sides** to have dimension lines locate both surfaces of interior and exterior walls. When this option is selected, two additional settings are available:
 - Check **Interior Walls Only** for dimensions to ignore the interior surface of exterior walls and the thicknesses of interior walls.
 - When **Display Wall Widths** is checked, the thicknesses of any walls that a dimension line crosses will be measured. Uncheck this box to suppress the segments dimension line segments that report these measurements.
- Check **Wall Steps** to have dimensions locate steps in walls in elevation views. Steps in foundation walls in plan views are also located. See *Stepped Walls and Footings on page 255*.

Note: Walls specified as No Locate will not be located by some dimension tools. See *No Locate on page 244*.

The remaining Locate Object options are organized into categories.

- Check the box beside an option to have dimension lines locate that location on the object type in question as they are drawn or generated.
- Check the box beside a category heading to check all of the boxes in that category. Uncheck the box to clear all of those options.

3 Cabinets

See *Using Dimensions on page 445*.

- Locate the **Sides** of cabinet objects. The sides do not need to be perpendicular to the dimension line.
- Locate the **Corners** of cabinet objects. Angled cabinets are dimensioned to their corners at a right angle to the dimension line. A cabinet's front or sides do not need to be perpendicular or parallel to the dimension line for its corners to be located.
- Locate the **Centers** of cabinet objects. A cabinet's front or sides do not need to be perpendicular or parallel to the dimension line for its center to be located.
- Locate tops and bottoms of **Moldings** in elevation views.
- Locate cabinet **Countertop** edges. In plan view, a cabinet's front or sides must be perpendicular or parallel to the dimension line for its countertop to be located. In elevation views, only the top and bottom edges can be located when the dimension is being drawn.
- Locate top and bottom **Backsplash** edges in elevation views.
- Locate top and bottom **Toe Kick** edges in elevation views.

4 Fixtures/Appliances

These options affect how dimension lines locate appliances and other fixtures including hardware, millwork, sprinklers, and Geometric Shapes.

- Locate the **Sides/Corners** of appliances and other fixtures. For sides to be located, they must be perpendicular to the dimension line.
- Locate the **Centers** of all fixtures within the Reach area. An object's front or sides do not need to be perpendicular or parallel to the dimension line for its center to be located.

5 Furniture

These options affect how dimension lines locate furniture and furnishing accessories.

- Locate the **Sides/Corners** of furnishings. For sides to be located, they must be perpendicular to the dimension line.
- Locate the **Centers** of all furnishings. An object's front or sides do not need to be perpendicular or parallel to the dimension line for its center to be located.

Note: In cross section/elevation views, dimensions can only locate furniture at points where a surface is present.

6 Openings

Specify how dimensions locate doors and windows.

- Locate the outer edges of both sides of wall openings' **Casing**. Because interior and exterior casing often have different widths, an opening may have different interior and exterior dimensions when this option is selected.
- Locate the **Centers** of wall openings.
- Locate both sides of the **Rough Opening** of doors and windows.
- Locate the both **Sides** of wall openings. This option locates the nominal width - not the rough opening.

Note: Openings in walls specified as No Locate will not be located by Auto Exterior Dimensions. See [No Locate on page 244](#).

7 CAD Objects

These options control how dimension lines locate 2D CAD objects as well as CAD-based objects such as slabs and stairs.

- Locate **Line/Sides** that are perpendicular to the dimension line. If the lines or edges are not perpendicular to the dimension line, they are not dimensioned.
- Locate all **Ends/Corners** of polylines, no matter what angle they are in relation to the dimension line.
- Check **Callouts/Markers** to locate these objects.
- Check **Clip Lines** to locate the clip lines associated with some cross section/elevation views. See [Cross Section/Elevation Views on page 744](#).
- Check **Text** to locate text objects.

8 Framing



See [Using Dimensions on page 635](#).

- Locate both **Sides** of framing objects.
- Locate the **Centers** of framing objects.

9 Other Objects

- Locate **Electrical** objects. Use this option when you want to precisely position electrical objects. See [Using Dimensions on page 476](#).
- Locate **Plants and Images**.

LOCATE END TO END PANEL

The settings on the LOCATE END TO END panel are the same as those on the LOCATE MANUAL panel, but control how objects are located when an **End to End Dimension**  or **Point to Point Dimension**  is drawn. See [End-to-End Dimensions on page 324](#) and [Locate Manual Panel on page 315](#).

LOCATE INTERIOR PANEL

The settings on the LOCATE INTERIOR panel are also found on the LOCATE MANUAL panel, but control how objects are located when an **Interior Dimension**  is drawn. See [Interior Dimensions on page 325](#) and [Locate Manual Panel on page](#)

315.

LOCATE AUTO EXTERIOR PANEL

The settings on the LOCATE AUTO EXTERIOR panel are also found on the LOCATE MANUAL panel, but control how objects are located when **Auto Exterior Dimensions**  are generated. See *Auto Exterior Dimensions on page 326* and *Locate Manual Panel on page 315*.

LOCATE AUTO INTERIOR PANEL

The settings on the LOCATE AUTO INTERIOR panel are also found on the LOCATE MANUAL panel, but control how objects are located when **Auto Interior Dimensions**  are generated. See *Auto Interior Dimensions on page 326* and *Locate Manual Panel on page 315*.

FORMAT PANEL

The settings on the FORMAT panel allow you to specify the units, position, and degree of accuracy of dimension numbers. The settings on this panel also control the format of object length numbers in the Status Bar. See *The Status Bar on page 23*.

These settings are the same as those on the FORMAT panel of the Dimension Line Specification dialog and the DIMENSION FORMAT panel of the Room Label Defaults dialog. See *Dimension Line Specification Dialog on page 334* and *Room Label Defaults on page 282*.

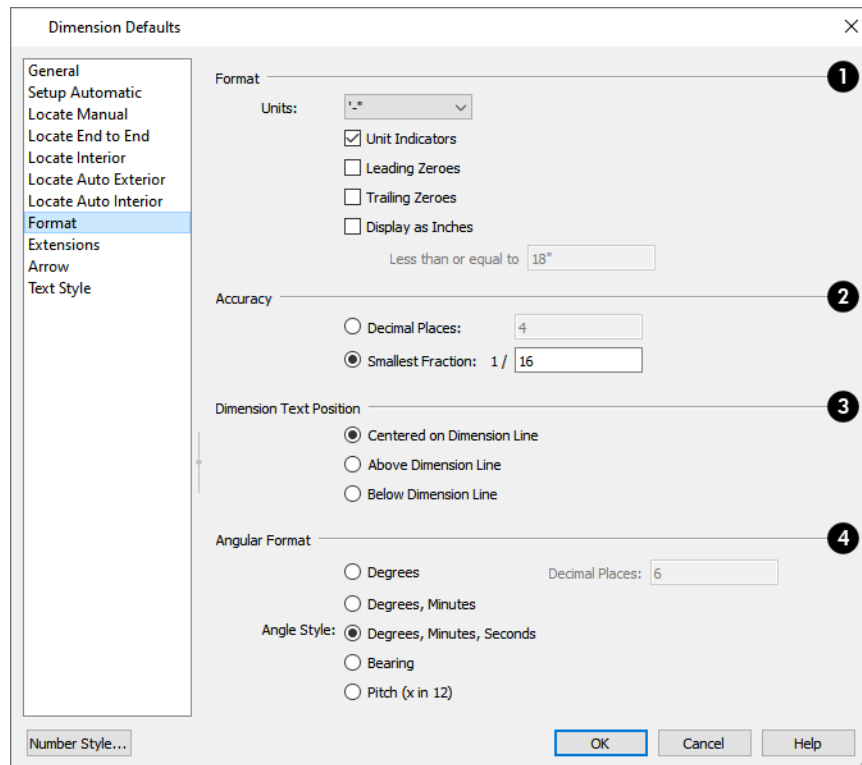

1 Format

Specify the numbering **Format** for dimension numbers.

- Select the **Units** of measurement to be used by dimensions from the drop-down list. The choices in this list correspond to all units measuring length specified in the Preferences dialog. See *Unit Conversions Panel on page 71*.

Note: Although you can select Imperial or metric units in any plan or layout, it is best to use the same unit type that the file uses to save measurements. See *Units of Measurement on page 34*.

- Check **Unit Indicators** to display the unit of measurement along with the dimension number.
- Check **Leading Zeros** to include the zero before a decimal less than 1 or to display 0' or 0" when the ft-in or '-"' unit format is used.
- Check **Trailing Zeros** to display trailing zeros at the end of decimal values. When the ft-in or '-"' unit format is used and fractional inches are specified, 0" will be included.
- Check **Display as Inches** to display the dimension number of sufficiently short segments in inches rather than the Unit selected above. This option is only available when the specified Unit is a form of either feet or yards, or a format that includes feet.
- The **Less than or equal** to value specifies how short a segment must be before its number uses inches rather than the specified Unit.

2 Accuracy

Specify the degree of **Accuracy** used by dimension numbers.

- Select the **Decimal Places** radio button for dimension numbers in decimal format. In the text field, specify the number of decimal places to use, from 0 to 20. If 0 is used, no decimal places are used.
- Select the **Smallest Fraction** radio button for dimension numbers using whole numbers and fractions. In the text field, specify the largest denominator to use, from 1 to 16. If 1 is entered, whole numbers are used.

3 Dimension Text Position

Specify the location of dimension numbers relative to the dimension line.

- **Centered on Dimension Line** centers the primary dimension numbers on the dimension line. If two formats are used, the primary format is placed above the line and the secondary format, beneath it.
- Position dimension numbers **Above Dimension Line**.
- Position dimension numbers **Below Dimension Line**.

4 Angular Format

Specify the **Angular Format** used by Angular Dimensions. See *Angular Dimensions on page 324*.

- Select an **Angle Style**. For a description of each, see *Dialog Number/Angle Style Dialog on page 87*.
- When **Degrees** is selected, you can specify the number of **Decimal Places** to report.

EXTENSIONS PANEL

The settings on the EXTENSIONS panel control the length of extension lines.

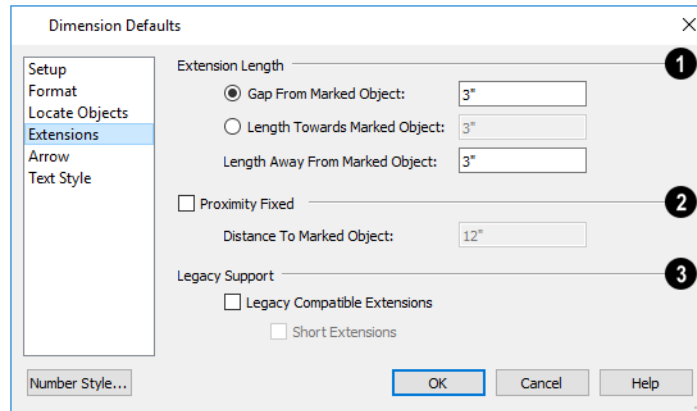

1 Extension Length

Specify the **Extension Length** relative to the marked location on an object.

- Select **Gap From Marked Object** to specify the distance between the end of extension lines and their marked location in plan inches or mm. If a dimension line is moved, extension lines update, and the size of this gap is maintained.
- Select **Length Towards Marked Object** to specify a fixed length for the portion of an extension line that extends from the dimension line toward the object it locates. If the dimension line is moved, this length remains the same but the size of the gap updates.
- Specify the **Length Away From Marked Object**, which is the length of the portion of an extension line that extends from the dimension line in the opposite direction of the object it locates.

2 Proximity Fixed

Check **Proximity Fixed** to specify a fixed distance between the marked object and the dimension line. You can only fix the proximity for a single extension line. See [Using Proximity Fixed on page 332](#).

- **Distance to Marked Object** - When Proximity Fixed is checked, you can specify the distance from the dimension line to the marked object using a positive value.

Gap From Marked Object + Length Toward Marked Object = Distance to Marked Object

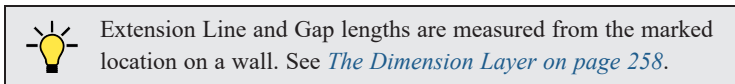

Proximity Fixed only affects dimension lines that locate an object using an extension line. When a dimension line arrowhead points directly to the object without using an extension line, this option has no effect.

Auto Exterior Dimensions ignore Distance to Marked Object and use the default 1st Line Offset and Line Separation values. See [Setup Automatic Panel on page 314](#).

3 Legacy Support

The **Legacy Support** settings are only recommended for files originally created in Chief Architect Home Edition 5 and prior. See [Compatibility With Previous Versions on page 312](#).

- Check **Legacy Compatible Extensions** to assign a program-defined length to extension lines that cannot be edited.
- Check **Short Extensions** to have short, uniform-length extension lines that do not reach all the way to the objects they locate.

Note: If you select an extension line, Legacy Compatible Extensions will be turned off automatically.

ARROW PANEL

The settings on the ARROW panel control the size and style of dimension line arrows. See [Arrow Panel on page 205](#).

TEXT STYLE PANEL

The settings on the TEXT STYLE panel control the size, font and other attributes of automatic, manually drawn, and temporary dimension line labels. Individual dimension lines inherit their text style from a Saved Dimension Default: they cannot have a non-default text style assigned to them. See [Dimension Labels on page 327](#).

For information about the settings on this panel, see [Text Style Panel on page 361](#).

Temporary dimensions and their labels always use the **Selection Line** color set in the Preferences dialog. See [Colors Panel on page 62](#).

The Manually Drawn Dimension Tools





Select **CAD> Dimensions** to access the manually-drawn Dimension Tools.

Manually drawn dimensions are created by clicking and dragging like other line-based objects and can be drawn in plan view, cross section/elevation views, and on layout pages.



 The Automatic Dimension tools can also be used to create interior and exterior dimensions. See [Automatic Dimensions on page 325](#).

There are six manually drawn Dimension Tools:

With the exception of **Angular Dimensions** , dimension lines only locate objects that are parallel or nearly parallel to one another and should be drawn orthogonal, or at right angles, to the objects being located.

Dimension lines locate objects using **Object Snaps** , although they do not need to be enabled in order to draw dimensions. See [Object Snaps on page 113](#). Bear in mind, though, that Object Snaps must be enabled in order to:

- Locate parallel objects drawn at angles other than Allowed Angles.
- Locate more than one object drawn in the same space, such as a CAD line drawn over a wall.

The zoom factor of the current view affects whether objects drawn close together are dimensioned or not. If you try to dimension an array of objects but the dimension line locates only the first and last objects along its path, **Zoom**  in on the objects and try again. Similarly, if you want to dimension between two objects but the dimension locates unwanted objects between them, **Zoom**  out. See [Zoom Tools on page 106](#).

Once created, both manually drawn and automatically generated dimension lines can be selected and edited. See [Editing Dimension Lines on page 328](#).

If the object or objects located by a dimension are resized or moved, the dimension will update to reflect the change. Objects located by a dimension can also be accurately relocated or resized by specifying a new dimension value. See [Moving Objects Using Dimensions on page 332](#).

MANUAL DIMENSIONS



The **Manual Dimension** tool creates dimension lines that locate all eligible objects positioned between their start and end points and within the default Reach distance.

Manual Dimensions locate walls and a variety of other object types as specified in the Dimension Defaults dialog. See [Locate Manual Panel on page 315](#).

END-TO-END DIMENSIONS



The **End-to-End Dimension** tool creates dimension lines that locate an eligible object at its start and end points but ignores any objects in between.

End to End Dimensions locate walls and a variety of other object types as specified in the Dimension Defaults dialog. See [Locate End to End Panel on page 319](#).

ANGULAR DIMENSIONS



The **Angular Dimension** tool measures the angle between any two straight edges, including walls, cabinets, and the straight sides of polyline-based objects. To create an angular dimension, click on the first edge to be dimensioned, then drag an arc and release on the second edge.

By default, Angular Dimensions use the **Angle Style** specified in the Dimension Defaults dialog. See [Format Panel on page 320](#).

INTERIOR DIMENSIONS



 The **Interior Dimension** tool creates dimension lines that measure the interiors of rooms. Interior Dimensions do not locate the exterior sides of exterior walls by default, although they can be edited to do so, and they have **Display Wall Widths** unchecked by default in their specification dialog so they do not report the thicknesses of walls or wall layers. See [Dimension Panel on page 335](#).

Interior Dimensions locate either wall surfaces or the Main Layer, as well as a variety of other objects, depending on the settings in the Dimension Defaults dialog. See [Locate Interior Panel on page 319](#).

POINT TO POINT DIMENSIONS

 The **Point to Point Dimension** tool creates dimension lines that locate an eligible object at their start and end points if possible. If no object is present at either location, a Point Marker is created and the dimension line locates it instead. See [Markers on page 357](#).



Point to Point Dimensions can be drawn in either of two ways:

- When the **Default**  edit behavior is active, a Point to Point Dimension places Point Markers at its start and end points, which it locates. Any objects along the dimension line's length are ignored. See [Point Markers on page 197](#).
- When the **Alternate**  edit behavior is active, a Point to Point Dimension locates objects along its length as well as objects or Point Markers at its start and end. See [Defaults, Preferences, and Edit Behaviors on page 137](#).

The Point Markers created by the **Point to Point Dimension** tool can be selected and edited. See [Editing Markers on page 359](#).

Point to Point Dimensions locate walls and a variety of other objects depending on the settings in the Dimension Defaults dialog. See [Locate End to End Panel on page 319](#).

TAPE MEASURE

 Use the **Tape Measure** tool to draw a temporary dimension line between any two points in the drawing area. The tool will place temporary markers at the start and end points of the dimension line. The Tape Measure line and its start and end points all disappear when you release the mouse button. If **Object Snaps**  are enabled and an object is located by the temporary line, you can snap to it.

Automatic Dimensions

These tools automatically create dimension lines in plan view for different purposes:

 The manually drawn Dimension tools can also be used to draw dimensions in plan and cross section/elevation views. See [The Manually Drawn Dimension Tools on page 323](#).

TEMPORARY DIMENSIONS

 **Temporary Dimensions** display automatically when an object is selected and report the distance between that object's selected edge and other objects. Select **View > Temporary Dimensions** to turn on or off the display of Temporary Dimensions. This toggle affects all views and is saved between launches of Home Designer.

A Temporary Dimension will only display when an object is selected, and as with other dimension lines, it will only locate objects that are parallel or nearly parallel to one another. Temporary Dimensions will also locate the endpoints of CAD lines and the corners of objects located past the end of the selected edge, within 4 feet (1200 mm) of the point where you click to select the object.

AUTO EXTERIOR DIMENSIONS

 The **Auto Exterior Dimensions** tool generates dimensions around a plan's exterior in plan view, locating walls and openings as specified in the Dimension Defaults dialog.

Up to three rows of automatically generated dimensions may be created per exterior wall:

- The innermost dimension line locates exterior walls, interior walls, and all openings in exterior walls.
- The second dimension line locates exterior and interior walls.
- The outermost dimension line is the overall exterior dimension.

 Auto Exterior Dimensions do not generate properly if there is a gap in the exterior walls or if they do not connect properly. If automatic dimensions do not generate, try Build> Wall> Fix Wall Connections.

If you edit an **Auto Exterior Dimension**  line, it will be converted to a manual dimension, so if Auto Exterior Dimensions are later regenerated, your changes will not be lost.

AUTO INTERIOR DIMENSIONS

 Select one or more rooms and click the **Auto Interior Dimensions** edit button to generate interior dimensions that measure each wall defining the selected room(s).

Auto Interior Dimensions lines are generated inside of the rooms they measure and locate walls and wall openings, as well as other objects, as specified in the Dimension Defaults dialog. See [Locate Auto Interior Panel on page 320](#).

Auto Interior Dimensions do not recognize the **No Locate** setting for walls. If a wall is specified as No Locate, Auto Interior Dimensions will locate it anyway. See [No Locate on page 244](#).

Displaying Dimension Lines

 The display of dimension lines is controlled in the Layer Display Options dialog. See [Displaying Objects on page 122](#).

Dimension lines created by any of the dimension tools share the same components:

- **Dimension Lines** run parallel with the distance being measured.
- **Extension Lines** are perpendicular to dimension lines, indicating what they locate. If a dimension line locates more than two objects, extension lines divide the dimension line into segments.
- **Arrowheads** display at the intersections of dimension and extension lines.
- **Dimension Labels** display at the midpoint of dimension line segments and indicate the distance that each segment measures.

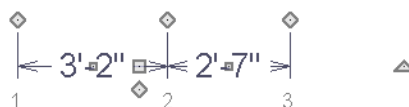

EXTENSION LINES

If a dimension line is offset from the objects it locates, extension lines help clarify exactly what is being located. Extension lines are numbered: when a dimension line is selected, an Extension Line Number displays at the end of each extension line.

You can specify the default length of extension lines in the Dimension Defaults dialog. See [Extensions Panel on page 321](#).

Once drawn, the appearance of extension lines can be edited. See [Editing Extension Lines on page 329](#).

DIMENSION LABELS

Manually drawn, automatic, and temporary dimension labels use the Text Style specified in the Dimension Defaults dialog. Unlike many objects that use Text Styles, by default dimensions use a Text Style specified in the defaults dialog rather than the Text Style assigned to their layer. See [Text Style Panel on page 361](#).

 Like other text, dimension labels are subject to scaling. For example, A Character Height of 6" prints a 1/8" tall number at 1/4" = 1' scale. A Character Height of 125 mm prints a 3 mm tall number at 1 m = 50 m scale. See [Printing Text, Dimensions, and Line Styles on page 949](#).

By default, dimension labels have a solid fill that is the same as the **Background Color** set in the Preferences dialog. You can instead specify that labels use a Text Style with a transparent fill.

You can also specify the minimum size of dimension numbers displaying on screen in the Preferences dialog. See [Appearance Panel on page 60](#).

Labels can be centered on dimension lines or located either above or below them. See [Format Panel on page 320](#).

Dimension labels have their own edit handle and can be moved when a dimension line is selected. See [Editing Dimension Lines on page 328](#).



DIMENSION ARROWHEADS

You can specify the style, color and size of dimension arrows in the Dimension Defaults and Dimension Line Specification dialogs. See [Arrow Panel on page 205](#).

The arrow at the end of a dimension line will not display if it is close enough to another dimension arrow that the two will overlap. A typical example of this is where two sections of an Interior Dimension locate two sides of an interior wall.

Selecting Dimension Lines

Before a manually-drawn or automatic dimension line can be edited, it must be selected. A dimension line can be selected in one of three ways, each of which affects the ways that the dimension line can then be edited.

The standard way to select an individual dimension line is to click anywhere along its length when the **Select Objects**  or any of the **Manual Dimension**  tools is active. When selected in this manner, the dimension line's full range of editing options are available.

You can instead click on one of the dimension line's extension lines. When selected in this way, the selected extension line's length can be edited; however, fewer edit handles are available overall. See [Editing Extension Lines on page 329](#).



If you select an extension line by mistake, press the Esc key to display the full set of dimension line edit handles.

Dimension lines can also be group-selected, with limited editing options. See [Selecting Multiple Objects on page 143](#).

Editing Dimension Lines

Before a dimension line can be edited, it must be selected. See [Selecting Dimension Lines on page 327](#).

With the exception of **Temporary Dimensions** , dimension lines can be selected and edited using the mouse, the Edit Toolbar buttons, and the Dimension Line Specification dialog. See [Dimension Line Specification Dialog on page 334](#).

If an Auto Dimension line is edited, it will no longer be considered an automatic dimension line and will not be deleted and replaced the next time the tool used to create it is used.

For information about changing the value reported in a dimension line label, see [Moving Objects Using Dimensions on page 332](#).

USING THE EDIT HANDLES

When a dimension line is selected, its edit handles can be seen. There are five types of dimension line edit handles. The total number of edit handles a dimension line has depends on how many extension lines it has.

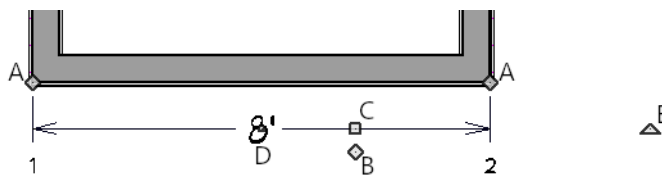

- The **Extension Line End** handles are positioned at the point that each extension line locates and are used to move or delete extension lines. See [Moving an Extension Line on page 330](#).
- The **Add Extension Line** handle displays to the side of the Move handle and is used to add extension lines to the dimension line. Extension lines added in this manner are able to locate marks that the dimension line might not locate as it was being drawn. See [Adding an Extension Line on page 330](#).
- The **Move** handle is located where you clicked to select the dimension line and is used to move the entire dimension line, including any subsections, perpendicular to itself. Extension lines are resized as appropriate. The pointer changes to a two-headed arrow \leftrightarrow when moved over this handle.
- The small, square **Move Dimension Label** handle is located at the center of the selected label. Use this handle to move the dimension number for each dimension line section. The pointer changes to a four-headed arrow $\updownarrow\leftarrow\rightarrow$ when moved over this handle. When Object Snaps are enabled, dimension label centers will snap to their associated dimension line.
- The **Rotate** handle is located past the end of the dimension line and can be used to rotate the dimension line.

A selected Angular Dimension has only one edit handle. When you click and drag this handle, the selected Angular Dimension will move. Its length will increase or decrease concentrically depending on which direction it is moved, and the location of its arc center will be maintained.

As a selected dimension line is resized, its drawing behavior and the objects it locates may vary, depending on the Dimension Tool that was used to create it. When selected, Interior Dimensions are described as such in the Status Bar. See [The Status Bar on page 23](#).

USING THE EDIT TOOLS

Dimension lines can be repositioned, copied, and deleted using the Edit Toolbar buttons just like other objects in the program can. See [The Edit Toolbar on page 91](#).

Click the **Edit Extensions**  edit button to edit the lengths of the selected dimension's extension lines. See [Editing Extension Lines on page 329](#).

DIMENSION NUMBER SIZE

The initial size of dimension numbers is specified in the Dimension Defaults dialog. See [Dimension Defaults Dialog on page 313](#).

You can specify number height for individual dimension lines in the Dimension Line Specification dialog. See [Dimension Panel on page 335](#).

As with text and other objects, dimension number size is subject to scaling when sent to layout or printed. See [Printing Text, Dimensions, and Line Styles on page 949](#).

COPYING AND PASTING DIMENSION LINES

Dimension lines can be copied and pasted into any view type that supports dimensions. If a dimension line is copied independent of the objects it originally locates, the pasted dimension line will locate Point Markers. See [Point Markers and Dimensions on page 358](#).

DELETING DIMENSION LINES

There are several ways to delete dimension lines.

You can select any manual or automatic dimension line or group of dimension lines, then press the Delete key or click the **Delete**  edit button. See [Deleting Objects on page 187](#).

The Delete Objects dialog allows you to delete all manually drawn and/or automatic dimension lines at once. See [Delete Objects Dialog on page 188](#).

Individual dimension line segments located between extension lines can also be deleted. If a segment is located between two other segments along the same dimension line, that dimension will be broken in two.

To delete a portion of a dimension line

1. Select any **Dimension Tool** aside from Angular or Auto Exterior Dimensions.
2. Manually draw a dimension line over the segment that you wish to remove, dragging from extension line to extension line.

Editing Extension Lines

Before extension lines can be edited, either they or their dimension line must be selected. See [Selecting Dimension Lines on page 327](#).

Extension lines can be added, edited, and deleted using the edit handles when their dimension line is selected. In addition, extension lines can be individually selected and edited.

Extension lines are also affected by settings in the Dimension Line Specification dialog. See *Extensions Panel on page 336*.

ADDING AN EXTENSION LINE

The Add Extension Line edit handle allows you to locate marks that the dimension line might not have been able to locate as it was being drawn. Interior Dimensions, for example, do not locate cabinets as they are drawn; however, you can add an extension line that locates a cabinet.

To add an extension line

1. Select the dimension line anywhere along its length.
2. Click the diamond-shaped Add Extension Line edit handle which displays near the Move edit handle. The pointer changes to a two-headed arrow ↔.
3. Drag the handle to the object that you want to locate with a new extension handle. This example adds an extension line to the window edge.

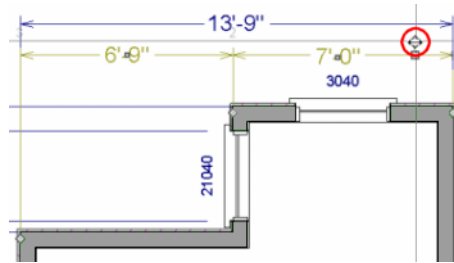

4. Release the mouse button to add an extension line.

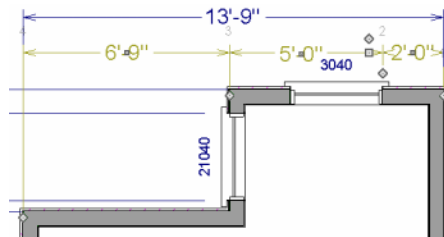

MOVING AN EXTENSION LINE

Extension lines can be moved to locate the centers, sides, or surfaces of most objects. Here, an extension line is moved from the windows edge to the center.

To move an extension line

1. Select the dimension line anywhere along its length: do not click on the extension line itself.
2. Click the Extension Line edit handle. The pointer changes to a two-headed arrow ↔.

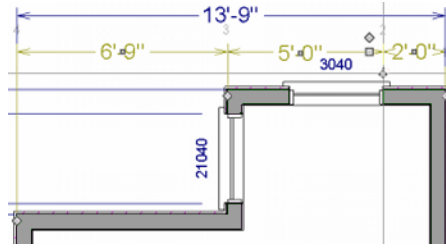

3. Drag the handle to a new location. The extension line snaps to possible marks as the handle is moved.
4. Release the mouse button at the new location.

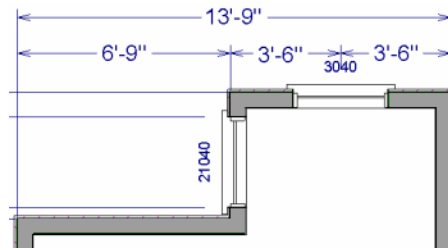

 Not all library symbols can be located by a dimension line as it is drawn. Once a dimension is drawn, however, you can move or add an extension line to locate the library object.

DELETING AN EXTENSION LINE

When an extension line is deleted, the remaining dimensions update. If a dimension line has only two extension lines, they cannot be deleted.

To remove an extension line

1. Select the dimension line anywhere along its length: do not click on the extension line itself.
2. Click the Extension Line edit handle.

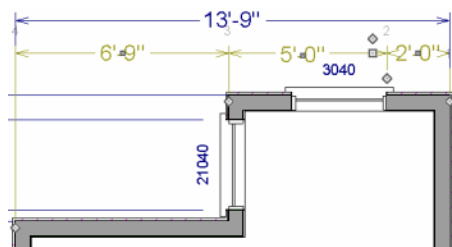

3. Drag it perpendicular to the direction of the arrows, away from any dimensionable object, and release the button when the extension line disappears.

In addition, individual extension lines can be selected, allowing you to resize them.

RESIZING EXTENSION LINES

You can resize extension lines in the Dimension Line Specification dialog or using their edit handles. See [Extensions Panel on page 321](#).

To resize an extension line

1. Click on the extension line or select the dimension line and click the **Edit Extensions**  edit button to display two handles along the extension line.



2. Click either handle, turning the pointer into a two-headed arrow \leftrightarrow .
3. Extend or contract the extension line and release the mouse.

USING PROXIMITY FIXED

The **Proximity Fixed** option allows you to specify a fixed length for one extension line that will not change if the object the extension line locates is moved.

To use Proximity Fixed

1. Select a dimension line that locates multiple independent objects and note the Extension Number of the extension line that you would like to have a fixed length.
2. Open the Dimension Line Specification dialog and go to the EXTENSIONS panel. See [Extensions Panel on page 336](#).
 - Select the Extension Number that you noted in step 1 from the **Selected Extension** drop-down list.
 - Check **Proximity Fixed**.
 - Specify the desired **Distance to Marked Object**, which is the distance from the selected dimension line to the object that the Selected Extension locates. This distance includes the Gap From Marked Object.
 - Click **OK**.

To see how Proximity Fixed works, select the object that the extension line with Proximity Fixed specified and move it. Notice that the dimension line moves in response and that all extension lines' lengths adjust except for the one with Proximity Fixed.

Moving Objects Using Dimensions

Most objects can be moved by changing an automatic, manual, or temporary dimension value that locates it. This technique can be applied in nearly any situation where dimensions are present, including angular dimensions. See [Moving Objects on page 165](#).

In addition, some objects can be resized using dimensions. See [Resizing Objects on page 171](#).

Your pointer indicates which dimensions can be used to relocate the selected object by changing to a pointing hand  icon.

Another way to tell is to select an object and drag it in the desired direction. As you drag, note which dimensions update. These dimensions are the dimensions that can be used to move that object.

Note: A selected object can be moved and resized using a dimension line even when that dimension's layer is locked. See [Locking Layers on page 125](#).

To move an object using dimensions

1. Select the object and click on a dimension line that locates it. An inline text field opens at the location where you clicked.
 - The actual distance displays in the text field.
 - If the dimension is locating two different objects and the selected object is polyline-based, the **Move Edge** and **Move Entire Object** buttons display to the right of the text field.



- If the dimension describes a selected wall's length, additional buttons display to the right. See *Using Dimensions on page 245*.



2. Click the **Move** button of your choice.
3. Enter a new value in the text field.
 - To use a different unit, include its indicator after the value.
 - To move the selected object past a second object, to its opposite side, enter a negative value.
 - Basic math operations can also be performed in the inline text box, just as they can in dialogs. See *Units and Math Operations in Dialogs on page 18*.
4. The selected object moves or resizes when you press the Enter key or click outside of the text field.
5. If **Bumping/Pushing**  is enabled, the object being moved will bump into any objects in its move path and not move the entire distance. Hold down the Ctrl key when you press Enter to override this move restriction. See *Bumping/Pushing on page 166*.

A variety of polyline- and box-based objects can also be resized using dimensions.

To resize an object using dimensions

1. Select the object along the edge that you would like to move. See *Selected Edge on page 142*.
2. Click on a dimension line that indicates its distance from the object's opposite side.
3. In the inline text field, enter a value.
4. Click **Move edge** to move the selected edge only.
5. The selected edge moves, resizing the object, when you press the Enter key.

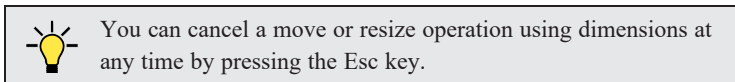

RESIZING WALLS USING EXTERIOR DIMENSIONS

When resizing a structure using dimensions, it is important to work your way around it in one direction. Relocate one wall at a time in succession so that you do not redefine the same dimension more than once.

For more information, see *Measuring Walls on page 242*.

USING ANGULAR DIMENSIONS

 **Angular Dimensions** are useful for adjusting the angles of polyline-based objects and walls.

To change an angular dimension

1. Draw an **CAD> Dimensions> Angular Dimension** , then click and drag to draw an arc within the angle you wish to measure.
2. Select the edge that you want to move.
3. Click the dimension value to open the Set Angular Dimension dialog.

The Set Angular Dimension dialog reports the **Previous Value** in degrees, minutes and seconds.

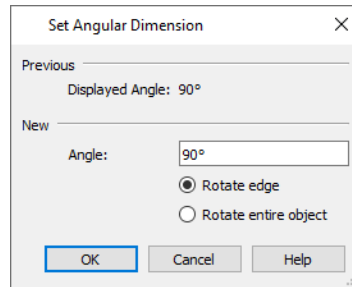

4. Enter a value in the **New Value** field.
5. Specify what you want to rotate:
 - Select **Rotate edge** to move the selected edge when you click OK, or
 - Select **Rotate entire polyline** to rotate the entire object about the corner formed by the edges that the Angular Dimension locates, maintaining the previous value of that angle.
6. Click **OK** to apply the change.

Dimension Line Specification Dialog

 To open the Dimension Line Specification dialog, select one or more dimension lines and click the **Open Object** edit button.

The settings in this dialog are dynamic defaults. See [Dimension Defaults Dialog on page 313](#).

The Dimension Line Specification dialog has the following panels:

DIMENSION PANEL

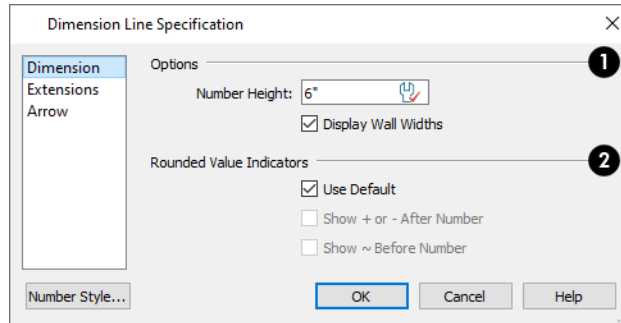

1 Options

Specify the text size and display of wall widths attributes for the selected dimension line. The minimum on-screen size can be set in the Preferences dialog. See *Appearance Panel on page 60*.

- Specify the **Number Height** of the selected dimension's labels. See *Dynamic Defaults on page 55*.

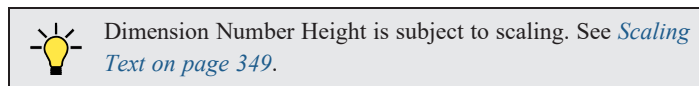

- Uncheck **Display Wall Widths** to suppress those portions of the dimension line that measure between two surfaces of the same wall. Both sides of a wall may still be located, but its width will not display. This option is checked by default for most manually drawn dimensions, but is unchecked for **Interior Dimensions** .

2 Rounded Value Indicators

Specify the use and appearance of **Rounded Value Indicators**, which can display when the degree of accuracy in use is not sufficient to describe a dimension's true value.

- Check **Use Default** to use the default indicator(s). Uncheck this box to make the options that follow active.
- Check **+ or - After Number** to indicate that the actual dimension value is higher or lower than the value shown.
- Check **~ Before Number** to indicate dimension values that are not accurate with the ~ symbol.

DIMENSION PANEL FOR ANGULAR DIMENSIONS

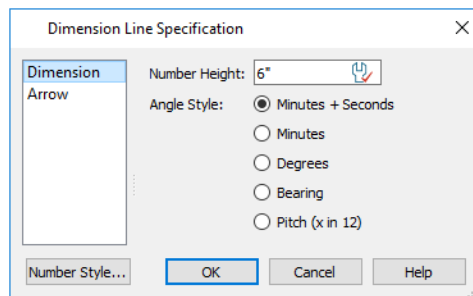

- Specify a **Number Height** for the selected dimension. See *Dynamic Defaults on page 55*.
- When **Use Default Angle Style** is checked, the selected dimension uses the angle style set in the Dimension Defaults dialog. Uncheck this box to select a different **Angle Style**. See *Format Panel on page 320*.

EXTENSIONS PANEL

The EXTENSIONS panel is not available for dimensions selected as a group or for **Angular Dimensions** .

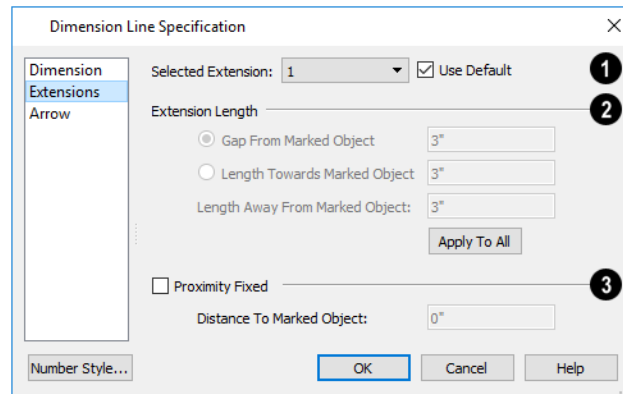
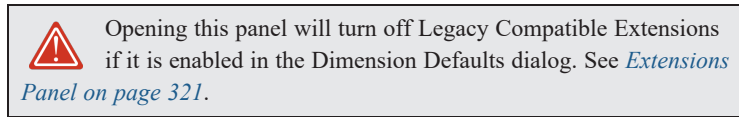

1 Selected Extension

Choose an extension line associated with the currently selected dimension from the drop-down list. The Selected Extension can then be edited here.

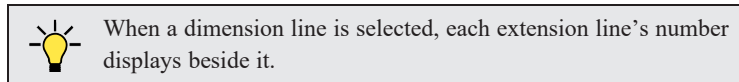

- Uncheck **Use Default** to enable the three settings that follow. Check this box to restore the default settings to the Selected Extension line. See [Dimension Defaults Dialog on page 313](#).

2 Extension Length

The **Extension Length** settings are the same as those in the Dimension Defaults dialog, but apply to the extension lines associated with the selected dimension line only. See [Extensions Panel on page 321](#).

- Click **Apply to All** to apply the settings for the Selected Extension line to all extension lines associated with the selected dimension.

3 Proximity Fixed

Check **Proximity Fixed** to specify a fixed distance between the marked object and the dimension line. You can only fix the proximity for a single extension line.

- **Distance to Marked Object** - When Proximity Fixed is checked, you can specify the distance from the dimension line to the marked object using a positive value. See [Extensions Panel on page 321](#).

ARROW PANEL

For information about the settings on this panel, see [Arrow Panel on page 205](#).

Text, Callouts, and Markers

Chapter 14

The Text Tools help you draw attention to special details of your drawings. Text objects can be added in plan view, in cross section/elevation views, and to layout pages.

TOPICS

Text Defaults and Preferences	338
Fonts and Alphabets	339
The Text Tools	340
Creating Text, Callouts and Markers	341
Displaying Text Objects	341
Rich Text Specification Dialog	342
Editing Text	347
Copying and Pasting Text	350
Find/Replace Text	351
Text Arrows	352
Callouts	354
Callout Specification Dialog	355
Editing Callouts	357
Markers	357
Marker Specification Dialog	358
Editing Markers	359
Text Styles	360
Object Labels	362
Label Panel	363

Text Defaults and Preferences

 Text Defaults can be accessed by selecting **Edit> Default Settings** in any view in which text can be created. Click the "+" next to **Text, Callouts and Markers** to display the sub-headings. See [Default Settings vs Preferences on page 54](#).

The default settings for Rich Text, Callouts, Markers, and Arrows determine what these objects look like when they are first created. Text Style Defaults determine the appearance of text associated with things like dimensions and object labels.

Changes made to default settings do not alter existing text objects, so it is a good idea to go over these settings before placing text.

TEXT STYLE DEFAULTS

Select "Text Style" from the list in the Default Settings dialog and click the **Edit** button to open the Saved Text Style Defaults dialog.

The Text Style Defaults dialog allows you to specify the attributes of the various Text Styles in use in the current file. See [Text Styles on page 360](#).

RICH TEXT DEFAULTS

Double-click the **Rich Text**  to open the Rich Text Defaults dialog and specify the default appearance of Rich Text objects.

The Rich Text Defaults dialog is similar to the Rich Text Specification dialog. See [Rich Text Specification Dialog on page 342](#).

Text Lines with Arrows use the same default layer as Rich Text, so by default they have the same color, line weight and line style. See [Layers on page 123](#).

CALLOUT DEFAULTS

Double-click the **Callout**  tool to open the Callout Defaults dialog and specify the default appearance of callouts.

The Callout Defaults dialog looks almost the same as the Callout Specification dialog. See [Callout Specification Dialog on page 355](#).

MARKER DEFAULTS

Double-click the **Marker**  tool to open the Marker Defaults dialog and specify the default appearance of markers.

The Marker Defaults dialog looks almost the same as the Marker Specification dialog. See [Marker Specification Dialog on page 358](#).

ARROW DEFAULTS

Double-click the **Text Line with Arrow**  tool to open the Arrow Defaults dialog.

The settings in the Arrow Defaults dialog determine the initial settings for arrows drawn using the **Text Line with Arrow**  and **Line With Arrow** tools. These settings also determine the initial appearance of arrows when they are added to CAD lines, arcs, and polylines.

The Arrow Defaults dialog looks almost the same as the ARROW panel of the Line Specification dialog. See [Arrow Panel on page 205](#).

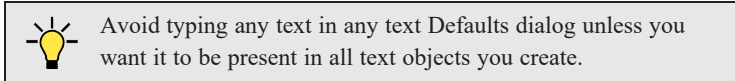

PREFERENCES



Specify whether pressing the Enter key creates a new line of text or closes the Rich Text and Text Specification dialogs in the Preferences dialog. See [Text Panel on page 66](#).

Fonts and Alphabets

Home Designer allows you to use any font found in your computer's Fonts directory.

For best printed results, using true-type or open-type fonts is recommended.

CHIEF BLUEPRINT FONT

The Chief Blueprint font is installed in the Windows Fonts directory when Home Designer is installed.

On Mac systems, this font is embedded with the Home Designer Pro 2022 installation but not installed on the system. As such, it is available for use in Home Designer Pro 2022 but not in other programs.

INTERNATIONAL ALPHABETS





The **Rich Text**  tool supports unicode alphabets and characters. In order to use a unicode alphabet or characters, the appropriate language support must be installed on your computer. See [The Text Tools on page 340](#).

Special characters can be added to any **Rich Text**  object by:

- Copying and pasting the character from another application;
- Copying and pasting the character from the Windows Character Map;
- Using the Mac Character Viewer;
- Typing the keystroke associated with the character.

See [Copying and Pasting Text on page 350](#).

CHARACTER SIZE

Rich Text , **Text** , **Callouts** , **Markers** , **Plant Schedules** , and dimension numbers can be sized to 1/128" accuracy (0.078125 mm). See [Text Style Panel on page 361](#).

These objects use CAD Style Font Sizing, which specifies text size as the measurement from the baseline to the topmost part of the capital letter A, as in most CAD programs.

In legacy files migrated into Version 2022, an additional **Legacy Compatible Size** option will be available for some objects if it was specified in the original program version. When this method is used, text size is based on information stored in the font that is then modified to approximate the specified Character Height.

Rich Text  objects have two font sizing methods to choose from: **CAD Style Font Sizing** and a method similar to most word processing applications, where size is based on information stored in the font. See [Options Panel on page 346](#).

MISSING FONTS

If you open a plan or layout file that uses a font that is not installed on the current computer, the program will give you an opportunity to replace it in the Replace Fonts dialog.

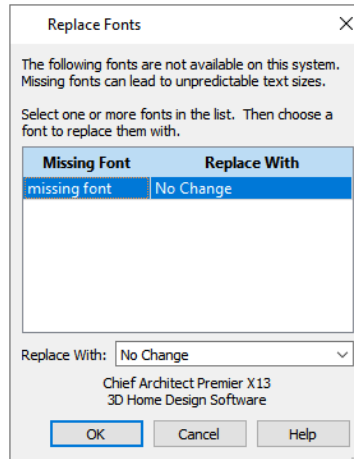

The table lists all missing fonts and how they will be replaced.

- Click on a font name in the list to select it. Use the Shift or Ctrl key to select multiple fonts. See *Shift and Ctrl Select on page 144*.
- Select a replacement font from the **Replace With** drop-down list, or leave “No Change” as the selection to maintain the file’s association with the missing fonts.
- A preview of the selected font displays below the **Replace With** list.

If you do not plan to return the file to the computer where it was created, you may want to replace missing fonts with the fonts you normally use. On the other hand, if you do intend to return the file, you may prefer to not replace any missing fonts.

The Text Tools

T Select **CAD> Text** to access the **Text Tools**. These tools are available in plan view, in cross section/elevation views, and in layout files.



The **Rich Text** tool is used to create text objects. See *Creating Text, Callouts and Markers on page 341*.



The **Text Line with Arrow** tool is used to connect text and another object with an arrow. See *Text Arrows on page 352*.



The **Text with Arrow** tool places a Rich Text object with an arrow attached.



The **Callout** tool is used to place callouts. See *Callouts on page 354*.





The **Marker** tool is used to place markers for **Level Lines**, **Test Borings** and **Point Markers**. See *Markers on page 357*.

Creating Text, Callouts and Markers



Text, callouts and markers can be created in plan view, in cross section/elevation views, and on layout pages. See [View Windows on page 102](#).

Once created, text, callouts and markers can be selected and edited in a variety of ways. See [Editing Text on page 347](#).

To create Rich Text

1. Select **CAD> Text> Rich Text** .
2. Click in the drawing area, and the Rich Text Specification dialog will open. See [Rich Text Specification Dialog on page 342](#).
3. Type or paste the desired text into the Text Field.
4. Use the options in the dialog to change the font, style and size of any portion of the text. See [Editing Text on page 347](#).
5. When you are finished, click OK. The **Text**  tool remains active, so you can create additional text objects if you wish.

Note: If you do not type anything in the Text Field, a text object will not be created when you click outside of it.

Rich Text , **Callouts** , and **Markers**  can also be created by clicking where you want the upper left corner of the object to be created. The object's specification dialog will open: enter text and click OK.

You can also create lines with arrows connecting the text that you create to items in the drawing. See [Text Arrows on page 352](#).

PLACING TEXT FROM THE LIBRARY

 **Rich Text**, **Text**, **Callouts** and **Markers** can be added to the User Catalog in the Library and then placed into plans and layout files as needed. See [Add to Library on page 681](#).

TEXT AND CAD OBJECTS

Text can be used in combination with CAD objects to create legends, title blocks, and a wide variety of other details. See [CAD Objects on page 192](#) and [Layout on page 924](#).

Displaying Text Objects

As with other types of objects, the display of Text objects is controlled in the Layer Display Options dialog. Text objects are located on layers with "Text" at the beginning of the layer name, such as "Text, Callouts". See [Layer Display Options Dialog on page 126](#).

Text objects can only be displayed in views where text can be created.

The display attributes of each individual text object can be controlled independent of the layer it is placed on. See [Rich Text Specification Dialog on page 342](#).

Rich Text Specification Dialog

The Rich Text Specification dialog opens if you select one or more Rich Text objects, then click the **Open Object** edit button.

This dialog also opens when you select the **Rich Text**  tool and then click once in the drawing area.

When **Rich Text** objects are group-selected, the text content, zoom factor, and Paragraph Options cannot be changed, but everything else can be.

The Rich Text Specification dialog is similar to the Rich Text Defaults dialog but affects the selected text rather than all subsequently created text objects. See *Text Defaults and Preferences on page 338*.

TEXT PANEL

The settings on the TEXT panel allow you to type the selected Rich Text object's content and control many aspects of its appearance, including its font, size, color and style.





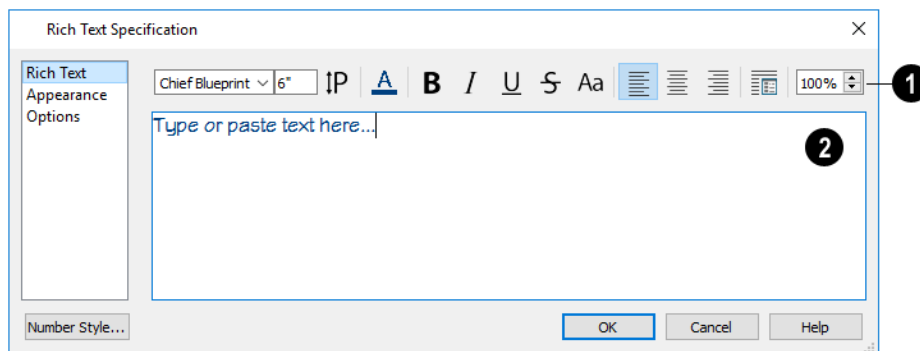





You can specify the appearance of the text before typing, and can also select and change the attributes of all or portions of the text content after it is typed. To change text that already exists, simply highlight it using the mouse and/or the Shift + arrow keys and then make any needed changes to its attributes.

Note: If you do not type anything in the text field on this panel when creating a new object, no object will be created when you click OK. On the other hand, if you remove the text from an existing object and click OK, an empty text box will result.



1 Edit Bar

Use the options on the Edit Bar, which displays above the Text Entry field, to change the font, size, and style of the text. Select the desired options before typing to affect the text as it is typed, or select some or all of the text and then specify which options to apply to it.

- Select a **Font** from the drop-down list.
- Specify the **Text Size** in drawing units.
- Click the **Print Size**  button to open the Printed Size Input dialog. See [Scaling Text on page 349](#).
- Click the **Color**  button to specify the color of the selected or subsequently typed text. See [Select Color Dialog on page 134](#). If **Layer Color Text** is checked on the APPEARANCE panel, any custom colors specified here are lost.
- Click the **Bold**  button to specify the selected text as bold. The Ctrl+B hotkey can also be used.
- Click the **Italic**  button to specify the selected text as italic. The Ctrl+I hotkey can also be used.
- Click the **Underline**  button to specify the selected text as underlined. The Ctrl + U hotkey can also be used.
- Click the **Strikethrough**  button to specify the selected text as stricken-through.
- Click the **Uppercase**  button to display the selected text in all capital letters.
- Click the **Align Left** , **Align Center** , or **Align Right**  button to specify how the selected text is aligned.
- Click the **Paragraph Options**  button to specify the selected paragraph's alignment, spacing and bullets or numbering in the Paragraph Options dialog.
- Specify the **Zoom** factor of the selected text by typing a percentage value in the text field or clicking the up/down arrows. This setting only affects the text as it appears in this dialog.

Note: Some fonts cannot be drawn at certain zoom factors. When this is the case, the appearance of the text will not change.

2 Text Entry Field

Type or paste text in the Text Entry field. See [Copy, Cut and Paste on page 350](#).

- Depending on the current **Preferences**  settings, pressing the Enter key either forces a new line in the text box or closes the dialog. A carriage return can also be added by typing Shift + Enter or Ctrl + Enter. See [Text Panel on page 66](#).
- Right-click in the Text Entry field to access a contextual menu from which you can select Undo, Redo, Cut, Copy, Paste and Select All. See [Contextual Menus on page 18](#).
- To edit text in the entry field, click and drag to highlight any portion of it and then use the tools on the Edit Bar as needed.

PARAGRAPH OPTIONS DIALOG

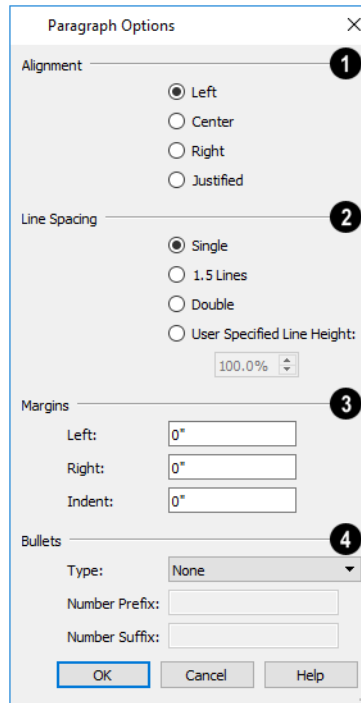

1 Alignment

Specify the **Alignment** of the selected paragraph(s). See *Aligning Text on page 349*.

2 Line Spacing

Specify the **Line Spacing** of the selected paragraph(s).

- Click the radio button beside **Single**, **1.5 Lines**, **Double** or **User Specified**.
- If you select **User Specified Line Height**, type the desired height in the text field. For best results, this value should be at least as much as the largest text size used in the selection.

3 Margins

Specify the appearance of the selection's side **Margins**, as measured in from edges of the text box. Only positive Margin values can be used.

- Specify the **Indent**, which is measured from the left side margin. A negative value can be used if a left Margin has been specified.

4 Bullets

Specify the appearance of **Bullets** and numbering in the selection.

- Select the desired bullet, numbered, or lettered **Type** from the drop-down list.
- Specify the **Number Prefix**, which are any characters that you would like to display before the number or letter. Does not affect paragraphs using circle or square bullets.
- Specify the **Number Suffix**, which are any characters that you would like to display after the number or letter and before its actual text. Does not affect paragraphs using circle or square bullets.

APPEARANCE PANEL

Text Lines with Arrows  use the same default layer as Rich Text, so they share the same default color, line weight and line style. See *Layers on page 123*.

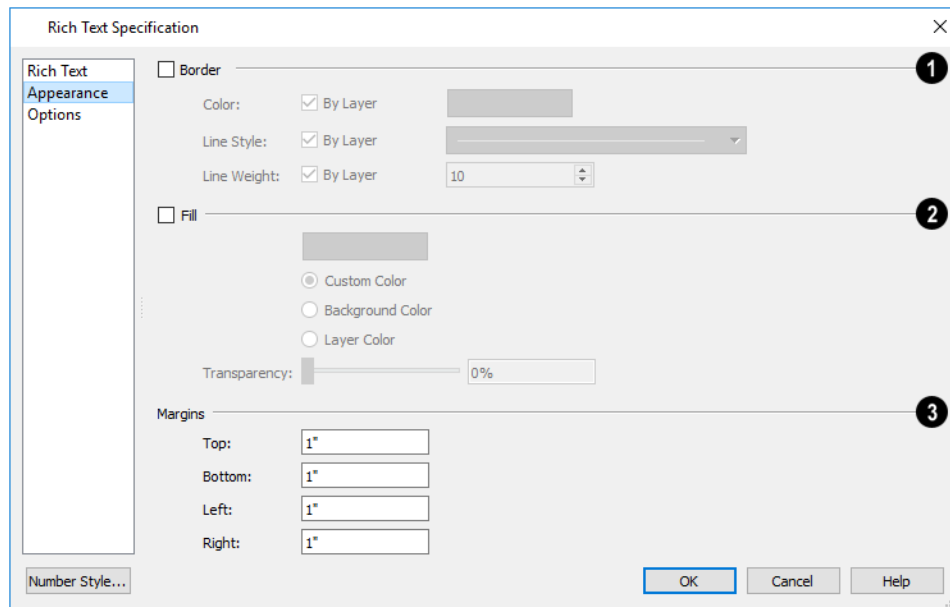

1 Border

Check **Border** to display a border around the selected text object and enable the settings that follow.

2 Fill

Check **Fill** to display a fill color within selected text object(s) and enable the settings that follow.

- Select **Custom Color** then click the Color bar to use a fill color of your choosing.
- Check **Use Layer Color** to use the color assigned to the text object's layer as its fill color.
- Check **Use Background Color** to use program's Background color as the text object's fill color. See *Colors Panel on page 62*.
- Use the **Transparency** slider bar or text field to control how transparent the fill color is.

3 Margins

Specify the **Top**, **Bottom**, **Left**, and **Right Margins**, which are the distance between the text and the border of the selected text object(s).

OPTIONS PANEL

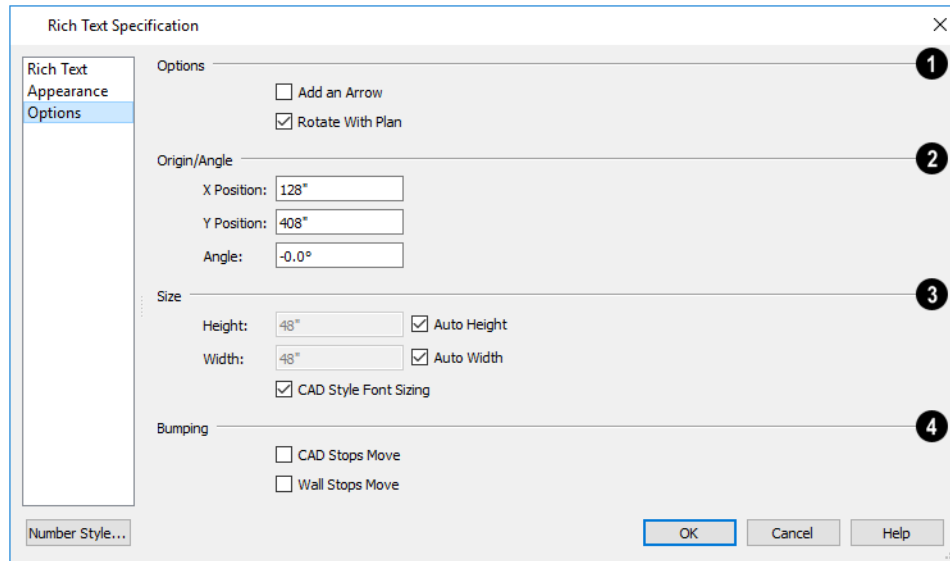

1 Options

- Check **Add an Arrow** to add a Text Arrow to the selected text object. See [Text Arrows on page 352](#).
- Check **Rotate with Plan** to rotate the selected text when **Rotate Plan View**  is used. If unchecked, the selected text is unaffected when Rotate Plan View is used. See [Rotate Plan View on page 103](#).

Rotate with Plan also affects text in views sent to layout if the layout box is rotated. See [CAD and Text in Layout on page 926](#).

2 Origin/Angle

- Specify the **X Position** and **Y Position** of the selected object relative to the origin. See [3D Drafting on page 11](#).
- Specify the **Angle** of the selected text object. The default value is 0°.

3 Size

Specify the **Size** of the selected text object.

- Specify the **Height** of the selected text object(s) or check **Auto Height** to automatically adjust the text object's height to match its contents.
- Specify the **Width** of the selected text object(s) or check **Auto Width** to automatically adjust the text objects width to match its contents. When Auto Width is used, text extends in a single line rather than wrap.
- **CAD Style Font Sizing** measures text size based on the total height of the capital letter A, as most CAD programs do. Uncheck this to instead size text according to information stored with the font, as most word processing programs do. See *Character Size on page 339*.

4 Bumping

See *Bumping/Pushing on page 166*.

- Check **CAD Stops Move** to bump the selected object into other CAD or CAD-based objects as it is moved.
- Check **Wall Stops Move** to stop the selected object when it bumps into a wall.

Editing Text

Once created, **Rich Text**  objects can be selected individually or as a group and edited using the edit handles, the Edit Toolbar buttons, and their specification dialogs. See *Rich Text Specification Dialog on page 342*.

 A customized text object can be added to the Library for future use. See *Add to Library on page 681*.

Text objects can be edited using a variety of methods:

Callout and Marker editing are described separately. See *Editing Callouts on page 357* and *Editing Markers on page 359*.

EDITING TEXT ATTRIBUTES

Most text attributes, including the font, size, style, and the content itself, are edited in the Rich Text Specification dialog.

In order to edit the attributes of an existing **Rich Text** object, you must select some or all of the text before making changes. See *Text Panel on page 342*.

To edit Rich Text attributes

1. Select a **Rich Text** object and click the **Open Object**  edit button.
2. On the TEXT panel of the Rich Text Specification dialog, click and drag to select some or all of the text typed into the Text field.

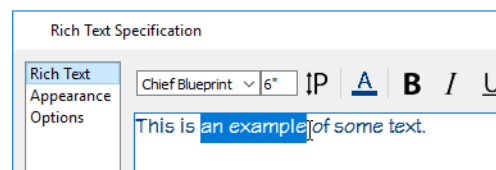

- With some or all of the text selected, change any of the attributes available along the top of the panel, including the font, size, color, and style.

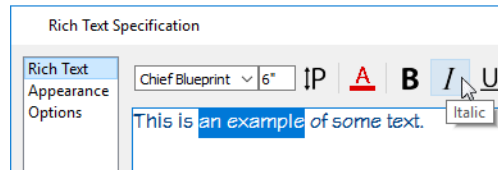

- As changes are made, the selected text updates. Only the selected text is modified.

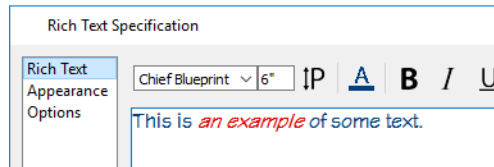





USING THE EDIT HANDLES

A selected **Rich Text** object has the same edit handles as other box-based objects. See [Editing Box-Based Objects on page 158](#).

As a text box’s width is made narrower or wider using an edit handle, its height may increase or decrease so that none of the text becomes hidden. The opposite is not true, however: a text box’s height cannot be resized smaller than the height of the rows of text it currently contains, plus its margins.

Depending on the active **Edit Behavior** , the text box and the characters within it may or may not resize together when a corner edit handle is dragged. See [Defaults, Preferences, and Edit Behaviors on page 137](#).

- If **Resize**  editing is enabled, both the text object and the font resize when a corner edit handle is dragged.
- If **Default**  or **Concentric**  editing is enabled, the text box resizes, but not the font size.
- If **Fillet**  editing is selecting, the corners become rounded and the font size does not change. See [Behaviors Panel on page 76](#).

 When text is resized using the edit handles, there is a “sticky point” at the natural size of the text box. Hold down the Ctrl key while resizing to override this behavior.

USING THE EDIT TOOLS

A selected **Rich Text** object can be edited in a variety of ways using the buttons on the Edit Toolbar. See [The Edit Toolbar on page 91](#).

RESIZING TEXT

Both the border of a text object and the characters it contains can be resized.

The border of a text object can be resized using its edit handles or by specifying the Height and Width in its specification dialog.

The default character height of **Rich Text** objects can be specified as can the character height for individual objects, in their specification dialogs. See [Text Defaults and Preferences on page 338](#).

Character height can be measured in either of two ways. See *Character Size on page 339*.

SCALING TEXT

As with the size of other objects, text size is subject to the current drawing scale specified in the Page Setup dialog. See *Drawing Sheet Setup Dialog on page 943*.

To determine the **Height** in drawing units that is needed to produce text of a specific size when printed, use the Print Size Calculator dialog.

To use the Print Size Calculator dialog

1. Select the text object or Text Style that you wish to scale and click:
 - The **Print Size**  button on the TEXT panel of the Rich Text Specification dialog. See *Text Panel on page 342*.
 - The **Scale** button on the TEXT panel of a variety of specification dialogs. See *Text Style Panel on page 361*.
 - The **Scale** button in the Text Style Defaults dialog.

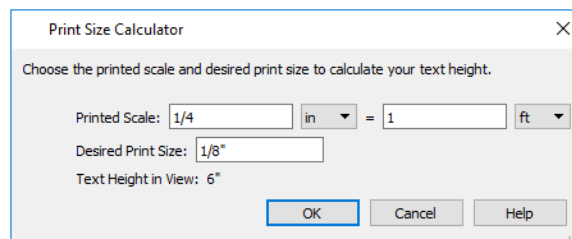





2. In the Print Size Calculator dialog:
 - Confirm the desired **Printed Scale**.
 - Enter the **Desired Print Size** of the text.
 - The **Text Height in View** required to produce the Desired Print Size displays here for reference.
3. Click OK to return to the previous dialog. The **Character Height** value now equals that of the Text Height in View.

Generally, the **Printed Scale** does not need to be changed in the Print Size Calculator dialog unless you intend to send the current view to layout at a different drawing scale. See *Sending Views to Layout on page 927*.

ALIGNING TEXT

Text can be aligned in a number of ways.

- The text content of a text object can be aligned to the left, right, center or justified in the Rich Text Specification dialog. See *Text Panel on page 342*.
- The text content of a text object can be also be aligned by clicking the **Align Left** , **Align Right** , **Center** , or **Justify**  edit button.
- The center points of text objects can be aligned with one another by assigning them the same **X** and/or **Y Position**. See *Attributes Panel on page 356*.
- Text objects can be aligned by bumped them against a CAD line or CAD based object such as a roof plane. See *Bumping/Pushing on page 166*.

A variety of other alignment methods are also available. See *Aligning Objects on page 168*.

The text in the columns of a plant schedule can also be aligned. See *Plant Schedules on page 898*.

COPY, CUT AND PASTE

Copy, Cut and Paste of text into and out of the text specification dialogs can be accomplished using keyboard hotkeys:

- Press Ctrl + X to Cut the selected text and save it to the system clipboard.
- Press Ctrl + C to Copy the selected text and copy it to the system clipboard.
- Press Ctrl + V to paste your last cut or copied selection in a new text object.

For more, see *Copying and Pasting Objects on page 117*.

Copy, Cut and Paste use the system clipboard, making it possible to transfer text between text objects, between Home Designer files, from a plan or layout into another application, or vice versa. See *Copying and Pasting Text on page 350*.

Copying and Pasting Text

The Copy, Cut and Paste commands use the system clipboard, making it possible to transfer text between text objects, between Home Designer files, from a plan or layout into another application such as a text editor or spreadsheet program, or vice versa. See *Copying and Pasting Objects on page 117*.

All or selected portions of the Materials List can also be copied and pasted into a text object, as well as into a word processing or spreadsheet program. See *Materials Lists on page 904*.

Cut, Copy, and Paste can also be accessed from the Edit menu of many applications, including Home Designer. These menu commands are not available when the text specification dialogs are open, but you can use the associated hotkeys.

To Copy, Cut and Paste text

1. On the TEXT panel of either text specification dialog or in another program altogether, highlight the text you wish to cut, copy or paste.
2. Press Ctrl + X to **Cut** the selected text out of its original location and save it to the system clipboard.
3. Press Ctrl + C to **Copy** the selected text to the system clipboard without removing it from its original location.
4. Open the text object or a file in another application and click to place your cursor in the Text field, writing area, or spreadsheet cell.
5. Press Ctrl + V to **Paste** the copied text at the location of your cursor.

Bear in mind that when text is copied and pasted, its formatting is not always retained. The results depend on the program or type of text object in which the content was created as well as the type of text object into which it is pasted.

PASTING INTO RICH TEXT

T Text pasted into a **Rich Text** object from another source will retain most - but not necessarily all - of its custom formatting. If a line of text is sufficiently long, however, it may be wrapped automatically when pasted into Rich Text.

To retain the same character size when text is pasted from a word processing program into the Rich Text Specification dialog, uncheck **CAD Style Font Sizing**. See *Options Panel on page 346*.

If you want to retain the original color(s) of the text being pasted into a **Rich Text** object, be sure to uncheck **Layer Color Text** in the Rich Text Specification dialog. See *Appearance Panel on page 345*.

Text pasted into a **RichText** object from a spreadsheet program retains basic column and row information. Column width cannot be adjusted as it can in simple **Text** ; however, as you add or remove text from a cell, row height will increase or decrease to accommodate your changes.

PASTING INTO A VIEW

Text can also be pasted directly into a plan view or cross section/elevation view. When you use the Paste command, a new Rich Text object is created, the text is pasted into that object, and it is selected. In order to see the new object, you may need to Fill Window.

Find/Replace Text

Find/Replace Text locates text in Rich Text, Callouts, Markers, Plant Schedule titles and headings, and custom labels for objects and rooms. It does not locate text in automatic object labels, default room labels, suppressed labels, the Materials List, or in the bodies of Plant Schedules, however.

Find/Replace Text locates text even when an object's layer is turned off and/or locked. It can also find text in objects on locked layers. See *Locking Layers on page 125*.

FIND/REPLACE TEXT

A **B** Select **Edit> Find/Replace Text** to find a particular word or string of text in your plan or layout file and replace it if you wish.

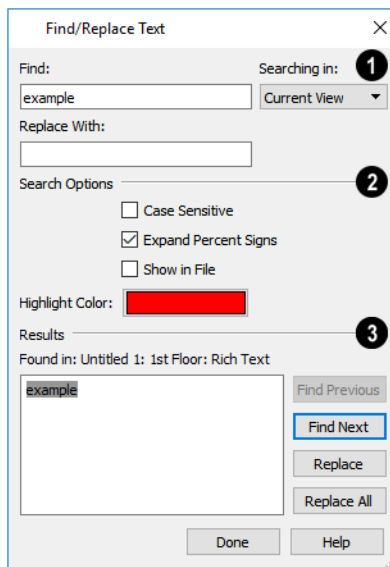

1 Find and Replace

- Type the string of text that you want to **Find** in the text field.
- Type the string of text that you want the text you find to be **Replaced With**.
- Select the scope of your search from the **Searching In** drop-down list. Choose “Current View”, “Current File”, “All Open Files” or “Selected Objects”.

2 Search Options

These settings allow you to refine your search.

- Check **Case Sensitive** to distinguish between capitalized and lowercase letters when searching. When unchecked, capitalization is ignored while searching. The Replace function is always case sensitive.
- When **Expand Percent Signs** is checked, the program will ignore strings of one or two % signs in a row, which may be used to mark up imported text with style commands. Uncheck this to find individual % signs in the search results.
- Check **Show in File** to open a new view window and highlight the object associated with the current search Result. When unchecked, the current search Result will only be highlighted if it is located in the current view window. See [Working in Multiple Views on page 103](#).
- Click the **Highlight Color** button to specify the color used to highlight the object associated with the current search Result. See [Select Color Dialog on page 134](#).

3 Results

The current search results are shown for reference in the field on the left. The location of the associated object, including file name, view name, and its object type is stated above the Results field as well. Click a button to perform the associated action:

- Click **Find Previous** to find the previous search Results.
- Click **Find Next** to search for additional Results.
- Click to **Replace** the current search Results with the replacement specified above.
- Click to **Replace All** instances of the current search Results found throughout the Searching In scope, selected above.

	<p>Although the Find options do not locate text in suppressed labels, Replace All will replace that text. See Displaying Labels on page 363.</p>
---	--

Text Arrows

Text arrows, which are simply CAD lines with arrows drawn on the “Text” layer, can be used to connect text objects to details of interest in your drawing. See [Line Tools on page 199](#).

When a selected Text Line with Arrow is snapped to an object on either end, its end edit handle will display the Selected Edge Handle Fill color. See [Colors Panel on page 62](#).

Text arrows can be snapped together to form open or closed polylines. If two lines with arrows meet within the bounding box of a text object, however, they will not join. This allows you to attach multiple, separate text arrows to a single text object. See [Editing Line-Based Objects on page 145](#).

Lines with arrows can be independent or attached to other objects. If an attached object is moved, the end of the Line with Arrow will move, as well. Arrows attach to closed polyline-based objects along their edges, but can attach to Text or an architectural object anywhere within its bounding box in plan view.

If an arrow is attached to text or another object, deleting either the text or the object will also delete the arrow.

TEXT WITH ARROW

 The **Text with Arrow** tool places a text object with an arrow already attached. This arrow can be selected and edited like any other arrow.

TEXT LINE WITH ARROW

 **Text Lines with Arrow** can be attached to text, CAD and architectural objects by selecting **CAD> Text> Text Line with Arrow** and then clicking and dragging to draw a line. There is no limit to the number of text lines with arrows that can be attached to an object.

The endpoints of **Text Lines with Arrow** can be joined to form polylines with corners that can be adjusted using the edit handles. See [Polylines on page 214](#).

A **Text Line with Arrow** behaves like a **Line With Arrow**  with one exception: Text Lines with Arrow are initially placed on the “Text” layer, not the “CAD, Default”. See [Layers on page 123](#).

AUTO POSITION ARROWS

If either or both ends of a line with arrow are attached to an object, **Auto Position Tail** and **Auto Position Head** will be available in the Line Specification dialog. See [Arrow Panel on page 205](#).

The Auto Position options are designed to prevent lines with arrows from crossing over the text or other objects that they are snapped to. These options snap the ends of a line with arrow to predefined points on the object(s) it is attached to. If an attached object is moved, the end of the line with arrow will update so that it is snapped to the closest Auto Position location. Similarly, if the line with arrow is moved, rotated, or resized, its end may snap to a new Auto Position location on an attached object.

There are four Auto Position locations on a text object: one at the midpoint of each side. The Auto Position locations on other objects varies by object type.

The following image illustrates the behavior of Auto Positioning. The arrow has the **Auto Position Tail** option checked, and the tail end of the line is snapped to the text object. When the head of the line with arrow is moved, the tail of the arrow snaps to different Auto Position locations on the text object, maintaining its connection.

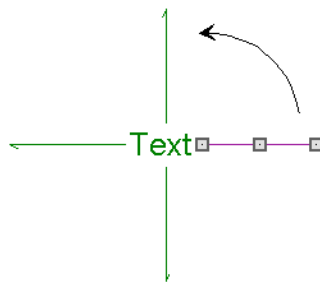

In addition:

- If a selected Text Line with Arrow is moved away from an Auto Position location and you check **Auto Position Tail**, the tail will snap to the nearest Auto Position location.
- The first segment of a polyline arrow attached to text maintains its angle when Auto Position is off and text is moved.
- Auto Position is disabled automatically when an arrow is not attached to one of the auto position locations.
- Arcs and splines with arrows can also be attached to text and other objects.

Callouts

 Select **CAD> Text> Callout**, then click at the location where you want a callout to be placed in plan view, a cross section/elevation view, or on a layout page. The Callout Specification dialog displays. Make any needed changes and click **OK** to place a callout. See *Callout Specification Dialog on page 355*.

CROSS SECTION LINES

Check the **Display Cross Section Line** box in the Callout Specification dialog to add a cross section line perpendicular to the nearest wall. See *Attributes Panel on page 356*.

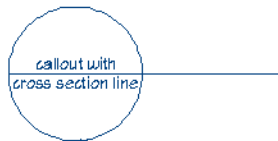

Cross section lines can be added to any callout shape. Resize or rotate the cross section line by dragging the triangular edit handle near the end of the cross section line.

POINTERS AND ARROWS

To add an arrow or “hat” to a callout, select the callout and drag the diamond-shaped handle away from the center of the callout. An arrow is created, pointing in the direction you dragged. Arrows can also be specified in the Callout Specification dialog. See *Attributes Panel on page 356*.

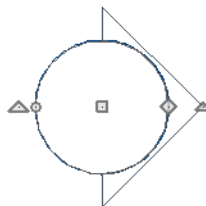

- Change the arrow’s direction by selecting the callout and dragging the edit handle appearing just beyond the arrow.
- Remove an arrow by clicking and dragging the edit handle at the point of the arrow towards the center of the callout.

You can also add as many lines with arrows as you like to callouts. To add a line with arrow to a callout, select **CAD> Text> Text Line with Arrow** , then click and drag to create a line with arrow, which can be moved or resized as needed.

DOUBLE CALLOUTS

Any callout can be specified as a **Double Callout** in the Callout Specification dialog. See *Attributes Panel on page 356*.



To resize the line between the two callout shapes, select the callout and then click and drag the edit handle at the center of either callout shape. The arrows on a double callout are always the same on both callouts.

Callout Specification Dialog

To open the Callout Specification dialog, select a callout and click the **Open Object** edit button. This dialog also displays when a new callout is created using the **Callout**  tool.

The Callout Specification dialog is similar to the Callout Defaults dialog but affects the selected callouts rather than all subsequently created callouts. See *Text Defaults and Preferences on page 338*.

CALLOUT PANEL

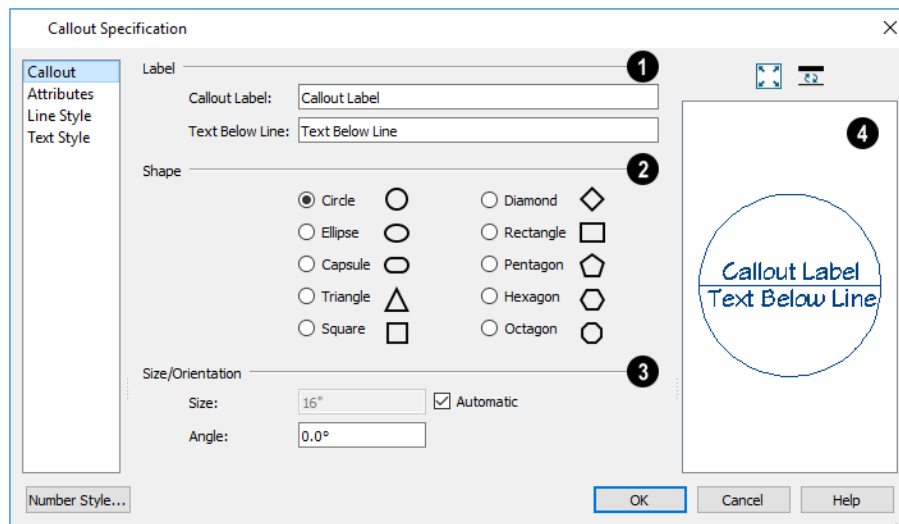

1 Label

Specify the text of the selected callout's **Label** by typing in the text fields here. The label's text style can be specified on the **TEXT STYLE** panel. See *Text Styles on page 360*.

- Type a **Callout Label**, which displays inside the callout shape. If no **Text Below Line** is specified, the **Callout Label** is centered in the callout shape.
- Type the **Text Below Line** for the bottom row, if desired. If **Text Below Line** is added, a line will separate this text from the **Callout Label** in the callout shape.

2 Shape

Specify the **Callout Shape** by clicking the radio button beside one of the options here.

3 Size/Orientation

Additional **Specifications** can be set here.

- Uncheck **Automatic** to enable the **Size** field and specify a new value. When checked, the callout is sized so that it encompasses the text of its label.
- Specify the **Angle** of the selected callout. Does not affect Ellipse, Capsule, or Rectangle shaped callouts.

4 Preview

A preview of the selected callout displays on the right. See *Dialog Preview Panes on page 20*.

ATTRIBUTES PANEL

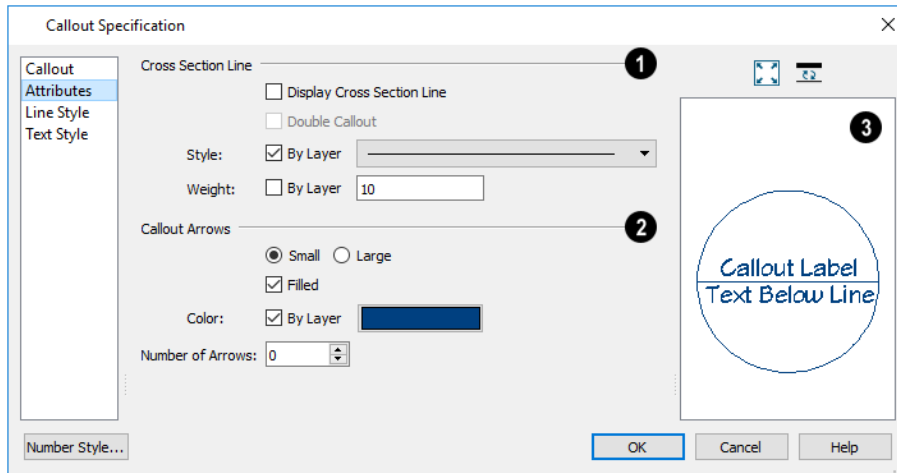

1 Cross Section Line

- Check **Display** to apply a cross section line to the selected callout. When unchecked, no cross section line is used.
- Check **Double Callout** to specify two identical callouts connected by the cross section line. Only available when Display is checked.
- Select the cross section line's line **Style** from the drop-down list. When **By Layer** is checked, the line style specified in the Layer Display Options dialog is used.
- Specify the **Weight** of the cross section line or check **By Layer** to use the line weight specified in the Layer Display Options dialog.

2 Callout Arrows

Specify the attributes of the **Callout Arrows**.

- Specify whether the arrows are **Small** or **Large**.
- Check **Filled** to specify arrows with a solid fill. When unchecked, arrows are unfilled.
- Check **By Layer** to use the color specified in the Layer Display Options dialog or click the **Color** bar to choose an arrow color. See [Select Color Dialog on page 134](#).
- Specify the **Number of Arrows**.

3 Preview

A preview of the selected callout displays on the right. See [Dialog Preview Panes on page 20](#).

LINE STYLE PANEL

The LINE STYLE panel is found in the specification dialogs for many different objects. For more information, see [Line Style Panel on page 204](#).

Additional attributes for the cross section line and arrows can be specified on the Attributes panel.

TEXT STYLE PANEL

The settings on the TEXT STYLE panel control the appearance of the selected object's text. For more information, see [Text Style Panel on page 361](#).

Editing Callouts

Callouts can be edited using the edit handles, the Edit Toolbar buttons and the Callout Specification dialog. See [Callout Specification Dialog on page 355](#).

When a callout is selected, it has at least four edit handles. An additional rotate handle displays for each arrow added to the callout.

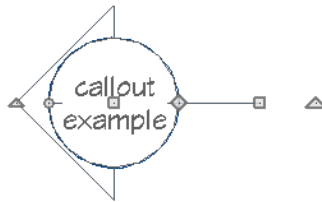

- The **Move** handle is located at the center of the callout and is used to move it.
- The triangular **Extend/Rotate** handle is used to extend and/or rotate the callout's cross section line, if one exists. See [Cross Section Lines on page 354](#).
- The small, square **Resize** handle is located on the edge of the callout and is used to resize it and its associated text.
- The **Add Arrow** handle is used to add arrows by dragging away from the callout shape.
- The small triangular **Rotate Arrow** handle located at the end of an arrow, if one has been added, is used to rotate that arrow around the callout shape.

RESIZING CALLOUTS

Callout shapes can be resized either in the Callout Specification dialog or using the edit handles. See [Callout Panel on page 355](#).

Callout text can be resized in the Callout Specification dialog. See [Attributes Panel on page 356](#).

As long as **Specify Callout Size** box is checked, a callout's shape and text resize independent of one another. When this box is unchecked, the two are dynamically linked: if you resize the shape, the text adjusts accordingly or vice versa.

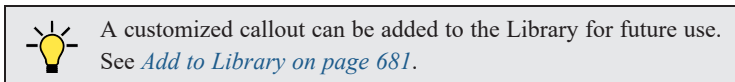

Markers



To create a marker, select **CAD> Text> Marker** and click at the location where you want it to be placed. The Marker Specification dialog opens.

Markers for **Level Lines**, **Test Borings** and **Point Markers** can be placed in plan view, or cross section/elevation views.

You can also place a framing reference marker using **Build> Framing> Framing Reference** . **Framing Reference Markers** should only be placed in plan views. See [Framing Reference Markers on page 628](#).

POINT MARKERS AND DIMENSIONS

There are a number of scenarios in which Markers may be created in conjunction with dimension lines. These Point Markers derive their initial attributes from the Marker Defaults dialog:

- When the **Point to Point Dimension**  tool is used to draw a dimension line and an object is not available to snap to at either the start or end point, a Point Marker will be automatically created and the dimension line will locate it. See [Point to Point Dimensions on page 325](#).
- Dimensions drawn in a cross section/elevation view may locate Cross Section Lines that represent objects rather than the objects themselves. When this occurs, Point Markers will also be placed and the dimension lines will locate them. See [Cross Section Lines on page 758](#).
- If a dimension line is copied independent of the objects it locates, the pasted dimension line will locate Point Markers. See [Copying and Pasting Dimension Lines on page 329](#).

Marker Specification Dialog

 To open the Marker Specification dialog, select a marker and click the **Open Object** edit button.

This dialog also displays when a new marker is created by clicking in plan view using the **Marker**  tool.

The Marker Specification dialog is similar to the Marker Defaults dialog but affects the selected markers rather than all subsequently created markers. See [Text Defaults and Preferences on page 338](#).

MARKER PANEL

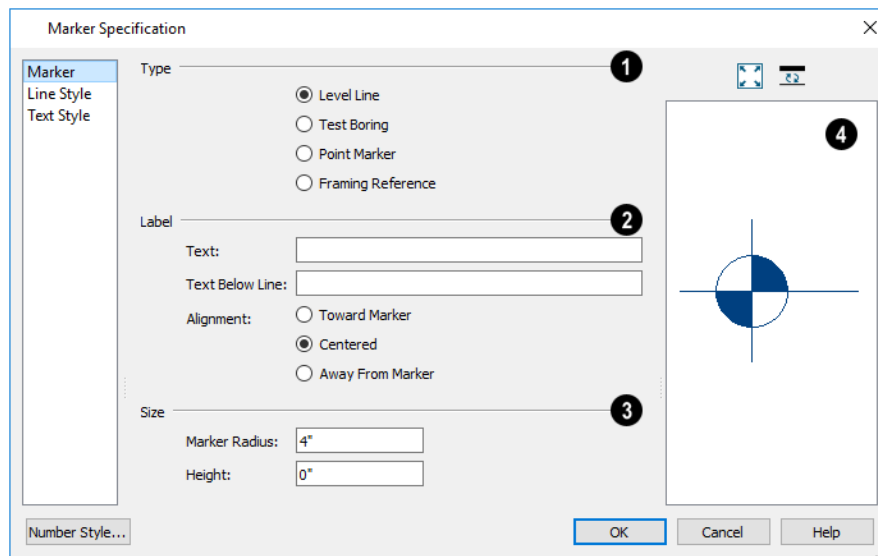

1 Type

Choose a marker **Type**. Note that **Framing Reference Markers**  affect the model, while the other marker types are for annotation only. See [Framing Reference Markers on page 628](#).

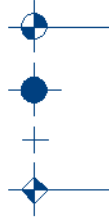

2 Label

Specify the text and alignment of the selected marker's **Label**. The label's text style can be specified on the TEXT STYLE panel. See [Text Styles on page 360](#).

- Type the **Text** which displays above the marker's line.
- Type the **Text Below Line** that displays below the marker's line, if desired. Only available for Level Lines.
- When a Level Line has text both above and below the line, specify its **Alignment**. Select **Toward Marker** to align both lines of text next to the marker; select **Centered** to center the shorter line of text relative to the longer line; select **Away From Marker** to align both lines of text with the end of the line.

3 Size

Specify the **Size** of the selected marker.

- Specify the **Marker Radius**, which is the distance from the marker's center to the edge of its filled shape.
- In a cross section/elevation view, specify the **Height** of the marker, relative to 0. This setting is also available in plan view but does not affect the marker's position. See [Detailing Cross Section/Elevation Views on page 745](#).

4 Preview

A preview of the selected marker displays on the right. See [Dialog Preview Panes on page 20](#).

LINE STYLE PANEL

The LINE STYLE panel is found in the specification dialogs for many different objects. For more information, see [Line Style Panel on page 204](#).

Additional attributes for the cross section line and arrows can be specified on the ATTRIBUTES panel. See [Attributes Panel on page 356](#).

TEXT STYLE PANEL

The settings on the TEXT STYLE panel control the appearance of the selected object's text. For more information, see [Text Style Panel on page 361](#).

Editing Markers

Markers can be edited using the edit handles, edit toolbar and Marker Specification dialog. See [Marker Specification Dialog on page 358](#).

When a marker is selected, it has four edit handles.



- The **Move** handle is located at the center of the marker and is used to move it.
- The **Resize** handle is located on the edge of the marker and is used to resize the marker and associated text.
- The triangular **Rotate** handle is used to rotate the marker and associated text.
- The **Extend** handle is used to adjust the distance between the marker and its associated text.

 A customized marker can be added to the Library for future use. See [Add to Library on page 681](#).

Text Styles

In Home Designer, a Text Style is a set of attributes assigned to objects that displays text, such as Dimensions, Callouts, Markers, Plant Schedules, and object labels.

Note: Because of its ability to use multiple attributes in the same object, Rich Text does not use Text Styles. See [Rich Text Specification Dialog on page 342](#).

You can create your own or edit existing Text Styles to suit your needs in the Text Style Defaults dialog.

TEXT STYLE DEFAULTS



Select **Edit > Default Settings**, click on “Text Styles” and click the **Edit** button. The Saved Text Styles dialog will open, allowing you to select which Saved Text Style Defaults you would like to edit.

SAVED TEXT STYLES DIALOG

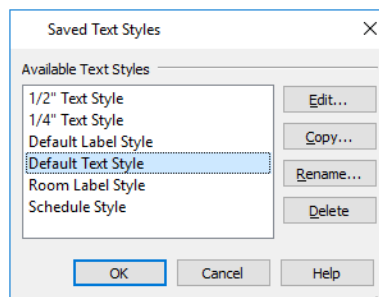

- Select the **Name** of a Text Style from the list.
- Click the **Copy** button to create a new Text Style by copying the one currently selected in the Name field.
- Click the **Edit** button to open the defaults dialog for the selected Text Style so that you can edit it.
- Click the **Rename** button to change the name of the selected Text Style.
- Click the **Delete** button to remove the selected Text Style from the current plan or layout file.
- Click **OK** to close the Saved Text Style Defaults dialog and save any changes you made in the defaults dialog(s). Any changes made to a given Text Style will be applied to all objects in the current plan that are set to use that Text Style.

- Click **Cancel** to close the Saved Text Style Defaults dialog without saving any changes that you may have made in the defaults dialog.

TEXT STYLE PANEL

The TEXT STYLE panel is found in various specification and defaults dialogs in the program.

The settings on this panel are also found in the Text Style Defaults dialog, where they affect all objects using that style rather than a single selected object.

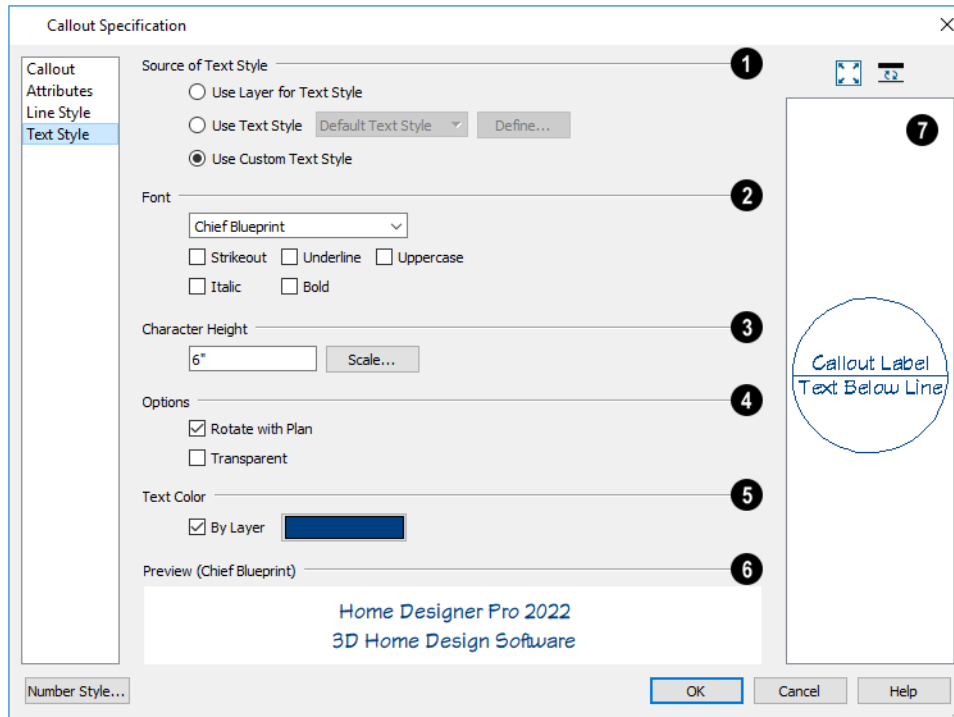

1 Source of Text Style

Specify where the selected object should draw its Text Style from. These options are not available in the Text Style Defaults dialog.

- Select **Use Layer for Text Style** to use the Text Style assigned to the layer that the selected text is located on.
- Select **Use Text Style**, then choose a style from the drop-down list to apply that style to the selected object, regardless of what layer it is on. When this is not selected, the name of the selected object's Text Style displays here for reference.
- Select **Use Custom Text Style** to enable the settings below and customize the selected objects Text Style attributes.
- Check **Use Default Text Style** to use the default style for the selected object type, or uncheck this box to enable the settings below and define a custom style.
- The settings that follow are only editable when **Use Custom Text Style** is selected. When it is not selected, information about the Text Style that is assigned to the selected object displays for reference.

2 Font

- Select a font from the drop-down list.
- The text styles **Bold**, **Underline**, **Italic**, **Strikeout**, and **Uppercase** are available. Check any of the boxes to apply that style.

3 Character Height

- Enter the **Character Height** in drawing units. This height is subject to the current drawing scale.
- Click the **Scale** button to open the Printed Size Input dialog. See *Scaling Text on page 349*.
- If the selected object was originally created in an older program version and had **Legacy Compatible Size** checked in that version, this check box will be available. If you uncheck the box and click OK, however, the option will be removed. See *Character Size on page 339*.

4 Options

- Check **Rotate with Plan** to rotate text using the selected Text Style when **Rotate Plan View**  is used. If unchecked, the text is unaffected when **Rotate View** is used. See *Rotate Plan View on page 103*.

Rotate with Plan also affects text in a view sent to layout if the layout box is rotated. See *CAD and Text in Layout on page 926*.

- Check **Transparent** to make text boxes using the selected Text Style transparent. When unchecked, text boxes have a solid fill the same color as your background color. Not available for objects that have FILL STYLE panels in their specification dialogs. See *Colors Panel on page 62*.

5 Text Color

- When **By Layer** is checked, text uses the line color assigned to the layer that the object it is assigned to is located on. See *Layer Attributes on page 124*.
- Uncheck **By Layer**, then click the **Color** bar to select a different color. See *Select Color Dialog on page 134*.

6 Preview of Text Style

A preview of the Text Style currently assigned to the selected object displays here.

7 Object Preview

In some specification dialogs, a preview of the selected object displays on the right. See *Dialog Preview Panes on page 20*.

Object Labels

Object labels can display in plan views for a variety of different object types:

- Automatic Labels provide basic information about the object, such as its type, size, or name.
- You can create a custom label for an object in its specification dialog using text. See *Label Panel on page 363*.

AUTOMATIC LABELS

Most objects that can display labels have an Automatic Label created by the program that states basic information about it.

When **Automatic Labels** is selected in the object’s specification dialog, this is usually the label that will be used; however:

- If a user-defined label is specified in the object’s defaults dialog, that label will be used instead of the Automatic Label.
- Fixtures and appliances inserted into cabinets do not have labels of their own.

DISPLAYING LABELS

 The display of object labels in plan views can be controlled by layer in the Layer Display Options dialog. Label layer names begin with the object type, followed by the word Label: for example, cabinet labels are located on the “Cabinets, Labels” layer. See *Layer Display Options Dialog on page 126*.

You can choose to suppress the label for an individual object on the LABEL panel of its specification dialog. See *Label Panel on page 363*.

Object labels use the Text Style assigned to each label’s layer. For example, cabinet labels use the “Cabinets, Labels” layer’s Text Style. See *Text Styles on page 360*.

Object labels use the “Default Label Style” Text Style. See *Text Styles on page 360*.

With the exception of those for rooms, roofs, and cameras, labels can also be included in the Materials List and Master List. Items in the Labels column of the Materials List are editable; however, any changes will not be applied to the actual objects’ labels. See *Materials List Columns on page 912*.

The minimum on-screen display size of labels can be specified in the Preferences dialog. See *Appearance Panel on page 60*.

Label Panel

 The LABEL panel is found in the specification and defaults dialogs for a variety of different objects.

Note: If you choose a callout shape in the Plant Schedule Specification dialog, the settings here are overridden and the schedule label is used instead. See *Labels Panel on page 902*.

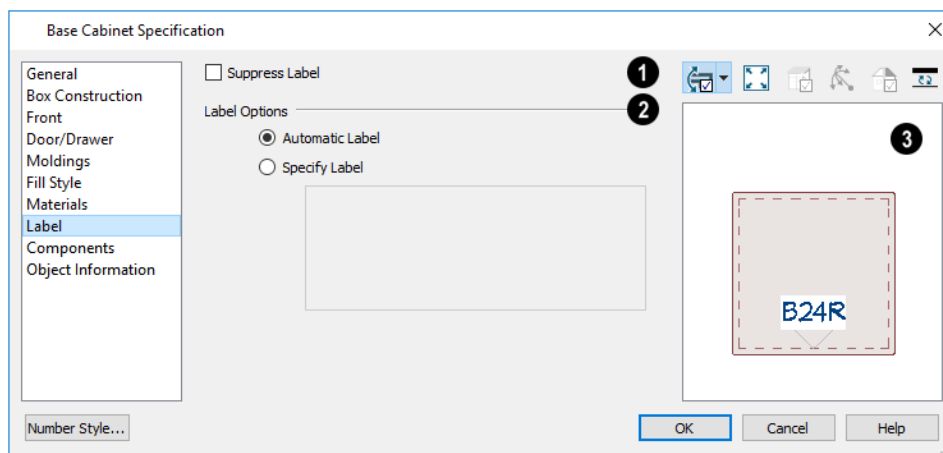

1 Suppress Label

Most objects have this option; however, Bay, Box, and Bow Windows and Mulled Units instead have several settings for controlling **Multiple Component** labels. See *Window Labels on page 402*.

- Check **Suppress Label** to prevent the selected object's label from displaying in plan.

For Bay, Box and Bow Windows and Mulled Window units:

- Select **Suppress All Labels** to display no label in plan view. Individual components are counted in the Materials List.
- Select **Show Component Labels** to produce labels for each component in plan view. Individual components are counted in the Materials List.
- Select **Show Single Label for Entire Unit** to produce one label for the unit and suppress component labels. When this option is selected, the settings that follow on the LABEL panel become enabled.
- These settings also affect how Bay, Box and Bow Windows and Mulled Window units are counted the Materials List. See *Window Labels on page 402* and *Displaying Mulled Units*.

2 Label Options

Specify the information reported in the label. Not available for cameras. See *Displaying 3D Views on page 747*.

- Select **Automatic Labels** to use the default label for the selected object. See *Automatic Labels on page 362*.
- Select **Specify Label** to replace the selected object's Automatic Label with whatever you type in the text field below. Press the Enter key while the cursor is in the text field to begin a new line. When Specify Label is chosen, the text of the selected object's Automatic Label initially populates the text field.

3 Preview

In most specification dialogs, a preview of the selected object displays here. In the preview pane, labels can be seen in Plan View only. See *Dialog Preview Panes on page 20*.

Doors

Chapter 15



Home Designer comes with tools for creating a wide variety of interior and exterior doors. In addition, the library offers a large selection of specialty doors and doorways including hinged, sliding, pocket, bifold, and garage doors. Additional name-brand door catalogs are also available for download from our website, HomeDesignerSoftware.com.

TOPICS

Door Defaults	366
Door Tools	367
Displaying Doors	369
Editing Doors	371
Changing Door Swings	374
Special Doors	376
Door Specification Dialog	378

Door Defaults

There are several defaults dialogs for doors. Default Settings are accessed by selecting **Edit> Default Settings** . Click the arrow next to “Doors” to expand the category. Select a subheading and click the **Edit** button to open the defaults dialog associated with your selection:

Door Defaults can also be accessed by double-clicking the **Door Tools**  parent button or the **Hinged Door**  or **Sliding Door**  child button. Double-clicking the other Door Tools child buttons will open the defaults dialog for that particular door type.

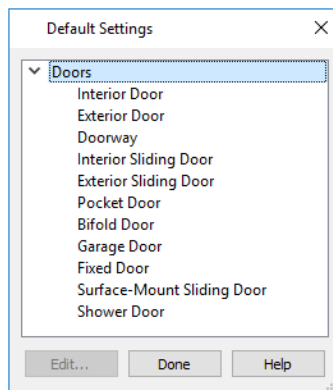

The Door Defaults dialogs look nearly the same as the Door Specification dialog. See [Door Specification Dialog on page 378](#). There are only a couple of differences:

- Since default settings are specified here, “Use Default” is not an option for some settings as it is in the Door Specification dialog.
- The **Door Type** cannot be changed in the Defaults dialogs.

Because Hinged and Sliding Doors are often used in both interior and exterior applications, they have both Interior and Exterior Door Defaults.

INTERIOR VS EXTERIOR DOORS

Regardless of its **Door Type** or the tool used to create it, a door will be:

- An Interior Door if it is created in a wall that separates two interior rooms;
- An Exterior Door if it is created in a wall that separates an interior room from either an exterior room or the building’s exterior. See [Room Types on page 282](#).

This rule does not apply to doors placed from the Library or copied and pasted from one location to another, however. If, for example, you place a hinged door in an interior wall between two rooms and then paste a copy of that door in an exterior wall, the copy will remain an interior door. See [Exterior and Interior Walls on page 230](#).

DYNAMIC DOOR DEFAULTS

A variety of door default values are dynamic, including the **Add for Rough Opening** values, **Casing** and **Lintel Specifications**, and **Hardware**. When a dynamic default is changed, existing doors using the default value are affected. See [Dynamic Defaults on page 55](#).

All **Materials** listed under “Doorway” on the MATERIALS panel are also dynamic. Materials assigned to doors and hardware items from the library are listed separately and are dynamically linked to the “Interior Door”, “Exterior Door” and “Fixture Trim” and “Hardware” materials set in the Material Defaults dialog rather than the Door Defaults dialogs. See [Material Defaults Dialog on page 713](#).

DOOR FRAMING

The default headers, trimmers, rough opening, and sill for doors can be defined in the Door Defaults dialogs. You can also specify an additional amount to cutout for door openings in concrete garage curbs and foundation walls. See [General Panel on page 379](#).

Additional header defaults can also be specified in the Build Framing dialog. See [Framing Defaults on page 606](#).

Door Tools



To place a door, select the type you want from the **Build> Door** submenu. Move your mouse pointer over a wall section. When a preview outline can be seen, click to place a door at that location.

The minimum initial size for doors varies by Door Type. For example, If there is room enough along the wall to fit a 12” (300 mm) wide Hinged Door, a preview outline will display and a door can be placed. Garage doors, in contrast, must initially be at least 6’ (1800 mm) wide.

Doors can be placed in both straight and curved walls, as well as span across straight, collinear wall segments.

A newly created door inherits the settings in the Door Defaults dialog for its door type. Once created, doors can be edited in a variety of ways. See [Door Defaults on page 366](#).

Doors cannot be placed in a wall specified as Invisible or if the wall in question is on a locked layer. See [Locking Layers on page 125](#). See [Room Dividers and Invisible Walls on page 233](#).

Once placed, any door may be changed into any other type of door in the Door Specification dialog. See [General Panel on page 379](#).

HINGED DOORS



Select **Build> Door> Hinged Door** and click on a wall to place a hinged door at that location. Hinged doors have separate defaults for interior and exterior doors. By default, a hinged door becomes a double door when its width is four feet (1200 mm) or greater.

The initial swing direction of a hinged door depends on the location of the mouse pointer relative to the wall when you click. The door will swing towards the side of the wall that you click nearest.

The initial hinge side of a hinged door can be set by clicking to place the door and then holding the mouse button down rather than releasing it. Move the mouse toward the end of the door that you would like the hinges to be on: as the mouse pointer nears either end, the door preview’s hinge side will move to that end. You can also adjust the door’s swing direction in this manner. When the swing direction and hinge side are correct, release the mouse button.

DOORWAYS



Select **Build> Door> Doorway** and click on a wall to place a doorway. Doorways are simply openings without a door and can be placed in interior and exterior walls, railings, and fences. You can assign a door from the library to a doorway if you wish.

SLIDING DOORS

 Select **Build> Door> Sliding Door** and click on a wall to place a sliding door. Sliding doors have separate defaults for interior and exterior doors: interior sliding doors are typically solid while exterior sliding doors are Glass Panel doors.

The initial opening side of a sliding door can be specified by moving the mouse pointer along the wall while the mouse button is still pressed.

POCKET DOORS

 Select **Build> Door> Pocket Door** and click on a wall where you want to place a pocket door.

As with sliding doors, the initial opening side of a pocket door can be specified by moving the mouse pointer along the wall while the mouse button is still pressed.

By default, a pocket door becomes a double pocket door if its width is four feet (1200 mm) or greater.

BIFOLD DOORS

 Select **Build> Door> Bifold Door** and click on a wall where you want to place a bifold door.

Like a hinged door, the initial opening side of a bifold door depends on the location of the mouse pointer relative to the wall when you click. The door will open towards the side of the wall that you click nearest.

Similarly, the initial hinge side of a bifold door can be specified by moving the mouse pointer along the wall while the mouse button is still pressed.

By default, a bifold door becomes a double bifold if its width is greater than three feet (900 mm).

GARAGE DOORS

 Select **Build> Door> Garage Door** and click on a wall to place a garage door.

In plan view, dashed lines show the size and location of the garage door when open.

Garage doors will build into a garage stem wall provided the room is designated as a garage before the door is inserted. See [Room Types on page 282](#).

FIXED DOOR

 Select **Build> Door> Fixed Door** and click on a wall to place a fixed door.

BARN DOOR

 Select **Build> Door> Barn Door** and click on a wall to place a surface mounted sliding door, sometimes referred to as a barn style door.

SHOWER DOOR

 Select **Build> Door> Shower Door** and click on a wall to place a hinged glass slab shower door.



Place a Shower Door in a Straight Glass Wall. See [Wall Tools on page 226](#).

THE DOORS & DOORWAYS LIBRARY CATALOG



The Doors & Doorways library catalog can be accessed by selecting **View > Library Browser** and browsing to Home Designer Core Catalogs > Architectural > Doors and Doorways. This catalog contains a variety of interior and exterior doors, as well as special entryways and wrapped openings.

Entryways and wrapped openings are examples of Doorways, which are wall openings that do not have doors within them.



To add a door to the Doorway, select a **Door Type** other than “Doorway” from the drop-down list in the Door Specification dialog. See [General Panel on page 379](#).

You can also select a door from the library and place it into a doorway in plan view or any 3D view.

To place a library door in a doorway

1. Go to plan view or any 3D view.
2. Open the Library Browser.
3. Browse or search to find a door style that suits your needs.
4. Select the door in the Library Browser, then click on the doorway to place the selected door within it. If a door already exists, it is replaced.
5. Continue clicking other doorways as needed.

Displaying Doors



The display of doors, door labels, opening indicators, header lines, and casing is controlled in the Layer Display Options dialog. See [Layer Display Options Dialog on page 126](#).

Doors can only be placed in walls, so if a wall’s layer is turned off in plan view, any doors placed in that wall will not display, either. Doors can display independent of their containing walls in 3D views, however. See [Displaying Walls on page 240](#).

If the “Doors” layer is turned off, doors and their casing do not display but openings in the walls where they are located are visible.

IN PLAN VIEWS

A door’s jamb, casing, and swing are all represented in plan view. If a door is recessed, the affected wall layers will adjust to accommodate the casing.

A threshold line will display across a door opening in plan view when the door:

- Is located in an exterior wall. See *Exterior and Interior Walls on page 230*.
- Opens to an exterior room such as a Garage or Deck. See *Room Types on page 282*.
- Is located between rooms with different floor heights. See *Floor and Ceiling Platforms on page 295*.

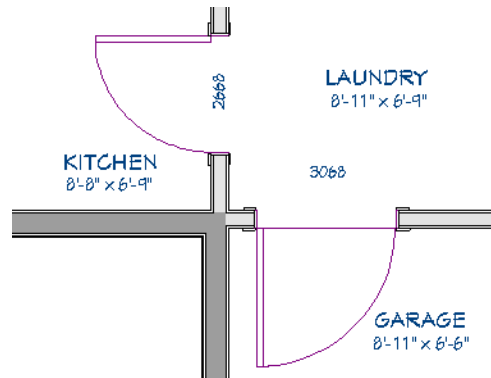



Doorways display dashed lines that represent the wall surface between the doorway and the ceiling. Other types of doors do not display these wall surface lines, however, you can specify that any door display them or not in its specification dialog. See *Options Panel on page 381*.

If an exterior door to a Garage room on Floor 1 extends into a Garage stem wall or curb on Floor 0, its location will be indicated on Floor 0. You can control the display of this concrete cutout in the Door Specification dialog. See *Garages on page 490*.

When the “Opening Header Lines” layer is turned on in plan view, headers are represented by dashed lines within each door’s opening. These lines do not correspond to actual framing objects and cannot be selected. In addition, header framing members can be set to display. See *Wall Framing on page 606*.

The vertical casing on the sides of doors will display in plan view when the “Casings, Exterior” and “Casings, Interior” layers are turned on. See *Casing Panel on page 383*.

IN 3D VIEWS

You can specify whether a selected door is shown open or closed in 3D views by clicking the **Show Door Open in 3D**  and **Show Door Closed in 3D**  edit buttons as well as in the Door Specification dialog. See *Options Panel on page 381*.

If a door is set to display open in 3D, the angle of the open door can be changed using the edit handles in plan view. See *Using the Edit Handles on page 372*.

You can specify whether an exterior door has a threshold in the Door Specification dialog. See *Casing Panel on page 383*.

You can also specify whether window and door glass is opaque or transparent in the Rendering Technique Options dialog. See *Rendering Technique Options on page 787*.

When displayed as opaque, window and door glass uses the Material Color set in the Define Material dialog. See *Pattern Panel on page 727*.

OPENING INDICATORS

Doors, windows and cabinet doors can all display opening indicator arrows in Vector Views. See *Vector View on page 785*.

To display an object's opening indicator arrows in a Vector View:

- Turn on the “Opening Indicators” layer in the Layer Display Options dialog.
- Make sure the object is set to Show its opening indicators in its specification dialog. See [Opening Indicators Panel on page 390](#).

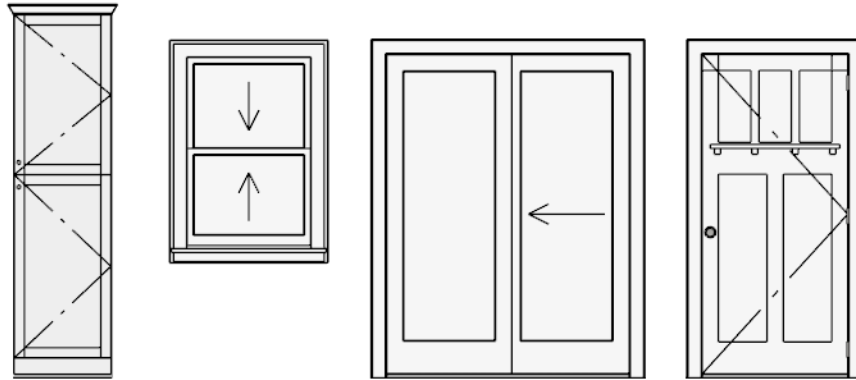

You can specify whether opening indicators point to the opening hinge side or the opening side in the General Plan Defaults dialog. See [General Plan Defaults Dialog on page 56](#).

DOOR LABELS

Door labels display in floor plan view, centered on the doors they represent, when the “Doors, Labels” layer is turned on and use the Text Style assigned to their layer. See [Label Panel on page 363](#).

Door labels indicate Width and Height. For example:

- In Imperial plans, the automatic label for a 3’-0” wide, 6’-8” high double hung window will read 3068.
- In metric plans, the automatic label for a 900 mm wide, 2100 mm high double hung window will read 900x2100.

Customized labels can also be specified in the Door Specification dialog.

IN THE MATERIALS LIST



The materials associated with doors are listed under different Categories in the Materials List:

- **Doors** - Lists door panels, handles, and hinges.
- **Interior Trim** - Lists interior casing and lintels as well as interior door jambs.
- **Exterior Trim** - Lists exterior casing, lintels, shutters. Exterior jambs and thresholds are also listed here.

As with other objects, there are a number of ways to control how, or whether, doors are included in the Materials List. See [Organizing Materials Lists on page 908](#).

You can add and edit information about a door’s accessories in the Door Specification dialog. See [Components Panel on page 921](#).

Editing Doors

Before a door can be edited, it must be selected. To select a door, click it when the **Select Objects**  tool or any of the **Door Tools**  are active. Doors and/or windows can also be group selected and edited. See [Selecting Objects on page 141](#).

Blocked units are made up of individual doors and windows that have been grouped together to act as one object. You can create what is essentially a blocked door unit by assigning a library door to a doorway from the library.

Select a blocked unit by clicking on it in any view. To select a door that is a component of a blocked unit, click at the location of the component in question, then click the **Select Next Object**  edit button. See *Selecting Objects on page 141*.

USING THE EDIT HANDLES

In plan view, click either of the two end handles and drag along the wall to change the width. The label showing the size updates as the handles are dragged. Click and drag the Move handle at the center to move the door along the wall it is placed in. Use the triangular Rotate handle to adjust the door's swing.

In 3D views, a selected door has five edit handles: the Move handle at the center and a Resize handle on each edge. Click and drag an edge handle to resize the door.

Using the edit handles, doors resize according to the currently active **Edit Behavior** . See *Defaults, Preferences, and Edit Behaviors on page 137*.

A door or window moved against an intersecting wall temporarily stops when the casing meets the intersecting wall. You can continue to drag and it resumes movement past the intersecting wall.

IN THE SPECIFICATION DIALOG

The most precise method of editing a door or group of doors is to use the Door Specification dialog. Door type, size, casing, materials, shape, and more can all be specified in this dialog. See *Door Specification Dialog on page 378*.

USING THE EDIT TOOLS

A selected door or doors can be edited in a variety of ways using the buttons on the Edit Toolbar. See *The Edit Toolbar on page 91*.



Change Opening/Hinge Side changes the side of the door that its hinges are on. See *Changing Door Swings on page 374*.



Change Swing Side changes which direction the selected door swings.



Show Door Open in 3D or **Show Door Closed in 3D** controls the selected door's appearance in 3D views. See *In 3D Views on page 370*.



Gable Over Door/Window creates a gable over the selected door(s) the next time the roof is rebuilt. See *Gable/Roof Lines on page 590*.

USING DIMENSIONS



Like various other objects, doors can be moved using dimensions. See *Moving Objects Using Dimensions on page 332*.

You can specify how doors and windows are located by dimensions in the Dimension Defaults dialog. Dimensions can be set to locate the centers, sides, casing, and/or rough openings of doors and windows, or you can choose to not locate them at all. See *Locate Manual Panel on page 315*.

Once a dimension line has been drawn, you can move or add its extension lines to locate non-default locations on a door. See *Editing Extension Lines on page 329*.

CENTERING DOORS

 The **Center Object** edit button allows you to center a selected door along a wall within a room or relative to a cabinet or window. See [Center Object on page 169](#).

To center a door along a wall

1. Select a door or combination of windows and doors in plan view.
2. Click the **Center Object**  edit button then choose from one of the following options:
 - Click near a wall inside a room to center the door along that wall in that room.
 - Click outside the house (on the exterior room) near an exterior wall to center the door along an exterior wall.

DOOR STYLE AND PANELS

There are a number of Door Styles available for use, including Slab, basic Panel, and Louvered. In addition, a selection of door panel symbols is available in the Library. See [Placing Library Objects on page 686](#).

By default, most door types are either single or double, depending on their width. You can specify how many panels a selected door has in the Door Specification dialog. See [Options Panel on page 381](#).

DOOR SIDES

Like walls, all doors have two sides: an interior side and an exterior side. This is the case even for doors placed in interior walls. See [Exterior and Interior Walls on page 230](#).

By default, the interior side of the door will face the direction that the door swings to open. If you prefer, you can specify that the interior side face the opposite direction in the Door Specification dialog. See [General Panel on page 379](#).

You can specify the materials for the two sides separately in the Door Specification dialog. See [Materials Panel on page 392](#).

You can also specify different casing for the interior and exterior sides of exterior doors - that is, doors placed in exterior walls or walls defining a Garage or other exterior room type. See [Room Types on page 282](#).

DOOR CASING

Doors typically feature casing, or trim, on both sides of the wall opening. See [Applying Moldings on page 665](#).

- By default, interior doors use the same casing profile on both sides. You can specify that both sides be edited separately in the Door Specification dialog. See [General Panel on page 379](#).
- Exterior doors can have different casing profiles on their interior and exterior sides.

The default casing for interior and exterior doors is a basic rectangular stock profile. You can specify a door's casing profiles in the Door Specification dialog, or you can choose to suppress casing altogether. See [Casing Panel on page 383](#).

A separate molding profile can be specified for the lintel, or top horizontal molding. See [Lintel Panel on page 384](#).

Exterior and interior door casing will display in all views when the “Casings, Exterior” and “Casings, Interior” layers are turned on. In plan view, only the vertical side casing is shown.

DOOR HARDWARE

Handles, locks, and hinges can be assigned to a door in the Door Specification dialog. See [Hardware Panel on page 388](#).

In 3D views, handles and locks can also be applied directly from the Library Browser. Select a hardware item in the library, then click on the door to apply it to that side of the door. See [Inserted Objects on page 687](#).

Changing Door Swings



Door swing direction and hinge side can be changed using the edit handles and the **Change Opening/Hinge Side** and **Change Swing Side** edit buttons.

Note: If the door is set to draw closed, the swing as it appears in plan view has no effect on the 3D view. See [Options Panel on page 381](#).

The **Change Opening/Hinge Side**  edit button is available for all doors except doors with multiple panels and garage doors.

The **Change Swing Side**  edit button is available for all doors except pocket doors.

HINGED DOORS

In addition to using the edit buttons, Hinged Doors and Shower Doors' hinge side and swing direction can be changed using the triangular Rotate edit handle.

To adjust the angle of swing:

1. In plan view, select the door and grab the triangular handle.
2. Drag to change the amount of swing.

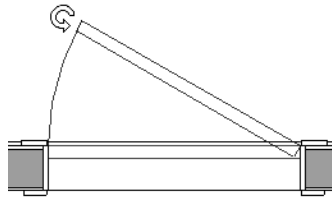

3. Release the mouse.

If you drag near the closed position, the door snaps to a closed position.

To change the swing using edit handles:

1. In plan view, select the door and grab the triangular edit handle.

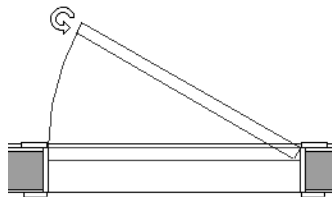

2. Drag the pointer along the path of the new arc to change the hinge side and/or swing direction.

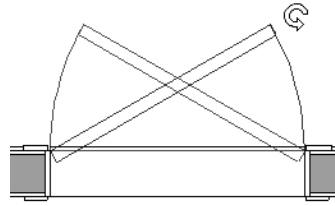

3. Release the mouse.

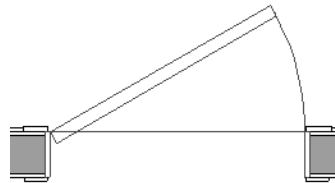

 You can specify a Double Hinged Door to swing from its center in the Door Specification dialog. See [Options Panel on page 381](#).

To change the swing using edit buttons:

1. In plan view, select the door.
2. To change the hinge side, click the **Change Opening/Hinge Side**  edit button.

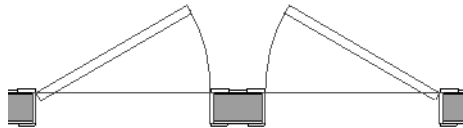

3. To change the swing direction, click the **Change Swing Side**  edit button.

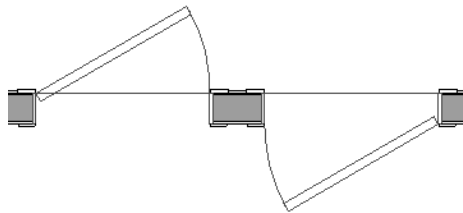

 You can also specify a Hinged Door to swing in both directions in the Door Specification dialog. See [Options Panel on page 381](#).

SLIDING TYPE DOORS

Sliding, Pocket, Bifold, and Barn Doors are types of sliding door.

Similar to hinged doors, the Opening/Hinge and Swing sides of a Sliding, Pocket, Bifold, or Barn Door can be changed by clicking and dragging its diamond-shaped edit handle.

To change the side of a Sliding, Pocket, Bifold or Barn door that opens, select the door and click the **Change Opening/Hinge Side**  edit button.



Note: For a Pocket Door to change Opening Side, there must be enough room for the entire door to fit in the wall on that side.

To flip the fixed and moving sides of the door, click the **Change Swing Side**  edit button.

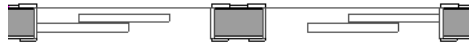

GARAGE DOORS

To change the side of a garage door that it faces, select it and click the **Change Swing Side**  edit button.

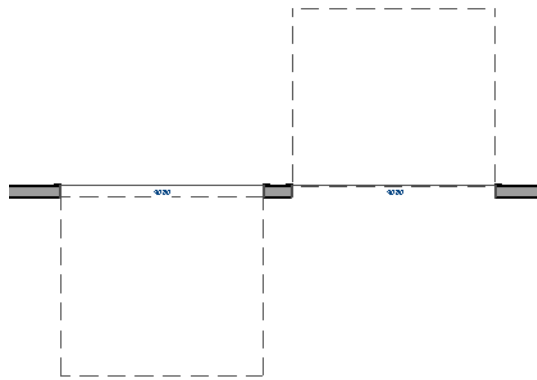

Unlike other door types, the Swing side of a garage door cannot be modified using the edit handles.

Special Doors

A variety of special doors and doorways can be created in Home Designer.

TRANSOMS ABOVE DOORS

Transom windows above doors are created the same as other stacked windows. See [Grouped Windows on page 398](#).

WRAPPED OPENINGS

Wrapped openings of various shapes are available in the **Doors & Doorways Library**.

You can also create a wrapped opening by unchecking **Use Interior Casing** and/or **Use Exterior Casing** in a Doorway's Door Specification dialog. See [Casing Panel on page 383](#). If base molding is present, it will wrap around the opening.

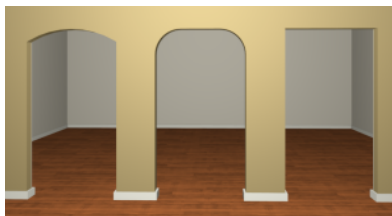

RECESSED DOORS

A door placed in a brick or stone wall is often recessed into the wall's exterior. In the illustration below, the door to the right is recessed, so the brick wraps the opening. The door on the left is not recessed, so the casing is outside the brick.

You can specify a door as recessed in the Door Specification dialog. See [Options Panel on page 381](#).

OPENINGS IN RAILINGS

Use the **Doorway**  tool to open a railing for a stairway or other access.



To open a railing across an entire section, resize the doorway's **Width** so that it is greater than the length of the railing in the Door Specification dialog. The opening resizes to the maximum width possible for that space. See [General Panel on page 379](#).



To add a gate, specify the doorway's **Door Type** as a Door, then choose an appropriate gate as the **Door Style**. A selection of gates is available in the Fences & Railings library folder. See [Placing Library Objects on page 686](#).

CREATING A DOORWAY WITH A RAILING

When a railing is specified as **No Room Def**, it can be positioned within a **Doorway** .



To create a doorway with railing

1. Place a **Doorway**  at the desired location in your plan.
2. Select **Build> Railing and Deck> Straight Railing** , then click and drag to draw a railing parallel to the wall with the doorway.

3. Select the railing, then use the Resize edit handles to adjust the length of the railing as needed. See *Using the Edit Handles on page 145*.
4. With the railing selected, click the **Open Object**  edit button.
5. On the GENERAL panel of the Railing Specification dialog, check **No Room Def** and click OK. See *General Panel on page 262*.
6. With the railing still selected, Ctrl + drag it into position within the doorway. See *To move an object freely on page 166*.

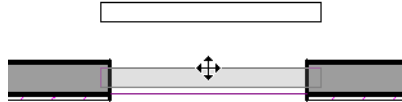

PLACING A GABLE OVER A DOOR





Click the **Gable Over Door/Window** edit button to produce a gable roof over the selected door(s) the next time automatic roofs are built. See *Gable/Roof Lines on page 590*.

You can manually edit or delete this gable line at any time. Your changes take effect when the automatic roofs are rebuilt. This can also be used with group selected doors.

Door Specification Dialog



To open the Interior or Exterior Door Specification dialog, select a door or group of doors and click the **Open Object** edit button or double-click on a door using the **Select Objects**  or any **Door**  tool.

Whether a selected door is Interior or Exterior depends on where it is placed. See *Interior vs Exterior Doors on page 366*.



The Lintel panel is also found in the Window Specification dialog. See *Window Specification Dialog on page 404*.

The Door Specification dialog has the following panels:

GENERAL PANEL

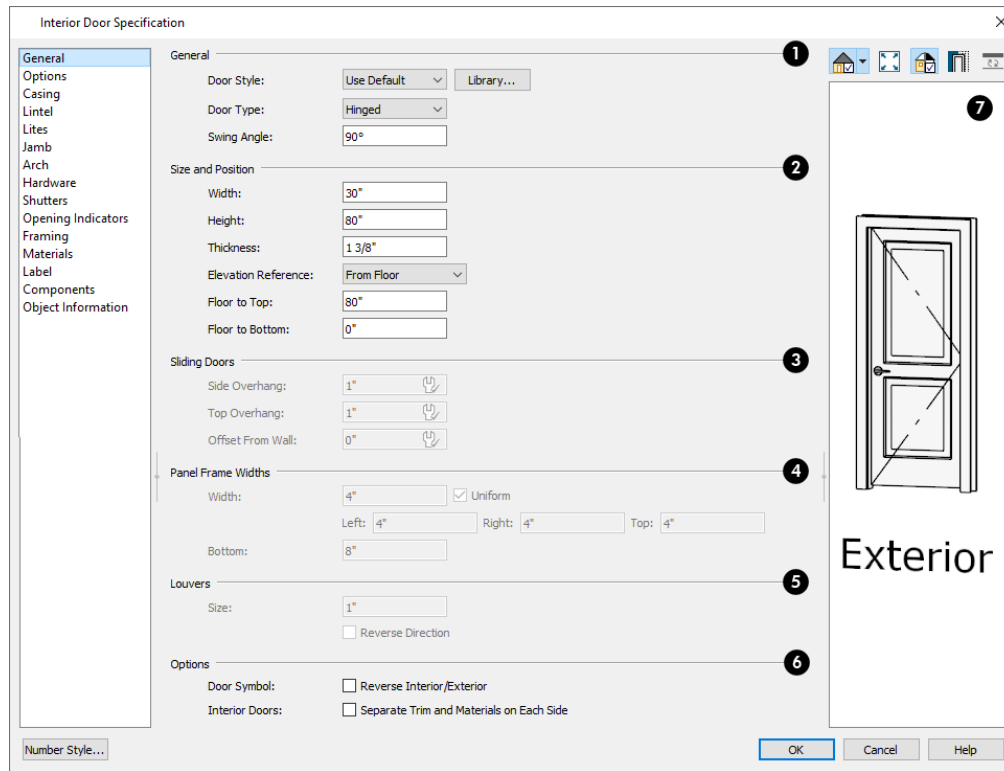

1 General

- **Door Style** - Select Slab, Glass Slab, Panel, Glass Panel, Louvered, or Glass Louver from the drop-down list; select a style from the Library; or choose “Use Default” to use the default door style set in the Door Defaults dialog. See [Door Defaults on page 366](#).
- Select “Library” from the drop-down list or click the **Library** button to choose a door symbol from the library. Once a library door is selected, its name is added to the Door Style list. See [Select Library Object Dialog on page 688](#).
- Specify the **Door Type** as Doorway, Hinged, Sliding, Pocket, Bifold, Garage, Fixed, Barn, or Shower. In the Door Defaults dialogs, the Door Type cannot be changed.
- Specify the **Swing Angle** of the selected door in plan view, between 0° and 180°. An angle of 0° displays the door as closed and an angle of 180° displays it as wide open. The Swing Angle for Bifold doors and double doors that swing from the center can be no more than 90°.

The Swing Angle also affects the door’s appearance in 3D views if **Draw Closed** is unchecked on the OPTIONS panel. See [Options Panel on page 381](#).

2 Size and Position

Specify the **Size and Position** of the selected door.

- Specify the **Width, Height, and Thickness** of the door. These values do not include the jamb.
- Select the **Elevation Reference** from the drop-down list. This determines where the next two settings are measured from and also affects their labels.
- Specify the height **to Top**, measured from the selected Elevation Reference to the top of the door frame.
- Specify the height **to Bottom**, measured from the selected Elevation Reference to the bottom of the door frame.

3 Sliding Doors

The **Sliding Doors** settings are available for Slider, Pocket, and Barn Doors.

- Specify the **Side** and **Top Overhang** values, which control how much the selected door extends past its wall opening. Only available for Barn Doors.
- Specify the **Offset from Wall**, which is how far the selected door is offset from its default location. Slider and Pocket Doors are centered in the wall's Main Layer by default, while Barn Doors are positioned against the wall surface.

4 Panel Frame Widths

Specify the dimensions of the selected door's rails and stiles. Only available for Glass, Panel, and Louvered doors.

- Specify the **Width** of the stiles and top rail. Uncheck **Uniform** to specify separate values for the **Left, Right, and Top** of the frame, or leave it checked to use the same value for all three.
- Specify the height of the **Bottom** rail.

5 Louvers

- Specify the **Size**, or vertical height, of the selected door's louvers. Only available for Louvered and Glass Louvered doors.
- By default, louvers face the direction that the door swings. Check **Reverse Direction** to reverse the direction that they face.

6 Options

- Check **Reverse Interior/Exterior** to reverse the two sides of the selected door so that they face the opposite direction. Only available when a door symbol from the Library is specified as the Door Style. See [Door Sides on page 373](#).
- Check **Separate Trim and Materials for Each Side** to specify the casing, lintels, and all materials for each side of the selected interior door independently. When unchecked, the two sides of the door use the same trim and materials. Only available when the selected door is placed in an interior wall. See [Exterior and Interior Walls on page 230](#).

7 Preview

A preview of the door displays on the right side of the dialog box. A label indicates which side of the door is its Interior and which is its Exterior. See [Dialog Preview Panes on page 20](#).

OPTIONS PANEL

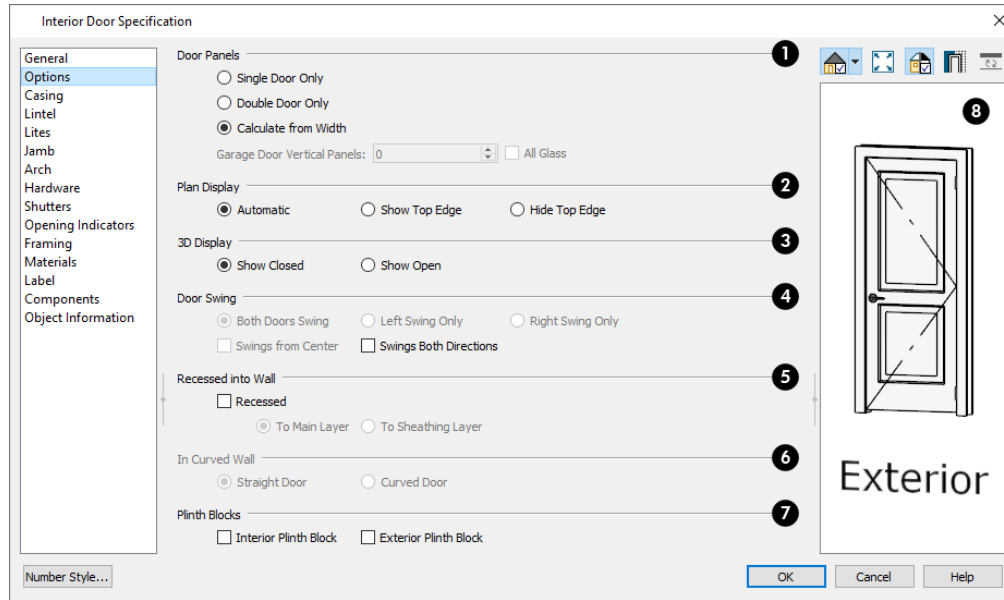

1 Door Panels

Specify the number of **Door Panels** or sections that the selected door has. See [Door Style and Panels on page 373](#).

- Select **Single Door Only** to force the selected hinged, pocket or bifold door to be a single door, regardless of its width.
- Select **Double Door Only** to force the selected hinged, pocket or bifold door to be a double door, regardless of its width.
- Select **Calculate From Width** to use the program defaults. Hinged and pocket doors default to **Single Door** when less than four feet (1200 mm) wide; bifold doors do so when less than three feet (900 mm) wide. If the width is greater than this, **Double Door** is the default.

Note: The Calculate From Width defaults are not editable.

- For a selected Garage Door, specify the number of **Vertical Panels**.
- When **All Glass** is unchecked, only the third panel from the bottom the door is a glass panel: the rest are solid panels. Check this box to make all of the panels glass. The number and style of the lites and the Muntin Width can be specified on the LITES panel.

2 Plan Display

The **Plan Display** settings control the display of dashed wall surface lines above the door in plan view. See [In Plan Views on page 369](#).

- Select **Automatic** to display wall surface lines only when the selected door is a Doorway.
- Select **Show Top Edge** to display wall surface lines regardless of the door type.
- Select **Hide Top Edge** to not show wall surface lines regardless of door type.

3 3D Display

Specify whether the selected door is shown open or closed in 3D and cross section/elevation views.

- If **Show Open** is selected, the Swing Angle set on the *General Panel on page 379* is used.

4 Door Swing

Specify how the selected door swings. Most options here are only available when the selected Hinged or Pocket door is a Double Door. Not available for Bifold, Slider or Garage doors. See *Changing Door Swings on page 374*.

- Check **Both Doors Swing** to allow both sides of a Double Door to swing.
- Check **Left Swing Only** or **Right Swing Only** to allow only the left or right side of a Double Door to swing.
- Check **Swings from Center** to create a Double Door with hinges at the center rather than at the outside edges.
- Check **Swings Both Directions** to allow a door or both sides of a Double Door to swing both directions.

5 Recessed Into Wall

The **Recessed into Wall** options allow you to recess the selected door's jamb into a wall, away from the exterior surface. This setting also affects the exterior casing and lintel, if used. Only available if the door is placed in a multi-layered wall. See *Wall Type Definitions on page 256*.

- Check **Recessed** to activate the settings that follow.

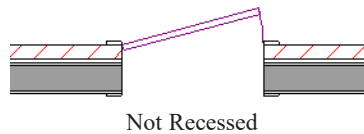

- Select **To Main Layer** to recess the door to the wall's Main Layer.

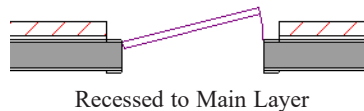

- Select **To Sheathing Layer** to recess the door to the wall's sheathing layer.

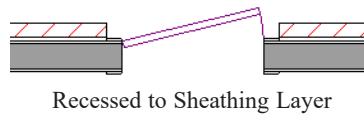

6 In Curved Wall

Specify whether a door placed in a curved wall is **Straight** or **Curved**. Curved is selected for Slider, Pocket, and Barn Doors and cannot be changed. See *Drawing Curved Walls on page 238*.

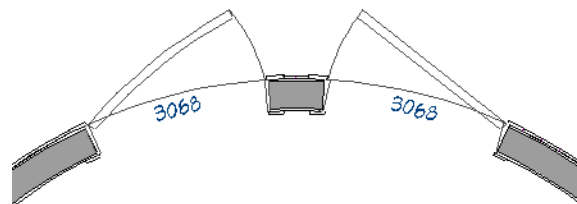

7 Plinth Blocks

Add an **Interior Plinth Block** and/or **Exterior Plinth Block** to the selected door. Plinth blocks do not display in 3D views, but are counted in the Materials List.

8 Preview

A preview of the door displays on the right side of the dialog box. See *Dialog Preview Panes on page 20*.

CASING PANEL

By default, interior and exterior casing is suppressed for doorways placed into railings: including solid railings and railing pony walls.

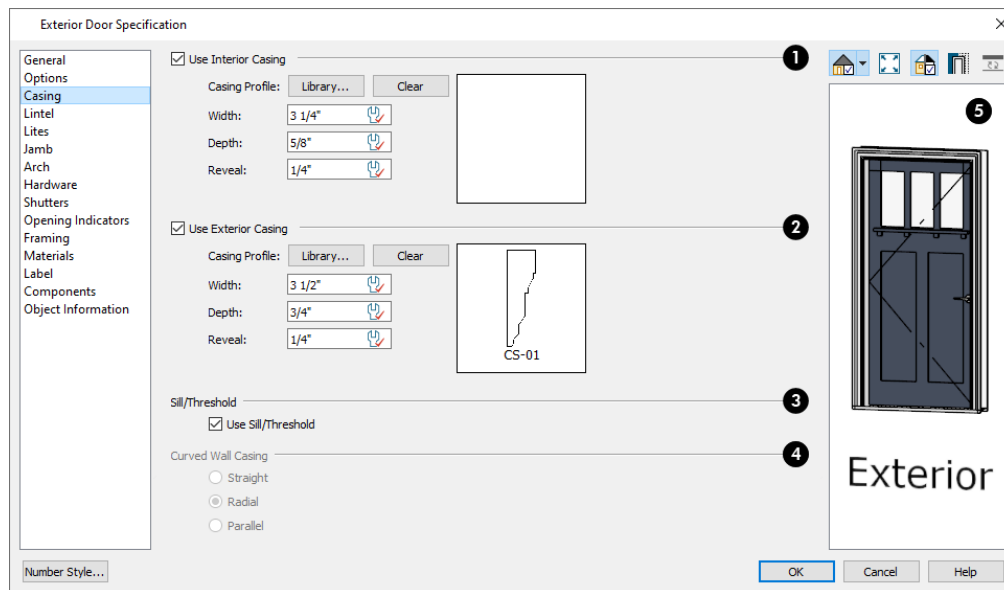

1 Use Interior Casing

When this box is unchecked, no casing is used and the settings that follow are disabled.

- **Casing Profile** - Click the **Library** button to select a molding profile for the casing. A preview of the casing profile displays to the right. See *Select Library Object Dialog on page 688*.
- Click the **Clear** button to remove a selected casing profile from the door. When no profile from the library is selected, a basic rectangular stock profile is used.
- Specify the **Width** of the selected casing.
- Define the **Reveal**, which is the distance between the inside edge of the door frame and the inside edge of the casing.

2 Use Exterior Casing

Check **Use Exterior Casing** to enable the settings that follow, then specify the exterior casing for the selected door(s) These settings are the same as those for the Interior Casing, and are not available for doors in interior walls unless **Use Exterior Trim and Materials** is checked on the GENERAL panel. See *General Panel on page 379*.

3 Use Sill/Threshold

Uncheck **Use Sill/Threshold** to prevent a sill from being generated under the door. See *Displaying Doors on page 369*.

4 Curved Wall Casing

The **Curved Wall Casing** settings are enabled if the selected door is located in a curved wall. See [Drawing Curved Walls on page 238](#).

- Door and window casing and jamb can be constructed three ways in curved walls:
- **Straight** - Both the door and casing are straight. This can be used where the wall's curvature is not too sharp and the opening is not too wide. Not available for Sliding, Pocket, or Barn Doors.

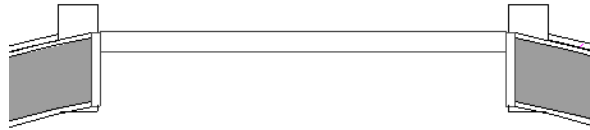

- **Radial** - A vertical surface that would be perpendicular to a straight wall has its plane pass through the wall's center of curvature.



- **Parallel** - A vertical surface that would be perpendicular to a straight wall remains parallel to the line from the wall center through the opening center.



5 Preview

A preview of the door displays on the right side of the dialog box. If casing is not specified for a Doorway, the **Show Wall** option will be toggled on automatically. See [Dialog Preview Panes on page 20](#).

LINTEL PANEL

The settings on the LINTEL panel allow you to assign a lintel, or top molding that meets the side casing using a butt joint instead of a mitered joint. These settings are not available if the door has a reflected arch. See [Arch Panel on page 386](#).

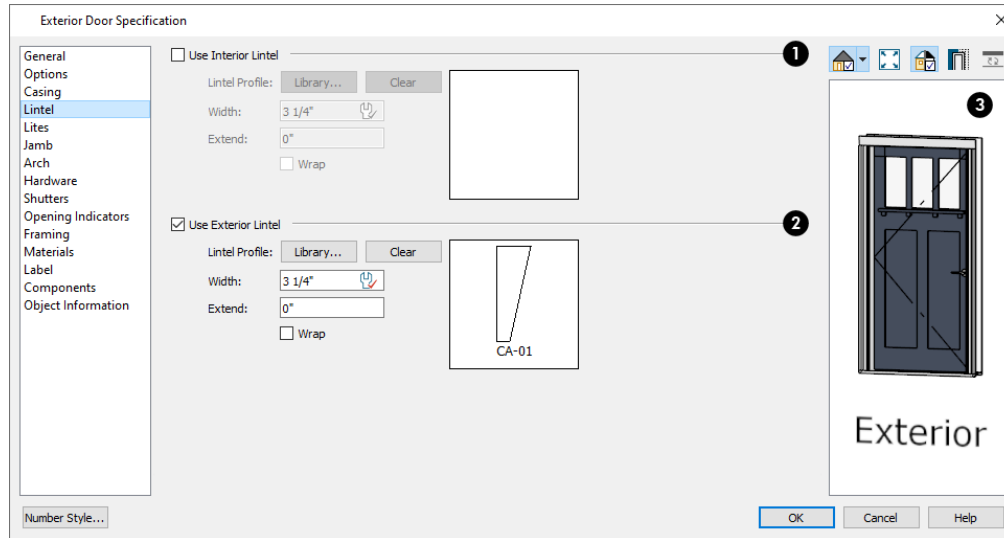

1 Use Interior Lintel

Check **Use Interior Lintel** to enable the settings that follow, then specify the lintel applied to the interior side of the selected door(s) using these settings. When this box is unchecked, no lintel is used.

- **Lintel Profile** - Click the **Library** button to select a molding profile for the lintel. A preview of the selected profile displays to the right. See [Select Library Object Dialog on page 688](#).
- Click the **Clear** button to remove a selected lintel profile from the door.
- Specify the **Width** of the lintel. This value is independent of the casing's width; however, the lintel does inherit its depth from the casing.
- Specify how far to **Extend** the lintel past the outside edges of the casing on each side.
- Check **Wrap** to wrap the lintel profile back toward the wall.

2 Use Exterior Lintel

Check **Use Exterior Lintel** to enable the settings that follow, then specify the exterior lintel for the selected door(s) using these settings. These settings are the same as those for the Interior Lintel, and are not available for doors in interior walls unless Use Exterior Trim and Materials is checked on the GENERAL panel. See [General Panel on page 379](#).

3 Preview

A preview of the door displays on the right side of the dialog box. See [Dialog Preview Panes on page 20](#).

LITES PANEL

The settings on the LITES panel of the Door Specification dialogs are only available when the selected door is specified as a Glass door on the [General Panel on page 379](#). These settings are also found on the LITES panel of the Window Specification dialog. See [Lites Panel on page 413](#).

JAMB PANEL

The settings on the JAMB panel are similar to those on the FRAME panel of the Window Specification dialog. See [Frame Panel on page 412](#).

By default, Has Jamb is unchecked for doorways placed into railings: including solid railings and railing pony walls.

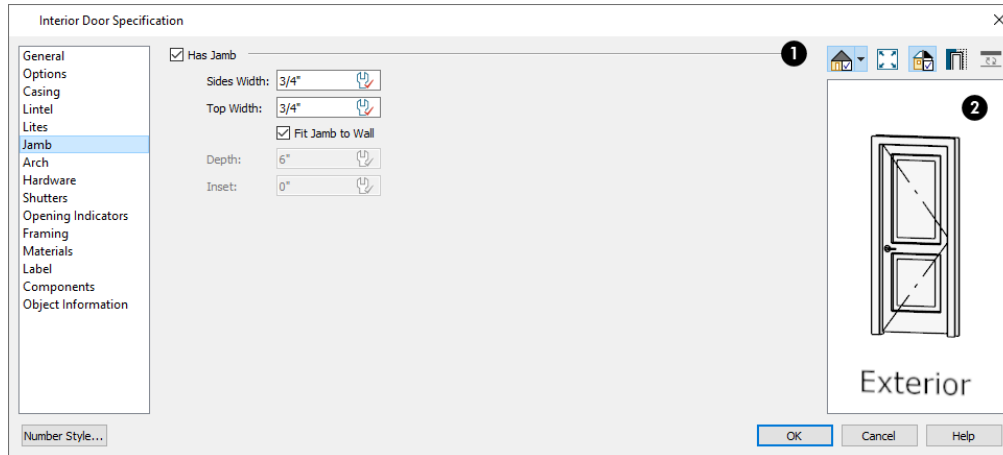

1 Has Jamb

Check **Has Jamb** to enable the settings that follow, then specify the attributes of the selected door’s jamb using those settings. The jamb is not included in the door’s size, which is set on the [General Panel on page 379](#).

- Specify the **Sides Width**, which is the thickness of the pieces of the door jamb that display in plan view. Changing this value does not affect the door’s size.
- Uncheck **Fit Jamb to Wall** to specify the Depth and Inset of the selected door’s jamb. When this box is checked, the jamb Depth automatically extends from the Recessed Into Wall layer to the wall’s inside surface with an Inset of 0”. The Recessed Into Wall layer is specified on the [Options Panel on page 381](#) of this dialog.
- Specify the **Depth** of the door jamb from front to back.
- Specify the jamb’s **Inset**, which is measured from the Recessed Into Wall layer and moves the door jamb towards its interior side. If used, the casing and lintel are not affected by this setting.

2 Preview

A preview of the door displays on the right side of the dialog box. See [Dialog Preview Panes on page 20](#).

ARCH PANEL

The settings on the ARCH panel are also found in the Window Specification dialog.

The settings on this panel are not available if the selected door is a Sliding, Bifold or Garage door, or if the selected door has been assigned a lintel. See [Lintel Panel on page 384](#).

The ARCH panel is not available for window symbols from the library, and its settings are not available if a selected window has been modified using the SHAPE panel. See [Shape Panel on page 416](#).

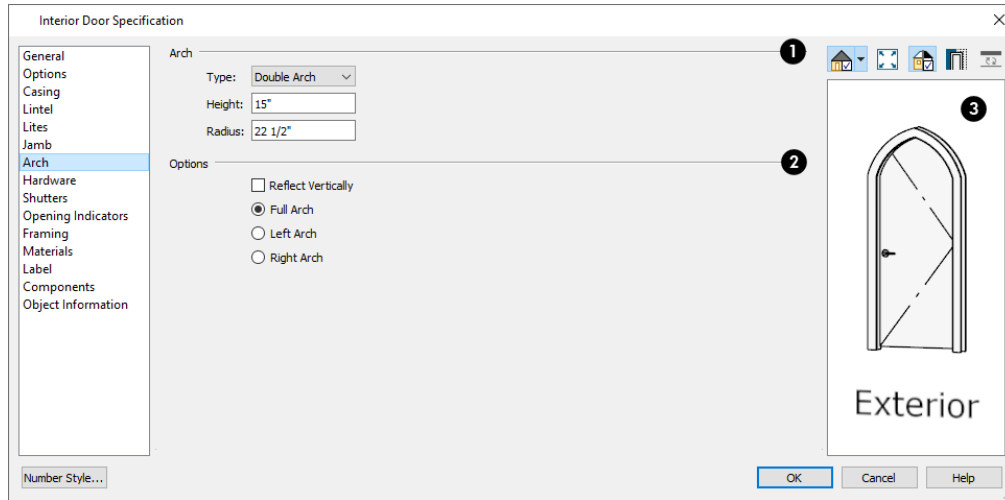

1 Arch

Define the style and size of the **Arch**.

- Select a **Type** of arch from the drop-down list.
- Specify the **Height** of the arch, as measured from the base of the arch to the top of the door. Not available for Round Top and Octagonal Arches.
- The **Radius** can also be defined for Tudor and Double Arches.

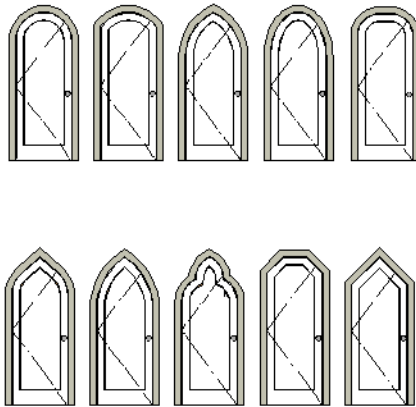

2 Options

Define the orientation of the arch.

- Check **Reflect** to reflect the arch, top to bottom. This is typically used with windows rather than doors. Not available if a lintel is specified for the selected door. See *Lintel Panel on page 384*.
- Select **Full Arch** to produce an arch with the apex at the door’s center.
- Select **Left Arch** to produce an arch with the apex on the door’s right side.
- Select **Right Arch** to produce an arch with the apex on the door’s left side.

Note: The Left and Right settings here on this panel refer to the door or window as viewed from its exterior.

3 Preview

A preview of the door displays on the right side of the dialog box. See *Dialog Preview Panes on page 20*.

HARDWARE PANEL

Many of the settings on the HARDWARE panel are Dynamic Defaults: if “Use Default” is selected, the setting in the Door Defaults dialog for the selected door’s Type is used. See *Dynamic Defaults on page 55*.

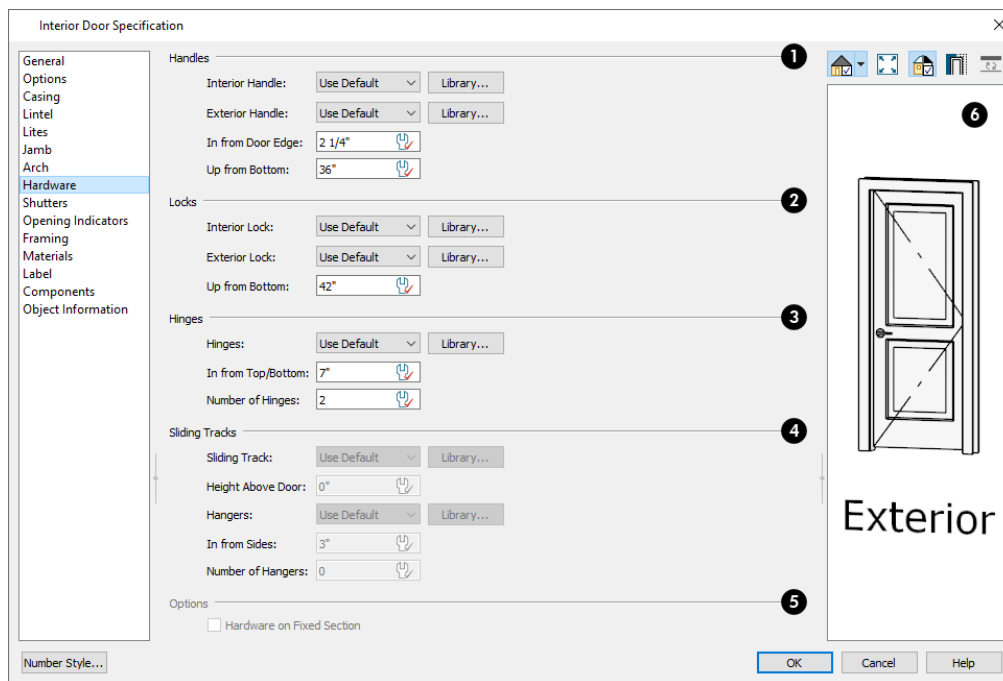

1 Handles

Specify the **Handles** to be used on the selected door.

- Select an **Interior Handle** and/or **Exterior Handle** from the drop-down lists. Select “Library” or click the **Library** button to select a handle from the library. See *Select Library Object Dialog on page 688*.
- Specify the location of the door handles **In From Door Edge**.
- Specify the location of the door handles **Up From Bottom**.

2 Locks

Specify the door's interior and exterior **Locks**.

- Select an **Interior Lock** and/or **Exterior Lock** from the drop-down lists. Select "Library" or click the **Library** button to select a lock from the library.
- Specify the location of the door locks **Up From Bottom**. The locks use the same In From Door Edge value as the handles.



To use the same handle and lock on both sides of a door, select "Match Interior" as the Exterior option.

3 Hinges

Specify the **Hinges** to be used on the selected door.

- Select a style of **Hinges** from the drop-down list. Select "Library" or click the **Library** button to select a hinge style from the library.
- Specify the distance **In From Top/Bottom** of the door to the center of the top and bottom hinges.

Note: For hinges to look right, it is best to have at least a 1/4" (6 mm) reveal for the interior, or hinge side, door casing.

- Specify the **Number of Hinges** on the selected door. Interior hinged doors and bifold doors typically have two hinges while exterior hinged doors have three.

4 Sliding Tracks

Specify the **Sliding Tracks** to be used on the selected Barn Door.

- Select a **Sliding Track** from the drop-down list. Select "Library" or click the **Library** button to select a track from the library. See [Select Library Object Dialog on page 688](#).
- Specify the track's **Height Above Door**.
- Select a style of **Hangers** from the drop-down list. Select "Library" or click the **Library** button to select a hanger from the library.
- Specify the distance **In From Sides** of the door to the center of the outermost hangers.
- Specify the number of **Hangers** to be evenly spaced along the door.

5 Options

Check **Hardware on Fixed Section** to include handles, locks, and hinges on the fixed side of a double Hinged door. Only available for Double Doors with Left or Right Swing Only selected. See [Options Panel on page 381](#).

6 Preview

A preview of the door displays on the right side of the dialog box. See [Dialog Preview Panes on page 20](#).

SHUTTERS PANEL

The settings on the SHUTTERS panel of the Door Specification dialogs are also found on the Shutters panel of the Window Specification dialog. See [Shutters Panel on page 389](#).

OPENING INDICATORS PANEL

The settings on the OPENING INDICATORS panel control the appearance of the selected hinged or sliding door's opening indicator in camera views using the Vector View Rendering Technique. These settings are also available for windows and cabinets. See *Opening Indicators on page 370*.

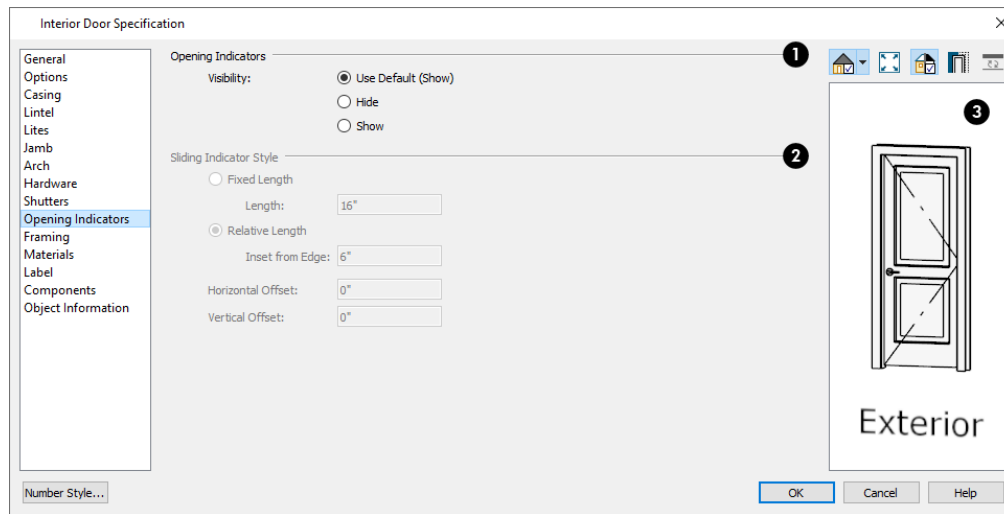

1 Opening Indicators

Specify whether the selected door's opening indicators display.

2 Sliding Indicator Style

Available for Sliding, Pocket, Barn, and Garage doors, as well as Single Hung, Double Hung, and Sliding windows. Sliding indicator arrows display centered over all movable door panel(s) or window component(s).

- Select **Fixed Length**, then specify the desired **Length** of the indicator arrow in the text field.
- Select **Relative Length** for an indicator arrow sized relative to the movable component it is drawn over.
- Specify the **Inset from Edge**, which is the distance of each end of the indicator arrow line from the adjacent edge of the associated door panel or window component. If a panel or component is not wide or tall enough to accommodate the Inset distance on both ends of the arrow line, this value will be ignored and an arrow 10" (250 mm) long will be used.
- Specify the **Horizontal Offset**, which allows you to offset the arrow line to the right or left using a positive or negative value.
- Specify the **Vertical Offset**, which allows you to offset the arrow line upwards or downwards using a positive or negative value.

3 Preview

A preview of the door displays on the right side of the dialog box. Opening indicators only display in Vector Views. See *Dialog Preview Panes on page 20*.

FRAMING PANEL

The settings on the FRAMING panel control how the selected door or doors is framed. A similar panel is also found in the Window Specification dialog. See *Window Specification Dialog on page 404*.

 Home Designer is dependent upon user input and does not calculate loads or perform structural analysis. Always consult your local building authorities and contact a licensed engineer for structural calculations.

1 Header

Specify the characteristics of the selected door's header. See [Headers on page 607](#).

- Uncheck **Include Header** to prevent a structural header from generating when wall framing is created. When this box is checked, a header as defined below is generated; when it is unchecked, a single, non-structural, horizontal framing member of the same type as the wall studs is created above the door opening.
- Select the header's framing member **Type** from the drop-down list. See [Structure Types on page 636](#).
- Specify the **Thickness** of each header framing member.
- Specify the **Count**, which is the number of the framing members used to create the header. Up to 10 header boards can be specified, but only those that fit within the wall's framing layer will be generated when wall framing is created.
- Specify the vertical **Depth** of the header. This value does not include the top and bottom chords of a Box Header.
- In the Door and Window Defaults dialogs, an additional **Calculate from Width** check box is available. When checked, the header Depth is automatically calculated based on settings in the Framing Defaults dialog and the door's current width. See [Openings Panel on page 620](#).
- Check **Box Header** to add horizontal top and bottom rails above and below the vertical rails. These horizontal boards are not included in the header Depth. See [Headers on page 607](#).

2 Trimmers

Specify the number of trimmers to be generated on each side of the selected door.

3 Rough Opening

- Specify the amount to add to **Each Side**, the **Top** and the **Bottom** for the door's framed rough opening. The rough opening should be large enough to accommodate the door frame and space for shims. Window frames do not need to be included in the rough opening: only shim space. If the Bottom Rough Opening value is greater than the Floor to Bottom value, the difference is added to the top of the rough opening when framing is built.

4 Add for Concrete Cutout

- Specify the amount to add to **Each Side** of the door opening when the upper part of the door is in a framed wall and the lower part is located in a concrete or masonry wall, stem wall, or garage curb. See *Wall Type Definitions on page 256*.
- Uncheck **Show in Plan** to suppress the display of the concrete cutout in plan views. A concrete cutout will only display in plan views if it is located in a garage curb. See *In Plan Views on page 369*.

5 Sill

When the bottom of a door is raised sufficiently off the floor, it will require a sill as part of its framing.

- Specify the **Thickness**, which is the vertical thickness of the sill board.
- Check **Double Bottom Sill** to generate two bottom sill members of the specified thickness instead of one.

MATERIALS PANEL

The MATERIALS panel is available for a variety of objects throughout the program. For more information, see *Materials Panel on page 716*.

LABEL PANEL

Door labels display in plan view when the “Doors, Labels” is turned on and use the Text Style assigned to that layer. See *Door Labels on page 371*.

For information about the settings on this panel, see *Label Panel on page 363*.

COMPONENTS PANEL

The information on the COMPONENTS panel can be used in the materials list. For more information, see *Components Panel on page 921*.

OBJECT INFORMATION PANEL

The information entered on the OBJECT INFORMATION panel can be used the materials list. For more information, see *Object Information Panel on page 922*.

MANUFACTURER PANEL

The MANUFACTURER panel provides contact information for the selected door's manufacturer. Only available for doors from Manufacturer library catalogs. See *Manufacturer Catalogs on page 677*.

Windows

Chapter 16

Home Designer can model a wide variety of windows. Fixed glass, hung, casement, sliding, awning, hopper, and louver window styles can all be created with the standard Window tool. The shape of a window can be angled or made into a round top or other arch styles. Home Designer can create bay, box, and bow windows with a single click. In addition, the library contains many mullied window combinations.

TOPICS

Window Defaults	394
Window Tools	394
Special Windows	396
Grouped Windows	398
Window Levels	399
Displaying Windows	401
Editing Windows	403
Window Specification Dialog	404
Bay, Box, and Bow Windows	422
Bay, Box, Bow Windows and Roofs	424
Bay/Box and Bow Window Specification Dialogs	426

Window Defaults



Default Settings can be accessed by selecting **Edit> Default Settings**. Select Window from the Default Settings dialog and click the **Edit** button.

You can also double-click the **Window Tools**  parent button to open the Window Defaults dialog.

The settings in the Window Defaults dialog control the attributes of a window when it is initially placed in a plan, so you should define the type of window that will be placed most often in your model. See [Default Settings on page 54](#).

The panels in the Window Defaults dialog are similar to those found in the Window Specification dialog, with one exception:

On the **GENERAL** panel of the Window Defaults dialog, you can specify the **Minimum Separation** between window and/or door units in the plan.

Minimum Separation:

The **Minimum Separation** value in the Window Defaults dialog specifies how close window and/or door units can be to each other. This setting also determines the width of the shared casing between windows.

For more information, see [Window Specification Dialog on page 404](#).

DYNAMIC WINDOW DEFAULTS

A variety of window default values are dynamic, including the **Window Type**, **Add for Rough Opening** values, **Casing**, **Lintel** and **Sill Specifications**, **Sash** and **Frame** sizes, and **Treatments**. All **Materials** are also dynamic. When a dynamic default is changed, existing windows using the default value are affected. See [Dynamic Defaults on page 55](#).

WINDOW FRAMING

The defaults for window framing can be defined in the Window Defaults dialogs. You can also specify an additional amount to cutout for window openings in concrete walls when the upper part of the window is located in a framed wall. See [Framing Panel on page 421](#).

Window Tools



To place a window, select **Build> Window** and choose the desired Window Tool. Move your mouse pointer over a wall section, then click to place a window in the wall at that location.

- If there is room enough along the wall to fit a 6" (150 mm) wide Standard Window, a preview of the window will display and a window can be placed.
- The Bay, Box, and Bow Window tools do not have preview outlines. If a minimum width of 30" (725 mm) cannot be accommodated at the location where you click, a warning message will display and a window unit will not be created.

Standard Windows, Passthroughs, and Wall Niches can be placed in both straight and curved walls, as well as span across straight, collinear wall segments. In contrast, a Bay, Box, or Bow Window can only be placed in a single, straight wall.

Windows can also be placed in the Pony Walls; however, if the upper wall is a Railing, only Windows, Passthroughs, and Wall Niches can be placed provided that they are located entirely within the lower wall. See [Pony Walls on page 232](#).

Windows cannot be placed in a wall specified as Invisible or if the wall in question is on a locked layer. See [Locking Layers on page 125](#). See [Room Dividers and Invisible Walls on page 233](#).

STANDARD WINDOWS

 Select **Build> Window> Window**, then click on a straight or curved wall to place a Standard Window at that location.

A Standard Window is a single window that is not a bay, box, bow window, a corner window or a blocked unit. These special types are made up of multiple Standard Windows.

A Standard Window that is part of a special window is called a Component Window.

Standard Windows can be specified as any of a variety of window types, such as double hung, casement and awning. See *Window Specification Dialog on page 404*.

BAY WINDOWS

 The roof is affected by Bay, Box and Bow Windows. These windows should therefore be placed before the roof is built.

 A **Bay Window** is composed of three wall sections, each with a single component window. The two side walls are at an angle to the main wall. Select **Build> Window> Bay Window** and click on a straight wall to produce a bay window.

When initially placed, bay windows measure 2'-2" across at the front, 4'-2" across at the back, and are 1'-0" deep. The component windows are specified in the Window Defaults dialog and their sizes adjust to fit the available space.

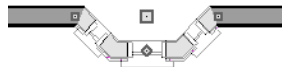

BOX WINDOWS

 A **Box Window** is a bay window with side angles set at 90°. Select **Build> Window> Box Window** and click on a straight wall to produce a box window.

Box windows initially measure 4'-2" wide with a depth of 1'-6". The component windows are specified in the Window Defaults dialog and their sizes adjust to fit the available space.

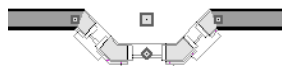

BOW WINDOWS

 A **Bow Window** is a group of identical wall segments that form a segmented curve. Select **Build> Window> Bow Window** and click on a straight wall to produce a 5-section bow window.

Bow windows can be composed of between two and twenty sections. The number of bow window components can be changed in the Bow Window Specification dialog. See *Bay/Box and Bow Window Specification Dialogs on page 426*.

The component windows are specified in the Window Defaults dialog. Their sizes adjust to fit the available space.

The 5-section bow below has a 4'-10" radius centered 3'-9" inside the wall, giving an opening 5'-10" across and a depth of 11½".

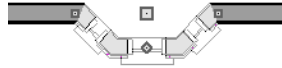

Note that for a bow with an odd number of sections, the radial dimension is from the center of the arc to an outside corner where two window sections join. The depth (11 ½”) is measured to the flat area of the center section, not to a corner. As a result, the radius is a bit greater than the sum of the depth and the distance from the center of the bow’s curve to the exterior of the wall.

Note: Bay, box, and bow window areas are not included in the living area or in room standard area calculations. They are included in room interior area calculations.

PASS-THROUGHS

 Select **Build> Window> Pass-Through**, then click on a straight or curved wall to place a Pass Through at that location.

A Pass-Through is simply a wall opening without a window unit placed inside. Like a window, it can have casing and a sill. It does not, however, have a sash, frame, or glass. It is one of the window **Types** available in the Window Specification dialog. See [General Panel on page 404](#).

WALL NICHE

 Select **Build> Window> Wall Niche**, then click on a straight or curved wall to place a Wall Niche at that location.

A Wall Niche is a wall opening that does not extend through the entire depth of the wall. You can specify the niche’s depth in the Window Specification dialog. See [General Panel on page 404](#).

WINDOWS LIBRARY

 Select **View> Library Browser**, then browse to Home Designer Core Catalogs> Architectural> Windows to access a selection of special window units. Select the desired window, then click on a wall to place the window at that location.

Special Windows

A variety of special windows can be created using multiple standard windows, the edit tools or custom symbols.

CREATING MANUAL BAY, BOX AND BOW WINDOWS

Sometimes it is easier to draw bay, box and bow windows manually than to use the automatic tools. Bays created using walls can have more than one window per section, which is not possible using a bay window unit.

Bear in mind that moving a manually created bay, box or bow window is generally more difficult than moving a unit created with one of the **Window Tools**  since it is composed of individual walls.

CORNER WINDOWS

To create a corner window, first create the desired window on each side of the corner. For best results, the heights, casing, and sills of both windows should be the same. For glass that meets at the corner:

- Specify both windows as **Fixed Glass**.
- Use each window's Move edit handle to position it all the way in the corner. To do this, drag the Move handle past the corner and parallel to the wall that the window is placed in. When the preview outline moves into the middle of the wall corner, release the mouse button.
- You can also position a window in a corner using its end Resize handle.
- Uncheck **Has Corner Post** in the Window Specification dialog. See [Frame Panel on page 412](#).



Angled top, or shaped windows can be components of corner windows as long as their heights are equal at the corners. Windows with single or two segment tops can be used, but windows with three cannot. If a two segment window is used, the segment nearest the corner must be flat.

When a corner post is required, there are a number of ways to control its size.



- Use dimensions to position the windows relative to the corner. By default, windows will stop when their interior casing bumps into the adjacent wall. See [Editing Windows on page 403](#).
- To move a window all the way into a corner, check **Ignore Casing for Opening Resize**. See [General Plan Defaults Dialog on page 56](#).
- To produce a minimal corner post and no siding or casing between the windows, use their Move edit handles. Click and drag each window past the exterior corner until its preview outline moves into the middle of the wall corner.

SPECIAL WINDOW SHAPES

A selection of special shaped windows is available in the Windows Library, including arched windows and mullied units.

In addition, you can create a wide variety of window shapes in the Window Specification dialog, including:

- Arched windows. See [Arch Panel on page 418](#).
- Trapezoidal windows. See [Shape Panel on page 416](#).

RECESSED WINDOWS

A window or muller unit placed in a brick or stone wall is often recessed into the wall's exterior, so the brick wraps the opening.

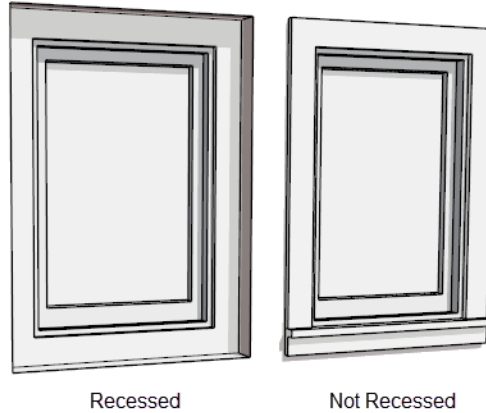

You can specify a window as recessed in the Window Specification dialog. See [Options Panel on page 406](#).

PLACING A GABLE OVER A WINDOW



Click the **Gable Over Door/Window** edit button to produce a gable roof over the selected window(s) the next time automatic roofs are built. See [Gable/Roof Lines on page 590](#).

You can manually edit or delete this gable line at any time. Your changes take effect when the automatic roofs are rebuilt. This tool can also be used with group selected windows.

STAINED GLASS

A selection of solid stained glass materials is available in the Home Designer Core Catalogs> Materials> Glass library. See [Materials on page 711](#).

VENTS

A selection of attic, foundation and gable vents are available in the Library Browser. See [The Library on page 668](#).

Vents are placed in the same manner as regular windows and can be edited in much the same way, as well.

Grouped Windows

Windows can be grouped together to create a wide variety of custom configurations. Stacked windows are easy to create in 3D views, particularly cross section/elevation views, using their edit handles. See [Editing Windows on page 403](#).



Notice how the windows and door in this example are separate, with spaces between them. Doors and/or windows can also be positioned so that there are no spaces between the windows and door units, and the casing between them appears to be shared. To help organize their display in plan view, you can place stacked windows of varying heights on different Window Levels. See [Window Levels on page 399](#).

AUTOMATICALLY MULLED OPENINGS

To form a mulled group of windows and/or doors, move them close enough together so that their casings touch. Once the casings touch, the windows are mulled together with one casing between the two of them.

The sill of each window in the group must be at the same level for them to share the middle casing; however, the casing tops do not. The casings are modeled as if they are one unit but the windows remain separate objects for dimensioning and the Materials List.

Windows can be automatically mulled to doors if the bottom of the window is at the elevation of the floor, equal to the bottom of the door.

The **Minimum Separation** value in the Window Defaults dialog specifies how close window and door units can be to each other. This setting also controls the width of the shared casing between adjacent windows. See [Window Defaults on page 394](#).

MULLED UNITS IN THE LIBRARY



A selection of mulled window units is available in the Windows library. To place one in your plan, select it and click on a wall in any view. See [Placing Library Objects on page 686](#).

MULTIPLE STACKED OPENINGS

If four or more multiple windows or doors occupy the same space in a wall, a Caution ⚠ symbol will display at the problem location in plan view.

Click on the Caution ⚠ symbol that displays over the wall to open a contextual menu, then select **Delete Duplicate** to delete a duplicate opening. When no more Caution symbols remain, you should then confirm that the remaining three openings meet your needs and delete any that are unnecessary.

Window Levels

It is often necessary to position more than one window, mulled unit, and/or door at the same location along a wall in plan view: for example, to create an entry with side lites and transom.

To help control and organize the appearance of stacked wall openings in plan view, you can assign windows at various heights to different **Window Levels**.

Window Levels do not define the height of a window, just the appearance and behavior of windows and doors in plan view.

- In plan view, windows and doors on the **Default Level** display the line color and style of the layer they are on. See [Layers on page 123](#).
- Windows on any other level appear light gray, regardless of the layer they are on.

THE DEFAULT LEVEL

The **Default Level** is the Window Level that Standard Windows are initially placed on when created and affects several things:

- In plan view, windows and doors on the **Default Level** display the line color and style of the layer they are on.
- When you click on stacked doors and windows in plan view, those on the Default Level are selected first. To select an opening on another level, use the **Select Next Object**  edit button. See [Select Next Object on page 143](#).

Typically, the Default Level is set as 0 (zero).

WINDOW LEVEL ZERO

Window Level 0 (zero) is the level that all bay, box and bow windows and doors are always placed on. Typically, it is also the Default Level that standard windows are placed on, as well.

Because doors are always on Level 0 and because Window Levels affect line colors in printouts, it is usually best to keep the Default Level at 0. If you do change the Default Level, remember to change it back before printing.

If you specify the Default Level as a value other than zero and then place a window in your plan, it will not use all Window Defaults settings. Instead:

- The program will position it above any windows that are at the same location but on a lower level rather than use the default Floor to Top height;
- Its Type will be Fixed Glass;
- Its Height will be 12” (300 mm);
- It will have no Sill.

Once the window is created, its parameters can be changed. See [Editing Windows on page 403](#).

USING WINDOW LEVELS

The door and windows in the illustration below were created on different Window Levels.

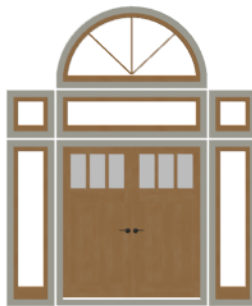

To stack windows using Window Levels

1. Place the door and side lites on Window Level Zero.
2. Open the Window Defaults dialog and change the Default Level to 1.
3. Place the second row of windows above the door and side lites on Level Zero. The program will automatically position fixed glass windows above the door and side lites.
4. Edit these fixed glass windows' Widths and other attributes as needed.
5. Open the Window Defaults dialog and change the Default Level to 2.
6. Place the top window above the others. The program will place a fixed glass window above the windows on Level 1.
7. Edit this window's Arch and other attributes as needed.
8. When you are finished, open the Window Defaults dialog and change the Default Level back to 0.

Displaying Windows



The display of windows, openings, casing, headers, and window labels in floor plan and 3D views can be controlled in the Layer Display Options dialog. See [Layer Display Options Dialog on page 126](#).

If the “Windows” layer is not set to display, window casing and other components are not visible, but the openings in the walls where they are located can still be seen.

Windows can only be placed in walls, so if a wall's layer is turned off in plan view, any windows placed in that wall will not display, either. Windows can display independent of their containing walls in 3D views, however. See [Displaying Walls on page 240](#).

IN PLAN VIEW

A window's frame, glass, casing, and sill are all represented in plan view. This makes some window types, notably Sliding and Double and Triple Casement windows, distinguishable.

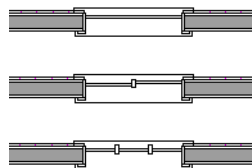

Interior and exterior window casings will display in all views when the “Casings, Exterior” and “Casings, Interior” layers are turned on. In plan view, the sills and vertical side casings will be shown, but the horizontal top casing or lintel will not. If a window is recessed, the affected wall layers will adjust to accommodate the casing.

When the “Opening Header Lines” layer is turned on in plan view, headers are represented by dashed lines within each window. These lines do not correspond to actual framing objects and cannot be selected. In addition, header framing members can be set to display. See [Wall Framing on page 606](#).

If a window is placed in a Garage room at a height where it extends into the stem wall or curb, a cutout in the concrete will display on the floor below. You can specify the cutout's size and whether it displays in plan view in the Window Specification dialog. See [General Panel on page 404](#).

By default, when a window is located entirely in one part of a pony wall, and that part is not displayed in plan view, the window's outline is shown but the wall's layer lines and fill drawn through it. You can instead display windows in the non-displayed parts of pony walls the same as in the displayed parts, or not at all. See *Pony Wall Defaults on page 225*.

Bay, box, and bow windows have dimensions lines associated with them.

- You can suppress their display by turning off the "Manual Dimensions" layer or on a unit by unit basis in the unit's specification dialog. See *Bay/Box and Bow Window Specification Dialogs on page 426*.
- The arrow style and fill are set in the Dimension Defaults dialog. See *Dimension Defaults Dialog on page 313*.

IN 3D VIEWS

In 3D Vector Views, windows can display opening indicator arrows. See *Opening Indicators on page 370*.

You can also specify whether window and door glass is opaque or transparent in the Rendering Technique Options dialog. See *Rendering Technique Options on page 787*.

When displayed as opaque, window and door glass uses the Material Color set in the Define Material dialog. See *Pattern Panel on page 727*.

WINDOW LABELS

Window labels display in floor plan view, centered on the windows they represent, when the "Windows, Labels" layer is turned on and use the Text Style assigned to their layer. Similarly, Wall Niche labels display in the same manner when the "Wall Niches, Labels" layer is turned on. See *Label Panel on page 363*.

Automatic window and niche labels indicate Width and Height, followed by Type. For example:

- In U.S. Unit plans, the automatic label for a 3'-0" wide, 4'-0" high double hung window will read 3040 DH.
- In metric plans, the automatic label for a 900 mm wide, 1200 mm high double hung window will read 900x1200 DH.

You can specify whether a Bay, Box or Bow Window displays a single label or displays the labels of its component windows. See *Bay, Box, and Bow Windows on page 422*.

- When **Suppress All Labels** is selected, individual components of Bay, Box and Bow Windows are counted in the Materials List.
- When **Show Component Labels** is selected, components of Bay, Box and Bow Windows are counted in the Materials List.
- When **Show Single Label for Entire Unit** is selected, the Bay, Box or Bow Windows has one label in plan view but each component is counted separately in the materials list.

These options are also available for mullied units but affect their display the materials list somewhat differently. See *Displaying Mullied Units*.

Customized labels can also be specified in the Window Specification dialog.

IN THE MATERIALS LIST



The materials associated with windows are listed under different Categories in the Materials List:

- **Windows** - Lists windows units, including Passthroughs.
- **Interior Trim** - Lists interior casing, lintels, aprons, and sills.
- **Exterior Trim** - Lists exterior casing, lintels, aprons, sills, and shutters.
- **Wall Board** - Lists the backerboard associated with Wall Niches.

As with other objects, there are a number of ways to control how, or whether, windows are included in the Materials List. See [Organizing Materials Lists on page 908](#).

You can add and edit information about a window's accessories in the Window Specification dialog. See [Components Panel on page 921](#).

Editing Windows

Before a window can be edited, it must be selected. Click on a window when the **Select Objects**  tool or any of the **Window Tools**  are active. Doors and/or windows can also be group-selected and edited. See [Selecting Objects on page 141](#).

To select a window that is part of a blocked unit, click the component window, then click the **Select Next Object**  edit button. See [Selecting Components of Mulled Units](#).

Once selected, windows can be edited using their edit handles, the Edit Toolbar buttons, and their specification dialogs.

USING THE EDIT HANDLES

In plan view, click either of the two end handles and drag along the wall to change the width. The label showing the size updates as the window is resized.

In 3D views, a selected window has five edit handles: the Move handle at the center and a Resize handle on each edge. Click and drag an edge handle to resize the window.

Using the edit handles, a window resizes according to the currently active **Edit Behavior** . See [Defaults, Preferences, and Edit Behaviors on page 137](#).

A single window or a group of windows can be moved with the center edit handle.

A door or window moved against an intersecting wall temporarily stops when it is the casing distance from the intersecting wall. Enable **Ignore Casing for Opening Resize** in the Plan Defaults dialog to turn off this behavior. See [General Plan Defaults Dialog on page 56](#).

You can continue to drag the selected window and it will resume movement past or onto the intersecting wall.

To create a corner window, drag the Move handle straight out past the wall corner, parallel to the selected window's wall. See [Corner Windows on page 397](#).

IN THE SPECIFICATION DIALOG

 The most precise method of editing an individual window or group of windows is to use the Window Specification dialog. The window type, size, casing, materials, shape, and more can all be specified in this dialog. See [Window Specification Dialog on page 404](#).

USING THE EDIT TOOLS

A selected window or windows can be edited in a variety of ways using the buttons on the Edit Toolbar. See [The Edit Toolbar on page 91](#).



Gable Over Door/Window creates a gable over the selected window(s) the next time the roof is rebuilt. See [Gable/Roof Lines on page 590](#).



Change Wall Side moves a selected Wall Niche to the opposite side of the wall. See [Wall Niches on page 396](#).

USING DIMENSIONS



Like various other objects, windows can be moved using dimensions. See [Moving Objects Using Dimensions on page 332](#).

You can specify how windows and doors are located by dimensions in the Dimension Defaults dialog. Dimensions can be set to locate the centers, sides, casing, and/or rough openings of windows and doors, or you can choose to not locate them at all. See [Locate Manual Panel on page 315](#).

Once a dimension line has been drawn, you can move or add its extension lines to locate non-default locations on a window. See [Editing Extension Lines on page 329](#).

WINDOW CASING, SILLS, AND MILLWORK

Windows often feature casing, or trim, on both sides of the wall opening as well as a sill on one or both sides. See [Applying Moldings on page 665](#).

The default casing for windows is a basic rectangular stock profile. You can specify a window's casing profiles in the Window Specification dialog, or you can choose to suppress casing altogether. See [Casing Panel on page 408](#).



A separate molding profile can be specified for the lintel, or top horizontal molding. A sill profile can be specified, as well. See [Lintel Panel on page 410](#).

Additional millwork items can be applied above and below the window's casing on its exterior side. See [Treatments Panel on page 418](#).

Each of these objects can be replaced with a different profile or object directly from the library in 3D views. Select a molding profile or millwork item, then click on the window component you want it to replace. See [Replace From Library on page 689](#).

Window Specification Dialog



To open the Window Specification dialog, select a window or a group of windows and click the **Open Object** edit button; or double-click the window using the **Select Objects**  or a **Window**  tool.

The settings in this dialog are similar to those in the Window Defaults dialog. See [Window Defaults on page 394](#).

The settings in this dialog are also similar to those in the Wall Niche, Muller Unit and Window Symbol Specification dialogs. Although similar, a number of the options cannot be edited when either a window symbol or a muller unit is selected, and some panels are not available. See [Grouped Windows on page 398](#).

The panels that are available in the Window Specification dialog will vary depending on whether the selected window is a regular window or a muller unit or symbol object from the library.

GENERAL PANEL

In the Wall Niche Specification dialog, only the **Size and Position** settings on this panel are available. See [Wall Niches on page 396](#).

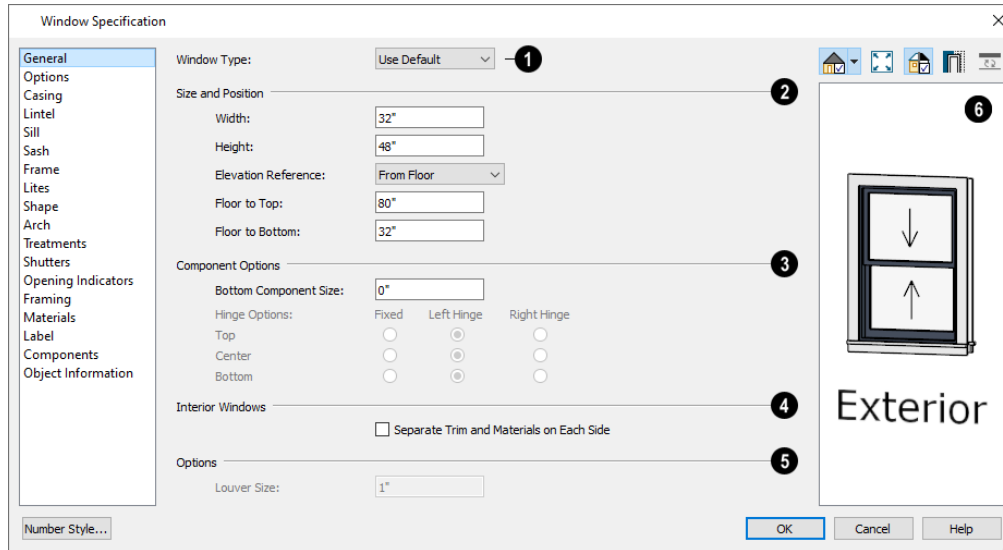

1 Window Type

Select the type of window from the list. The first entry in the list is the “Use Default”, which is set in the Window Defaults dialog.

2 Size and Position

- Specify the window’s **Width** and **Height**. These values include the window frame.
- Select the **Elevation Reference** from the drop-down list. This determines where the next two settings are measured from and also affects their setting labels.
- Specify the height **to Top**, measured from the selected Elevation Reference to the top of the window frame.
- Specify the height **to Bottom**, measured from the selected Elevation Reference to the bottom of the window frame.
- Specify the **Depth** of the selected Wall Niche, measured from the wall surface to the back of the niche. Only available for Wall Niches.

Note: When either the Floor to Top or Floor to Bottom setting is modified, the other will adjust in response to prevent the window’s Height from changing.

3 Component Options

These settings affect windows with movable sections and are not available for Pass-Throughs, Fixed glass windows, mullied units, or window symbols.

- Specify the **Bottom Component Size** for Single Hung, Double Hung, Double Awning, Double Hopper, and Triple Hopper windows; specify the **Top/Bottom Component Size** for Triple Awning windows; or,
- Specify the **Side Component Size** for Triple Casement and Triple Sliding windows, the **Right Component Size** for Left Sliding windows, or the **Left Component Size** for Right Sliding and Double Casement windows. A **Component Size** value of 0 creates a window with identically sized components.
- Specify how each **Component Opens** from the available options. Only available for Casement, Double and Triple Awning, and Double and Triple Hopper windows.

4 Interior Windows

These settings are only present when the selected window is a Pass-Through placed in an interior wall. See [Exterior and Interior Walls on page 230](#).

- Check **Separate Trim and Materials for Each Side** to specify the casing, lintels, sills, and all materials for each side of the selected Pass-Through independently. When unchecked, the two sides use the same trim and materials.

5 Options

- **Louver Size** - Specify the vertical height of the selected window's louvers. Only available for Louvered and Glass Louver windows.

6 Preview

A preview of the selected window displays here. A label indicates which side of the window is its Interior and which is its Exterior. See [Dialog Preview Panes on page 20](#).

Window opening directions can best be seen using the Vector View Rendering Technique.

OPTIONS PANEL

The OPTIONS panel is not available in the Wall Niche Specification dialog.

The Muller Units and Mullion Depth settings on the OPTIONS panel are only available in the Muller Unit Specification dialog. See [Grouped Windows on page 398](#).

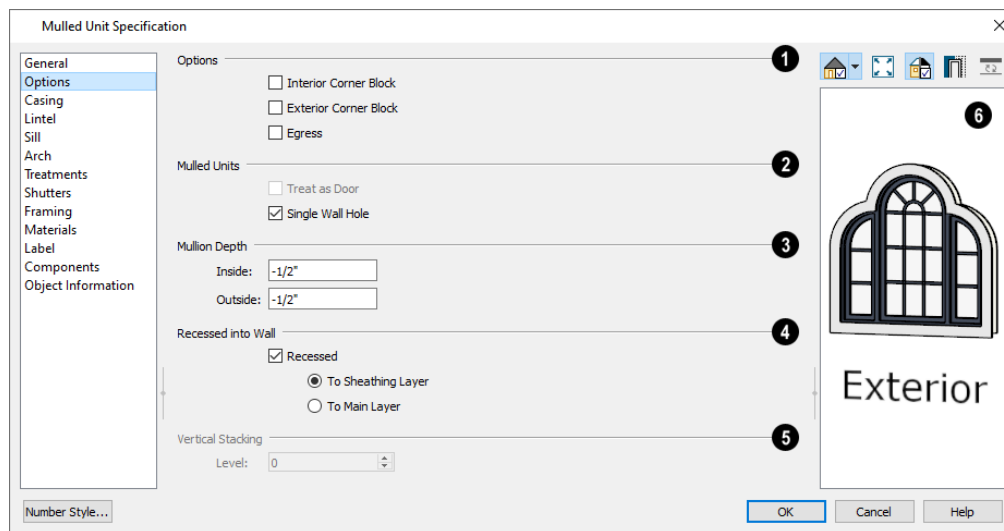

1 Options

- Check **Interior Corner Block** to count interior corner blocks in the materials list. These do not display in 3D views.
- Check **Exterior Corner Block** to count exterior corner blocks in the materials list. These do not display in 3D views.
- Check **Egress** to specify the window as an egress window in the Materials List. Not available for Pass-Throughs.



Consult your local building and fire code authorities for your local egress window requirements.

- Check **Reverse Symbol** to reverse a window symbol as though it were reflected about a vertical line through its center. Only available in the Window Symbol Specification dialog.

2 Mullied Units

Only available when a mullied unit is selected. See *Mullied Units in the Library on page 399*.

- Check **Treat as Door** to include the unit in the “Doors” category of the Materials List. Only available when the selected unit contains a door.
- Uncheck **Single Wall Hole** to produce individually framed wall openings for each unit in a mullied unit. When this box is checked, a single wall opening with one header for the entire unit is produced.

3 Mullion Depth

Specify the depth of the casing between the components of a mullied unit, measured from the wall surface. Positive values move the mullion surface towards the wall center; negative values, away from it. Only available when a mullied unit is selected.

- Specify the **Inside** depth of the mullion on the interior surface of the wall.
- Specify the **Outside** depth of the mullion on the exterior surface of the wall.

4 Recessed into Wall

These settings allow you to recess the selected window or muller unit into a wall, away from the exterior surface. Only available if the window or muller unit is in a multi-layered wall.

- Check **Recessed** to enable the options below.

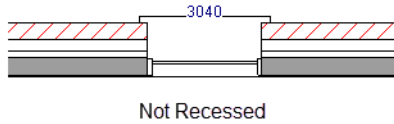

- Select **To Main Layer** to recess the window to the wall's Main Layer.

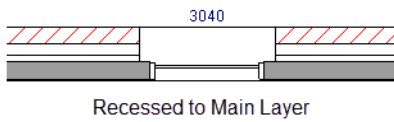

- Select **To Sheathing Layer** to recess the window to the wall's sheathing layer, which is the layer located just outside of the wall type's Main Layer(s). See *Wall Type Definitions on page 256*.

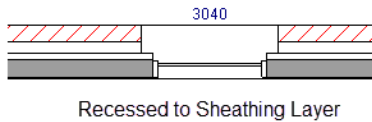

5 Vertical Stacking

- Specify the window **Level** that the selected window is placed on. Not available for muller units or window symbols. See *Window Levels on page 399*.

6 Preview

A preview of the selected window displays here. See *Dialog Preview Panes on page 20*.

CASING PANEL

The CASING panel is not available in the Window Symbol Specification dialog.

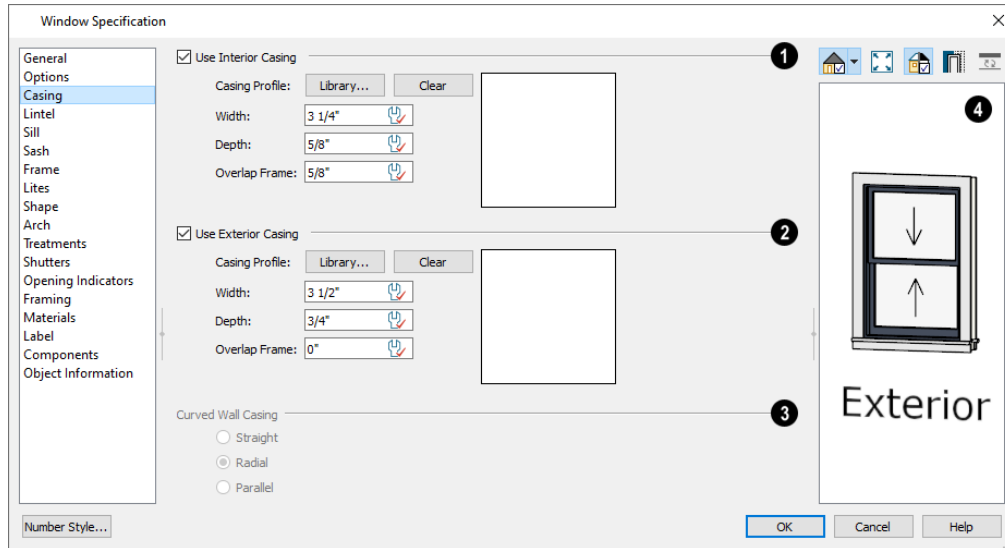

1 Interior Casing

When this box is unchecked, no casing is used and the settings that follow are disabled.

- **Casing Profile** - Click the **Library** button to select a molding profile for the casing. A preview of the casing profile displays to the right. See [Select Library Object Dialog on page 688](#).
- Click the **Clear** button to remove a selected casing profile from the window. When no profile from the library is selected, a basic rectangular stock profile is used.
- Specify the **Width** of the selected casing.
- Define the **Overlap Frame** value, which is the distance between the outside edge of the window frame and the inside edge of the casing. The default is 0", which places the inside edge of the casing against the outside edge of the frame.

Type a positive value to overlap the casing over the frame by that amount.

Type a negative value to produce a gap between the casing and the frame.

To produce a reveal of a certain width, subtract the desired reveal from the total width of the frame and type the result here.

2 Exterior Casing

If the selected window is a Pass-Through placed in an interior wall, these settings will be unavailable unless **Separate Trim and Materials on Each Side** is checked on the GENERAL panel. See [General Panel on page 404](#).

- Check **Use Exterior Casing** to apply exterior casing to the selected window and enable the settings that follow. These settings are the same as those for the Interior Casing, above. When this box is unchecked, no exterior casing is used.

3 Curved Wall Casing

These settings are only available when the selected window is placed in a curved wall. See [Drawing Curved Walls on page 238](#).

- Door and window casing and jamb can be constructed three ways in curved walls:
- **Straight** - Both window sash and casing are straight. Straight casing may not fit properly into a wall if the window is too wide or the curvature of the wall, too tight.

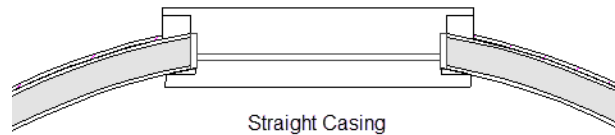

- **Radial** - The sides of the casing or jambs are inserted in the wall at an angle that passes through the center of the curve.

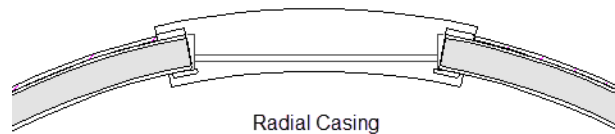

- **Parallel** - The sides of the casing are inserted in the wall at a right angle to the line tangent to the curved wall at the center of the window.

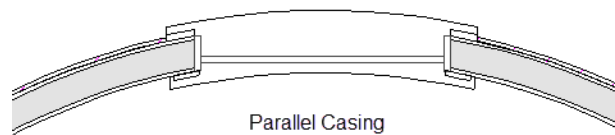

Normally, parallel casing has a straight sash. Radial casing is more like traditional curved windows, and typically has a curved sash.

4 Preview

A preview of the selected window displays here. You may need to rotate the preview to see the casing on the side of the door you are editing. If casing is not specified for a Pass-Through, the **Show Wall**  option will be toggled on automatically. See [Dialog Preview Panes on page 20](#).

LINTEL PANEL

The settings on the LINTEL panel of the Window and Muller Unit Specification dialogs are also found on the panel of the same name in the Door Specification dialog. See [Lintel Panel on page 384](#).

The LINTEL panel is not available in the Window Symbol Specification dialog.

These settings are not available if the window has a reflected arch. See [Arch Panel on page 418](#).

SILL PANEL

The settings on the SILL panel of the Window and Muller Unit Specification dialogs are not available if the window has a reflected arch. See [Arch Panel on page 418](#).

The SILL panel is not available in the Window Symbol Specification dialog.

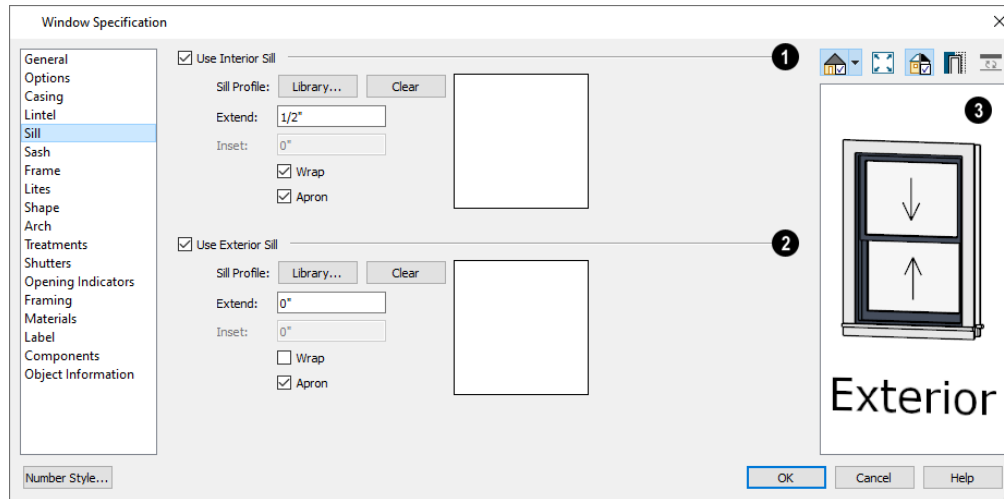

1 User Interior Sill

Check **Use Interior Sill** to enable the settings that follow, then specify the sill applied to the interior side of the selected window(s) using these settings. When this box is unchecked, no interior sill is used.

- **Sill Profile** - Click the **Library** button to select a molding profile for the sill. A preview of the selected profile displays to the right. See [Select Library Object Dialog on page 688](#).
- Click the **Clear** button to remove the selected sill profile from the window. When no library profile is selected, a basic rectangular profile is used.
- Specify how far to **Extend** the sill past the outside edges of the casing on each side. If an Apron is specified, it will also be affected by this setting.
- Specify how far to **Inset** the sill into the window. A value of 0 positions the sill profile against the surface of the wall. Only available when a sill profile from the library is selected.
- Check **Wrap** to wrap the sill profile back toward the wall.
- Check **Apron** to include an apron under the sill. When Wrap is checked, the apron will be 1/2" (12 mm) shorter than the sill on each side; when it is unchecked, it will be the same length as the sill.

2 Use Exterior Sill

Check **Use Exterior Sill** to enable the settings that follow, then specify the exterior sill for the selected window(s) using these settings. These settings are the same as those for the Interior Sill, above.

3 Preview

A preview of the selected window displays here. See [Dialog Preview Panes on page 20](#).

SASH PANEL

The settings on the SASH panel control the size and position of the selected window's sash. Note that increasing the Side, Middle, Top or Bottom Width decreases the area of the glass and vice versa.

The SASH panel is not available in the Wall Niche, Muller Unit, and Window Symbol Specification dialogs, and the settings on this panel are not available for Pass-Throughs.

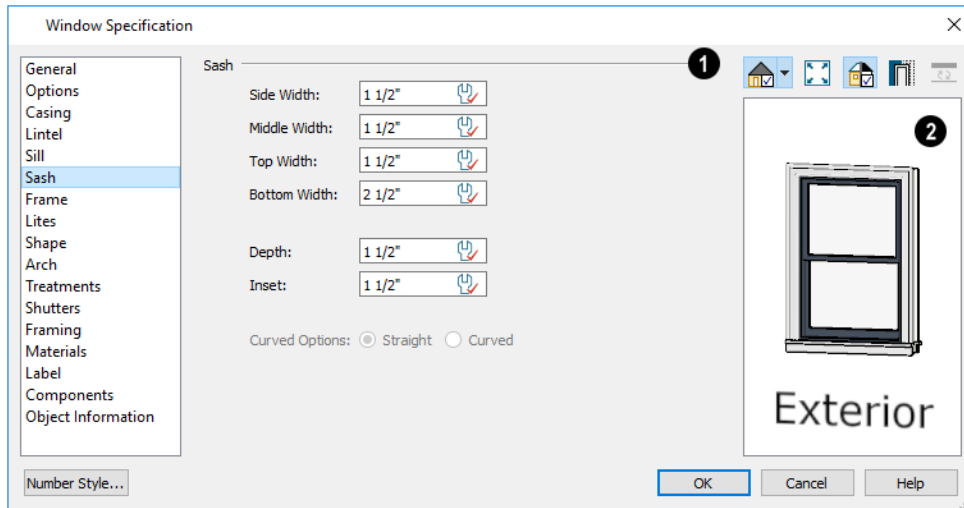

1 Sash

Specify the width and depth of the selected window’s sash, which are the pieces of the window that hold the glass; or, uncheck this box to prevent it from having a sash.

- Specify the **Side Width** of all vertical sash members: those at the window sides as well as the central members of Casement and Sliding windows. This is also the width of the top portion of the window when an arch is specified.
- Specify the **Middle** width of horizontal components between the top and bottom sash in Double Hung, Double and Triple Awning, and Double and Triple Hopper windows. It does not affect Casement and Sliding windows.
- Specify the **Top** and **Bottom Widths**. The **Top** value is not used if the window has an arch.
- Specify the **Depth**, or thickness, of the sash stock measured from the exterior to the interior.
- Specify the **Inset**, the distance between the frame and the outermost sash. If there is no frame, the inset is measured from the outer surface of the wall’s Main Layer.
- **Curved Options** - When the selected window is placed in a curved wall, specify whether it has a curved or straight sash. A curved sash is typically used with Radial casing. See [Casing Panel on page 408](#).

Radial Casing

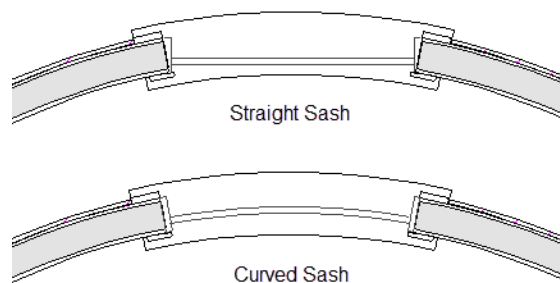

2 Preview

A preview of the selected window displays here. See [Dialog Preview Panes on page 20](#).

FRAME PANEL

The FRAME panel is not available for mullied units or window symbols from the library. The settings on the FRAME panel are similar to those on the JAMB panel of the Door Specification dialog. See [Jamb Panel on page 385](#).

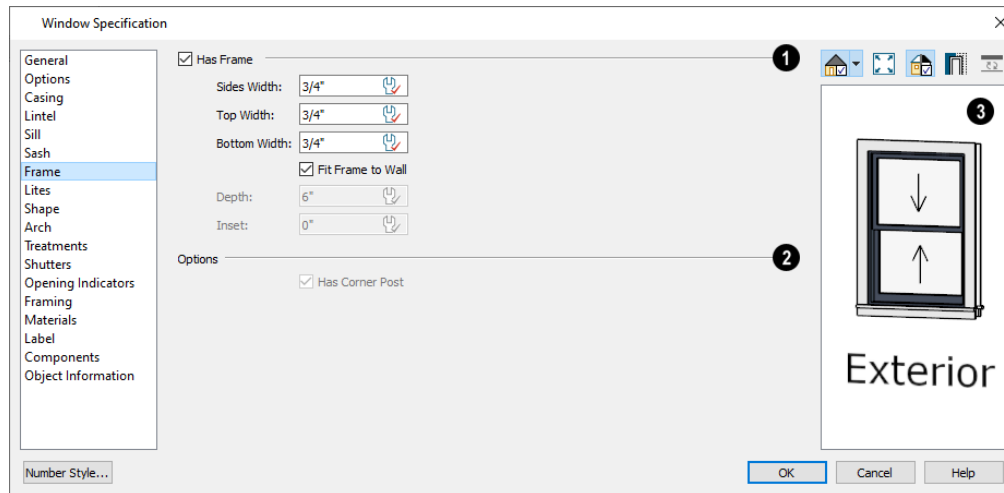

1 Has Frame

Specify the attributes of the selected window's Frame. Note that a window's frame is included in its size, while a door's jamb is not.

- Check **Has Frame** to include a frame and enable the settings below. When this is unchecked, the selected window has no frame around it.
- Specify the **Side**, **Top**, and **Bottom Widths** of the window's frame. Changing these values modifies the interior of a window but does not affect its size.
- Uncheck **Fit Frame to Wall** to specify the Depth and Inset of the selected window's frame. When this box is checked, the frame Depth automatically extends from the Recessed Into Wall layer to the wall's inside surface with an Inset of 0". The Recessed Into Wall layer is specified on the *Options Panel on page 406* of this dialog.
- Specify the **Depth** of the window frame from front to back.
- Specify the frame's **Inset**, which is measured from the Recessed Into Wall layer and moves the window frame towards its interior side. If used, the casing and lintel are not affected by this setting.

2 Options

Has Corner Post is only available when the selected Fixed glass window is one of a pair forming a corner window. See *Corner Windows on page 397*.

3 Preview

A preview of the selected window displays here. See *Dialog Preview Panes on page 20*.

LITES PANEL

The LITES panel allows you to add muntins to windows, and is also available for Glass doors. See *Doors on page 365*.

There are four possible styles of muntin bars for regular windows, plus two additional options for arched windows.

A window that has been modified using the SHAPE panel cannot have divided lites or shutters added.

The LITES panel is not available in the Wall Niche, Muller Unit, and Window Symbol Specification dialogs, and the settings on this panel are not available for Pass-Throughs.

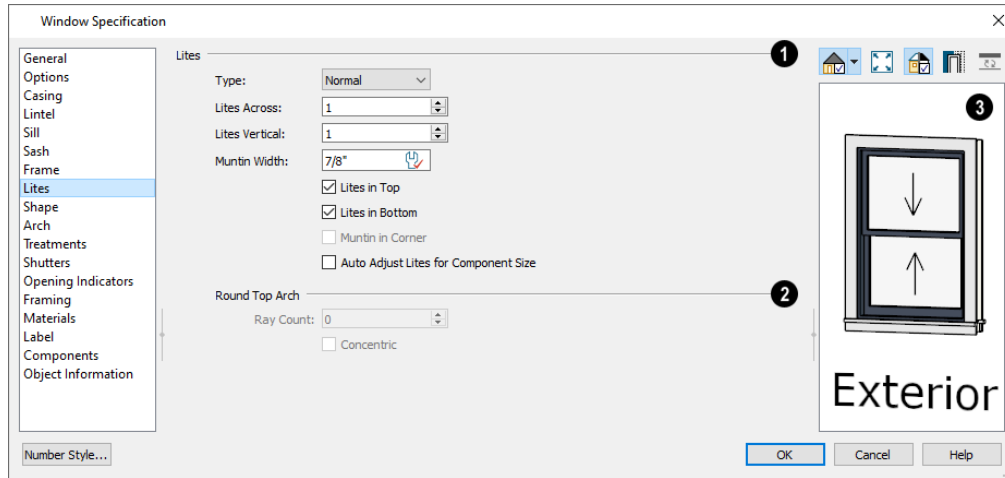

1 Lites

Specify the number, position and style of lites for the selected window.

- Select a **Type**, or style, of window lite from the drop-down list.

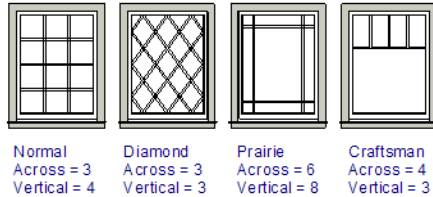

- **Normal** style is the most common, with muntins going horizontally and vertically. Colonial windows are an example of the normal style.
- **Diamond** style uses angled muntin bars to divide up the lites. French windows are an example of the diamond style.
- **Prairie** style is based on the normal style, but with all the central muntin bars removed, leaving only the two outside muntin bars both horizontally and vertically. Typically, both Lites Across and Lites Vertical should be set between 6 and 8. Federal or Federation windows are an example of the Prairie style.
- **Craftsman** style is based on the normal style, but only the topmost horizontal muntin bar is kept with all the portions of the vertical muntin bars above it. Typically, both Lites Across and Lites Vertical should be set between 4 and 8.
- Enter the number of horizontal **Lites Across** in each sash.
- Enter the number of vertical **Lites Vertical** in each sash.
- Specify the **Muntin Width**, which is the width of the bars dividing the panes of glass.
- Check or uncheck **Lites in Top** and/or **Lites in Bottom** - or **Lites in Left** and/or **Lites in Right** - to specify either one or both of the sashes to have divided lites.
- Check **Muntin in Corner** to add a vertical muntin bar where two corner windows meet. Only available when Has Corner Post is unchecked on the FRAME panel. See [Corner Windows on page 397](#).
- Check **Auto Adjust Lites for Component Size** to have the program produce lites that are consistent in size across all components. When this is checked, the window's lites and its specification settings may not agree; when unchecked, lites in the components may not be consistent in size.
- Note: Because the fixed window in a Triple Sliding window is twice the size of the movable windows, the fixed section has a vertical muntin bar. To eliminate this, uncheck Auto Adjust Lites for Component Size.

2 Round Top Arch

These options are only available if the window has an Arch specified.

- Specify a **Ray Count** of up to 10 radial muntin bars in the portion of the window within the arch. There is one more pane of glass than the number of rays specified. See [Arch Panel on page 418](#).
- Check **Concentric** to produce muntins radiating from a curved inner muntin that is concentric with the window's arch. You must have at least three Lites Across for this to be used.

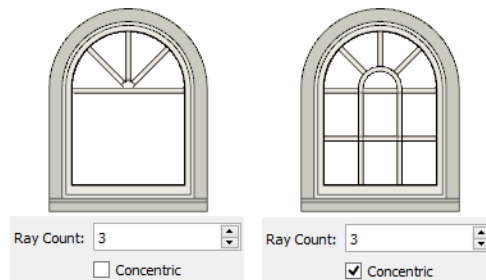

3 Preview

A preview of the selected window displays here. See [Dialog Preview Panes on page 20](#).

SHAPE PANEL

The settings on the SHAPE panel control the position of the selected window's corners, allowing you to create angled edges and mitered top corners.

If any of these settings are used to create a custom shape, the selected window will be automatically specified as "Fixed Glass" on the GENERAL panel. If the selected window has an arch specified on the ARCH panel, it will be removed.

The SHAPE panel is not available for mulled units or window symbols from the library.

Note: The Left and Right settings on this panel refer to the window's exterior.

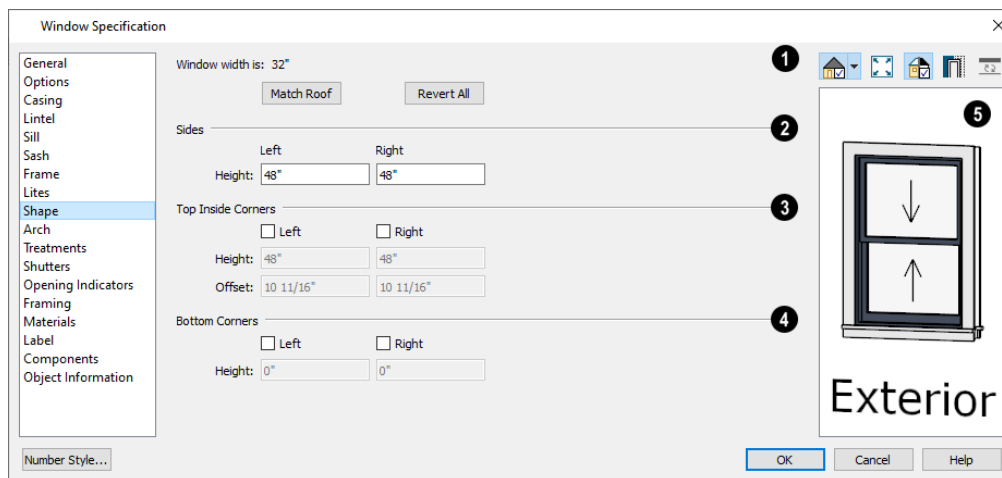

1 Window Width

The Window Width displays for reference here. It can be changed on the *General Panel on page 404*.

- Click **Match Roof** to match the angle of the top of the window to the pitch of the roof above by changing its Sides heights, below. If either Top Inside Corner box is checked, it will become unchecked.

Match Roof does not work for curved roofs, has no effect if the window is not in a gable end wall, and is not available in the Window Defaults dialog.

- Click **Revert All** to restore the window to its original shape, type and arch settings.

2 Sides

Specify the height of the window's **Left** and **Right** sides, as measured from the bottom of the window. By default, these settings match the window's Height.

3 Top Inside Corners

These settings allow you to create a second set of top corners with angled edges between them and the outside top corners.

- Check **Left** to add an additional corner along the top edge.
- Specify the **Height** of the left inner corner, as seen from the exterior, measured from the bottom of the window.
- Specify the **Offset** of the left inner corner, as measured from the left side of the window.
- An additional **Right** Inside Corner can be specified in a similar manner.

4 Bottom Corners

These settings allow you to raise the heights of the bottom corners, as measured from the bottom of the window specified on the *General Panel on page 404*.

- Check **Left** to raise the height of the bottom left corner.
- Specify the **Height** of the bottom left corner. This value cannot exceed the Height of the Left Side.

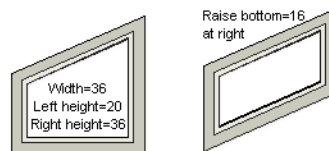

- The height of the **Bottom Right** corner can be raised in a similar manner.

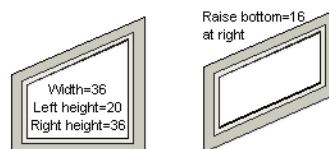

- The height of the **Bottom Right** corner can be raised in a similar manner.

5 Preview

A preview of the selected window displays here. You may want to rotate the view so the window's exterior can be seen. See [Dialog Preview Panes on page 20](#).

Note: The Left and Right settings on this panel refer to the window's exterior.

The following diagram represents added Inner corners using open circles and the left and right corners using solid black circles:

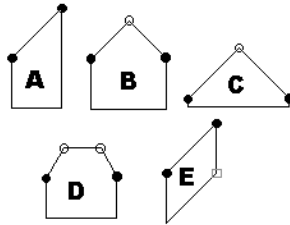

- **A** has different left and right Side Heights with no Top Inside Corner added.
- **B** has matching left and right heights with an added Top Inside Corner.
- **C** is the same as **B**, except that the left and right Side Heights have been shortened to 1/4".
- **D** is the same as **B** except it has two added Top Inside Corners.
- **E** is the same as **A** except that the Bottom Right Corner has been raised.

ARCH PANEL

The settings on the ARCH panel of the Window and Muller Unit Specification dialogs are also found on the panel of the same name in the Door Specification dialog. See [Arch Panel on page 386](#).

The settings on this panel of the Muller Unit Specification dialog define the overall shape of the blocked unit's top. If the muller unit already includes a component window with an arch, these settings cannot be modified.

The ARCH panel is not available for window symbols from the library, and its settings are not available if the selected window has been modified using the SHAPE panel.

TREATMENTS PANEL

The settings on the TREATMENTS panel allow you to add embellishments to the interior and exterior of the selected window or muller unit.

The TREATMENTS panel is not available in the Wall Niche and Window Symbol Specification dialogs.

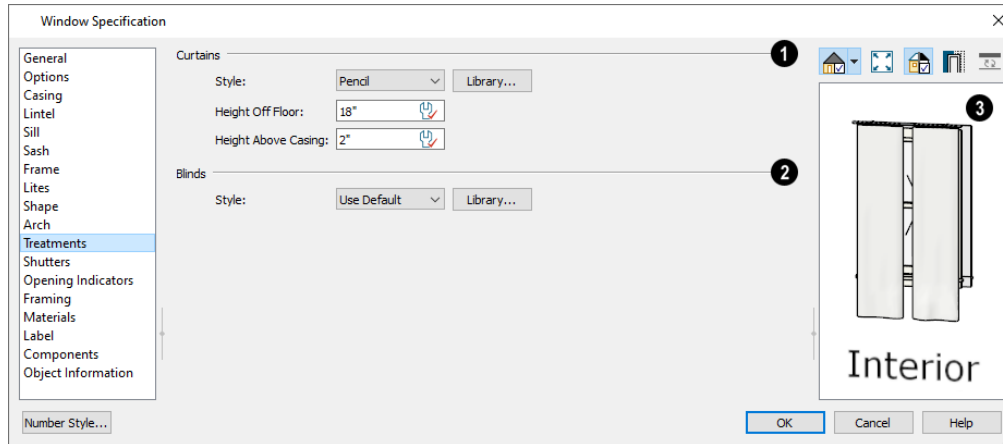

1 Curtains

Curtains are applied to the selected window or muller unit’s interior side.

- Specify a style of **Curtains** by selecting “Use Default”, “None” or “Library” from the drop-down list. If a non-default library item has been selected, its name will display in the list, as well.
- Click the **Library** button or select “Library” from the drop-down list to choose a style of curtain from the library. See [Select Library Object Dialog on page 688](#).
- Specify the **Height Off Floor** of the bottom edge of the curtains.
- Specify the **Height Above Casing** of the top of curtains.

2 Blinds

Blinds are specified in the same manner that Curtains are chosen, above.

3 Preview

A preview of the selected window displays on the right. You may want to rotate the view so the window’s interior can be seen. See [Dialog Preview Panes on page 20](#).

SHUTTERS PANEL

The settings on the SHUTTERS panel allow you to specify exterior shutters for the selected window or muller unit from the library.

The SHUTTERS panel is not available in the Wall Niche and Window Symbol Specification dialogs.

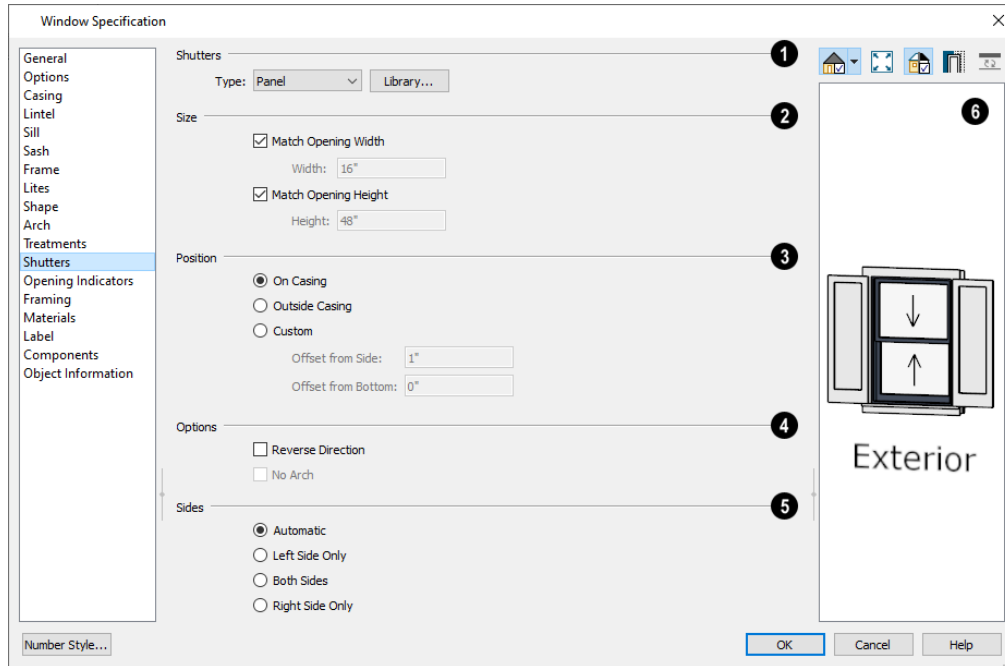

1 Shutters

Select a **Type** of shutters from the drop-down list or click the **Library** button to select a style of shutters from the Library Browser. See [Select Library Object Dialog on page 688](#).

2 Size

- When **Match Opening Width** is checked, each shutter's width is exactly half that of the window, excluding casing.
- Uncheck **Match Opening Width** to specify a **Width** in the text field. If the window is later resized, the shutters will not adjust in response.
- When **Match Opening Height** is checked, each shutter's height equals that of the window, excluding casing.
- Uncheck **Match Opening Height** to specify a **Height** in the text field. If the window is later resized, the shutters will not adjust in response.

3 Position

Specify the position of the shutters relative to the window.

- Select **On Casing** to position the shutters just outside the window frame, like functional shutters.
- Select **Outside Casing** to position shutters outside the window casing, as decorative shutters often are.
- Select **Custom** to create a custom position for the shutters by specifying the **Offset from Side** and **Offset from Bottom** in the fields below.

4 Options

Additional shutter **Options** can be specified here.

- Check **Reverse Direction** to orient the shutters so their exterior sides face outward and their interior sides face the wall. For functional shutters, this should remain unchecked.
- Check **No Arch** for shutters with flat tops that reach the bottom of the curved portion of an arched window. Only available when an Arch is selected. See *Arch Panel on page 418*.

5 Sides

Specify which sides of the selected window receive shutters.

- Select **Automatic** to assign shutters to both sides of the window as long as there is sufficient room on the wall. If the window is next to a wall intersection or corner, the shutter closest to the intersection will not generate.
- Select **Left Side Only** to assign a shutter to the left side of the window and none on the right.
- Select **Both Sides** to assign shutters to both sides of the window under all circumstances, even if there isn't enough room on the wall for one or both of them.
- Select **Right Side Only** to assign a shutter to the right side of the window and none on the left.

6 Preview

A preview of the selected window displays on the right. In order to see the shutters, you may need to rotate the preview to show the Exterior. See *Dialog Preview Panes on page 20*.

OPENING INDICATORS PANEL

The settings on the OPENING INDICATORS panel are also found on the panel of the same name in the Door Specification dialog. See *Opening Indicators Panel on page 390*.

FRAMING PANEL

The settings on the FRAMING panel are also found on the panel of the same name in the Door Specification dialog. See *Framing Panel on page 390*.

MATERIALS PANEL

The settings on the MATERIALS panel are the same as those found on the same panel in dialogs throughout the program. See *Materials Panel on page 716*.

The settings on the MATERIALS panel of the Muller Unit Specification dialog apply to all components of the blocked unit. Any settings made for individual components of the blocked unit are overridden here.

LABEL PANEL

Window labels display in plan view when the “Windows, Labels” layer is turned on and use the Text Style assigned to that layer. See *Window Labels on page 402*.

Similarly, Wall Niche labels display in plan view when the “Wall Niches, Labels” layer is turned on and use the Text Style assigned to that layer. See *Window Labels on page 402*.

For more information about the settings on this panel. See *Label Panel on page 363*.

COMPONENTS PANEL

The information on the COMPONENTS panel can be used in the materials list. For more information, see [Components Panel on page 921](#).

OBJECT INFORMATION PANEL

The information entered on the OBJECT INFORMATION panel can be used in the materials list. For more information, see [Object Information Panel on page 922](#).

MANUFACTURER PANEL

The MANUFACTURER panel provides contact information for the selected window's manufacturer. Only available for windows from Manufacturer library catalogs. See [Manufacturer Catalogs on page 677](#).

Bay, Box, and Bow Windows



Bay, Box and Bow Windows are created much the way regular windows are: select a tool, then click a wall to place that window type.

Pro automatically builds a foundation under bay/box/bow windows placed on floor 1 unless they are raised from their original position. That section of the foundation wall is also a bay/box/bow, but without windows. If the foundation was generated before the window is placed, the foundation must be rebuilt or edited manually.

EDITING BAY, BOX, AND BOW WINDOWS

Bay, box, and bow windows are edited similar to regular windows with one exception: in plan view, a diamond-shaped Depth edit handle displays on the section. Drag this Depth handle outward to increase the depth, or inward to decrease the depth of the unit. See [Editing Windows on page 403](#).

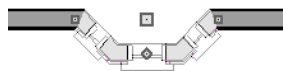

Bay, box, and bow windows can also be edited in their respective specification dialogs. See [Bay/Box and Bow Window Specification Dialogs on page 426](#).

DISPLAYING BAY, BOX, AND BOW WINDOWS

The display of bay, box, and bow windows is controlled in the Layer Display Options dialog. See [Layer Display Options Dialog on page 126](#).

Like other windows, bay, box, and bow windows can display labels: either a single label for the unit, or one for each component. See [Window Labels on page 402](#).

Bay, box, and bow window width and radius dimensions, which display in plan view when specified to do so in the window's specification dialog, are placed on the "Dimensions, Manual" layer. See [Options Panel on page 428](#).

COMPONENT WINDOWS

A component window within a bay, box, or bow window can be resized like any other standard window. To select a component window, click at the location of the component in question, then click the **Select Next Object**  edit button or press the Tab key.

- Only the bay or box window component that was clicked on is selected using this method. If you need to select a different component, click on it and repeat the process.
- In a bow window, all components are identical, so only one component can be selected. Changing this component changes them all.

RESIZING COMPONENTS

An individual component window can be resized using the edit handles, by changing settings in the component's Window Specification dialog, or by using the Transform/Replicate Object dialog. See [Transform/Replicate Object Dialog on page 180](#).

When a bay/box/bow window is first created, there is room for one standard trimmer on each side of each component window. When the bay as a whole is moved and resized, its components automatically resize so that a standard trimmer is still accommodated.

If you increase a component window's width to the point where there is not enough room for standard trimmers, a thinner trimmer can be used. The size of this thinner trimmer is specified in the Build Framing dialog. See [Openings Panel on page 620](#).

If a component window is resized, it retains its size if at all possible when the containing bay/box/bow window is moved or resized. If the bay is resized in such a way that the component is too large to fit even with a thinner trimmer, the component resumes its default behavior, resizing as the containing bay window is resized.

FLOORS AND CEILINGS

When originally created, the floor and ceiling within a bay, box, or bow window are the same heights as the floor and ceiling of the room in which it is placed.



Both the top and bottom heights of these window units can be adjusted in its specification dialog or a 3D view using its edit handles to create a lowered ceiling and/or a bench seat or garden window.

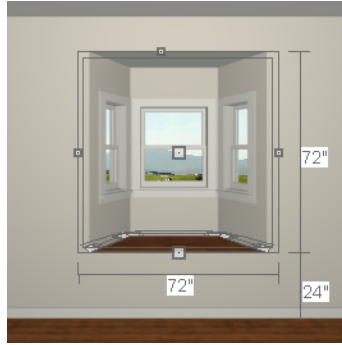

When the ceiling is lowered, the top heights of the walls that define the window unit are also lowered. When a roof is built over the unit, its height will be affected, as well.

When the bottom of the window is raised to create a bench seat, the unit's walls will not reach the ground. As a result, window units with bench seats will have no foundation beneath them when the foundation is built.

Bay, Box, Bow Windows and Roofs

Several different roof styles can be specified for bay, box and bow window units in the Bay/Box and Bow Specification dialogs. See [General Panel on page 427](#).

If you change a bay, box, or bow window's roof specification, you will need to rebuild the roofs to see the changes. See [Rebuilding Roofs on page 561](#).

HIP ROOFS

By default, a hip roof is built above the unit when roofs are automatically generated. No roof directives need to be selected in the specification dialog to produce this roof.



USE THE EXISTING ROOF

To generate a standard roof that ignores a bay, box, or bow window, check **Use Existing Roof**.

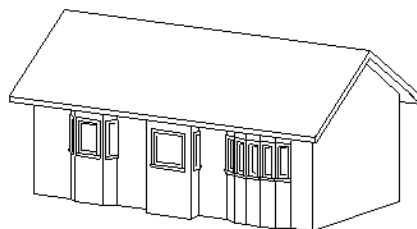

With this option the bay, box, or bow windows is tucked under the roof eave. You may find it helpful to increase the width of the eaves. See [Roof Panel on page 563](#).

EXTEND THE EXISTING ROOF

To have the main roof extend down over the window unit and follow the shape of the unit, select **Extend Existing Roof Over**.

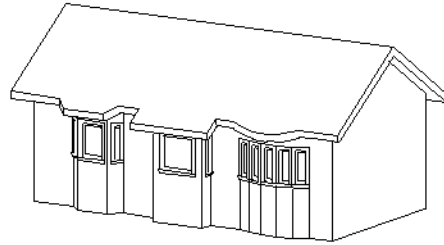

For this roof style, the ceiling heights of the window unit and the adjacent room must be the same. If you lower the ceiling of the window unit and then build the roof, a lower hip roof over the window is created. See [Floors and Ceilings on page 423](#).

If a header is desired over the window unit, first build the roof, then lower the ceiling of the window unit. Once the ceiling is lowered, select **Rebuild Walls/Floors/Ceilings** . Do not rebuild roof planes.

RECTANGULAR HIP ROOFS

To create a rectangular-shaped hip roof above a bay, box, or bow window, select **Rectangular Roof Over**.



EXTEND EXISTING ROOF - RECTANGULAR

To extend the main roof down over a window unit to create a rectangular roof over it rather than one that follows its shape, select both **Extend Existing Roof over** and **Rectangular Roof Over**.

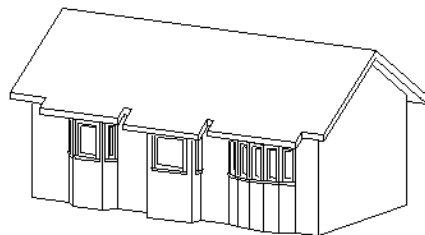



GABLE ROOF

A gable roof is not one of the automatic options for the roof above a bay, box or bow window. A gable can be created by manually editing the rectangular hip roofs that are automatically created. See [Roof Planes on page 570](#).

To create a gable over a bay window

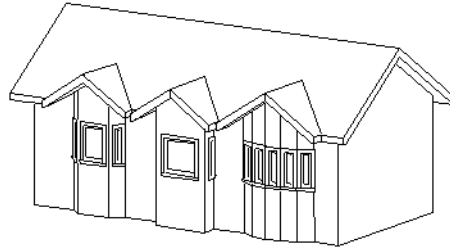
1. Select the front ridge corner handle of each side hip roof plane and drag the edge forward until the fascia snaps to the edge of the front hip section.
2. Delete the front hip section.
3. Adjust the roof's overhang as needed.



 To create a gable roof over a normal window, use the Gable Over Door/Window edit button. See [Gable/Roof Lines on page 590](#).

Bay/Box and Bow Window Specification Dialogs

 To open the Bay/Box Window Specification or the Bow Window Specification dialog, select one or more Bay, Box, or Bow Windows and click the **Open Object** edit button. See [Bay, Box, and Bow Windows on page 422](#).

The options in this dialog can only be set for objects placed in a plan: Bay, Box, and Bow Windows do not have defaults dialogs.

The settings that are available in these dialogs depend on whether the selected object is a Bay, Box, or Bow Window.

The Bay/Box and Bow Window Specification dialogs have the following panels:

GENERAL PANEL

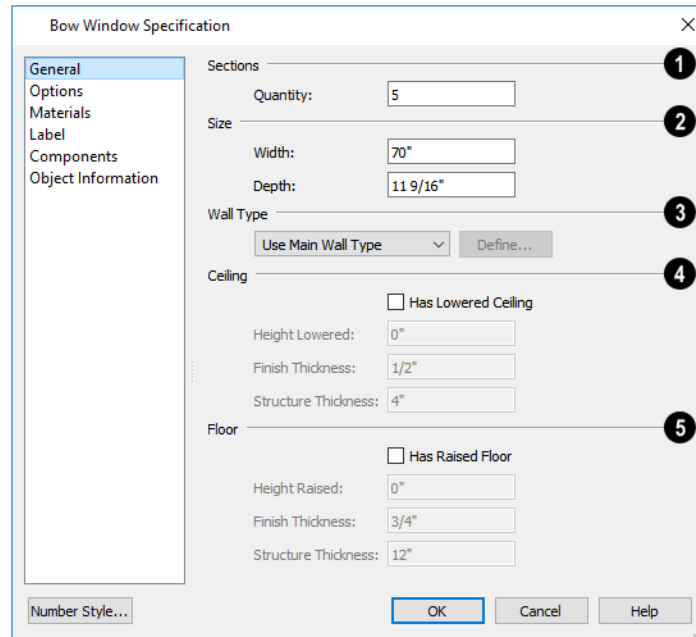

1 Sections

The setting that displays here depends on whether the selected window is a Bay, Box, or Bow Window.

- Specify the **Bay Angle**, which is the angle of the side components of a Bay or Box Window. Bay Windows have an angle of 45° by default; Box Windows have an angle of 90°.
- Specify the **Quantity**, which is number of component windows in a Bow Window.

2 Size

Specify the **Width** and **Depth** of the Bay, Box, or Bow Window.

3 Wall Type

Specify the **Wall Type** used by the walls embedded in the selected Bay, Box, or Bow Window. See *Wall Type Definitions on page 256*.

- Select “Use Main Wall Type” from the drop-down list to use the same wall type as that of the wall that the window unit is placed in. If the main wall is a Pony Wall, both wall types are used.
- Select a specific wall type from the drop-down list to use it instead of the Main Wall Type.
- When a specific wall type is selected, click the **Define** button to modify its definition. See *Wall Type Definitions Dialog on page 259*.

4 Ceiling

Specify the height and structure of the **Ceiling** within the selected window.

- Check **Has Lowered Ceiling** to enable the settings that follow. When this is unchecked, the ceiling height and finish material within the window is the same as that for the adjacent room.
- Specify the **Height Lowered**, which is measured from the ceiling height of the adjacent room.

Note: If the Height Lowered is 0", Has Lowered Ceiling will become unchecked when you click OK.

- Specify the **Finish Thickness**, which is the thickness of the ceiling's finish material.
- Specify the **Structure Thickness**, which is the thickness of the ceiling's structural layer.

5 Floor

Specify the height and structure of the **Floor** within the selected window.

- Check **Has Raised Floor** to enable the settings that follow. When this is unchecked, the floor height and material within the window is the same as that for the adjacent room.
- Specify the **Height Raised**, which is the measured from the floor height of the adjacent room.

Note: If the Height Raised is 0", Has Raised Floor will become unchecked when you click OK.

- Specify the **Finish Thickness**, which is the thickness of the floor's finish material.
- Specify the **Structure Thickness**, which is the thickness of the floor's structural layer.

OPTIONS PANEL

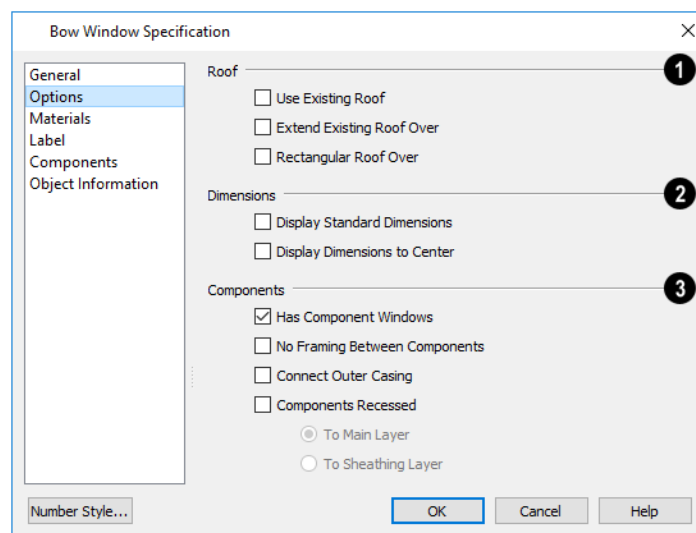

1 Roof

Specify the structure of the automatic **Roof** over the selected window unit. See *Bay, Box, Bow Windows and Roofs on page 424*.

- Check **Use Existing Roof** if the existing roof needs no changes to accommodate the bay window.
- Check **Extend Existing Roof Over** to extend the existing roof plane to cover the bay window below.
- Check **Rectangular Roof Over** to create a roof over the bay window that is square across the end instead of following the profile of the roof.

2 Dimensions

Specify the appearance of the selected window unit's **Dimensions** in plan view.

- Check **Display Standard Dimension** to display the automatically-produced dimensions that show the window's width and depth.
- Check **Display Dimensions to Center** to display a Bow Window's radial dimension.

3 Components

Specify the structure of the selected window unit's **Components** and the wall sections containing them.

- Uncheck **Has Component Windows** to remove the component windows of the selected Bay, Box, or Bow Window and disable the settings that follow.
- Check **No Framing Between Components** to eliminate the trimmer studs for Bay and Box Window components, allowing the width of each component window to increase. See *Wall Framing on page 606*.
- Check **No Framing Between Components** to remove both studs between the component windows.

Note: If the selected unit is moved or resized, its components automatically resize to use a standard trimmer, regardless of whether either of the two options above are selected.

- Check **Connect Outer Casing** to have exterior casing surround the component windows of a Bow Window as a group rather than individually. Mullions are provided between components. This is how interior casing is always created.
- Check **Components Recessed** to recess the component windows into the wall and enable the settings that follow. Typically used if the window is placed in a brick wall and you want to produce a brick molding.
- Select **To Main Layer** to recess the components to the wall's Main Layer instead of the exterior wall surface. See *The Main Layer on page 257*.
- Select **To Sheathing Layer** to recess the components to the sheathing layer instead of the exterior wall surface.

MATERIALS PANEL

The settings on the MATERIALS panel are the same as those found on the same panel in dialogs throughout the program. See *Materials Panel on page 716*.

LABEL PANEL

Bay, Box, and Bow Window labels display in plan view when the "Windows, Labels" layer is turned on and use the Text Style assigned to that layer. See *Window Labels on page 402*.

For more information about the settings on this panel. See *Label Panel on page 363*.

COMPONENTS PANEL

The information on the COMPONENTS panel can be used in the materials list. See *Components Panel on page 921*.

OBJECT INFORMATION PANEL

The information entered on the OBJECT INFORMATION panel can be used in the materials list. For more information, see *Object Information Panel on page 922*.

Cabinets

Chapter 17

With Home Designer's cabinet tools you can create base, wall, and full height cabinets as well as soffits, shelves, partitions, and custom countertops. These objects are very versatile, allowing for a wide range of customization.

A selection of cabinet door and drawer styles are available in the Library Browser.

Home Designer also has many customized cabinets and cabinet groups available in the library.

TOPICS

Cabinet Defaults	432
The Cabinet Tools	434
Cabinet Fillers	436
Placing Cabinets	436
Countertops	437
Custom Backsplashes	439
Displaying Cabinets	439
Cabinet Labels	441
Cabinet Construction	443
Editing Cabinets	444
Editing Cabinet Styles	446
Special Cabinets	448
Cabinet Specification Dialog	450
Cabinet Shelf Specification Dialog	461
Shelf/Partition Specification Dialog	462
Custom Countertop Specification Dialog	463
Custom Backsplash Specification Dialog	466

Cabinet Defaults

There are several defaults dialogs for cabinets. Access Default Settings by selecting **Edit> Default Settings**, then clicking the arrow beside “Cabinets”. Select a subheading and click the **Edit** button to open the defaults dialog associated with your selection.

The Cabinet Defaults dialogs can also be accessed by double-clicking the **Cabinet Tools**  parent button.

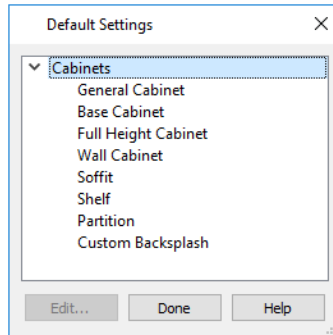

Double-clicking a Cabinet Tools child button also opens its corresponding defaults dialog, if that object has a defaults dialog.

Each type of cabinet object has default definitions for size, style, materials and much more. In fact, the default dialog for each cabinet type is similar to its corresponding specification dialog. For descriptions of these settings, see [Cabinet Specification Dialog on page 450](#), [Shelf/Partition Specification Dialog on page 462](#) and [Soffit Specification Dialog on page 706](#).

Custom Countertops do not have defaults dialogs. Instead, their initial settings are based on the those of other objects.

- Custom Countertops’ initial settings are based on Base Cabinet Default settings but are also influenced by the settings of cabinets beneath them. See [Countertops on page 437](#).

DYNAMIC CABINET DEFAULTS

When a dynamic default is changed, existing cabinet objects using the default value are affected. See [Dynamic Defaults on page 55](#).

The following cabinet default values are dynamic: **Separation, Backsplash Height and Thickness, Countertop Overhang and Thickness, Toe Kick Height and Depth, Side and Vertical Overlap, Stiles, and Hardware** spacing.

All **Materials** are also dynamic. In addition, the Cabinet Defaults can be set up to refer dynamically to information in the Material Defaults dialog. This makes it easy to have all cabinet objects in a plan use the same default materials. See [Material Defaults Dialog on page 713](#).

To use dynamic cabinet Material Defaults

1. Specify the desired materials for the cabinet categories in the Material Defaults dialog:
 - “Cabinets” can be linked to the default cabinet box, cabinet interior, shelves, and toe kicks as well as to Shelves and Partitions.
 - “Cabinet Door/Drawer” can be linked to the default frames and panels of cabinet doors and drawers.

- “Countertop” can be linked to the default countertop.
 - “Hardware” can be linked to the default door and drawer pulls and hinges.
2. On the MATERIALS panel of the Base Cabinet Defaults dialog, select the first object component and click the **Select Material** button.
 3. The Select Material dialog opens:
 - On the LIBRARY MATERIAL panel, check **Use default material**, or
 - On the PLAN MATERIAL panel, select “Use Default” at the top of the list.
 4. Click **OK**, then repeat this step for each of the components in the list.
 5. Repeat steps 2-4 in each of the Cabinet Defaults dialogs.

GENERAL CABINET DEFAULTS

The General Cabinet Defaults dialog can be accessed only from the Default Settings dialog.

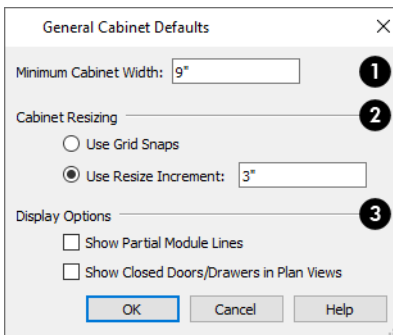

1 Minimum Cabinet Width

The smallest allowable value is 1/16 of an inch (10 mm).

2 Cabinet Resizing

Specify how **Cabinet Resizing** takes place when the edit handles are used.

- Select **Use Grid Snaps** to resize cabinets using Snap Grid increments. See [Grid Snaps on page 115](#).
- Select **Use Resize Increment** to resize cabinets using the increment specified here.
- Set the **Resize Increment** at which cabinets resize. The minimum allowable increment is 1/16 of an inch (10 mm).

3 Display Options

- Check **Show Partial Module Lines** to represent module lines as grey lines that do not extend across the cabinets. When this is unchecked, lines between merged cabinet modules display as specified by the “Cabinets, Module Lines” layer. See [Displaying Cabinets on page 439](#).
- Check **Show Closed Doors/Drawers in Plan Views** to display closed cabinet doors and drawers in plan view. When unchecked, closed doors and drawers are not shown. See [Displaying Cabinets on page 439](#).

The Cabinet Tools



Select **Build> Cabinet** to access the Cabinet Tools.

Cabinets are easily created with a single click in plan view or any camera view. See [Click-to-Crete on page 115](#).

Typically, groups of cabinet objects are positioned closely together and arranged to form work spaces, and there are some special behaviors and techniques to be aware of. See [Placing Cabinets on page 436](#).

Once created, cabinets, soffits, shelves, partitions and fillers can be selected and edited much like other box-based objects. See [Editing Cabinets on page 444](#).

BASE CABINETS



Base cabinets can be placed directly under wall cabinets and generate a countertop and toe kick by default.

WALL CABINETS



Wall cabinets can be placed directly over base cabinets.

FULL HEIGHT CABINETS



Full height cabinets generate a toe kick by default and cannot be placed on top of other cabinets.

SOFFITS



Soffits typically fill the space between cabinet tops and the ceiling, but can also be used to create any object that can be modeled as a 3D box. To place a soffit, select **Build> Cabinet> Soffit** and click in any view.

By default, soffits use the material assigned to interior walls in the Material Defaults dialog. Like cabinets, soffits can have molding profiles applied to them.

For more information about using soffits for a variety of purposes, see [Other Objects on page 702](#).

SHELVES



Select **Build> Cabinet> Shelf** and click in any view to create a shelf.

Create corner shelves by placing one shelf on each wall, then moving or stretching them until they touch.

Once created, shelves can be selected and edited. See [Shelf/Partition Specification Dialog on page 462](#).

You can also specify shelves inside of base, wall, and full height cabinet boxes. See [Cabinet Shelf Specification Dialog on page 461](#).

PARTITIONS



Select **Build> Cabinet> Partition** button and click in any view to create a vertical partition.

Like shelves, partitions can be selected and edited after they are placed.

Partitions can be used with shelves to create complex storage systems.

CUSTOM COUNTERTOPS



Custom Countertops are drawn and edited just like other closed-polyline based objects. Select **Build> Cabinet> Custom Countertop**, then either click and drag a rectangle or single-click to place a 2'x2' countertop. See [Countertops on page 437](#).

You can also generate a custom countertop over one or more base cabinets using the **Generate Custom Countertop**  edit tool. See [Using the Edit Tools on page 445](#).

CUSTOM BACKSPLASHES



Select **Build> Cabinet> Custom Backsplash** while an elevation or camera view is active, then either click and drag a rectangle or single-click on a wall surface to place a Custom Backsplash Layered Material Polyline on that wall. See [Custom Backsplashes on page 439](#).

A custom backsplash can also be created using the **Convert Polyline**  edit tool. See [Convert Polyline on page 179](#).

CABINET LIBRARY CATALOG



In the Library Browser, browse to Home Designer Core Catalogs> Architectural> Cabinets to access a selection of specialty cabinets. Select the library object you want, then click in any view to place it in the plan. Once placed, library cabinets can be edited. See [Placing Library Objects on page 686](#).

CABINET DOORS, DRAWERS, AND PANELS CATALOG



A selection of cabinet door panels, drawer fronts, and specialty cabinet storage options can be found in the Library Browser in Home Designer Core Catalogs> Architectural> Cabinet Doors, Drawers, and Panels.

- Doors and drawers can be assigned to a cabinet in its specification dialog. See [Door/Drawer Panel on page 457](#).
- Select a door or drawer in the library, then click on a cabinet in your plan to place the door or drawer onto that cabinet. Side and back panels cannot be applied to cabinets using this approach. See [Inserted Objects on page 687](#).
- Cabinet doors and drawers can also be placed as stand-alone fixtures. Once placed, they can be edited like other stand-alone library objects. See [Editing Library Objects on page 691](#).

BUILT-IN SINKS AND APPLIANCES

A variety of fixtures and appliances such as sinks, cooktops, and dishwashers can be placed into cabinets. See [Inserted Objects on page 687](#).





Place fixtures and appliances into cabinets early, so that any resizing can be done while there is adequate free space.

To insert a fixture into a cabinet, select the fixture in the Library Browser, then click on a cabinet. There must be enough space in the cabinet or adjoining cabinets to contain the selected fixture. Only one front mounted appliance can be inserted in this manner.

If a sink or cooktop is inserted into a cabinet with a Drawer or Double Drawer, its Item Type will automatically change to a False Drawer or False Double Drawer.

Once placed, an inserted fixture can be selected and edited:

- To select a fixture in a cabinet top, click on it and then click the **Select Next Object**  edit button. See *Select Next Object on page 143*.
- Front fixtures can only be modified or deleted in the Cabinet Specification dialog. See *Front Panel on page 454*.

 Fixtures can be added to both the top and front of the same cabinet. It is up to you to determine which can be effectively and safely combined in the real world.

ELECTRICAL SWITCHES AND OUTLETS

 Electrical switches and outlets placed within the backsplash area of a base cabinet will display in front of the backsplash in 3D views when the “Electrical” layer is turned. See *The Electrical Tools on page 470*.

Cabinet Fillers

Home Designer automatically generates fillers when cabinets of the same height are either touching or placed with 3” (75 mm) of one another. Automatic fillers receive the same toe kick, moldings, and backsplash as adjacent cabinets, and model a continuous countertop.

If two cabinets meeting at a corner are separated from each other by 3” (75 mm) or less, the program will automatically generate a filler in the angle between them. A filler is used to separate the front of one of these cabinets from the one it meets so that drawers and doors have room to operate.

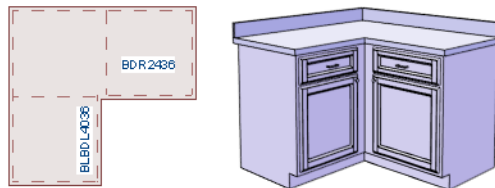

Placing Cabinets

Cabinets are easily created with a single click in any view. See *Click-to-Create on page 115*.

When used near a wall corner, the Cabinet Tools will produce corner cabinets and soffits. See *Corner Cabinets on page 448*.

When created, cabinets are positioned relative to the floor of the room in which they are placed. Base and full height cabinets typically rest on the floor while wall cabinets are placed a set distance above the floor. See *Cabinet Defaults on page 432*.

If the ceiling height of the room does not accommodate the height of a cabinet, its **Floor to Bottom** value will be retained and its **Height** will be reduced so that it fits under the ceiling. When this happens, some front items may be removed from the cabinet if there is not enough room for them. See *Front Panel on page 454*.

Because cabinets are typically organized into groups with shared attributes, they have some special behaviors.

CABINET SNAPPING AND ALIGNING

Cabinets have several special snapping and aligning behaviors which help you create precisely aligned cabinets quickly and easily.

- When Base and/or Full Height cabinets are within 3” of one another’s sides, they will snap together. Wall cabinets snap in a similar manner, but only with other Wall cabinets.
- When Base and/or Full Height cabinets are within 3” of one another’s sides and their front or back surfaces are within 3” of aligning, they will become aligned. Wall cabinets snap in a similar manner with other Wall cabinets as well as Full Height cabinets.
- When a Base and/or Full Height cabinet is placed against the back of another Base or Full Height cabinet, its back surface will automatically face the other cabinet’s back. Wall cabinets snap in a similar manner with other Wall as well as Full Height cabinets.
- When a cabinet or cabinet filler is placed against a wall, its back and/or side will snap to the wall and, if the wall is moved, the cabinet will move with it.

When cabinets are snapped to a wall or to other cabinets, only exposed end cabinets have side counter overhangs.

Cabinet snapping and aligning occurs even when **Object Snaps**  are turned off; however, you can override this behavior by moving a cabinet into the desired position using dimensions. See [Moving Objects Using Dimensions on page 332](#).

CABINET MERGING

When cabinets of the same height and type are placed side-by-side within 3” (30 mm) of one another they will automatically merge, making any shared components such as the toe kick, countertop, backsplash, and moldings continuous. Any gap between merged cabinets will be automatically filled.

The exposed ends of merged cabinets have side counter overhangs.

Cabinets placed at different angles will also merge if they face toward one another and meet at a front corner. Cabinets that meet at a back corner will also merge provided that they face away from one another at an angle no greater than 87°. In either case, a filler is created in the angle between the two.

If the side of a cabinet is placed within 3” (30 mm) of a wall, the countertop will extend to the wall and a filler will be created.

Cabinet merging occurs even when **Object Snaps**  are turned off.

BASE AND WALL CABINETS

Base and wall cabinets have different default heights, so they can be placed directly above or below one another without interference. You can use **Object Snaps**  to center a wall cabinet’s back center point above that of a base cabinet, or vice versa. See [Click-to-Create on page 115](#).

MINIMUM CABINET SIZE

If you try to place a cabinet into a space that is too narrow for its default size, the program will place a smaller cabinet with a width that is a multiple of the default **Resize Increment**. For example, if you try to place a 24” wide cabinet in a 20” wide space and your Resize Increment is 3”, the program places an 18” cabinet. See [General Cabinet Defaults on page 433](#).

If you try to place a cabinet into a space narrower than the default **Minimum Cabinet Width**, a cabinet will not be placed. If, for example, you have a space that is 8” and your Minimum Cabinet Width is 9”, no cabinet is placed.

Countertops

Countertops are automatically generated on top of base cabinets, but can also be drawn manually.

AUTOMATIC COUNTERTOPS

Base cabinets automatically receive countertops as specified in the Base Cabinet Defaults dialog. These default countertops are components of the cabinets and can be edited in the Cabinet Specification dialog, but cannot be selected and modified separately.

The overhangs on automatic countertops are clipped on any side where the cabinet is positioned against or within 3" (75 mm) of a wall, a Full Height Cabinet, a Partition, or free-standing appliance from the Library. Edge profiles on those sides are also suppressed, as are toe kicks.

CUSTOM COUNTERTOPS



When an automatic countertop does not meet your needs, you can instead use a **Custom Countertop**. In any view except a cross section/elevation, select **Build> Cabinet> Custom Countertop**, then either click and drag a rectangle or single-click to place a 2'x2' countertop polyline. This countertop can be selected independent of any cabinets beneath it and is edited just like other closed-polyline based objects. See [Editing Closed Polyline-Based Objects on page 155](#).

When a Custom Countertop covers any portion of a base cabinet, it overrides that cabinet's automatic countertop and bases its thickness and height on the base cabinet below.

- If there are multiple cabinets below, it uses the specifications for the cabinet with the greatest overall height.
- If there is no base cabinet below, its height and thickness are based on the base cabinet defaults. See [Cabinet Defaults on page 432](#).

If a sink or built-in appliance is added to the cabinet, a hole for the fixture is automatically cut in the Custom Countertop.

By default, if a side of a Custom Countertop is positioned against a wall, the edge profile on that side will not generate.



You can also generate a Custom Countertop over one or more selected base cabinets by clicking the **Generate Custom Countertop** edit button. See [Using the Edit Tools on page 445](#).

When created in this manner, the Custom Countertop inherits the cabinet's countertop material. If the cabinet has a To Top molding profile at counter height, the Custom Countertop will inherit it, as well. See [Editing Cabinet Styles on page 446](#).

EDITING CUSTOM COUNTERTOPS

Once created, a custom countertop can be selected in 2D and 3D views and edited like other closed-polyline based objects. See [Editing Closed Polyline-Based Objects on page 155](#).

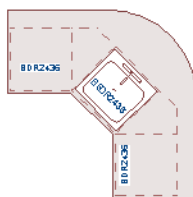

Custom countertops initially use the default countertop material set in the Base Cabinet Defaults dialog. You can specify a different material as well as the height and position in the Custom Countertop Specification dialog. See [Custom Countertop Specification Dialog on page 463](#).

You can also specify the edge profile of a custom countertop in the Custom Countertop Specification dialog. See [Moldings Panel on page 463](#).

WATERFALL COUNTERTOPS



To add a vertical waterfall to the edge of a Custom Countertop, select that edge and click the **Add Waterfall to Selected Edge** edit button. See [Selected Edge on page 142](#).

You can also specify a waterfall edge as well as edit its attributes in the Custom Countertop Specification dialog. See [General Panel on page 464](#).



To remove a waterfall from a countertop edge, select that edge and click the **Remove Waterfall from Selected Edge** edit tool.

Custom Backsplashes



The **Custom Backsplash** tool allows you to create areas on a wall that use a different surface material than the parent wall. To create a Custom Backsplash, select **Build> Cabinet> Custom Backsplash**.

Custom Backsplashes are closed polyline-based objects that are drawn on the vertical surface of a wall. They can only be drawn, and their shapes edited, in camera and elevation views. See [Polylines on page 214](#) and [Editing Closed Polyline-Based Objects on page 155](#).

Custom Backsplashes are composed of a layer of backsplash material. The layer material and its thickness can be set in the Custom Backsplash Specification dialog. See [Custom Backsplash Specification Dialog on page 466](#).

If any cabinets and/or appliances are present, a Custom Backsplash will:

- Seek to fill the area between any base cabinets or floor appliances against that wall surface and any wall cabinets and/or windows above them.
- If nothing is above any base cabinets, it will fill the area between the cabinets and the ceiling; if nothing is below any wall cabinets, it will fill the area between the cabinets and the floor.
- Replace the backsplash associated with any base or wall cabinets.

By default, a Custom Backsplash will cut into the wall layers between it and its parent wall's Main Layer and replace those layers with its own within its perimeter; it can, however, can be affixed to the wall's surface instead if you prefer.

Displaying Cabinets



The display of the various cabinet object types, labels, module lines, door opening indicators, and more is controlled in the Layer Display Options dialog. See [Layer Attributes on page 124](#).

IN PLAN VIEW

Fill Styles and colors that display in plan view can be assigned to cabinet objects. See [Fill Styles on page 130](#).

Like other objects, cabinets are placed in Drawing Groups that affect whether they display in front of or behind other objects in plan view. By default, wall cabinets, soffits and shelves are drawn in front of base and full height cabinets, countertops and partitions. You can modify a selected cabinet's place in the drawing order by clicking the **View Drawing Group Edit Tools**  edit button. See [Drawing Group Edit Tools on page 128](#).

Objects assigned to cabinets, including hardware and moldings, are located on the same layer as their parent object. They display in 3D views, but are not shown in plan view. There are two notable exceptions: countertops and doors/drawers.

- Both automatic and Custom Countertops are drawn on the “Cabinets, Countertops” layer in all views. In plan view, countertops use the line style, color, and weight assigned to this layer; in 3D views, the line attributes of the parent object’s layer is used instead.
- Cabinet doors and drawers are drawn on the “Cabinets, Doors & Drawers” layer in all views, but only display in 3D views by default. See *Cabinet Doors and Drawers on page 440*, below.

Custom Countertops can be assigned an edge profile, and can display the width of this profile if **Display Molding Edges** is selected in the Custom Countertop Specification dialog. See *General Panel on page 464*.

By default, cabinet module lines display in plan view when cabinet objects of the same type are placed side by side. If you prefer that these lines not display, turn off the “Cabinets, Module Lines” layer. You can also specify whether module lines are full or partial. See *General Cabinet Defaults on page 433*.

You can also display cabinet front indicator arrows in plan view by turning on the “Cabinets, Front Indicators” layer.

Cabinet labels display in plan view when the “Cabinets, Labels” layer is turned on Text Style assigned to their layer. See *Cabinet Labels on page 441*.

IN 3D VIEWS





In 3D views, cabinet doors and drawers are drawn on the “Cabinets, Doors & Drawers” layer, and their display can be turned on and off.

In 3D Vector Views, cabinet doors can display opening indicator arrows. See *Opening Indicators on page 370*.

CABINET DOORS AND DRAWERS

There are several options for controlling the display of cabinet doors and drawers in plan and 3D views.

Cabinet doors and drawers are drawn on the “Cabinets, Doors & Drawers” layer. In plan view, they use the line style, color, and weight assigned to that layer when they are set to display. In 3D Vector Views, they use the line style, color, and weight assigned to their parent cabinet’s layer.

- Cabinet doors and drawers can be drawn open or closed in both plan and 3D views.
- To draw a selected cabinet’s doors open in all views, click the **Open Cabinet Doors**  edit button. Any shelves set as Rollout will display in 3D views as well.
- To draw its drawers open in all views, click the **Open Cabinet Drawers**  edit button.
- To close the doors and/or drawers, click the **Close Cabinet Doors**  or **Close Cabinet Drawers**  edit button.

Cabinet doors and drawers also can be set to **Show Open** in the Cabinet Specification dialog. In addition, you can specify how far open each is drawn. See *Front Panel on page 454*.

By default, doors and drawers do not display in plan view when they are closed- even when the “Cabinets, Doors & Drawers” layer is set to display. You can, however, check **Show Closed Doors/Drawers in Plan Views** in the General Cabinet Defaults dialog. See *General Cabinet Defaults on page 433*.

ROLLOUT SHELVES AND STORAGE

Shelves can be specified for Door and Opening cabinet front items and are visible in 3D views. Those inside of Doors will display in 3D views only when Doors and Rollout Shelves are set to **Show Open**. See *Front Panel on page 454*.

Shelves can be specified as **Rollout**, each with its own rollout percentage, and will display in 3D views when Doors and Rollout Shelves are set to **Show Open**. If a Rollout shelf is in a Door item, the door must be set to 100% **Percent Open** in order for the shelf to draw open. See *Cabinet Shelf Specification Dialog on page 461*.

Cabinet shelves and added storage items do not display in plan view.

IN THE MATERIALS LIST

The materials associated with cabinet objects are listed under different Categories in the Materials List:

- **Cabinets** - Lists Cabinets, Shelves, Partitions, Custom Countertops, Custom Backsplashes, storage and organization inserts, as well as cabinet doors and drawers placed from the library as free-standing objects.
- **Interior Trim** - Lists Soffits and any moldings assigned to cabinet objects located in Interior rooms. Note that Soffits are not listed in the Materials List unless a non-default material is applied to them. See *Calculating Materials on Soffits on page 705*.
- **Exterior Trim** - Lists any Soffits and moldings assigned to cabinet objects located in Exterior rooms. See *Room Types on page 282*.
- **Fixtures** - Lists any sinks inserted into base cabinets. See *Inserted Objects on page 687*.
- **Appliance** - Lists any appliance fixtures inserted into cabinets. If a base cabinet has an under-counter appliance inserted into it, that cabinet will not be counted in the Materials List - only the countertop and backsplash materials associated with it will be listed. The cabinet will also display the appliance's label information instead of its own. See *Cabinet Labels on page 441*.

As with other objects, there are a number of ways to control how, or whether, cabinets are included in the Materials List. See *Organizing Materials Lists on page 908*.

You can add and edit information about a cabinet's accessories in the Cabinet Specification dialog. See *Components Panel on page 921*.

Note that cabinet door and drawer height is described in two different ways:

- In the Cabinet Specification dialog, the Item Height for cabinet doors and drawers describes the height of the opening in the cabinet box rather than that of the door or drawer front. See *Front Panel on page 454*.
- In the Materials List, the full height of cabinet door and drawer front is listed in the Size column.

Cabinet Labels

Labels for cabinets display in plan view when the "Cabinets, Labels" layer is turned on. See *Label Panel on page 363*.

Shelves and Partitions can also display labels when the "Cabinets, Labels" layer is turned on. Unlike cabinets, the Automatic Label for these objects is blank; however, you can specify a custom label in their specification dialogs.

Cabinet labels use the Text Style specified for the "Cabinets, Labels" layer. See *Text Styles on page 360*.

If a base cabinet's only front item aside from Separations and Blank Areas is an Appliance, the appliance's label will display instead of the cabinet's, and will be placed on the "Cabinets, Labels" layer.

The minimum on-screen display size of object labels can be specified in the Preferences dialog. See *Appearance Panel on page 60*.

AUTOMATIC LABELS

The format for automatic cabinet labels has four parts: Key, Code, Size, and Door Swing.

The **Key** provides basic information about the cabinet box and its use. B refers to base cabinets, W refers to wall cabinets and U refers to full height cabinets.

Together with the key, the **Code** provides additional information about the shape of the cabinet box:

Code	
	All Cabinets
LS + Key	Lazy Susan
LSD + Key	Lazy Susan Diagonal Door
DC + Key	Diagonal Door
LC + Key	Left Corner
BC + Key	Blind Corner
E + Key	Right or Left End
A + Key	Angled Front
PR + Key	Peninsula Radius
R + Key	Radius End
Key + XL	Extend Left Face Frame
Key + XR	Extend Right Face Frame
Key + XLR	Extend Left and Right Face Frame
B	Base
OB	Oven Base
SB	Sink Base
RB	Range Base
#DB	Drawer Bank (# is the number of drawers)
FHB	Full Height Base (1 full height door)
W	Wall
Code above + #D	Drawer (# is the number of drawers)
U	Full Height (Utility)
OTC	Tall Oven
RTC	Tall Refrigerator

Blind corner cabinets are dependent on the cabinet’s position in the plan. A cabinet can only be a blind corner cabinet when its front is partially hidden by another cabinet. See *Blind Cabinets on page 450*. If a cabinet is moved, therefore, its Code information may change.

The **Size** follows the Code in a cabinet label. Cabinet width is always included in the label; depth and height, on the other hand, may be included depending on the cabinet type and whether they are standard or non-standard.

Base and full height cabinet labels present Size information in this order: width, depth, height. Wall cabinet labels present it in a slightly different order: width, height, depth.

	Sizes
Base	W(D)(H)
Width (W)	Always included
Depth (D)	24” (60 cm)
Height (H)	34 1/2” (90 cm)

	Sizes
Corner Depth (D)	Depth = Width
Wall	WH(D)
Width (W)	Always included
Depth (D)	Always included
Height (H)	12" (30 cm)
Corner Depth (D)	Depth = Width
Full Height	WDH
Width (W)	Always included
Depth (D)	Always included
Height (H)	Always included
Corner Depth (D)	Always included

Door Swing is included at the end of the label as either **L** or **R**, but only if all the doors on a cabinet have the same swing.

Here are a few examples of automatic cabinet labels and their meanings:

- **3DB24**: Base cabinet with 3 drawers, 24" wide. Depth and height are standard.
- **SB24R**: Sink base, 24" wide, with a right door. Depth and height are standard.
- **BCW2436R**: Blind wall cabinet, 24" wide, 36" high, with a right door. Depth is standard.
- **DCW2436L**: Diagonal corner wall cabinet, 24" wide, 36" high, with a left door. Depth is standard (equal to width).
- **OTC362490**: Full height cabinet with oven, 36" wide, 24" deep, 90" high.

 The Automatic Labels for Shelves and Partitions are blank, but you can specify custom labels for both. See [Shelf/Partition Specification Dialog on page 462](#).

Cabinet Construction

Both framed and frameless, or European-style, cabinet construction can be specified in Home Designer Pro. You can also specify either the overlay or reveal of cabinet doors, drawers, and panels.

If you know what cabinet construction style you want, you can save time by specifying that style in the Cabinet Defaults dialogs before you start placing cabinets. See [Cabinet Defaults on page 432](#).

FRAMED AND FRAMELESS

A cabinet can be specified as Framed or Frameless on the BOX CONSTRUCTION panel of the Cabinet Specification dialog. See [Box Construction Panel on page 453](#).

The sides of both Framed and Frameless cabinet boxes are 3/4" (18 mm) thick. This value is also the system default Item Height for Separation face items in Frameless cabinets. See [Cabinet Defaults on page 432](#).

Framed cabinets have left and right stiles with widths that can be specified. The Separation value set on the BOX CONSTRUCTION panel of the Cabinet Specification dialog serves as the default Height value for separation face items as well as the default width for left and right stiles. These can be set individually on the FRONT/SIDES/BACK panel. See [Front Panel on page 454](#).

TRADITIONAL OVERLAY

To specify how far doors, drawers and panels overlap vertical stiles and horizontal separations, select **Traditional Overlay** on the BOX CONSTRUCTION panel of the Cabinet Specification dialog and then specify the **Overlap** of all doors, drawers, and panels on the selected cabinet.

When Traditional Overlay is selected, the widths of stiles can be specified on the FRONT/SIDES/BACK panel, as can the heights of selected Separation items; however, the overlap of individual items cannot.

FULL OVERLAY AND REVEAL

To specify the reveal on horizontal separations and vertical stiles, select **Full Overlay** on the BOX CONSTRUCTION panel and then specify the desired **Reveal**. Both the sizes and the reveals on the Left and Right Stiles and on individual Separation items can be customized on the FRONT/SIDES/BACK panel.

INSET DOORS AND DRAWERS

Cabinet doors and drawers can be specified as Inset instead of overlaid on the BOX CONSTRUCTION panel of the Cabinet Specification dialog.

Editing Cabinets

Cabinets can be selected in 2D and 3D views both individually and in groups and edited using the edit handles, the Edit Toolbar and their specification dialog.

 You can marquee-select cabinets of multiple types when the Full Height Cabinet tool is active. See [Marquee Select on page 143](#).

USING THE EDIT HANDLES

Cabinets can be edited like other box-based objects. See [Editing Box-Based Objects on page 158](#). The edit handles that a cabinet displays when selected will vary depending on the view.

When a cabinet is selected in plan view or on its top surface in a 3D view, ten edit handles display: the Move handle at the center, the Rotate handle, and a Resize handle on each edge and at each corner.

In 3D views, cabinets can be selected on any surface: front, side, back or top. When the side of a cabinet is selected, five edit handles are available: the Move handle and a Resize handle on each edge.



When cabinet labels are displayed, a label will move as its cabinet is moved or resized. See [Displaying Cabinets on page 439](#).

Cabinets cannot be concentrically resized, even when the Concentric edit behavior is enabled. See [Defaults, Preferences, and Edit Behaviors on page 137](#).

IN THE SPECIFICATION DIALOG

 A selected cabinet can be customized in a variety of ways in its specification dialog. See [Cabinet Specification Dialog on page 450](#).

When you group select cabinets of different types, some options are not available in the Cabinet Specification dialog. For example, you cannot modify the crown molding on a full height cabinet if it is selected with a base cabinet that does not have crown molding. Any specifications that they share in common, however, can be edited.

Soffits, shelves, and partitions can also be group-selected and edited using a shared specification dialog. It is, however, necessary that only soffits, or only shelves, or only partitions be a part of the selection set in order to access a shared specification dialog.

USING THE EDIT TOOLS

A cabinet or cabinets can be edited in a variety of ways using the buttons on the Edit Toolbar. See [The Edit Toolbar on page 91](#).



The **Open Cabinet Doors/Drawers** and **Close Cabinet Doors/Drawers** tools affect the cabinet's doors and drawers in 2D and 3D views. See [Cabinet Doors and Drawers on page 440](#).



Generate Custom Countertop replaces a base cabinet's countertop with a separate Custom Countertop object. See [Custom Countertops on page 438](#).



Select Next Object allows you to select a fixture inserted into a cabinet. See [Select Next Object on page 143](#).

ADD TO LIBRARY



Cabinets can be saved in the Library Browser. Select a base, wall or full height cabinet or cabinet filler and click the **Add to Library** edit button. See [Add to Library on page 681](#).

USING DIMENSIONS



Like various other objects, cabinets can be moved and resized using dimensions. See [Moving Objects Using Dimensions on page 332](#).

In order to be edited using dimensions, cabinets must be located by them. In the Dimension Defaults dialog, you specify what components of a cabinet are located by dimensions as they are drawn:

- Cabinet sides, corners, and centers can be located in both plan and elevation views.
- Backsplashes, countertops, toe kicks, and moldings can be located in elevation views. The heights of cabinet components cannot, however, be edited using dimensions.
- Automatic Countertops can be located as well as edited in both plan and elevation views provided that Countertops are set to be located.
- Automatic Backsplashes can also be located and edited in both types of views provided that CAD Objects are set to be located.

See [Locate Manual Panel on page 315](#).

If you wish, you can add or move a dimension's extension lines to locate countertop edges in plan view after the dimension line is drawn. In elevation views, the heights of cabinet face items, openings, the toe kick, backsplash, and/or moldings can also be located in this manner.

Depending on whether a cabinet box or Custom Countertop is selected, Temporary Dimensions will locate objects near the Selected Edge somewhat differently: See [Temporary Dimensions on page 325](#).

- If a cabinet box is selected, Temporary Dimensions will locate the nearest wall surface or another cabinet box, but not automatically generated or Custom Countertops.
- If a Custom Countertop is selected, Temporary Dimensions will locate the nearest wall surface, Custom Countertop, or automatically generated countertop edge.

MOVING WALLS WITH CABINETS ATTACHED

When a cabinet is placed or moved against a wall, it will snap to the wall and become attached to it. When a wall is moved, all attached cabinets move with it.

When wall layers are resized or the wall layer definition redefined, the cabinets may become unattached. To reattach, select the cabinets, drag them away from the wall, and then drag them back again.

Editing Cabinet Styles

A variety of settings allow you to customize the appearance of your cabinets to create styles ranging from traditional to contemporary.

If the desired style is known before cabinets are placed, you can save time by specifying that style in the Cabinet Defaults dialogs before you start drawing. See [Cabinet Defaults on page 432](#).

CABINET FACE ITEMS

A variety of different face items can be added to the front of any cabinet, including doors, drawers, cutting boards, and horizontal separations. Face items can be moved, resized, as well as removed and can also be split vertically or horizontally to produce a variety of custom configurations. See [Front Panel on page 454](#).

When adding, removing, or resizing face items, it is helpful to keep a few rules in mind:

- Door and drawer Item Height settings reflect the height of the opening rather than that of the front item. When **Traditional Overlay** is specified, an item's front height will be equal to its **Item Height** plus its top and bottom **Vertical Overlap**.
- When the overall height of a cabinet or the height of a face item is changed, the height of the lowest face item that is not a Separation is adjusted to accommodate the change.
- If you increase the height of the lowest face item, the non-Separation item directly above is adjusted; if you decrease its height, a Blank Area and Separation are created below it.
- If the bottom-most face item on a cabinet is a Separation and you increase its height to be greater than the default value, it will extend down past the bottom of the cabinet, creating a recessed bottom.
- By default, if the bottom-most face item on a cabinet is anything other than a Separation or Blank Area, the cabinet box will be treated as an appliance garage and will not have a bottom.

Note: To ensure that Face Item heights always equal the total cabinet front height, the program automatically adjusts the bottom Face Item as changes are made elsewhere. This means you should start editing Face Items at the top and work down.

DOORS, DRAWERS AND PANELS

- Cabinet doors, drawers, and panels can be applied in either of two ways:
- In the Cabinet Specification dialog. See [Door/Drawer Panel on page 457](#).
- Directly from the Library Browser.

Select a style in the Library, then click on a cabinet to apply the selected style to that cabinet. See [Replace From Library on page 689](#).

A secondary door or drawer style can also be specified - for example, to create glass doors above solid doors in wall cabinets. See [Front Panel on page 454](#).

FRAMED AND FRAMELESS CABINETS

Both framed and European-style frameless cabinets can be specified in Home Designer Pro.

For both types of cabinet, you can define the door and drawer overlay or specify inset doors. On a traditional framed cabinet, you can also control the size of the rails and stiles. See [Front Panel on page 454](#).

CABINET HARDWARE AND MOLDINGS

Cabinet handles, pulls, and hinges can be assigned in the Cabinet Specification dialog. See [Door/Drawer Panel on page 457](#).

In 3D views, cabinet hardware can also be applied directly from the Library Browser. Select a cabinet hardware item in the Library, then click on a cabinet door or drawer to assign it to face items of that type. See [Inserted Objects on page 687](#).

The hardware on individual doors and drawers can also be customized. See [Front Panel on page 454](#).

Multiple molding profiles can also be applied around the perimeter of a cabinet at any height. For example, you may want an edge profile around base cabinet countertops and a crown molding that ties together the tops of the wall cabinets and full height cabinets. Moldings are automatically suppressed along any side where the cabinet is within 3" (75 mm) of a wall, another cabinet, a Partition, or free-standing appliance from the Library. See [Applying Moldings on page 665](#).



COUNTERTOPS AND BACKSPLASHES

The countertop thickness, overhang, edge profile, and material for a selected base cabinet can be specified in the Cabinet Specification dialog. See [General Panel on page 451](#) and [Moldings Panel on page 665](#).

Backsplashes can be applied to base cabinets as well as down from wall cabinets on the GENERAL panel of their specification dialogs.

Custom Countertops and Backsplashes can also be created independent of base or wall cabinets. See [The Cabinet Tools on page 434](#).

CABINET SHELVES

You can customize the shelves inside of base, wall, and full height cabinet boxes. See *Cabinet Shelf Specification Dialog on page 461*.

Special Cabinets

There are a number of special cabinet shapes that can be specified. Certain requirements must be met before some special cabinet shapes can be specified. If the requirements are not met, a warning message will explain what is needed. See *Cabinet Specification Dialog on page 450*.



Note: Only Standard cabinets can be the default cabinet Type. See *Cabinet Defaults on page 432*.

STANDARD CABINETS

Select **Build> Cabinet> Base Cabinet**  and click in plan view to place a standard, rectangular base cabinet.



CORNER CABINETS

To create a corner cabinet, click as close to an inside wall corner as possible using either the **Base Cabinet** , **Wall Cabinet** , or **Full Height**  cabinet tool. A corner cabinet remains a corner cabinet when it is moved, edited or copied.

You can turn an existing cabinet into a corner cabinet by selecting “Corner” from the **Special** drop-down list in its specification dialog. See *General Panel on page 451*.

- Before a corner cabinet can be specified in the Cabinet Specification dialog, the cabinet’s Width must be greater than its Depth.
- The **Left** and the **Right Side Widths** can be set independently for corner cabinets.



- You can specify a Diagonal Door on corner cabinets to create an angled corner cabinet. See *Front Panel on page 454*.



END CABINETS

To turn a cabinet into an end cabinet, specify its Type as “Left End” or “Right End”.



- End Cabinets have an angled front and side.
- The cabinet width must be no greater than its depth for an end cabinet to be specified.

RADIUS END CABINETS

To turn a cabinet into a radius end cabinet, specify its Type as “Left Radius End” or “Right Radius End”.



As you face the cabinet, a right radius end curves to the right, and a left radius end curves to the left.

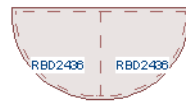

PENINSULA RADIUS CABINETS

To turn a cabinet into an end cabinet, specify its Type as “Peninsula Radius”.



The radius can be adjusted by changing the Depth/Bow Depth value. See *General Panel on page 451*.

ANGLED FRONT CABINETS

To assign an angled front to a cabinet, specify its Type as “Angled Front”.



- The length of the left and right side of an **Angled Front** cabinet can be defined by changing the Depth/Bow Depth value. See *General Panel on page 451*.

KITCHEN ISLANDS

To create a kitchen island, simply place several cabinets back-to-back and/or side-to-side. Match the widths so that each cabinet back or side meets the back or side of only one other cabinet. If this is not done, the lines separating the cabinets cannot be suppressed.

A given side of a single cabinet cannot merge with the edges of two different cabinets. The example below shows two instances of cabinets placed back-to-back. Cabinet fronts and joining surfaces are shown.

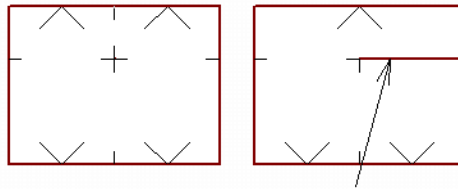

BLIND CABINETS

Often, when two cabinets meet in a corner, one is partially hidden by the other. This partially hidden cabinet is called a “blind” cabinet. Home Designer will resize and offset the front items of the partially hidden cabinet so that they are not located in the hidden portion of the cabinet face.



You can also create a blind cabinet manually by controlling the widths of a cabinet’s left or right stile in its Cabinet Specification dialog. See *Front Panel on page 454*.

Cabinet Specification Dialog



Select one or more cabinets and click the **Open Object** edit button to open the Cabinet Specification dialog.

The options in the Cabinet Specification dialogs are similar to the corresponding Cabinet Defaults dialog. See [Cabinet Defaults on page 432](#).

The Cabinet Specification dialogs have the following panels:

GENERAL PANEL

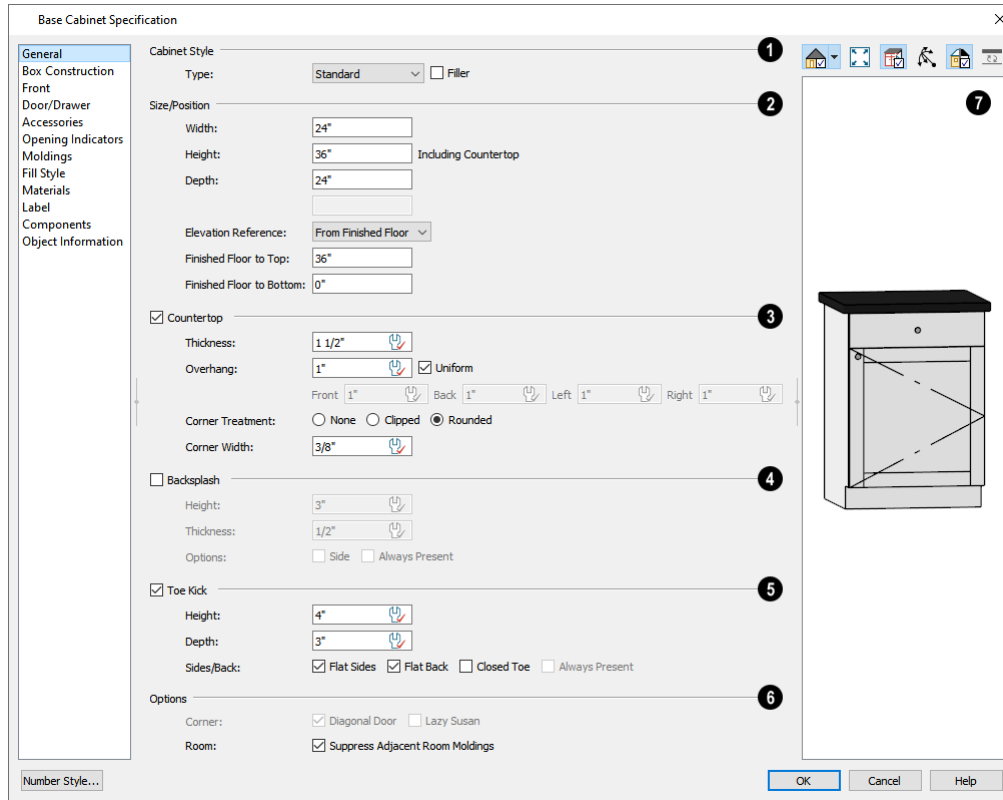

1 Cabinet Style

A number of **Cabinet Types** are available in the drop-down list. Certain requirements must be met before some types can be specified. Not available in the Cabinet Defaults dialogs. See [Special Cabinets on page 448](#).

2 Size/Position

The selected cabinet's dimensions and position relative to the floor can be specified here. Fractional values are supported to 1/16th of an inch (1 mm).

- Specify the **Width** of the cabinet box, as measured across the front of the cabinet box from left to right. This does not include the countertop overhang.
- Specify the **Height (Including Counter)** of the cabinet box, as measured from bottom to top. For base cabinets, this value includes the countertop thickness, but not the height of the backsplash.

Note: Height refers to the height of the entire cabinet, including countertop and toe kick. If you change the Countertop Thickness or Toe Kick Height, the cabinet's total height is not altered. Instead, the cabinet face height and the heights of face items change in response.

- Specify the **Depth** of the cabinet box, as measured from front to back. It does not include the thickness of overlay doors or the countertop overhang.
- For Corner cabinets, the **Width** and **Depth** fields are instead named **Right Side Width** and **Left Side Width**.
- For Corner cabinets, specify the **Bow Depth**. A positive number creates a bow and a negative number, an inside bow. Not available for Corner cabinets if Diagonal is unchecked on the Front panel. See *Front Panel on page 454*.
- For Angled Front cabinets, specify the **Left Depth** and **Right Depth** rather than the Depth and Bow Depth.
- Select the **Elevation Reference** from the drop-down list. This determines where the next two settings are measured from and also affects their setting labels.
- Specify the **to Top** distance, measured from the Elevation Reference to the top of the cabinet's countertop.
- Specify the **to Bottom** distance, measured from the Elevation Reference to the bottom of the cabinet, including the toe kick.

3 Countertop

Specify the dimensions and style of the selected cabinet's **Countertop**, or uncheck this box to prevent it from having a countertop. Only available for base cabinets.

- Specify the countertop **Thickness**. Changing this value does not alter the cabinet height, but it does affect the height of face items. See *Front Panel on page 454*.
- Specify the countertop **Overhang**. Uncheck **Uniform** to specify separate values for each side in the fields below, or leave it checked to use the same value for all sides. Overhangs do not generate on sides that are against a wall, free-standing appliance, Partition, or another Base or Full Height Cabinet. See *Cabinet Snapping and Aligning on page 436*.
- **Corner Treatment** - Specify **Clipped** or **Rounded** countertop corners.
- When Clipped or Rounded is selected, specify the **Corner Width**, which is measured from the original location of the corner to the point where the straight front edge ends.

4 Backsplash

Check the box beside **Backsplash**, then specify its dimensions and when it should generate, or leave this box unchecked to prevent the selected base or wall cabinet from having a backsplash.

- Specify the backsplash **Height** and **Thickness**. Height is only available for base cabinets - not wall cabinets.
- Check **Side** to add the backsplash to the side of the cabinet if it is against a wall or a taller cabinet. Not available for Corner cabinets.
- Check **Always Present** to display the backsplash at all times. If unchecked, a backsplash is present only when the cabinet is against a wall.
- Check **Backsplash to Base Below** to extend a backsplash from the selected wall cabinet down to the backsplash or countertop of the base cabinet below. Only available for wall cabinets.

Note: While a base cabinet's backsplash is measured from the countertop up, a wall cabinet's backsplash extends downward.

5 Toe Kick

Specify the dimensions and style of the selected cabinet's **Toe Kick**, or uncheck this box to prevent it from having a toe kick. Only available for base and full height cabinets. Regardless of the settings here, toe kicks do not generate on sides that are against a wall, free-standing appliance, Partition, or another Base or Full Height Cabinet.

- Specify the toe kick's **Height** and **Depth**. Changing the Height does not alter the cabinet height but does affect the heights of the cabinet face and face items.
- **Flat Sides** can be added to base and full height cabinets. Checking Flat Sides eliminates the toe kick area on the exposed end(s) of the cabinet.
- Check **Flat Back** to eliminate the toe kick on a cabinet with an exposed back. This does not eliminate the toe kick on the cabinet front.
- Check **Closed Toe** to extend the cabinet sides to cover the sides of the toe kick. If pilasters that do not extend to the floor are specified, checking this places a support block under them at Exposed Ends. See [Accessories Panel on page 459](#).

6 Options

- Uncheck **Diagonal Door** to create double doors at right angles instead of a single diagonal door. This option is checked by default in the Cabinet Defaults dialog and is only available for Corner Cabinets. See [Corner Cabinets on page 448](#).
- Check **Lazy Susan** to indicate a lazy Susan in the cabinet's label and its appearance in plan view. This option does not display in 3D views.
- When **Suppress Adjacent Room Moldings** is checked, room moldings do not generate on walls where the selected cabinet touches them. Uncheck this box to allow room moldings to generate through the cabinet. See [Room Moldings on page 300](#).

7 Preview

A preview of the selected cabinet displays on the right side of the panel. See [Dialog Preview Panes on page 20](#).

BOX CONSTRUCTION PANEL

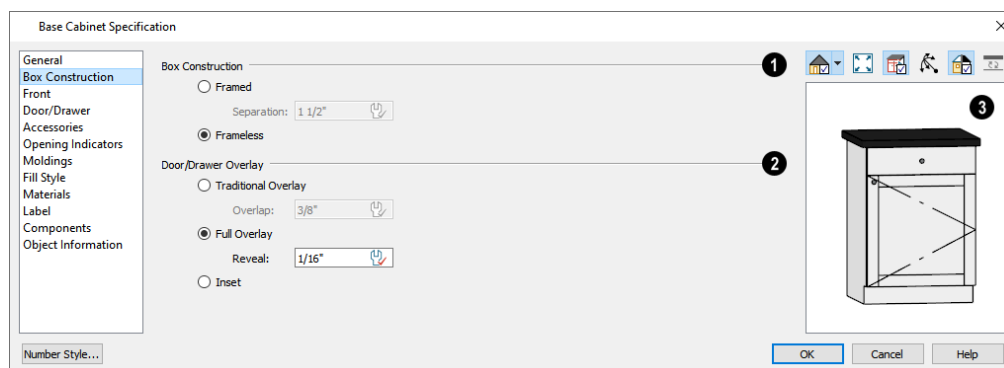

1 Box Construction

Define the **Box Construction** of the selected cabinet. Select **Framed** to create a traditional framed cabinet and enable the settings below, or choose **Frameless** for a European style cabinet.

- Specify the **Separation** value, which is the width of the horizontal face frame piece between doors, drawers, and other face items.

2 Door/Drawer Overlay

Define the **Door/Drawer Overlay** of the selected cabinet. See *Cabinet Construction on page 443*.

- Select **Traditional Overlay**, then specify the **Overlap** value.
- Select **Full Overlay**, then specify the **Reveal**, which is the distance between door and drawer front items. This serves as the default for the Left and Right Reveal settings on THE FRONT/SIDES/BACK panel.
- Select **Inset** to produce doors and drawers that are flush with the rails and stiles rather than overlaying it.

3 Preview

A preview of the selected cabinet displays on the right side of the panel. See *Dialog Preview Panes on page 20*.

FRONT PANEL

If you click on a cabinet face item in the preview on the right side of the dialog, the FRONT panel will become active and that face item will be selected and can be edited.

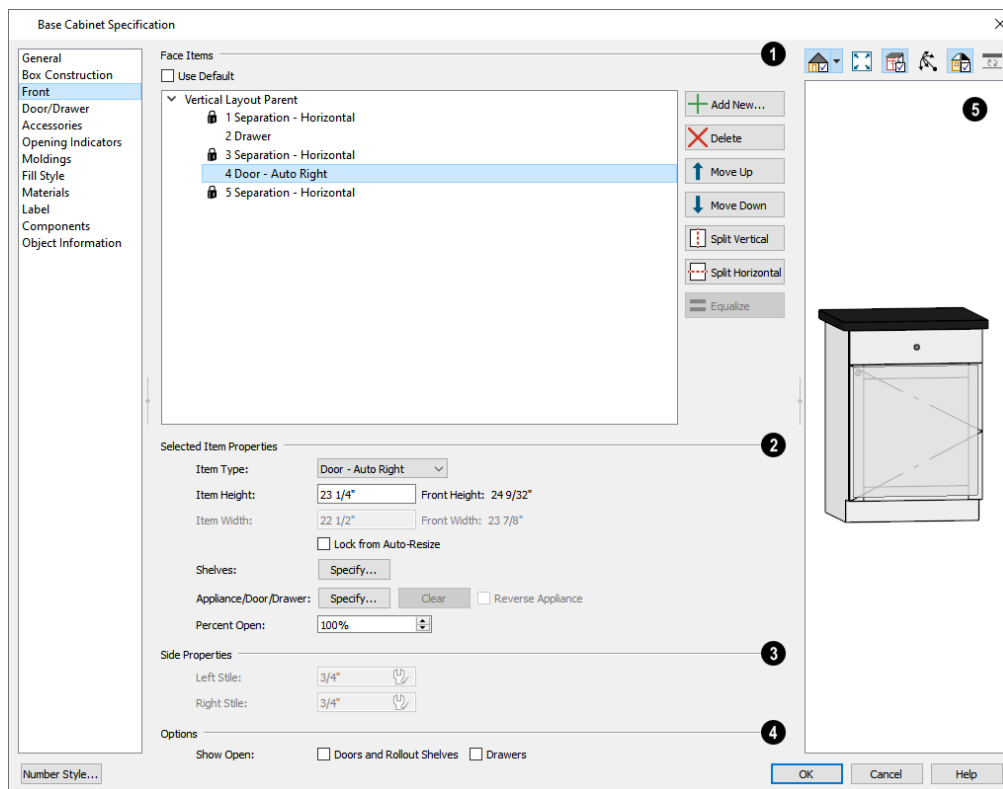

1 Face Items

Most of the **Face Items** settings are only active when a door, drawer, or other face item is selected. To select a face item, click on its name in the list or click on it in the preview on the right.

When a face item is selected, it is highlighted in the list as well as in the preview; its attributes can be edited and the list can be navigated using the arrow and number keys. The vertical frame pieces on the sides of the cabinet front are referred to as stiles and cannot be selected in the preview. See *Cabinet Face Items on page 446*.

- A numbered tree list of face items displays here. Item numbers start at the top of the cabinet and go down the face to the bottom of the cabinet. Item 1 is usually the top face frame Separation, or rail. The selected face item is highlighted; if no item is selected, the “Vertical Layout Parent” heading will be highlighted.
- Click **Add New** to add a new face item directly below the currently selected item. When a face item is added, the height of the lowest item on the cabinet front is reduced to make room for the new item. If you click **Add New** with no face item selected, the new item is added to the bottom of the cabinet face.
- In the New Cabinet Face Item dialog, define the **Item Type**, **Item Height**, and click OK. If the Item Type is “Separation”, you can check **Default** to use the default Separation Height.

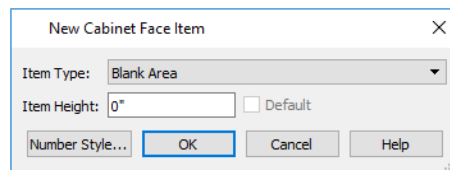

- Click **Delete** to remove the selected face item. When an Auto Left, Auto Right, Left, Right, or Double Door is deleted, it is replaced by an Opening; when other face item types are deleted, the height of the lowest item is increased to make up the difference. You can also press the Delete key on the keyboard.



The program tries to maintain a single separation between all face items. When you add or delete a face item, separations are usually added or deleted with them.

- Click **Move Up** to move the currently selected item up one position, switching places with the item directly above.
- Click **Move Down** to move the currently selected item down one position, switching places with the item directly below.
- When the selected face item is part of a “Layout - Horizontal”, the **Move Left** and/or **Move Right** buttons will be available instead. Click either to have the selected item switch places with its neighbor.
- Click **Split Vertical** to divide the selected face item into two separate side-by-side items of the same Item Type and Height. A vertical separation is added between them and together the three new items have the same Width as the original item. Not available for Horizontal or Vertical Layouts, Appliances, Separations, or for items 1 1/2” (50 mm) wide or less.
- Click **Split Horizontal** to divide the selected face item into two separate items of the same Item Type and Width, stacked one above the other. A horizontal separation is added between them and together the three new items have the same Height as the original item. Not available for Horizontal or Vertical Layouts, Appliances, Separations, or for items 1 1/2” (51 mm) tall or less.
- Click **Equalize** to make the sizes of a face item’s sub-items equal in size. Only available if the selected item is a Vertical or Horizontal Layout with sub-items.

2 Selected Item Properties

- Choose the selected face item's **Item Type** from the drop-down list:

Item Type	Special Behaviors
Blank Area	Creates a solid, flat surface.
Horizontal Layout	Creates a group of identical, side-by-side items separated by vertical separations.
Vertical Layout	Creates a group of identical, stacked items separated by horizontal separations.
False Drawer and False Double Drawer	Assumes the appearance of specified the drawer style, including hardware.
Drawer and Double Drawer	Creates a single or double drawer of the specified drawer style, including hardware.
Cutting Board	Creates a cutting board.
Auto Right and Auto Left Door	Become double doors when the width of the opening is greater than 24" (600 mm).
Left, Right, and Double Door	As specified, regardless of opening width.
Door Panel	Assumes the appearance of the specified door style but with no hardware.
Opening	Creates an opening with shelves.
Separation	Creates a horizontal rail, or frame piece.
Appliance	Creates an opening with no shelves, for which an appliance can be specified.

- Specify the selected face item's **Item Height**. Fractional values are supported to 1/16th of an inch (1 mm). For doors and drawers, this is the height of the opening: the selected door or drawer's Front Height is reported to the right for reference. A door or drawer's front height is equal to its Height plus its top and bottom Vertical Overlap. For best results, edit face item heights starting at the top of the cabinet and work down. See [Cabinet Face Items on page 446](#).
- Specify the selected face item's **Item Width**. Fractional values are supported to 1/16th of an inch (1 mm). For doors and drawers, this is the width of the opening: the selected door or drawer's Front Width is reported to the right for reference. Only available for components of a Horizontal Layout.
- Check **Lock from Auto Resize** to prevent the selected face item from resizing when the cabinet is resized, new face items are added, or when the **Equalize** button is clicked.

- **Shelves** - Click the **Specify** button to open the Cabinet Shelves Specification dialog and specify the shelf configuration for a selected Door or Opening Face Item. See *Cabinet Shelf Specification Dialog on page 461*.
- When an **Appliance/Door/Drawer** or panel is selected, click the **Specify** button to choose an appliance from the Library or to customize the selected door, drawer, or panel's front style and hardware. The options available depend on the type of face item currently selected. See *Select Library Object Dialog on page 688* and *Door/Drawer Panel on page 457*.
- Click the **Clear** button to remove the selected appliance from the cabinet or to reset the selected door or drawer so it uses hardware and front style assigned to the cabinet.
- Check **Reverse Appliance** to reverse the selected face item from left to right: for example, to move a dishwasher's controls from the left side to the right. Only available when an "Appliance" item is selected. See *Inserted Objects on page 687*.

3 Side Properties



- Specify the widths of the **Left Stile** and **Right Stile**. Only available when the selected cabinet has **Framed Box Construction** specified. See *Framed and Frameless Cabinets on page 447*.

4 Options

- Specify which types of front items you would like to **Show Open** in plan, 3D, and cross section/elevation views. See *Cabinet Doors and Drawers on page 440*.

5 Preview

A preview of the selected cabinet displays on the right side of the panel. See *Dialog Preview Panes on page 20*.

- **Select Cabinet Face Item**  mode is active by default and allows you to click on a face item like a door, drawer, or separation in the preview to select it for editing. The selected face item is highlighted in grey.
- **Mouse-Orbit Camera**  mode allows you to orbit around the preview of the cabinet. When this is active, you can right-click on a front item to select it.

DOOR/DRAWER PANEL

The settings on the DOOR/DRAWER panel allow you to control the appearance of the selected cabinet's doors, drawers and hardware.

Similar settings are also found in the Door and Drawer Face Item Specification dialogs, which allow you to customize the door and drawer style as well as the hardware for individual cabinet face items. See *Front Panel on page 454*.

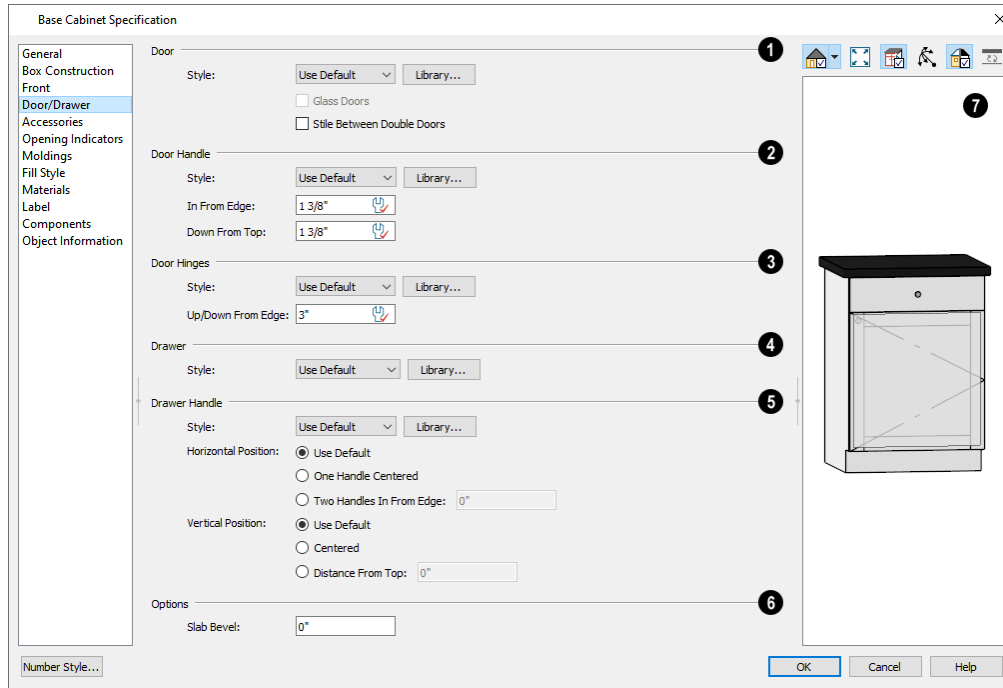

1 Door

- Select a door **Style** from the drop-down list. See *Doors, Drawers and Panels on page 447*.
- Select “Use Default” to apply the door style specified in the defaults dialog for the selected cabinet’s type. See *Cabinet Defaults on page 432*.
- Select “Slab Doors” to apply a flat door front or “Framed Doors” to apply a door with a frame and flat panel front.
- Select “Library” or click the **Library** button to select a cabinet door from the **library**. If a library door has been previously selected, its name will display in the list. See *Select Library Object Dialog on page 688*.
- Check **Glass Doors** to use a glass material for the panel of Framed doors or for the entire door for Slab doors. Not available when “Library” is the selected door Style.
- Check **Stile Between Doors** to separate double doors and double drawers with a stile. Other face items types are not affected by this setting.

2 Door Handle

- Select a door handle **Style** from the drop-down list or choose one from the **Library**.
- Specify the position of the handle **In From Edge**, as measured from the edge of the door opposite the hinges.
- Specify the height of the handle **Down From Top**, as measured from the top edge of the door. For wall cabinets, this value is measured **Up From Bottom**.

3 Door Hinges

- Select a door hinge **Style** from the drop-down list or choose one from the **Library**.
- Specify the location of the hinges **Up/Down From Edge**, as measured from the door edge. If the cabinet door is more than 35 1/4" (880 mm) high, three hinges will be created instead of two.

4 Drawer

Select a drawer **Style** from the drop-down list or choose one from the **Library**. For best results, "Framed" drawers should be at least 6" (150 mm) high.

5 Drawer Handle

- Select a drawer handle **Style** from the drop-down list or choose one from the **Library**.
- Specify the **Horizontal Position** of the drawer handle(s): Choose **Use Default** to use the default position; **One Handle Centered** for a single handle centered on the drawer face; or **Two Handles In From Edge** for two handles set in from the drawer sides by the value specified in the text field.
- Specify the **Vertical Position** of the drawer handle(s): Choose **Use Default** to use the default position, **Centered** for handle(s) centered on the drawer face, or specify the handle's **Distance From Top**.

6 Options

- Enter a **Slab Bevel** width to create beveled edges on Slab drawers and doors. The bevel width, as viewed from the front, has a maximum value of 3" (75 mm). Framed and Library doors are not affected by this setting.

7 Preview

A preview of the selected cabinet displays on the right side of the panel. See [Dialog Preview Panes on page 20](#).

ACCESSORIES PANEL

The ACCESSORIES panel is only available in the Base Cabinet Specification dialog. It is not available for wall or full height cabinets, nor is it found in the Base Cabinet Defaults dialog.

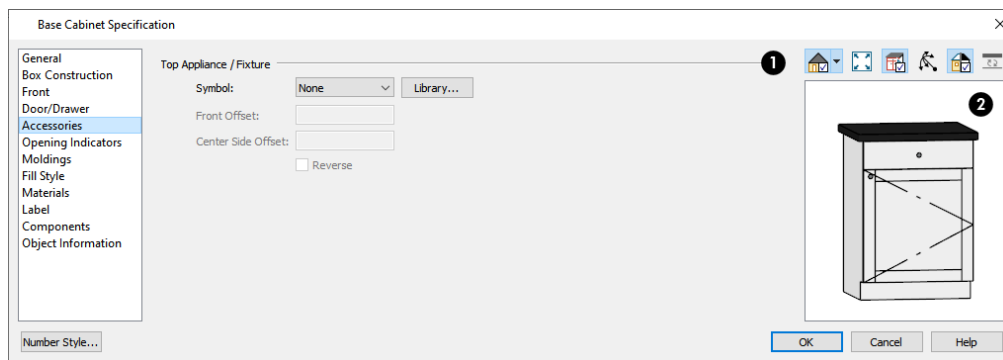

1 Top Appliance/Fixture

The **Top Appliance/Fixture** settings apply to a fixture inserted into a base cabinet's countertop. These settings are not available in the Base Cabinet Defaults dialog. See [Built-In Sinks and Appliances on page 435](#).

- Select a fixture **Symbol** from the drop-down list, or choose "None". If a fixture is inserted into the countertop, its name will be listed. If no top fixture is present, you can select "Library" to select a fixture symbol from the Library.
- Specify the **Front Offset**, which is the distance from the front of the fixture to the front of the cabinet box. A positive value offsets the fixture towards the back of the cabinet while a negative value moves it forward.
- Specify the **Center Side Offset**, which is the distance between the fixture's center and that of the cabinet. A positive value offsets the fixture to the right while a negative value offsets it to the left.
- Check **Reverse** to reverse the selected fixture from left to right: for example, to move a cooktop's controls from the left side to the right. See [Inserted Objects on page 687](#).

2 Preview

A preview of the selected cabinet displays on the right side of the panel. See [Dialog Preview Panes on page 20](#).

OPENING INDICATORS PANEL

The settings on the OPENING INDICATORS panel allow you to control whether an opening indicator displays on the selected cabinet's door(s) in camera views. See [Opening Indicators Panel on page 390](#).

MOLDINGS PANEL

The settings on the MOLDINGS panel allow you to assign one or more horizontal moldings around the selected cabinet. See [Editing Cabinet Styles on page 446](#).

For information about the settings here, see [Moldings Panel on page 665](#).

FILL STYLE PANEL

The settings on the FILL STYLE panel affect the appearance of the selected cabinet in plan view. For more information, see [Fill Style Specification Dialog on page 131](#).

MATERIALS PANEL

The settings on the MATERIALS panel affect the appearance of the selected cabinet in 3D views. For information about these settings, see [Materials Panel on page 716](#).

Some material options may be disabled if the selected cabinet is a manufacturer symbol.

LABEL PANEL

Cabinet labels display in plan view when the "Cabinets, Labels" layer is turned on and use the Text Style assigned to that layer. See [Cabinet Labels on page 441](#).

For more information about the settings on this panel, see [Label Panel on page 363](#).

COMPONENTS PANEL

The information on the COMPONENTS panel can be used in the materials list. For more information, see [Components Panel on page 921](#).

OBJECT INFORMATION PANEL

The information entered on the OBJECT INFORMATION panel can be used in the materials list. For more information, see *Object Information Panel on page 922*.

Cabinet Shelf Specification Dialog

In the Base Cabinet, Wall Cabinet, or Full Height Cabinet Specification dialog, select a door or opening face item and click the **Specify Shelves** button to open the Cabinet Shelf Specification dialog. See *Front Panel on page 454*.

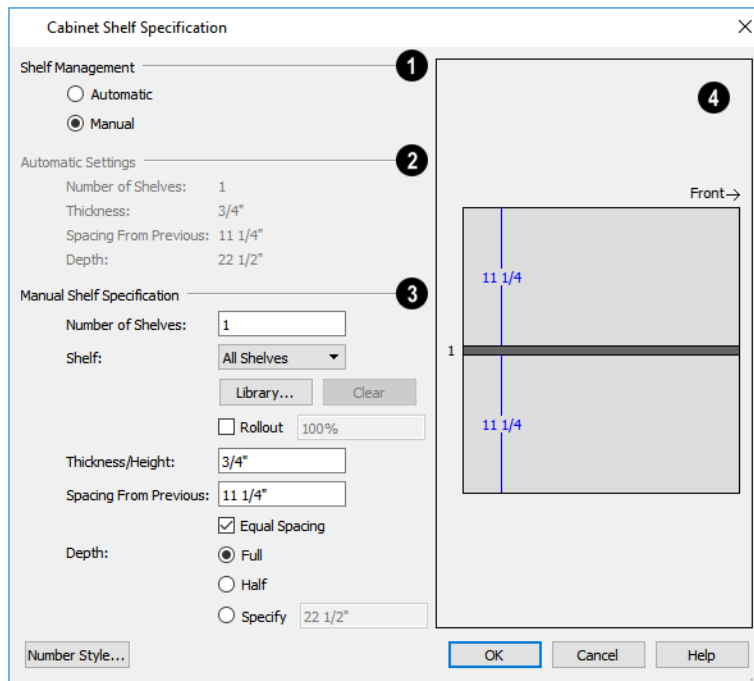

1 Shelf Management

Specify how shelves in the selected face item are created.

- By default, cabinet doors and openings receive **Automatic** cabinet shelves. The number of shelves, shelf type, thickness, spacing, and depth display below.
- Select the **Manual** radio button to specify the shelving for the selected door or opening. If the cabinet is resized after shelving has been manually edited, the specifications are maintained, but all shelves may not display in all situations.

2 Automatic Settings

Displayed for reference only.

3 Manual Shelf Specification

The following settings are available when **Manual** is selected, above:

- Specify the total **Number of Shelves** in the selected door or opening front item.
- Select a **Shelf** from the drop-down list to customize its settings. To edit all shelves at once, choose “All Shelves”.

Note: If “All Shelves” is selected after changes are made to an individual shelf, “No Change” may display in the settings that follow.

- Click the **Library** button to select a shelf, storage, or organization object from the Library Browser. See *Inserted Objects on page 687*.
- Click the **Clear** button to restore the default shelf style.
- Check **Rollout**, then specify the amount that the shelf rolls out when set to Show Open. Only available for Standard cabinets. See *Rollout Shelves and Storage on page 440*.
- Specify the **Thickness/Height** of the shelves or storage item.
- Specify the **Spacing From Previous**, which is the distance from the bottom of the selected shelf to the top of the shelf below it.
- If the **Spacing From Previous** value is changed, **Equal Spacing** will become unchecked. Check this box to produce evenly space the shelves within the selected cabinet front item.
- Specify the selected shelf’s **Depth**: choose **Full**, **Half**, or **Specify** a custom value in inches (mm).

4 Preview

The preview shows shelf numbers and spacing. Shelf thickness and depth are also represented. Press the Tab key to update the preview as changes are made.

Shelf/Partition Specification Dialog

Select a shelf or partition and click the **Open Object** edit button to open the Shelf Specification or Partition Specification dialog.

The options in these specification dialogs are similar to the corresponding defaults dialogs. See *Cabinet Defaults on page 432*.

GENERAL PANEL

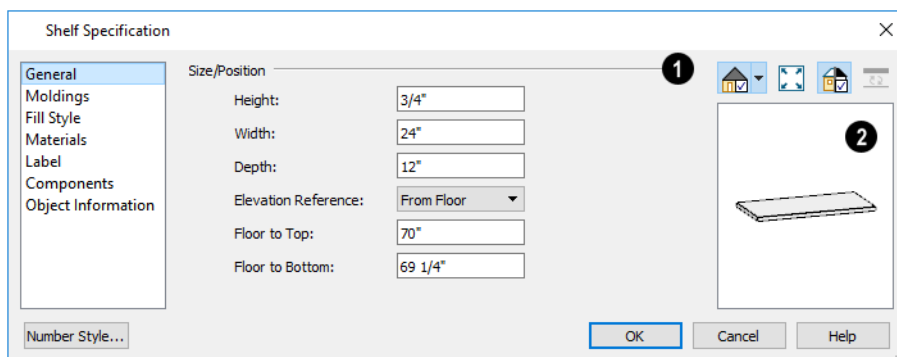

1 Size/Position

Specify the **Height**, **Width**, and **Depth** of the shelf or partition.

- Select the **Elevation Reference** from the drop-down list. This determines where the next two settings are measured from and also affects their setting labels.
- Specify the **to Top** distance, measured from the Elevation Reference to the top of the shelf or partition.
- Specify the **to Bottom** distance, measured from the Elevation Reference to the bottom of the shelf or partition.

2 Preview

A preview of the selected object displays on the right side of the panel. See [Dialog Preview Panes on page 20](#).

FILL STYLE PANEL

The settings on the FILL STYLE panel affect the appearance of the selected object in plan view. For information about these settings, see [Fill Style Specification Dialog on page 131](#).

MOLDINGS PANEL

The settings on the MOLDINGS panel allow you to apply molding to the selected object. For information about these settings, see [Moldings Panel on page 665](#).

MATERIALS PANEL

The settings on the MATERIALS panel affect the appearance of the selected object in 3D views. For information about these settings, see [Materials Panel on page 716](#).

LABEL PANEL

Shelf and Partition labels display in plan view when the “Cabinets, Labels” layer is turned on and use the Text Style assigned to that layer. The Automatic Labels for Shelves and Partitions are blank, but you can specify custom labels if you wish. See [Cabinet Labels on page 441](#).

For more information about the settings on this panel, see [Label Panel on page 363](#).

COMPONENTS PANEL

The information on the COMPONENTS panel can be used in the materials list. For more information, see [Components Panel on page 921](#).

OBJECT INFORMATION PANEL

The information entered on the OBJECT INFORMATION panel can be used in the materials list. For more information, see [Object Information Panel on page 922](#).

Custom Countertop Specification Dialog



Select a custom countertop and click the **Open Object** edit button to open the Custom Countertop Specification dialog.

GENERAL PANEL

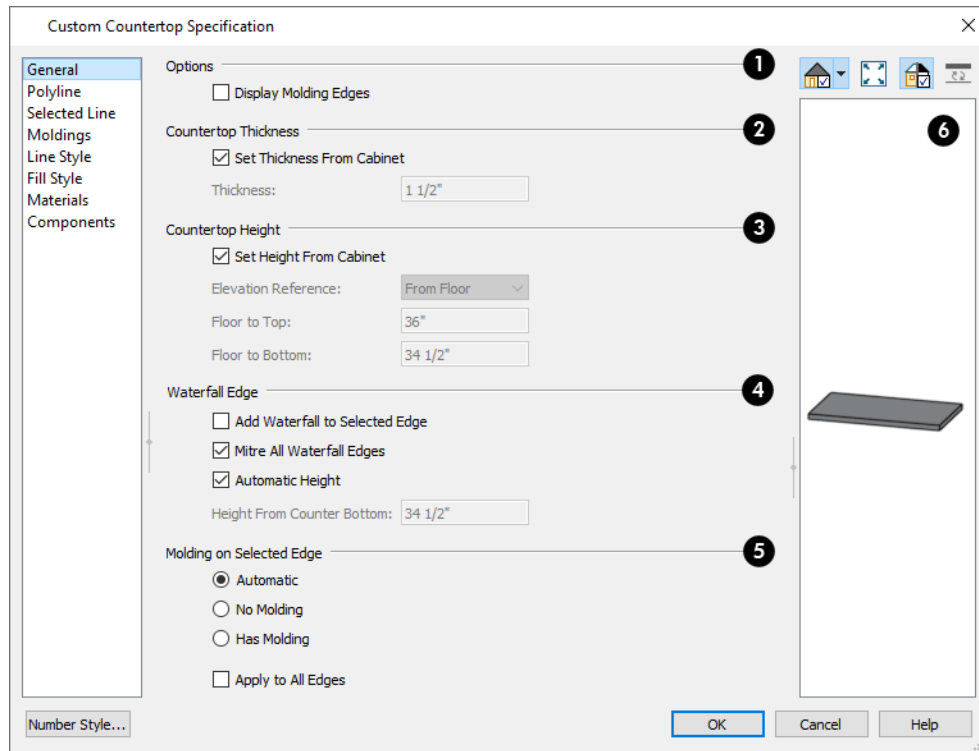

1 Options

- Check **No Molding On Selected Edge** to turn off the display of molding on the selected edge. Only has an effect when a molding is specified for the countertop on the **MOLDINGS** panel of this dialog.
- Check **Display Molding Edges** to display two edge lines instead of one, indicating the width of any molding applied to the countertop. Only has an effect when a molding profile is specified for the countertop.

2 Countertop Thickness

- Uncheck **Set Thickness From Cabinet**, then specify the Thickness of the selected Custom Countertop below. When this is checked, the thickness is inherited from the cabinet below or from the Base Cabinet Defaults dialog if no cabinet is present below.

3 Countertop Height

- Uncheck **Set Height from Cabinet**, then specify the height of the selected Custom Countertop using the settings below. When this is checked, Countertop height is determined by the cabinet below or by the default base cabinet counter thickness if no cabinet is present below.
- Select the **Elevation Reference** from the drop-down list. This determines where the next two settings are measured from and also affects their setting labels.
- Specify the height **to Top**, which is measured from the selected Elevation Reference to the top of the countertop.
- Specify the height **to Bottom**, which is measured from the selected Elevation Reference to the bottom of the countertop.

4 Waterfall Edge

Control whether the selected countertop edge has a waterfall and specify its attributes. See [Waterfall Countertops on page 439](#).

- Check **Add Waterfall to Selected Edge** to add a vertical extension to the selected edge of the countertop.
- Uncheck **Mitre All Waterfall Edges** to create butt joints with seams that may be visible in some views where the waterfall meets the horizontal countertop and any adjacent waterfall edges. When checked, these joints are mitered so the only visible seams are located at the corners.
- When **Automatic Height** is checked, the waterfall builds down to the floor height countertop's room, or the default floor height for the current floor if it is not in a room. Uncheck this to specify the waterfall's vertical height, below.
- Specify the **Height from Counter Bottom**, measured from the bottom of the horizontal countertop to the bottom of the waterfall.

5 Molding on Selected Edge

An edge profile for the selected counter can be specified on the Moldings panel. See [Selected Edge on page 142](#).

- Select **Automatic** to remove the edge profile from the selected edge when it is positioned against a wall and generate it otherwise.
- Select **No Molding** to remove the edge profile from the selected edge regardless of where it is positioned.
- Select **Has Molding** to generate the edge profile on the selected edge regardless of where it is positioned.
- Check **Apply to All Edges** to apply the option specified for the currently selected edge to all edges of the countertop. This is an action rather than a state: the next time this dialog is opened, this box will be unchecked.

6 Preview

A preview of the selected countertop displays on the right side of the panel. See [Dialog Preview Panes on page 20](#).

POLYLINE PANEL

The POLYLINE panel states the length of the countertop's **Perimeter**, its **Area**, and its **Volume**. See [Polyline Panel on page 215](#).

SELECTED LINE/ARC PANEL

The SELECTED LINE panel is available when the selected edge is a line as opposed to an arc. For more information, see [Line Panel on page 203](#).

The SELECTED ARC panel is available when the selected edge has been converted to an arc. For more information, see [Arc Panel on page 210](#).

See, too, [Selected Edge on page 142](#) and [Change Line/Arc on page 174](#).

MOLDINGS PANEL

The settings on the MOLDINGS panel allow you to apply an edge profile to the selected countertop. For information about these settings, see [Moldings Panel on page 665](#).

LINE STYLE PANEL

For information about the settings on this panel, see [Line Style Panel on page 204](#).

FILL STYLE PANEL

The settings on the FILL STYLE panel affect the appearance of the selected countertop in plan view. For information about these settings, see [Fill Style Specification Dialog on page 131](#).

MATERIALS PANEL

The settings on the MATERIALS panel affect the appearance of the selected countertop in 3D views. For information about these settings, see [Materials Panel on page 716](#).

COMPONENTS PANEL

The information on the COMPONENTS panel can be used in the materials list. For more information, see [Components Panel on page 921](#).

Custom Backsplash Specification Dialog

 Select a Custom Backsplash and click the **Open Object** edit button to open the Custom Backsplash Specification dialog.

STRUCTURE PANEL

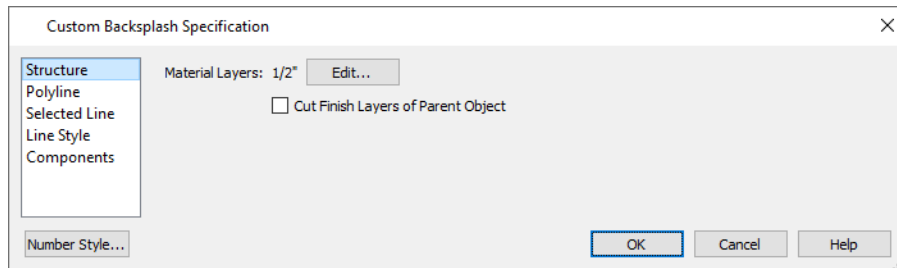

- The total thickness of the **Material Layers** displays here for reference.
- Click the **Edit** button to open the Material Layers Definition dialog. See [Material Layers Definition Dialogs on page 709](#).

- Uncheck **Cut Finish Layers of Parent Object** to fix the selected Material Region to the surface of its parent floor platform or wall. When checked, it cuts into the finish layers of the polyline's parent object and replaces those layers with its own within its perimeter.

POLYLINE PANEL

The POLYLINE panel indicates the length of the region's **Perimeter** and its enclosed **Area**. See *Polyline Panel on page 215*.

SELECTED LINE/ARC PANEL

The SELECTED LINE panel is available when the selected edge is a line as opposed to an arc. See *Line Panel on page 203*.

The SELECTED ARC panel is available when the selected edge has been converted into an arc. See *Arc Panel on page 210*.

See, too, *Selected Edge on page 142* and *Change Line/Arc on page 174*.

LINE STYLE PANEL

For information about the settings on this panel, see *Line Style Panel on page 204*.

FILL STYLE PANEL

The FILL STYLE panel is only available for Floor Material Regions. For information about the settings on this panel, see *Fill Style Specification Dialog on page 131*.

COMPONENTS PANEL

The information on the COMPONENTS panel can be used in the materials list. For more information, see *Components Panel on page 921*.

Electrical

Chapter 18

The electrical plan shows the location of all electrical objects such as lights, switches, outlets, smoke detectors and vent fans. Basic wiring diagrams show which objects share circuits and the locations of the controlling switches.

Electrical objects can be displayed in 2D and 3D views. Some electrical light fixtures also add light sources to 3D views. See *Lighting on page 772*.

Usually, the electrical plan is one of the last additions to a plan since the position of most electrical objects is determined by the location of walls, cabinets and other objects.



Building requirements vary throughout the country and around the world. It is your responsibility to comply with local codes.

TOPICS

Electrical Defaults Dialog	469
The Electrical Tools	470
Placing Electrical Objects	472
Auto Place Outlets	472
Creating Wiring Schematics	473
Electrical Library Content	474
Displaying Electrical Objects	474
Editing Electrical Objects	475
Electrical Service Specification Dialog	476

Electrical Defaults Dialog

 Default Settings for electrical objects control which symbols are placed in the current plan when the Electrical Tools are used. It can be accessed by selecting **Edit> Default Settings** or by double-clicking any of the electrical toolbar buttons, except **Connect Electrical**. See [Default Settings on page 54](#).

Default heights and other attributes of individual objects can be overridden in the Electrical Service Specification dialog. See [Electrical Service Specification Dialog on page 476](#).

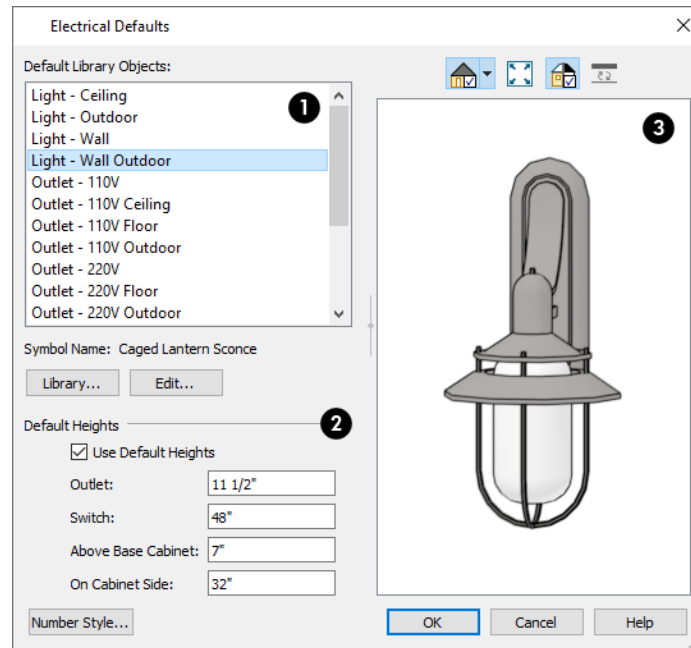

1 Default Library Objects

The **Default Library Objects** are the objects created using the Electrical Tools. Select an item in the scrollable list to see and edit its settings.

- The name of the object shown in the preview image displays here.
- Select an item in the Default Library Objects list and click the **Library** button to select a new default object from the library. See [Select Library Object Dialog on page 688](#).
- Click the **Edit** button to open the specification dialog for the selected object. Any changes you make in the specification dialog are saved with the plan as long as the selected object is not replaced. See [Electrical Service Specification Dialog on page 476](#).

2 Default Heights

Specify the heights at which electrical outlets and switches are initially placed when the Switch or any of the Outlet tools are used.

- Check **Use Default Heights** to apply the default heights specified here to electrical objects placed in plan view using the Electrical Tools. When this is unchecked, electrical objects use the height saved with their symbol. See *Placing Library Objects on page 686*.
- **Outlet** - Specify the default height for outlets, as well as phone, cable and TV jacks.
- **Switch** - Specify the default height for switches, doorbells and thermostats.
- **Above Base Cabinet** - Specify the default height for switches and outlets placed above base cabinets in plan view, as measured from the countertop. See *Adjusting Electrical Object Heights on page 476*.
- **On Cabinet Side** - Specify the default height for switches and outlets placed on the sides of cabinet boxes, measured relative to the side of the cabinet in question. See *Placing Electrical Objects on page 472*.

3 Preview

A preview of the selected object displays here. See *Dialog Preview Panes on page 20*.

The Electrical Tools

 Select **Build> Electrical** to access the Electrical Tools. Some electrical objects are designed to be inserted into walls, floors, ceilings or cabinets, although some can also be free-standing. With the exception of Connect Electrical splines, they can be created with a single click in plan and camera views. See *Placing Electrical Objects on page 472*.

The Electrical Tools place objects according to the settings in the Electrical Defaults dialog.

Different outlet, switch, and light fixture symbols can be placed in different room types. To take advantage of the program's capabilities, define room types properly before placing electrical objects. See *Room Types on page 282*.

Once created, outlets, switches, and lights can be selected and edited. See *Editing Electrical Objects on page 475*.

OUTLETS

The outlet tools can place receptacles on walls, the floor, and on the sides of cabinets and soffits.

Select **Build> Electrical**, then choose:

 **110V Outlet** to place 110 volt duplex outlets.

 **GFCI Outlet** to place ground fault circuit interrupter outlets.

 **220V Outlet** to place 220 volt outlets.

The type and height of an outlet will vary depending on where it is placed. For example:

- An outlet placed on a wall at the back of a base cabinet in plan view is positioned above the counter.
- An outlet placed on a wall at the back of a base cabinet containing a kitchen sink is placed at the standard 11 1/2" (300 mm) above the floor.
- An outlet placed on the side of a cabinet or soffit will be positioned 32" (800 mm) up from that object's bottom.

- An outlet placed outside the building or in an exterior area such as a deck or porch will be weatherproof.
- An outlet placed in the central area of a room in plan view will be positioned on the floor, with one exception: 110V Outlets placed in Garage or Slab rooms will be positioned on the ceiling.

 In camera views, 110V Outlets can be placed on ceilings in any room type.

LIGHT FIXTURES

 Select **Build> Electrical> Light** to place light fixtures on walls, the ceiling, or on soffits. All light fixtures placed in a plan can also serve as light sources in most 3D views. To place a light fixture using the Light tool:

- Click near a wall or the side of a soffit to place a wall-mounted fixture at that location.
- Click away from a wall to place a ceiling mounted light.
- Click inside of a soffit in plan view or on its bottom surface in a camera view to place a ceiling mounted light on the soffit's bottom surface.
- Click outside of a room and away from a wall to place a path light.
- Some light symbols from the library can be mounted under wall cabinets, as well.

The rendering characteristics of individual lights that control how they appear in rendered views can be specified on the LIGHT DATA panel of the Electrical Service Specification dialog. See [Light Data Panel on page 478](#).

SWITCHES

 Select **Build> Electrical> Switch** to place electrical switches on walls or on the sides of cabinets or soffits. Like outlets, the height of switches is measured from the floor to the center of the object.

- A switch placed on the side of a cabinet or soffit will be positioned 32" (800 mm) up from that object's bottom.
- Switches placed outside the building or in an exterior area such as a deck or porch will be weatherproof.

 If you connect two or more switches in a circuit, they update to 3-way or 4-way switches automatically.

Switches placed from the Electrical Library do not automatically update by default, but can be specified to do so. See [Electrical Service Specification Dialog on page 476](#).

AUTO PLACE OUTLETS

 Select **Build> Electrical> Auto Place Outlets** and click in a room tool to place outlets at regular intervals around the entire room. See [Auto Place Outlets on page 472](#).

CONNECT ELECTRICAL

 Select **Build> Electrical> Connect Electrical**, then click and drag to draw splines that snap to electrical switches, outlets, and lights to illustrate wiring circuits. See [Creating Wiring Schematics on page 473](#).

LIGHTING AND ELECTRICAL LIBRARY CATALOGS

 A selection of free-standing and ceiling-, wall- and cabinet-mounted light fixtures is available in the Library Browser at Home Designer Core Catalogs> Architectural> Lighting.

Special use outlets, switches, jacks and numerous other electrical items can be found at Home Designer Core Catalogs> Mechanical, Electrical, Plumbing> Electrical. See [Placing Library Objects on page 686](#).

Placing Electrical Objects

Electrical switches, outlets, lights, and other symbols can be created with a single click in any view. They can also be placed from the Library. See [Click-to-Create on page 115](#).

When the Switch, Light, or an outlet tool is used, the type and height of the object that is created will vary depending on where it is placed. As you move your mouse pointer around the view, an object preview will display near the pointer whenever it is over a location where an object can be placed. Specific details for each tool are noted in [The Electrical Tools on page 470](#).

The electrical objects in the Library are typically designed for a specific use and can only be placed on a wall, on the floor, or on the ceiling. Some are instead free-standing and are designed to be placed on a table or the floor. See [Placing Library Objects on page 686](#).

Wall mounted outlets, switches, and Library symbols can also be placed on the sides of cabinets and soffits. They will snap to the outside of the cabinet box or to the outside of Side or Back Panels, but will ignore doors and drawers.

When a light fixture is created using any method, including copying and pasting, it will always be turned On. This is the case even if the default symbol is turned Off. See [Light Data Panel on page 478](#).

ELECTRICAL OBJECT HEIGHTS

When a wall-mounted electrical object is placed in plan view using one of the Electrical Tools, its initial height off the floor is based on settings in the Electrical Defaults dialog. See [Electrical Defaults Dialog on page 469](#).

Wall mounted electrical symbols placed directly from the Library derive their initial heights from specification settings saved with each object. See [Electrical Service Specification Dialog on page 476](#).

Similarly, cabinet-mounted electrical objects are placed using height information set in either the Electrical Defaults dialog or the symbol's specification dialog. If the default height is higher or lower than the cabinet it's being placed on, the electrical object will be placed along the top or bottom edge of the cabinet box.

In 3D views, an electrical object placed on a wall in a 3D view will snap to its default height provided that the mouse pointer is near that height when you click. If you move the mouse pointer away from the default height, the object will be positioned wherever you click on the wall, regardless of the height at that point.

Auto Place Outlets

 Select **Build> Electrical> Auto Place Outlets** and click in a room to place 110 volt outlets on the walls around the entire room, spaced so that no wall position is farther than six feet (1800 mm) from the nearest outlet. 110 or 220 volt outlets are also placed behind large appliances. In addition, a light is placed above each sink.

Outlets and sink lights are placed based on settings in the Electrical Defaults dialog. See [Electrical Defaults Dialog on page 469](#).

It is important that a room's Type be defined before **Auto Place Outlets** is used so that outlets are placed appropriately. For example, **GFCI Outlets**  (Ground Fault Circuit Interrupter) are placed over cabinets in Kitchen, and Bath rooms. See [Room Types on page 282](#).

Auto Place Outlets does not work in rooms assigned an exterior room type such as Deck. To place outlets in an exterior room, place them from the Electrical Library or use the **110V Outlet**  tool.

Railings and invisible walls are ignored by **Auto Place Outlets**. If it is used in a room defined by railings or invisible walls, outlets are automatically placed in any adjacent rooms on the other side of these wall types. See [Room Definition on page 280](#).

Once placed, any outlet can be moved, edited, or deleted. See [Editing Electrical Objects on page 475](#).

Creating Wiring Schematics

Electrical schematics can be created in two ways. Using the **Connect Electrical**  tool is quick and easy, but if you need detailed schematics, you can create your own wiring diagrams using the CAD tools. See [CAD Objects on page 192](#).

CONNECT ELECTRICAL

Select **Build > Electrical > Connect Electrical**, then click and drag to draw splines that snap to electrical switches, outlets, and lights to illustrate wiring circuits. See [Splines on page 219](#).

To create a new circuit or add to an existing circuit, click on a switch, outlet, or light while the **Connect Electrical** tool is active, drag to the next object and release. You can also draw electrical circuits using the **Alternate**  continuous drawing mode. See [Alternate on page 138](#).

When a **Connect Electrical** spline is first drawn, it looks like an arc but actually consists of two segments that are defined by vertex points. When selected, its edit handles display at each of these vertices. If you click and drag one of these edit handles, the length, angle, and curvature of the spline will change but the other vertices will not move.

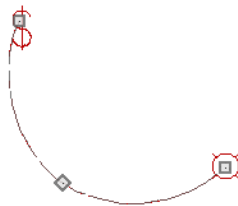

Connect Electrical splines cannot be snapped to one another: they can only snap to electrical objects. Once drawn, though, additional vertices can be added and used to form complex curves. See [Editing Spline-Based Objects on page 160](#).

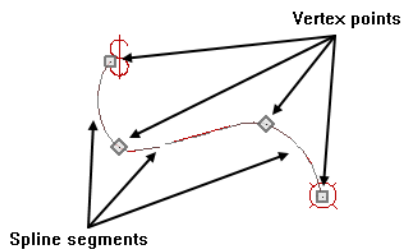

To remove a connection from a circuit, simply select and **Delete**  it. If you remove an electrical object from a circuit, any **Connect Electrical** splines snapped to it will also be deleted. See [Deleting Objects on page 187](#).

THREE- AND FOUR-WAY SWITCHES

Multiple switches can control an object or group of objects.

- Two switches controlling the same objects are referred to as three-way switches.
- Three switches controlling the same objects are called four-way switches.

In plan view, a three- or four-way switch's "way" number will automatically display in its 2D symbol.

Electrical Library Content

Select **View > Library Browser**  to access a variety of electrical symbols. See [The Library Browser on page 669](#).

Browse for electrical objects such as bath vent fans, an electrical panel, fluorescent lights, chandeliers, a smoke detector, thermostat, and more. Select a symbol, then click in your plan to place it on a wall, floor, or ceiling.

You can specify which electrical object in the library is used by each of the Electrical Tools. See [Electrical Defaults Dialog on page 469](#).

You can also assign electrical objects from the library to toolbar buttons for easy access and placement to frequently-used library objects. See [Place Library Object Button on page 688](#).

ADDING ELECTRICAL CONTENT

Any electrical symbol placed into a plan can be customized and added to the User Catalog in the Library Browser. See [Add to Library on page 681](#).

Displaying Electrical Objects



The display of electrical objects and connections is controlled in the Layer Display Options dialog. See [Layer Attributes on page 124](#).

When displayed in 3D views, light fixtures act as sources of light that help illuminate the 3D model. See [Lighting on page 772](#).

IN PLAN VIEW

In plan view, electrical objects are represented by commonly used CAD symbols that represent the type of object rather than its appearance in 3D.

Like other objects, electrical objects are placed in Drawing Groups that affect whether they display in front of or behind other objects in plan view. You can modify a selected object's place in the drawing order by clicking the **View Drawing Group Edit Tools**  edit button. See [Drawing Group Edit Tools on page 128](#).

Electrical symbols are placed on the "Electrical" layer, while Connect Electrical splines are drawn on the "Electrical, Connections" layer.

ELECTRICAL LABELS

Electrical labels display in plan view when the "Electrical, Labels" layer is turned on and use the Text Style assigned to their layer. See [Label Panel on page 363](#).

Customized labels can be specified in the Electrical Service Specification dialog.

Note: Some electrical objects are represented in plan view by a symbol that includes text. This text is not part of the object's label and does not use the Text Style assigned to the "Electrical, Labels" layer.

IN THE MATERIALS LIST

Electrical objects, including outlets, switches, lights, and symbols from the library such as jacks and fans, are listed under the Electrical Category in the Materials List. Connect Electrical splines are 2D objects only, however, and are not calculated. See [Materials Lists on page 904](#).

As with other objects, there are a number of ways to control how, or whether, electrical objects are included in the Materials List. See [Organizing Materials Lists on page 908](#).

You can add and edit information about an electrical object's accessories and sub-accessories in specification dialog. See [Components Panel on page 921](#).

Editing Electrical Objects

Electrical objects can be selected individually as well as in a group in 2D and 3D views and edited using the edit handles, the Edit Toolbar and their specification dialog. See [Electrical Service Specification Dialog on page 476](#).

Electrical objects can be marquee-selected by type when the drawing tool used to create them is active. The Marquee Select Similar edit tool can also be used to group-select electrical objects. See [Selecting Multiple Objects on page 143](#).

Light fixtures and Added Lights can be group-selected, but their light data cannot be edited unless each has the same number of light sources. See [Lighting on page 772](#).

Lights can also be edited using the Adjust Lights dialog. See [Adjust Lights Dialog on page 775](#).

USING THE EDIT HANDLES

The edit handles for electrical objects vary depending on the location of the object.

- Wall mounted electrical objects cannot be rotated, so only the Move edit handle displays.
- Electrical objects placed on floors and ceilings can be rotated.
- In 3D views, some ceiling mounted and free-standing light fixtures can be resized.
- **Electrical connections**  are edited like splines. See [Editing Spline-Based Objects on page 160](#).

IN THE SPECIFICATION DIALOGS



Electrical objects can be edited in the Electrical Service Specification dialog. See [Electrical Service Specification Dialog on page 476](#).

USING THE EDIT TOOLS

A selected electrical symbol can be edited in a variety of ways using the buttons on the Edit Toolbar. See [The Edit Toolbar on page 91](#).



Change to GFCI Outlet changes a selected 110V Outlet to a GFCI Outlet, as specified in the Electrical Defaults dialog.



Change to 110V Outlet changes a selected GFCI Outlet to a 110V Outlet.



Turn Light(s) On in 3D toggles a selected light on so that it emits light in 3D views while **Turn Light(s) Off in 3D** toggles it off. See [Displaying Lights on page 774](#).



USING DIMENSIONS

Electrical objects can be moved precisely using dimensions. See *Moving Objects Using Dimensions on page 332*.

By default, electrical objects are not located by dimension lines as the lines are drawn. Once created, though, you can edit a dimension line's extensions to locate the center of any electrical object. See *Editing Extension Lines on page 329*.

In order to locate electrical objects by a dimension line as it is being drawn, first check the box beside **Dimensions** on the LOCATE OBJECTS panel of the Dimension Defaults dialog. See *Locate Manual Panel on page 315*.

ADJUSTING ELECTRICAL OBJECT HEIGHTS

When a wall- or cabinet-mounted electrical object is placed, its initial height is based on settings in the Electrical Defaults dialog. See *Placing Electrical Objects on page 472*.

Once placed, a wall-mounted electrical object's height can be edited in three ways:

- Specify the height in the Electrical Service Specification dialog. See *General Panel on page 476*.
- In 3D views, the position of an electrical object can be adjusted using its edit handles.
- In any view, use the **Transform/Replicate Object**  tool. See *Transform/Replicate Object Dialog on page 180*.

DELETING ELECTRICAL OBJECTS

An electrical object can be deleted by selecting it and clicking the **Delete**  edit button or by pressing the Delete key.

All electrical objects in a room, on a floor, or in the entire plan can also be deleted as a group using the Delete Objects dialog. See *Deleting Objects on page 187*.

Electrical Service Specification Dialog

 Select one or more electrical objects and click the **Open Object** edit button to open the Electrical Service Specification dialog. The settings in this dialog vary, depending on the type of objects you select. This dialog can also be accessed by clicking the **Edit** button in the Electrical Defaults dialog. See *Electrical Defaults Dialog on page 469*.

The Electrical Service Specification dialog has the following panels:

GENERAL PANEL

The items on this panel vary, depending on the type of electrical object selected.

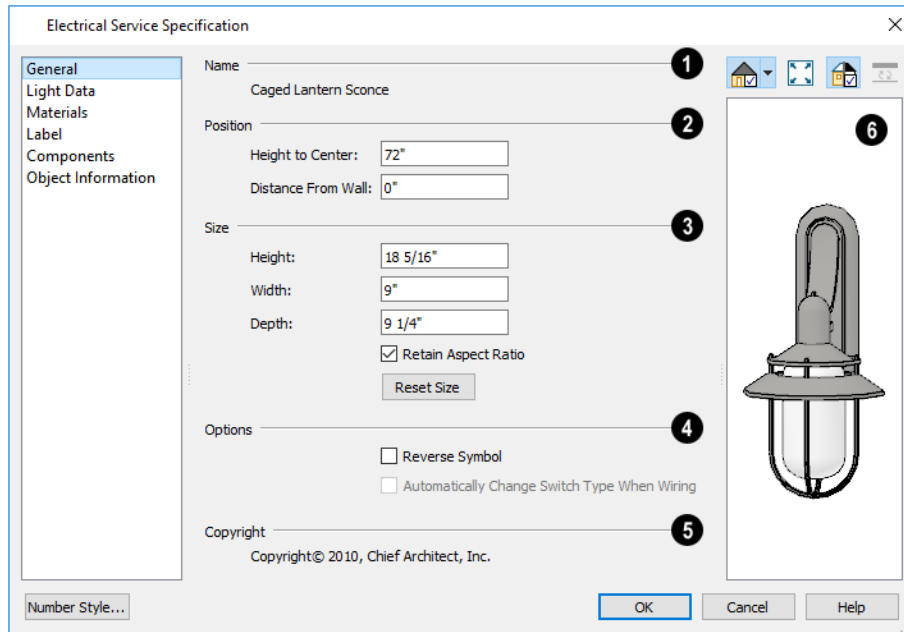

1 Name

The **Name** of the selected object as used in the Library Browser and Materials List displays here.

2 Position

Specify the **Position** of the selected electrical object. The options available depend on the type of object selected.

- Specify the **Offset From Ceiling** of a ceiling outlet or ceiling mounted light. If the light is mounted to a cabinet, this value is the offset from the cabinet.
- Specify the **Height to Center** of a switch, wall outlet or wall light.
- Specify the **Offset From Floor** of a floor outlet or floor lamp.
- Specify the **Distance From Wall** of a wall mounted symbol. A negative value will recess the symbol into the wall and may prevent it from being seen in 3D.

3 Size

Specify the **Size** of the selected electrical symbol.

- Specify the **Height, Width** and **Depth** of the selected symbol.
- Uncheck **Retain Aspect Ratio** if you would like to modify one of the above values without affecting the others. Doing so may cause the symbol's shape to become distorted. This check box does not affect editing performed outside of this dialog and is an action rather than a state: the next time you open this dialog, it will be checked.
- Click the **Reset** button to restore the electrical symbol's original size.

4 Options

- Check **Reverse Symbol** to reverse the object’s appearance so that features on its left are located on its right and vice versa. Does not affect symmetrical symbols.
- Check **Automatically Change Switch Type When Wiring** for a selected switch to become a three- or four-way switch if your wiring plan uses it as such. This setting is not available when the dialog is accessed via the Electrical Defaults dialog. See *Connect Electrical on page 473*.

Switches placed from the toolbar use this option by default; switches placed from the library do not.

5 Copyright

Any **Copyright** information associated with the selected symbol will be stated here.

6 Preview

A preview of the selected object displays here. See *Dialog Preview Panes on page 20*.

LIGHT DATA PANEL

The LIGHT DATA panel is available when the selected electrical object is a light fixture. The available options vary depending on the type of light selected.

The settings on this panel are similar to those on the same panel of the Light Specification dialog. See *Light Specification Dialog on page 777*.

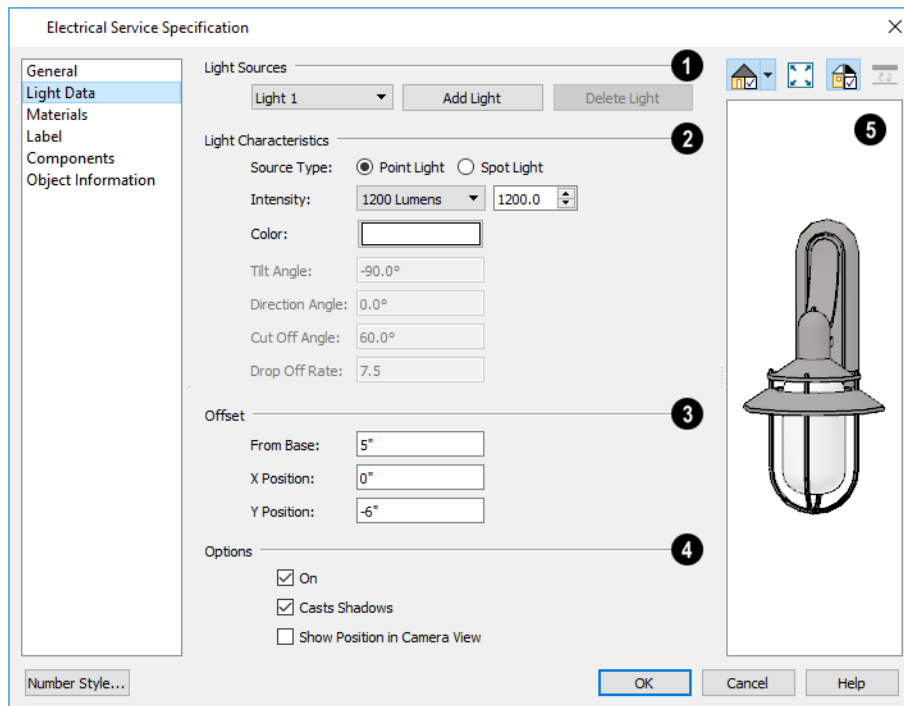

1 Light Sources

Each fixture can have multiple **Light Sources**, listed here. Not available for Added Lights. See [Lighting on page 772](#).

- Select a **Light Source** assigned to the selected light fixture from the drop-down list. The selected light source can be edited using the settings on this panel.
- Click **Add Light** or **Delete Light** to add or delete light sources from the list. If the selected fixture has only one light source, Delete Light will not be available.

2 Light Characteristics

- Select either **Point Light** or **Spot Light** as the light **Source Type**. The Type determines which options are enabled below. See [Light Types on page 773](#).
- Select an **Intensity** from the drop-down list. The available options are described using lumens and correspond to commonly used light bulb wattages. You can also use the text box or spin controls to make fine adjustments to the Intensity value. When a non-standard value is specified, the Intensity is described as “Custom Lumens”.
- Click the **Color** bar to define the color of the selected light source. Colored lights alter the appearance of textures and can be used to achieve special effects. See [Select Color Dialog on page 134](#).



The default color of light is pure white, which has the least effect on the appearance of material colors and textures.

The Angle and Drop Off Rate settings below are only available for Spot Lights.

- The **Tilt Angle** controls the angle of the illumination with respect to the horizon. A value of -90° points the light straight down and a value of 90° points it straight up. 0° is parallel to the horizon.
- The **Direction Angle** defines the direction of the illumination relative to the ground. 0° is measured horizontally pointing to the right. Positive values rotate in a counter-clockwise direction from there. Enter a value up to 360° . If you enter a negative value, the program adds 360° to it when you click OK or press the Tab key.
- The **Cut Off Angle** controls the angle of the cone of illumination for Spot Lights only. A cone angle of 180° creates a spot light that shines in a half sphere on one side of the light source. A small cone angle, for example 10° , creates a very narrow cone of light.
- The **Drop Off Rate** affects how fast a Spot Light’s intensity drops off from the center of the cone to the outside edge.

A value of 0 produces a cone of light with the same intensity from the center to the outside edge and a sharp distinction between lit areas within the cone and unlit areas outside of it. As this value is increased, the light intensity decreases closer to the edge of the cone and the distinction between lit and unlit areas becomes softer. Only available for Spot Lights.

3 Offset

The **Offset** settings control the location of the selected Light Source relative to the fixture.

- **From Base** controls how far the light source is from the fixture base. The fixture base is determined by the surface that it is attached to (i.e. wall, floor, or ceiling).
- **X Position** and **Y Position** allow you to position the light source relative to the center of the fixture, along the floor/ceiling.

4 Options

Additional **Options** that affect how the selected light source behaves are available.

- Check **On** to use the light source in camera views, or uncheck it if you prefer that the light source not be used. See [Lighting on page 772](#).
- **Casts Shadows** controls whether or not the selected light source casts shadows in camera views. See [Shadows on page 770](#).
- Check **Show Position in Camera View** to indicate the position of a selected Point or Spot Light source in the preview pane and in 3D views when it is turned On. This tool can be used to determine if your light source is positioned correctly. See [In 3D Views on page 774](#).

5 Preview

A preview of the selected object displays here. The selected light source's Position in Camera View will display in all views except Plan View if the light source is On. See [Dialog Preview Panes on page 20](#).

MATERIALS PANEL

The MATERIALS panel is found in the specification dialogs for a variety of objects. For more information, see [Materials Panel on page 716](#).

LABEL PANEL

Labels for electrical fixtures display in plan view when the “Electrical, Labels” layer is turned on and use the Text Style assigned to that layer. See [Electrical Labels on page 474](#).

For information about the settings on this panel, see [Label Panel on page 363](#).

COMPONENTS PANEL

The information on the COMPONENTS panel can be used in the materials list. For more information, see [Components Panel on page 921](#).

OBJECT INFORMATION PANEL

The information entered on the OBJECT INFORMATION panel can be used in the materials list. For more information, see [Object Information Panel on page 922](#).

Foundations

Chapter 19

There are three foundation types in Home Designer Pro: stem walls with footings, grade beams on piers, and monolithic slab. All three can be generated automatically or manually. The foundation type can be specified in the Foundation Defaults dialog when the foundation is built on Floor 0.

There can be only one foundation level in a plan, Floor 0; however, foundation structures can be drawn on any floor using the Foundation and Slab Tools.



Always consult registered geotechnical and civil engineers for information regarding the proper foundation for your site.

TOPICS

Foundation Defaults	482
Foundation Defaults Dialog	482
Building a Foundation	485
Displaying Foundations	487
Editing Foundations	488
Deleting Foundations	490
Foundations and Rooms	490
Foundations and the Terrain	491
The Slab Tools	493
Editing Slabs	493
Slab Specification Dialog	494
Editing Piers and Pads	495
Fireplaces	496
Fireplace Specification Dialog	497
Library Fireplaces	499
Chimneys	500

Foundation Defaults



There are several defaults dialogs that affect the foundation. They can be accessed by selecting **Edit> Default Settings**.

In the Default Settings dialog, select “Foundation” and click the **Edit** button to open the Foundation Defaults dialog.

If a foundation has been built, it will have a Floor 0 Defaults dialog. The structural settings in this dialog are initially drawn from those in the Foundation Defaults dialog. See *Floor Defaults Dialog on page 502*.

The Foundation Wall Defaults dialogs control the default setup of Foundation Walls. See *Wall, Railing, and Fencing Defaults on page 223*.

The default attributes for Slabs and Slabs with Footings can be set in the Slab Defaults dialogs. See *The Slab Tools on page 493*.

The default attributes for Post footings can be set in the Framing Defaults/Build Framing dialog. See *Build Framing Dialog on page 613*.

Foundation Defaults Dialog



The Foundation Defaults dialog allows you to specify stem wall height, slab thickness, sill plates, and other characteristics of an automatically-generated foundation. These values determine how a new foundation is generated as well as the sizes for manually drawn foundation walls added to an existing foundation. Select **Edit> Default Settings**, and in the Default Settings dialog, select "Foundation" and click the **Edit** button.

The settings in the Foundation Defaults dialog are similar to those in the Build Foundation dialog, which opens when **Build> Floor> Build Foundation**  is selected. The primary difference is that when you click **OK** in the Foundation Defaults dialog, no changes are made to the model. See *Building a Foundation on page 485*.

FOUNDATION PANEL

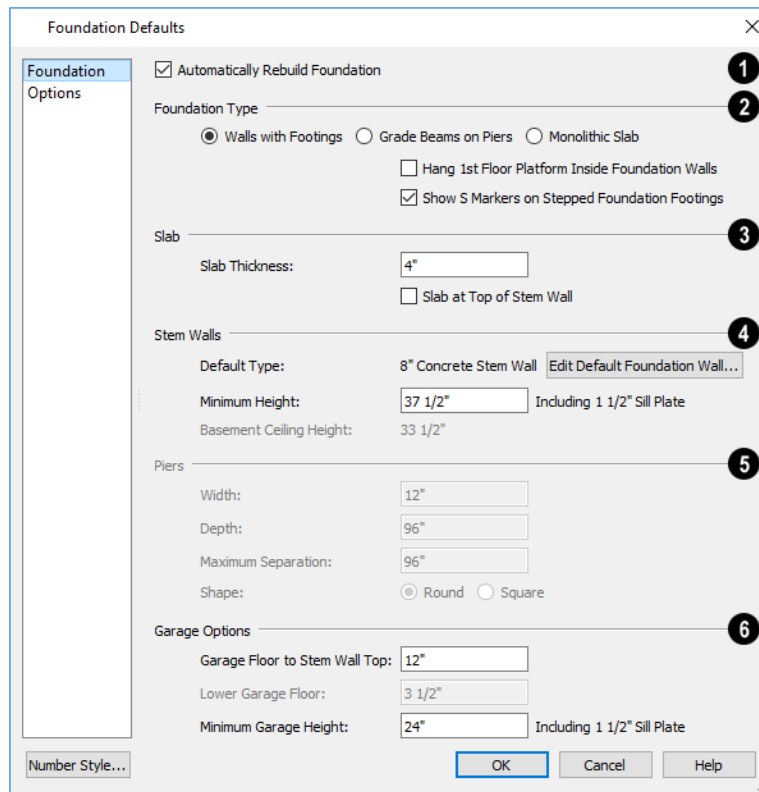

1 Automatically Rebuild Foundation

Check **Auto Rebuild Foundation** to automatically rebuild the foundation whenever changes are made to Floor 1 that affect the structure of the foundation. See [Rebuilding Foundations on page 488](#).

2 Foundation Type

Three different **Foundation Types** can be created in Home Designer Pro. Each type of foundation has different default settings, options, and behaviors. Select the radio button next to the desired type.

- Select **Walls with Footings** to produce a foundation composed of stem walls with footings that run continuously under the base of the walls.
- Select **Grade Beams on Piers** to generate a pier and grade beam foundation. The floor framing rests directly on top of the grade beams.
- Select **Monolithic Slab** to build a slab foundation defined by slab footings. The foundation forms the floor platform for Floor 1. It is visible on Floor 0 and can be selected and edited.
- Check **Hang 1st Floor Platform Inside Foundation Walls** to produce stem walls that build up to the top of the floor platform of Floor 1. When unchecked, the stem walls build to the bottom of the floor platform, which bears on top of them. Only available when Walls with Footings is selected, above.
- Check **Show “S” Markers on Step Foundation** to include an “S” symbol in plan view anywhere there is a step in foundation wall height. Not available when Grade Beams on Piers is selected, above. See [Displaying Foundations on page 487](#).

3 Slab

- Specify the **Slab Thickness**, which is the thickness of the slab produced above the footing or at the top of the stem wall.
- Check **Slab at top of Stem Wall** to raise the slab so its top is flush with the top of the stem walls. Only available when Walls with Footings is the selected Foundation Type.
If **Slab at top of Stem Wall** is selected, all rooms on the first floor are automatically set to **Floor Supplied by the Foundation Room Below** in the Room Specification dialog. See *Structure Panel on page 302*.

4 Stem Walls

- The name of the **Default Foundation Wall Type** displays here for reference.
- Click the **Edit Default Foundation Wall** button to open the Foundation Wall Defaults dialog and change the default settings for foundation walls. See *Foundation Walls on page 231*.
- If Monolithic Slab is the selected Foundation Type, the **Edit Garage Curb** button will be available. Click it to open the Foundation Wall Defaults dialog and define the walls that form curbs around Garage and Slab rooms.
- Specify the **Minimum Height**, which is the minimum height for foundation stem walls and grade beams and includes the sill plates.
- The **Basement Ceiling Height** displays here as a reference. This is the distance from the top of the slab floor to the basement ceiling and is equal to the Minimum Wall Height minus the Slab Thickness.

If the Minimum Wall Height is at least 76" (1900 mm), a Ceiling Finish is added to the foundation room automatically. A slab floor is also generated above the footing. The ceiling height and finish can be changed later. To remove this slab, specify the room areas in the basement as "Open Below". See *Room Specification Dialog on page 300*.

5 Piers

These settings are only available when Grade Beams on Piers is the selected Foundation Type.

- Specify the **Width, Depth, and Maximum Separation** of the piers.
- Choose either **Round or Square** piers.

6 Garage Options

These settings only apply to rooms defined as Garages. See *Garages on page 490*.

- Specify the **Garage Floor to Stem Wall Top**, which is the distance between the slab and the tops of the stem walls in both Garage and Slab rooms. Available for Walls with Footings and Grade Beams on Piers foundation types. See *Foundation Defaults on page 482*.

Note: The Garage Floor to Stem Wall Top setting only affects Garage rooms that have a Floor Height of 0. See *Structure Panel on page 302*.

- Specify the **Lower Garage Floor** height, which is the distance that Garage and Slab room floors are lowered when a Monolithic Slab foundation is built. This value is also the height of the curbs around these rooms.
- Specify the **Minimum Garage Height**, which is the minimum height that stem walls defining a Garage foundation will be, regardless of the Minimum Stem Wall Height for the rest of the foundation.

OPTIONS PANEL

The OPTIONS panel allows you to include rebar and other materials related to the foundation in the Materials List. See *Materials Lists on page 904*.

Some options on this panel may be unavailable depending on the foundation type selected on the FOUNDATION panel.

The screenshot shows the 'Foundation Defaults' dialog box. On the left is a 'Foundation Options' list. The main area is divided into two sections: 'Rebar' (marked with a circled 1) and 'Foundation Options' (marked with a circled 2). The 'Rebar' section has a table with columns: 'Bars per Course', 'Course Spacing (On Center)', 'Rebar Size (#)', and 'Overlap (x Diameter)'. The rows are: Footing (2, 40.0), Wall Horizontal (2, 12", 4, 40.0), Wall Vertical (2, 24", 4, 0.0), Pier (4, 4, 0.0), and Slab (0, 12", 4, 40.0). Below this is a 'Use Mesh' checkbox. The 'Foundation Options' section has 'Foam Seal' (checked) and 'Termite Flashing' (unchecked) checkboxes. At the bottom are 'Number Style...', 'OK', 'Cancel', and 'Help' buttons.

1 Rebar

Specify the **Rebar** used in the major foundation components: **Footing**, **Wall Horizontal** courses, **Wall Vertical** courses, **Pier**, and **Slab**. Rebar and mesh are calculated in the Materials List provided that the wall or footing they are associated with is the “Concrete” Structure Type; but, they do not display in any 2D or 3D views of the model. See *The Materials List Tools on page 905*.

- **Bars per Course** - Specify the number of bars of rebar to be used per course for each foundation component.
- **Course Spacing** - Define the spacing for Vertical and Horizontal Wall courses, and for Slabs. If slabs are to have rebar instead of mesh, this spacing value applies to both directions.
- **Rebar size** - Define the rebar size in 1/8th inches. 4 represents 4/8, or 1/2 inch.
- Specify the **Overlap** where sticks of rebar meet, in terms of the rebar’s **Diameter**. A value of 40.0, for example, equals 40 times the Rebar Size.
- Check **Use Mesh** to reinforce the slab floor with mesh instead of rebar, or uncheck it to use rebar.

2 Foundation Options

Select either **Foam Seal**, **Termite Flashing**, or both. These options are added to the Materials List, but do not display in the model.

Building a Foundation

 Foundations can be generated automatically or drawn manually. A combination of the two methods can also be used.

Three foundation types are available: stem walls with footings, grade beams on piers, and monolithic slabs. The first two options are created using walls; the last creates concrete slabs with footings.

Automatically built foundations are placed on Floor 0 and are based on wall positions and floor heights on Floor 1. Foundation walls or slab footings are generated under:

- All exterior walls on Floor 1 that define a room other than a Deck type room. See [Room Definition on page 280](#).
- Any interior walls on Floor 1 defining rooms with different floor heights. See [Floor and Ceiling Heights on page 293](#).

At least one room must be defined on Floor 1 for a foundation to be automatically generated. If no rooms are defined on Floor 1, a blank Floor 0 is created.

There can be only one Floor 0 per plan. If your plan requires a foundation on more than one floor, you will need to draw the required foundation walls or slabs yourself.

To build an automatic foundation

1. Specify the desired floor heights for the rooms on Floor 1: particularly Porch and Garage rooms.
2. Select **Build> Floor> Build Foundation** .
3. Specify the desired foundation type and other information in the Build Foundation dialog. The settings in this dialog are similar to those in the Foundation Defaults dialog. See [Foundation Defaults Dialog on page 482](#).
4. In the New Floor dialog, select **Derive new Foundation plan from the 1st floor plan** and click **OK** to build a foundation based on Floor 1.

If you prefer, you can instead select **Make new (blank) plan for the Foundation** to create an empty foundation level where you can manually draw foundation walls or slabs.

In most cases, it is preferable to base Floor 0 off the first floor plan and then manually edit the foundation as needed. See [Editing Foundations on page 488](#).



FOUNDATION WALL ALIGNMENT

By default, foundation walls and slab footings will align with walls on the floor above along the outside surface of the Main Layer of both wall types. See [Aligning Walls on page 249](#).

MIXING FOUNDATION TYPES

You can also create a foundation that combines stem walls, grade beams and piers, and/or monolithic slabs.

To create a foundation of multiple types

1. Begin by specifying any rooms on Floor 1 that require a slab floor as either a Garage or Slab **Room Type**. See [Foundations and Rooms on page 490](#).
2. Alternatively, or in addition, you can specify any rooms on Floor 1 as having a **Monolithic Slab Foundation**. See [Structure Panel on page 302](#).
3. **Build Foundation** , as described above.
 - If the foundation will include any grade beams and piers, specify **Grade Beams on Piers** as the **Foundation Type** and build the foundation.
 - If the foundation will include a combination of stem walls and slabs, specify **Walls with Footings** as the **Foundation Type**.
4. Once the foundation walls have been generated, they can be moved or deleted, and new **Foundation Walls**  and/or **Slabs**  can be drawn. See [Foundation Walls on page 231](#) and [The Slab Tools on page 493](#).

OPENINGS IN FOUNDATION WALLS

Any doors placed in walls around a Garage will receive cutouts in the garage stem wall or curb. The width of that cutout can be specified in the Door Specification dialog. See [General Panel on page 379](#).

Displaying Foundations



The display of foundation walls, slabs, curbs, piers and footings is controlled in the **Layer Display Options** dialog. See [Layer Display Options Dialog on page 126](#).

- Foundation Walls, including grade beams, slab footings and Garage curbs, are placed on the “Walls, Foundation” layer.
- Footings under slab footings and Foundation Walls are placed on the “Footings” layer, as are foundation piers.
- Post footings and deck post footings are placed on the “Footings, Post” and “Footings, Deck Post” layers.
- Slabs created using the **Slab Tools**  are placed on the “Slabs, Custom” layer.
- Wall labels and slab labels are placed on the “Walls, Labels” and “Polylines 3D, Labels” layers, respectively.
- In stem wall and grade beam foundations, brick ledge lines in plan view are on the “Slabs” layer; in monolithic slab foundations, they are on the “Walls, Foundation” layer. See [Brick Ledges on page 231](#).
- The “Foundations” layer controls the display of all objects on Floor 0 in 3D views but does not affect plan view.

IN PLAN VIEW

The appearance of foundation wall types, including line weights, colors and fill styles, is specified in the Wall Type Definitions dialog. See [Wall Type Definitions Dialog on page 259](#).

Changes in stem wall and monolithic slab foundation heights are represented in plan view with S markers. These markers are located on the “Footings, Step Markers” layer and use the Text Style assigned to that layer. See [Stepped Foundations on page 492](#).

If a door on Floor 1 extends into a stem wall or curb defining a Garage room, its location will be indicated on Floor 0. See [Displaying Doors on page 369](#).

IN 3D VIEWS

In 3D views, all objects on Floor 0 will only display when the “Foundation” layer is turned on.

While the display of foundation walls and their footings can be controlled independent of one another in plan view, in 3D views this is not the case. If a foundation wall is set to display, its footing will as well - even if the “Footings” layer is turned off. The reverse is also true - if a foundation wall’s display is turned off, so will its footing’s.

The display of monolithic slab foundations in 3D views is controlled by the “Foundation” layer. Slab footings are located on the “Walls, Foundation” layer; but if this layer is turned off, any slab footings that define a foundation room will continue to display as long as the “Foundation” layer is on.



IN THE MATERIALS LIST

The materials that make up foundation walls, footings, and slab floors are listed under the Foundation category in the Materials List, including:

- Concrete for walls, slabs, and footings
- Rebar for walls and footings

- Rebar or mesh for slabs

Other objects relevant to foundations can be found in these categories:

- **Exterior Trim** - Lists slabs drawn with the **Slab**  tools that are located outside of a structure.
- **Interior Trim** - Lists slabs drawn with the **Slab**  tools that are located inside of a structure.

See *Materials Lists on page 904*.

Editing Foundations

Stem wall with footings, wall with piers and monolithic slab foundations are all created using walls which enclose room areas.

- Foundation walls can be selected and edited much like other walls. See *Editing Walls on page 244*.
- Footing size can be changed on a wall by wall basis. See *Footing Width and Height on page 489*.
- Foundation rooms can also be selected and edited like other rooms. See *Foundations and Rooms on page 490*.

REBUILDING FOUNDATIONS

By default, foundations update automatically when changes are made to the structure on Floor 1. For example, if exterior walls are moved or floor platforms are raised or lowered, the foundation will be rebuilt.

You can direct the program to rebuild an automatically generated foundation whenever changes are made on Floor 1 that affect the foundation by checking **Auto Rebuild Foundation** in the Foundation Defaults dialog. See *Foundation Defaults on page 482*.

You can also rebuild an automatically generated foundation by selecting **Build> Floor> Build Foundation**  from the menu.

When **Auto Rebuild Foundation** is enabled, walls cannot be edited, manually drawn or deleted on Floor 0. When the foundation is rebuilt, any manually drawn or edited walls are deleted. Similarly, rooms on Floor 0 cannot be edited while this option is enabled. If you try to draw a wall or edit a room or a wall while **Auto Rebuild Foundation** is turned on, a warning message will display.

CHANGING FOUNDATION TYPES

When a foundation is generated, the program creates Floor Defaults settings for Floor 0 based on the information in the Build Foundation dialog. If you specify a Monolithic Slab foundation, the default Floor Structure on Floor 1 will also be changed to a slab rather than a framed platform. See *Floor Defaults Dialog on page 502*.



To avoid unexpected results, it is recommended that you not change the Foundation Type once the foundation is built.

STEM WALL HEIGHT

When a foundation is created, all of Floor 0 uses the stem wall height specified in the Foundation Defaults dialog,

This height is measured from the bottom of floor platform of Floor 1 to top of the stem walls' footings. If Floor 1 has multiple floor platform heights, the foundation stem walls will be stepped.

Once a foundation is created, stem wall heights can be adjusted either on a room-by-room basis or for individual walls.

To change a room's stem wall height

1. Select a room on Floor 0 and click the **Open Object**  edit button.
2. Specify the desired **Stem Wall Height** in the Room Specification dialog. See [General Panel on page 300](#).
3. If you wish to reduce the **Stem Wall Height**, you will first need to reduce the **Ceiling Height** value by the same amount.

If adjacent rooms have stem wall heights that differ by at least 1/16 of an inch, the stem wall separating them uses the larger of these two values.

In 3D views, individual stem walls can be selected and edited. In most cases, this method should only be used for stepping the bottom of the foundation wall. See [Stepped Walls and Footings on page 255](#).

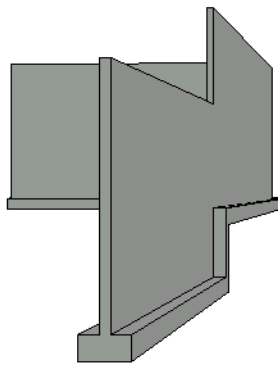

FOOTING WIDTH AND HEIGHT

Foundation Wall footings derive their Width and Height from in the Foundation Wall Defaults dialog, Once a Foundation Wall is created, its footing can be adjusted in its specification dialog. See [Foundation Panel on page 268](#).



Stem wall footing heights can also be edited in 3D views just as the rest of the stem wall can. Slab footing heights, on the other hand, cannot be adjusted in 3D. See [Stepped and Raked Walls on page 255](#).

You can specify whether stepped stem walls have vertical footings on the FOUNDATION panel of the Foundation Wall Defaults and Specification dialogs.

INTERIOR FOOTINGS

Slab foundations often have interior footings: to support posts, for example. Home Designer does not generate interior footings automatically, but you can easily draw them using the **Slab**  tool. See [The Slab Tools on page 493](#).

To create an interior footing

1. Select **Build> Slab> Slab** , then click and drag to draw a slab on Floor 0. This slab will serve as a footing.
2. Select the slab and click the **Open Object**  edit button.
3. In the Slab Specification dialog, specify the desired **Height** and **Thickness**. See [General Panel on page 494](#).

- The **Height** should be set so that it meets the bottom surface of the monolithic slab above.
4. Use the edit handles, dimensions and/or the Reference Display to position the slab at the desired location.

Deleting Foundations



Select **Build> Floor> Delete Foundation** to delete the entire foundation floor.

You can also select and delete individual foundation walls and slabs by clicking the **Delete**  edit button or pressing the Delete key. See [Deleting Objects on page 187](#).

Deleting and rebuilding the foundation is often the quickest way to update the model when substantial changes are made to Floor 1 after the foundation is built.

Foundations and Rooms

When a foundation plan is created, rooms included in the Living Area calculation generate a stem wall, grade beam, or slab foundation below them. Garage rooms generate slab foundations, but exterior rooms such as Decks, Courts and Balconies do not generate any foundation. See [Room Types on page 282](#).

Interior foundation walls are not generated unless:

- They separate the area under a Slab or Garage room from the rest of the plan;
- They separate the area under a room specified as having a slab foundation from the rest of the plan;
- They define areas under rooms with different floor heights.

Note: To remove all or part of the concrete slab in the basement area, select a basement room and define it as Open Below in the Room Specification dialog.

GARAGES

When a foundation is generated based on the floor plan of Floor 1, a room on the first floor specified as either a Garage or Slab type will receive a stem wall or pier foundation with a slab floor and stem walls. If a monolithic slab foundation is generated, the room will receive a slab floor with curbs.

An opening placed in a wall defining a Garage will receive a cutout in the stem wall or curb that displays in plan view on the floor below provided that the stem wall or curb's Main Layer has a Concrete or Brick material type.

The width of the concrete cutout can be defined and you can specify whether the cutout displays in the Door or Window Specification dialog. See [Framing Panel on page 390](#).

By default, a room on Floor 1 specified as a Garage or a Slab will be assigned a lower floor height when the foundation is built. The amount that it is lowered depends on the foundation type:

- The floor height will drop the default thickness of the floor platform for Floor 1 plus 12" (300 mm) in a Walls with Footings or Grade Beams on Piers foundation.
- The floor height will drop 3 1/2" (88 mm) in a Monolithic Slab foundation.

These values are set in the Foundation Defaults dialog. See [Foundation Defaults on page 482](#).

To build a Garage slab with stem walls

1. Before the foundation is generated, specify the room as a Garage or Slab.
2. Build an automatic Wall with Footings or Grade Beam on Piers foundation.

In the Floor 1 Garage's Room Specification dialog, **Floor Supplied by the Foundation Room Below** will now be checked. See [Structure Panel on page 302](#).

By default, the program produces a 4" (100 mm) slab and 24" (600 mm) high stem walls around the garage. These stem walls are drawn on Floor 0 and will indicate the locations of any doors that extend into them.

To build a Garage slab with curbs

1. Before the foundation is generated, specify the room as a Garage or Slab.
2. Build an automatic Monolithic Slab foundation, specifying the required Lower Garage Floor value.

By default, the program produces a 4" (100 mm) slab and 3 1/2" (88 mm) high curb around the garage. The curbs are drawn on Floor 0, use the Default Foundation Wall type, and will indicate the locations of any doors that extend into them.



The floor height of the garage and the stem wall or curb height can then be adjusted, if necessary, in the Garage room's Room Specification dialog. See [Structure Panel on page 302](#).

BASEMENT ROOMS

When a foundation's type is Walls with Footings or Grade Beams on Piers, and it is assigned a Basement Ceiling Height of 48" (1200 mm) or greater, the resulting basement is automatically included in the Living Area calculation. It does not, however, have a floor or ceiling finish.

When a foundation is assigned a Basement Ceiling Height of 72" (1800 mm) or greater, the resulting basement is automatically created with a 4" (100 mm) concrete slab floor and a default Floor Finish like that on Floor 1. Similarly, it is automatically given a painted drywall Ceiling Finish. See [Foundation Defaults on page 482](#).

Regardless of its ceiling height, however, you can specify a floor or ceiling finish for any room in the Room Specification dialog. See [Structure Panel on page 302](#).

The resulting basement can be divided into separate rooms using **Interior Walls**  or any wall type you wish. If the rooms in a basement have different floor heights, it is best to separate them using walls specified as **Foundation Walls** .

Foundations and the Terrain

Home Designer automatically raises the structure in a plan a set distance above the terrain. See [Terrain Height vs Floor Height on page 848](#).

In a plan with a foundation present, the terrain will be:

- 6" (187 mm) below the top of the stem walls or grade beams in a Walls with Footings or Grade Beams on Piers foundation.
- 8" (200 mm) below the top of the slab in a Monolithic Slab foundation.

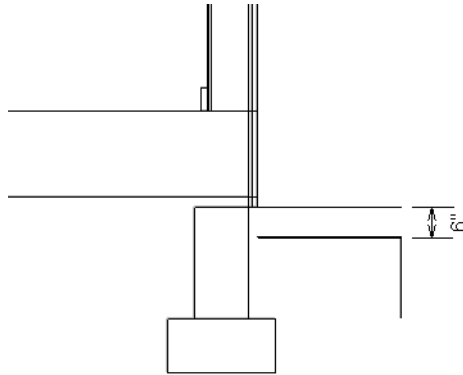

By default, the program will also create a flattened pad under the building footprint.

Not all foundations have these requirements, of course, so you can customize your foundation and terrain to suit your needs.

DAYLIGHT BASEMENTS

Daylight basements, also referred to as look-out basements, have walls that are tall enough for basement windows to be positioned above the terrain. They are often found in split level or split entry structures.

To create a daylight basement condition, build a stem wall foundation and modify these settings in the Terrain Specification dialog:

- Uncheck **Auto Calculate Elevation**.
- Increase the **Building Pad Elevation**, which is the distance between the default floor height of Floor 1 and the terrain.

WALKOUT BASEMENTS

Walkout basements are a type of daylight basement typically located on sloped terrain. They feature walls that are above ground at the lower end of the slope so that a door can be positioned above the terrain at that end.

To create a walkout basement, build a stem wall foundation and modify these settings in the Terrain Specification dialog:

- Uncheck **Flatten Pad**.
- Uncheck **Auto Calculate Elevation**.

You will also need to create sloped terrain and adjust the **Building Pad Elevation** and/or terrain data so that the terrain is at the appropriate height relative to the structure at both the high and low ends of the slope.

STEPPED FOUNDATIONS

Stepped foundations are usually built on sloping terrain. A stepped foundation will be produced automatically if more than one floor height is present on Floor 1 when the foundation is built.

In plan view, steps in stem wall and monolithic slab foundations are represented using S markers. See [Displaying Foundations on page 487](#).

As with a walkout basement, you will need to build a stem wall foundation and modify these settings in the Terrain Specification dialog:

- Uncheck **Flatten Pad**.
- Uncheck **Auto Calculate Elevation**.



You will also need to create sloped terrain and adjust the **Building Pad Elevation** and/or terrain data so that the terrain is at the appropriate height relative to the structure at both the high and low ends of the slope.

You can also create a stepped foundation by editing foundation rooms and walls. See *Stem Wall Height on page 488*.

The Slab Tools

 Select **Build> Slab** to access the Slab Tools.



SLABS

  Select **Build> Slab> Slab** or **Slab With Footing**, then either click or click and drag a rectangle to draw a slab. The Slab Tools are intended for generic purposes than foundations and should not be substituted for a foundation plan. See *Rectangular Polyline on page 217*.

A newly drawn **Slab** or **Slab With Footing** inherits the settings in the Slab Defaults or Slab with Footing Defaults dialog. Once created, slabs can be edited like other closed polylines. See *Editing Slabs on page 493*.

A slab is also created when the **Post with Footing**  tool is used. See *Post with Footing on page 611*.

PIERS AND PADS

  Piers and pads can be manually placed under walls, railings, or beams on any floor. Select **Build> Slab> Round Pier** or **Build> Slab> Square Pad** and click in plan view to place a pier or pad.

For information about editing Round Piers and Square Pads, see *Editing Piers and Pads on page 495*.

SLABS AND THE MATERIALS LIST

If a slab's material type is specified as Concrete or Volume, the materials list calculates the total volume of the slab and all footings. See *Define Material Dialog on page 726*.

Editing Slabs

Slabs can be selected in 2D and 3D views both individually and as a group and can be edited using the edit handles, the Edit Toolbar, and the Slab Specification dialog. See *Slab Specification Dialog on page 494*.

USING THE EDIT HANDLES

Slabs can be edited like other closed-polyline base objects in both 2D and 3D views. See *Editing Closed Polyline-Based Objects on page 155*.

USING THE EDIT TOOLS

One or more selected Slabs can be edited in a variety of ways using the buttons on the Edit Toolbar. As with most objects, Slabs can be copied, replicated, moved, deleted, etc. See *The Edit Toolbar on page 91*.

Slab Specification Dialog

Select one or more Slabs and click the **Open Object** edit button to open the Slab Specification dialog.

The options in this dialog are similar to those in the Slab Defaults and Slab with Footing Defaults dialogs, but affect the selected slab(s) only.

GENERAL PANEL

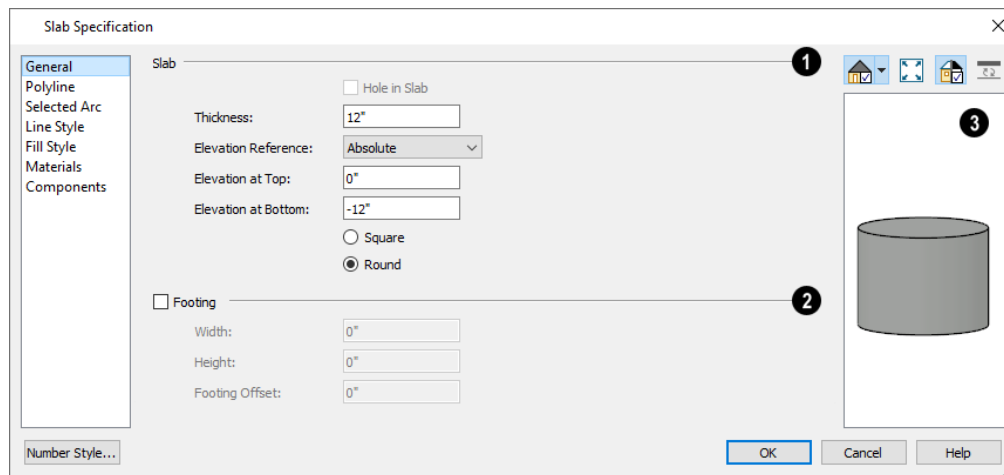

1 Slab

Specify the characteristics of the selected **Slab**.

- Specify the **Thickness**, which is the measurement from the slab's top to bottom surfaces.
- Select the **Elevation Reference**, from the drop-down list. This determines where the next two settings are measured from and also affects their setting labels.
- Specify the slab's height **to Top**, which is of its top surface measured from the selected Elevation Reference.
- Specify the slab's height **to Bottom**, which is the height of its bottom surface, measured from the Elevation Reference.
- When the selected slab is a Post Footing or Deck Post Footing, specify whether it is **Square** or **Round**. Not available for manually drawn slabs or if the slab's shape has been modified using the **Change Line/Arc**  edit tool. See *Post with Footing on page 611*.

2 Footing

Specify the characteristics of the selected slab's **Footing**. Not available in the Slab Defaults dialog.

- Check **Has Footing** if you would like the slab to have a footing around the inside of its perimeter.
- Specify the **Height** and **Width** for the footing.
- Specify the **Footing Offset**, which is the distance that the footing extends out past the edges of the slab. A value of 0 aligns the outside of the footing with the outside of the slab.

3 Preview

A preview of the selected slab displays on the right side of the panel. See *Dialog Preview Panes on page 20*.

POLYLINE PANEL

The POLYLINE panel states the length of the selected slab's **Perimeter**, its enclosed **Area**, and its **Volume**. See *Polyline Panel on page 215*.

SELECTED LINE PANEL

The SELECTED LINE panel is available when the selected edge is a line as opposed to an arc. For information about the settings on this panel, see *Polyline Specification Dialog on page 215*.

SELECTED ARC PANEL

The SELECTED ARC panel is available when the selected edge is an arc as opposed to a line. See *Change Line/Arc on page 174*.

LINE STYLE PANEL

For information about the settings on this panel, see *Line Style Panel on page 204*.

FILL STYLE PANEL

The settings on the FILL STYLE panel affect the selected slab's appearance in plan view. For information about these settings, see *Fill Style Specification Dialog on page 131*.

MATERIALS PANEL

For information about the settings on this panel, see *Materials Panel on page 716*.

COMPONENTS PANEL

The information on the COMPONENTS panel can be used in the materials list. For more information, see *Components Panel on page 921*.

Editing Piers and Pads

Round Piers and Square Pads can be selected individually and in groups in 2D and 3D views and edited using their edit handles and edit toolbars.

There are several ways to move piers and pads; however, they must always be positioned under a wall. A pier or pad can only be moved away from the wall it is placed beneath if it is moved to another wall.

USING THE MOUSE

In plan view, piers and pads can be edited like CAD lines. Three edit handles allow the pier or pad to be resized and moved along the wall it is placed beneath. See *Editing Line-Based Objects on page 145*.

In 3D views, piers and pads can be edited like CAD boxes. See *Editing Box-Based Objects on page 158*.

USING DIMENSIONS

In plan view, piers and pads can also be moved using dimensions. See *Moving Objects Using Dimensions on page 332*.

 If you move a foundation wall or beam, any piers or pads it contains will move with it.

USING THE EDIT TOOLS

A selected pier or pad can be edited in a variety of ways using the buttons on the Edit Toolbar. As with most objects, piers and pads can be replicated, moved, deleted, etc. See [The Edit Toolbar on page 91](#).

Fireplaces

 A selection of freestanding fireplace symbols is available in the Architectural Core Catalog. See [The Library on page 668](#).

 A masonry fireplace can be placed in or away from a wall by selecting the legacy **Fireplace** tool and then clicking in the drawing area.

- If created in a wall, it is considered a wall opening and can be moved or resized like a window or door.
- If created away from a wall, it moves and resizes similar to a cabinet.

The legacy **Fireplace**  tool can be added to the toolbars. See [Adding and Removing Buttons on page 92](#).

The display of fireplaces is controlled in the Layer Display Options dialog. See [Layer Display Options Dialog on page 126](#).

Fireplaces can be edited, moved, resized, and deleted similar other objects. See [Editing Objects on page 136](#).

BUILT INTO A WALL

Flush and Mantle fireplace symbols are available in different styles in the Library Browser and can be positioned against a wall to create the front face of a built-in fireplace. For information about adding a chimney, see [Chimneys on page 500](#).

To place a masonry fireplace in a wall, click the **Fireplace**  button, then click on a wall. A fireplace is created with the outside of the fireplace flush with the outside of the wall.

Fireplaces cannot be placed in a wall specified as Invisible or if the wall in question is on a locked layer. See [Locking Layers on page 125](#).

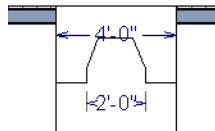

A selected masonry fireplace inserted into a wall has four edit handles, all located along the wall.

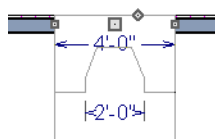

Click the diamond-shaped Depth handle and drag toward the outside of the wall. The fireplace will stop when the firebox front is flush with the inside edge of the wall.

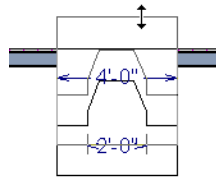

In 3D views, fireplaces placed in walls have five edit handles: a Resize handle along each edge and a Move handle at the center.

Fireplaces always face the interior when placed on an exterior wall. When placing a fireplace in an interior wall, click on the edge of the wall that you want the fireplace to face. The fireplace is created with the firebox on the same side as the wall edge you clicked on to create it.

FREESTANDING FIREPLACES

A selection of freestanding metal and adobe fireplace unit symbols is available in the Library Browser.

To place a free-standing masonry fireplace, click the **Fireplace**  button, then click in an open area away from a wall.

Both fireplace symbols and freestanding legacy masonry fireplace objects have ten edit handles when selected and may be rotated, resized, or moved in any direction, similar to the way CAD boxes can. See [Editing Box-Based Objects on page 158](#).

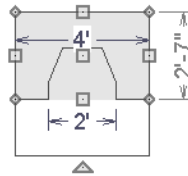

Free-standing fireplaces can be selected and replaced with a symbol from the library by clicking the **Replace From Library**  edit button. See [Replace From Library on page 689](#).

MASONRY FIREPLACE FOUNDATIONS

When a Walls with Footings or Grade Beams on Piers foundation is built, a fireplace foundation will be generated under any **Fireplaces**  present on Floor 1. See [Building a Foundation on page 485](#).

Fireplace foundations are the same material type as the original fireplace, but do not have a firebox or a hearth. Fireplace foundations can be edited or deleted as needed. A firebox and hearth can be added in the Fireplace Specification dialog. See [Fireplace Specification Dialog on page 497](#).

Fireplace Specification Dialog

 Select a legacy Fireplace and click the **Open Object** edit button to display the Fireplace Specification dialog. Multiple fireplaces can be group-selected, but all objects in selection group must be either placed in a wall or free-standing.

Dimensions in this dialog here must be entered in whole inches. Fractions and decimals are not accepted.

GENERAL PANEL

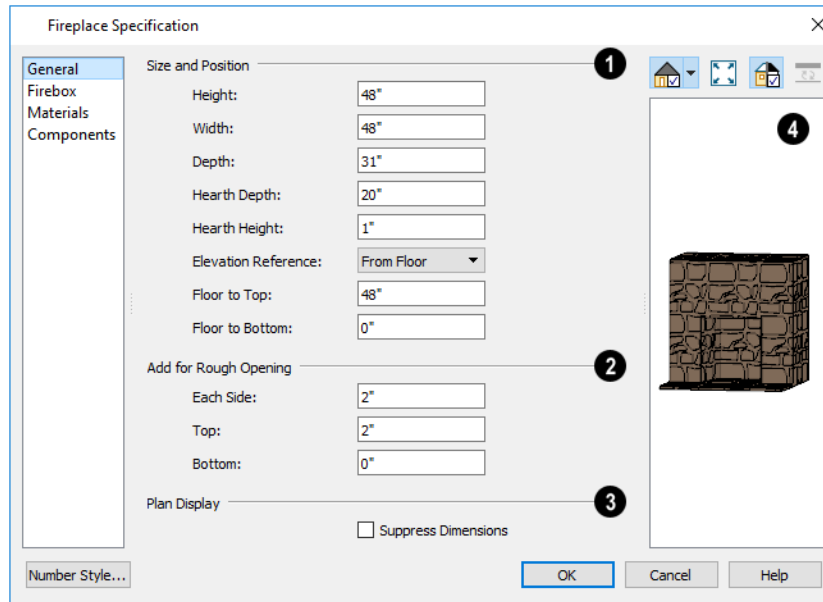

1 Size and Position

- Specify the **Height**, **Width**, and **Depth** of the fireplace.
- Specify the **Hearth Depth**. This is measured from the front of the fireplace out into the room. To eliminate the hearth altogether, enter a zero for this value.
- Specify the **Hearth Height**, relative to the floor in the room that the fireplace faces.
- Select the **Elevation Reference** from the drop-down list. This determines where the next two settings are measured from and also affects their setting labels.
- Specify the height **to Top**, measured from the selected Elevation Reference.
- Specify the height **to Bottom**, measured from the selected Elevation Reference.

2 Add for Rough Opening

Specify the amount to add to **Each Side**, the **Top** and the **Bottom** for the fireplace's framed rough opening. Only available for a fireplace placed in a wall, **Each Side** and **Top** are set to 2" (50 mm) by default.

- If the Bottom Rough Opening value exceeds the fireplace's distance to the floor, the difference is added to the top when wall framing is built.
See *Framing on page 605*.

3 Plan Display

Check **Suppress Dimensions** to turn off the display of the selected fireplace's width and firebox width dimensions in floor plan view.

4 Preview

The preview of the fireplace updates as changes are made.
See *Dialog Preview Panes on page 20*.

FIREBOX PANEL

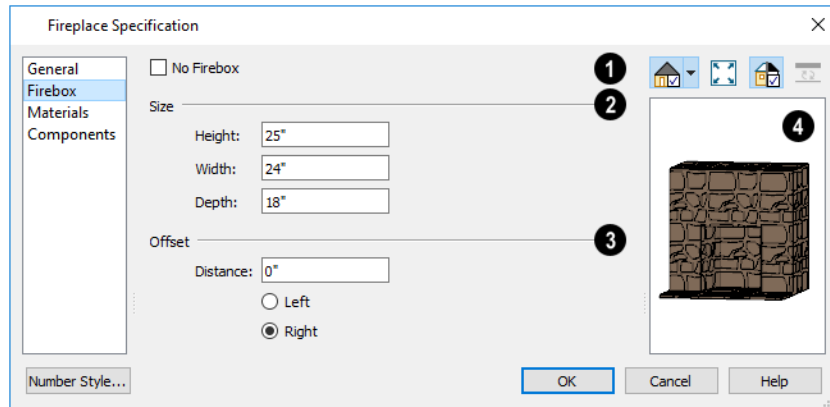

1 No Firebox

Check **No Firebox** to eliminate the firebox from the fireplace. This is checked by default for a fireplace object generated on Floor 0 to serve as a solid matching base for a fireplace on Floor 1.

2 Size

- Specify the firebox's **Height** and **Width**.
- Specify the **Depth** of the firebox.

3 Offset

- Enter the offset **Distance**, which is how far the firebox is offset from the fireplace center. A value of 0 centers the firebox in the fireplace.
- **Offset to Left/Right** - Choose to offset the firebox to the left or to the right.

4 Preview

The preview of the fireplace updates as changes are made. See [Dialog Preview Panes on page 20](#).

MATERIALS PANEL

For information about the settings on this panel, see [Materials Panel on page 716](#).

COMPONENTS PANEL

The information on the COMPONENTS panel can be used in the materials list. For more information, see [Components Panel on page 921](#).

Library Fireplaces

A variety of fireplace symbols are available in the library. Flush fireplaces are designed to snap to wall surfaces. Some fireplace symbols can be enclosed by walls or positioned to project through a wall. See [Placing Library Objects on page 686](#).

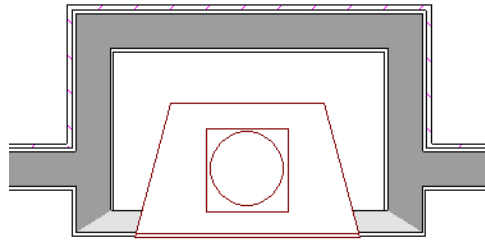

 Always check the manufacturer's product information for the framing and clearance requirements of the fireplace unit you plan to use, and design your plan accordingly

Chimneys

Chimneys can be created using a variety of methods.

MASONRY FIREPLACE CHIMNEYS

To create a chimney on a masonry fireplace

1. Select the fireplace in a 3D view.
2. Ctrl + drag the top edge of the chimney upward through all the floors and the roof until it is to the desired height. See [Unrestricted Movement on page 166](#).
3. When the chimney is approximately the correct height, select the fireplace, click the **Open Object**  edit button, and type in the exact height.

CHIMNEY CHASES AND CAPS

There are two ways to draw a chimney chase:

- Place a closed box Geometric Shape or Soffit over the chimney chase, resize it to match, then increase its height either in its specification dialog or in a 3D view using the same method as extending a masonry fireplace.
- Use walls to define the chimney chase as a room area, making sure these walls are aligned between floors. The chimney chase “room” on the uppermost floor should have a much higher ceiling than the other rooms on that floor and should also have no ceiling or roof. See [Room Specification Dialog on page 300](#).

A selection of chimney tops is available in the library. In addition, custom chimney caps can be made using Geometric Shapes and/or Soffits. See [Other Objects on page 702](#).

Multiple Floors

Chapter 20

When a new plan file is opened in Home Designer Pro, two floor levels are present: Floor 1 and the Attic Floor. You can add more floors whenever you like: up to 5 total. Once created, floors can also be copied and deleted.



Home Designer also supports special floors for foundations and attics. Only one foundation level and one attic can exist in a plan. Foundations are discussed in their own chapter. See *Foundations on page 481*.

TOPICS

Floor Defaults Dialog	502
Floor Tools	502
Adding Floors	503
Displaying Floors	504
Exchanging Floors	505
Copying Floors	506
Deleting Floors	506
Rebuilding Walls, Floors and Ceilings	506
Split Levels	507
The Current Floor	508
The Attic Floor	509
The Reference Floor	509

Floor Defaults Dialog

 There is a Floor Defaults dialog for each floor in a plan file aside from the Attic floor, which can be accessed by selecting **Edit> Default Settings**. Click the arrow to the left of “Floors and Rooms” to expand the category, then expand the “Floor Levels” subcategory. Select a floor level one or more floor levels and click the **Edit** button to open the Floor Defaults dialog for that floor. See [Default Settings vs Preferences on page 54](#).

- Floor Defaults can also be accessed by double-clicking the **Floor Tools**  parent button.
- In addition, the **Floor Defaults**  button can be added to the toolbars. See [Toolbar Customization Dialog on page 95](#).

The Floor Defaults dialog also opens whenever you add a new floor to the plan. See [Adding Floors on page 503](#).

The Floor Defaults dialog does not open when you build a foundation; however, the **Floor 0 Default** settings are created based on the current Foundation Defaults. See [Foundation Defaults on page 482](#).

The Floor Defaults dialog is similar to the Room Specification dialog, but controls the default settings for all rooms on the floor in question. The settings here also control the height of individual walls as they are drawn on that floor. See [Room Specification Dialog on page 300](#).

Note: The default floor height for Floor 1 is 0. It can be modified in the Room Specification dialog, but not in the Floor 1 Defaults dialog. See [Floor and Room Defaults on page 280](#).

STRUCTURE PANEL

The settings on the STRUCTURE panel are similar to those in the Room Specification dialog. See [Structure Panel on page 302](#).

MOLDINGS PANEL

The settings on the MOLDINGS panel are similar to those in the Room Specification dialog. See [Moldings Panel on page 665](#).

FILL STYLE PANEL

The settings on the FILL STYLE panel are similar to those in the specification dialogs for many objects throughout the program. See [Fill Style Specification Dialog on page 131](#).

MATERIALS PANEL

The settings on the MATERIALS panel are similar to those in the specification dialogs for many objects throughout the program. See [Materials Panel on page 716](#).

Floor Tools

 Select **Build> Floor** to access the following floor tools:



Build New Floor builds a new floor; a new floor can be generated based upon the perimeter of the floor below or a blank floor can be created and drawn from scratch. See [Adding Floors on page 503](#).



Insert New Floor inserts a new floor below the Current Floor. See [Adding Floors on page 503](#).



Delete Current Floor removes the Current Floor from the plan. For more information, see [Deleting Floors on page 506](#).



Build Foundation opens the Foundation Defaults dialog and build a foundation floor. See [Building a Foundation on page 485](#).



Delete Foundation removes the foundation from the plan. See [Deleting Foundations on page 490](#).



Rebuild Walls/Floors/Ceilings forces Home Designer Pro to recalculate the relationship between the walls, floors, and ceilings in your model. See [Rebuilding Walls, Floors and Ceilings on page 506](#).

Adding Floors

When a new plan file is opened in Home Designer Pro, two floor levels are present: Floor 1 and the Attic Floor. You can add up to 5 total living floors, as well as create a foundation below Floor 1.

Floors can be added whenever you like; and once created, they can also be copied and deleted.

Note: Home Designer allows only one floor, the foundation/basement, below Floor 1. See [Foundations on page 481](#).

BUILD NEW FLOOR



New floors can be created in plan view as well as in 3D views, and are always added above the top living floor. To create a new floor, select **Build> Floor> Build New Floor**.

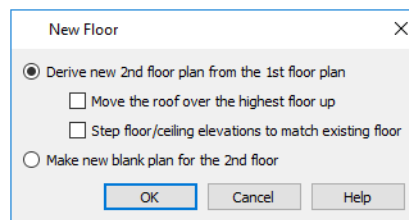

- **Derive new 2nd floor plan from the 1st floor plan** creates a new top floor with exterior walls generated directly over the exterior walls of the floor below. Wall types and roof directives associated with the walls on the floor below are duplicated; however, interior walls are not. See [Roof Panel on page 266](#).
- Check **Move Highest Floor's Roof Up** to move any roof planes displaying on the highest floor in the plan up one floor when the new floor is created. Roof planes displaying on floors other than the top floor are unaffected. This option is only available if there are roof planes built on the top floor and is not available when **Auto Rebuild Roofs** is enabled. See [Build Roof Dialog on page 562](#).



When Move highest floor roof up is checked, roof planes on the top floor will move even if the "Roof Planes" layer is locked and manually edited roof planes are set to be retained. See [Roof Panel on page 563](#).

- Check **Step floor/ceiling elevations to match existing floor** to maintain all ceiling heights on the existing floor by stepping floor heights on the new floor to match. Ceiling heights on the new floor also become stepped accordingly. See [Floor and Ceiling Platforms on page 295](#).
- **Make new (blank) plan for the # floor** creates a new top floor that is blank. This option is typically useful only if none of the exterior walls on the new floor will be directly above the exterior walls on the floor below. If you choose this method, it may be helpful to turn on the Reference Floor when drawing walls on the new floor. See [The Reference Display](#).

When you click OK, the Floor Defaults dialog for the newly created floor opens. Make any necessary changes to the floor structure, moldings, or materials and click OK. See [Floor Defaults Dialog on page 502](#).

The new floor becomes the Current Floor in plan view. If, however, the new floor is created in a 3D view, the camera remains on its original floor and does not move.

INSERT NEW FLOOR



A floor level can also be inserted beneath the Current Floor in both plan and 3D views. Begin by going to the floor level you would like to insert a floor under to make it the Current Floor, then select **Build> Floor> Insert New Floor**. See [The Current Floor on page 508](#).

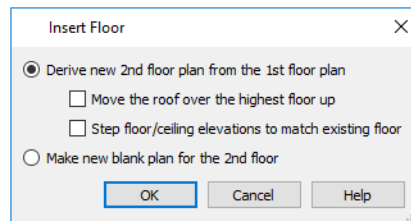

- Select **Derive new # Floor plan from the # Floor plan** to insert a new floor below the Current Floor, with exterior walls based on those of the Current Floor.
- Check **Move Highest Floor's Roof Up** to move any roof planes displaying on the highest floor in the plan up one floor when the new floor is created. Roof planes displaying on floors other than the top floor are unaffected. This option is only available if there are roof planes built on the top floor and is not available when **Auto Rebuild Roofs** is enabled. See [Build Roof Dialog on page 562](#).



When Move highest floor roof up is checked, roof planes on the top floor will move even if the "Roof Planes" layer is locked and manually edited roof planes are set to be retained. See [Roof Panel on page 563](#).

- Check **Step floor/ceiling elevations to match existing floor** to maintain the floor and ceiling heights on the existing floors by stepping floor and ceiling heights on the new floor to match. See [Floor and Ceiling Platforms on page 295](#).
- Select **Make new (blank) plan** to insert a blank floor below the Current Floor.

ADDING A FOUNDATION

To add a foundation, select **Build> Floor> Build Foundation** . See [Building a Foundation on page 485](#).

Displaying Floors

Home Designer allows you to view the floors in your plan in a variety of ways.

IN PLAN VIEW

In plan view, only one floor can be active for editing at a time. This is referred to as the Current Floor. See [The Current Floor on page 508](#).

In addition to the Current Floor, one other floor can be displayed for reference purposes: the Reference Floor. Objects on the Current Floor can snap to those on the Reference Floor, helping you align objects. See [The Reference Display](#).

Floor and ceiling platforms do not display in plan view. When floor and/or ceiling framing is present, its display can be turned on; however, other components of floor and ceiling platforms like sheathing, drywall, and finish materials, cannot.

IN 3D VIEWS

In 3D views, all floors in a plan are visible, from the foundation up to the attic. There are two exceptions:



Orthographic and Perspective Doll House Views, which show the Current Floor, not including its ceiling, plus any floors beneath it.



Wall Elevation views, which show a wall on a single floor, in a single room.

See [3D View Tools on page 740](#).

IN THE MATERIALS LIST

The materials that make up floor and ceiling platform assemblies are listed under different Categories in the Materials List:

- **Subfloor** - Lists floor framing and structural subflooring materials specified in all Floor Structure Definitions in the current plan. See [Floor and Ceiling Platform Definitions on page 296](#).
- **Flooring** - Lists flooring and subflooring materials specified in all Floor Finish Definitions in the current plan.
- **Framing** - Lists ceiling framing and any other materials specified in all Ceiling Structure Definitions in the current plan.
- **Wall Board** - Lists ceiling finish materials specified in all Ceiling Finish Definitions in the current plan.
- **Insulation** - Floor insulation is calculated for all rooms that have a floor, and ceiling insulation is calculated for all rooms that have a ceiling - regardless of the Floor or Ceiling Structure Definition. When a ceiling is not present, insulation is calculated for the roof. See [Structure Panel on page 302](#).
- **Foundation** - Lists the concrete and mesh for all Floor Structure Definitions in the current plan with a layer of concrete material. See [Materials and the Materials List on page 723](#).

See [Materials Lists on page 904](#).

Exchanging Floors



Select **Build> Floor> Exchange With Floor Above** or **Exchange With Floor Below** to swap the Current Floor with the floor above or below.

The floor that was moved becomes the Current Floor at its new location. You can easily move a floor up or down several floors by using either one of these buttons repeatedly.

Copying Floors

The **Edit Area**  tools can be used to make copies of entire floors in a plan. See *Edit Area Tools on page 182*. You can use these tools to:

- Make a copy of an existing floor to be pasted onto a new floor.
- Make a copy of all existing floors in a plan to be pasted into a different plan.

You can also copy the information on a floor by pressing Ctrl + A (Select All), then using **Copy**  and **Paste Hold Position** . See *Paste Hold Position on page 120*.

COPYING BETWEEN PLANS

While you can copy and paste floors from one plan file to another, this is not always the best approach.

- To make a copy of the plan for backup or your records, use **Save As**  to save the file using a new name. See *Saving Plan and Layout Files on page 37*.
- To copy the model into another plan with multiple structures, consider exporting it as a symbol and importing it into the new plan. See *Custom Symbols*.

Deleting Floors



Select **Build> Floor> Delete Current Floor** to remove the Current Floor from the plan. If there is a floor above, it becomes the Current Floor; if there is no floor below, the floor beneath becomes the Current Floor.



To delete Floor 0, select **Build> Floor> Delete Foundation**. You can delete the foundation without actually being on Floor 0. Floor 0 cannot be deleted while **Auto Rebuild Foundation** is turned on. See *Deleting Foundations on page 490*.



When a floor is deleted, all objects on that floor are deleted with it, including locked roof planes and any other objects on locked layers. See *Locking Layers on page 125*.

Rebuilding Walls, Floors and Ceilings



When you make a change to the walls or to the floor or ceiling platforms in your plan, they may not immediately resize or move in the 3D model. The program does detect such changes, though, and the next time you generate a 3D or section/elevation view, walls, floors and ceilings are rebuilt.

By default, walls, floors and ceilings are also rebuilt when an automatic roof is generated. See *Build Roof Dialog on page 562*.

You can direct the program to rebuild walls, floors, and ceilings at any time by selecting **Build> Floor> Rebuild Walls/Floors/Ceilings** .

If you do not want the program to rebuild walls, floors and ceilings when a 3D view is created, uncheck **Auto Rebuild Floors and Ceilings** in the 3D View Defaults dialog. This may speed up plan view editing for very large plans. When this is

unchecked and the structure is not up-to-date, the **Rebuild Walls, Floors, Ceilings**  icon displays near your mouse pointer. See [3D View Defaults Dialog on page 739](#).

Split Levels

Both split level floor plans and split level entries can be created by controlling the floor and ceiling heights of individual rooms in a multiple story structure.

For more detailed information about both types of structure, visit HomeDesignerSoftware.com.

SPLIT LEVEL FLOOR PLANS

A split level, or tri-level, structure is a building where the floor level in one part of the plan is located approximately halfway between the floor and ceiling levels of another part of the plan.

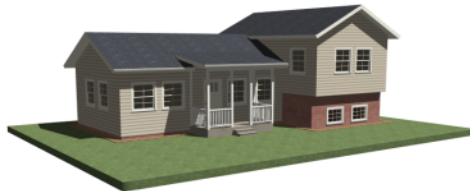

To create a simple split level plan



1. Draw a simple rectangular structure divided into two separate halves by an interior wall.
2. Select one of the rooms and click the **Open Object**  edit button. See [Room Specification Dialog on page 300](#).
3. Raise the **Floor Height** then press the Tab key.
4. Restore the **Relative Rough Ceiling** to the default value, then click OK.
5. Build a stem wall foundation. See [Foundations on page 481](#).
 - The foundation under the room with the lower floor height will have the specified Min Stem Wall Height.
 - The foundation under the room with the raised floor will have taller stem walls.
 - Both can be edited in the Room Specification dialog.
6. If you add a Floor 2, note that the **Ceiling Height** in the room on Floor 1 will be reset to the default value.
 - To maintain a stepped condition on multiple floors, return to this room and set the **Relative Rough Ceiling** back to using the default.

SPLIT LEVEL ENTRIES

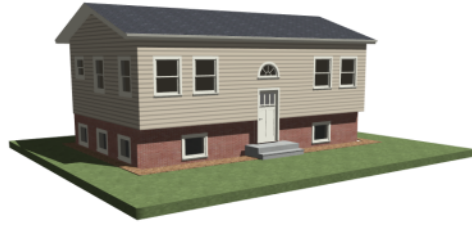
A split level entry, or divided entry, is characterized by an entry door that opens onto a landing positioned halfway between the basement floor and first floor levels.



To create a simple split level entry

1. Create a plan file with a full basement at the location of the entry door. See [Basement Rooms on page 491](#).
2. Go to Floor 0 and draw a stair **Landing**  at the location of the entry. See [Landings on page 521](#).
3. Specify the desired height of the landing. See [Stair Landing Specification Dialog on page 553](#).
4. Draw stairs upward from the basement floor to the landing.
5. Draw a second stair section from the landing upward.
6. Select the stairs and click the **Auto Stairwell**  edit button. See [Creating a Stairwell on page 535](#).

Split level entries are often associated with daylight basements. See [Daylight Basements on page 492](#).

The Current Floor

In a given plan view window, only one floor level can be active at any given time. The active floor is referred to as the **Current Floor**, and it is the only floor on which objects can be edited.

If you would like to view two different floor levels side by side, open a second plan view, navigate to the desired floor, and then tile the two views. Although both are visible, only one of these view windows is active. See [Working in Multiple Views on page 103](#).

FLOOR UP / FLOOR DOWN



If you are working with more than one floor, you can select **Tools> Floor/Reference Display> Up One Floor** or **Down One Floor** to switch from one floor to another.

You can change the Current Floor in floor plan, cross section/elevation and 3D views. The Current Floor displays on the **Change Floor/Reference**  button, which can be found between the **Down One Floor** and the **Up One Floor** buttons.

Floors become available once they have been built. The Attic and foundation levels are also accessible using these tools.

CHANGE FLOOR / REFERENCE

1 If there are multiple floors, select **Tools> Floor/Reference Display> Change Floor/Reference** to open the Change Floor/Reference dialog, where you can select both the Current Floor and which floor is used in the Reference Floor, as well as control the appearance of the Reference Floor. See [The Reference Display](#).

The Attic Floor

A Home Designer automatically creates a floor above the top numbered floor level of each plan. This floor is called the Attic floor and has only one purpose: to provide a space for automatically generated Attic walls. See [Attic Walls on page 254](#).

In some situations, you may find it necessary to draw one or more walls on the Attic floor; however, even if you enclose an area with walls, rooms cannot be created on this floor level. If you wish to create an attic loft or bonus room in your plan, you must do so on a numbered floor level.

Because the Attic floor is not meant to be a living area, a warning message will display if you try to draw walls or other objects on this floor level.

The Reference Floor

When the Reference Floor Display is turned on, the floor level below the Current Floor is used as the Reference Floor. If there is no floor level below, the floor above is used. By default, the Reference Floor displays in red.

You can specify which floor is used in the Reference Display in the Change Floor/Reference dialog: select **Tools> Floor/Reference Display> Change Floor/Reference** or click the **floor level**  toolbar button. See [Change Floor / Reference Dialog](#).

Note: When objects on the Current Floor and the Reference Floor align and lines of two different colors are superimposed upon each other, discoloration may result.

Stairs, Ramps, and Landings

Chapter 21

Staircases can be composed of one or more straight or curved stair sections, ramps, and landings. Stairs and ramps can be drawn, selected and edited in 2D and 3D views.

Starter treads can be defined, stair sections can be flared, treads can be wrapped, and curved sections can be turned into winders.

Landings can be created automatically or manually and their shape customized. You can edit an existing landing, or create a landing from a closed CAD polyline. Landing heights can be defined or you can let them automatically adjust as needed.

Stairwells can be created automatically or manually and can be seen in 3D views.



Local building and fire authorities must be consulted for specific stair construction codes and access requirements.

TOPICS

Stair and Ramp Defaults	511
The Stair Tools	511
Anatomy of a Staircase	512
Drawing Stairs and Ramps	513
L- and U-Shaped Stairs	515
Displaying Stairs, Ramps, and Landings	516
Editing Stairs and Ramps	517
Stair and Ramp Sections and Subsections	518
Landings	521
Maintaining Tread Depth	523
Flared Stairs and Curved Treads	524
Starter Treads	527
Winders	529
Wrapped Stairs	530
Other Special Railings and Stairs	531
Creating a Stairwell	535
Rooms Below Staircases	537
Staircase Specification Dialog	538
Ramp Specification Dialog	550
Stair Landing Specification Dialog	553

Stair and Ramp Defaults

The purpose of interior stairs is to provide passage from one floor platform to another, so the attributes that influence floor heights - including ceiling heights, floor platform thicknesses, and floor finish materials - also influence the structure of stairs. When considering a staircase's structure, bear in mind that riser height is directly dependent on the distance from one floor platform to another.

When **Automatic Heights** are used, stairs are built so that they rest on the top of the floor structure of the floor where they are drawn, and build up to the top of the floor structure on the floor above. Risers are measured to the floor finish surfaces on both floors. See *Floor and Ceiling Platform Definitions on page 296*.

Ramps are built in a similar manner: interior ramps bear on the floor structure, and when **Automatic Heights** are used, the top surface of both interior and exterior ramps locates floor finish surfaces.

The Stair Tools



Select **Build> Stairs** to access the Stair Tools.

DRAW STAIRS



To draw a straight staircase select **Build> Stairs> Draw Stairs**, then click and drag in floor plan or a 3D view. You can also click once to place a staircase that extends from the current floor up to the next floor. See *Drawing Stairs and Ramps on page 513*.

STRAIGHT STAIRS



Select **Build> Stairs> Straight Stairs**, then click to create stairs between the current floor and the floor above. To create stairs between two floor platforms on the current floor, click on the low side, within a few feet of where the floor changes height.

- If you click on the low side of a floor platform defined by a railing, a doorway will be created in the railing, adjacent to the stairs.
- If you click on the low side of a floor platform defined by a wall, stairs will be created but a doorway will not.
- If you click at a location that is not near the edge of a floor platform, a full height staircase will be created.

CURVED STAIRS



Select **Build> Stairs> Curve to Left** or **Curve to Right** and click once in plan view to place a curved staircase. See *Curved Stairs and Ramps on page 514*.

L-SHAPED STAIRS



Select **Build> Stairs> L-Shaped Stairs**, then click to create two equal stair sections that form a 90° corner and are connected by a landing. See *L- and U-Shaped Stairs on page 515*.

U-SHAPED STAIRS



Select **Build> Stairs> U-Shaped Stairs**, then click to create two stair sections that form a 180° turn and are connected by a landing.

LANDING



Select **Build> Stairs> Landing** to draw a landing, which is a platform connecting two or more stair sections. See [Landings on page 521](#).

There are two ways to create a landing using this tool:

- Click once to place a landing measuring 39" (975 mm) on each side.
- Click and drag to draw a rectangular landing sized as needed. See [Polylines on page 214](#).

You can also create a landing by converting a CAD polyline. See [Convert Polyline on page 179](#).

RAMP



Select **Build> Stairs> Ramp** to draw a sloped ramp. By default, ramps are drawn at a 1:12 slope to a maximum height of 30" (760 mm). See [Drawing Stairs and Ramps on page 513](#).

SPIRAL STAIRS



In the Library Browser, browse to Home Designer Core Catalogs> Architectural> Spiral Stairs to access a selection of spiral staircase fixtures. Select the object that you want, then click in any view to place it in the plan. See [The Library on page 668](#).

Because spiral staircase symbols are fixture symbols, they do not have an Auto Stairwell edit tool. An opening in the floor above a spiral staircase must be created manually. See [Creating a Stairwell on page 535](#).

Anatomy of a Staircase

Stairs as well as ramps are often described in terms of **rise** and **run**. Rise is typically between 6" and 8", and the run between 10" and 12". In metric plans, rise is 177 to 190 mm, and the run is about 250 mm. Whenever possible, Home Designer will automatically apply reasonable rise and run values that meet most building codes to stairs and ramps as they are drawn.

In Home Designer, staircases automatically have a consistent rise and run along their length because this is also a typical requirement of most building codes. When this is not desired, however, stairs and ramps can be divided into multiple sections subsections. See [Stair and Ramp Sections and Subsections on page 518](#).

STAIRCASE TERMINOLOGY

Balusters - The vertical members that run between the handrail and the treads or bottom rail.

Bracket - Decorative L-shaped supports on the exposed side of stairs below each tread.

Landing - A platform connecting two or more stair sections.

Newels - The end post of a stair railing located at landings and the beginnings and endings of new stair sections.

Rise - The height of a riser, measured from tread surface to tread surface, Also referred to as Unit Rise.

Rise Angle - The angle of the staircase or stair section, defined by a line drawn through the back surfaces of its treads.

Riser - The vertical stair member located between the treads. Risers may be solid or open. When open, the front surfaces of the stringers are considered the risers.

Run - The depth of a tread, measured from riser surface to riser surface. Run does not include the Tread Overhang. Also referred to as Unit Run.

Runner - The carpet that runs down the center of the staircase.

Shoe - The bottom railing, placed on the landing floor, that anchors the balusters at landings.

Stringer - The inclined support member of a staircase that supports the treads and risers.

Tread - The horizontal member of a stair that the foot is placed on.

Tread Overhang - The portion of a tread extending past the front surface of the riser and over the tread below. Also referred to as Nosing or Nosing Extension, it is not included in the Run or Tread Depth measurements.

Tread Thickness - The vertical depth of the tread material.

Winder - A wedge-shaped stair tread used where curved or angled stairways change direction.

STAIR STRUCTURE AND THE MODEL

By default, stairs locate the height of the floor platform that they are drawn on and seek the next level, which may be the floor platform of the floor above or a landing. The stringers locate the subfloor of the floor platforms and maintain consistent riser height. If the stairs are long enough to reach the next level at a reasonable rise angle, their tread depth and number of treads are automatically calculated to create a staircase with consistent tread and riser dimensions along its entire length.

You can modify this behavior or turn off it off altogether in the Staircase Specification dialog and specify your own rise and run values. Bear in mind, though, that if you turn it off, you will need to specify the correct **Top** and **Bottom Heights** to make sure that the stairs actually meet both floor platforms correctly. See [General Panel on page 538](#).

Drawing Stairs and Ramps

Stairs and ramps can be drawn in floor plan and 3D views but not in cross section/elevation views. There are a few things to keep in mind when drawing stairs:

- Before stairs are created, make sure that the heights for both the lower and upper floors are correctly defined.
- Stairs are drawn going **UP**, so they should be drawn from the lower of the two floors they connect.
- By default, stairs adjust their riser and tread dimensions to connect two floor heights if possible. The rise and run are calculated so that the steps are consistent in size.
- Stairs drawn within 1" (25 mm) of a wall will snap to the outer surface of the wall.
- Stairs will snap to the **Reference Display** , if you have it turned on. See [The Reference Display](#).
- Hold down the Ctrl key to suppress these snapping behaviors.
- If a stairwell room has been defined on the floor above, the top of the stairs can be dragged until it stops at the railing or wall defining the stairwell.
- When drawing stairs or a ramp up from the terrain, it is a good idea to make sure the terrain is up to date. See [Building the Terrain on page 860](#).

STRAIGHT STAIRS AND RAMPS

The **Draw Stairs**  tool can be used in two different ways:

- Click and drag in a straight line to draw stairs that are the length that you drag.
- Click once to place stairs that go from the current floor up to the height of the next floor level.

You can also click once using the **Straight Stairs**  tool to create stairs between rooms on the same floor with different floor heights or between exterior rooms and the terrain. When the Straight Stairs tool is active, a preview outline of the stairs will follow the mouse pointer. Hold down the Alt key to reverse the direction of the Up arrow in the preview.

Similarly, **Ramps**  can be created by either clicking and dragging or by clicking. A ramp created with a single click will be 30" (760 mm) high, have a slope of 1:12, and be 360" (9120 mm) long.

An individual stair or ramp section must be between 6" (150 mm) and 100' (30 m) in length. If a greater length is needed, connect two sections using a landing.

CURVED STAIRS AND RAMPS

You can make a straight stair or ramp section curved, or vice versa:

- Select the stairs or ramp and click the **Change Line/Arc**  edit button. See [Change Line/Arc on page 174](#).
- Select the stairs or ramp, hold down the Alt key (or right-click), and drag an end edit handle. See [Alternate on page 138](#).

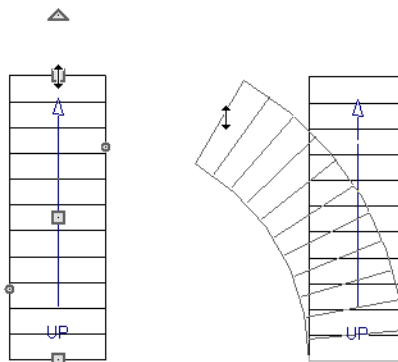

You can also curve straight stairs and ramps by drawing them against a curved wall.

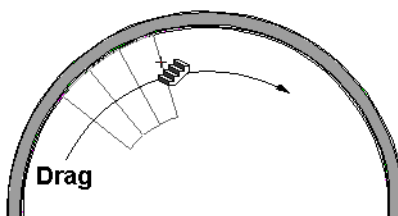

 **Curved Stairs** can also be created in plan view by selecting **Build> Stairs> Curve to Left** or **Curve to Right**. Click to place a 90° curved stair section that can then be edited. You can continue clicking to place additional curved staircases until another tool is selected.

DRAWING STAIRS AND RAMPS DOWNWARD

Stairs and ramps can be drawn from the current floor level downward; however, drawing stairs or ramps between floors in this manner is not recommended. Drawing downward should only be used to create a staircase or ramp between a porch or deck and the terrain when you require the direction arrow to say “DN” instead of “UP”. See [Displaying Stairs, Ramps, and Landings on page 516](#).

To draw stairs going downward

1. Select **Build> Stairs> Draw Stairs** .
2. Hold down the Alt key or the right mouse button.
3. Click and drag to create straight stairs.

When drawing stairs or ramps from a floor platform to the terrain, or vice versa, they will locate the height of the terrain as long as it is lower than the floor height. You can also create a landing or “room” outside the structure and use it to establish the bottom height of the stairs or ramp. Then, draw in an upward direction from the lower platform to the upper platform.

L- and U-Shaped Stairs



The **L-Shaped Stairs** and **U-Shaped Stairs** tools allow you to place staircases composed of two stair sections connected by one or more landings with a single click.

The staircases created with these tools build from the current floor to the floor above. If you need a staircase that builds between platforms on the same floor level, or in a downward direction, you will need to draw it manually. See [Landings on page 521](#).

When you select either tool, the New Shaped Staircase dialog opens.

NEW SHAPED STAIRCASE DIALOG

The settings in this dialog retained between sessions in the software and are global, affecting all plans.

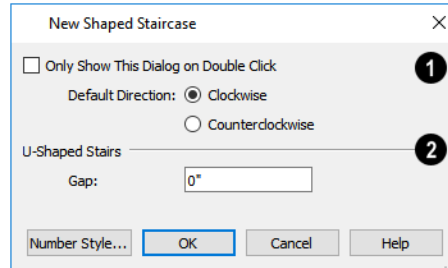

1 Only Show This Dialog on Double Click

Check **Only Show This Dialog on Double Click** to suppress this dialog unless the L-Shaped Stairs or U-Shaped Stairs is double-clicked.



- Specify the **Default Direction** of the stairs as they build upward: **Clockwise**, or **Counterclockwise**.
- Check **Make Winders** to create multiple landings with angled edges between the two stair sections. When unchecked, a single rectangular landing is produced.

2 U Shaped Stairs

- Specify the width of the Gap between the two stair sections.
- Check **Split Landing** to create two rectangular landings instead of one. When Make Winders is also checked, each of these two landings is further divided into triangular shaped winders.

When you click OK, a preview outline will follow the mouse pointer.

You can control the staircase's orientation and direction by moving the mouse pointer towards a wall.

- In the case of a **U-Shaped**  staircase, the landing will snap to the wall first.
- As you move the mouse pointer closer to the wall, the preview will rotate so that the upper stair section snaps to the wall.
- If you continue to move the mouse closer, the lower stair section will snap to the wall instead.
- If you move the mouse pointer into a wall corner, the preview will rotate so that the bottom stair section snaps to the wall that is nearest to the mouse pointer.
- When a **U-Shaped**  staircase preview is in a wall corner, move the mouse pointer within the landing area to control which wall the back of the landing snaps to. With the landing in place, move the mouse pointer over the two stair sections to control which is the bottom section.
- Press the Alt key to reverse these snapping behaviors and the stairs' direction.
- Hold down the Ctrl key to prevent the stairs from rotating or snapping to walls.

Displaying Stairs, Ramps, and Landings



The display of stairs, ramps, and landings in all views is controlled in the Layer Display Options dialog. Stairs, ramps, and landings are placed on the “Stairs & Ramps” layer. See [Layer Attributes on page 124](#).

IN PLAN VIEW

In plan view, stairs, ramps and landings display on the floor they were drawn on and are only visible from the floor above if there is a stairwell. See [Creating a Stairwell on page 535](#).

Stairs and ramps have an arrow indicating the direction they run. Interior stairs and ramps have an **UP** arrow on the floor they were created on and a **DN** arrow when viewed from the floor above. See [Drawing Stairs and Ramps on page 513](#).

The style and size of the direction arrow can be specified in the Staircase or Ramp Specification dialog. The Text Style, color, and display are controlled by the “Stairs & Ramps, Up/Down Arrows” layer. See [Arrow Panel on page 205](#).

When a staircase is selected in plan view, the numbers associated with each of its sections and subsections display. Stair sections are assigned a single number, while subsection numbers have two parts: a section number and subsection number separated by a hyphen.

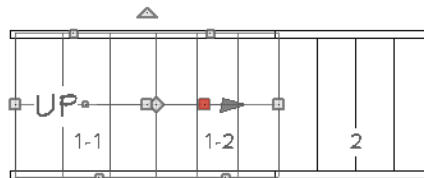

To see the center of a stair section curve in plan view, click **Show Arc Centers and Ends** . See [Arc Centers and Ends on page 151](#).

ON MULTIPLE FLOORS

Stairs and ramps display on the floor level on which they are drawn. If they are located beneath an Open Below room, they will be visible within the area of that room on the floor level above, as well.

IN 3D VIEWS

Although stairs span between two floors, they can only belong to one floor. As a result, only multi-floor views show the upper floor with the platform opening and the lower floor with the staircase simultaneously. In Doll House Views, stairwells may appear as an empty spaces. See *3D View Tools on page 740*.



Editing Stairs and Ramps

Staircases and ramps can be selected and edited in plan view and 3D views. See *Selecting Objects on page 141*.

To select a single section of a staircase, hold down the Shift key before clicking on it. When selected in this manner, a stair section can be edited independent of any other connected stair sections.

USING THE EDIT HANDLES

When a staircase or ramp is selected, its edit handles display. These edit handles can be used to customize the selected object in many ways. See *Editing Objects on page 136*.

- Straight stair sections and ramps are edited like lines. They have additional edit handles for resizing the width of the section. See *Editing Line-Based Objects on page 145*.
- Curved stair sections and ramps are edited like arcs and also include edit handles for resizing the stair's width. See *Editing Arc-Based Objects on page 147*.
- Ramps can be resized to a maximum top height of 30" (760 mm). If you extend a ramp's length to greater than 360" (9120 mm), its slope will decrease. For a taller ramp and control over the slope, uncheck **Automatic Heights** in the Ramp Specification dialog and specify the values you need. See *General Panel on page 550*.
- When stair sections are merged, the edit handles display differently depending on what subsection is currently selected. See *Merging Stair and Ramp Sections on page 519*.
- When moving merged stair or ramp sections, all merged sections and landings move as one unless **Stair Sections Move Independently** is checked in the Preferences dialog. To temporarily enable this behavior, hold down the Alt key on the keyboard. See *Architectural Panel on page 73* and *Alternate on page 138*.
- Additional edit handles display on the first two treads of a staircase if the **Starter Tread**  edit button is clicked. See *Starter Treads on page 527*.
- Several additional edit handles display on a staircase if the **Flare/Curve Stairs**  edit button has been clicked. See *Flared Stairs and Curved Treads on page 524*.

IN THE SPECIFICATION DIALOG

 Stairs and ramps can be customized and their structure precisely defined in the Staircase and Ramp Specification dialogs. See *Staircase Specification Dialog on page 538*, *Ramp Specification Dialog on page 550*, and *Stair Landing Specification Dialog on page 553*.

Stair, ramp, and landing railings can also be customized. See *Railing Panel on page 544*, and *Newels/Balusters Panel on page 547*.

USING THE EDIT TOOLS

A selected staircase or ramp can be edited in a variety of ways using the buttons on the Edit Toolbar. See *The Edit Toolbar on page 91*.



Starter Tread allows you to create one or two rounded starter treads at the base of a selected staircase. See [Starter Treads on page 527](#).



Flare/Curve Stairs allow you to flare or curve the sides of the selected staircase's base. See [Flared Stairs and Curved Treads on page 524](#).



Auto Stairwell creates a Stairwell room on the floor above the selected staircase. See [Creating a Stairwell on page 535](#).

ADJUSTING THE RADIUS OF CURVED STAIRS

The easiest way to match the radius of a stair section to the radius of a curved wall is to draw a staircase near one side of the curved wall using the **Draw Stairs**  tool. The stairs snap to the wall, and the radius of the new staircase is defined. See [Curved Stairs and Ramps on page 514](#).

Existing curved stairs can be aligned with an existing curved wall by aligning their centers, much the same way that curved stairs on different floors can be aligned. See [Aligning Objects on page 168](#).

If there is no curved wall, the radius of a stair section can be aligned to a CAD arc or circle.

To align curved stairs to an object

1. Align the centers of the CAD object and the staircase.
2. Select the curved stairs and move the side nearest to the arc or circle edge using the **Resize** edit handle.

Finally, restore the stair width by dragging from the other side handle or using the Stair Specification dialog.

Stair and Ramp Sections and Subsections

In Home Designer, staircases and ramps can be composed of multiple sections. In addition, each section can be broken into multiple subsections.

- Both sections and subsections can be curved while their neighbors are straight and can have different tread depths.
- Stair sections can also have different tread widths, can be disconnected from adjacent sections using the edit handles, and are usually separated from other sections by landings.
- Subsections both move and rotate as a single object, while sections move with other sections but rotate separately.

You can identify sections and subsections by clicking on a stair or ramp to select it: sections are identified with labels using whole numbers (1, 2, etc), while subsections are identified using hyphens (1-1, 1-2, etc). In addition, when a stair or ramp is selected, only the selected section will have edit handles.

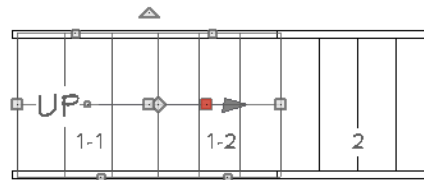

The selected section or subsection can be identified by the Move edit handle, which is red by default. See [Selected Edge on page 142](#).



CREATING STAIR AND RAMP SUBSECTIONS

There are several ways to create a stair section with multiple subsections:

- Draw one section, then draw a second section that begins at the first one's endpoint.
- Draw two separate segments, then snap the start point of one segment to the endpoint of the other using the edit handles.
- Draw one segment and use the **Add Break**  edit tool to divide it into two subsections. See [Add Break on page 172](#).

CREATING STAIR AND RAMP SECTIONS

There are also three ways to create multiple stair sections:

- Draw two separate stair sections and join them using a landing.
- Use the **Complete Break**  edit tool to divide a section into two sections. See [To create a complete break on page 173](#).
- Use the **Disconnected Selected Section**  edit tool to change a subsection into a section.

MERGING STAIR AND RAMP SECTIONS

Any combination of straight and curved stair sections or straight and curved ramps using **Automatic Heights** can be merged. The resulting staircase or ramp section is made up of subsections and, if there are no landings, functions as a single unit.

Stair and ramp subsections must be drawn in the same direction if they are to be merged:

- The top edge of a stair section or ramp cannot merge with the bottom edge of another section or ramp.
- Combinations of stairs drawn in the **UP** and **DOWN** directions cannot be merged.

Stair subsections merge at the center points of their upper and lower edges.

Stair sections and ramps cannot be merged directly. If a combination of stairs and a ramp is required, connect them with a landing. See [Landings on page 521](#).

To merge stair or ramp sections

1. Confirm that the stairs or ramps that you wish to merge are using **Automatic Heights**. See [General Panel on page 538](#).
2. Position the sections so they are in the desired relationship to each other.
 - In order to merge stair sections correctly, they must be parallel to one another.
 - To create merged subsections that change direction, make one of the merged sections curved and then specify Winders. See [Winders on page 529](#).
3. Select either stair or ramp section so that its edit handles display.
4. Click the Extend handle on the end to be merged and drag it to the point where the two stairs or ramps are to meet.

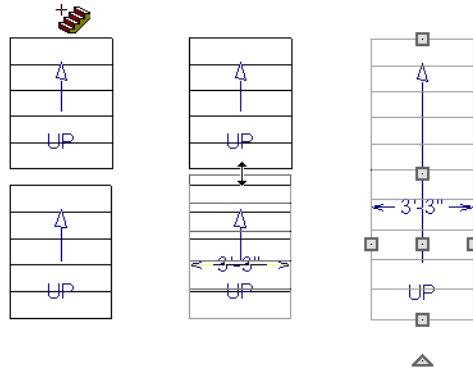

A staircase consisting of merged subsections resembles a single stair section in plan view. The **UP** (or **DN**) arrows join, becoming a single direction arrow.

When a subsection is selected, the entire staircase is selected. Additional edit handles, indicating the presence of multiple subsections and allowing you to reposition the line along which they join. See [Using the Edit Handles on page 517](#).

LOCK TREAD DEPTH

If a staircase with **Lock Tread Depth** selected in the Staircase Specification dialog is resized, its length increases or decreases one full tread at a time. See [General Panel on page 538](#).

When **Lock Tread Depth** is checked, it can be difficult to merge the section with another section or landing. If this is a problem, you can temporarily uncheck **Lock Tread Depth**. After the stairs are merged, the tread depth can be locked again.

CURVED SUBSECTIONS

Stair subsections attached at both ends by other sections do not have a free end that can be dragged into a curve. In this situation, change the middle sub-section to a curve using the **Change Line/Arc**  edit button. See [Change Line/Arc on page 174](#).

To curve an enclosed stair subsection

1. Draw three straight stair sections and connect them end to end.
2. Select the middle subsection.

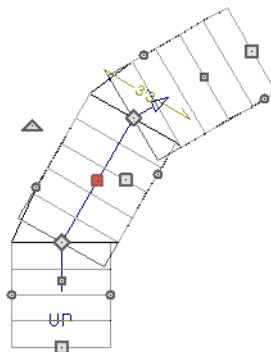

3. Click the **Change Line/Arc**  edit button. The center section turns into a curved stair section.

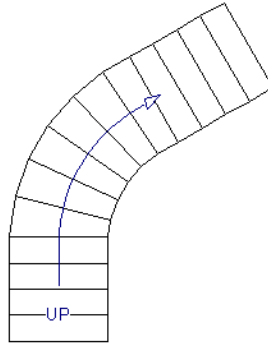





4. Use the triangular Change Curve edit handle to adjust the curvature of the middle section as needed.

Stairs joined in this manner can be turned into winders, which are steps located where a staircase turns and are narrower on the inside of the turn than they are on the outside. See [Winders on page 529](#).

Landings

Stair landings are platforms between stair sections and/or ramps, and can be created in either of five ways:

- Click and drag using the **Landing**  tool.
- Single-click using the **Landing**  tool to create a 3'-3" (975 mm) square landing.
- Click between two stair sections using the **Draw Stairs**  tool.
- Convert a closed CAD polyline into a landing. See [Convert Polyline on page 179](#).
- One or more landings are also created when the **L-Shaped Stairs**  or **U-Shaped Stairs**  tool is used.

To create a landing between stair sections

1. Draw two stair sections going UP. They can be at any angle.
2. Click between the two sections using the **Draw Stairs**  tool to create a landing. Notice that only one direction arrow displays after the sections are joined by a landing.

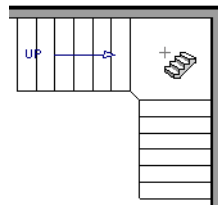

Similarly, a landing can be created between two ramps by clicking between them with the **Ramp**  tool active.

Multiple stair sections and/or ramps can be connected to one landing. For example, two or three stair sections might meet at a landing with a single stair section continuing to the next level.

To be linked by a landing, all sections must be drawn in the same UP direction and the top of one section should be near the bottom of the next.

Stair sections connected with a landing will move together as a single unit unless **Stair Sections Move Independently** is checked in the Preferences dialog. See [Architectural Panel on page 73](#).

A landing formed between two stair sections having less than a 90° angle between them are created with a short edge not less than 6" (150 mm). This is because most building codes require the shortest tread to be at least 6" wide. This edge can be manually edited to less than 6" if needed.

ADJACENT LANDINGS

Some staircases have more than one landing adjacent to one another. When **Auto Adjust Height** is used, landings in Home Designer recognize other nearby landings and will automatically adjust their heights and railings when their edges are sufficiently close to one another.

To create adjacent landings, draw two landings and then position them so that their edges are within 1" (25 mm) of one another. The landing that was drawn first will maintain its position while the height of the one drawn later will be the equivalent of one riser higher than the first. The railings on adjacent edges are suppressed, as well.

Adjacent landings can be used to represent winders. See *Winders on page 529*.

EDITING LANDINGS

Once created, landings can be selected in 2D and 3D views and edited like other closed-polyline based objects. See *Editing Closed Polyline-Based Objects on page 155*.

Landings derive their initial materials, height, thickness, and railings from the stairs and/or ramps attached to them. You can assign a unique railing or material to a landing in the Stair Landing Specification dialog. See *Stair Landing Specification Dialog on page 553*.

When moving a landing, all stair or ramp sections connected to it move as one unless **Stair Sections Move Independently** is checked in the Preferences dialog. To temporarily enable this behavior, hold down the Alt key on the keyboard. See *Architectural Panel on page 73* and *Alternate on page 138*.

LANDING HEIGHT AND THICKNESS

A landing's height and thickness can either be dynamically controlled by the program or user-defined and static.

By default, landing top height and thickness are both set to **Auto Adjust**. This means that if the structure of the attached stairs is edited so that their length or riser height is affected, the landing's height and thickness will adjust automatically to maintain consistent riser height in all connected stair sections.

If you uncheck either **Auto Adjust** box in the Stair Landing Specification dialog, the landing will maintain the specified height and/or thickness no matter how the attached stairs or ramps are modified. This can result in stairs that have inconsistent risers. See *General Panel on page 553*.

LANDING RAILINGS

By default, landings have railings on all edges, but will automatically suppress the railing along any portion of an edge that connects to a stair or ramp section or has an adjacent landing. You can specify whether this automatic behavior is used, the railing is suppressed, or the railing is always applied in the Stair Landing Specification dialog. See *General Panel on page 553*.

You can also suppress the railing on a selected edge by clicking the **Remove Railing from Selected Edge**  edit button.

To always generate the railing on a selected edge, click the **Add Railing to Selected Edge**  edit button. See *Selected Edge on page 142*.

Landings can be edited into a wide variety of shapes. So that the railings of stair sections connect properly to the landing railings, you may find it helpful to use the **Add Break**  edit tool to create a break in a landing edge if it is longer than the connecting stairs are wide. See [Add Break on page 172](#).

Maintaining Tread Depth

Most building codes require staircases to maintain a consistent tread depth.

WALK LINE

By default, Home Designer measures a stair section's length and tread depth along a Walk Line located 12" (30 cm) from the right edge of the stair section. On curved stairs, it is located 12" (30 cm) from the inside edge of the curve.

The distance of the Walk Line from the staircase edge can be specified in the Staircase Specification dialog. See [Style Panel on page 541](#).

Alternatively, you can turn the Walk Line feature off and tread depth will be measured at the tread center.

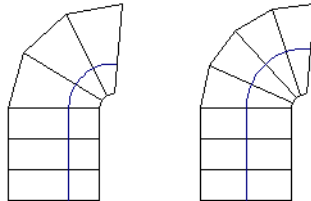

When a curved stair section has **Automatic Treads** specified in the Staircase Specification dialog and the Walk Line is used, the number and/or width of treads in a section or subsection changes when the inner edge is moved. For this reason, it is best to finalize stair section width as early as possible.

There are two ways to keep tread depth even throughout a stair section made of multiple subsections.

LOCK TREAD DEPTH

The first way to maintain tread depth is to **Lock Tread Depth** to a specified value in the Staircase Specification dialog. See [General Panel on page 538](#).

Once locked, any changes to the length of the stair section are achieved by keeping the specified tread depth and changing the number of treads.

IGNORE SUBSECTION BOUNDARIES

Curved stair sections typically have treads that are wider on one side than on the other. When they are connected to other stair sections, as with winders, it is possible to have treads that are too narrow at the Walk Line. See [Winders on page 529](#).

Uniform tread depth in a stair section with subsections can be maintained by checking **Ignore Subsection Boundaries** in the Staircase Specification dialog. See [General Panel on page 538](#).

When **Ignore Subsection Boundaries** is checked, the Tread Depth value may change when the stair section is edited, but will remain consistent throughout all subsections.

Because the boundaries between stair sections are being ignored, the treads where a straight section joins a curved section may shift position or change angle to accommodate the adjustment.

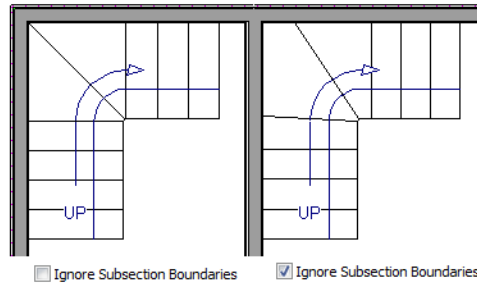

Flared Stairs and Curved Treads



Any stair section can be flared and/or its treads curved using the **Flare/Curve Stairs** edit button.

Only exposed sides of a stair section can be flared. If one side of a stair section is against a wall or wrapped (see *Wrapped Stairs on page 530*), only the exposed end can be flared.



Flaring, curved treads, and special treads should be the last changes that you make to any stairs.

CREATING A FLARED STAIR

Flared stairs grow wider near one end, typically sweeping outward at the bottom. Stairs can also be flared at the top or on both ends.



To create flared stairs

1. Create the stairs and connect them to a landing, floor platform edge, or another stair section.
2. Specify the section width, tread depth, and any other needed information.
3. Select the stairs and click the **Flare/Curve Stairs**  edit button. New **Flare** edit handles display on all four corners of the stairs.

4. Drag one of the corner handles to flare that corner. As you drag the flare, the Status Bar shows the distance the side handle moves. This allows you to move the opposite handle the same amount.

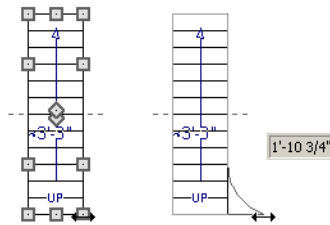

5. When you are finished editing the flare, click the **Main Edit Mode**  to restore the stairs' regular edit handles and toolbar buttons.

SYMMETRICALLY FLARED STAIRS

Use the dimension information that displays in the Status Bar as a reference to create symmetric flares on both sides.

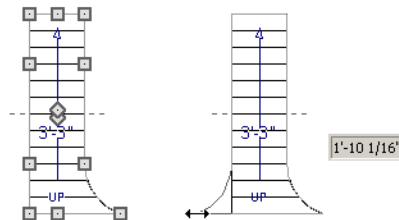

ADJUSTING THE FLARE RADIUS

After a flared staircase has been created, you may want to soften the radius of the flare.

The four handles at the sides and the four handles at the corners flare the stair section when dragged outward. The two handles in the center of the section move the starting point for flaring along the stair section.

To adjust the flare radius

First, adjust the curvature of the flared section.

1. Select the flared stair and click the **Flare/Curve Stairs**  edit button to access the flare handles again.
2. Select the handle along the flared edge of the stair. Drag this handle outward very slightly. This forms a more gradual flare.

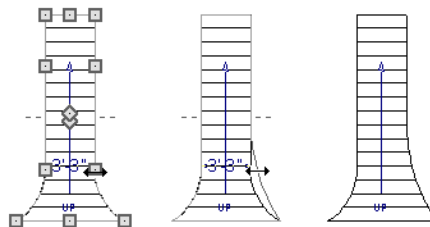

Then, adjust the starting point of the flare:

1. Select the flared stair and click the **Flare/Curve Stairs**  edit button to access the flare handles again.
2. This time, drag the lower of the two central handles upward. The handle above it moves with it. This moves the start point for the bottom flare from the middle of the section toward its top, making the flare even more gradual.

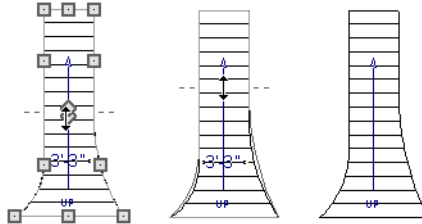

TREADS PERPENDICULAR TO FLARE

Flared stairs often look best when the treads curve to meet the flared side perpendicular to the radius.

To curve the edges of flared treads

1. Select the flared stair and click the **Flare/Curve Stairs**  edit button to access the flare handles again.
2. Drag a corner edit handle upward one tread depth or less.

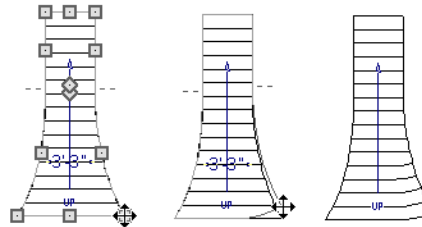

3. When you are finished editing the curve, click the **Main Edit Mode**  to restore the stairs' regular edit handles and toolbar buttons.

This type of tread curving works only on flared edges and concentrates the curvature at that edge.

Flared treads can also be curved using the Curve edit handle, which curves the treads more uniformly.

CURVING THE TREADS

When treads are curved, all treads in the section show some degree of curvature. Treads close to the curved end have a greater curve than those at the opposite end, but both ends can be curved.



To curve stair treads

1. Select the staircase, then click the **Flare/Curve Stairs**  edit button.
2. Drag the edit handle at the center of the bottom edge a small distance to curve the treads.

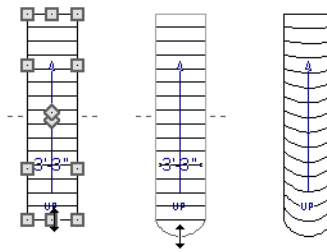

3. When you are finished editing the curve, click the **Main Edit Mode**  to restore the stairs' regular edit handles and toolbar buttons.

Starter Treads



The first and second treads of a staircase can be turned into starter treads by clicking the **Starter Tread** edit button. Starter treads extend to the side of the staircase, have rounded edges and are common on traditional staircases.

A starter tread can be added only to open sides of a stair section. If one side of a stair section is against a wall or wrapped (see [Wrapped Stairs on page 530](#)), only the exposed tread end can become a starter tread.



To create starter treads

1. Click on a staircase to select it.
2. Click the **Starter Tread**  edit button. An edit handle displays on each end of both the first and second treads.

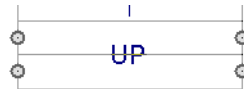

3. Drag either of the handles on the first tread outward from the stair section. If the stair section is against a wall, only one handle displays on the side opposite the wall.
4. As you drag, the ends of the tread become rounded.

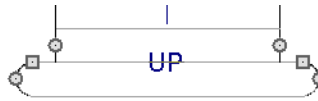

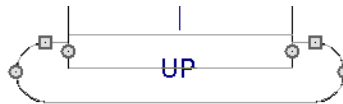

5. Two additional edit handles display on each side of the tread, along the back edge.
6. Drag either of the two square handles upward to increase the width of the rounded ends of the tread.

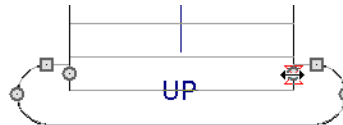

7. Drag the edit handle on the second tread outward from the stair section to create a second starter tread.



8. To make changes to existing starter treads, select the stairs, click the **Starter Tread**  edit button and repeat the above steps as needed.

- When you are finished editing the starter treads, click the **Main Edit Mode**  to restore the stairs' regular edit handles and toolbar buttons.

Winders

Winders are steps located where a staircase turns and are narrower on the inside of the turn than they are on the outside. A staircase defined as a winder expands to fill in any gaps between the side of the stairs and nearby walls.

Curved stair sections are typically used to create winders, although straight stairs can also be used. See [Curved Stairs and Ramps on page 514](#).

To create winders

- In an enclosed room area, place and connect the stair sections that you want to be winders. For best results:
 - The stairs should be two straight sections connected by a curved section between them;
 - The curved section should be adjacent to a 90° corner, as illustrated.



It is often easiest to create the staircase configuration in an open space, away from walls, then move it into position in a wall corner before specifying it as Winders.

- Select the staircase and click the **Open Object**  edit button to open the Staircase Specification dialog.
- On the GENERAL panel, place a check in the **Winders** check box and click **OK**.
 - The stairs should be two straight sections connected by a curved section between them;
 - The curved section should be adjacent to a 90° corner, as illustrated.



It is often easiest to create the staircase configuration in an open space, away from walls, then move it into position in a wall corner before specifying it as Winders.

- Select the staircase and click the **Open Object**  edit button to open the Staircase Specification dialog.
- On the GENERAL panel, place a check in the **Winders** check box and click **OK**.

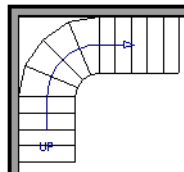

- The steps nearest the wall corner adjust their shapes and extend into the corner after the stair is changed to a winder.



Winders must be in a room with valid room definition. You cannot create winders in an area composed of only 2 corner walls. If this configuration is needed, enclose the area in with Invisible walls so that a room area is defined.

The Winders attribute directs the stair section to expand or contract to meet nearby walls, and can also be used to create a partial railing. See [Partial Railings on page 533](#).

Winders sometimes have treads that are too narrow at the inside curve. The **Ignore Subsection Boundaries** option can address this issue. See [Ignore Subsection Boundaries on page 523](#).

In situations where the conditions for stair winders cannot be met, you can use adjacent landings. See [Landings on page 521](#).

Wrapped Stairs

Check **Allow Wrap** on the **STYLE** panel of the Staircase Specification dialog and the selected stairs can be wrapped around the corner of a deck or landing. Curved stairs and stairs with multiple subsections cannot be wrapped. See [Style Panel on page 541](#).

Stair sections that wrap around a corner to meet one another must have identical attributes. As a result, edits made to one wrapped stair section apply to all adjacent, wrapped sections.

To wrap stairs around a deck

1. Begin by drawing a deck. See [Decks on page 292](#).
2. Use the **Straight Stairs**  tool to place a stair section on each side of the corner around which you want them to wrap.
3. Move the stair sections toward the corner of the deck. When the two sections are sufficiently close to the corner, they will merge to form wrapped steps.



 You can also draw stairs down from a deck by right-clicking to draw them or by pressing the Alt key while you drag. See [To draw stairs going downward on page 515](#).

To wrap stairs around a landing

1. Use the **Draw Stairs**  tool to create two perpendicular stair sections with top ends that share a corner.
2. Click between them to create a landing.
3. Rotate one stair section 180°.

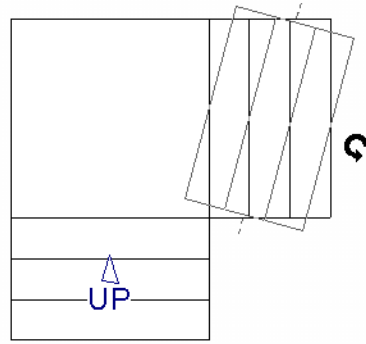

- 4. The stairs wrap around the corner. Notice that the Up arrow displays on the most recently edited stair section.

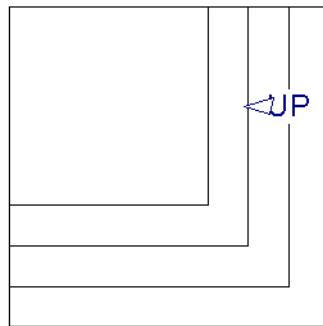

Other Special Railings and Stairs

Stairs can be customized to meet a variety of needs.

SOLID RAILINGS

-  To create a solid rail along a staircase, position a solid Railing against, but not underneath, the stairs. Specify it as **Solid** and that it **Follow Stairs**. See *Rail Style Panel on page 274*.

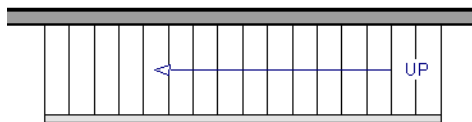

The solid railing recognizes the adjacent stairs and climbs alongside them.







If any balusters extend beyond the railing, eliminate them by unchecking **Left Railing** or **Right Railing** in the Staircase Specification dialog. See *Style Panel on page 541*.

FULLY HOUSED STRINGERS WITH BALUSTERS

Fully housed stringers with balusters can also be created by positioning a pony wall next to the stairs.



To create fully housed stringers

1. Create a staircase, then select the stairs and click the **Open Object**  edit button.
2. On the STYLE panel of the Staircase Specification dialog, uncheck **Stringer at Wall** and click OK.
3. Draw an **Interior Wall**  or **Half Wall**  against, but not underneath, the stairs.
4. Select the wall and click the **Open Object**  edit button.
5. On the GENERAL panel of the Wall or Railing Specification dialog, make sure **Railing** is checked.
6. On the WALL TYPES panel:
 - Check **Pony Wall**.
 - Specify the **Lower Wall Type** as the same interior wall as the upper wall.
 - Specify the **Elevation of Lower Wall Top**. This value should equal the stairs' riser height plus the height above the treads.
7. On the RAIL STYLE panel:
 - Check **Follow Stairs**.

- Specify desired **Railing Height**.
- Click OK.

Note: To create housed stringers, check Trim Against Wall in the Staircase Specification dialog. See *Stringers Panel on page 542*.





PARTIAL RAILINGS

A staircase can be enclosed on one side by a combination of wall and railing.



Partial railings can be created by creating a staircase composed of two sections, each with a different tread width. See *Stair and Ramp Sections and Subsections on page 518*.

To create a partial stair railing

1. Create a staircase and draw an **Interior Wall**  against, but not underneath, the stairs.
2. In plan view, select the stairs and click the **Add Break**  edit button. See *Add Break on page 172*.
3. Next, click the **Complete Break**  edit button.
4. With **Object Snaps**  enabled, click once on the stairs where they meet the end of the interior wall to add a complete break to the stairs at that location. The staircase is broken into two separate sections. See *Object Snaps on page 113*.
5. Select the stair section that is not adjacent to the interior wall and, using either its edit handles or its specification dialog, increase its tread width.

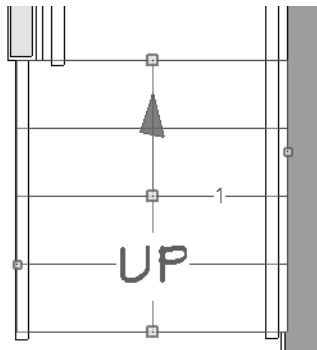

6. You may need to **Zoom**  in on the stairs and wall to move the stair edge.



RAILING PANELS

You can specify panels, including glass panels or cables, as a stair or ramp's railing in the Staircase and Ramp Specification dialogs. See [Railing Panel on page 544](#).

INSET OR MIDDLE RAILING

You can use a **Railing**  to create inset stair railings or a middle railing.

To use railing panels with stairs

1. Create a staircase and draw a **Railing**  under the stairs.
 - Make sure that the railing is located entirely within a single stair section.
 - Position it so that it is aligned with the left edge.
2. Select the railing and click the **Open Object**  edit button. See [Wall Specification Dialog on page 262](#).
3. On the RAIL STYLE panel of the Railing Specification dialog:
 - Select the **Panels** radio button.
 - Check **Follow Stairs**.
4. On the NEWELS/BALUSTERS panel, click the **Browse** button to the right of **Panel Type** and select the railing panel you want to use on the stairs, then click OK.
5. Select the staircase and click the **Open Object**  edit button.
6. On the NEWELS/BALUSTERS panel of the Railing Specification dialog, uncheck **Left Railing** to prevent the default stair railing from generating in addition to the railing panel.
7. Repeat these steps if you want railing panels under the right side of the stairs, as well.

CONCRETE STAIRS



To make a solid concrete staircase

1. Select the stairs and click the **Open Object**  edit button.
2. On the STYLE panel of the Staircase Specification dialog:
 - Set the **Tread Overhang** to zero.
 - Set the **Tread Thickness** to zero.

- Uncheck **Open Risers**.
 - Uncheck **Open Underneath**.
3. On the **STRINGERS** panel, you can also check **Large Stringer Base**.
 4. On the **MATERIALS** panel, specify the “Riser/Trim”, “Support Wall”, and “Tread” materials as concrete.

MASONRY STAIRS



To make a set of masonry stairs

1. On the **STYLE** panel of the Staircase Specification dialog:
 - Set the **Tread Overhang** to zero.
 - Set the **Tread Thickness** to the thickness of the masonry material.
2. On the **MATERIALS** panel, assign the desired masonry material to the “Tread” component and specify the “Riser/Trim” material as concrete.

STEEL STRINGER

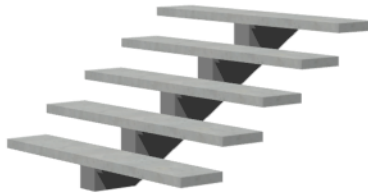

To make a steel stringer with concrete treads

1. On the **STYLE** panel of the Staircase Specification dialog:
 - Check **Open Underneath**.
 - Set the **Tread Thickness** to 2 inches or more.
2. On the **STRINGERS** panel, select **1 Center Stringer**.
3. On the **MATERIALS** panel, specify the “Tread” material as concrete and the “Riser/Trim” material as steel.

Creating a Stairwell

An interior staircase must be located in a stairwell, an opening to the floor above. A stairwell is an Open Below room type on the floor above. See [Room Types on page 282](#).

If you create a stairwell away from other walls so the Open Below is created in the center of another room, connect a wall of the Open Below room to another wall using an invisible wall.

CREATING A STAIRWELL AUTOMATICALLY



 To create a stairwell that matches the perimeter of a selected staircase, click the **Auto Stairwell** edit button. This button is only available when a living space exists above the staircase. It will not be available if the space above is Open Below or on the Attic Floor.

Auto Stairwell automatically creates a room on the floor above enclosed by railings, defined as **Open Below** in the Room Specification dialog, and given a **Stairwell** room label. This room can be selected and edited like any other room.





CREATING A STAIRWELL MANUALLY

Stairwells can also be created manually.

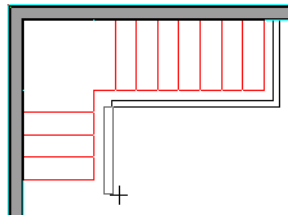
To create a manual stairwell

1. Draw a two-story building. Create the staircase on the first floor.
2. Make the second floor the **Current Floor** and the first floor the **Reference Floor**. See *The Reference Display*.
3. Select **Tools> Floor/Reference Display> Reference Display**  to show the Reference Floor, including the stairs.
4. On the upper floor, use the **Railing**  tool to create a room around the stairs. Use the edit handles to position the railings as needed.



5. Select the railings one at a time and move them into position.
 - When a railing is selected, its bounding box shows the location of the outer surface of the railing's drywall layer. For best results, this outer surface (which does not display when the railing is not selected) should meet the top edge of the stairs. See *Wall Types and Railings on page 229*.
 - If you prefer, you can also go **Down One Floor**  and adjust the top edge of the staircase to snap it to the surface of the railing on the floor above.
6. When the railings are positioned properly, select **Tools> Floor/Reference Display> Reference Display**  to turn off the display of the Reference Floor.
7. Click inside the room using the **Select Objects**  tool to select it, then click the **Open Object**  edit button.
8. On the GENERAL panel of the Room Specification dialog, select "Open Below" from the **Room Type** list. Click **OK** to close the dialog.

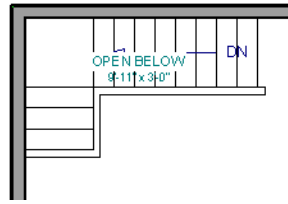

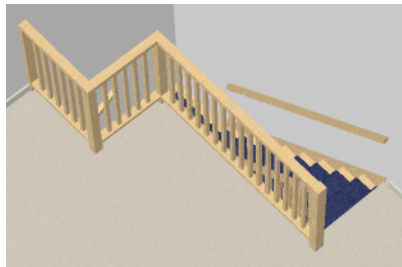

9. Place a **Doorway**  in the railing at the top step for an opening.
10. Select the doorway and define a large width in the Door Specification dialog. If the doorway is specified wider than the railing, its width adjusts to fit the available space.



Rooms Below Staircases

Rooms such as closets or storage areas are commonly located beneath staircases.

To create a room below a staircase

1. Draw a staircase, select it, and click the **Open Object**  edit button to open the Staircase Specification dialog. See [Staircase Specification Dialog on page 538](#).
 - If Winders are specified for this staircase, set **Max Tread Contraction** to 2" on the STYLE panel to allow walls to be built entirely under the staircase.
 - On the FILL STYLE panel, select "No Pattern" so the walls and other objects under the stairs can be seen.
2. On the same floor as the staircase, draw the **Interior Walls**  under them, following their shape.
3. Reposition the walls as needed, making sure that each is entirely under the stairs.
4. The wall at the foot of the stairs should be placed no closer to the bottom than the second step.
5. Add a door and specify the Room Type.

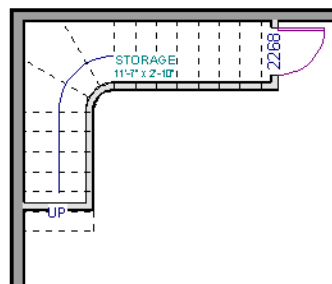

Staircase Specification Dialog

Staircases can be defined with the greatest accuracy in the Staircase Specification dialog. To open this dialog, select one or more staircases and click the Open Object edit button, or double-click a stair section using the **Draw Stairs**, **Straight Stairs**, or **Select Objects** tool.

If a staircase is composed of multiple stair sections, the section that you clicked on to select the staircase is the Selected Section; however, information about all the sections is available and can be edited in the dialog.

The Staircase Specification dialog has the following panels:

 It is recommended that all floor heights, ceiling heights and platform thicknesses be established before using the Staircase Specification dialog.

GENERAL PANEL

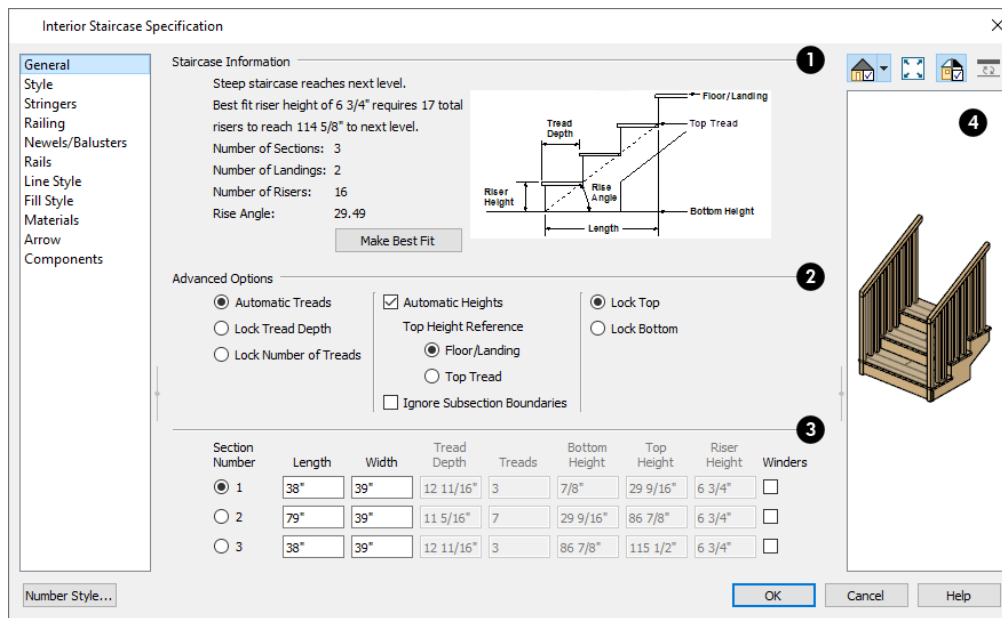

1 Staircase Information

Structural information about the selected staircase displays here for reference and updates as changes are made on the GENERAL panel.

- The first comment tells whether or not the staircase reaches the next level, which may be a floor platform or locked landing. It also indicates whether its rise angle is either steeper or more shallow than the Best Fit, described below. If **Automatic Heights** is unchecked, this comment instead says “Start and end heights are set manually”.
- The second comment, **Best fit riser height of ___ requires ___ total risers to reach ___ to next level**, describes the ideal rise and run for the selected staircase. The program defines the Best Fit Riser Height as the riser height closest to 6 3/4” (168.75 mm) that allows the selected staircase to meet the next level precisely. This comment is only active if **Automatic Heights** is checked, below.

If the staircase includes a landing with a user-specified height, that height is used to calculate this information. See [Landing Height and Thickness on page 522](#).

- The total number of stair **Sections**, **Landings**, and **Risers** associated with the selected staircase also display here.
- The **Rise Angle** of the currently active stair section also displays here.
- Click the **Make Best Fit** button to add or remove risers to the Selected Section. Only available when **Automatic Heights** is checked and the staircase does not currently use the Best Fit Riser Height.

Make Best Fit will also extend stairs drawn in a downward direction until they reach the terrain. See [Terrain Perimeter on page 847](#).

A diagram of a sample staircase's structure displays here for reference, as well.

2 Advanced Options

The **Advanced Options** apply to all sections and subsections.

- Select **Automatic Treads** to have the program define the depth and number of stair treads. If the staircase has multiple sections, each may have different tread depths.
- Select **Lock Tread Depth** to specify the Tread Depth for each stair section, below, and prevent them from changing. When Lock Tread Depth is selected and the length of the stairs is changed, the number of treads will change.
- Select **Lock Number of Treads** to specify the number of treads in each stair section and prevent it from changing. When Lock Number of Treads is selected and the length of the stairs is changed, the tread depths will change.
- If multiple staircases or a staircase with multiple sections is selected, **No Change** may be an option as well. Select this to maintain the multiple sections' individual settings.
- Uncheck **Automatic Heights** if you would like to specify the bottom and top heights of each stair section, as measured from the default floor height of Floor 1, 0" (mm). When checked, the program automatically defines the top and bottom heights by precisely locating floor platforms and landings.

The **Top Height Reference** values control what point on the staircase the Top Height value, below, describes.

- Select **Floor/Landing** for the Top Height value to describe the height of the top tread plus the stated Riser Height.
- Select **Top Riser** for the Top Height value to describe the height of the top riser.
- Check **Ignore Subsection Boundaries** to maintain tread depth throughout a stair section composed of merged subsections, regardless of whether the subsections have different tread depths assigned to them. See [Ignore Subsection Boundaries on page 523](#).
- Select **Lock Bottom** to lock the position of the selected stair section's bottom end to prevent it from moving. Sections and landings below the selected section do not move when you click OK, while those above do move.
- Select **Lock Top** to lock the position of the selected stair section's top end to prevent it from moving. Sections and landings above the selected section do not move when you click OK, while those below do move.

Lock Bottom and **Lock Top** are actions rather than settings. If you make changes to a staircase that will affect its length, first lock either the bottom or top end of the Selected Section to prevent it from moving. The height of the Selected Section's locked end is not affected by these settings - only its position on the X/Y axis.

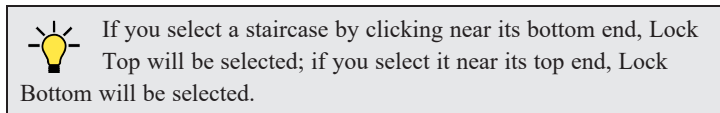

3 Specifications

The specifications for each stair section and subsection are listed and can be edited here. Up to ten items total can display.

A change in one value usually affects other values. You may need to reposition the staircase after making changes.

- The **Section Number** column identifies the Selected Section and the number of each section of the selected staircase. If **Ignore Subsection Boundaries** is unchecked, subsection numbers are also identified. The radio button to the left indicates which section or subsection is selected. See *Displaying Stairs, Ramps, and Landings on page 516*.
- Define the **Length**, or run, of each section or subsection measured along the Walk Line. The length is equal to the number of treads multiplied by the tread depth. See *Walk Line on page 523*.

When the length of a section changes, other sections and landings in the staircase unit move in response. You can specify whether the bottom or top edge of the Selected Section moves when you resize it by selecting either the Lock Bottom or Lock Top radio button, above.

- Define the **Width** of each section. Only one width can be defined for a section, so all subsections in the same section have the same width. If a section is connected to a landing, its width should equal the length of the landing edge that it connects to. See *Landings on page 521*.
- Specify the **Tread Depth**, or run, of each stair tread in the selected section. To lock this value, check **Lock Tread Depth**, above.

If a landing is created between two stair sections and one of them has locked tread depth, the resulting staircase also has locked tread depth. Any landings or sections connected to this new staircase adjust to meet it and then have locked tread depth as well.

- Define the number of **Treads** in a stair section or subsection. To lock this value, select Lock Number of Treads, above.
- Define the **Bottom Height**, the height of the stair section's bottom edge. To lock this value, click the radio button to the left of the section's number, then click the Lock Bottom radio button, above, and click OK.
- Define the **Top Height**, the height of the stair section's top edge. To lock this value, click the radio button to the left of the section's number, then click the Lock Top radio button, above, and click OK.
- Define the **Riser Height**, the height of the risers in each stair section.
- Check **Winders** to specify the Selected Section, including subsections, as winders. See *Winders on page 529*.

4 Preview

A preview of the selected staircase displays on the right side of the panel. If the staircase includes any landings, only the section that was selected when the dialog was opened will display. See *Dialog Preview Panes on page 20*.

STYLE PANEL

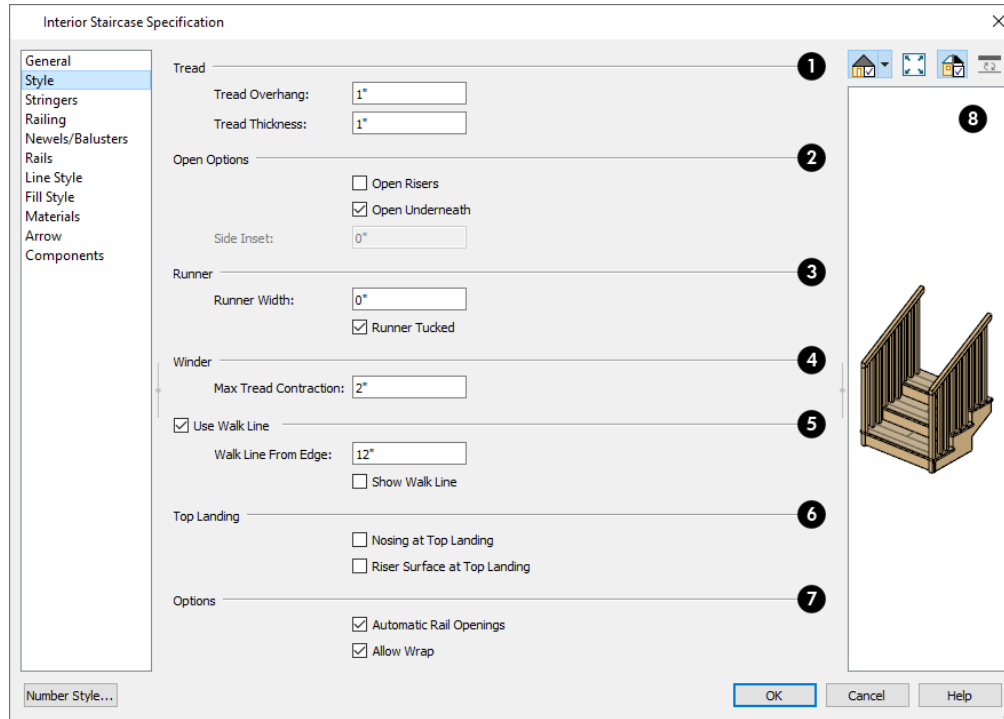

1 Tread

See [Anatomy of a Staircase on page 512](#).

- Specify the **Tread Overhang**, which is the distance that each tread overhangs the riser.
- Specify the **Tread Thickness**.

2 Open Options

The **Open Options** control whether the selected stairs have open risers or an open underside.

- Check **Open Risers** to eliminate the riser face under each tread and expose the stringers.
- Uncheck **Open Underneath** to add a skirt below the staircase along the two sides. It looks like a wall in 3D, but only has a single face. Base molding does not generate along the bottom of the skirt, and doors cannot be placed in it. In most cases, the recommended way to enclose the area beneath stairs is to use walls. See [Rooms Below Staircases on page 537](#).
- Specify the **Side Inset** of the skirt below the staircase. The default value of 0 aligns the skirt with the outside of the surface of the stringers. Only available when **Open Underneath** is unchecked.

3 Runner

Specify the attributes of the staircase's carpet **Runner**. Only available when **Open Risers** is unchecked, above.

- Specify the **Runner Width**. The default value of 0 does not create a runner.
- Uncheck **Runner Tucked** to have the runner drop straight down from the tread front to the riser below. This is checked by default.

4 Winder

Define the **Max Tread Contraction**, which is the amount a tread's width may be reduced when it meets a wall. See *Partial Railings on page 533*.

This option only takes effect when the stairs are specified as **Winders** on the GENERAL panel. See *General Panel on page 538*.

5 Use Walk Line

See *Walk Line on page 523*.

- Check **Use Walk Line** to have the program calculate the tread depth based on a Walk Line. Uncheck the box to disable this function.
- Specify the distance of the **Walk Line from Edge**. The default value is 12" (300 mm).
- Check **Show Walk Line** to show the Walk Line in plan view.

6 Top Landing

Specify the appearance of the staircase where it meets the next floor platform. These options do not affect the edges of landings.

- Check **Nosing at Top Landing** to produce tread nosing attached to platform edge at the top of stairs.
- Check **Riser Surface at Top Landing** to produce a riser surface against the platform edge at the top of the stairs. This allows stair risers to match all the way to the top of the platform.

7 Options

- Check **Automatic Railing Openings** to automatically create a doorway opening when the selected stairs are snapped to a railing drawn on the same floor as the stairs. This is checked by default.
- Check **Allow Wrap** to wrap the selected stairs around the corner of a deck or landing where another, identical stair section is present. See *Wrapped Stairs on page 530*.

8 Preview

A preview of the selected staircase displays on the right side of the panel. If the staircase includes any landings, only the section that was selected when the dialog was opened will display. See *Dialog Preview Panes on page 20*.

STRINGERS PANEL

The settings on the STRINGERS panel affect all sections of a selected staircase.

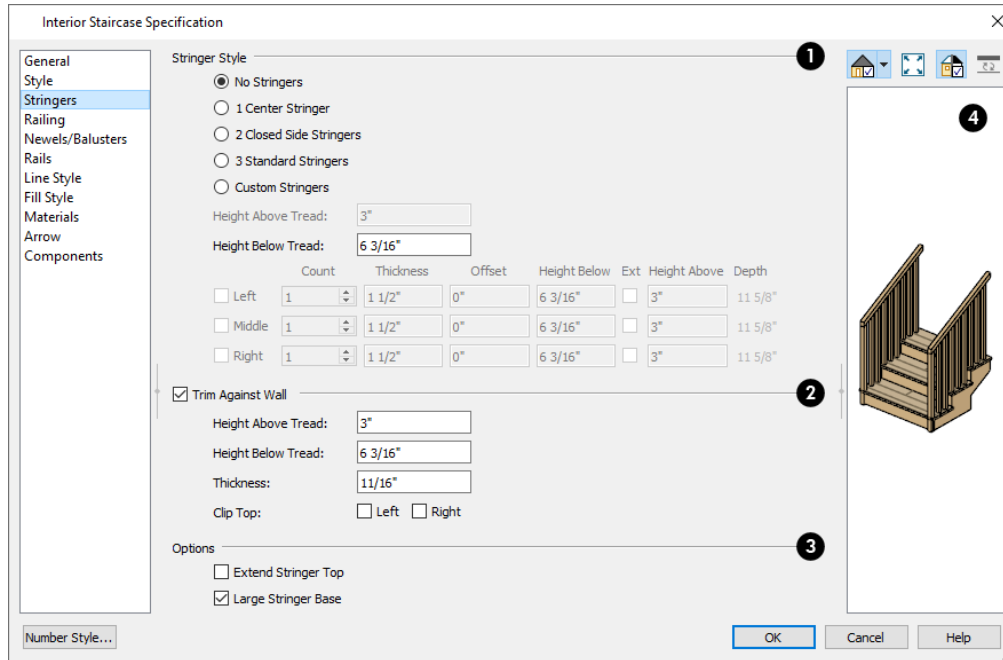

1 Stringer Style

- Click a radio button to specify the number of stringers assigned to the staircase. Select **Custom Stringers** to enable the Left, Middle, and Right settings below.
- Specify the **Height Above Tread**, measured straight down from the top outer edge of the tread nosing to the top of the stringer. Only available when 2 Closed Side Stringers is selected, above.
- Specify the **Height Below Tread**, measured straight down from the back bottom edge of the tread to the bottom of the stringer. Not available when Custom Stringers is selected, above.

The **Left**, **Middle**, and **Right** settings are enabled when Custom Stringers is selected. For each of these:

- Specify the **Count** for each stringer location. Multiple Left and Right stringers are butted side to side while multiple Middle stringers are evenly spaced between them.
- Specify the **Thickness**, measured horizontally.
- Specify the **Offset** of each stringer from its default location. A positive value offsets the stringer(s) to the right; a negative value offsets them to the left.
- Specify the **Height Below** the treads, measured straight down from the back bottom edge of the tread to the bottom of the stringer.
- Check **Ext** to specify the stringer(s) as Exterior and allow them to extend up past the top of the stair treads.
- Specify the **Height Above** the stair treads, measured straight down from the top outer edge of the tread nosing to the top of the stringer.
- The vertical **Depth** of the stringers is reported here for reference. This value is affected by the Heights above and below the treads, as well as the stairs Rise Angle.

2 Trim Against Wall

Specify the attributes of the **Trim Against Wall** that generates when the staircase is positioned against a wall.

- Specify the **Height Above Tread**, measured straight down from the top outer edge of the tread nosing to the top of the tread.
- Specify the **Height Below Tread**, measured straight down from the back bottom edge of the tread to the bottom of the trim.
- Specify the **Thickness** of the trim, measured horizontally.
- **Clip Top** - Specify whether to clip the top of the trim where it meets the upper floor level. Trim can be clipped on the **Left** and/or **Right** sides of the staircase.

3 Options

- **Extend Stringer Top** is checked by default and extends a triangular portion of the stringer under the landing or platform at the top of the stairs.
- Check **Large Stringer Base** to widen the stringers at the foot of the staircase. This is helpful when walls are created below the stairs.

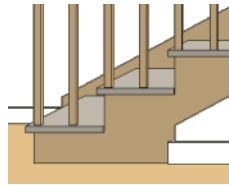

4 Preview

A preview of the selected staircase displays on the right side of the panel. To see the stringers, click in the preview and drag upward to rotate. See [Dialog Preview Panes on page 20](#).

RAILING PANEL

By default, the settings on the RAILING panel also affect the railings on any landings attached to the selected staircase or ramp. See [Landings on page 521](#).

This panel is also found in the Ramp and Landing Specification dialogs.

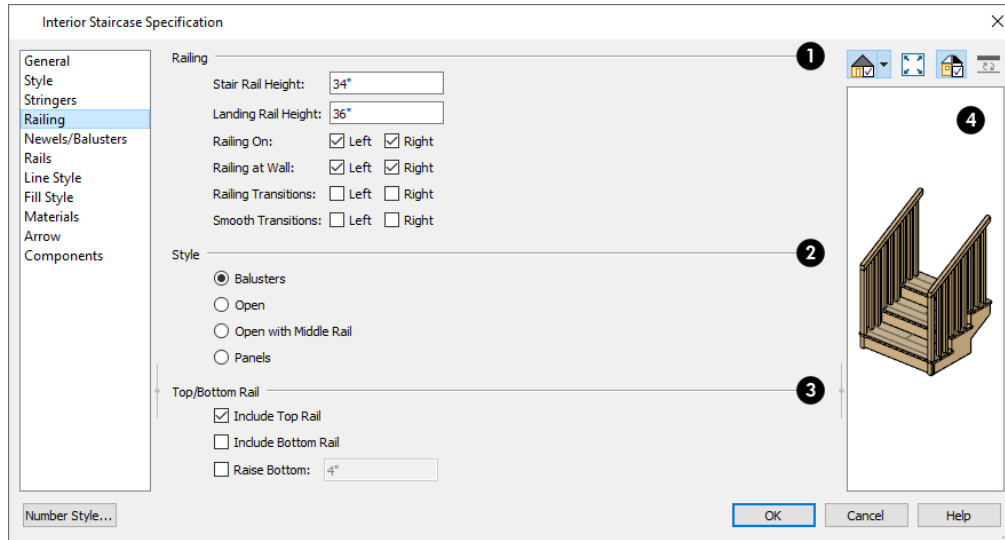

1 Railing

- **Stair Rail Height** defines the height from tread surface directly over the riser to railing top.
- **Landing Rail Height** defines the height of the landing rail top from the landing surface.
- **Railing On** - Select **Left** and/or **Right** to specify placement of railings on stair sections.
- **Railing at Wall** - Select **Left** and/or **Right** to specify the placement of wall railings. Not available for ramps.

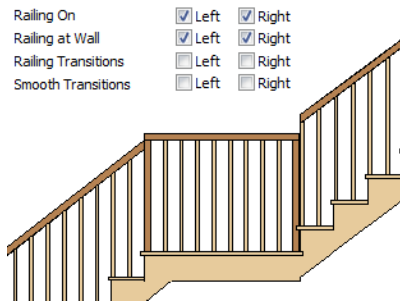

- Check **Railing Transitions** on **Left** and/or **Right** to create “gooseneck” connections between stair and landing railings. This option only has an effect when **Rail Passes Over Newel** is checked. Not available for ramps.

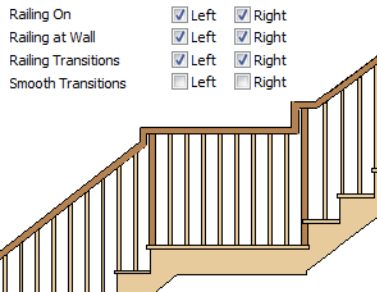

- Check **Smooth Transitions** on **Left** and/or **Right** to specify the placement of smooth connections between stair and landing railings. Not available for ramps.

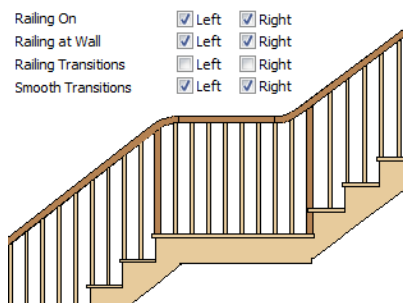

- Check both **Railing Transitions** and **Smooth Transitions** to produce a handrail like this:

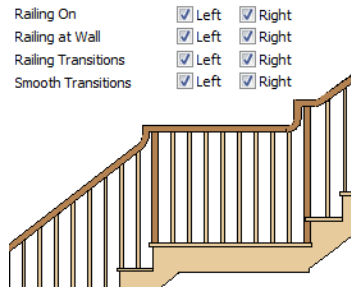

2 Style

- Select **Balusters** to create regularly spaced balusters between larger newel posts.
- Select **Open** to create with only newels posts.
- Select **Open with Middle Rail** to create railings with newel posts and a middle rail.
- Select **Panels** to create railings composed of panels. The panel style is specified on the NEWELS/BALUSTERS panel. See [Newels/Balusters Panel on page 547](#).

3 Top/Bottom Rail

- Check **Include Top Rail** to produce a top rail on the stair railings that receives the top baluster ends and typically acts as a handrail.
- Check **Include Bottom Rail** to place a low rail on the landing surface that receives the balusters ends.

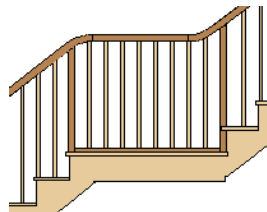

- Check **Raise Bottom**, then specify the distance to raise the bottom rail or panel from the stair tread.

4 Preview

A preview of the selected staircase displays on the right side of the panel. If the staircase includes any landings, only the section that was selected when the dialog was opened will display. See [Dialog Preview Panes on page 20](#).

NEWELS/BALUSTERS PANEL

The settings on the NEWELS/BALUSTERS panel will also affect the appearance of railings on any landings attached to the selected staircase. See [Landings on page 521](#).

These settings are similar to those found on the same panel of the Ramp and Landing Specification dialogs. See [Ramp Specification Dialog on page 550](#).

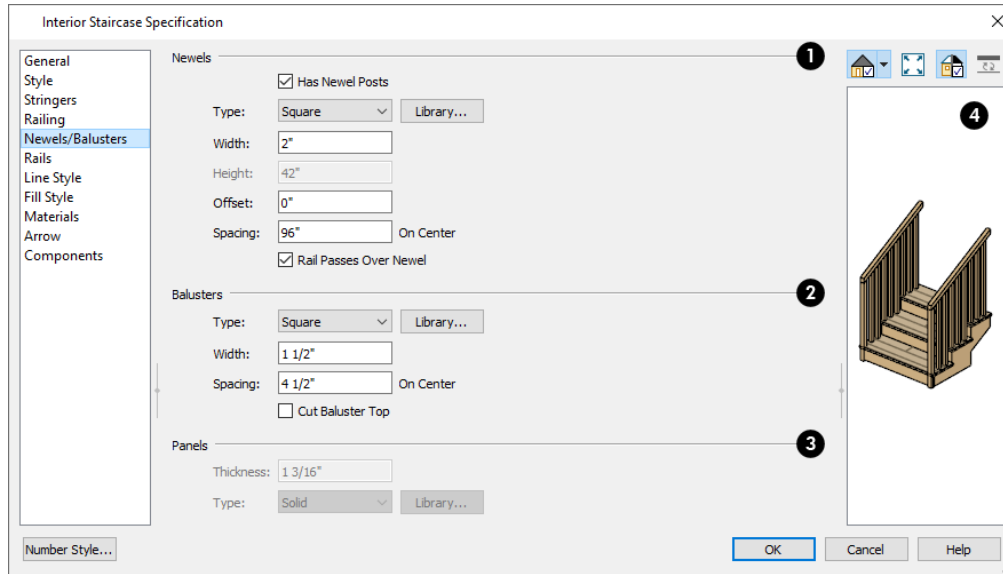

1 Newels

- Uncheck **Has Newel Posts** to prevent newels from generating in the selected staircase's railings. When this box is checked, newels are generated and can be edited using the settings that follow.
- **Type** - Select **Square**, **Round**, or newels from the **Library**. Selecting **Library** from the drop-down list is the same as clicking the **Library** button to the right and allows selection of a newel from the library.
- Specify the **Width**, which is the width or diameter of each newel. For Library newels, this is the width at its widest point.
- Specify the **Height**, which is the height from the landing surface to the top of the newel. Only available when **Rail Passes Over Newel** is unchecked below.
- Specify the **Offset**, which is the amount each newel is offset from the center of the railing.
- Specify the on-center **Spacing** of the newel posts.

2 Balusters

The first three **Balusters** settings are similar to the Newels options of the same names, above.

- **Cut Baluster Top** - Each tread normally has two to three balusters, growing longer toward its back. The default is to use the same baluster and cut it off at the bottom to shorten it toward the tread front. Check this box to cut the balusters at the top instead.

3 Panels

These settings are only available when the railing Style specified as “Panels” on the *Railing Panel on page 544*.

- Specify the panel’s **Thickness**.
- Select “Solid” or “Library” from the **Type** drop-down list.



You can also apply newels, balusters, and panels onto stair or ramp railing directly from the Library Browser. See *Inserted Objects on page 687*.

4 Preview

A preview of the selected staircase displays on the right side of the panel. If the staircase includes any landings, only the section that was selected when the dialog was opened will display. See *Dialog Preview Panes on page 20*.

RAILS PANEL

The settings on the RAILS panel are similar to those on the RAILS panel of the Wall Specification dialog as well as the MOLDINGS panel of a variety of other dialogs. See *Moldings Panel on page 665*.

By default, the settings on the RAILS panel will also affect the appearance of railings on any landings attached to the selected staircase. See *Landings on page 521*.

LINE STYLE PANEL

The settings on the LINE STYLE panel are available for a variety of other objects in the program. For information about these settings, see *Line Style Panel on page 204*.

FILL STYLE PANEL

The settings on the FILL STYLE panel affect the appearance of the selected staircase in plan view. For information about these settings, see *Fill Style Specification Dialog on page 131*.

MATERIALS PANEL

The settings on the MATERIALS panel affect the appearance of the selected staircase in 3D views and are available for a variety of objects throughout the program. For information about these settings, see *Materials Panel on page 716*.

The settings on this panel will also affect the materials applied to any landings attached to the selected staircase. See *Landings on page 521*.

ARROW PANEL



The settings on the ARROW panel control the appearance of the selected staircase’s direction arrow in plan view. See *In Plan View on page 516*.

For information about these settings, see *Arrow Panel on page 205*.

COMPONENTS PANEL

The information on the COMPONENTS panel can be used in the materials list. See *Components Panel on page 921*.

Ramp Specification Dialog

Ramps can be defined with the greatest accuracy using the Ramp Specification dialog. To open this dialog, select one or more ramps and click the **Open Object** edit button or double-click a ramp section using the **Ramp**  or **Select Objects**  tool.

The Ramp Specification dialog has the following panels:

GENERAL PANEL

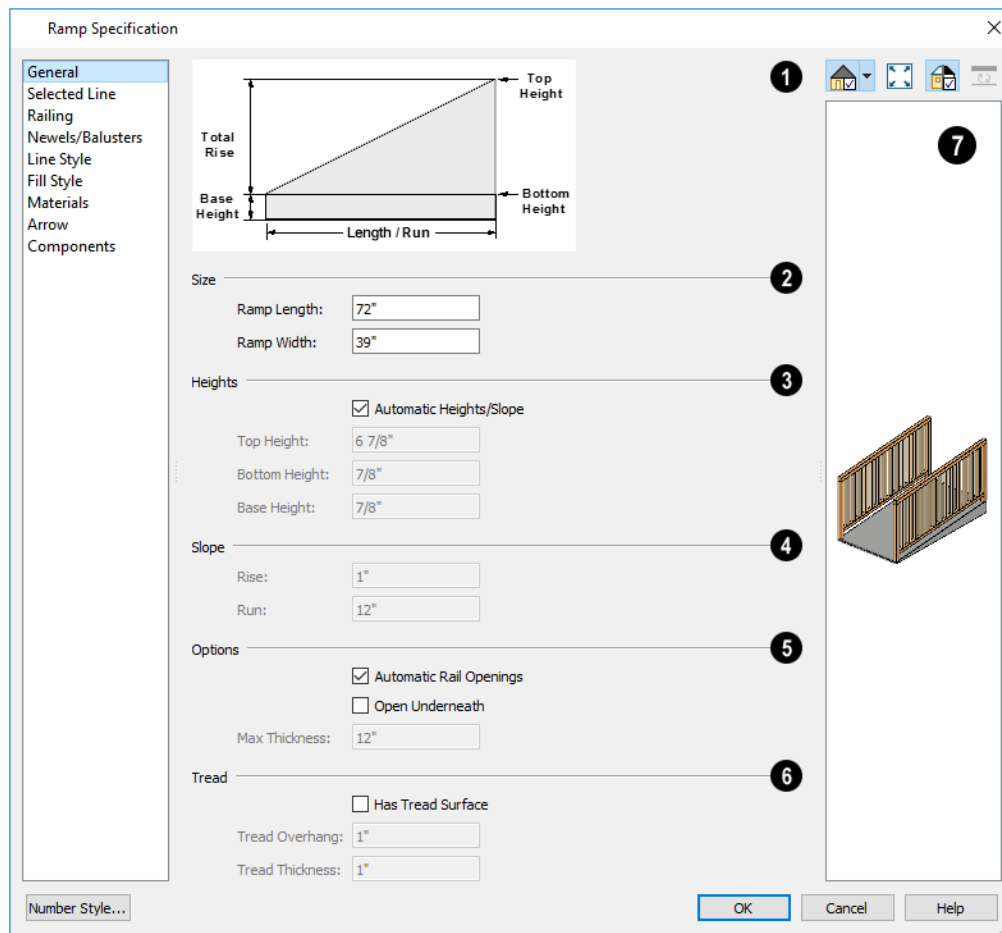

1 Diagram

A diagram of a sample ramp's structure displays here for reference.

2 Size

Specify the **Ramp Length** and **Width**.

3 Heights

Specify the **Heights** of various key locations on the selected ramp.

- Uncheck **Automatic Heights/Slope** to activate the settings below, then specify the height and slope of the ramp.
- Specify the **Top Height**, which is the height of the ramp at its high end.
- Specify the **Bottom Height**, which is the height of the ramp at its low end.
- Specify the **Base Height**, which is the height of the bottom surface of the ramp.

4 Slope

Specify the ramp's **Slope** by typing its **Rise** value in the first field, and the **Run** value in the second field. See *Anatomy of a Staircase on page 512*.

5 Options

- Check **Automatic Railing Openings** to automatically create a doorway opening when the selected ramp is snapped to a railing drawn on the same floor as the ramp. This is checked by default.
- Check **Open Underneath** to remove the skirt around the bottom of the ramp so that it has a uniform, sloped thickness that may not reach the floor or terrain at the high end. This is unchecked by default.
- Specify the **Max Thickness**, which is the ramp's maximum thickness. At the low end of the ramp where it meets the floor or terrain, its thickness may be less than this value.

6 Tread

Specify the structure of the ramp's **Tread**, which is an optional surface layer placed over the top of the ramp.

- Check **Has Tread Surface** to apply a top tread surface to the ramp and enable the settings below.
- Specify the **Tread Overhang**, which is the distance the tread surface extends past the ramp's edges.
- Specify the **Tread Thickness**, which is the tread surface's vertical depth.

7 Preview

A preview of the selected ramp displays on the right side of the panel. If the ramp is composed of multiple sections separated by landings, only the section that was selected when the dialog was opened will display. See *Dialog Preview Panes on page 20*.

SELECTED LINE/ARC PANEL

The **SELECTED LINE** panel is available when the selected ramp segment is a line as opposed to an arc. For more information, see *Line Panel on page 203*.

The **SELECTED ARC** panel is available when the selected ramp segment has been converted to an arc. For more information, see *Arc Panel on page 210*.

See, too, *Selected Edge on page 142* and *Change Line/Arc on page 174*.

RAILING PANEL

The settings on the **RAILING** panel are similar to those on the same panel in the Staircase Specification dialog. For information about these settings, see *Railing Panel on page 544*.

By default, the settings on this panel will also affect the appearance of railings on any landings attached to the selected ramp. See *Landings on page 521*.

NEWELS/BALUSTERS PANEL

The settings on the NEWELS/BALUSTERS panel are similar to those on the same panel in the Staircase Specification dialog. For more information, see *Newels/Balusters Panel on page 547*.

By default, the settings on this panel will also affect the appearance of railings on any landings attached to the selected ramp. See *Landings on page 521*.

RAILS PANEL

The settings on the RAILS panel are similar to those on the RAILS panel of the Staircase Specification dialog as well as the MOLDINGS panel of a variety of other dialogs. See *Moldings Panel on page 665*.

By default, the settings on this panel will also affect the appearance of railings on any landings attached to the selected ramp. See *Landings on page 521*.

LINE STYLE PANEL

The settings on the LINE STYLE panel are available for a variety of other objects in the program. For information about these settings, see *Line Style Panel on page 204*.

FILL STYLE PANEL

The settings on the FILL STYLE panel affect the appearance of the selected ramp in plan view. For information about these settings, see *Fill Style Specification Dialog on page 131*.

MATERIALS PANEL

The settings on the MATERIALS panel affect the appearance of the selected ramp in 3D views and are available for a variety of objects throughout the program. For information about these settings, see *Materials Panel on page 716*.

The settings on this panel will also affect the materials applied to any landings attached to the selected ramp. See *Landings on page 521*.

ARROW PANEL

The settings on the ARROW panel control the appearance of the selected ramp's direction arrow in plan view. See *In Plan View on page 516*.

For information about these settings, see *Arrow Panel on page 205*.

COMPONENTS PANEL

The information on the COMPONENTS panel can be used in the materials list. For more information, see *Components Panel on page 921*.

Stair Landing Specification Dialog

Select a landing and click the **Open Object** edit button to open the Stair Landing Specification dialog. See [Landings on page 521](#).

The Stair Landing Specification dialog has the following panels:

GENERAL PANEL

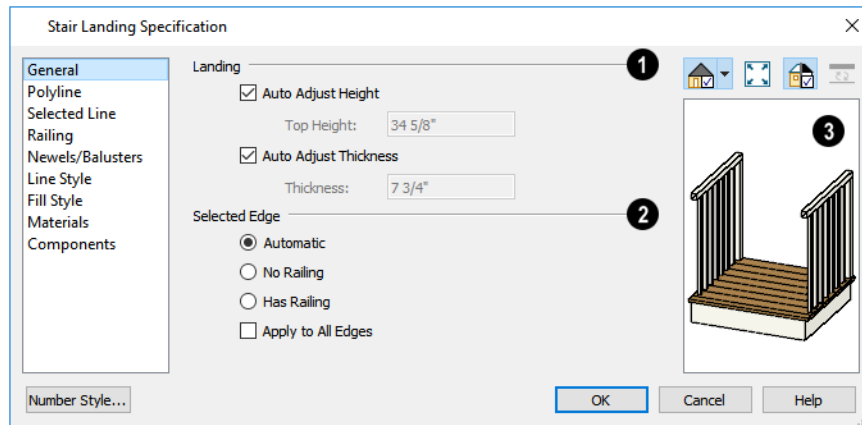

1 Landing

Uncheck **Auto Adjust Height** to specify the selected landing's **Top Height**.

- A free-standing interior landing will have a default Top Height equal to one riser plus the thickness of the default floor finish. A free-standing exterior landing will have a default top height equal to its thickness. When this box is checked, the landing height may adjust as needed to maintain consistent riser height in all connected stair sections, ramp sections, or adjacent landings.
- The **Top Height** field is only active when Auto Adjust Height is unchecked. See [Landing Height and Thickness on page 522](#).

Note: A network of adjacent landings can only be created when Auto Adjust Height is checked. See [Adjacent Landings on page 522](#).

Uncheck **Auto Adjust Thickness** to specify the selected landing's **Thickness**.

- A free-standing landing will have a default thickness of 6 3/4" (169 mm). When checked, the thickness is based on the riser height of the stair sections it is attached to, or the thickness of the ramps it is attached to.
- The **Thickness** field is only active when Auto Adjust Thickness is unchecked.

2 Selected Edge

Specify how railings are applied to the landing's **Selected Edge**. See [Selected Edge on page 142](#).

- Select **Automatic** to suppress the railing on any portion of the selected edge that either connects to a stair or ramp section or has an adjacent landing, but to produce a railing where that is not the case. See [Landing Railings on page 522](#).
- Select **No Railing** to suppress the railing on the selected edge of this landing.
- Select **Has Railing** to produce a railing along the selected edge, even where it connects to a stair or ramp section or has an adjacent landing.
- Check **Apply to All Edges** to apply your selection to all edges of the landing. This is an action rather than a state - the next time this dialog is opened, this box will be unchecked.

3 Preview

A preview of the selected landing displays on the right side of the panel. See [Dialog Preview Panes on page 20](#).

POLYLINE PANEL

The POLYLINE panel states the length of the landing's **Perimeter**, its enclosed **Area**, and its **Volume**.

The settings on this panel are available for a variety of other objects in the program. See [Polyline Panel on page 215](#).

SELECTED LINE/ARC PANEL

The SELECTED LINE panel is available when the selected edge is a line as opposed to an arc. For more information, see [Line Panel on page 203](#).

The SELECTED ARC panel is available when the selected edge has been converted to an arc. For more information, see [Arc Panel on page 210](#).

See, too, [Selected Edge on page 142](#) and [Change Line/Arc on page 174](#).

RAILING PANEL

The settings on the RAILING panel are similar to those on the same panel in the Staircase Specification dialog. For information about these settings, see [Railing Panel on page 544](#).

There is one setting that is unique to the Landing Specification dialog:

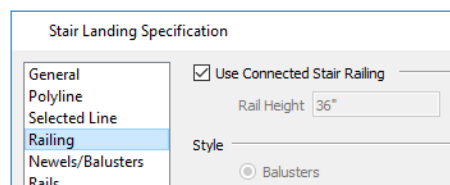

Uncheck **Use Connected Stair** or **Ramp Railing** to enable the settings on this panel, the NEWELS/BALUSTERS panel, and the RAILS panel. When checked, the selected landing derives all railing settings from the connected stairs or ramp.

If the selected landing is not connected to a stair or ramp, this check box will be named **Use Default Interior** or **Exterior Stair Railing**, depending on where the landing is located.

NEWELS/BALUSTERS PANEL

The settings on the NEWELS/BALUSTERS panel are similar to those on the same panel in the Staircase Specification dialog. For more information, see *Newels/Balusters Panel on page 547*.

By default, the settings on this panel will also affect the appearance of railings on any landings attached to the selected ramp. See *Landings on page 521*.

RAILS PANEL

The settings on the RAILS panel are similar to those on the RAILS panel of the Staircase Specification dialog as well as the MOLDINGS panel of a variety of other dialogs. See *Moldings Panel on page 665*.

LINE STYLE PANEL

The settings on the LINE STYLE panel are available for a variety of objects throughout the program. See *Line Style Panel on page 204*.

FILL STYLE PANEL

The settings on the FILL STYLE panel affect the appearance of the selected landing in plan view. See *Fill Style Specification Dialog on page 131*.

MATERIALS PANEL

When a landing is attached to stairs or a ramp, its initial materials are derived from the stairs or ramp. When the landing is attached to a ramp, its top surface material is defined by the Landing Sides component unless the ramp is using a Tread material.

The settings on this are available for a variety of objects throughout the program. For information about these settings, see *Materials Panel on page 716*.

COMPONENTS PANEL

The information on the COMPONENTS panel can be used in the materials list. For more information, see *Components Panel on page 921*.

Roofs

Chapter 22

Home Designer Pro’s manual and automatic Roof Tools allow you to draw almost any roof style.



Verify that all roof planes join as intended. The program does not confirm correct geometry between manually designed or edited roof planes. It is possible to design and edit roof planes with hips and valleys that do not meet properly.

TOPICS

Automatic vs. Manual Roofs	557
Roof Defaults	557
The Roof Tools	558
Automatic Roofs	560
Build Roof Dialog	562
Roof Planes	570
Displaying Roofs	572
Editing Roof and Ceiling Planes	573
Connecting Roof and Ceiling Planes	576
Roof Plane Specification Dialog	578
Roof Baseline Polylines	583
Roof Baseline Specification Dialog	584
Roof and Ceiling Framing	586
Ceiling Planes	586
Ceiling Plane Specification Dialog	587
Gable/Roof Lines	590
Gable Line Specification Dialog	593
Skylights and Roof Holes	593
Roof Hole/Skylight Specification Dialog	594
Dormers and Crickets	596
Editing Auto Dormers	598
Dormer Specification Dialog	599
Roof Returns and Other Details	601
Roof Pitches in Degrees	604

Automatic vs. Manual Roofs

Home Designer Pro can create just about any roof style. Most common roof styles such as hips and gables can easily be generated automatically.

More complex roof styles, including curved roof planes, can be created manually. The manual roof tools allow you to create any roof system that can be represented using roof planes.

AUTOMATICALLY GENERATED ROOFS

The quickest and easiest way to create a roof over a structure is automatically. By default, a roof plane is generated over each exterior wall, creating a hip roof. The program automatically joins the roof planes at ridges, hips, and valleys and tries to create roof planes that join together to form a single, integrated system. See [Automatic Roofs on page 560](#).

Any deviations from the default hip roof can be specified on the ROOF panel of the Wall Specification dialog for any exterior wall. Here, you can specify a Full Gable Wall, High/Shed Gable Wall, or other options instead of a default hip roof. You can also specify a different overhang, pitch, an upper pitch, and the elevation where the upper pitch begins for the roof plane that rests on the selected wall. See [Roof Directives in Walls on page 252](#).

When you need the roof planes over an area of a plan to be entirely separate from those over the rest of the structure, you can assign those areas to a non-default Roof Group. See [Roof Groups on page 560](#).

Roofs can also be automatically generated based on a Roof Baseline Polyline. When a Roof Baseline Polyline is used, information that determines where and how roof planes are generated is contained in the Roof Baseline Specification dialog. See [Roof Baseline Polylines on page 583](#).

Bay, bow, and box windows also produce roof planes automatically. For information about these windows and the roof styles that can be used with them, see [Bay, Box, Bow Windows and Roofs on page 424](#).

MANUALLY DRAWN ROOFS

Any roof system that can be created automatically can also be created manually. Each roof plane is drawn and edited individually, offering full control over the process and limiting the possibilities only to your imagination.

Note: You cannot manually draw or edit roof planes when Auto Rebuild Roofs is enabled in the Build Roof dialog. See [Roof Panel on page 563](#).

USING BOTH TECHNIQUES

Another useful option is to start with an automatically generated roof and use manual design techniques to finish it. Using both automatic roof generation and the manual roof drawing and editing techniques, you can quickly design highly customized roof systems.

Roof Defaults



Select **Edit> Default Settings**, to open the Default Settings dialog for a variety of drawing tools, several of which directly affect roof generation.

ROOF DEFAULTS DIALOG

The Build Roof and Roof Defaults dialogs are nearly identical in appearance and function. The only difference is that the Build Roof dialog has a number of checkboxes that allow you to automatically generate roof planes and related objects. See [Build Roof Dialog on page 562](#).

If changes are made to the settings in this dialog after the roof has been built, you will need to rebuild the roof in order for your changes to take effect.

ROOF FRAMING DEFAULTS

Default settings for framing can be specified in either the Build Roof, Framing Defaults, or the Framing Defaults dialog. Framing defaults control the depth of roof planes as well as the depth of floor and ceiling platforms, which influence roof plane heights. See [Framing Defaults on page 606](#).

To create roof planes with a particular assembly of layers, begin by setting up the desired roof framing defaults, then build the roof. If you later need to change the structure of the roof planes, make the needed change to the Framing Defaults, and then rebuild the roof. You can also edit the structure of individual roof planes.

FLOOR AND CEILING HEIGHTS

The initial heights of floors and ceilings, which influence roof heights, are specified in the Floor Defaults dialog for each floor. See [Floor Defaults Dialog on page 502](#).

The floor and ceiling heights in individual rooms also influence roof heights and are specified in the Room Specification dialog. See [Structure Panel on page 302](#).

 If Auto Rebuild Roofs is checked in the Build Roof dialog and you change floor or ceiling heights, floor or ceiling platform depths, wall positions or roof directives in walls, the roof rebuilds to reflect your changes. See [Rebuilding Roofs on page 561](#).

WALL SPECIFICATION DIALOG

By default, when an automatic roof is built, a roof plane is generated over each exterior wall, creating a hip roof.

Any deviations from this default hip roof, such as a gable or a different pitch, can be specified in the Wall Specification dialog for any exterior wall. See [Roof Panel on page 266](#).

DORMER DEFAULTS

The settings in the Dormer Defaults dialog determine the initial settings for automatic dormers and are much like those in the Dormer Specification dialog. See [Dormer Specification Dialog on page 599](#).

The Dormer Defaults dialog can be opened from the Default Settings dialog or by double-clicking either of the **Auto Dormer**  tools.

The Roof Tools

 Select **Build> Roof** to access the Roof Tools.

BUILD ROOF



Select **Build> Roof> Build Roof** to open the Build Roof dialog, specify the settings for automatically generated and manually drawn roof planes as well as manually drawn ceiling planes, and build or rebuild a roof. See *Build Roof Dialog on page 562*.

When roofs are automatically generated, a roof plane is created over each exterior wall by default, resulting in a hip roof, and the program tries to join them together to form a single, integrated system.

To automatically generate a roof plane using values other than the defaults or to not generate a roof plane bearing on a particular wall (as with a gable or the sides of a shed roof), you can change the settings in the Wall Specification dialog. See *Roof Panel on page 266*.

ROOF PLANE



Select **Build> Roof> Roof Plane** to draw a roof plane manually. See *Roof Planes on page 570*. You can also double-click the **Roof Plane** button to open the Build Roof dialog.

Note: You cannot use the Roof Plane tool when Auto Rebuild Roofs is enabled in the Build Roof dialog. See *Manually Drawn Roofs on page 557*.

CEILING PLANE



Select **Build> Roof> Ceiling Plane** to draw a ceiling plane manually. Ceiling planes are drawn and behave much like roof planes. See *Ceiling Planes on page 586*.

GABLE/ROOF LINE



Select **Build> Roof> Gable/Roof Line** to draw a gable line that generates a gable along a baseline edge when roofs are automatically generated. See *Gable/Roof Lines on page 590*.

SKYLIGHT



Select **Build> Roof> Skylight**, then draw a rectangle over an existing roof plane to create a skylight. The skylight, skylight shaft, and ceiling hole (if a ceiling exists) are drawn at the same time. See *Skylights and Roof Holes on page 593*.

AUTO FLOATING DORMER



Select **Build> Roof> Auto Floating Dormer** and click within an existing roof plane to place an auto floating dormer. See *Dormers and Crickets on page 596*.

AUTO DORMER



Select **Build> Roof> Auto Dormer** and click within a roof plane to place a dormer. See *Dormers and Crickets on page 596*.

DELETE ROOF PLANES



Select **Build> Roof> Delete Roof Planes** to delete all roof planes in the plan. See *Deleting Roof Planes on page 575*.

DELETE CEILING PLANES



Select **Build> Roof> Delete Ceiling Planes** to delete all manually drawn ceiling planes in the plan. See [Ceiling Planes on page 586](#).

FIX ROOFS



Select **Build> Roof> Fix Roofs** to remove breaks where a single edge of one roof plane meets the broken edge of another along a ridge, hip or valley. **Fix Roofs** does not affect eave edges. See [Roof Edges and Walls on page 575](#).

Automatic Roofs

When roofs are automatically generated, a roof plane is created over each exterior wall by default, resulting in a hip roof, and the program tries to join them together to form a single, integrated system.

There are a number of options available to produce variations in this default roof style.

ROOF DIRECTIVES IN WALLS

To automatically generate a roof plane using values other than the defaults or to not generate a roof plane bearing on a particular wall (as with a gable or the sides of a shed roof), you can change the settings in the Wall Specification dialog for that wall. See [Roof Panel on page 266](#).

ROOF GROUPS

When an automatic roof is generated, the program tries to create roof planes that join together to form a single, integrated system. Different parts of the structure influence how the roof is generated over the whole.

When you need the roof planes over an area of a plan to be entirely separate from those over the rest of the structure, you can assign those areas to a non-default Roof Group. The program treats different Roof Groups as separate buildings for the purpose of automatic roof generation, preventing their roofs from influencing one another.

Bear in mind that the use of Roof Groups typically involves using a combination of both automatic roof generation and manual roof editing, and that changes to Attic walls may also be necessary. See [Using Both Techniques on page 557](#).

Roof Groups are assigned using numbers. The Default Roof Group is always 0, and you can assign rooms to other roof groups in the Room Specification dialog. See [General Panel on page 300](#).

CURVED WALLS AND ROOFS

Automatically generated roof planes are placed over curved walls at specified increments. In the Build Roof dialog, you can specify the degree increments for the roof over curved walls, from 6° to 90°. The lower the number, the more roof sections are created over the curved wall.

The following illustrations show a roof created at two different curved increments: 30° and 15°.

Segment Angle at Curved Wall	<input type="text" value="15.0°"/>
Minimum Alcove Size	<input type="text" value="36°"/>

CONCAVE CURVED WALLS AND ROOFS

Regular roof plane sections can also generate over concave curved walls. For roof sections to generate over a concave curved wall, the sections' baselines must be longer than the **Minimum Alcove Size** value on the BUILD panel of the Build Roof dialog.

If the baselines are shorter, the automatically generated roofs are simplified by either:

- Ignoring the curved wall, as if the walls on either side extended to their meeting point.

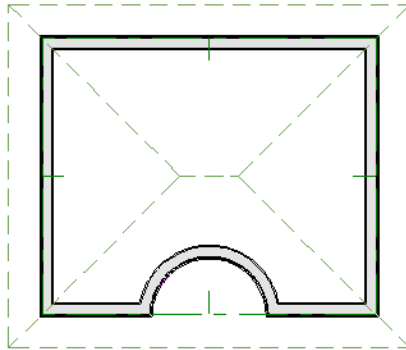

- Spanning the concave curved wall with a straight Baseline and produce a roof plane for it from that.

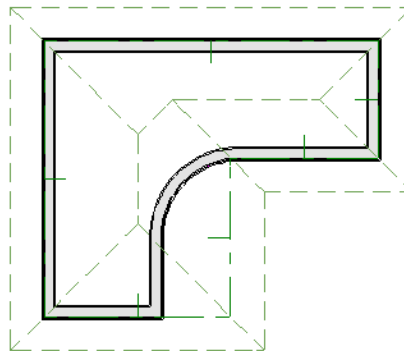

REBUILDING ROOFS

By default, whenever changes are made to wall placement, floor/ceiling heights, or roof directives in walls, the roof will update in response. If you do not want the roof to rebuild automatically, uncheck **Auto Rebuild Roofs** in the Build Roof dialog. See [Roof Panel on page 563](#).

Changes made to floor or ceiling platform thicknesses will also cause the roof to be automatically rebuilt. See [Editing Rooms on page 286](#).

You can also rebuild the roof at any time to reflect the current state of the model by opening the Build Roof dialog, checking **Build Roof Planes**, and clicking OK.

Manually drawn roof planes are specified as such in the Roof Plane Specification dialog. If a roof plane was automatically generated, it will instead have a **Mark as Edited** checkbox. See [Roof Plane Specification Dialog on page 578](#).

When the roof is rebuilt using **Auto Rebuild Roof** or **Build Roof Planes** in the Build Roof dialog, all roof planes in the plan, both automatically generated and manually drawn, are deleted and replaced.

- To preserve any manually drawn roof planes, check **Retain Manually Drawn Roof Planes** on the BUILD panel of the Build Roof dialog before the roof is rebuilt.
- To preserve any automatically generated roof planes that you have edited, check **Retain Edited Roof Planes** on the BUILD panel of the Build Roof dialog before the roof is rebuilt.

Note: Under some conditions, when the roof is rebuilt new roof planes may be generated in the same location as retained manually drawn or automatic roof planes.

Roof planes cannot be edited or manually drawn when **Auto Rebuild Roofs** is turned on. If you try to either edit or draw a roof plane using the **Roof Plane**  tool, a question message will display.

Build Roof Dialog



The Build Roof dialog is used to automatically build or rebuild roof planes and generate Roof Baseline Polyines. The settings in this dialog act as defaults for both manually drawn and automatic roofs. See [Roof Defaults on page 557](#).

To open the Build Roof dialog, select **Build> Roof> Build Roof** . You can also double-click the **Roof Tools**  button or the **Roof Plane**  button to open this dialog.

Roof planes and Roof Baseline Polyines are generated based on the positions and roof directive settings for each exterior wall in the plan. If you make changes to any of these walls or to any of the settings in this dialog, you will need to build the roof again for them to take effect. See [Roof Panel on page 266](#).

Aside from a number of checkboxes on the ROOF panel that allow you to automatically generate roof planes and related objects, the settings in this dialog are also found in the Roof Defaults dialog. See [Roof Defaults on page 557](#).

The settings in this dialog are similar to those found in the Roof Plane Specification dialog, but affect all subsequently created roof planes rather than one or more selected roof planes. See [Roof Plane Specification Dialog on page 578](#).

The Build Roof dialog has the following panels:

ROOF PANEL

Build Roof
✕

Roof

Options

Structure

Arrow

Materials

Roof Styles

Build

Build Roof Planes Retain Manually Drawn Roof Planes

Auto Rebuild Roofs Retain Edited Automatic Roof Planes

Make Roof Baseline Polylines Use Existing Roof Baselines

Specifications

Pitch (in 12):

Trusses (no Birdsmouth)

Roof Overhang

Eave:

Gable:

Roof Height

Raise/Lower From Ceiling Height:

Ignore Top (2nd) Floor

Same Roof Height at Exterior Walls

Same Height Eaves

Allow Low Roof Planes

Automatic Birdsmouth Cut

Raise Off Plate (+) or Birdsmouth (-):

Birdsmouth Seat:

Vertical Structure Depth: 11 1/8

Options

Segment Angle at Curved Wall:

Minimum Alcove Size:

Number Style...
OK
Cancel
Help

1 Build

- Check **Build Roof Planes** to build a new roof structure over the entire model. Unless you specify otherwise, the program discards the existing roof planes and produces new ones.
- If you check **Auto Rebuild Roofs**, the program automatically rebuilds the roof whenever you make a change that affects the generation of roofs, such as changes to exterior walls or ceiling heights.
- Check **Make Roof Baseline Polylines** to delete the existing roof and to create Roof Baseline Polyline(s) based on the exterior wall layout and roof information defined in those walls. Not available when **Build Roof Planes** is checked. See *Roof Baseline Polylines on page 583*.
- You can also specify how manually drawn or edited roof planes are handled when the roof is rebuilt automatically. These options are only available when **Build Roof Planes** is checked. See *Rebuilding Roofs on page 561*.
- Check **Retain Manually Drawn Roof Planes** to prevent manually drawn roof planes from being deleted when roof planes are rebuilt. Automatic roof planes may be generated in the same location. Also available if **Make Roof Baseline Polylines** is checked.
- Check **Retain Edited Automatic Roof Planes** to prevent automatic roof planes that have been manually edited - including roof planes over exploded dormers - from being deleted when roof planes are rebuilt. Also available if **Make Roof Baseline Polylines** is checked.
If a newly generated roof plane is coplanar with a retained plane, and the area where they overlap is at least half the area of either of them, the new roof plane is deleted and only the retained plane is kept.

Note: Under some conditions, new roof planes may be generated in the same location as manually drawn or automatic roof planes that have been retained.

- Check **Use Existing Roof Baselines** to produce a roof plan based on your Roof Baseline Polyline(s) instead of the exterior wall layout.

2 Specifications

- Enter a value to describe the **Pitch** as a ratio over 12.
- Check **Trusses (no Birdsmouth)** if you wish to frame the roof using trusses rather than rafters. The roof height will be set so that the bottom edge of the truss top chord is flush with the top of the wall. See *Roof Trusses on page 642*.
- If you plan to use both trusses with rafters, leave **Trusses (no Birdsmouth)** unchecked so that the rafters' depth can be accommodated. See *Mixing Trusses with Stick Framing on page 647*.

3 Roof Overhang

An overhang is measured horizontally from the outside Main Layer of exterior walls to the top outside edge of the fascia or, if no fascia is present, the end of the top of the rafter. The overhang does not include gutters. See *The Main Layer on page 257*.

- **Eave** is the overhang distance outside of bearing walls for roof planes using the default Pitch. If a particular roof plane has a different Pitch, its overhang will adjust to keep its fascia at the same height. Overhang may be greater for a shallower pitch, lesser for a greater pitch.
- **Gable** is the overhang distance at gable ends or rake walls.

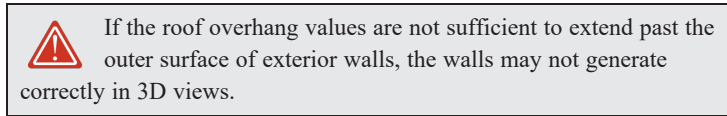

4 Roof Height

- Specify the amount to **Raise/Lower From Ceiling Height**, which controls the height of roof planes relative to the ceiling height specified for the rooms below. See [Floor and Ceiling Heights on page 293](#).
- The default value is 0, which creates roof planes that bear on the wall top plates at the Ceiling Height of the room below.
- Increase this value to raise roof planes so they do not bear directly on the wall top plates. If roofs are raised sufficiently, Attic walls will automatically generate to support them. The exact height depends on the roof pitch.
- Decrease this value to drop roof planes downward and decrease the height of the bearing walls. If roofs are lowered sufficiently, they may extend into rooms, producing areas with angled ceilings.
- Check **Ignore Top Floor** to ignore the top living floor when roof planes are generated. Roof planes are built on the top plates of the walls below the top floor.
- Specify how you would like the eaves of roof planes with different pitches to meet. See [Aligning Eaves on page 577](#).
- Check **Same Roof Height at Exterior Walls** to keep bearing walls the same height and change horizontal roof overhang distances as needed so that eaves meet correctly. When checked, this option ignores any overhang values you may have entered in the Wall Specification dialog. See [Aligning Eaves on page 577](#).

Uncheck this option to raise or lower some roof planes relative to the wall's top plate, allowing all horizontal overhangs to be the same unless a non-default value has been entered in the Wall Specification dialog. See [Roof Directives in Walls on page 252](#).

- Check **Same Height Eaves** to keep the eave height for all roof planes the same. Roof planes are raised and lowered as needed so that eaves meet correctly.

The eave height used when this box is checked is that of a roof plane using the default Pitch and Overhang values. When this box is checked, all roof planes are affected, including those that do not need adjustment in order to align with adjacent planes.

When **Same Height Eaves** is checked, any non-default overhang values specified in the Wall Specification dialog are used. Roof planes are raised or lowered so that the eave height is the same, regardless of the horizontal overhang.

- Uncheck **Allow Low Roof Planes** only when an upper floor overhangs roof planes below.

5 Automatic Birdsmouth Cut

- Uncheck **Automatic Birdsmouth Cut** to enable the settings below. When checked, the birdsmouth is calculated based on the pitch and rafter depth and its values are listed here for reference. See [Birdsmouth Cut on page 574](#).
- The **Raise Off Plate** and **Birdsmouth** settings do not affect the bearing wall heights.
- Enter a positive **Raise Off Plate** value in this field to produce the trusses with an energy heel to allow for more insulation.
- Enter a negative **Birdsmouth Cut** value to control the Birdsmouth Depth. For example, for the Birdsmouth Depth of 3", enter -3". The location of the Baseline may change if you use the **Raise Off Plate** setting to specify the birdsmouth depth. See [Birdsmouth Cut on page 574](#).
- Specify the **Birdsmouth Seat**, which is the horizontal depth of the birdsmouth cut. If you change this value, the **Raise Off Plate/Birdsmouth Cut** value will automatically adjust.
- To control the Birdsmouth Cut, you should also check **Same Roof Height at Exterior Walls**, above.
- The **Vertical Structure Depth** displays here as a reference. It can be changed on the STRUCTURE panel. See [Structure Panel on page 569](#).

6 Options

- Enter the **Segment Angle at Curved Wall**, which is the angle for roof segments automatically generated to cover a curved wall. A smaller angle produces more roof planes. Note that in some instances, slightly smaller or larger values will be used instead of the specified angle.
- Specify the **Minimum Alcove Size**, which is the minimum depth and width of an alcove in an otherwise straight exterior wall. Alcoves with both a depth and width less than this value are roofed over, while alcoves that are either wider or deeper than this value do not receive a roof.

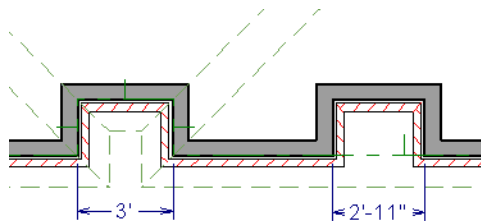

OPTIONS PANEL

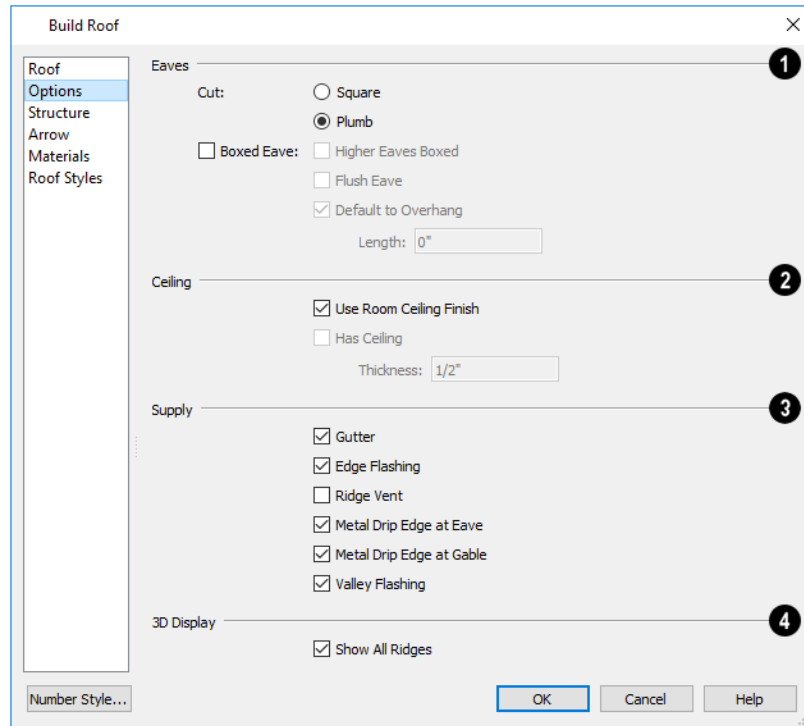

1 Eaves

- Specify how the rafter and truss ends are **Cut** by selecting either **Square Cut** or **Plumb Cut**.
- Check **Boxed Eave** to produce horizontal boxed eaves or uncheck it for sloping eaves. You can also change this for individual roof planes in the Roof Plane Specification dialog. See [Boxed Eaves on page 602](#).
- Check **Flush Eave** to produce box eaves that build flush with the adjacent exterior wall. When unchecked, boxed eaves build to the gable fascia.
- **Higher Eaves Boxed** - If the selected roof plane contains more than one eave, check this box to box the higher eaves as well as the lower ones.

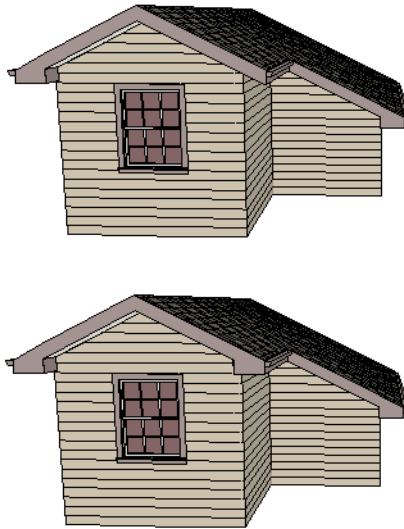

- By default, Boxed Eaves extend from the inside edge of the roof fascia to the exterior Main Layer of the wall, enclosing the overhang area. If an exterior room with **Use Soffit Surface for Ceiling** checked is located between the roof's baseline and an interior room, the Boxed Eave will extend across that room, as well. You can instead uncheck **Default to Overhang** and specify the **Length** of the boxed eaves. Not available if **Flush Eave** is checked.

2 Ceiling Break Lines

See [Special Ceilings on page 297](#).

- Specify how the **Ceiling** surface on the underside of roof planes is built. See [Vaulted and Cathedral Ceilings on page 298](#).
- When **Use Room Ceiling Finish** is checked, the ceiling finish thickness and material on the undersides of roof planes are defined by the room below. Uncheck this box to enable the two settings that follow and define the ceiling finish as part of the roof planes instead. When this is unchecked, you can specify the Ceiling Surface material on the [Materials Panel on page 569](#).
- Check **Has Ceiling** to enable the Ceiling Thickness option. When this box is unchecked, the selected roof plane will have no ceiling surface at all and the "Ceiling Surface" component will not be available on the MATERIALS panel.
- Specify the **Ceiling Thickness**, which is the thickness of the bottom surface of the ceiling plane.

3 Supply

Specify which material components to calculate in the Materials List. See [Materials Lists on page 904](#). Only **Gutter** is available in the Roof Plane Specification dialog.

- Uncheck **Gutter** to not include gutters on subsequently-built roof planes. This option affects both the Materials List and 3D views.
- Check **Edge Flashing** to calculate edge flashing in the Materials List when one or more roof planes is against a wall.
- Check **Ridge Vent** to calculate ridge venting in the Materials List.
- Check **Metal Drip Edge at Eave** to calculate metal drip edge along the eaves in the Materials List.
- Check **Metal Drip Edge at Gable** to calculate metal drip edge along any gable eaves in the Materials List.
- Check **Valley Flashing** to calculate valley flashing in the Materials List when two or more roof planes form a valley.

4 3D Display

- When **Show All Ridges** is checked, a line along each hip between roof planes forming the conical roof above a curved wall displays in Vector Views. Uncheck this box to suppress these lines. See [Rendered and Vector Views on page 736](#).

STRUCTURE PANEL

The settings on the STRUCTURE panel of the Build Roof dialog are the same as those on the ROOF panel of the Build Framing dialog. Changes made in one dialog are also applied in the other. See [Roof Panel on page 624](#).

Note: Changes made on the Structure panel will not affect the structure of existing roof planes. To make changes take effect, rebuild the roof.

ARROW PANEL

The settings on this panel allow you to control the appearance of roof plane slope direction arrows. See [Displaying Roofs on page 572](#).

For information about these settings, see [Arrow Panel on page 205](#).

MATERIALS PANEL

The settings on this panel allow you to specify the default materials for the roof's various components. See [Materials Panel on page 716](#).

ROOF STYLES PANEL

The ROOF STYLES panel provides links to tutorial information about creating different roof styles automatically. Click on a roof style to launch the online Help to a page with information about the roof style you selected.

COMPONENTS PANEL

The information on the COMPONENTS panel can be used in the materials list. For more information, see [Components Panel on page 921](#).

Roof Planes

When creating a roof, it is helpful to know how to draw a roof plane manually and be familiar with its parts.

DRAWING ROOF PLANES



Roof planes are CAD-based objects that are created and edited like much closed polylines, and also have pitch, elevation and structural properties.

Before drawing roof planes, you should set your roof defaults so that the 3D attributes of your roof planes are correct. See [Roof Defaults on page 557](#).

To draw a roof plane

1. Select **Build> Roof> Roof Plane** .
2. Click and drag a Baseline from point **1** to point **2**, as in the following example:

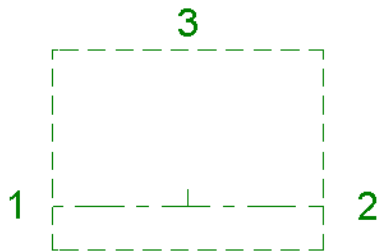

Most roof planes are drawn over a wall, and the Baseline should be located directly above the outer edge of the wall's Main Layer. See [The Main Layer on page 257](#).

3. Release the mouse button at point **2** and move your cursor in the upslope direction. As you move the cursor, a preview outline of the roof plane displays.
4. Click at point **3** to build the roof plane. Point 3 is located on the ridge edge of the roof plane.

Note: You cannot manually draw roof planes when Auto Rebuild Roofs is enabled in the Build Roof dialog. See [Roof Panel on page 563](#).

THE BASELINE

The pitch direction and initial height of any roof plane - manual or automatic - is determined by its Baseline.

The Baseline of the roof plane is normally located over the outer main layer of the wall and is used as the pivot point for the roof plane when the pitch is changed.

The Baseline height is determined by the following formula:

$$\text{Elevation of the wall top plate} + (\text{Vertical Structure Depth} - \text{Vertical Birdsmouth Depth}) = \text{Baseline Height}$$

In a cross section, the Baseline is located directly above the outer surface of the main wall layer, at the top surface of the roof framing.

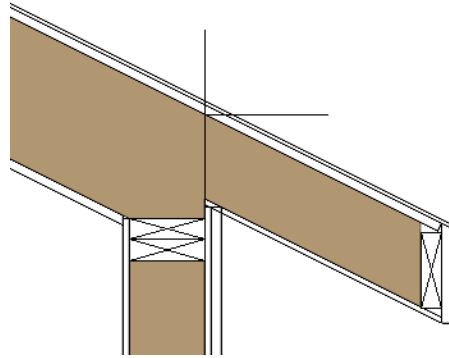

A roof Baseline displays as a separate line within its roof plane when the “Roofs, Baselines” layer is turned on. In 3D views, it can only be seen if the roof plane is selected.

A Baseline has a tick mark at its center point which indicates the direction that the roof plane slopes upward. If the upslope tick is pointing the wrong direction, either rotate the entire roof plane or delete it and draw a new one.

When drawing the Baseline of a roof plane, here are some things to consider:

- A Baseline does not have to be drawn over a wall, although it often is.
- A Baseline drawn along a wall should be drawn over the outer edge of the wall’s main layer. It tries to snap to that layer.
- The elevation of the top plate is defined by the ceiling height in the room. If the roof plane is not drawn over a wall, it’s height is based on the default ceiling height value for the current floor.
- If a Baseline is drawn over the top of any other roof plane, the Baseline height equals the height of the existing roof plane at the point where you started drawing.

Once drawn, a Baseline can be selected in plan view and edited independent of the roof plane. See [Editing Roof Baselines on page 574](#).

EAVE AND GABLE OVERHANGS

Roof overhangs are measured horizontally from the outside Main Layer of exterior walls to the top outside edge of the fascia or, if no fascia is present, the end of the top of the rafter. The overhang does not include gutters. See [The Main Layer on page 257](#).

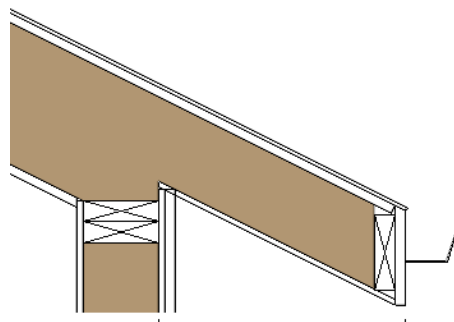

The location of a roof plane’s fascia and shadow boards also determines its area and the size of its polyline in plan view. See [Polyline Panel on page 581](#).

Displaying Roofs



The display of roof planes, their labels, and attributes such as gutters and ridge caps is controlled in the Layer Display Options dialog. See [Layer Display Options Dialog on page 126](#).

Roof planes are drawn on the "Roof Planes" layer. If this layer is turned off and **Auto Rebuild Roofs** feature is turned on, changes made to the plan that cause the roof to rebuild will not automatically turn on its display. See [Rebuilding Roofs on page 561](#).

IN PLAN VIEW

A number of layers associated with roof planes only display information in plan view, including "Roofs, Baselines" and "Roofs, Gable Lines". In addition,

If the bottom surface of the roof extends below the ceiling height of a room, Ceiling Break lines will display, indicating where the flat ceiling ends and sloped ceiling begins. Ceiling Break lines are drawn on the "Ceiling Break Lines" layer in plan view only.



In plan view, roof planes can display on any floor without affecting their height in 3D. To move the display of a roof plane to a new floor, select it in plan view and click either the **Display on Floor Above** or **Display on Floor Below** edit button. The display of group-selected roof planes can also be controlled in this manner.



Any skylights or roof holes placed in a roof plane moved in this manner will move, as well. Other associated objects like Auto Dormers or gutters will not move, however.

ROOF PLANE LABELS

Roof plane labels indicating the pitch and slope direction are located on the "Roofs, Labels" layer and can be set to display in floor plan view.

You can specify whether roof plane labels display the pitch in terms of rise and run or in decimal degrees by checking or unchecking **Pitch in Degrees** in the Roof Plane Specification dialog. See [General Panel on page 579](#).

A roof plane's label can be customized in its specification dialog. See [Label Panel on page 363](#).

Manually drawn **Ceiling Planes**  and **Skylights**  can also display labels when the "Roofs, Labels" layer is on. Unlike roof planes, these objects' labels do not include a slope indicator and their Automatic Labels are blank; however, you can specify a custom label using text in their specification dialogs. See [Ceiling Planes on page 586](#) and [Skylights and Roof Holes on page 593](#).

When a roof plane, ceiling plane or roof hole/skylight is selected in a 3D view, its label will display on a temporary basis if the "Roofs, Labels" layer is turned on.

IN CROSS SECTION VIEWS

When a roof or ceiling plane is viewed in a cross section, the layers that compose it can be seen, including the roof surface, sheathing, and the ceiling surface:

- If roof framing has been built, its display can be turned on, as well. See [Displaying Framing on page 632](#).
- If a roof or ceiling plane is located over a room with **Flat Ceiling Over this Room** checked, the ceiling surface will not generate. See [Vaulted and Cathedral Ceilings on page 298](#).

IN THE MATERIALS LIST

The materials that make up roof and ceiling plane assemblies are listed under different Categories in the Materials List:

- **Roofing** - Lists most materials associated with roofs, including roofing, sheathing, rafters and trusses, gutters, and skylights.
- **Insulation** - Insulation is calculated for roof and ceiling planes above rooms that do not have Flat Ceiling Over This Room checked. See *Structure Panel on page 302*.
- **Wallboard** - Lists ceiling materials for all rooms, including those that use the underside of the roof as their ceiling.
- **Framing** - Lists ceiling framing for manually drawn ceiling planes.

See *Materials Lists on page 904*.

Editing Roof and Ceiling Planes

A selected roof or ceiling plane can be edited in 2D and 3D using edit handles, edit toolbar buttons, its specification dialog, and the **Material Painter** . See *Material Painter Tools on page 713*.

A roof or ceiling plane's Baseline can also be selected and edited. To select it, first select the roof plane and then click the **Select Next Object**  edit button. See *The Baseline on page 570*.

The appearance and display of roof and ceiling planes can also be customized. See *Displaying Roofs on page 572* and *Roof Plane Specification Dialog on page 578*.

By default, all roof planes are deleted and replaced whenever the roof is rebuilt using the Build Roof dialog. If you have manually edited roof planes and do not want them to be replaced, be sure to check **Retain Edited Roof Planes**. See *Roof Panel on page 563*.

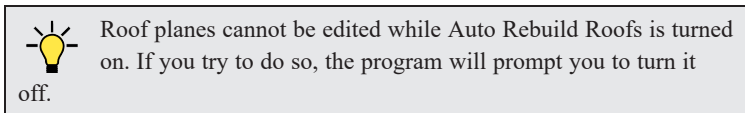

2D SHAPE AND 3D ORIENTATION

There are two basic aspects to editing roof planes: 2D shape and 3D orientation.

- The 2D shape of a roof or ceiling plane can be edited much like a closed CAD polyline. As a plane's perimeter is reshaped in 2D, the program maintains its height and pitch in 3D. See *Editing Closed Polyline-Based Objects on page 155*.
- The 3D orientation of a roof or ceiling plane is defined by its height, pitch, and its structure: all of which can be edited in its specification dialog.

An understanding of these two concepts allows you to design almost any kind of roof system.

RAISING/LOWERING ROOF AND CEILING PLANES

The default height of a roof or ceiling plane is based on the ceiling height of the room below. See *Floor and Ceiling Heights on page 558*.

 Roof planes can be raised or lowered in the Roof Plane Specification dialog. Begin by locking the **Pitch**, then change one of the **Height** values. See [General Panel on page 579](#).

Ceiling planes can be edited in a similar manner in their specification dialog. See [General Panel on page 588](#).

 You can also raise or lower roof and ceiling planes using the **Transform/Replicate Object** edit tool. See [Transform/Replicate Object Dialog on page 180](#).

In addition, when a new floor is added to a plan, you can choose to move any roof planes displaying on the top floor up to the newly added floor level. Ceiling planes are not affected when a new floor is added. See [Adding Floors on page 503](#).

CHANGING A ROOF OR CEILING PLANE'S PITCH

The default pitch for a roof system as well as for manually-drawn ceiling planes is set in the Build Roof dialog. Non-default pitches can be set in the specification dialog of each exterior bearing wall defining a room on the top floor level of the plan. See [Roof Directives in Walls on page 252](#).

 Just as with its height, the pitch of a roof or ceiling plane can be modified on the GENERAL panel of its specification dialog. Begin by locking one of the **Height** values and then change the **Pitch**.

If you choose to lock the **Top of Plate** height of a roof plane, the point about which the plane will pivot depends on whether **Automatic Birdsmouth Cut** is checked in the Build Roof dialog.

- When it is checked, the roof plane will pivot about the top inside edge of the bearing wall's top plate.
- When it is unchecked, it will pivot about the top outside edge of the top plate.

Changing a roof plane's pitch can affect how it connects to adjacent roof planes. See [Connecting Roof and Ceiling Planes on page 576](#).

EDITING ROOF PLANE STRUCTURE

To create roof planes of a particular depth, begin by setting up the desired roof framing defaults, then build the roof. See [Framing Defaults on page 606](#).

If you later need to change the structure of the roof planes, make the needed change to the Framing Defaults, and then rebuild the roof. You can also edit roof structure on an individual roof plane basis. See [Roof Plane Specification Dialog on page 578](#).

BIRDSMOUTH CUT

The birdsmouth is the notch cut into a rafter where it rests on the wall top plate. You can control its vertical depth and the width of the birdsmouth seat in the Build Roof dialog. See [Roof Panel on page 563](#).

There are two ways to create a roof plane with no birdsmouth:

- Check **Trusses (No Birdsmouth)** in the Build Roof dialog before drawing the roof plane.
- Specify a **Raise Off Plate** value of at least 1/16" in the Build Roof dialog.

To change the birdsmouth depth after the roof is built, you can move the roof planes up or down, or change the pitch. For example, if you lock the pitch and raise the roof plane by one inch, you decrease the birdsmouth depth by one inch.

EDITING ROOF BASELINES

The pitch direction and initial height of any roof plane - manual or automatic - is determined by its Baseline. See [The Baseline on page 570](#).

In plan view, a Baseline can be selected and edited independent of the roof plane. To select it, click on the roof plane at the location of the Baseline and then click the **Select Next Object**  edit button. The Status Bar tells you when the roof plane Baseline is selected. See [Select Next Object on page 143](#).

If a roof plane Baseline is moved, its height will not change. Instead, the height of the roof plane will be affected. In most cases, therefore, moving a roof plane's Baseline independent of the roof plane itself is not recommended.

If the angle of a roof plane's Baseline is changed, the direction of the roof plane's pitch will be modified. The Baseline Angle can be modified in either of two ways:

- In the Roof Plane Specification dialog. This will change its angle relative to the floor, and will tilt the roof plane along an axis perpendicular to its Baseline. This method is helpful when a specific eave angle is needed. See [General Panel on page 579](#).
- Using its Rotate edit handle in plan view. This will change its angle relative to the roof plane's eave or ridge and will modify the direction of the pitch. This method is best when the pitch direction matters more than the angle of the eave.
- Both of these methods can be used to modify the same roof plane, although the second approach makes it difficult to control both the pitch direction and eave angle, and is not recommended.

The length of a roof plane Baseline can be lengthened or shortened using its edit handles without changing any of the roof plane's attributes.

ROOF EDGES AND WALLS

By default, the edges of a roof plane will automatically snap to the outer surface of a nearby parallel wall. You can disable this **Special Snapping** behavior for a selected roof plane in its specification dialog. See [General Panel on page 579](#).

After moving a corner edit handle, it may be difficult to make an edge parallel to an eave or a wall. Use the **Make Parallel/Perpendicular**  edit button to align a roof or ceiling plane edge with a wall, another roof plane edge, or another object with a straight edge. See [Make Parallel/Perpendicular on page 169](#).

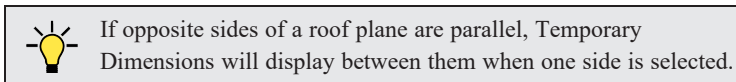

Sometimes, what appears to be a single, straight roof plane edge may actually be broken into two or more edges, which can affect your ability to align the edge properly.

A single edge will have three edit handles; if more than three display, more than one edge is present. An extra handle can be removed manually by dragging it into an adjacent handle. You can also use **Build > Roof > Fix Roofs** . See [Fix Roofs on page 560](#).

When **Bumping/Pushing**  is enabled and **CAD Stops Move** is checked in the Roof Plane Specification dialog, a roof plane will bump against another roof plane, CAD or CAD based object as it is moved. Roof planes cannot push these objects, however. See [Bumping/Pushing on page 166](#).

LOCKING ROOF PLANES

When the roof plan is correct, roof planes can be locked to prevent accidental changes. To do this, lock the "Roof Planes" layer. See [Layer Display Options Dialog on page 126](#).

Locking roof planes will not prevent roof planes from being deleted if the floor they are on is deleted.

DELETING ROOF PLANES

There are several ways to delete roof planes.



Delete the entire roof quickly by selecting **Build> Roof> Delete Roof Planes**.



You can also delete all roof planes at once in the Delete Objects dialog. See *Delete Objects Dialog on page 188*.



In addition, you can select any roof plane or group of roof planes, then press the Delete key or click the **Delete** edit button to delete it from the plan. See *Deleting Objects on page 187*.

Generally speaking, roof planes cannot be deleted if they are locked. An exception to this rule occurs when an entire floor of a plan is deleted. Any roof planes present on a floor will be deleted when the floor is deleted, locked or not. See *Deleting Floors on page 506*.

When a roof plane is deleted, any roof framing associated with it is automatically deleted, as well.

Connecting Roof and Ceiling Planes

When a roof system is drawn correctly, roof planes will meet along geometrically correct lines to form ridges, hips, and valleys. There are a number of tools to help you achieve this when manually drawing or editing roofs.

To generate roof planes that do not form a single, integrated system, consider using Roof Groups. See *Roof Groups on page 560*.

By default, all roof planes are deleted and replaced whenever the roof is rebuilt using the Build Roof dialog. If you have manually edited roof planes and do not want them to be replaced, be sure to check **Retain Edited Roof Planes** in the Roof Plane Specification dialog. See *Roof Panel on page 563*.



Roof planes cannot be edited while Auto Rebuild Roofs is turned on. If you try to do so, the program will prompt you to turn it off.

JOIN ROOF PLANES



Two roof or ceiling planes can be joined at adjacent edges in both 2D and 3D using the **Join Roof Planes** edit button. To use this tool, first identify which edges of the roof planes can extend to meet at a ridge, hip, or valley. The program will join the two planes along the line where they intersect whenever possible.

To use Join Roof Planes

1. Select a roof or ceiling plane on the edge to be joined to another plane.
2. Click the **Join Roof Planes**  edit button (or press 2 on the keyboard).
3. Move your pointer to the edge of the second roof or ceiling plane that the first one needs to join to. When your pointer is over the second plane, this plane will highlight.
4. Click on the edge of the second roof or ceiling plane to join it to the first plane.

Note: Join Roof Planes cannot be used to join a roof plane and ceiling plane. Only planes of the same type can be joined using this tool.

If the planes are not close enough, or their shape is not correct, you may need to align their edges, remove extra edges, or move them closer.

When roof or ceiling planes adjust, the program joins them at the proper location and the adjacent edges extend or contract to remain connected. If the joining of the two will completely eliminate or reverse an adjacent edge, the connection cannot be made.

LOCATING INTERSECTIONS

When roof planes of differing slopes meet, they create a ridge, hip, or valley. The **Join Roof Planes**  edit tool is the easiest way to move roof plane edges so that they meet correctly; but you can also locate roof plane intersection points where the ridge, hip or valley should be. Once you know where the planes will meet, you can drag edges or corners to those points.

To find roof plane intersection points

1. Make sure that **Automatically Place Roof Intersection Points** is turned on in the Preferences dialog. See [Architectural Panel on page 73](#).
2. Select the roof plane you would like to place intersection points on.
3. Click the edge of another roof plane to place a temporary CAD Point where it would meet the selected roof plane.
4. Repeat steps 1 and 2 for the ridge edge and both fascia edges. You should have three points located on the larger roof plane: these are the intersection points.

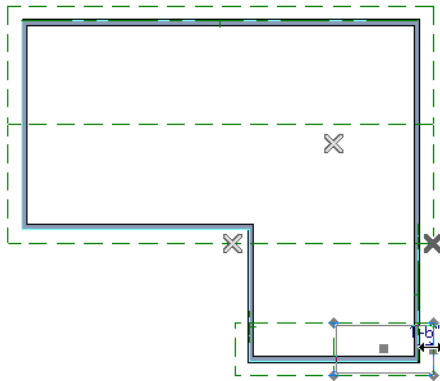

5. Once these intersection points are identified, you can snap the corners of the second roof plane to them.

ALIGNING EAVES

It is not uncommon for roof plans to feature more than one pitch. In order for the eaves of roof planes with different pitches to meet correctly at ridges and hips, you must control the roof planes' heights and their horizontal overhang distances. Two options in the Build Roof dialog allow you to control how the eaves of automatically generated roof planes align. See [Roof Panel on page 563](#).

- **Same Roof Height at Exterior Walls** maintains the default height of roof planes where they bear on exterior walls. The horizontal overhang distances of any non-default roof planes are adjusted so that they continue to join correctly with default roof planes.
- **Same Eave Heights** maintains the default roof plane height at the eaves as well as any non-default horizontal overhang distances. All roof planes are raised or lowered so that they all have the same height at the eaves as default roof planes.

Roof planes that do not join other roof planes with different pitches at ridges or hips are referred to as Independent.

- When **Same Roof Height at Exterior Walls** is checked, Independent roof planes are not affected and will maintain any non-default overhang values.
- When both **Same Roof Height at Exterior Walls** and **Same Eave Heights** are checked, the overhangs of Independent roof planes will be adjusted to preserve their heights at both the exterior walls and the eaves.

MOVE TO BE COPLANAR



The **Move to be Coplanar** edit button allows you to move the selected roof plane to be coplanar (in the same plane) with the next selected roof plane. You can use this tool in both 2D and 3D views. The results can be easily seen in a cross section view. The two roof planes must have parallel Baselines for this to work.

SET BASELINE HEIGHT DIALOG

If you manually draw a roof plane so that it bears on a wall at its Baseline, and is placed in the same location as an existing roof plane, the Set Baseline Height dialog will display. See *The Baseline on page 570*.

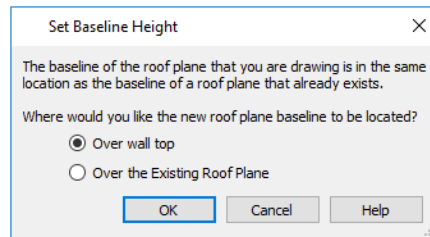

- Select **Over Wall Top** to create a roof plane that bears on the wall it is drawn over and has an overhang as specified in the Build Roof dialog. This option would be appropriate to produce a full height dormer. See *Manually Drawn Dormers on page 597*.
- Select **Over the Existing Roof Plane** to produce a roof plane with a height based on that of the roof plane below it rather than the wall. The Baseline height equals the top height of the existing roof at the point where you began drawing the new roof plane Baseline, and has no overhang. This option would be appropriate to create a dormer vent or cricket. See *Manually Drawn Crickets on page 598*.

Roof Plane Specification Dialog



Select one or more roof planes and click the **Open Object** edit button to open the Roof Plane Specification dialog.

The Roof Plane Specification dialog has the following panels:

GENERAL PANEL

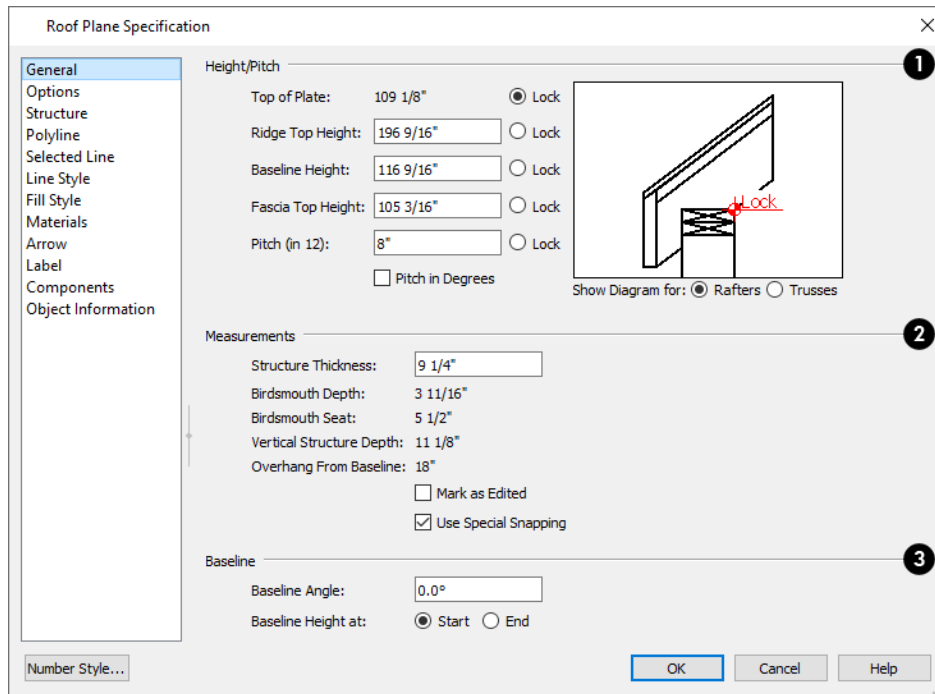

There are four values that define the 3D orientation of a roof plane: **Ridge Top Height**, **Baseline Height**, **Fascia Top Height**, and **Pitch**.

Locking any of the **Height** values defines that value as the pivot point for the selected roof plane. Each of these dimensions is measured from the first floor default elevation of 0' - 0".

If you lock the **Pitch** and change a Height value, the roof plane moves vertically, keeping the same slope. It will not pivot.

Changing these values does not affect the 2D representation of the roof plane.

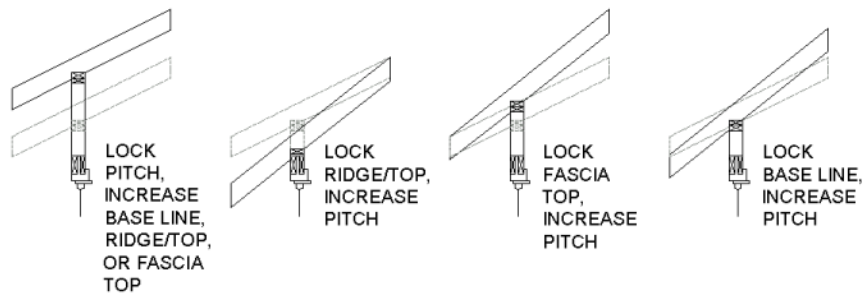

1 Height/Pitch

Specify the **Height** and **Pitch** of the selected roof plane(s). Heights are measured from the top surface of the roof plane(s) rafters or trusses. See *Roof Planes on page 570*.

- The **Top of Plate** is defined by the ceiling height of the room below and is reported here for reference. N/A displays if no room is below the roof plane.
- Define the **Ridge Top Height**, or lock this value to make it the roof plane's pivot point.
- Define the **Baseline Height**, or lock this value to make it the pivot point.
- Define the **Fascia Top Height**, or lock this value to make it the pivot point.

Note: The Fascia Top height will decrease slightly if the fascia edge is aligned with the ridge top of another roof plane.

- Specify the **Pitch** for the selected roof plane, or lock this value to move the roof plane vertically when a Height value is changed.
- Check **Pitch in Degrees** to display the pitch value in this dialog in degrees in all dialogs as well as in roof plane labels. Values between -89° and 89° can be entered. When **Pitch in Degrees** is unchecked, Pitch is described in terms of rise and run: x inches in 12 and in metric plans, x mm in 1000.

The diagram to the right of the Height/Pitch settings shows the location of the Lock point. If a Height/Pitch setting is currently selected for editing, its location will also be indicated using an arrow.

- By default, the selected **Show Diagram for** option is determined by whether Trusses (no Birdsmouth) was checked in the Build Roof dialog when the selected roof plane was created.
- Select a radio button to choose whether to **Show Diagram for Rafters** or **Trusses**. The structure of the roof and location of the Top of Plate Lock point vary between these two options.

2 Measurements

Information about the structure of the selected roof plane(s) displays here for reference.

- Specify the **Structure Thickness** of the selected roof plane(s). The default Structure Thickness is set in the Build Framing dialog. See *Build Framing Dialog on page 613*.
- The **Birdsmouth Depth** is the plumb or vertical depth of the birdsmouth cut. To change it, move the roof plane some way. For example, if you lock the pitch and raise the roof plane by one inch, you will decrease the birdsmouth depth by one inch. See *Birdsmouth Cut on page 574*.
- The **Birdsmouth Seat** is the horizontal width of the birdsmouth cut. This value is dynamically linked to the birdsmouth depth - if one changes, so does the other.
- The **Vertical Structure Depth** is defined by measuring a plumb line across the roof plane structure. The degree of pitch affects the Vertical rafter width. The greater the pitch, the greater the vertical structure depth.
- **Overhang from Baseline** is the horizontal overhang measured from the Baseline to the eave.
- **Mark as Edited** - When an automatically generated roof plane is modified, the program marks it as "edited", giving you the option of retaining it when the roof is rebuilt. Uncheck this box to remove this status from the selected roof plane. See *Rebuilding Roofs on page 561*.
- **Mark as Edited** is only available for automatically generated roof planes. If a manually drawn roof plane is selected, the words **Manual Roof Plane** will display here instead.
- When **Use Special Snapping** is checked, the selected roof plane's edges will automatically snap to the outside surface of walls that it may butt against. Uncheck this to prevent the roof plane from snapping to any nearby walls.

3 Baseline

Specify the angle of the selected roof plane's **Baseline**, relative to the XY axis. See *Editing Roof Baselines on page 574*.

- A positive **Baseline Angle** value causes the Baseline to tilt upward from its default height. A negative value causes it to tilt downward. The top heights of any walls under the selected roof plane will become angled, as well.
- The **Baseline Height** defined above can be maintained at either the **Start** or **End** point. In plan view, the Baseline direction is clockwise around the house.

OPTIONS PANEL

The settings on the OPTIONS panel are the same as those on the panel of the same name in the Build Roof dialog, but affect the selected roof plane only. See *Options Panel on page 567*.

STRUCTURE PANEL

The settings on the STRUCTURE panel are similar to those on the ROOF panel of the Build Framing dialog, but apply to the selected roof plane only. See *Roof Panel on page 624*.

One checkbox is unique to the STRUCTURE panel of the Roof Plane Specification dialog: check **Retain Roof Framing** to keep the selected roof plane's framing from being deleted and replaced when roof framing is rebuilt.

POLYLINE PANEL

The POLYLINE panel states the length of the roof plane's **Perimeter** and its enclosed **Area**, calculated using several different methods.

Roof Plane Specification		
General	Perimeter:	943 11/16"
Options	Framing Area:	294.683 sq ft
Structure	Projected Area:	247.25 sq ft
Polyline	Roof Surface Area:	297.158 sq ft
Selected Line	Overhang Area:	54.3133 sq ft
Line Style	Projected Overhang Area:	45.1914 sq ft
Fill Style		

- The **Perimeter** is the total length of the roof plane’s sides, not including fascia, with its pitch taken into account. It does not equal the perimeter as measured in plan view unless the roof plane has no fascia and the pitch is 0.
- The **Framing Area** is the area of the roof plane’s framing, not including the fascia, with the pitch taken into account. It is slightly smaller than the Roof Surface Area as roofing typically overhangs the framing by a small amount.
- The **Projected Area** is the area of the roof plane polyline, including fascia, as seen in plan view. It does not equal the Roof Surface Area unless the pitch is 0.
- The **Roof Surface Area** is the area of the roof plane’s top surface, which covers the fascia, with the pitch taken into account.
- The **Overhang Area** is the area of the roof plane’s overhang, including fascia, with its pitch taken into account.
- The **Projected Overhang Area** is the area of the roof plane’s overhang, including fascia, as seen in plan view.

SELECTED LINE PANEL

The SELECTED LINE panel is similar to the Line panel of the Line Specification dialog. See [Line Panel on page 203](#).

LINE STYLE PANEL

For information about the settings on this panel, see [Line Style Panel on page 204](#).

FILL STYLE PANEL

The settings on the FILL STYLE panel control the appearance of the selected roof plane in plan view. For information about these settings, see [Fill Style Specification Dialog on page 131](#).

ARROW PANEL

The settings on the ARROW panel allow you to control the appearance of the selected roof plane’s slope direction arrow. See [Displaying Roofs on page 572](#).

For information about these settings, see [Arrow Panel on page 205](#).

MATERIALS PANEL

The settings on the MATERIALS panel allow you to specify materials for the selected roof plane’s various components. For more information, see [Materials Panel on page 716](#).

The “Ceiling Surface” component is only available when **Use Room Ceiling Finish** is unchecked and **Has Ceiling**, checked, on the OPTIONS panel. See [Options Panel on page 567](#).

LABEL PANEL

Roof plane labels display when the “Roofs, Labels” layer is turned on and use the Text Style assigned to that layer. See [Roof Plane Labels on page 572](#).

For information about the settings on this panel, see [Label Panel on page 363](#).

COMPONENTS PANEL

The information on the COMPONENTS panel can be used in the materials list. See [Components Panel on page 921](#).

Roof Baseline Polylines

Typically, the program builds an automatic roof based on the settings in the Build Roof dialog and on the ROOF panel of the Wall Specification dialog, along with the layout of the exterior walls and floor and ceiling heights.

If you want to build a roof that diverges from the footprint of your building as well as the roof directives in the exterior walls, you can use Roof Baseline Polylines.

To create roof baseline polylines

1. Select **Build> Roof> Build Roof** .
2. On the BUILD panel of the Build Roof dialog, check **Make Roof Baseline Polylines**.
3. Click **OK**. A set of roof Baselines is created along the outside edge of the Main Layer of the exterior walls, forming one or more closed polylines.

As with roof planes, the heights of Roof Baseline Polylines are determined by ceiling heights in the plan. If roof planes will be built at more than one height, a separate baseline polyline is created for each height.

Once created, a Roof Baseline Polyline can be edited in a variety of ways, then used as the basis for the roof then next time it is built automatically.

To create a new roof using the directives in your Roof Baseline Polyline(s), check **Use Existing Roof Baselines** in the Build Roof dialog and click OK. See [Roof Panel on page 563](#).

DISPLAYING ROOF BASELINE POLYLINES

Roof Baseline Polylines are placed on the “Roofs, Baseline Polylines” layer and use the Text Style assigned to that layer. See [Layer Attributes on page 124](#).

Roof directive information displays along each edge of the polyline, including:

- V - vertical (against wall);
- G -gable/shed;
- K - knee wall;
- L - lower (extend slope downward).

If the directive information includes the pitch, the roof plane slopes toward that edge; if it includes the word (vert), it does not.

EDITING ROOF BASELINE POLYLINES

A Roof Baseline Polyline’s shape can be edited much like a CAD polyline using its edit handles and edit toolbar buttons. See [Editing Closed Polyline-Based Objects on page 155](#).

Roof Baseline Polylines always form a closed area with straight sides only. They cannot be severed or curved, but additional joints or corners can be added.

In addition to length and direction, each Roof Baseline Polyline edge has roof directives associated with it, much like the roof directives in individual walls. See [Roof Directives in Walls on page 252](#).

AN EXAMPLE

In order for it to reflect any changes that you make to a Roof Baseline Polyline, the roof must be rebuilt. For a simple example of Roof Baseline Polyline editing, consider an L-shaped house, with a rectangular roof. The inner part of the 'L' is a patio that is covered under the same roof.

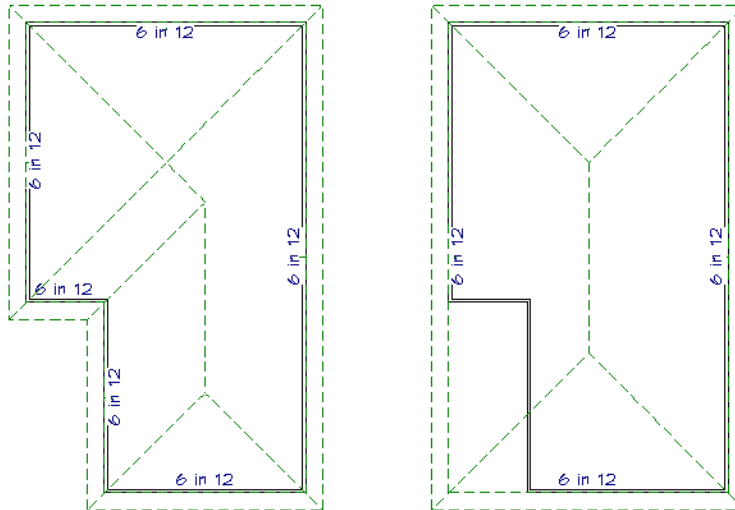

On the left is the baseline polyline as it was originally produced and the roof plan it creates.

To model the roof plan shown on the right

1. Select the Roof Baseline Polyline along its bottom-most edge.
2. Click the **Intersect/Join Two Lines**  edit button. See *Reshaping Objects on page 171*.
3. Click the left-most edge to remove the two intervening edges.
4. A message box informs you that “The system must delete intervening lines (those on the inside of the L) to join the two selected lines.” Click OK.
5. Open the Build Roof dialog and select the **Build Roof Planes** and **Use Existing Roof Baseline** check boxes to model the roof plan shown on the right side of the image above.

Roof Baseline Specification Dialog

 Like walls, each line of a Roof Baseline Polyline contains roof directives that affect automatic roof generation. Select any edge of a Roof Baseline Polyline click the **Open Object** edit button open the Roof Baseline Specification dialog.

ROOF BASELINE PANEL

The settings on the ROOF BASELINE panel control the roof directives associated with the selected edge of the Roof Baseline Polyline. See *Selected Edge on page 142*.

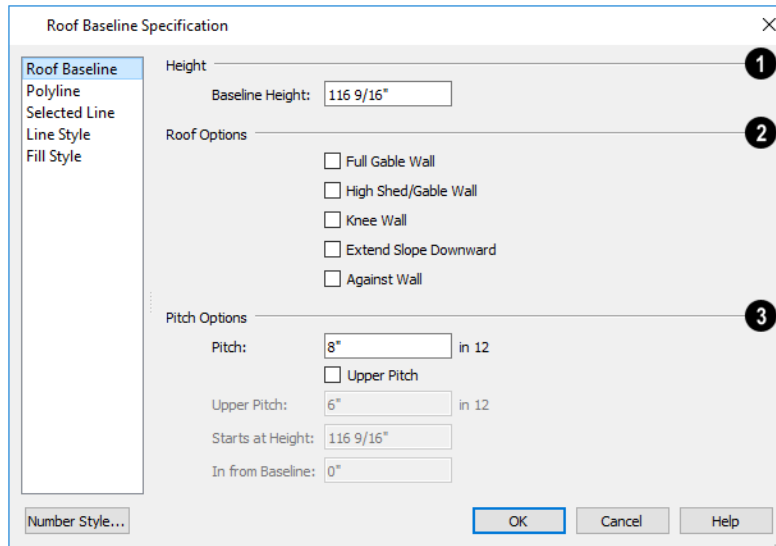

1 Baseline Height

See [The Baseline on page 570](#).

2 Roof Options

- The first six options: **Hip Wall**, **Full Gable Wall**, **Dutch Gable Wall**, **High Shed/Gable Wall**, **Knee Wall**, and **Extend Slope Downward** are the same as those in the Wall Specification dialog. See [Roof Panel on page 266](#).
- Select **Against Wall** if the roof plane rising from this baseline butts against an exterior wall. This is similar to checking High Shed/Gable Wall.

3 Pitch Options

These settings are also found in the Wall Specification dialog. See [Roof Panel on page 266](#).

- Unlike the **Pitch** value elsewhere, this value is not a Dynamic Default here; however, you can click on the Default icon to load the current default Pitch. See [Build Roof Dialog on page 562](#).

POLYLINE PANEL

The POLYLINE panel reports general information about the size and shape of the selected Roof Baseline Polyline. See [Polyline Panel on page 581](#).

SELECTED LINE PANEL

This panel is similar to the LINE panel of the Line Specification dialog. See [Line Panel on page 203](#).

LINE STYLE PANEL

For information about the settings on this panel, see [Line Style Panel on page 204](#).

FILL STYLE PANEL

The settings on the FILL STYLE panel control the appearance of the selected Roof Baseline Polyline in plan view. See [Fill Style Specification Dialog on page 131](#).

Roof and Ceiling Framing

Roof framing can be both drawn manually and generated automatically. You can also combine the two techniques. As with other kinds of framing, it is often easiest to begin by generating roof framing automatically and then editing it as needed. See [Manual vs. Automatic Framing on page 608](#).

Roof Trusses  cannot be generated automatically - they must be drawn manually and then replicated. If you intend to use Roof Trusses, make sure the settings in the Build Roof dialog are properly defined before you build the roof. See [Roof Trusses on page 642](#).

When using a combination of Roof Trusses and stick framing, begin by drawing the roof planes and ceiling planes. When they are in place, draw and replicate the Roof Trusses. Finally, automatically generate or manually draw the stick framing and edit it as needed. See [Mixing Rafters and Trusses on page 610](#).

Framing for manually drawn **Ceiling Planes**  cannot be drawn manually - it must be automatically generated. The framing for manually drawn Ceiling Planes is generated when roof framing is built and uses the settings in the Build Roof dialog as defaults. Once it has been created, it can be edited. See [Ceiling Planes on page 586](#).

REBUILDING ROOF FRAMING

If roof framing defaults are modified after the roof and roof framing are built, neither will update automatically. In order to update the model you need to rebuild the roof, then rebuild the roof framing.

You can also modify the roof framing settings for individual roof planes, and then either build roof framing or click the **Build Framing for Selected Object**  edit button. See [Keeping Framing Current on page 635](#).

Ceiling Planes

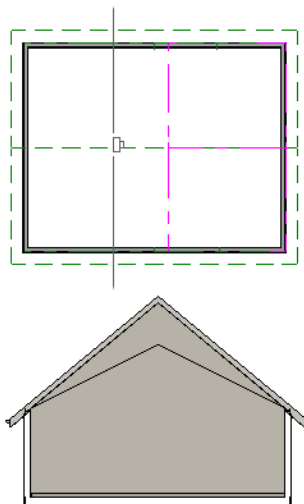

 Ceiling planes are drawn the same way as roof planes and are edited using the same tools. They are useful for creating custom vaulted ceilings. See [Vaulted and Cathedral Ceilings on page 298](#).

Ceiling planes are drawn using the same default pitch as roof planes, specified in the Build Roof dialog. See [Build Roof Dialog on page 562](#).



If you wish, you can specify the desired pitch in the Build Roof dialog before drawing a ceiling plane, or you can change the pitch after it is drawn in the Ceiling Plane Specification dialog. See [Ceiling Plane Specification Dialog on page 587](#).

There are a few things to remember when drawing ceiling planes.

- Ceiling planes should be created over rooms that have **Flat Ceiling Over this Room** unchecked in the Room Specification dialog. See [Structure Panel on page 302](#).
- The Baseline of a ceiling plane should be drawn along the outer surface of the bearing wall's Main Layer. This allows the ceiling plane to extend over and be supported by the wall. See [The Main Layer on page 257](#).
- The sloping edge at the side of a ceiling plane should butt to the inside of the wall.
- Ceiling planes act independent of the roof planes above.
- Usually, the pitch of a ceiling plane is lower than the pitch of the corresponding roof plane.
- Ceiling planes can be joined together using the **Join Roof Planes**  edit button. See [Join Roof Planes on page 576](#).
- Select a ceiling plane and click the **Open Object**  edit button to open the Ceiling Plane Specification dialog. See [Ceiling Plane Specification Dialog on page 587](#).

DISPLAYING CEILING PLANES



Ceiling planes are drawn on the “Ceiling Planes” layer.

Manually drawn **Ceiling Planes**  can also display labels when the “Roofs, Labels” layer is on. See [Roof Plane Labels on page 572](#).

EDITING CEILING PLANES

Ceiling planes can be edited much like roof planes using their edit handles and edit toolbar buttons. See [Editing Roof and Ceiling Planes on page 573](#).

Ceiling planes can also be edited in their specification dialog. See [Roof Plane Specification Dialog on page 578](#).

As with roof planes, the ceiling planes layer can be locked to prevent them from being selected.

DELETING CEILING PLANES

There are several ways to delete ceiling planes. See [Deleting Objects on page 187](#).



Select **Build> Roof> Delete Ceiling Planes** to delete all ceiling planes in the current plan.



Ceiling planes can also be deleted at once in the Delete Objects dialog. See [Delete Objects Dialog on page 188](#).



Select a ceiling plane or group of ceiling planes, then click the **Delete** edit button or press the Delete key.

Ceiling Plane Specification Dialog



Select a ceiling plane and click the **Open Object** edit button to open the Ceiling Plane Specification dialog.

The Ceiling Plane Specification dialog is similar to the Roof Plane Specification dialog. See [Roof Plane Specification Dialog on page 578](#).

The Ceiling Plane Specification dialog has the following panels:

GENERAL PANEL

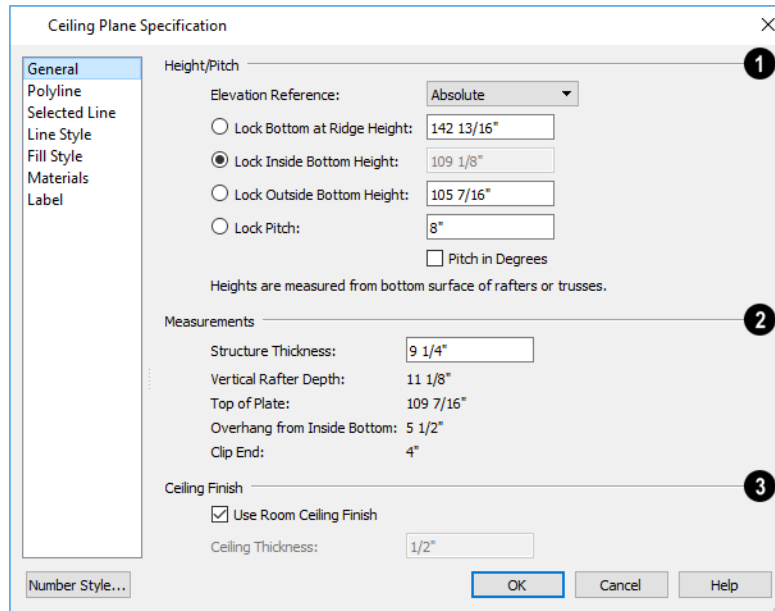

There are four values that define the 3D orientation of a ceiling plane: **Ridge Height**, **Height Inside Wall**, **Height Outside Wall**, and **Pitch**.

Locking any of the **Height** values defines that value as the pivot point for the selected ceiling plane. Each of these dimensions is measured from the first floor default elevation of 0' - 0".

If you lock the **Pitch** and change a Height value, the ceiling plane moves vertically, keeping the same slope. It will not pivot.

Changing these values does not affect the 2D representation of the ceiling plane.

1 Height/Pitch

Specify the **Height** and **Pitch** of the selected ceiling plane. Heights are measured to the bottom surface of the ceiling plane's rafters or trusses, at the center point of the ceiling plane's baseline. See [The Baseline on page 570](#).

- Select the **Elevation Reference**, which is where the Height values below are measured from.
- Define the **Ridge Height**, or lock this value to make it the ceiling plane's pivot point.
- Define the **Height Inside Wall**, or lock this value to make it the ceiling plane's pivot point. If the plane is drawn over a wall, this is located at the inside surface of the wall's Main Layer.
- Define the **Height Outside Wall**, or lock this value to make it the ceiling plane's pivot point. Only available when a ceiling plane is drawn over a wall, this is the height of the lower edge of the ceiling rafters, were they not clipped by the wall below.
- Specify the selected ceiling plane's **Pitch**, or lock this value to move the plane vertically when a Height value is changed.
- Check **Pitch in Degrees** to display the Pitch value in degrees in all dialogs as well as in roof plane labels.

2 Measurements

Information about the structure of the selected ceiling plane(s) displays here for reference.

- Specify the **Structure Thickness**. The default Structure Thickness is the same as that for roof planes and is set in the Build Framing dialog. See *Build Framing Dialog on page 613*.
- The **Vertical Rafter Depth** is defined by measuring a plumb line through the ceiling structure. The greater the pitch, the greater the vertical structure depth.
- The **Top of Plate** value is the top plate height of the bearing wall, and is also the ceiling height of the room.
- **Overhang From Wall Inside** - Only appearing when a ceiling plane is drawn over a bearing wall, this is the horizontal distance from the Baseline to the inside Main Layer surface of the wall. The Baseline is typically drawn over the outside Main Layer surface, so this value is equal to the wall's Main Layer thickness.
- **Clip End** - This is the amount a ceiling rafter's underside must be clipped at its lower end to rest on the wall top plate, and is zero if the ceiling plane was not drawn over a bearing wall. This value is equal to the ceiling plane's rise in slope over the distance of the **Overhang from Inside Bottom**.

The **Outside Bottom** value plus the **Clip end** value equals the **Top of Plate** value.

3 Ceiling Finish

Specify how the **Ceiling Finish** surface on the underside of the selected ceiling plane is built.

- When **Use Room Ceiling Finish** is checked, the selected ceiling plane's ceiling finish thickness and material are defined by the room below and the "Ceiling Surface" component will not be available on the MATERIALS panel. Uncheck this box to define the ceiling finish as part of the ceiling plane and enable the **Ceiling Thickness** option.
- Specify the **Ceiling Thickness**, which is the thickness of the bottom surface of the ceiling plane.

POLYLINE PANEL

The POLYLINE panel states the length of the ceiling plane's **Perimeter**, its **Framing Area**, and its **Projected Area**. See *Polyline Panel on page 581*.

SELECTED LINE PANEL

This panel is similar to the LINE panel of the Line Specification dialog. See *Line Panel on page 203*.

LINE STYLE PANEL

For information about the settings on this panel, see *Line Style Panel on page 204*.

FILL STYLE PANEL

The settings on the FILL STYLE panel affect the appearance of the selected ceiling plane in plan view. For information about these settings, see *Fill Style Specification Dialog on page 131*.

MATERIALS PANEL

The "Ceiling Surface" material can be specified here. It is only available, however, when **Use Room Ceiling Finish** is unchecked on the GENERAL panel.

For more information about the settings on this panel, see *Materials Panel on page 716*.

LABEL PANEL

Ceiling plane labels display when the “Roofs, Labels” layer is turned on and use the Text Style assigned to that layer. The Automatic Label for ceiling planes is blank, but you can specify a custom label. See *Roof Plane Labels on page 572*.

For information about the settings on this panel, see *Label Panel on page 363*.

COMPONENTS PANEL

The information on the COMPONENTS panel can be used in the materials list. See *Components Panel on page 921*.

Gable/Roof Lines



The **Gable/Roof Line** tool can be used to automatically generate a gable above the bearing wall of a hip roof plane. It is best used in situations where roof directives in walls are not possible. For example:

- Where a wall is not present, such as across the front of an alcove;
- Over a Bay, Box, or Bow Window.

See *Roof Directives in Walls on page 252*.





In addition, the **Gable Over Door/Window** edit button allows you to add a small Gable/Roof Line over one or more selected doors or windows the next time automatic roof planes are built.

Gable/Roof Lines display in plan view when the “Roofs, Gable Lines” layer is set to display and can be selected and edited much like regular CAD lines. See *Editing Line-Based Objects on page 145*.

CREATING A GABLE

To create a gable using a Gable/Roof Line

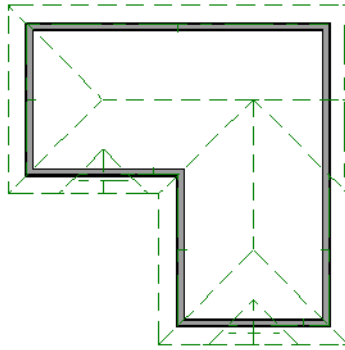

1. Select **Build> Roof> Gable/Roof Line** , then click and drag to draw a line outside of the exterior wall that you want to create a gable over.
2. Position the Gable/Roof Line within 10 feet (2260 mm) of the wall’s Main Layer but not touching it. See *The Main Layer on page 257*.
 - Make sure that the Gable/Roof Line is exactly parallel to the exterior wall.
3. Resize the Gable/Roof Line so that it is the length of the desired gable.
 - The length of the Gable/Roof Line determines the gable width at the wall Main Layer, not at the overhang.
 - At the larger roof eave, a gable roof is wider than the gable line by twice the overhang distance.
4. You can specify the pitch of the gable roof planes and their overhang in the Gable Line Specification dialog. See *Gable Line Specification Dialog on page 593*.
5. Select **Build> Roof> Build Roof**  and regenerate the roof. See *Build Roof Dialog on page 562*.

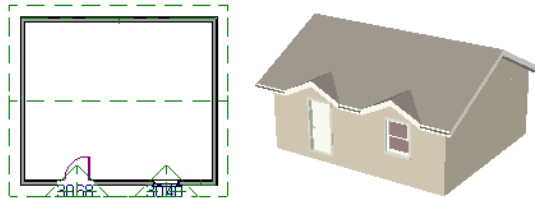

To use the Gable Over Door/Window tool

1. Select one or more doors or windows.
2. Click the **Gable Over Door/Window**  edit button.
 - **Gable Over Door/Window** is not available for openings placed in Full Gable Walls or for Bay, Box or Bow Windows. See *Bay, Box, Bow Windows and Roofs* on page 424.
3. In the Gable Line Specification dialog, specify the desired Pitch and Overhang for the gable roof. See *Gable Line Specification Dialog* on page 593.
4. The next time automatic roof planes are built, gables will be created over each of these doors and windows.



- Each gable will extend 12” (300 mm) on either side of its door or window.
 - If two of these openings are within 30” (750 mm) of each other on the same wall, a single gable will be created.
 - If you move or resize the door or window(s), the associated Gable/Roof Line will not update until the roof is built again.
5. To remove a Gable Over Door/Window, select the door(s) or window(s) and click the **Delete Gable Over Opening**  edit button, or select the gable line and click the **Delete**  edit button. The next time the roof is built, the gable will be removed.

COVERING AN ALCOVE

A **Gable/Roof Line**  can also be used to maintain a roof plane baseline where there is no wall below. For example, you can use it to extend a roof plane across an alcove, rather than wrap into it.

In order for a **Gable/Roof Line** to direct the roof to extend over an alcove or other area where no wall is present, it must be aligned with the exterior walls’ Main Layer.

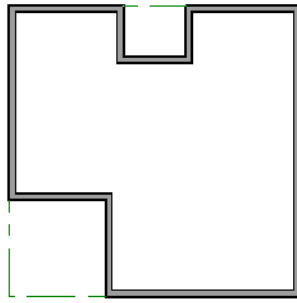

COVERING A BAY

A **Gable/Roof Line**  drawn across a bay causes a gable to be built above the bay when roofs are automatically generated.

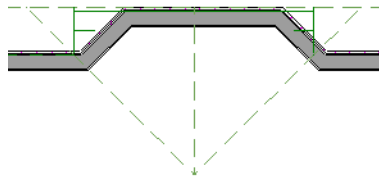

In order for the gable to be built, at least one end of the Gable/Roof Line must extend past the side walls of the bay.

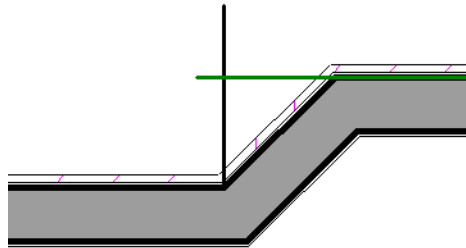

If the Gable/Roof Line is drawn along the outer edge of the bay's outer wall's Main Layer, the resulting gable will extend only to the eave of the larger roof. Draw the Gable/Roof Line beyond the bay's outer wall to extend out past the larger roof's eave.

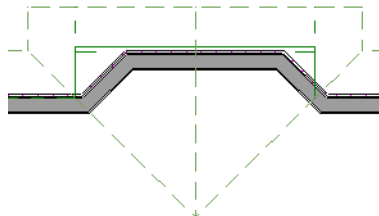

Gable Line Specification Dialog

Select a gable line and click the **Open Object** edit button to open the Gable Line Specification dialog. This dialog also opens whenever the **Gable Over Door/Window**  edit button is clicked. See [Gable/Roof Lines on page 590](#).

GABLE LINE PANEL

The settings on this panel affect the structure of the two roof planes associated with the selected Gable/Roof Line.

The defaults for these settings are set in the Build Roof dialog. See [Roof Panel on page 563](#).

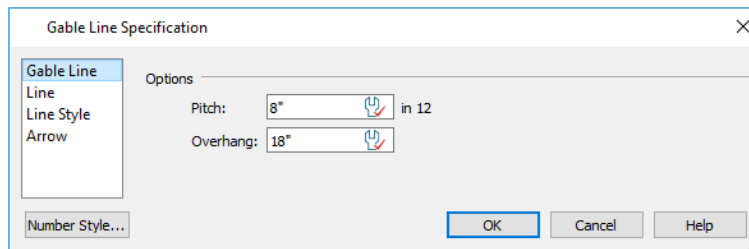

- Specify the **Pitch** of the roof planes that form the gable.
- Specify the **Overhang** of the roof planes that form the gable.

LINE PANEL

The settings on the LINE panel are available for a variety of other objects in the program. See [Line Panel on page 203](#).

LINE STYLE PANEL

The settings on the LINE STYLE panel are available for a variety of other objects in the program. See [Line Style Panel on page 204](#).

ARROW PANEL

The settings on the ARROW panel are available for a variety of other objects in the program. See [Arrow Panel on page 205](#).

Skylights and Roof Holes



A skylight can be created by selecting **Build> Roof> Skylight** and drawing a rectangular polyline within a single roof plane. You can also simply click once within a roof plane to place a 2' x 2' skylight. These measurements describe the skylight's projected size, as measured in plan view: roof pitch is not taken into account.

The **Skylight**  tool places a flat panel skylight into a roof hole, produces a hole in the ceiling platform below, and automatically generates the skylight shaft between these two holes.

To place a skylight in a vaulted ceiling, uncheck **Flat Ceiling Over This Room** in the Room Specification dialog, draw the ceiling planes to produce the vault and edit them as needed, and then draw the skylight. See [Structure Panel on page 302](#).

Note: If a sloped ceiling plane is present under the skylight, a hole in this ceiling plane is automatically produced. This hole is visible, and may be located directly under the roof hole. It can be moved and edited separately.

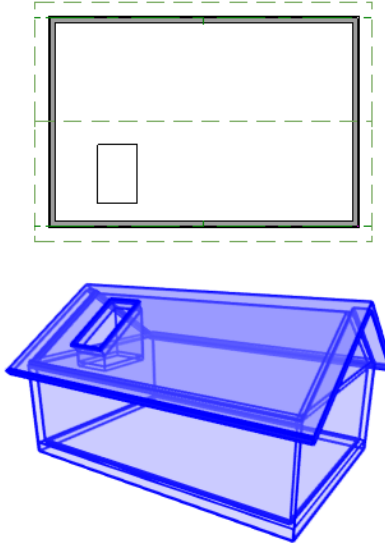

Skylights and roof holes are placed on the "Roofs, Openings" layer. See *Displaying Objects on page 123*.

Although inserted into roof planes, skylights and roof holes are able to display in both plan and 3D views when their containing roofs do not.

EDITING SKYLIGHTS

Skylights can be selected individually or in groups and can be edited using the edit handles, edit toolbar buttons, or the Roof Hole/Skylight Specification dialog. See *Roof Hole/Skylight Specification Dialog on page 594*.

Skylights must always be contained by a single roof plane. If the roof plane is deleted, any skylights or holes it contains are also deleted. Aside from this restriction, skylights can be edited much like standard closed polylines. See *Editing Closed Polyline-Based Objects on page 155*.

If you clear the **Skylight** check box in the Roof Hole/Skylight Specification dialog, the curb and glass for the skylight is removed but the opening remains.

Roof Hole/Skylight Specification Dialog

- ☐ Select a skylight and click the **Open Object** edit button to open the Roof Hole/Skylight Specification dialog. See *Skylights and Roof Holes on page 593*.

GENERAL PANEL

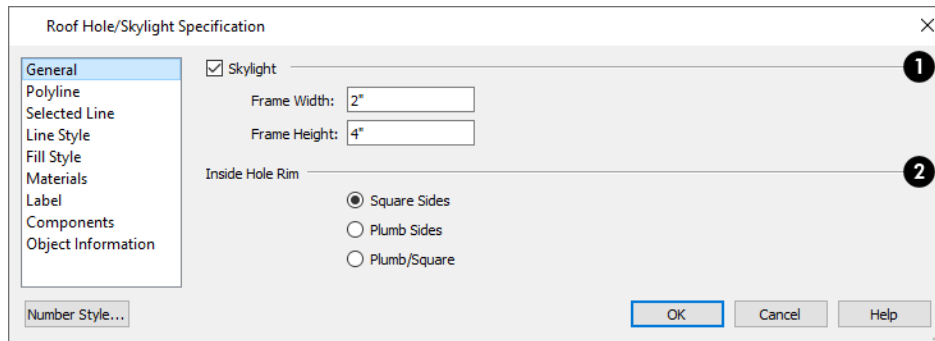

1 Skylight

- Check **Skylight** to specify this polyline as a skylight. If unchecked, the curb and glass for the skylight are removed but the opening remains.
- Specify the **Frame Width** and **Height** of the selected skylight. These values describe the skylight's projected size, as measured in plan view: roof pitch is not taken into account.

2 Inside Hole Rim

Specify how the hole for the skylight is framed as well as the shape of the skylight well where it passes through the roof plane.

- Select **Square Sides** to cut the framing for the skylight square to the pitch of the roof.
- Select **Plumb Sides** to produce framing for the skylight that is plumb-cut.
- Select **Plumb/Square** to produce framing with the bottom edge plumb-cut and the top edge, square-cut.

POLYLINE PANEL

The POLYLINE panel states the roof hole/skylight's **Perimeter**, its **Framing Area**, and its **Projected Area**. See [Polyline Panel on page 581](#).

SELECTED LINE PANEL

This panel is similar to the LINE panel of the Line Specification dialog. See [Line Panel on page 203](#).

LINE STYLE PANEL

For information about the settings on this panel, see [Line Style Panel on page 204](#).

FILL STYLE PANEL

The settings on the FILL STYLE panel control the appearance of the selected roof hole or skylight in plan view. See [Fill Style Specification Dialog on page 131](#).

MATERIALS PANEL

For information about the MATERIALS panel, see [Materials Panel on page 716](#).

LABEL PANEL

Roof hole and skylight labels display when the “Roofs, Labels” layer is turned on and use the Text Style assigned to that layer. The Automatic Label for these objects is blank, but you can specify a custom label. See *Roof Plane Labels on page 572*.

For information about the settings on this panel, see *Label Panel on page 363*.

COMPONENTS PANEL

The information on the COMPONENTS panel can be used in the materials list. See *Components Panel on page 921*.

Dormers and Crickets



Dormers can be drawn manually or placed automatically using the **Auto Dormer** tools. Automatic Dormers can be placed only under certain conditions:

- Automatic Dormers can only be placed entirely within a single roof plane. They cannot extend past the eaves or ridge of this roof plane.
- Automatic Dormer side walls cannot be positioned above other walls in the plan.

If you click within a roof plane to place an automatic dormer, but click too close to an eave or the ridge, a dormer will not be created; however, its outline will. Move this outline box to a location that meets the dormer’s requirements and it will be created.

Automatic dormers reside by default on their own layer, “Auto Dormers”. Their display cannot be turned off; however, you can lock this layer to prevent unintended editing. See *Layer Display Options Dialog on page 126*.

The initial width, height, roof style and other settings of Auto Dormers are set in the Dormer Defaults dialog. See *Dormer Defaults on page 558*.

AUTO FLOATING DORMER



Select **Build> Roof> Auto Floating Dormer** and click the roof plane where you would like to place the center of the dormer's front wall.

The bottom edges of all floating dormer walls are cut off by the underlying roof plane. To produce such a dormer manually, check **Roof Cuts Wall at Bottom** for the dormer walls on the ROOF panel of the Wall Specification dialog.

Usually, no room is defined by the walls of this type of dormer.

The images below show both the outside and inside of a typical floating dormer.

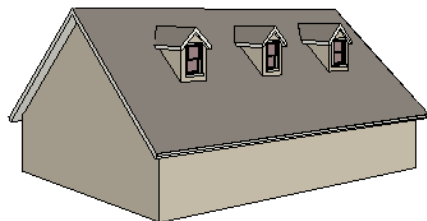

A floating dormer can be placed in plan view on the same floor that its underlying roof plane displays on, or it can be placed on the floor above. Normally, it does not matter what floor the dormer is on; but in some cases, it may need to be on the floor above so that the dormer walls do not interfere with walls or railings in the room below.

Regardless of which floor it is placed on, a dormer must always fit within a single roof plane. When placing a dormer on the floor above, you may find it helpful to turn on the **Reference Display** . See [The Reference Display](#).

You may also find it helpful to display the underlying roof plane on the floor above using the Roof Plane Specification dialog. See [Roof Plane Specification Dialog on page 578](#).

If the dormer is placed on the same floor as the underlying roof plane and the room below, and if the room has a flat ceiling, then a hole will be produced in the ceiling under the dormer.

AUTO DORMER



Select **Build> Roof> Auto Dormer** and click on a roof plane where you want the center of the dormer's front wall to be.

The walls of an auto dormer go to the floor and meet a knee wall on either side on the back of the dormer. This knee wall must run parallel to the underlying roof plane's Baseline.

- If you are creating a (non-floating) auto dormer, a knee wall must already exist. The dormer side walls run back to the knee wall and the knee wall is broken where the dormer walls meet it.
- The knee wall does not have to be designated as such in the Wall Specification dialog unless you are generating an automatic roof. See [Knee Walls on page 254](#).
- A non-floating dormer must always be created on the same floor as the knee walls.

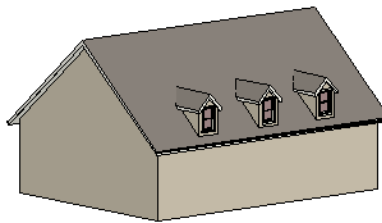
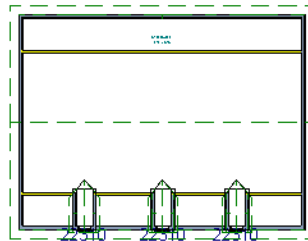

MANUALLY DRAWN DORMERS

Once you are familiar with Home Designer Pro's roof tools, drawing dormers manually can be quite simple. There are several different ways to draw dormers; some methods work better in certain applications.

A variety of resources with information about drawing dormers manually is available at HomeDesignerSoftware.com.

There are a few things to keep in mind.

- Walls extend upward until they meet an overlying roof plane.
- A wall can also be cut by underlying roof planes if **Roof Cuts Wall at Bottom** is checked in the Wall Specification dialog. For this to work properly, the edge of the roof plane must extend completely through the width of the wall. See *Clerestory and Dormer Walls on page 253*.
- Polyline can be converted into a **Hole in Roof/Ceiling** that allows walls to extend above or below the roof line. See *Convert Polyline on page 179*.

MANUALLY DRAWN CRICKETS

The automatic roof generator will not produce crickets in a roof plan; however, you can manually draw a cricket using the **Roof Plane**  tool.

Editing Auto Dormers

Auto Dormers are a collection of objects that behave as one. When a dormer is selected, it can be edited using its edit handles, edit tools, and specification dialog. See *Dormer Specification Dialog on page 599*.

If you click the **Explode Dormer**  edit button, the dormer's individual components can be edited.

USING THE EDIT HANDLES

When selected, an auto dormer displays three edit handles. The Move handle displays over the front wall and allows you to relocate the dormer. Two resize handles display on the side walls and allow you to change the width of the dormer.

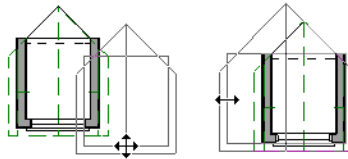

There are some things to keep in mind when editing auto dormers and auto floating dormers using the mouse.

- Dormers move at 90° angles unless the Ctrl key is pressed before moving them.
- The dormer must be contained within one underlying roof plane.
- Auto dormers cannot be moved beyond the required knee wall.

EDITING THE WINDOW

Dormer windows can be selected, edited, deleted and replaced just like other windows. See *Editing Windows on page 403*. You can place several windows in the front wall.

Unless the dormer's window has been edited or changed in the Window Specification dialog, when the dormer width is changed, its width changes automatically to fill the front dormer wall. If the window has been edited, its width stays fixed. If a change to the dormer makes its front wall too short to hold the window, the window reverts to auto width.

EXPLODING DORMERS



Click the **Explode Auto Dormer** edit button to explode a selected auto dormer into its component parts. The dormer walls, roof planes, window, and hole in the roof/ceiling can be edited individually.

The program treats roof planes over an exploded auto dormer as though they were manually drawn, allowing you to protect them from being rebuilt in the Build Roof dialog. See [Roof Panel on page 563](#).

Once exploded, it is not possible to block the components into a Dormer object again.

Dormer Specification Dialog



Select a dormer or dormers and click the **Open Object** edit button to open the Dormer Specification dialog.

The settings in this dialog are also found in the Dormer Defaults dialog, where they apply to all dormers as they are created rather than to a selected dormer.

ROOF PANEL

1 Roof Style

- Choose a roof **Type** from the drop-down list. You can choose from Hip, Gable, Shed, Gambrel, Mansard, Barrel, Curved Eave, Hip Curved Eave or Eyebrow.

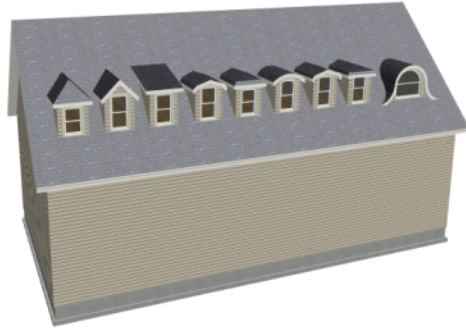

2 Pitch

- Specify the **Pitch** of the dormer roof planes. The default dormer pitch applies to all dormer roof types except Shed, which has a default 3 in 12 pitch. For Gambrel and Mansard types, this applies to the lowest, or eave, roof planes.
- Check **Pitch in Degrees** to display the pitch in degrees in all dialogs as well as in roof plane labels; uncheck it to display the pitch in terms of rise and run. See *Roof Pitches in Degrees on page 604*.
- The **Second Pitch** specifies the upper roof of a Gambrel, Mansard, curved eave, and hip curved eave.
- When a Second Pitch is used, specify the **In from Eave** distance, measured from the lower roof plane eave to where the upper roof plane starts.

3 Roof Overhang

Specify the depth of the selected dormer's **Eave** and **Gable Overhangs**.

4 Fascia/Rafters

- Specify the **Fascia Depth** for gable fascia and the **Eave Fascia Depth**.
- Specify the **Rafter Depth**.
- The **Vertical Rafter Depth** displays for reference.
- Specify whether to **Include Boxed Eaves** and/or **Gutters**
- Select either **Plumb** or **Square Rafter Cut**.

5 Auto Roof Returns

See *Roof Returns on page 601*.

- Check **Auto Roof Returns** to generate roof returns on the selected dormer. Roof Returns can be only specified for Gable dormers.
- Specify the horizontal **Length** of the roof return in inches (mm).
- Enter a value in inches (mm) to **Extend** the roof returns past the dormer overhang.
- Specify a **Gable**, **Hip**, or **Full** roof return.
- Specify a **Sloping** or **Flat** roof return.

WALLS PANEL

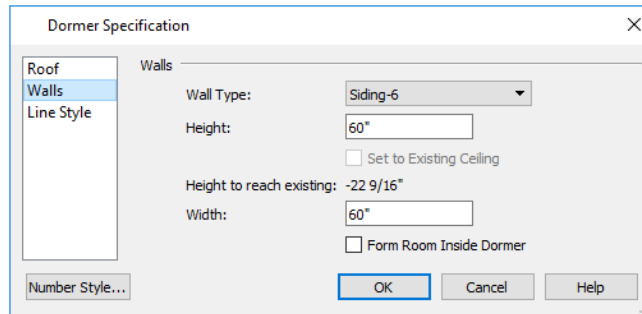

- Select a **Wall Type** for the dormer walls from the drop-down list.
- Specify the **Height** of the dormer, as measured from where the top of the underlying roof plane meets the dormer front wall exterior to the top plate of the dormer roof's bearing walls.

This top height is called the dormer ceiling height, even if the ceiling in the dormer is not flat. The top dormer window casing is usually close to this height.

- Check **Set to Existing Ceiling** to assign the ceiling height of the room behind the dormer to the dormer. Not available in the Dormer Defaults dialog.
- **Height to Reach Existing** shows the difference between the dormer height where the inside of the wall meets the underside of the roof and the ceiling of the room behind it.
- Specify the dormer's **Width**, measured from the outside surfaces of the dormer side walls.
- **Form Room Inside Dormer** is used only for floating dormers and creates a flat ceiling in the dormer. If you check this option, you should define the dormer on the floor above the room it is positioned over. If this room has a flat ceiling, checking this option makes a hole in the ceiling under the dormer. This option should normally be left unchecked.

Dormer windows can appear too narrow on the outside due to the space required for interior casing to clear the inside surfaces of the side walls. Two additional settings are available in the Dormer Defaults dialog to help address this.

- When **Set Inside Window Trim Width** is checked, you can set the **Inside Window Trim** value, which is the default interior casing width for dormer windows. When unchecked, dormer windows use the default interior casing width set in the Window Defaults dialog.

LINE STYLE PANEL

For information about the settings on this panel, see [Line Style Panel on page 204](#).

Roof Returns and Other Details

Home Designer Pro offers a selection of tools to add architectural details to your roof design.

ROOF RETURNS

A roof return is a small decorative roof plane that connects to the low side of a gable roof overhang and extends below the upper triangular portion of the gable wall. Three styles of roof returns that can be produced automatically.

The first two styles are called **Gable** and **Hip** returns since the return ends in a gable or hip.

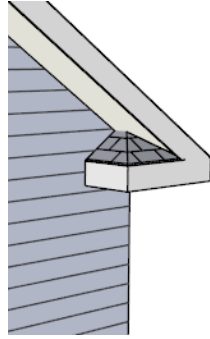

The third is called a **Full** return because it extends under the entire gable to connect both sides and is sometimes referred to as a water table. In order for a Full return to be created, the roof planes on each side must have the same Fascia Top Height.

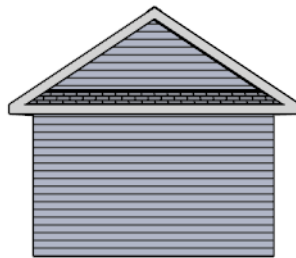

It is not difficult to manually draw roof returns using small roof planes, but it is quicker to produce them automatically. Roof returns are generated automatically on a wall by wall basis using settings in the Wall Specification dialog. See [Roof Panel on page 266](#).

These roof return settings are also found in the Dormer Specification dialog for gable roof dormers and function similarly. See [Roof Panel on page 599](#).

The pitch of an automatically generated roof return is the same as that of the roof plane above it. Its structure is the same as that of the subfascia and eaves of the roof plane above. See [Structure Panel on page 581](#).

BOXED EAVES

Boxed eaves have a flat, horizontal soffit surface instead of one that follows the underside of the rafter ends. Boxed eaves can either extend out to the gable fascia or build flush with the adjacent exterior wall.

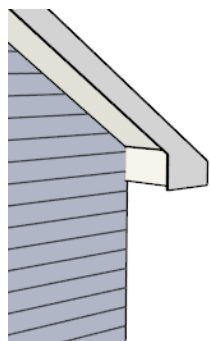

You can specify Boxed Eaves for all roof planes in the Build Roof dialog and for individual roof planes in the Roof Plane Specification dialog. See [Options Panel on page 567](#).

The flush eave end uses the wall's surface material by default; however, you can specify a different material if you wish. See [Materials Panel on page 569](#).

FASCIA

Fascia can be added to both automatic and manually drawn roof planes. They can be specified in the Build Roof dialog and added to roof planes as they are created, and they can be added to or removed from individual roof planes in the Roof Plane Specification dialog.

- Fascia and eave fascia can be specified in the Build Framing and Build Roof dialogs. See [Roof Panel on page 624](#).
- Fascia is generated whenever the roof is built or rebuilt.
- Fascia can be specified. See [Materials Panel on page 569](#).

Fascia display in 3D views and are included in the materials list.

Fascia

The material specified for fascia in the Build Roof dialog displays as part of the roof plane rather than as a separate object. It displays in 3D views but not plan view.

In addition, sub fascia boards are created when roof framing is generated and are placed on the “Framing, Roof Rafters” layer. The fascia material is not applied to these framing members, however.

The width and depth of fascia and eave fascia can be specified in the Build Framing dialog. See [Roof Panel on page 624](#).

SOFFITS

Soffits are the layer of material that covers the rafter ends on the underside of roof eaves and can be constructed in either of two ways:

- By default, soffits follow the underside of the rafter ends and butt against the inside edge of the fascia. The rafter end depth and thus the soffit height is controlled by the Gable Sub Fascia Depth. See [Roof Panel on page 624](#).
- Boxed eaves can be specified in the Build Roof and Roof Plane Specification dialogs. Boxed eave height is controlled by the Eave Sub Fascia Depth. See [Options Panel on page 567](#).

GUTTERS

Gutters are added to non-sloping eaves on both automatic and manually drawn roof planes when **Gutters** is checked in the Build Roof dialog. They can also be added to or removed from individual roof planes in the Roof Plane Specification dialog. See [Options Panel on page 567](#).

Gutters are placed on the “Roofs, Gutters” layer. By default, this layer is turned on in 3D views but not in plan view, is included in the materials list, and is locked. See [Layer Display Options Dialog on page 126](#).

Roof Pitches in Degrees

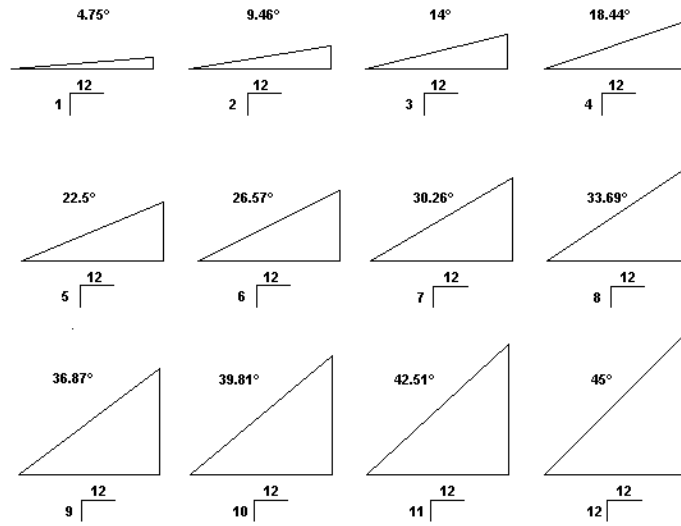

Framing

Chapter 23

In Home Designer Pro, framing can be produced both manually and automatically, and can be calculated in the Materials List.

Manual framing members are drawn by clicking and dragging, like drawing a CAD line. Automatic framing for the major components of a 3D model (floors, ceilings, walls and roofs) can be generated using the Build Framing dialog.

Both manually drawn and automatically generated framing members can be selected and edited in 2D and 3D views.

Trusses are covered in their own chapter, *Trusses on page 641*.

TOPICS

Framing Defaults	606
Manual vs. Automatic Framing	608
Framing Tools	611
Build Framing Dialog	613
Framing Reference Markers	628
Joist Direction Lines	630
Joist Direction Specification Dialog	630
Bearing Lines	631
Displaying Framing	632
Editing Framing	634
Keeping Framing Current	635
Framing and the Materials List	636
Framing Specification Dialog	637

Framing Defaults



Select **Edit > Default Settings** to open the Default Settings dialog. Select Framing from the list, then click the **Edit** button to open the Framing Defaults dialog.

Both automatic and manually-drawn framing are generated according to the settings in the Framing Defaults dialog. This dialog is nearly identical to the Build Framing dialog in both appearance and function. The only difference is that the Build Framing dialog has check boxes that allow you to generate different types of framing automatically. See [Build Framing Dialog on page 613](#).

Any changes made in the Framing Defaults or Build Framing dialog will affect subsequently drawn or generated framing, but not framing already present in the plan.



The settings in the Framing Defaults dialog directly affect a variety of important structural elements in each plan which determine floor, ceiling and roof heights; so it is best to set your Framing Defaults before building your model. See [Drawing a Plan on page 25](#).

FLOOR AND CEILING FRAMING

Floor and ceiling platform depths contribute to the overall height of a structure, so their default values should be set as early as possible. See [Floor Panels on page 614](#).

If you plan to draw floor trusses, also see [Trusses Panel on page 626](#).

The default floor and ceiling platform settings for a given floor can be overridden on a room by room basis in the Room Specification dialog, or for individual platforms using **Joist Direction**  lines. See [Structure Panel on page 302](#).

By default, automatically-generated floor and ceiling joists run in the direction that results in the shortest span between exterior walls and/or beams. **Joist Direction**  lines also allow you to define the direction that joists in a particular floor or ceiling platform. See [Joist Direction Lines on page 630](#).

In standard light frame construction, floor and ceiling platforms are built to pass over or bear on the wall framing; however, this is not always desired. You can specify that joists bear on a selected wall, that platforms hang on it, or that a wall build through platforms in the Wall Specification dialog. See [Structure Panel on page 264](#).

WALL FRAMING

Like other types of framing, wall framing is generated based on settings in the Framing Defaults dialog. See [Wall Panel on page 618](#) and [Openings Panel on page 620](#).

In addition, wall framing is dependent on settings from other sources:

- Framing Type, Spacing, Width, and more can be specified for each Wall Type in the Wall Type Definitions dialog. See [Wall Type Definitions Dialog on page 259](#).
- The structural specifications for individual walls can be set in the Wall Specification dialog. See [Structure Panel on page 264](#).

ROUGH OPENINGS

The rough openings, trimmers, and sills for doors and windows and legacy fireplace objects are set in their respective defaults and specification dialogs. See:

- [Door Specification Dialog on page 378](#)
- [Window Specification Dialog on page 404](#)
- [Fireplace Specification Dialog on page 497](#)

Note: Door and window bucks do not automatically generate in concrete or block walls.

HEADERS

The size, position, and composition of door and window headers can also be set in their respective defaults and specification dialogs.

In addition, a range of header depths for openings of different widths can be specified in the Framing Defaults dialog. Check **Calculate from Width** in the Door and Window Defaults dialogs to assign header depths to openings based on their width. See [Openings Panel on page 620](#).

Like other framing members, headers are assigned a Structure Type such as “Lumber” or “LVL”. By default, the program will try to ensure that an opening’s Header Type agrees with the framing material used by the wall it is inserted into. To do this, it compares the Header Type to the wall’s framing material:

- Wood framing types: Lumber, I-Joist, Glulam, Engineered Lumber, LVL, PSL, and VSL.
- Steel framing types: Steel I, Steel Box, C Channel, and U Channel.

If the Header Type agrees with the wall framing material, it will be unchanged; however, if it does not agree it will change to either “Lumber” in a wood-framed wall or “C-Channel” in a steel-framed wall. To prevent this from occurring and use the specified Header Type regardless of wall material, uncheck Automatic. See [Structure Types on page 636](#).

Box headers with top and bottom rails can also be specified. See [Framing Panel on page 390](#).

SILL PLATES

Sill plates are created when floor framing is generated. They are created over all exterior walls that have either Concrete or Brick material type as their Main Layer material and support a floor platform or a framed wall directly above. See [The Main Layer on page 257](#) and [Materials and the Materials List on page 723](#).

Sill plate size and number can be specified in the Wall Specification dialog of the supporting masonry wall. Only the bottommost plate that comes into contact with masonry is specified as **Treated**. See [Foundation Panel on page 268](#).

These sill plates are placed on the “Framing, Sill Plates” layer. See [Displaying Framing on page 632](#).

When a monolithic slab foundation is created, the bottom plates of framed walls built on the slab are specified as **Treated** and are placed on the “Framing, Wall” layer.

As with sill plates, multiple bottom plates can be specified in the Framing Defaults dialog, but only the bottommost plate is specified as **Treated**. See [Wall Panel on page 618](#).

POSTS AND BEAMS

The Post, Floor Beam, and Roof Beam Defaults dialogs can be accessed via the BEAMS and POSTS panels of the Framing Defaults dialog.

These defaults can also be accessed by double-clicking the respective drawing tools. In addition, the Deck Post and Deck Beam Defaults dialogs are similar, and can be accessed from the Deck Room Defaults dialog. See [Room Type Defaults on page 281](#).

ROOF FRAMING

Settings on the ROOF and TRUSSES panels of the Framing Defaults dialog determine the structure of roof planes and manually drawn ceiling planes as well as how they rest on bearing walls, so it is important that their default values be set before building the roof. See [Roof Panel on page 624](#) and [Trusses Panel on page 626](#).

If changes are made to these defaults that you need to apply to the entire roof plan, you will need to rebuild the entire roof - not just the roof framing. See [Roofs on page 556](#).

DECK FRAMING

Deck rooms have special automatically generated framing and are not affected by the settings in the Framing Defaults or Build Framing dialogs. Deck framing defaults are set in the Deck Room Defaults dialog. See [Decks on page 292](#).

FRAMING TYPES

By default, most framing is set to use “Lumber” as the material type. You can select from a number of other types, however, such as I-Joist and Glulam. See [Structure Types on page 636](#).

Manual vs. Automatic Framing

Platform, roof, and wall framing can be produced manually or automatically. In most cases, automatically-generated framing is preferable because it is faster than manually placing, replicating and editing numerous individual framing members.

In many plans, though, framing is drawn using both approaches. For example, a combination of automatically generated rafters and manually drawn trusses can be used to model a roof framing plan. See [Mixing Trusses with Stick Framing on page 647](#).

Regardless of how it is created, individual framing members can be selected and edited. See [Editing Framing on page 634](#).

- [Automatic Framing on page 608](#)
- [Manual Framing on page 609](#)
- [Framing with Beams on page 610](#)
- [Mixing Manual and Automatic Framing on page 609](#)
- [Mixing Rafters and Trusses on page 610](#)

AUTOMATIC FRAMING

Automatic framing of floor and ceiling platforms, walls and roofs can be generated using the Build Framing dialog. The settings in this dialog control the size, spacing, and type of framing drawn in a plan, and related structural information for the major components of the 3D model. See [Build Framing Dialog on page 613](#).



Automatic framing of a particular structural component is not generated until the Build Framing dialog is opened to the appropriate panel and one of two check boxes selected:

- Select the **Build** check box to build automatic framing once. For example, check **Build Wall Framing** on the WALL panel, then click OK to build wall framing once based on the current state of the model.

- Select the **Automatic** check box, then click OK to build automatic framing every time a change is made to that structural component in the plan. For example, check **Automatic Wall Framing** on the WALL panel to rebuild all wall framing any time a wall is affected by changes to the model.

Note: When Automatic framing of a particular type is enabled, framing of that type cannot be manually edited or deleted.



In order for framing to generate in a particular layer of a structural component such as a wall assembly or floor platform, that layer must have the Framing specification. See *Wall Type Definitions Dialog on page 259* and *Material Layers Definition Dialogs on page 709*.

By default, joists automatically generate in the direction that results in the shortest span; however, you can produce different results using **Bearing Lines** , **Floor/Ceiling Beams** , and/or **Joist Direction**  lines. See *Bearing Lines on page 631* and *Joist Direction Lines on page 630*.

MANUAL FRAMING

Framing objects can also be drawn manually. With the exception of Posts, framing objects are drawn by clicking and dragging in a straight line, the way other line-based objects are. See *Line Tools on page 199*.

The manual framing tools are organized into families: general framing, floor and ceiling framing and roof framing. The family that a drawing tool belongs to determines where it can be used:

- Roof framing objects can only be drawn within the area of one or more roof planes.
- Floor and ceiling framing objects can only be drawn within one or more floor or ceiling platforms.
- **General Framing**  objects and **Posts**  can be drawn anywhere in a model.

REBUILDING AND RETAINING FRAMING

It is important to remember that by default, framing does not update automatically when changes are made to the model. For example, if a door is moved or resized, wall framing must be rebuilt. If the footprint is enlarged, the wall framing and any roof or platform framing that is affected must be rebuilt.

You can direct the program to rebuild the automatic framing of floors/ceilings, walls and/or roofs every time a change to the model affects one of these components. To do this, select the **Automatic** check box on the FLOOR, WALL, and/or ROOF panels of the Build Framing dialog.

To learn more, see *Keeping Framing Current on page 635*.

When automatic framing associated with a particular panel in the Build Framing dialog is generated, any existing automatically produced framing of that type is deleted and replaced. You can prevent this from happening to a selected wall or roof or ceiling plane by checking **Retain Wall Framing** or **Retain Roof Framing** in the object's specification dialog.

MIXING MANUAL AND AUTOMATIC FRAMING

Floor and ceiling platforms can be framed with a combination of manually-drawn and automatically generated joists. Similarly, roof planes can be framed with a combination of manually drawn and automatic rafters.

If you plan to use this approach, bear in mind that automatically generated joists and rafters will not be created in the same location as an existing, manually drawn joist or rafter; but, they will not necessarily use the same layout. For consistent layout, consider using a **Framing Reference Marker** . See *Framing Reference Markers on page 628*.

Manually drawn floor, ceiling, and roof framing is unaffected when automatic framing is rebuilt and remains along with the newly produced automatic framing. In contrast, manually drawn wall framing is deleted when automatic framing is rebuilt. You can, however, prevent this from happening by checking **Retain Wall Framing** in the Wall Specification dialog.

MIXING RAFTERS AND TRUSSES

- Roofs can be framed with rafters, trusses, or a combination of the two. If you plan to combine roof trusses with rafters and/or ceiling joists, you can save time by:
- Check **Trusses (No birdsmouth)** in the Build Roof dialog before automatically building or manually drawing a roof. See *Build Roof Dialog on page 562*.
- Draw and position all roof trusses before automatically generating framing to produce rafters and ceiling joists. See *Roof Trusses on page 642*.

For more information, see *Mixing Trusses with Stick Framing on page 647*.



FRAMING WITH BEAMS

Floor/Ceiling Beams  can be drawn in a plan either before or after automatic framing has been generated. Default settings for beams can be set in the Framing Defaults dialog. See *Beams Panel on page 622*.



If a Floor/Ceiling Beam is present and wall framing is generated, posts will be placed under the beam in any walls that pass under it and studs and top plates will build around the beam as necessary.



If a Floor/Ceiling Beam is created before automatic floor or ceiling framing, you can specify whether joists bear on the beam or hang on its sides.

To build joists that bear on a beam

1. Draw a **Floor/Ceiling Beam**  at the desired location in your plan.
2. Select the beam and click the **Open Object**  edit button. On the GENERAL panel of the Beam Specification dialog, confirm that:
 - The **Top Height** value is equal to the Ceiling Height of the room(s) over which the beam is placed.
 - **Bearing Beam** is checked.
3. Click OK, then select **Build> Framing> Build Framing**  and build the appropriate floor or ceiling framing. See *Floor Panels on page 614*.

To build joists that butt against a beam

1. Draw a **Floor/Ceiling Beam**  at the desired location in your plan.
2. Select the beam and click the **Open Object**  edit button. On the GENERAL panel of the Beam Specification dialog:
 - Specify the desired **Depth** value and then lock it.
 - Specify the **Bottom Height** value so that it is equal to the Ceiling Height of the room(s) over which the beam is placed.
3. Uncheck **Bearing Beam**.

4. If necessary, select **Build> Framing> Joist Direction**  and draw a line perpendicular to the beam and within the floor or ceiling platform.
5. Click OK, then select **Build> Framing> Build Framing**  and build the appropriate floor or ceiling framing. See [Floor Panels on page 614](#).

Framing Tools



Select **Build> Framing** to access the automatic and manual Framing Tools.

The Framing Tools family has three separate parent buttons: **General Framing Tools** , **Floor/Ceiling Framing Tools** , and **Roof Framing Tools** .

The default settings for framing members are derived from their respective panels in the Framing Defaults dialog. See [Framing Defaults on page 606](#).

Most types of framing can be created both manually and automatically. Once created, both automatically generated and manually drawn framing members can be selected and edited. See [Editing Framing on page 634](#).



Horizontal floor/ceiling platform framing members are referred to as "joists"; vertical wall framing members are referred to as "studs"; and sloped roof framing members are referred to as "rafters".

BUILD FRAMING



Select **Build> Framing> Build Framing** to open the Build Framing dialog. Here, you can define settings that control how framing is drawn and generate automatic framing. See [Build Framing Dialog on page 613](#).

GENERAL FRAMING



General Framing objects are generic, framing members that can be drawn outside of a floor or ceiling platform or roof plane. Select **Build> Framing> General Framing**, then click and drag in a straight line to create one of these objects. In plan view, a horizontal framing member is created.

POST



Posts can only be placed manually. To do so, select **Build> Framing> Post** and click in plan view.

POST WITH FOOTING



Posts can also be created with footings beneath them. Select **Build> Framing> Post** and click in plan view to place a post centered over a footing. Post footings are **Slab**  objects and can be selected independent of their posts. See [The Slab Tools on page 493](#).

RAFTER



Rafters can be drawn both manually and automatically. To draw a rafter manually, select **Build> Framing> Rafter** in plan view, then click and drag in a straight line within a roof plane.

Rafters are edited like other framing members, except that you cannot set the height. If a rafter is moved, its height and slope are automatically reset to fit under the roof plane at its new position.

ROOF BLOCKING



Roof Blocking is automatically generated in the eaves if a soffit is not present; otherwise, blocking is drawn manually. In plan view, select **Build> Framing> Roof Blocking** and click and drag in a straight line within a roof plane. Blocking is typically drawn perpendicular to the rafters, but at the same pitch.

Each run of blocking behaves as a single object but has gaps where it crosses rafters, trusses or other blocking.

Before drawing Roof Blocking:

- Specify whether you want **In Line**, **Stagger** blocking, or **Cross** bridging in the Framing Defaults dialog.
- Build the roof framing. See *Roof Panel on page 624*.

In 3D, roof blocking is tilted to follow the pitch of the roof plane in which it is drawn.

ROOF TRUSS



Roof trusses can only be drawn manually. To do so, select **Build> Framing> Roof Truss** in plan view and click and drag in a straight line within one or more roof planes. Roof planes and either a default or manually drawn ceiling must be present before a roof truss can be drawn. See *Roof Trusses on page 642*.

ROOF BEAM



Roof beams can only be drawn manually. To do so, select **Build> Framing> Roof Beam** in plan view and click and drag in a straight line. Roof beams are normally drawn across rafters and placed directly under them.

JOIST



Floor and ceiling joists can be both drawn manually and generated automatically. To draw a joist, select **Build> Framing> Joist** in plan view, then click and drag in a straight line within a floor or ceiling platform.

Joists are always drawn as the ceiling framing for the current floor. See *The Current Floor on page 508*. Whether a floor or ceiling joist is drawn is determined by the presence of a floor platform above.

- If there is no floor platform above, a ceiling joist is drawn.
- If there is a floor platform above, a floor joist is drawn.

If you want to draw floor joists for Floor 1, for example, you must do so on Floor 0. See *Foundations on page 481*.

Joists can be automatically generated for multiple floors in the Build Framing dialog. See *Floor Panels on page 614*.



Ceiling joists, floor joists and rafters have their own layers. Proper layer assignment maximizes display and materials flexibility.

JOIST BLOCKING



Joist blocking can only be drawn manually in plan view. To do so, select **Build> Framing> Joist Blocking**, then click and drag in a straight line within a floor or ceiling platform.

Before drawing Joist Blocking:

- Specify whether you want **In Line**, **Stagger** blocking, or **Cross** bridging in the Framing Defaults dialog.
- Build the floor and/or ceiling platform. See [Floor Panels on page 614](#).

Regardless of how many joists or other objects it crosses, each run of blocking behaves as a single object.

FLOOR/CEILING TRUSS

 Floor and ceiling trusses can only be drawn manually in plan view. Select **Build> Framing> Floor/Ceiling Truss**, then click and drag in a straight line within a floor or ceiling platform. See [Floor and Ceiling Trusses on page 642](#).

FLOOR/CEILING BEAM

 Floor and ceiling beams can only be drawn manually in plan view. Select **Build> Framing> Floor/Ceiling Beam**, then click and drag in a straight line within a floor or ceiling platform.

Beams can be drawn in two different ways:

- **Under Joists** places the beam underneath the joists so the joists can bear on it.
- **With Joists** places the top of the beam even with the tops of the joists it supports. The joist then butts against it. See [Beams Panel on page 622](#).

FRAMING REFERENCE MARKER

 **Framing Reference Markers** are manually-placed reference points that specify how automatically-generated framing is laid out. To place one, select **Build> Framing> Framing Reference Marker** in plan view and click to place a Framing Reference Marker.

A Framing Reference Marker can also be created by placing a **Marker**  and then specifying its type. See [Markers on page 357](#) and [Framing Reference Markers on page 628](#).





BEARING LINE

 **Bearing Lines** direct the program to lap or butt joists and/or rafters where they cross the line instead of spanning from wall to wall, and can only be drawn in plan view. To draw one, select **Build> Framing> Bearing Line** and click and drag in a straight line. See [Bearing Lines on page 631](#).

JOIST DIRECTION

 **Joist Direction** lines define the direction in which joists run in a floor or ceiling platform and can only be drawn in plan view. To draw one, select **Build> Framing> Joist Direction** and click and drag within a floor or ceiling platform. See [Joist Direction Lines on page 630](#).

Build Framing Dialog

 Automatic framing can be generated by selecting **Build> Framing> Build Framing** to open the Build Framing dialog. This dialog can also be accessed by double-clicking the **General Framing**  button or any of the **Floor/Ceiling Framing Tools** , or **Roof Framing Tools**  buttons.

The settings in this dialog are similar to those found in the Framing Defaults dialog.

Each major structural component of the model has its own panel or panels in the Build Roof dialog. The number of panels in the dialog varies depending on how many floors are in your model. There will be a panel called “1st” for the first floor, “2nd” for the second floor, and so on.

- Floor and ceiling framing settings are found on the Floor panels. See [Floor Panels on page 614](#).
- Wall framing settings are located on the WALL, OPENINGS, and FIREPLACES panels. See [Wall Panel on page 618](#), [Openings Panel on page 620](#), and [Fireplaces Panel on page 621](#).
- Floor/Ceiling Beam and Roof Beam settings are found on the BEAMS panel. See [Build Framing Dialog on page 613](#).
- Post, floor/ceiling beam and roof beam settings are found on the POSTS panel. See [Posts Panel on page 623](#).
- Roof framing settings are located on the ROOF and TRUSSES panels. See [Roof Panel on page 624](#) and [Trusses Panel on page 626](#).
- The settings on the ROOF panel are the same as those on the STRUCTURE panel of the Build Roof dialog. See [Roof Panel on page 624](#).
- You can specify how framing looks in plan view on the PLAN VIEW panel. See [Plan View Panel on page 627](#).
- You can set the default materials used for framing on the MATERIALS panel. See [Materials Panel on page 628](#).



For best results, create roof framing before or at the same time that ceiling joists are generated.

FLOOR PANELS

The default floor and ceiling framing for individual floor levels is set here. The defaults for all floor levels, however, is set in the Floor/Ceiling Platform Defaults dialog. See [Floor and Room Defaults on page 280](#).

The floor framing for a given floor level is always generated or manually drawn on the floor below. As such, the floor framing settings for a given floor level are found on the FLOOR panel for the floor below it. For example, the floor framing settings for Floor 2 are found on the 1ST panel, while the floor framing settings for Floor 1 are found on the FOUNDATION panel. See [Floor and Ceiling Platforms on page 295](#).

In order to create the floor framing for Floor 1, a Floor 0 must be present. If a Floor 0 has not been built, the **Build Floor Framing** checkbox on the FOUNDATION panel will not be available. See [Foundations on page 481](#).

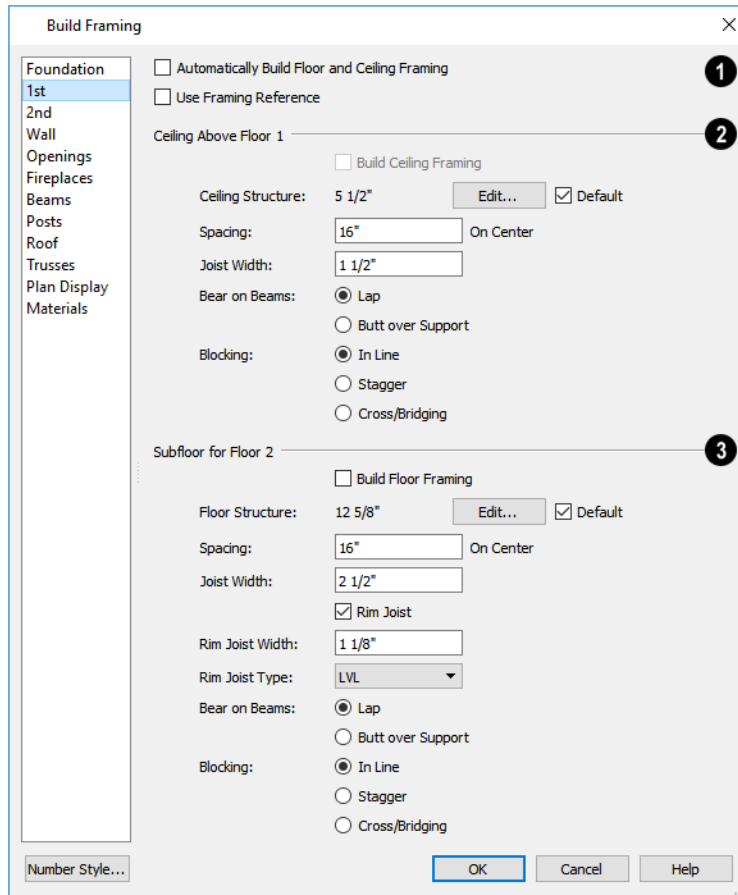

1 Automatic Floor/Ceiling Framing

Check **Automatic Floor/Ceiling Framing** to regenerate floor and ceiling framing whenever changes are made to the model. See *Automatic Framing on page 608*.

- Check **Use Framing Reference** to build ceiling framing to a Framing Reference Marker. If a reference is present, the center of the first joist is placed at this point and spacing goes from there. If joists are lapped, the surface is placed at this point. When this is unchecked, the program tries to position ceiling joists so that they coincide with rafters. See *Framing Reference Markers on page 628*.

2 Ceiling Above Floor X

Ceiling platforms are only present above rooms that do not have living space above them.

- Check **Build Ceiling Framing** to generate or regenerate ceiling framing when the **OK** button is clicked. Only available when there is no living space above at least part of the current floor. Not available in the Framing Defaults dialog.
- The **Ceiling Structure** depth displays here for reference. Click the **Edit** button to open the Ceiling Structure Definition dialog and define the layers of materials that form the ceiling platform. See *Material Layers Definition Dialogs on page 709*.
- Check **Default** to use the Ceiling Structure Definition set in the Floor/Ceiling Platform Defaults dialog. See *Floor and Room Defaults on page 280*.
- Enter a value for the On Center **Spacing** of joists generated in ceiling platforms on Floor X.
- Specify the **Joist Width**, which is their horizontal thickness.
- Specify how the ceiling framing members **Bear on Beams**: they can either **Lap** side by side or **Butt** end to end. The lap is 8" (200 mm) and centered over the support.
- Specify what style of **Blocking** or bridging is produced for the ceiling when **Joist Blocking**  is manually drawn after joists are in place. See *Joist Blocking on page 612*.
- **In Line** produces blocking pieces that align with each other.
- **Stagger** produces blocking that alternates on either side of the line you draw.
- **Cross** produces cross bridging that looks like in line blocking in plan view, but shows as cross bridging in 3D views and the materials list.

3 Subfloor of Floor Y

If a room has a living space above it, its ceiling will be supplied by the floor platform of the room(s) above instead of a ceiling platform.

- Check **Build Floor Framing** to generate or regenerate floor framing when the **OK** button is clicked. Not available in the Framing Defaults dialog or if there is no floor level located below Floor Y.
- The **Floor Structure** depth displays here for reference. Click the **Edit** button to open the Floor Structure Definition dialog and define the layers of materials that form the floor platform. Only available if there is living space above at least part of the current floor.
- Check **Default** to use the Floor Structure Definition set in the Floor/Ceiling Platform Defaults dialog.
- Enter a value for the on center **Spacing** of floor joists above the current floor.
- Specify the **Joist Width**, which is their horizontal thickness.
- Check **Rim Joist** to create rim joists across the ends of the floor joists when floor framing is generated. If this is unchecked, line blocking across the ends of the floor joists is usually drawn in later.
- Specify the **Rim Joist Width**, which is the horizontal thickness.
- Select the **Rim Joist Type** from the drop-down list.
- Specify how the floor framing members **Bear on Beams**: they can either **Lap** side to side or **Butt** end to end. The lap is 8" (200 mm) and centered over the support.
- Specify what style of **Blocking** or bridging is produced for the floor when **Joist Blocking**  is manually drawn after joists are in place. See #2, above.

WALL PANEL

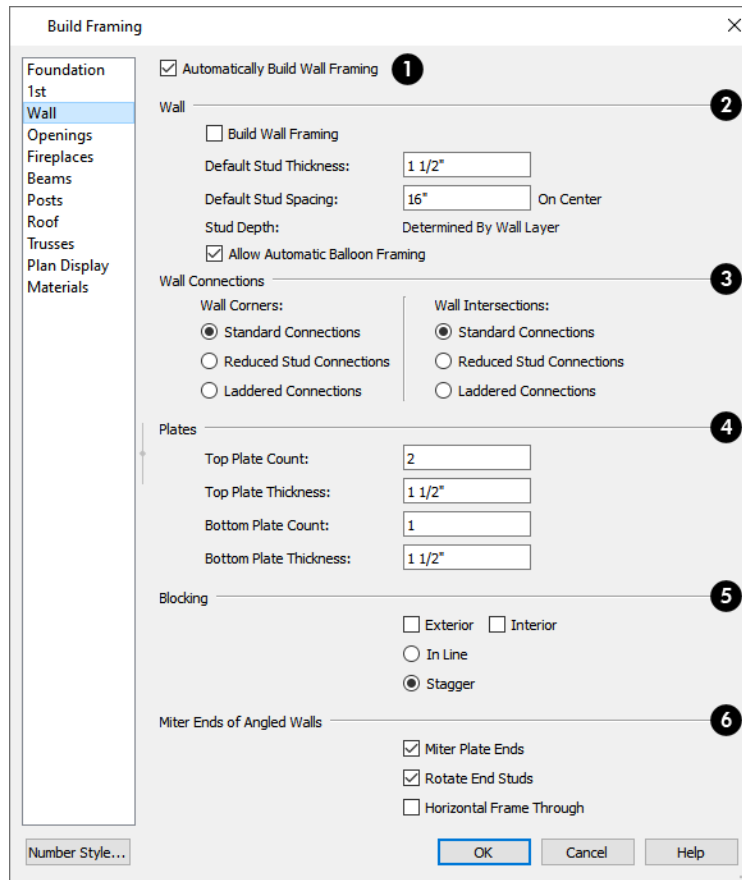

1 Automatically Build Wall Framing

Check this box to regenerate wall framing whenever changes are made to the model. See *Automatic Framing on page 608*.

2 Wall

Specify how wall studs are created.

- Check **Build Wall Framing** to build wall framing for the entire model. Framing is built in walls with one or more layers specified as Framing. Not available in the Framing Defaults dialog. See *Wall Type Definitions on page 256*.
- Specify the **Default Stud Thickness** for all wall Framing layers in the plan. Stud depth is equal to the thickness of each wall layer that has a Framing material.

Note: If the Stud Thickness is equal to the stud depth, only one stud will be created at wall corners.

- Specify the **Default Stud Spacing** for all wall Framing layers in the plan, starting from the Framing Reference Marker, if one is present. See *Framing Reference Markers on page 628*.
- **Stud Depth** - The depth of each wall stud is determined by the thickness of its wall layer, which is set in the Wall Type Definitions dialog. See *Wall Type Definitions Dialog on page 259*.
- When **Allow Automatic Balloon Framing** is checked, walls adjacent to Open Below rooms are balloon-framed. Uncheck this box to instead produce wall plates separated by rim joists instead. See *Effects of Room Types on page 283*.

3 Wall Connections

Define how the framing at **Wall Connections** is generated. **Wall Corners** and **Wall Intersections** can be specified separately.

- Select **Standard Connections** to produce corners or intersections composed of three studs.
- Select **Reduced Stud Connections** to produce corners or intersections composed of two studs.
- Select **Laddered Connections** to add horizontal ladder blocking at corners or intersections.

4 Plates

Define how top and bottom **Plates** are generated.

- Specify the **Top Plate Count**, as well as their **Thickness**.
- Specify the **Bottom Plate Count**, as well as their **Thickness**.

5 Blocking

Specify where and how **Blocking** is drawn. Each run of blocking behaves as a single object but has gaps where it crosses studs.

- Check **Exterior** to automatically produce blocking on exterior walls when wall framing is built.
- Check **Interior** to automatically produce blocking on internal walls when wall framing is built.
- **In Line** produces blocking pieces that align with each other.
- **Stagger** produces blocking that alternates on either side of a center line along the wall.
- Wall blocking is generated exactly half-way up each wall's total height. Once created, it can be selected in a Framing Overview.

6 Mitre Ends of Angle Walls

Specify how wall corners that are not right angles are framed. 90° corners are not affected by these settings.

- Select **Mitre Plate Ends** to mitre the ends of the top and bottom plates. If unchecked, top and bottom plates will be butted together.
- Select **Rotate End Studs** to rotate the studs closest to mitre ends to the angle of the mitre. If unchecked, studs will remain perpendicular to the angle of the walls.
- Select **Horizontal Frame Thru** to frame through the horizontal walls in plan view, butting vertical walls against them. If unchecked, walls that are vertical in plan view will frame through.

OPENINGS PANEL

Various defaults for door and window headers as well as the trimmers for bay/box/bow windows can be set here.

The rough openings for doors and windows can be specified in the Door and Window Defaults and Specification dialogs. See *Rough Openings on page 607*.

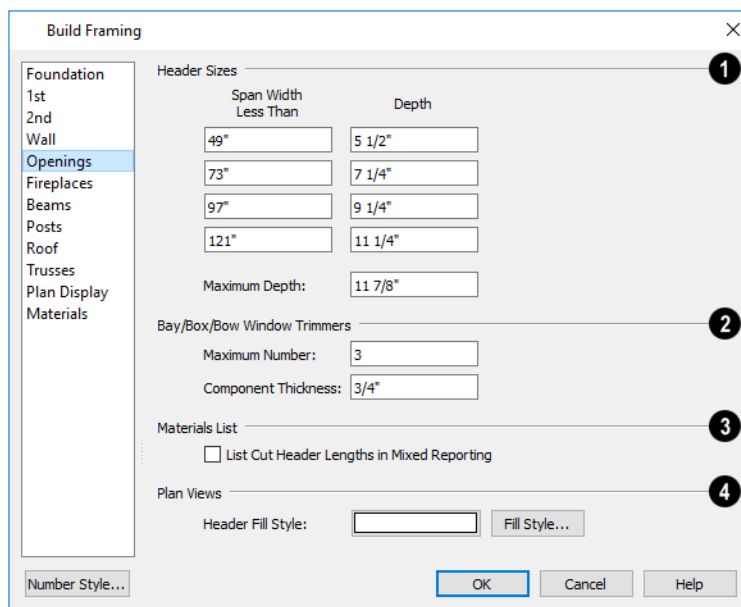

1 Header Sizes

Specify default **Header Sizes**, dependent on width of the door or window, including its Rough Opening. These values should be set so that the wider the opening, the deeper the header.

- If the top of an opening's Rough Opening is closer to the top plate than the **Maximum Depth**, a solid header is produced to fill the entire space. Short cripple studs between the header and top plate are not produced.

2 Bay/Box/Bow Trimmers

Specify how **Bay/Box/Bow Trimmers**, are generated.

- Specify the **Maximum Number** of trimmers that a Bay, Box, or Bow Window with a lowered top height can have on each side of the opening.
- Specify the **Component Thickness**, which is the thickness of a thinner trimmer for manually resized Bay/Box/Bow Window components if a standard trimmer does not fit. See [Resizing Components on page 423](#).

3 Materials List

Check **List Cut Header Lengths in Mixed Reporting** to show precut headers in the Materials List. Precut headers are shown only if the walls have been framed and Mixed Reported is selected as the reporting method. See [Structural Member Reporting on page 907](#).

If this is unchecked, the Materials List produces a total footage for all headers. When checked, each different length of precut header is listed separately. Note that the total number of headers is affected by the **Count** value of each door and window.

4 Plan Views

Specify the default **Header Fill Style** for door and window headers by clicking the **Fill Style** button to open the Wall Header Fill Style dialog. See [Displaying Framing on page 632](#).

FIREPLACES PANEL

The rough openings for legacy Fireplaces placed in walls can be set on the FIREPLACES panel.

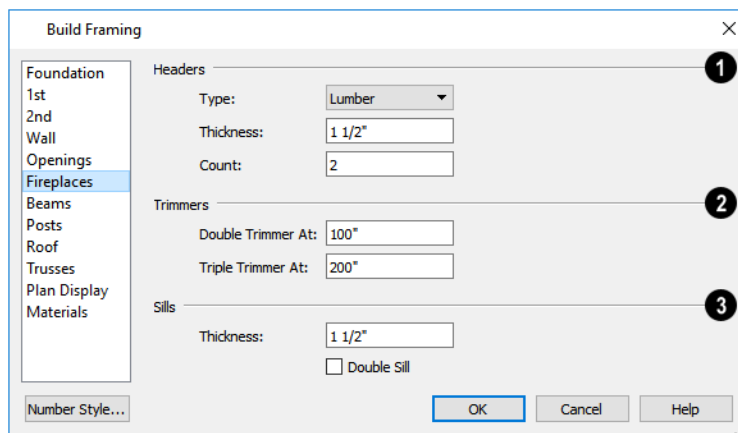

1 Headers

Specify the characteristics of fireplace **Headers**.

- Specify the **Type** of material used for fireplace headers.
- Specify the **Thickness** of fireplace headers.
- Specify the **Count** of boards used to form a fireplace header.

2 Trimmers

Specify when to generate multiple **Trimmers** on each side of a fireplace. These values include the fireplace's Rough Opening. See [Rough Openings on page 607](#).

- **Double Trimmer At** - Fireplace openings of this width or greater receive two trimmers on each side when framed.
- **Triple Trimmer At** - Fireplace openings of this width or greater receive three trimmers on each side when framed.

3 Sills

Specify the characteristics of fireplace **Sills**. A sill is only generated if a fireplace is raised sufficiently off the floor.

- Specify the **Thickness** of fireplace sills.
- Check **Double Sills** to specify a double sill for all fireplaces.

BEAMS PANEL



Floor/Ceiling Beams and **Roof Beams** are not automatically generated: they can only be drawn manually. See [Manual Framing on page 609](#).

 Posts and beams may be created under a Deck room automatically, depending on its size, location, and other variables. Deck Framing defaults are set in the Deck Room Defaults dialog. See [Deck Framing and Planking on page 293](#).

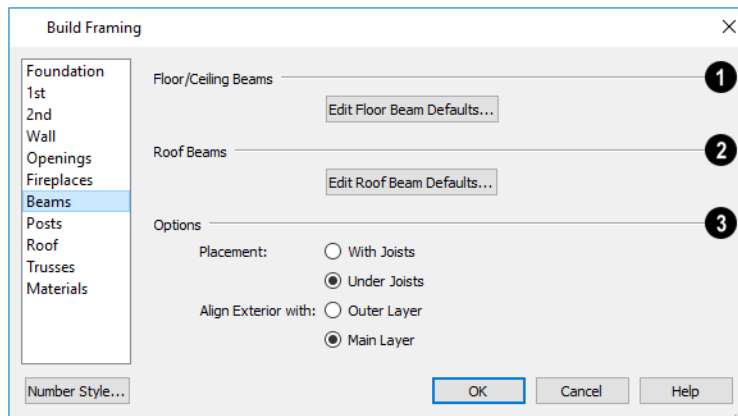

1 Floor/Ceiling Beams

Click the **Edit Floor Beam Defaults** to open the Floor/Ceiling Beam Defaults dialog. This dialog is similar to the Framing Specification dialog. See [Framing Specification Dialog on page 637](#).

2 Roof Beams

Click the **Edit Roof Beam Defaults** to open the Roof Beam Defaults dialog. This dialog is also similar to the Framing Specification dialog.

3 Options

The **Options** settings affect the positioning of **Floor/Ceiling Beams**.

- Specify the **Placement** of Floor/Ceiling Beams relative to the joists. **With Joists** places beams at the same height as the joists so they hang on the beams; **Under Joists** places beams below joists so they bear on the beams. See [Bearing Lines on page 631](#).
- **Align Exterior with Outer Layer/Main Layer** - When a Floor/Ceiling Beam is drawn along and over an exterior wall, its exterior surface can snap to either the wall's outer layer or outer Main Layer, as specified here. See [The Main Layer on page 257](#).

POSTS PANEL



Posts are not automatically generated: they can only be drawn manually. See [Manual Framing on page 609](#).

 Posts and beams may be created under a Deck room automatically, depending on its size, location, and other variables. Deck Framing defaults are set in the Deck Room Defaults dialog. See [Deck Framing and Planking on page 293](#).

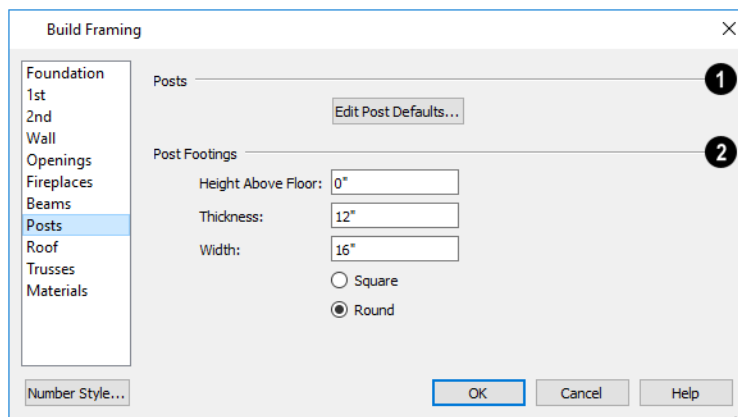

1 Posts

Click the **Edit Post Defaults** to open the Post Defaults dialog. This dialog is similar to the Framing Specification dialog for posts. See [Framing Specification Dialog on page 637](#).

2 Post Footings

The **Post Footings** settings control the initial attributes of footings created with the **Post with Footing**  tool.

- Specify the **Height Above Floor** value, measured from the top of the subfloor of the room in which the post is placed.
- Specify the top to bottom **Thickness** of the footing.
- Specify the **Width** of the footing. This is the length of each side of a square footing and the diameter of a round footing.
- Select the **Square** or **Round** radio button to specify the initial shape of post footings. Once created, a post footing can be edited like other closed polylines. See [Editing Closed Polyline-Based Objects on page 155](#).

ROOF PANEL

The settings on the ROOF panel of the Build Framing dialog are exactly the same as those on the STRUCTURE panel of the Build Roof dialog. See *Build Roof Dialog on page 562*.

These settings are also found on the STRUCTURE panel of the Roof Plane Specification dialog. Those settings that apply to ceiling planes are available in the Ceiling Plane Specification dialog. See *Roof Plane Specification Dialog on page 578*.

Note: Changes made on the Roof panel will not affect the structure of existing roof planes. To make changes take effect, rebuild the roof.

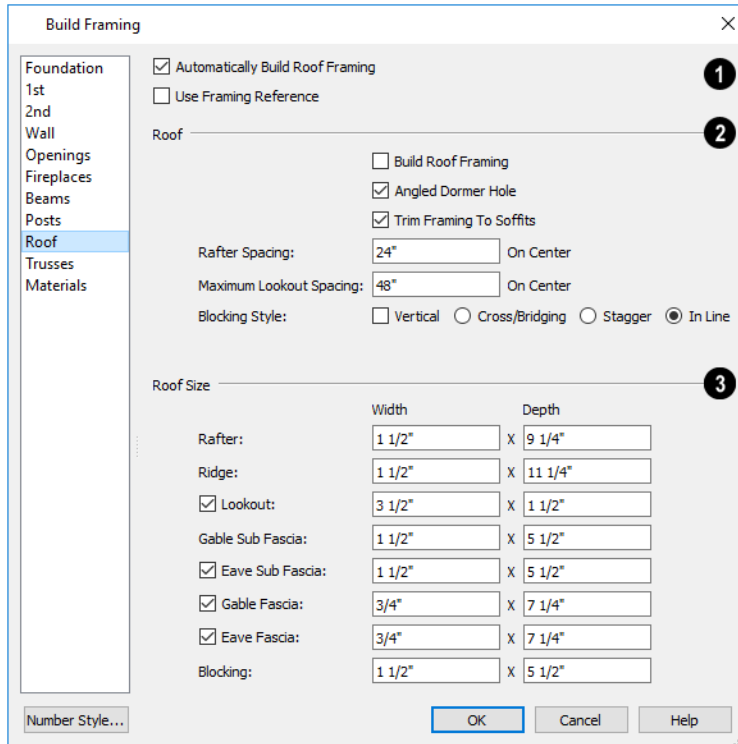

1 Automatic Roof Framing

Check **Automatic Roof Framing** to automatically rebuild roof framing if changes are made to the roof plan. See *Automatic Framing on page 608*.

- Check **Use Framing Reference** to use a defined starting point for rafter layout. See *Framing Reference Markers on page 628*.

Note: Use Framing Reference is useful when framing a gable roof, but not necessarily a hip roof. See *Framing References and Roof Framing on page 629*.

2 Roof

- Check **Build Roof Framing** to build roof framing for the entire model. Not available in the Framing Defaults dialog. See *Roofs on page 556*.
- Uncheck **Angled Dormer Hole** to frame dormers using rafters under the dormer valleys and a double header where the peak of the dormer roof meets the main roof plane. When checked, a five-sided hole is framed with two angled double rafters located under the dormer valleys.
If a double header does not fit within the main roof plane, an angled dormer hole is produced regardless of this setting.

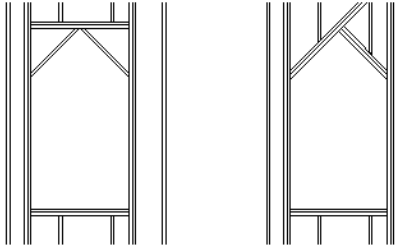

- Uncheck **Trim Framing To Soffits** to generate full-depth rafters all the way to the subfascia. If checked, rafter depths are trimmed to the top surface of the soffits in the eave area.
- Specify the **Spacing** of automatically generated rafters.
- Specify the **Maximum Lookout Spacing**. Depending on a roof plane's length, its lookouts may be spaced closer than this value, but not further.

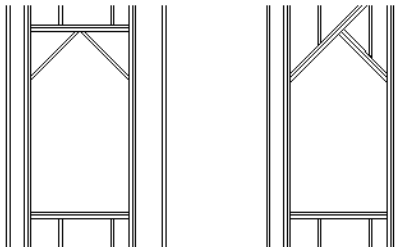

- Uncheck **Trim Framing To Soffits** to generate full-depth rafters all the way to the subfascia. If checked, rafter depths are trimmed to the top surface of the soffits in the eave area.
- Specify the **Spacing** of automatically generated rafters.
- Specify the **Maximum Lookout Spacing**. Depending on a roof plane's length, its lookouts may be spaced closer than this value, but not further.

Specify the **Blocking Style**. See *Roof Blocking on page 612*.

- Check **Vertical** to generate blocking that is oriented vertically, or plumb. When unchecked, blocking is perpendicular to the roof framing.
- **In Line** produces blocking pieces that align with each other.
- **Stagger** produces blocking that alternates on either side of the line you draw.
- **Cross/Bridging** produces cross bridging that looks like in line blocking in plan view, but shows as cross bridging in 3D views and the materials list.

3 Roof Size

Specify the desired **Width** and **Depth** for **Rafters**, the **Ridge**, **Lookouts**, **Gable Sub Fascia** (barge rafter), **Eave Sub Fascia**, **Gable Fascia**, **Eave Fascia** and **Blocking**.

Note that the **Gable Sub Fascia** setting controls the height of both gable and eave soffits, and thus the depth of rafter tails when **Trim Framing to Soffits** is checked, above.

Uncheck the boxes beside **Lookout**, **Eave Sub Fascia**, **Gable Fascia** and/or **Eave Fascia** to prevent these framing members from generating when roof framing is built. When these boxes are checked, these items will generate as specified here.

TRUSSES PANEL

Changes to the settings on this panel do not affect any trusses that are already present in the current plan. See [Trusses on page 641](#).

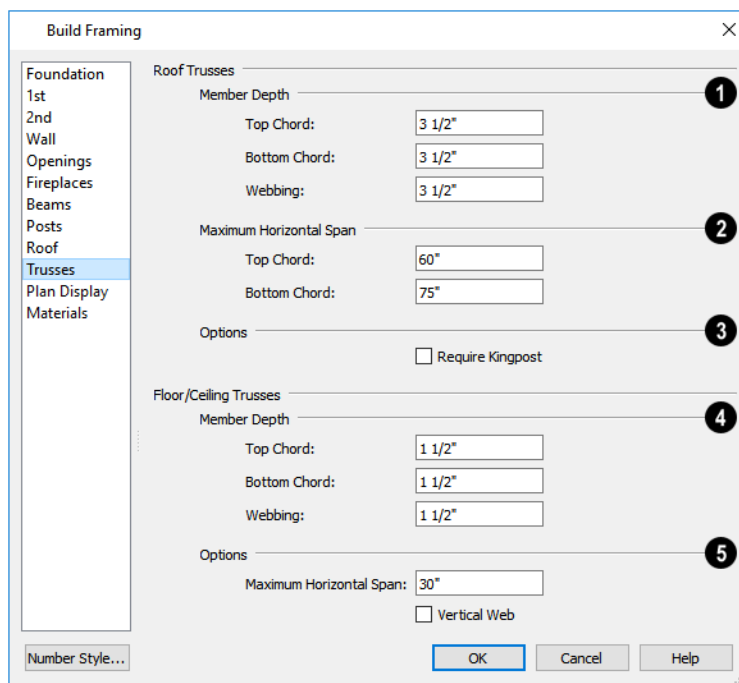
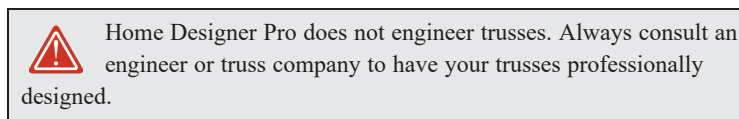

1 Member Depth

Specify the **Roof Truss Member Depths**.

- Specify the depth of the **Top Chord**.
- Specify the depth of the **Bottom Chord**.
- Specify the depth of the **Webbing**.

2 Maximum Horizontal Span

The **Maximum Horizontal Span** settings control the maximum length between junctions of the webbing and the **Top Chord** and **Bottom Chord**. Changing these values can create different truss configurations such as kingpost, queenpost, fink, double fink, fan, howe, or double howe.

These distances are measured horizontally for both roof and floor and ceiling trusses. In some instances, especially in more complex trusses, making these spans equal may result in the webbing appearing more normal or standard. See [Trusses on page 641](#).

3 Require Kingpost

Check **Require Kingpost** to include a central vertical webbing member. If this is unchecked, a vertical member may still be created, depending on the Maximum Horizontal Span settings and the length of the truss.

4 Floor/Ceiling Trusses

Specify the **Floor/Ceiling Truss Member Depths**.

- Specify the depth of the **Top Chord**.
- Specify the depth of the **Bottom Chord**.
- Specify the depth of the **Webbing**.

5 Options

The **Maximum Horizontal Span** setting controls the maximum length between junctions of the webbing and the top and bottom chords.

Trusses are always drawn manually, so while their depth, span and kingpost defaults are specified in the Build Framing dialog, their spacing is not.

Trusses are typically replicated using the **Transform/Replicate Object**  edit button. See [Transform/Replicate Object Dialog on page 180](#).

PLAN VIEW PANEL

The settings on the PLAN VIEW panel affect the appearance of Joists, Rafters, Trusses, and General Framing members in plan view. See [Displaying Framing on page 632](#).

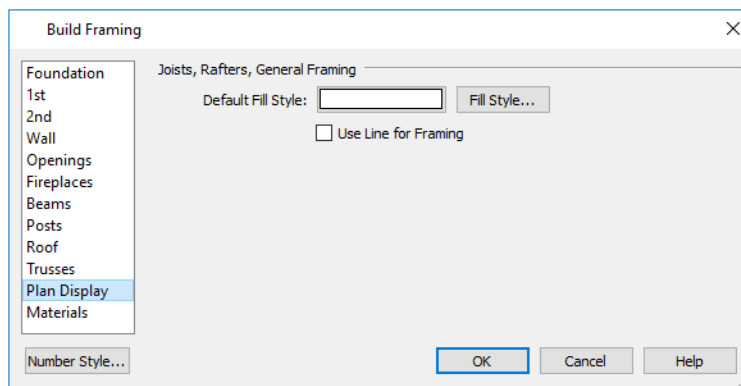

- Specify the **Default Fill Style** for joists, rafters, and General Framing members by clicking the **Fill Style** button to open the Default Framing Fill Style dialog. See [Displaying Framing on page 632](#).

- The Default Fill Style is not a dynamic default setting. Any framing already present in the plan will not be affected if you change it.
- Check **Use Line for Framing** to show joists, rafters, and General Framing members as single lines rather than as closed polylines. See *Displaying Framing on page 632*.

Note: The Use Line for Framing setting is dynamic but affects the current floor only. The Default Fill Style setting affects all framing as it is created but is not dynamic.

MATERIALS PANEL

The default materials that display on General Framing objects and Rafters are specified on the MATERIALS panel. These materials are used in 3D views only and are not used in the Materials List. Materials List information is derived from the structure Type of each framing object. See *Framing and the Materials List on page 636*.

Changes made on the MATERIALS panel of the Build Framing dialog only affect subsequently created framing: both manually drawn and automatically generated.

The settings on this panel of the Build Framing dialog are the same as in many other specification dialogs. See *Materials Panel on page 716*.

Framing Reference Markers

 **Framing Reference Markers** are reference markers that specify the starting point for the layout of automatically-produced framing, including Deck joists. See *Decks on page 292*.

- Wall and floor framing always build to the Framing Reference Marker if one is present.
- Ceiling and roof framing only build to the Framing Reference Marker when **Use Framing Reference** is specified for that type of framing.

Typically, a single Framing Reference Marker on Floor 1 is used for the entire model.

- When more than one Framing Reference Marker is present, framing layout starts at the one closest to the center of the area to be framed.
- If no Framing Reference Marker is found on the floor being framed, the closest Framing Reference Marker on Floor 1 is used.

Note: If no Framing Reference Markers exist in your plan, the point at 0, 0 is used as the Framing Reference Markers location and unexpected results may occur.

When **Automatic Wall Framing** is checked, wall framing automatically rebuilds if a Framing Reference Marker is added or moved. See *Automatic Framing on page 608*.

Automatic Floor/Ceiling Framing and **Automatic Roof Framing**, on the other hand, do not respond when a Framing Reference Marker is added or moved. These framing types must be rebuilt using the Build Framing dialog. See *Build Framing Dialog on page 613*.

USING FRAMING REFERENCE MARKERS

To place a Framing Reference Marker, select **Build> Framing> Framing Reference Marker** . Click in plan view to place the Framing Reference Marker.

When **Object Snaps**  are enabled, Framing Reference Marker snap to framing members and other CAD-based objects first, and then to a wall Main Layer surface or corner if possible. See [Object Snaps on page 113](#).

Framing Reference Markers can be modified just like other markers. See [Markers on page 357](#).

When framing is generated using a Framing Reference Marker, the first framing member of a given type snaps to this point and all other framing members are laid out from there.

- Wall and roof framing snap to the Framing Reference Marker at their centers.
- Floor and ceiling framing snaps to the Framing Reference Marker at their centers when it is set to **Butt Over Support** in the Build Roof dialog. See [Floor Panels on page 614](#).
- Floor and ceiling framing snaps to the Framing Reference Marker along an edge when it is set to **Lap** over a supporting beam or wall. If **Lap** is selected, the surfaces where the joists lap are placed at reference spacing, so that joists are placed on either side of the framing reference locations.

MOVE TO FRAMING REFERENCE



Manually drawn framing and automatic framing that was not generated using a Framing Reference Marker can be moved relative to a Framing Reference Marker using the **Move to Framing Ref** edit button.

When a framing member using the **Move to Framing Ref** edit button, the on-center spacing distance set in the Build Framing dialog is used.

The **Move to Framing Ref** edit button may also reference spacing specific to a particular floor or ceiling platform. See [Joist Direction Lines on page 630](#).

A group of selected framing objects that are all parallel to each other can be moved using the **Move to Framing Ref** edit button. Only one of the objects in the group is compared to the Framing Reference Marker and moved; the remaining objects are simply moved the same amount as the first object. Ideally, therefore, the group should have proper spacing relative to each other before the move.

To move framing objects to a framing reference marker

1. Group select the framing objects.
2. Click the **Move to Framing Ref**  edit button.
3. The framing members are moved to the nearest Framing Reference Marker.

FRAMING REFERENCES AND CEILING FRAMING

For floor joists, the starting point for layout is always the Framing Reference Marker. Ceiling joists, on the other hand, only use a Framing Reference Marker if **Use Framing Reference** is checked in the Build Roof dialog. See [Floor Panels on page 614](#).

If the **Use Framing Reference** check box is cleared, the program will try to position ceiling joists so that they coincide with rafters. Be sure to build the roof framing first if you are doing this.

A Framing Reference Marker is not usually used for both ceiling joists and nearby rafters that run the same way because one is placed on top of the other.

FRAMING REFERENCES AND ROOF FRAMING

Framing Reference Markers are useful when framing a gable roof, but not necessarily a hip roof. When a Framing Reference is used, common rafters on either side of a hip rafter do not meet in the same place.

If the Framing Reference is not used, the automatic framing utility starts common rafter spacing from each end of the horizontal ridges, which results in common rafters on either side of hip jacks meeting each other.

Joist Direction Lines

 By default, automatically-generated floor and ceiling joists will run in the direction that results in the shortest span between beams. A **Joist Direction** line allows you to define the direction that joists in a particular floor or ceiling platform run, regardless of span.



To draw a Joist Direction line, select **Build> Framing> Joist Direction** , then click and drag as you would draw a CAD line. In order to have any effect, a Joist Direction line must be drawn within the area of a single floor or ceiling platform.

To avoid unexpected results, only one Joist Direction line should be present in a given floor or ceiling platform, and it should not extend outside of the extents of that platform.

Joist Direction lines are located on the “Framing, Bearing Lines” layer and use the Text Style assigned to that layer. See [Text Styles on page 360](#).

MULTIPLE JOIST DIRECTIONS

By default, all of the rooms on each living floor share a single floor platform and a single ceiling platform. If you require joists that run in two directions in either of these platforms, begin by dividing the platform in question in two. There are a number of ways to do this:

- Divide the living area into separate rooms with different platform thicknesses and/or heights. See [Floor and Ceiling Platforms on page 295](#).
- Draw a **Floor/Ceiling Beam**  specified as a Bearing Beam. See [Floor/Ceiling Beam on page 613](#).
- Draw a **Bearing Line** . See [Bearing Lines on page 631](#).

Floor/Ceiling Beams and Bearing Lines should be drawn on the same living floor as the joists they will interact with. Floor framing for a living floor is created on the floor below, while ceiling framing for a living floor is created on that floor. See [Floor and Ceiling Framing on page 606](#).

JOIST SIZE AND SPACING

The text of a Joist Direction line states the platform framing’s Structure Type and size, and the spacing. By default, these values reflect the settings in the Framing Defaults dialog. See [Floor Panels on page 614](#).

In plans using US Units, when the Structure Type is “Lumber”, the nominal size will be reported for the joists. For all other Structure Types, fractional inches are used.

It is important to note that if a Joist Direction line is set to use non-default Spacing and Depth values, they will override the settings in both the Framing Defaults and Room Specification dialogs. It will not, however, change the settings in either dialog.

Joist Direction Specification Dialog

 A Joist Direction line can control the joist depth and spacing in the floor or ceiling platform in which it is drawn. To change these values, select a Joist Direction line and click the **Open Object** edit button. The Joist Direction

Specification dialog opens.

Any changes made in the Joist Direction Specification dialog will not affect any joists present in its floor or ceiling platform. Only subsequently produced framing in its platform will be affected.

FLOOR JOIST PANEL

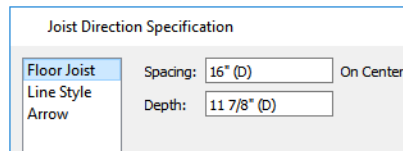

- Define the **Spacing** of the joists in the platform associated with the selected Joist Direction line.
- Define the **Depth** of these joists.

Note: This is not the recommended method for specifying joist depth and spacing in most cases. You should instead use the settings in the Room Specification dialog. See [Room Specification Dialog on page 300](#).

LINE STYLE PANEL

For information about the settings on this panel, see [Line Style Panel on page 204](#).

ARROW PANEL

Joist Direction Lines do not use the Attach or Auto Position options for arrows. For information about the settings on this panel, see [Arrow Panel on page 205](#).

Bearing Lines

 It is not unusual for joists to lap or butt in the middle of a span rather than build across a platform. When they do, they typically bear on a beam at that point. To produce joists that break over a support, specify the beam in question as Bearing in the Framing Specification dialog. See [General Panel on page 637](#).

Joists lap or butt over the support depending on the option selected in the Build Framing dialog. See [Floor Panels on page 614](#).

In either case, the joists' overlap or butted ends are centered over the support. When an offset from the center is required, do not specify the wall or beam as Bearing and instead draw a **Bearing Line**.

A **Bearing Line** directs the program to lap or butt joists where they cross the line instead of framing across to a wall.

Select **Build> Framing> Bearing Line** , then click and drag to draw a Bearing Line as you would draw a CAD line. A Bearing Line should start outside the floor or ceiling platform and end outside of it, passing completely through the building.

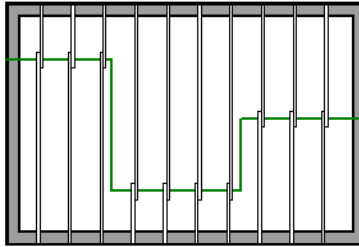

Bearing Lines are edited just like CAD lines, and can be connected to form polylines. See [Editing Line-Based Objects on page 145](#) or [Editing Open Polyline-Based Objects on page 151](#).

Bearing Lines are one of the ways that a floor or ceiling platform can be divided into separate smaller platforms with different **Joist Directions** . See [Joist Direction Lines on page 630](#).

Displaying Framing



The display of framing members is controlled in the Layer Display Options dialog. Framing objects are created on one of over twenty layers with names that begin with “Framing,”: Ceiling Beams, for example, are placed on the “Framing, Ceiling Beams” layer. See [Layer Attributes on page 124](#).

DISPLAYING FRAMING IN PLAN VIEW

In plan view, wall studs and posts are represented by box-based CAD objects that look like Cross Boxes. See [Cross Box on page 217](#) and [Editing Box-Based Objects on page 158](#).

Joists, rafters, trusses, General Framing, and headers are represented in plan view by line-based CAD objects that look like long, thin rectangles. See [Editing Line-Based Objects on page 145](#).

You can specify a default fill style for line-based framing members in the Build Framing dialog. See [Plan View Panel on page 627](#), [Openings Panel on page 620](#), and [Fill Styles on page 130](#).

By default, newly drawn line-based framing members of a given type display in front of older ones. Posts, meanwhile, display in front of beams, but behind joists. You can specify the drawing order of framing members in their specification dialogs. See [Line Style Panel on page 640](#).

If you prefer, joists, rafters, trusses, and General Framing can instead be represented by a single line. The **Use Line for Framing** setting can be set differently for each floor in a plan. See [Plan View Panel on page 627](#).

DISPLAYING FRAMING IN 3D VIEWS

The easiest way to view framing in 3D is to use either the **Orthographic Framing Overview**  or **Perspective Framing Overview**  tool, which display the model using the “3D Framing Layer Set”. See [Framing Overview on page 743](#).



Framing objects can display in other 3D and cross section/elevation views, although by default they are not set to do so. If you wish to see framing in these views, turn on the framing layers when the view is active.

To reveal framing covered by other objects or wall layers, use the **Delete Surface**  tool. See [Delete 3D Surface on page 749](#).

DISPLAYING FRAMING IN CROSS SECTION/ELEVATION VIEWS

To display framing in a cross section/elevation view, make sure the framing layers are turned on in that view. See [Layer Display Options Dialog on page 126](#).

You can also use the **Delete Surface**  tool to temporarily delete the surfaces of wall layers or other objects that block the view.

In cross section/elevation views, horizontal framing objects that are cut by the cross section plane display as boxes containing an 'X'. , **Joist Blocking**  and **Roof Blocking**  cut by the cross section plane displays as a box containing a single diagonal line. See [Cross Section/Elevation Views on page 744](#).

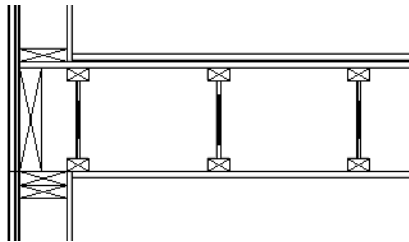

FRAMING MATERIALS AND TYPES

The appearance of a framing member in 3D and cross section/elevation views is affected by the material assigned to it and also by its Type.

The material specified for a framing member determines what it looks like in camera views by applying a texture, pattern, or color to its surface. Materials have no effect on how the framing is calculated in the Materials List, however.

The default materials for framing are set:

- In the Floor and Ceiling Structure Definition dialogs for floor and ceiling framing. See [Floor and Ceiling Platform Definitions on page 296](#).
- In the Wall Type Definitions dialog for wall framing. See [Wall Type Definitions Dialog on page 259](#).
- In the Framing Defaults dialog for General Framing, Posts, and Rafters. See [Materials Panel on page 628](#).

Framing Types can also influence how a framing member looks in camera views because some types have special profiles - for example, I-Joist. Framing Types are also stated in the Description column in the Materials List. See [Structure Types on page 636](#).



FRAMING MEMBERS IN THE MATERIALS LIST

When framing is calculated in the materials list, its dimensions and type are noted. Treated lumber is also counted separately from regular lumber. See [Structure Types on page 636](#).

Framing lengths can be counted using one of several methods to produce, for example, cut lists and buy lists. See [Structural Member Reporting on page 907](#).

If framing is not present in a plan when a Materials List is created, it will not be calculated. See *Framing and the Materials List on page 636*.

Editing Framing

Framing can be edited much like other line-based objects can using the edit handles, edit toolbar buttons, or the Framing Specification dialog. See *Framing Specification Dialog on page 637*.

Framing is organized into families which determine where it is generated and where it can be manually drawn. See *Manual vs. Automatic Framing on page 608*. Once framing has been created, however, it can be moved out of its structural component. In order to move roof framing above or below a roof plane, you must first check **Manual Rafter Height** in the Framing Specification dialog. See *Framing Specification Dialog on page 637*.

When **Start and End Indicators** are enabled in the Preferences dialog, a selected framing member will display an S and an E at its start and end points. This makes it easier to choose which end to lock when specifying its Length or Angle. See *Edit Panel on page 75*.

Roof and floor/ceiling trusses cannot be edited like regular framing members can and are discussed in their own chapter. See *Editing Truss Envelopes on page 646*.

SELECTING FRAMING

Before a framing member can be edited, it must be selected. Framing can be individually selected in all views, and some types can be group-selected. To group-select framing in plan view, first select any of the Framing Tools. See *Marquee Select on page 143*.

To select framing objects of a particular type, use the **Marquee Select Similar**  tool's **Restrictive Selection**  option. See *Marquee Select Similar on page 144*.

USING THE EDIT HANDLES

Framing members can be drawn, edited, and moved much the way CAD lines can. See *Editing Line-Based Objects on page 145*.

In cross section/elevation views, joists and rafters cut by the cross section and displaying a cross box can also be edited. See *Editing Box-Based Objects on page 158*. Also, in cross section/elevation views headers can be edited like closed polylines. See *Editing Closed Polyline-Based Objects on page 155*.

In a camera view or overview, the handles that display on a framing member depend on where it is clicked for selection and your current zoom factor.

- Click the top surface to display the same edit handles as in plan view, allowing you to rotate, move, and extend or shorten the length of the member.
- Click a side surface to display the same edit handles as in an elevation view, one at each end and one at the center.
- Zoom in and click on the appropriate edge to display edit handles that control the width and depth of framing members.

USING THE EDIT TOOLS

A selected framing member can be edited in a variety of ways using the buttons on the Edit Toolbar. See *The Edit Toolbar on page 91*.



Move to Framing Reference moves the selection into alignment with a Framing Reference Marker. See [Framing Reference Markers on page 628](#).



Join and Lap Ends and **Join and Mitre Ends** join horizontal framing members at either a lapped or mitered joint. See [Lapped and Mitered Joints on page 635](#), below.



USING DIMENSIONS



Framing members can be both moved and resized using dimensions. See [Moving Objects Using Dimensions on page 332](#).

LAPPED AND MITERED JOINTS



You can make two horizontal framing members meet at a lapped intersection using the **Join and Lap Ends** edit button.

To join and lap framing members

1. Select a horizontal framing member such as a joist, rafter, beam, or General Framing object.
2. Click the **Join and Lap Ends**  edit button.
3. Click on a second horizontal framing member that is not parallel to the initially selected member.
4. The two members now meet at a lapped joint. The initially selected framing member butts against the second one, which laps the end of the first.



Alternatively, mitered joints can be created using the **Join and Mitre Ends** edit button. This edit tool is used in the same way as the Join and Lap Ends tool.

The **Join and Mitre Ends** and **Join and Lap Ends** tools not available for wall studs, Posts, Floor/Ceiling Trusses, or Roof Trusses.

STEEL AND CONCRETE

You can set framing defaults to generate steel framing and concrete structural members as well as lumber and other framing types. Individual framing members can also be specified as concrete or steel, as well.

When setting up defaults or modifying an individual object, make sure you specify both the desired framing Type and the material. See [Framing Materials and Types on page 633](#).

DELETING FRAMING



Individual and group-selected framing members can be deleted the way other objects in the program are. See [Deleting Objects on page 187](#).



Categories of framing, such as wall framing or floor and ceiling framing, can also be deleted in the Delete Objects dialog. See [Delete Objects Dialog on page 188](#).

Keeping Framing Current

When you modify your plan, move walls, raise or lower platforms or redesign the roof, any framing present in the plan will not update to reflect your changes. In order for the framing to be updated, you must regenerate automatically produced framing and either edit or delete and replace manual framing.

For this reason, it is recommended that you wait until your model is finished, or nearly finished, before creating framing. See *Drawing a Plan on page 25*.

AUTOMATIC FRAMING

Automatically-generated framing can be rebuilt using either of two check boxes in the Build Framing dialog:

- Select a **Build** check box to build automatic framing once. For example, check **Build Wall Framing** on the WALL panel to build wall framing once based on the current state of the model. If the model is changed later, you may need to do this again.
- Select an **Automatic** check box to build automatic framing every time a change is made to that structural component in the plan. For example, check **Automatic Wall Framing** on the WALL panel to rebuild all wall framing any time a wall is affected by changes to the model.

When floor, ceiling or roof framing is regenerated, all automatically produced framing objects and any copies of them are deleted and new framing is calculated. See *Rebuilding and Retaining Framing on page 609*.

MANUAL FRAMING

It is vital to remember that manually drawn framing objects and copies of them are not retained when automatic framing is rebuilt.

If a plan is not final, therefore, do not spend a lot of time altering or copying automatically produced framing objects. It is best to wait until your design is final before doing manual framing work.

Framing and the Materials List

Each framing member created in a plan is counted in the Materials List. See *Materials Lists on page 904*.

Framing can be calculated using one of several reporting methods. See *Structural Member Reporting on page 907*.

Depending on what a framing member is used for, it may be listed in the Framing (F), Subfloor (SF), or Roofing (R) category. See *Categories on page 908*.

- Framing includes all wall framing, posts, and General Framing objects.
- Sub Floor lists floor and ceiling framing joists as well as sheathing.
- Roofing includes trusses, rafters, and sheathing.

It is important to note that the floor, ceiling, and roof framing counted in the Materials List may vary considerably depending on whether framing of those types is actually present in the plan:

- If no framing is present in the model, then the required floor, ceiling, and roof framing is estimated. Total linear footage for various depths of rafters and joists is estimated, rather than a quantity of specific lumber lengths and sizes. Wall framing is not estimated.
- If even one floor, ceiling, or roof framing object exists in the plan, then objects in that category are counted instead of estimated for the Materials List.

STRUCTURE TYPES

A variety of structural member Types is available for use in Home Designer Pro. They fall into four categories:

- Wood framing types: Lumber, I-Joist, Glulam, Engineered Lumber, LVL, PSL, and VSL.
- Steel framing types: Steel I, Steel Box, C Channel, and U Channel.

- Solid Concrete.
- Round (Posts only).

You can select any of these Types as the default for floor and ceiling framing, headers, roof framing, beams, and posts. See [Build Framing Dialog on page 613](#).

You can also specify the Type for individual framing members in their specification dialog. See [General Panel on page 637](#).

Changing the framing member Type does not affect how framing is placed, but it may change its profile in cross section and 3D views and will affect its description in the Materials List.

The framing member Type does not affect the appearance of the material used by a framing member in 3D views. See [Framing Materials and Types on page 633](#).

STRUCTURAL MEMBER REPORTING

You can specify whether framing materials are calculated by linear foot, as a cut list, or as a buy list. See [Structural Member Reporting on page 907](#).

FRAMING MATERIALS AND THE MATERIALS PANEL

The materials applied to framing objects in 3D views are not used in the Materials List. Materials List information is derived from the structural use of each framing object and its **Type** - not the material seen on its surfaces in 3D views. See [Materials Panel on page 628](#).

Framing Specification Dialog



Select a framing member and click the **Open Object** edit button to open the Framing Specification dialog for the type of framing member selected.

The settings in this dialog are similar to those in the Post and Beam Specification and Defaults dialogs. See [Framing with Beams on page 610](#).

The panels available in the Framing Specification dialog will vary, depending on the type of framing object that is selected.

GENERAL PANEL

The options available in on the GENERAL panel will vary depending on the type of framing member selected.

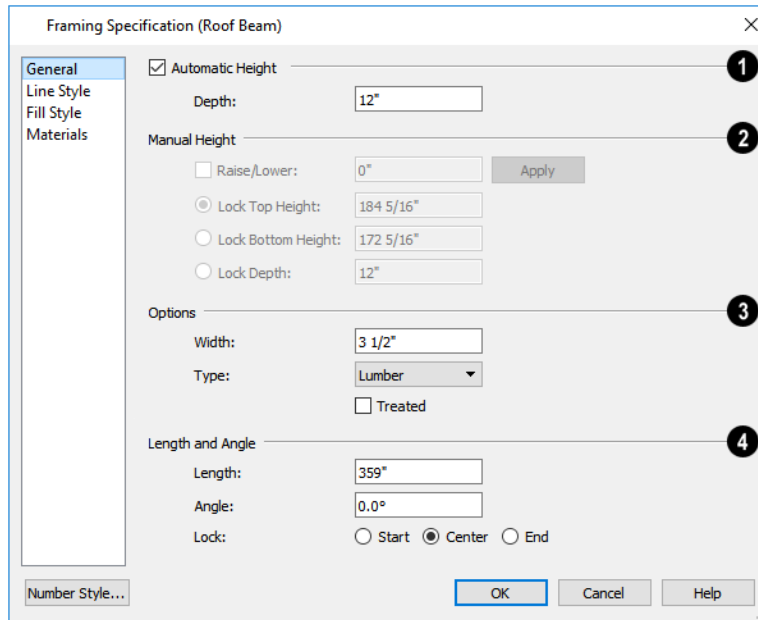

1 Automatic Height

- When **Automatic Height** is checked, the selected Roof Rafter, Roof Beam, or Roof Blocking object generates within the structural layer of the roof plane(s) it is drawn in. Uncheck this box to enable the Manual Height settings that follow.
- If the selected object's height is edited outside of this dialog, Automatic Height will become unchecked automatically.

2 Depth and Height

- Check the box beside **Raise/Lower**, then enter a positive value to raise or negative value to lower the framing object from its current position. The amount is added to both the Top and Bottom Heights when you click either **Apply** or **OK**, and does not affect the Depth. When Raise/Lower is checked, the other Depth and Height settings are disabled.
- Select the radio button beside one of the height values to **Lock** it, then change a value that remains available.
- Specify the **Top Height** of the post, as measured from the first floor subfloor at 0". For a rafter, this is the top height at its low end.
- Specify the **Bottom Height** of the post, as measured from the first floor subfloor at 0". For a rafter, this is the bottom height its low end.
- Specify the **Depth** of the framing object. For a rafter, this is the depth measured perpendicular to the roof plane.
- **Manual Rafter Height** - Normally, the height of each Rafter or Roof Beam end is reset after any move or edit so that it is located just under the roof surface. Check this box to allow the height of the object to be changed. Only available for Rafters and Roof Beams.

3 Options

- Set the framing member's **Width**, as seen in plan view.
- Specify a selected wall framing member's **Thickness**, as seen in plan view. Only available for wall framing.
- Select a structural member **Type** from the drop-down list. The Round Type is unique to Posts. See *Structure Types on page 636*.
- Check **Show Cross** to display the selected Post as a cross box in plan view. Only available for Posts. See *Displaying Framing on page 632*.

Note: Instead of counting individual concrete posts and beams in the Materials List, the total volume of their concrete is calculated. The square footage for beam and post forms is also listed.

- Check **Bearing Beam** to specify the selected Floor/Ceiling Beam as a load-bearing beam. When checked, automatically generated joists run perpendicular to the selected beam and either lap or butt over it, as specified in the Build Framing dialog. If the beam's Top Height is at least 1" higher than the joists' bottom height, the joists will instead butt against the sides of the beam. See *Framing with Beams on page 610*. Only available for Floor/Ceiling Beams.
- Check **Treated** to specify that the selected framing member be counted as treated in the Materials List.
- The **Rotate** options let you rotate and align a selected wall stud, blocking, or header within the wall's framing layer. Select **None** for the framing member's Thickness to span the depth of the framing layer; select **Flat to Outside** to rotate the member 90° and align it with the outside of the framing layer; select **Flat to Inside** to rotate the member 90° and align it with the inside of the framing layer.

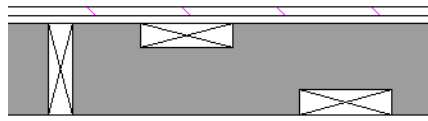

4 Length and Angle

Lock the point about which you want like the selected object to resize and/or rotate, then specify its exact length and angle. See *Editing Framing on page 634*.

- Specify the **Length** of the framing object. Rafter length is measured along the top of the rafter, and so is greater than the length measured in plan view. Not available for Posts.
- **Width 1** and **2** - Specify the Post width in each dimension. When a Round Post is specified, Width 1 refers to its diameter and Width 2 is not available.
- Specify the **Angle** of the framing object in plan view. Changing this rotates the object about the location specified by the radio buttons described below.
- Select **Lock Center** to resize or rotate the object about its center point.
- Select **Lock Start** to resize or rotate the object about the location from which you started drawing the framing object.
- Select **Lock End** to resize or rotate the object about the location where you stopped drawing it.

LINE STYLE PANEL

The settings on the LINE STYLE panel affect the selected object's line style, its bumping behaviors, and its drawing order. See *Line Style Panel on page 204*.

FILL STYLE PANEL

For headers, floor, ceiling, and roof framing, and General Framing, the settings on the FILL STYLE panel affect the selected object's appearance in plan view. See *Fill Style Specification Dialog on page 131*.

The settings on this panel do not affect any wall framing that displays as a cross box in plan view.

MATERIALS PANEL

The default materials on this panel are set in the Build Framing dialog. If you change the selected object's framing Type, the material here may update - unless you have previously specified a non-default material. See *Materials Panel on page 716*.

COMPONENTS PANEL

The information on the COMPONENTS panel can be used in the materials list. For more information, see *Components Panel on page 921*.

OBJECT INFORMATION PANEL

The information entered on the OBJECT INFORMATION panel can be used in the materials list. For more information, see *Object Information Panel on page 922*.

Trusses

Chapter 24

There are two basic ways to frame a roof. The first is commonly called “stick framing,” or sometimes “handstacking” or “cut-and-stack.” This type of roof incorporates framing such as rafters, ridges, and ceiling joists. See *Framing on page 605*.

The other method is to use prefabricated, engineered roof trusses. Home Designer Pro allows you to design and display a wide variety of trusses.

DISCLAIMER

Home Designer Pro does not engineer trusses. The trusses displayed by Home Designer are for illustrative purposes only. They can show how trusses are used in your plan, and help you communicate to the licensed engineer who produces your final truss design where you want your trusses and how you would like them to work.

Always have your truss designs approved by a licensed engineer.



TOPICS

Truss Defaults	642
Floor and Ceiling Trusses	642
Roof Trusses	642
Drawing Trusses	643
Displaying Trusses	644
Editing Trusses	644
Editing Truss Envelopes	646
Truss Labels	647
Mixing Trusses with Stick Framing	647
Hip Trusses	648
Special Roof Trusses	649
Roof Truss Specification Dialog	652
Floor/Ceiling Truss Specification Dialog	656
Framing and Truss Schedules	658

Truss Defaults



The default settings for floor, ceiling and roof trusses are set in the Framing Defaults dialog. Select **Edit> Default Settings** and in the Default Settings dialog, select Framing and click the **Edit** button.

- The default settings for truss chord and webbing depth, maximum span, and kingpost are set in the Framing Defaults dialog. See *Trusses Panel on page 626*.
- The overall depth of individual **Floor/Ceiling Trusses**  are based on the thicknesses of the platforms in which they are drawn. See *Floor Panels on page 614*.
- The structure of **Roof Trusses**  is determined by the position of the roof plane(s) above and the ceiling plane(s) below. See *Roof Planes on page 570* and *Ceiling Planes on page 586*.

Floor and Ceiling Trusses

 Floor and ceiling trusses can be used instead of joists to frame platforms. As with manually-drawn floor and ceiling framing, the presence of a room above determines whether a floor or ceiling truss is drawn. For example, a truss drawn on the first floor of a single story home will be a ceiling truss, while a truss drawn on the first floor of a two-story building will be a floor truss for the 2nd floor.

Floor and ceiling trusses can only be drawn manually. To place a floor or ceiling truss in your plan, select **Build> Framing> Floor/Ceiling Truss** , then click and drag within a floor or ceiling platform in plan view. See *Drawing Trusses on page 643*.



652.

To create a sloped truss ceiling truss, draw a Roof Truss and specify it as a Sloping Flat Truss. See *General Panel on page*

The TRUSSES panel of the Build Framing dialog contains default settings for floor and ceiling trusses. See *Trusses Panel on page 626*. These default settings can be overridden by the settings in the Floor/Ceiling Truss Specification dialog. See *Floor/Ceiling Truss Specification Dialog on page 656*.

Roof Trusses



Roof trusses can be used instead of or in combination with rafters to frame roofs and ceilings. Roof trusses can only be drawn manually, and can only be created where a roof and ceiling are already present. Select **Build> Framing> Roof Truss**, then click and drag in plan view within one or more roof planes to manually draw a roof truss. See *Drawing Trusses on page 643*.

If you intend to use roof trusses, you need first to build your roof planes with this in mind. Before building the roof, select the **Trusses (no Birdsmouth)** checkbox in the Build Roof dialog. When this is checked, roof plane thickness is based on the default **Top Chord Depth** set in the Framing Defaults dialog. See *Trusses Panel on page 626*.

If **Trusses (no Birdsmouth)** is not checked, the roof plane thickness is determined by the rafter **Depth** setting on the ROOF panel of the Framing Defaults dialog. If you plan to use both trusses and rafters, you should leave this unchecked.

ROOF TRUSS PLACEMENT

A roof truss can only exist in a space defined by the roof planes above it and the ceiling or manually drawn **Ceiling Plane**  below it. This is because the shape of a truss is defined by the location of the roof and the ceiling.

If the program either does not find both roof and ceiling planes, or if there is not enough room between them to model a truss, a warning message displays. For example, if you draw a truss in a roof overhang where there is no ceiling, this message displays:

“Roof and ceiling surfaces too close together or cannot be found, so cannot make truss.”

The incorrect truss may still display in plan view with a label of the form “TR-*”. If it does, it should be deleted or moved. See [Editing Trusses on page 644](#).

One or both ends of a truss may be truncated if they are drawn across another truss. If this happens, it will end exactly on the surface of the existing truss, producing a girder truss. See [Girder Trusses on page 651](#).

Trusses can end on interior walls. You can draw a truss that partially crosses the building by starting and/or ending it within 24” (600mm) of an interior wall. The truss extends over the wall’s Main Layer. Its end lines up with the Main Layer surface on the far side of the wall.

ROOF TRUSS WEBBING



The webbing in a newly drawn truss is controlled by the **Top Chord** and **Bottom Chord** settings in the Framing Defaults dialog. See [Trusses Panel on page 626](#).



Changing these default values may cause different truss configurations such as kingpost, queenpost, fink, double fink, fan, howe, or double howe to be represented.

Drawing Trusses

Trusses cannot be generated automatically: they must be manually drawn and then replicated. All trusses are drawn similar to the way CAD lines are and can be drawn in plan view only. See [Draw Line on page 199](#).

To draw and replicate trusses

1. Select the either the **Floor/Ceiling Truss**  or **Roof Truss**  tool, then click and drag within either a floor/ceiling platform or one or more roof planes.
 - As they are drawn, roof trusses will snap to any walls that they cross.
 - When a roof truss ends over an exterior wall, it will extend into the roof eave, stopping at the inside edge of the Eave Sub Fascia.
 - When a roof truss is drawn over a Full Gable Wall, it will have **End Truss** and **Reduced Gable** checked automatically.
 - Floor/Ceiling trusses will snap to the wall surfaces, the exterior surface of a wall’s Main Layer, as well as to a variety of CAD-based objects, and can be drawn to any length.
2. Reposition the truss:

- Floor/ceiling trusses are often positioned relative to an exterior wall or **Framing Reference Marker** . See [Framing Reference Markers on page 628](#).
 - Roof trusses can be positioned over a gable end wall or at the ridge end of a hip.
3. Open the truss's specification dialog and edit its settings to meet your needs. See [Roof Truss Specification Dialog on page 652](#) or [Floor/Ceiling Truss Specification Dialog on page 656](#).
 4. Make multiple copies of the truss at specified intervals using the **Transform/Replicate Object**  edit tool. See [Transform/Replicate Object Dialog on page 180](#).

The copies of Roof Trusses automatically conform to the structural conditions in their new locations. As a result, replicated Roof Trusses and their labels may be different from the original. See [Truss Labels on page 647](#).

Unlike Roof Trusses, Floor/Ceiling Trusses do not conform to new structural conditions when they are either moved or copied. See [Moving Trusses on page 645](#).



Displaying Trusses



The display of trusses and their labels is controlled in the Layer Display Options dialog. See [Layer Display Options Dialog on page 126](#).

Truss labels display in plan view and are used in the Materials List. See [Truss Labels on page 647](#).

IN 3D VIEWS

The easiest way to view trusses in 3D is to use either the **Orthographic Framing Overview**  or **Perspective Framing Overview**  tool, which display the model using the 3D Framing Set layer set. See [Framing Overview on page 743](#).

Trusses can display in other 3D and cross section/elevation views, although by default they are not set to do so. If you wish to see trusses in these views, turn on the “Framing, Trusses” layer when the view is active.

You can create exposed trusses by placing roof and ceiling planes to produce the desired truss structure, drawing the trusses, and then removing the ceiling. See [Vaulted and Cathedral Ceilings on page 298](#).

To reveal trusses covered by other objects, you can use the **Delete Surface**  tool. See [Delete 3D Surface on page 749](#).

IN THE MATERIALS LIST

All trusses are listed under the Roofing category in the Materials List. Their labels appear in the Size column, along with their length. See [The Materials List Tools on page 905](#).

Editing Trusses

Trusses can be edited much like other objects can using the edit handles, edit toolbar buttons, or the Truss Specification dialogs. See [Roof Truss Specification Dialog on page 652](#) and [Floor/Ceiling Truss Specification Dialog on page 656](#).

SELECTING TRUSSES

Before a truss can be edited, it must be selected. Like other architectural objects, Trusses can be individually and group-selected in all views. See [Selecting Objects on page 141](#).

To group-select trusses of a particular type, use the **Marquee Select Similar**  tool. See [Marquee Select Similar on page 144](#).

When **Start and End Indicators** are enabled in the Preferences dialog, a truss selected in plan view will display an S and an E at its start and end points. See [Edit Panel on page 75](#).

Trusses can be deleted individually, or all at once in the Delete Objects dialog. See [Delete Objects Dialog on page 188](#).

USING THE EDIT HANDLES

In plan view, trusses can be drawn, edited, and moved much the way CAD lines can. See [Editing Line-Based Objects on page 145](#).

When editing a roof truss's length, bear in mind that if you position either of its ends at a location that doesn't correspond to a roof plane edge, interior wall, or another truss, **Use Special Snapping** will automatically become unchecked in its specification dialog.

When selected in a camera view, a truss can be edited like a closed polyline. This is not always recommended, though, because the truss may no longer match the space in the structure that it is meant to occupy. See [Editing Truss Envelopes on page 646](#).

The depth of truss chords can be changed in the truss's specification dialog, but not using the edit handles.

USING THE EDIT TOOLS

A selected truss can be edited in a variety of ways using the buttons on the Edit Toolbar. See [The Edit Toolbar on page 91](#).



Build Framing for Selected Object(s) rebuilds the envelope and webbing of the selected truss. See [Editing Truss Envelopes on page 646](#).



Move to Framing Reference moves the selection into alignment with a Framing Reference Marker. See [Framing Reference Markers on page 628](#).

USING DIMENSIONS





Trusses can be repositioned precisely as well as resized using dimensions. See [Moving Objects Using Dimensions on page 332](#).

In order for a dimension tool to locate trusses as dimensions are drawn, that tool needs to be set to do so in the Dimension Defaults dialog. See [Locate Manual Panel on page 315](#).

MOVING TRUSSES

Trusses can be moved using either their Move edit handle or the **Transform/Replicate Object**  edit tool. It's important to note that Roof and Floor/Ceiling Trusses may behave differently when they are moved:

- When a **Roof Truss**  is moved, its shape updates to conform to the structural conditions defined by the roof and ceiling in its new location. To prevent this from occurring, check **Lock Truss Envelope and Webbing** in the Roof Truss Specification dialog before moving the truss. See [Lock Truss Envelope and Webbing on page 647](#).

- This is not the case with **Floor/Ceiling Trusses** : when moved to a location with a different platform structure, a Floor/Ceiling Truss will not update to conform to its new surroundings. It is important to draw, position, and copy them within the same floor or ceiling platform structure. If a different Floor/Ceiling Truss depth is needed, a new truss should be drawn.

SPECIAL TRUSS SNAPPING

By default, **Roof Trusses**  have a number of special snapping behaviors that are used even when **Object Snaps**  are toggled off. See *Object Snaps on page 113*.

These special behaviors include:

- As they are drawn, Roof Trusses will snap to any walls that they cross.
- When drawn along an exterior wall, a Roof Truss will snap so that its outer surface is flush with the outer surface of the wall's Main Layer.
- When drawn along a roof plane edge, a Roof Truss will snap to the roof plane's edge or corner.
- The center line Roof Trusses will snap to the line along which two roof planes meet.
- When a Roof Truss ends over an exterior wall, it will extend into the roof eave, stopping at the inside edge of the Eave Sub Fascia.

Floor/Ceiling Trusses  can be drawn to any length but also have special snapping:

- Floor/Ceiling trusses will snap to the wall surfaces, the exterior surface of a wall's Main Layer, as well as to a variety of CAD-based objects.

If you edit a truss in such a way that its ends do not correspond to a special snapping location, **Use Special Snapping** will automatically become unchecked in its specification dialog. This allows you to easily customize a truss but may make it difficult to snap to commonly used locations.

You can check or uncheck **Use Special Snapping** in the Roof Truss Specification dialog. See *General Panel on page 652*.

DELETING TRUSSES



Individual and group-selected trusses can be deleted the way other objects in the program can. See *Deleting Objects on page 187*.



Trusses can also be deleted by category as well as floor in the Delete Objects dialog. See *Delete Objects Dialog on page 188*.

Editing Truss Envelopes

A truss envelope is the shape defined by a truss's top and bottom chords. When a truss is drawn, the envelope is derived from the floor platform, ceiling platform, or roof that the truss is drawn in.

When a truss is viewed in a 3D view, its envelope can be edited like a closed polyline. See *Editing Closed Polyline-Based Objects on page 155*.

This function can be used to change a roof truss end or overhang as well as the overall truss shape. Changing the truss envelope does not change the structure that it is drawn in, however.

In addition, when a **Roof Truss**  is moved, its shape updates to conform to the structural conditions defined by the roof and ceiling in its new location. As a result, a Roof Truss's label can change when the truss is moved to a new location.

Floor/Ceiling Trusses  do not update when moved to a location with different structural conditions.

FORCE TRUSS REBUILD

If you make changes to a selected truss that affect its envelope or webbing, you can ensure that its configuration is up-to-date by checking **Force Truss Rebuild** in the truss's specification dialog. See [General Panel on page 652](#).

LOCK TRUSS ENVELOPE AND WEBBING

The **Lock Truss Envelope and Webbing** attribute can be used to prevent a **Roof Truss**  envelope from updating when it is moved or replicated. See [Roof Truss Specification Dialog on page 652](#).

Truss Labels

Labels for roof trusses display when the “Framing, Roof Truss Labels” layer is turned on in the current view. Similarly, floor and ceiling trusses display when the “Framing, Floor/Ceiling Truss Labels” is turned on. See [Layer Display Options Dialog on page 126](#).

Truss labels are available in two formats: automatic and user-specified. See [Label Panel on page 363](#).

Truss labels can display in plan view and are used in the Label column of the Materials List. See [Displaying Trusses on page 644](#).

Truss labels use the Text Style specified for their layer in the current view. See [Text Styles on page 360](#).

By default, truss labels are centered on the truss that they identify. If the truss is moved or deleted, the label is moved or deleted as well. See [Editing Trusses on page 644](#).

Truss labels obey the **Minimum Display Size** for labels set in the Preferences dialog. See [Appearance Panel on page 60](#).

If two or more trusses share the same configuration with identical chords and webbing, they will also share the same truss label.

AUTOMATIC TRUSS LABELS

Automatic roof truss labels use the format TR-X, where X is a number indicating the order in which each distinct truss configuration was created. For example, the first truss type created in a plan is labeled TR-1; the second, TR-2; and so on.

Floor and ceiling trusses are labeled FTR-X and use the same numbering convention.

Mixing Trusses with Stick Framing

After the trusses for your roof are in place, additional roof framing can be added. See [Roof Framing on page 608](#).

FRAMING DEFAULTS

Roof planes created using defaults set up for trusses will continue to use those defaults when stick framing is added. If you intend to add rafters, the roof planes should be created while **Trusses (no Birdsmouth)** is unchecked in the Build Roof dialog. See [Roof Panel on page 563](#).

Leaving **Trusses (no Birdsmouth)** unchecked has a similar effect on roof trusses to that of **Raise Off Plate**: roof truss bottom chords may be longer than expected and their top chords, higher. This is necessary to create the space needed to accommodate the rafter's depth.

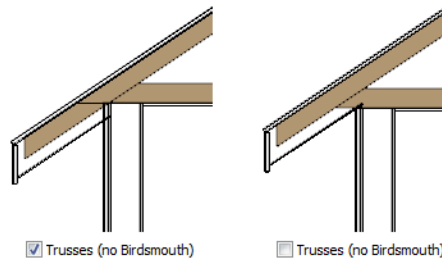

AUTOMATIC FRAMING

The Build Framing dialog can be used to generate roof framing in areas not framed by the trusses, including gable eaves and the ends of hips. Note that rafters will not generate closer than 14" (350mm) to an existing, parallel truss.

Automatically generated roof framing will not extend through an existing roof truss. Instead:

- Automatically produced rafters generate inward from the eave until they butt into a truss.
- Blocking for standard and hip ridges generates as individual rafter objects between trusses.
- Lookouts will pass over **Reduced Gable** trusses and will end at the next truss in. See *Roof Truss Specification Dialog on page 652*.
- Hip ridges and common rafters at the end of a hip roof will pass over a **Drop Hip Truss**. See *Drop Hip or California Hip on page 649*.

MANUALLY DRAWN FRAMING

Unlike automatically generated roof framing, manually drawn rafters will extend through trusses. Rafters can also snap to truss edges as they are being drawn or when they are being edited. See *Manual Framing on page 609*.





Hip Trusses



A variety of different hip truss configurations can be created, including:

STEP DOWN HIP

Step Down hip roofs are the quickest style of hip truss framing to produce.

To create a step down hip truss system

1. First, draw a **Roof Truss**  at the apex of the triangular hip roof plane. When **Object Snaps**  are enabled, it will snap into position. See *Object Snaps on page 113*.
2. Select the truss; click the **Transform/Replicate Object**  edit button; and create enough copies of the truss in the direction of the hip to reach a reasonable minimum height. See *Transform/Replicate Object Dialog on page 180*.
3. Using the **Roof Truss**  tool, draw hip jacks along the hip ridge from the last truss out into the overhang.

4. Using the **Roof Truss**  tool, draw a jack truss from the intersection of the last hip truss and the hip jack to the eave.
5. Select the jack truss; click the **Transform/Replicate Object**  edit button; and lay out jack trusses up to the other hip jack.

DROP HIP OR CALIFORNIA HIP

A Drop Hip, or California Hip, system uses trusses with lowered top chords to support stick frame hip ridges and common rafters.

To create a drop hip truss system



1. Start a drop hip truss system as you would a step down hip system.
2. When the hip trusses are drawn, group select them, open the Truss Specification dialog, and select the **Drop Hip Truss** check box. See [General Panel on page 652](#).
3. Use the Build Framing dialog to produce the common rafters, and the short joists at the hip end. See [Build Framing Dialog on page 613](#).

The amount that the top chord is lowered is derived from the rafter **Depth** on the ROOF panel of the Framing Defaults dialog. Because both common rafters and hip ridges must pass over this truss, the ridge depth should be set equal to that of the rafter depth.

SUBGIRDER HIP

Subgirders are the partial trusses that butt into the doubled truss at the end of the main run.

To create a subgirder truss system

1. Draw a **Roof Truss**  where the hip apex meets the ridge.
2. Double it by drawing a second truss on the far side from the hip section.
3. Using the **Roof Truss**  tool, draw the first subgirder from the hip apex out to the eaves.
4. Select it and use the **Transform/Replicate Object**  edit button to make copies in both directions. Stop when the height of the subgirders reach a reasonable minimum.
5. Finish off with hip jacks and jack trusses as in a step down hip system.

Special Roof Trusses

A number of special purpose roof trusses can be created in Home Designer Pro.

ENERGY HEELS

To provide more space for ceiling insulation at the exterior walls, roofs are sometimes raised off of the top plate with an energy heel. To create a truss with an energy heel, a vertical member is added over the supporting wall and the bottom chord stops there rather than extending into the overhang.

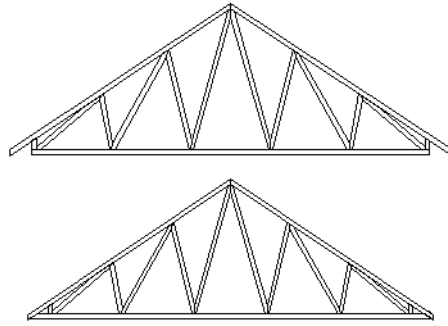

To create an energy heel

1. In the Build Roof dialog:
 - Check **Trusses (no Birdsmouth)**;
 - Uncheck **Automatic Birdsmouth Cut**;
 - Specify the desired energy heel height as a positive **Raise Off Plate** value.
2. Automatically generate or manually draw the roof planes.
3. Draw and position the first truss. See [To draw and replicate trusses on page 643](#).
4. Open this truss's specification dialog and check **Energy Heel** and **Force Truss Rebuild**, then click **OK**. See [Roof Truss Specification Dialog on page 652](#).
5. Use the **Transform/Replicate Object**  edit tool to replicate the truss as needed.

ATTIC TRUSSES

Attic trusses, a variation of roof trusses, can be drawn if a plan contains an Attic area on both sides and above an upstairs room, such as in a Cape Cod style home. The following is a typical cross section view of a building with attic trusses:

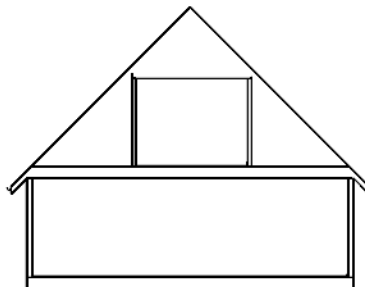

Certain conditions must be met before an attic truss can be built:

- The structure should be sufficiently wide to allow for a loft and attic spaces.
- The loft area must be on a living floor. It cannot be on the Attic floor. See [The Attic Floor on page 509](#).
- The loft area must have Attic rooms on both sides. See [Room Types on page 282](#).
- The loft area must be separated from the Attic rooms on both sides by Knee Walls. See [Knee Walls on page 254](#).
- A flat ceiling in the loft area and a floor below must be present.
- The roof pitch must be steep enough to provide appropriate ceiling height for the loft area. Typical pitches for such a condition are 8 in 12 or greater.
- The roof should bear on the walls of the floor below the loft area and form continuous planes from ridge to baselines.

Once these conditions are met, a roof truss is ready to be designated as an attic truss.

1. Select the roof truss in plan view and click the **Open Object**  edit button to display the GENERAL panel of the Roof Truss Specification dialog.
2. Check the box beside **Attic Truss** and click OK. See *Roof Truss Specification Dialog on page 652*.

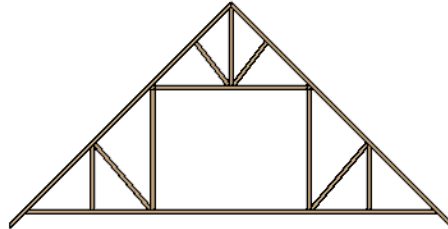

SCISSORS TRUSSES

Trusses drawn between roof planes and sloping ceiling planes of a different pitch than the roof are called Scissor trusses. See *Ceiling Planes on page 586*.

The following is an example of a scissors truss drawn beneath an 8 in 12 pitch gable roof and above 4 in 12 pitch ceiling planes.

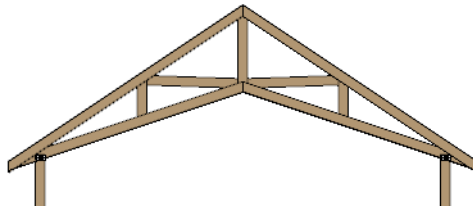

GIRDER TRUSSES

Girder trusses provide support for trusses that are cut short, for example, by a reverse gable or a skylight. They are often doubled- or tripled-up for strength.

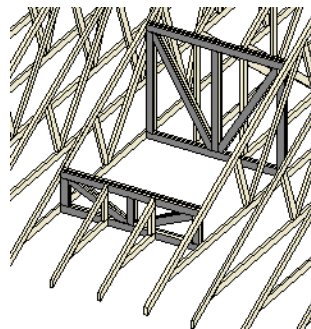

Draw a new truss from an existing truss to the roof edge, as you would to draw a hip or end jack truss; or draw a truss between two trusses, forming a girder. This may be necessary for a large opening, such as a skylight.



Trusses cannot be drawn through each other. If a truss is drawn through an existing truss, the program automatically shortens it so that it butts into the existing truss.

SLOPING FLAT TRUSSES

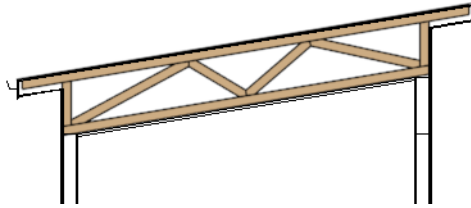
A sloping flat truss is a roof truss that builds within the rafter area of the roof plane(s) it is drawn in. In order to create one, the roof plane(s) must have a rafter depth deep enough to accommodate its chords and webbing.



To create a sloping flat truss

1. Select the roof plane in which you would like to draw sloping flat trusses and click the **Open Object**  edit button.
2. On the STRUCTURE panel of the Roof Plane Specification dialog, specify the **Rafter** depth as the desired depth of the sloping flat truss. See [Structure Panel on page 581](#).
3. Select the roof truss and click the **Open Object**  edit button.
4. On the GENERAL panel of the Roof Truss Specification dialog, check the boxes beside **Sloping Flat Truss** and **Force Truss Rebuild**, then click OK. See [General Panel on page 652](#).
5. Use the **Transform/Replicate Object**  edit tool to replicate the truss within the area of the roof plane(s) edited in step 2.

Roof Truss Specification Dialog

 Select a roof truss or group of roof trusses and click the **Open Object** edit button to open the Roof Truss Specification dialog.

The Roof Truss Specification dialog allows you to redefine parts of an existing truss or group of trusses. Some settings affect only individual trusses, such as gable trusses, while others affect the whole group.

The shape or volume of a roof truss is controlled by the roof planes above it and the ceiling planes below it. It cannot be changed from this dialog.

 Truss webbing is drawn for representational purposes only and as with trusses in Home Designer Pro in general, is not engineered.

The Roof Truss Specification dialog has the following panels:

GENERAL PANEL

The defaults for many of the settings on the GENERAL panel are set in the Build Framing dialog. See [Trusses Panel on page 626](#).

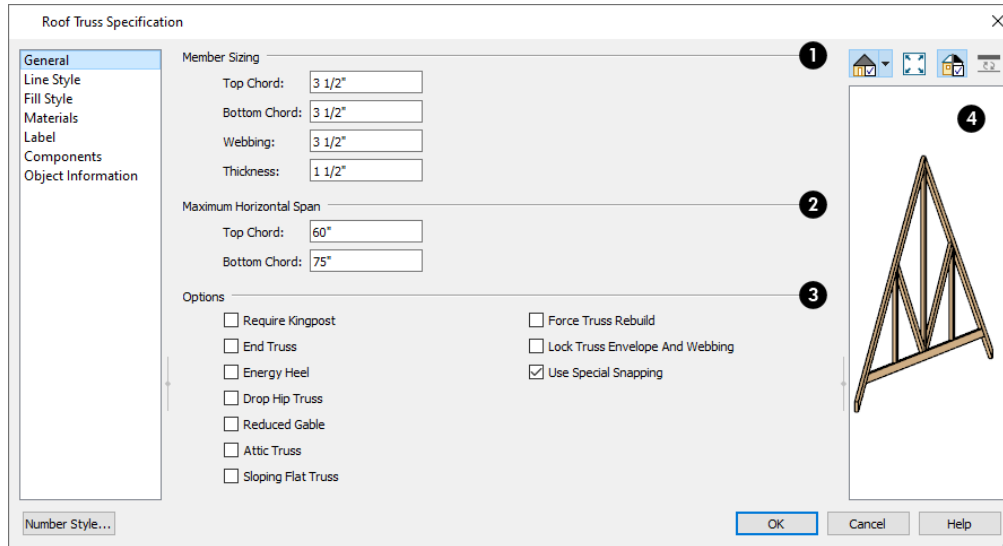

1 Member Sizing

Specify the sizes of the different members that form the selected truss.

- Specify the depths of the **Top Chord** and **Bottom Chord**.
- Specify the depth of the **Webbing**.
- Specify the **Thickness**, which is the width of the truss in plan view.

2 Maximum Span

Specify the **Maximum Span**, which is the maximum horizontal distance between supports along the **Top** and **Bottom Chords**. When these values are equal, the truss webbing often appears more regular.

3 Options

Additional **Options** allow you to create special truss types.

- Check **Require Kingpost** to require a vertical webbing member from the roof peak to the bottom chord.

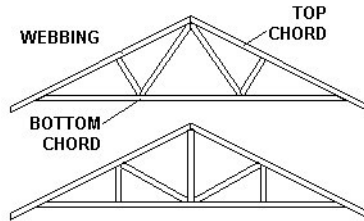

- If Require Kingpost is unchecked, a kingpost may still be supplied, depending on the truss length and the specified maximum spans.
- Check **End Truss** to replace the webbing with vertical members positioned and spaced the same as the wall studs below.

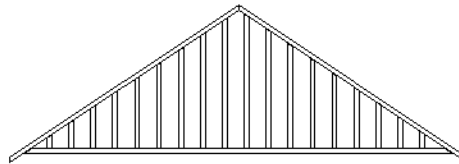

- If an End Truss is in the same position as a gable attic wall, it replaces the framing that would otherwise be produced for that wall.
- Check **Energy Heel** to model remove the bottom chord from the overhang area. For an energy heel to be modeled, the roof should also be raised off the top plates by at least 7", depending on the roof pitch. See [Energy Heels on page 649](#).

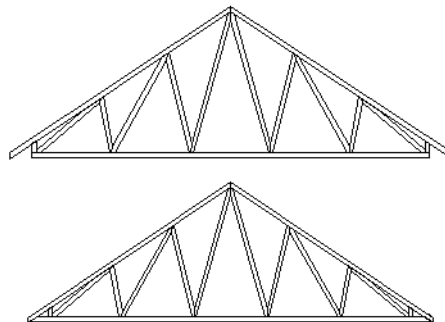

- Check **Drop Hip Truss** to lower the flat top of a truss in the hip area of a roof so that common rafters and hip ridges can pass over and be supported by it. See [Drop Hip or California Hip on page 649](#).
- Check **Reduced Gable** to lower the top chord of an End Truss so that lookouts can pass over the truss. Reduced trusses do not have overhangs, but you can draw short rafters drawn at the ends of the truss.

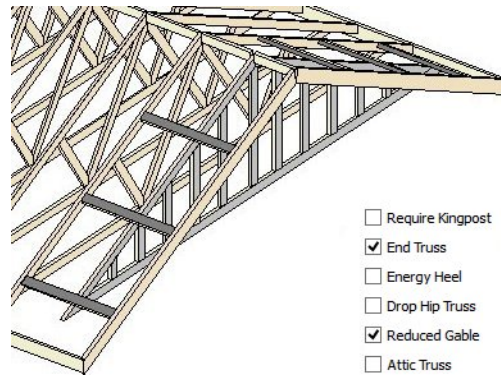

- Check **Attic Truss** to specify an attic truss. See [Attic Trusses on page 650](#).
- Check **Sloping Flat Truss** to create a truss with a bottom chord that follows the underside of the roof plane(s) it is drawn in. When this is unchecked, the bottom chord follows the ceiling of the room or manually drawn ceiling plane below. See [Sloping Flat Trusses on page 652](#).
- Check **Force Truss Rebuild** to rebuild the truss envelope based on the current state of the ceiling and roof when you click **OK**. See [Force Truss Rebuild on page 647](#).
- Check **Lock Truss Envelope and Webbing** to lock the size and configuration of the selected truss. If a locked truss is moved, it will maintain its original settings and will not fit properly if the new roof and ceiling conditions are different from the original. See [Lock Truss Envelope and Webbing on page 647](#).
- Uncheck **Use Special Snapping** to prevent the selected truss from using special truss snapping behavior. This box may become unchecked automatically if you edit a truss using its edit handles. When unchecked, **Object Snaps**  may still occur. See [Special Truss Snapping on page 646](#).

4 Preview

A preview of the selected truss displays on the right side of the panel. See [Dialog Preview Panes on page 20](#).

LINE STYLE PANEL

The settings on this panel affect the appearance of the selected truss in plan view only. See [Line Style Panel on page 204](#).

FILL STYLE PANEL

The settings on this panel affect the appearance of the selected truss in plan view. See [Fill Style Specification Dialog on page 131](#).

MATERIALS PANEL

The settings on the MATERIALS panel affect the appearance of the selected truss in 3D views. See [Materials Panel on page 716](#).

LABEL PANEL

Roof truss labels can display in plan view when the “Framing, Roof Truss Labels” layer is turned on and use the Text Style assigned to that layer. See [Text Styles on page 360](#).

For more information about the settings on this panel, see [Label Panel on page 363](#).

COMPONENTS PANEL

The information on the COMPONENTS panel can be used in the materials list. For more information, see [Components Panel on page 921](#).

OBJECT INFORMATION PANEL

The information entered on the OBJECT INFORMATION panel can be used in the materials list. For more information, see [Object Information Panel on page 922](#).

Floor/Ceiling Truss Specification Dialog

To open the Floor or Ceiling Truss Specification dialog, select one or more floor or ceiling trusses and click the **Open Object** edit button. See [Floor and Ceiling Trusses on page 642](#).

Default values for trusses are set in the Build Framing dialog. See [Build Framing Dialog on page 613](#).

The Floor/Ceiling Truss Specification dialogs have the following panels:

GENERAL PANEL

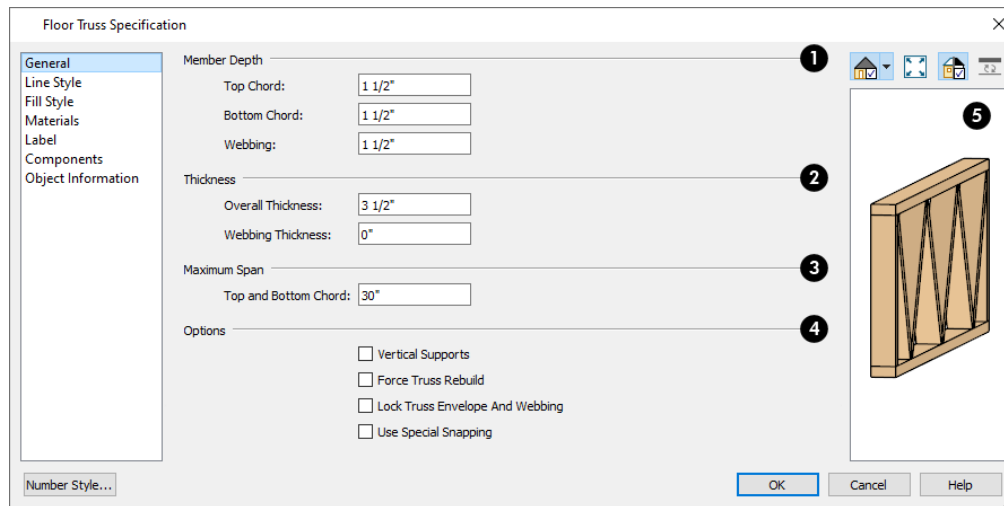

1 Member Depth

Specify the **Member Depth** of the different components of the selected truss.

- Specify the depth of the **Top Chord**.
- Specify the depth of the **Bottom Chord**.
- Specify the depth of the **Webbing**.

2 Thickness

Specify the **Thickness** of the truss's chords and webbing.

- Specify the **Overall Thickness** of the selected truss.
- Specify the thickness of the **Webbing**.

3 Maximum Span

Specify the **Maximum Span**, which is the maximum horizontal distance between supports along the **Top and Bottom Chord**.

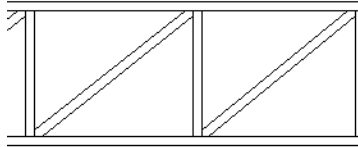

4 Options

- Check **Vertical Supports** to use vertical supports in the selected truss.
- Check **Force Truss Rebuild** to rebuild the truss envelope based on the existing floor or ceiling platform when you click OK. Not available if Lock Truss Envelope and Webbing is checked, below. See [Force Truss Rebuild on page 647](#).
- Check **Lock Truss Envelope and Webbing** to lock the size and configuration of the truss. A locked truss which has been relocated will maintain its original settings. See [Lock Truss Envelope and Webbing on page 647](#).
- Uncheck **Use Special Snapping** to prevent the selected truss from snapping along its long edge to a wall's Main Layer or to the corner of a roof plane. If disabled, **Object Snaps**  may still occur. See [Special Truss Snapping on page 646](#).

5 Preview

A preview of the selected truss displays on the right side of the panel. See [Dialog Preview Panes on page 20](#).

LINE STYLE PANEL

The settings on this panel affect the appearance of the selected truss in plan view only. See [Line Style Panel on page 204](#).

FILL STYLE PANEL

The settings on this panel affect the appearance of the selected truss in plan view only. See [Fill Style Specification Dialog on page 131](#).

MATERIALS PANEL

The settings on the MATERIALS panel affect the appearance of the selected truss in 3D views. See [Materials Panel on page 716](#).

LABEL PANEL

Floor and ceiling truss labels can display in plan view when the "Framing, Floor/Ceiling Truss Labels" layer is turned on and use the Text Style assigned to that layer. See [Text Styles on page 360](#).

For more information about the settings on this panel, see [Label Panel on page 363](#).

COMPONENTS PANEL

The information on the COMPONENTS panel can be used in the materials list. For more information, see [Components Panel on page 921](#).

OBJECT INFORMATION PANEL

The information entered on the OBJECT INFORMATION panel can be used in the materials list. For more information, see [Object Information Panel on page 922](#).

Framing and Truss Schedules



The **Framing Schedule** tool allows you to produce customizable framing and truss schedules as well as object labels that display schedule numbers. See [Schedules and Object Labels](#).

Framing schedules created in a Truss Detail use a special **Only Include Objects from this Detail** setting and a selection of Objects to Include that report only floor, ceiling, and roof trusses. See [Truss Details](#).

Trim and Moldings

Chapter 25

The Trim Tools allow you to place corner boards and quoins at wall intersections that form corners.

You can also assign moldings to a variety of objects, such as rooms and cabinets, in those objects' specification dialogs. See *Specification Dialogs on page 19*.

TOPICS

Trim and Molding Defaults	660
Corner Boards	660
Corner Board Specification Dialog	661
Quoins	662
Quoin Specification Dialog	662
Editing Corner Boards and Quoins	664
Millwork	665
Applying Moldings	665

Trim and Molding Defaults



Select **Edit> Default Settings** to open the Default Settings dialog where you can access the defaults for a variety of drawing tools, including a number that affect trim and moldings.

- Click the + beside “Corner Trim” to access the defaults for Corner Boards and Quoins. See [Corner Boards on page 660](#) and [Quoins on page 662](#).
- Click the + beside “Floors and Rooms”, then beside “Floor Levels”. Select a floor level and click the **Edit** button to specify the default moldings for rooms on that floor. See [Floor Level Defaults on page 281](#).
- Click the + beside “Door” to access the defaults for Interior and Exterior Doors. See [Door Defaults on page 366](#).
- Select “Window” and click the **Edit** button to specify the default casing for windows. See [Window Defaults on page 394](#).
- Click the + beside “Cabinet” to access the defaults for the Cabinet Tools, where you can specify default crown and other moldings. See [Cabinet Defaults on page 432](#).

Corner Boards



Corner boards are added to a building exterior in any view by selecting **Build> Trim> Corner Boards**.

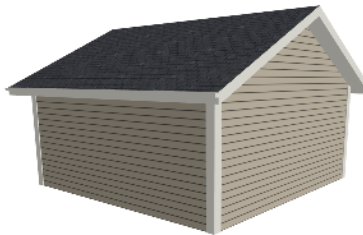

Click at a wall corner where you want to add trim. Be sure to click where the outside wall surfaces meet. If you click where the inside surfaces meet, corner trim will be created inside the room.

You can also add Corner Boards to all exterior corners at once by selecting **Build> Trim> Auto Place Corner Boards** .

By default, **Auto Place Corner Boards**  adds Corner Boards to outside corners only. If you prefer, you can specify that inside corners receive corner boards in the Corner Board Defaults dialog. See [General Panel on page 661](#).

Note: The Auto Place Corner Boards tool does not place corner boards on manually drawn dormers or at intersections with Attic Walls. See [Attic Walls on page 254](#).

Corner boards extend from the top plate down to the bottom of the floor platform of the floor on which it is placed, but do not extend to other floors. You must add corner boards to all floors of the building that you want to have corner boards.

A selected corner board or boards can be moved, but only to another wall corner or corners. In 3D views, corner boards can be lengthened or shortened using the edit handles. Corner boards can be copied, deleted and resized similar to other objects using the Edit Toolbar or the Corner Board Specification dialog. See [Corner Board Specification Dialog on page 661](#).

The default material for corner boards is defined by the **Exterior Trim** entry in the Material Defaults dialog. See [Material Defaults on page 712](#).

Corner Board Specification Dialog

Select one or more corner boards and click the **Open Object** edit button to open the Corner Board Specification dialog.

The settings in this dialog are similar to those in the Corner Board Defaults dialog, but affect the selected corner boards rather than all subsequently created corner boards.

GENERAL PANEL

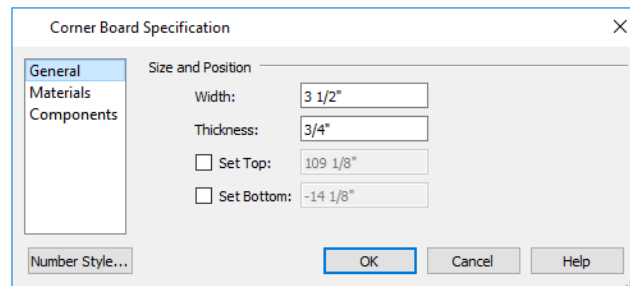

Specify the **Width** and **Thickness** of the selected corner board(s).

Check **Set Top/Set Bottom** to specify the top and bottom heights of the corner board(s).

- If **Set Top** is unchecked, the top of the corner board automatically extends to the top plate.
- If **Set Bottom** is unchecked, the bottom of the corner board automatically extends to the bottom of the floor platform.

In the Corner Board Defaults dialog, an additional **Auto Place Option** is available.

- Check **Include Inside Corners** to place Corner Boards on inside corners when the **Auto Place Corner Boards**  tool is used. When unchecked, only outside corners receive corner boards.

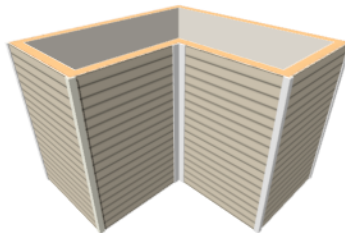

MATERIALS PANEL

The settings on the MATERIALS panel are available for a wide variety of objects in the program. For information about these settings, see [Materials Panel on page 716](#).

COMPONENTS PANEL

The information on the COMPONENTS panel can be used in the materials list. For more information, see [Components Panel on page 921](#).

Quoins



Select **Build> Trim> Quoins** in any view and click at a wall corner where you want to place quoins.

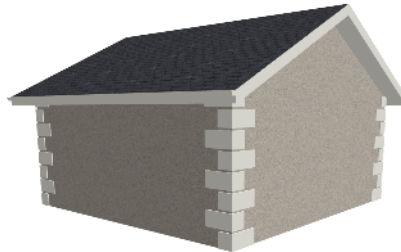

You can also add Quoins to all exterior corners at once by selecting **Build> Trim> Auto Place Quoins** .

By default, **Auto Place Quoins**  adds Quoins to outside corners only. If you prefer, you can specify that inside corners receive quoins in the Quoin Defaults dialog. See [General Panel on page 661](#).

Note: The Auto Place Quoins tool does not place quoins on manually drawn dormers or at intersections with Attic Walls. See [Attic Walls on page 254](#).

A selected quoin or quoins can be moved, but only to another wall corner or corners. In 3D views, quoins can be lengthened or shortened using the edit handles. Quoins can be copied, deleted and resized similar to other objects using the Edit Toolbar or the Quoin Specification dialog. See [Quoin Specification Dialog on page 662](#).

The size of quoins in plan view is relative on their size in 3D.

Initially, quoins use the same material as the default material of the wall surface they are placed against. This material is specified in the Wall Type Definitions dialog. See [Wall Specification Dialog on page 262](#).

Quoin Specification Dialog



Select one or more quoins and click the **Open Object** edit button to open the Quoin Specification dialog.

The settings in this dialog are the same as those in the Quoin Defaults dialog, but affect the selected quoins rather than all subsequently created quoins.

GENERAL PANEL

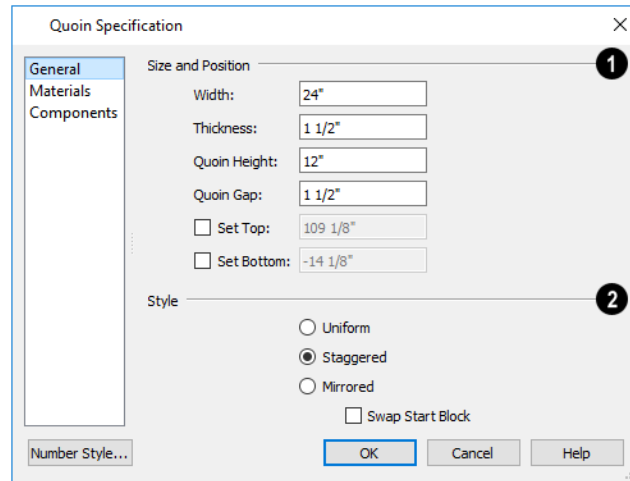

1 Size and Position

- Specify the **Width**, which is the horizontal dimension of each quoin in the selected Quoin object. The dimension along the other wall is half this value when they are staggered or mirrored.
- Specify the **Thickness**, which is the amount that the quoin protrudes from the exterior surface of the wall.
- Specify the **Quoin Height** for individual quoins in the selected Quoin object.
- Specify the **Quoin Gap**, which is the distance between successive quoins.
- Check **Set Top/Set Bottom** to specify the top and bottom heights of the quoin(s) in the text fields.
- If **Set Top** is unchecked, the top of the corner board automatically extends to the top plate.
- If **Set Bottom** is unchecked, the bottom of the quoin automatically extends to the bottom of the floor platform.

2 Style

- **Uniform** - Produce quoins that are of equal length on both sides of the corner.
- **Staggered** - Produce quoins that have one long side and one short side staggered on opposite sides of the corner.
- **Mirrored** - Produce quoins that alternate having either two long sides or two short sides.
- When Staggered or Mirrored is selected, check **Swap Start Block** to switch the starting order for the quoins.

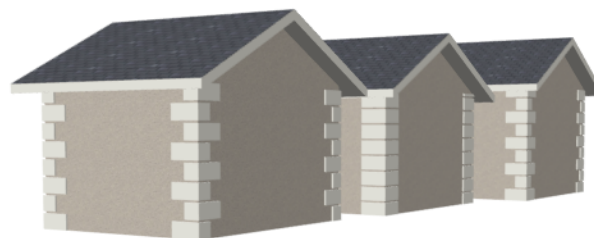

In the Quoin Defaults dialog, an additional **Auto Place Option** is available.

- Check **Include Inside Corners** to place Quoins on inside corners when the **Auto Place Quoins**  tool is used. When unchecked, only outside corners receive quoins.

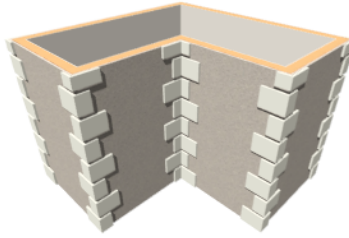

MATERIALS PANEL

The settings on the MATERIALS panel are available for a wide variety of objects in the program. For information about these settings, see [Materials Panel on page 716](#).

COMPONENTS PANEL

The information on the COMPONENTS panel can be used in the materials list. For more information, see [Components Panel on page 921](#).

Editing Corner Boards and Quoins

Before a corner board or quoin can be edited, it must be selected. Click on a trim object when the **Select Objects**  tool is active. Corner boards and quoins can also be group selected and edited. See [Selecting Objects on page 141](#).

Corner boards and quoins can be edited using their edit handles, the Edit Toolbar buttons, and their specification dialogs. See [Corner Board Specification Dialog on page 661](#) and [Quoin Specification Dialog on page 662](#).

USING THE EDIT HANDLES

Depending on the type of view, a corner board or quoin displays a different set of edit handles when selected.

- In plan view, corner boards and quoins display one edit handle and can be moved from one eligible location at a wall corner to another.
- In 3D views, corner boards and quoins can be moved, lengthened, and shorted much the other line-based objects are. See [Editing Line-Based Objects on page 145](#).

USING THE EDIT BUTTONS

A selected corner board or quoin can be edited in a variety of ways using the buttons on the Edit Toolbar. See [The Edit Toolbar on page 91](#).

DELETING CORNER TRIM

Corner boards and quoins can be selected individually or in groups and deleted using the **Delete**  edit button or the Delete key on the keyboard. They can also be removed using the Delete Objects dialog. See [Deleting Objects on page 187](#).

Millwork

A selection of various types of millwork including columns, corbels and finials is available in the Library Browser. See [The Library Browser on page 669](#).

Most millwork objects are designed to be placed in a plan as free-standing objects. Some - notably, newels and balusters - can be assigned to objects such as railings and stairs. See [Placing Library Objects on page 686](#).

Millwork assigned to an object can be replaced from the library in 3D views. See [Replace From Library on page 689](#).



Applying Moldings

Moldings can be applied to rooms, doors, windows, and cabinets.

REPLACING AN EXISTING MOLDING



If a molding profile has already been applied to an object, it can be replaced by another directly from the library in a 3D view. Select **Build> Trim> Replace Moldings**, select a molding profile from the Select Library Object dialog, then move the mouse pointer into the view window and click on a molding in the view. See [Select Library Object Dialog on page 688](#) and [Replace From Library on page 689](#).

You can also select a molding profile directly from the Library Browser while a 3D view is active and move your mouse pointer into the view window. When a molding is selected, the pointer displays the Moldings  icon. When the mouse pointer is moved over a molding in the view, the Replace From Library  icon displays instead. Click on the molding's surface to change its molding profile.

MOLDINGS PANEL



The specification dialogs for a variety of objects in the program include a MOLDINGS panel. Select an object or group of similar objects and click the **Open Object** edit button to open the specification dialog for that selection.

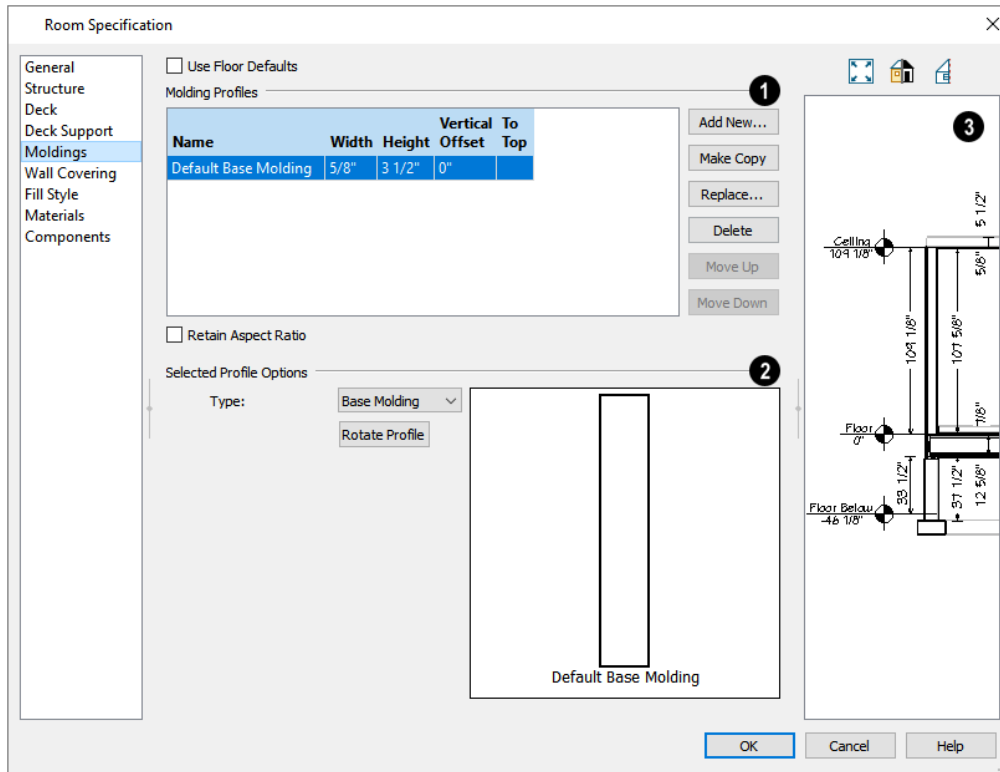

At the top of the dialog, one or more check boxes may be present.

- Only available for rooms, uncheck **Use Floor Default** to make the settings that follow active. Check this box to use the defaults set in the Floor Defaults dialog for the current floor. In the Room Type Defaults dialogs, the settings for Floor 1 are shown in the preview when this is checked. See *Floor Level Defaults on page 281*.
- If multiple objects with different moldings assigned to them are selected, a **No Change** check box will be available. Uncheck this box to make the settings that follow active but note that only moldings that all selected objects have in common will be retained.

Note: If multiple rooms are selected and only some of them have Use Default checked, these settings on this panel will not be editable.

1 Molding Profiles

The selected object's **Molding Profiles** are listed in a table and can be edited here.

- Select the name of a molding to edit it or remove it from the object.
- Click in the **Width** and/or **Height** column and type to specify the selected molding's size.
- Specify the **Vertical Offset** of the selected molding, measured relative to the default molding location on the object it is assigned to.
- A check mark in the **To Top** column means that the Vertical Offset value is measured from the top of the molding. When unchecked, this value is measured from the bottom of the molding. Click to place or remove a check mark.
- When **Retain Aspect Ratio** is checked, if you change either the Height or Width, the other value changes to maintain their original ratio. When this is unchecked, the two values can be edited independently.

The buttons on the right allow you to manage the moldings listed in the table.

- **Add New** opens the Select Library Object dialog and add a new molding profile to the selected object. See [Select Library Object Dialog on page 688](#).
- Click the **Make Copy** button to add a copy of the selected molding profile at the bottom of the list.
- **Replace** removes the selected profile and replace it with a new profile from the Library.
- **Move Up** and **Move Down** change the order of the line items in the table. This does not change a selected item's Height, Offset, To Top setting, or Type: only its position in the table.
- Click the **Add to Library** button to save a copy of the molding as specified here in the User Catalog. See [Adding Library Content on page 681](#).

2 Selected Profile Options

The **Selected Profile Options** only apply to the molding profile selected above.

- A preview of the molding profile(s) displays here. When multiple moldings of the same Type, To Top setting, or similar Height are specified, they will display together here, even when only one is selected. The selected profile is identified by thicker edge lines than the others. When multiple moldings of different Types, To Top, or Height settings are selected, no preview will display.
- When a room or cabinet is selected, choose a molding **Type** from the drop-down list. For rooms, the choices are "Base Molding", "Chair Rail", and "Crown Molding"; for base cabinets, "Edge Profile" and "Base Molding"; for wall cabinets, "Crown Molding" and "Light Rail"; and for full height cabinets, "Crown Molding" and "Base Molding". When a molding profile's Type is changed, its To Top setting may also change, above. See [Room Moldings on page 300](#) and [Cabinet Hardware and Moldings on page 447](#).
- Click the **Rotate Profile** button to rotate a selected profile 90° counterclockwise, or to the left.

Note: The Default Base Molding is a basic rectangular stock profile rather than a profile from the library.

3 Preview

Many specification and defaults dialogs have previews of the selected object in which the moldings assigned to it can be seen. See [Dialog Preview Panes on page 20](#).

When **Use Floor Default** is checked in the Room Type Defaults dialog, this preview always shows the default moldings for Floor 1.

The Library

Chapter 26

Home Designer Pro’s library offers thousands of symbols, materials, and images that can enhance any plan.

New library catalogs and enhancements are made available by Chief Architect Software on a continuing basis and are available for download for the current program version.

You can also customize items from the library or import new items from outside the program and then save them in the library for future use.

TOPICS

The Library Browser	669
Searching the Library	675
Find in Library	676
Library Content	677
Downloading Library Content	678
Importing Library Catalogs	679
Adding Library Content	681
Organizing the Library	682
Filtering the Display of Library Content	684
Exporting Library Catalogs	686
Placing Library Objects	686
Select Library Object Dialog	688
Place Library Object Button	688
Replace From Library	689
Displaying Library Objects	690
Editing Library Objects	691
Symbol Object Specification Dialogs	693

The Library Browser



The Home Designer Library Browser allows you to manage the contents of the library as well as add library content to your drawings.

To open the Library Browser:

- Select **View > Library Browser**.
- Click the **Library Browser**  button.
- Press **Ctrl + L** on your keyboard.

By default, the Library Browser is docked to the right side of the program window, but can be undocked or docked to another side. See [Docking the Library Browser on page 674](#).

The Library Browser has four sections:

- The search options at the top.
- The Directory and Search Results Pane.
- The Selection Pane.
- The Preview Pane.

To adjust the height or width of a section, place the pointer over the split bar you want to move. When the double-headed arrow  displays, click and drag.



You can control the configuration of the Library Browser panes in the Preferences dialog. See [Library Browser Panel on page](#)

[64](#).

You can work on your drawing with the Library Browser open. To close the Browser, click the Close  button or double-click on an object in the Selection Pane.

The library directory is presented in a tree list with five categories: Home Designer Core Catalogs, Home Designer Bonus Catalogs, Manufacturer Catalogs, User Catalog and Trash. See [Library Content on page 677](#).

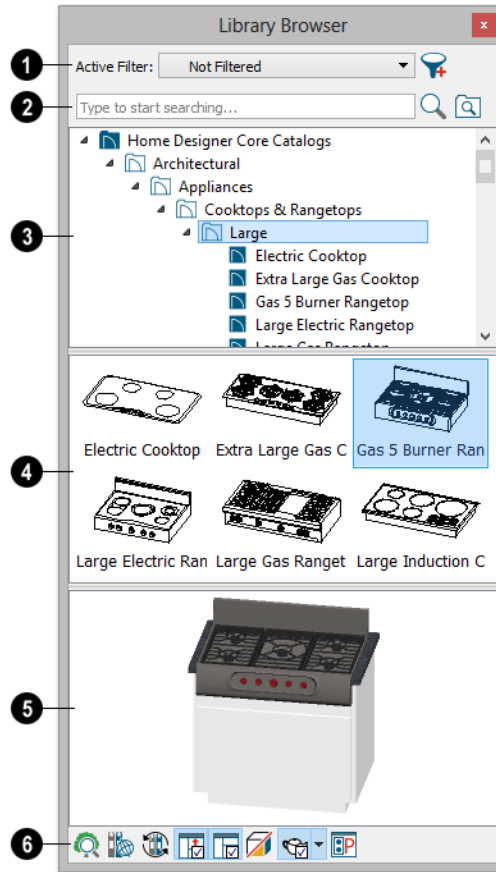



1 Active Filter

Specify what displays in the Directory Pane’s tree list by selecting a filter from the drop-down list. See *Filtering the Display of Library Content on page 684*.

- When “Not Filtered” is selected, all installed library content will display in the tree list.
- “Not Filtered” will be the only available option until you create a custom filter.
- Click the **Manage Library Filters**  button to open the Manage Library Filters dialog. See *Manage Library Filters Dialog on page 685*.

2 Search

Search the library using keywords and optional search filters. See [Searching the Library on page 675](#).

- Begin typing in the text field to search for library items. As you type, search results will display in the Directory Pane.
- Search a specific catalog or folder by right-clicking on it and selecting Search Folder. Multiple items can be searched in this manner.
- Right-click on an item in the Search Results list and select **Show in Browser** to view the item's location in the Directory list.
- Click the **Browse**  button to stop searching and restore the Directory list.
- Click the **Search**  button to display the search results for your search entry.
- Click the **Search Filtering Options**  button to customize your search parameters. If the Library Browser is resized so that it is narrow, this button will be replaced by two arrows.

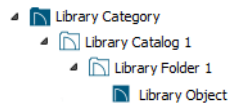

3 Library Pane

The library **Directory** and **Search Results** display here. The basic structure of the directory tree is:



Library items are always placed in alphabetical order within their hierarchy.

The Library Browser includes a Trash bin, where deleted items are moved until you choose to Empty Trash. See [Deleting Library Items on page 684](#).

Navigate the Directory Pane using the mouse. Click the gray Expand arrow  beside a catalog or folder to display its contents. Once expanded, you can click the black Collapse arrow  to close it again. You can also browse the list using the arrow keys on your keyboard.

Click on an item to select it. Preview images display in the Selection and Preview Panes and basic information about it also displays in the program's Status Bar. See [The Status Bar on page 23](#).

4 Selection Pane

The **Selection Pane** shows a thumbnail image of the item selected in the Directory Pane.

When an item is selected in the Directory Pane, a basic line-based representation of the item displays in the Selection Pane.

- If the selected item is a single object, a preview of that object displays in the Preview Pane. You can move your cursor into the drawing area to place the item. See *Placing Library Objects on page 686*.
- If the selected item is a folder, a thumbnail image displays, representing each item inside. Move your pointer over an item in this pane to see a Tool Tip with the item's name. Click on a folder in the Selection Pane to display its contents here and make it the item selected in the Directory Pane.
- Some folders may have too many items to display useful thumbnails for each; when this is the case, they do not display.

If you have **Scrollable List** checked in the Preferences dialog, a scrollbar is present at the bottom of the Selection Pane.

Click the **Show/Hide Selection Pane**  button to toggle the Selection Pane on and off.

5 Preview Pane

When an individual item is selected in either the Directory or Selection Pane, an image of it displays in the **Preview Pane**. If the item is designed to be inserted into another object such as a cabinet, that parent object will also display in the preview.

You can click the **Toggle Preview Display**  button at the bottom of the browser window to switch between preview images in Standard Render and Vector View styles.

If the selected object is a 3D symbol, you can rotate and zoom in or out on the Preview using the mouse.

If you have rotated a view in the Preview Pane, you can restore the default angle either by clicking in the Selection Pane or by right-clicking on the Preview Pane and selecting **Reset Preview**.

Click the **Show/Hide Preview Pane**  button to toggle the Preview Pane on and off.

6 Toolbar

The toolbar at the bottom of the browser aids in searching, displaying panes, and managing library content.



Open the Plant Chooser dialog. See [Plant Chooser Dialog on page 891](#).



Get Additional Online Content launches your default web browser to the Home Designer website, where additional library content is available for download.



Update Library Catalogs downloads and installs updates to your installed catalogs to include the latest content. See [Updating Library Catalogs on page 677](#).



Show/Hide Selection Pane toggles the Selection Pane on and off.



Show/Hide Preview Pane toggles the Preview Pane on and off.



Toggle Preview Display switches between Standard Render and Vector View images of a selected library object in the Preview Pane. See [Rendered and Vector Views on page 736](#).



A selected material will display on a shape in the Preview Panel. The initial shape is a Sphere, but you can select a Cube, Teapot, or 2D Plane instead if you prefer. The object shape selection is also shared with the Define Material dialog. See [Define Material Dialog on page 726](#).



Open the Preferences dialog, where display properties for the Library Browser can be controlled. See [Library Browser Panel on page 64](#).

USING THE CONTEXTUAL MENUS

A number of important library functions can be accessed using the contextual menus. Right-click on an item in the Library Browser to open a contextual menu displaying options related to that item. See [Contextual Menus on page 18](#).

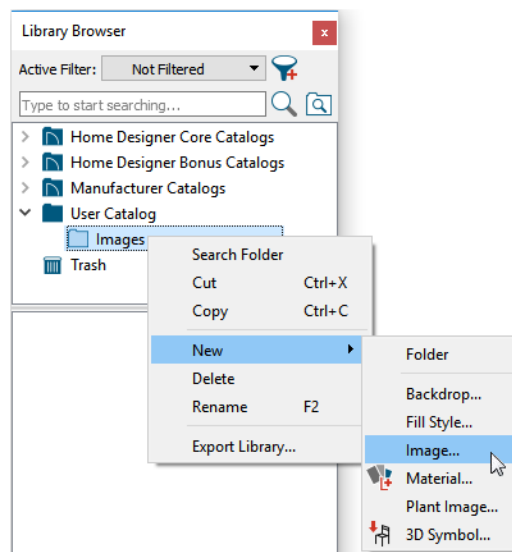

The options in the contextual menu vary depending on the item selected, but may include:

- Search Folder
- Cut/Copy/Paste
- Copy to User Catalog

- Paste Shortcut
- Locate Shortcut Source
- New
- Rename
- Delete
- Export Library
- Open Object
- Reset Preview
- Expand All/Collapse All
- Show in Browser

KEYBOARD COMMANDS

The Library Browser can be navigated using the arrow keys on your keyboard.

- The right and left arrow keys expand and collapse folders.
- The up and down keys change which library object is currently selected.
- Select an item and press F2 to rename it.
- Select an item and press the Delete key to delete it.

If you have **Scrollable List** selected in the Preferences dialog, pressing the Tab key switches focus between the Directory and Selection Panes. Use your mouse to select an object for placement. See *Library Browser Panel on page 64*.

If you have **Tiled To Fit Window** selected instead, pressing the Tab key switches focus between the tree view and the Selection Pane. You can then use the arrow keys to select a library object within the Selection Pane.

EXPAND/COLLAPSE ALL

When a library category or folder is selected in the Directory Pane, **Expand All** and **Collapse All** are available in the contextual menu, allowing you to expand or contract its contents in the tree view.

DOCKING THE LIBRARY BROWSER

Initially, the Library Browser side window is docked to the right side of the main Home Designer program window. To undock it, click and drag its title bar towards the center of the program window. Once undocked, it can be moved and redocked in the same manner. See *Side Windows on page 16*.

When moved to the top, bottom, or side of the program window, it automatically docks in a vertical or horizontal orientation, depending on its location. You can prevent the Library Browser from docking when dragged:

- In the Preferences dialog. See *Appearance Panel on page 60*.
- By holding down the **Ctrl** key while dragging it.

To return the Library Browser to its original position and size, click the **Restore Position/Size** button in the Preferences dialog. See *Reset Options Panel on page 86*.

CLOSING THE LIBRARY BROWSER



The Library Browser can be closed in either of two ways:

- Click the Close **×** button at the top right corner of the browser window.
- Select **View > Library Browser** .

Searching the Library

The Library Browser filtering options let you focus your searches to meet parameters that you define.

To search the Library Browser

1. Select **View > Library Browser**  and click in the Search field at the top of the Library Browser.
2. Begin typing a keyword to search for. As you type, the search results will populate in the Directory Pane below.
 - Use Boolean keywords (NOT, AND, OR), capitalized and with spaces, to refine your search. Shortcuts (!, +, |) can be used, as well.
 - Boolean keywords' are prioritized from highest to lowest in this order: not, and, or. Parentheses can also be used.
 - Use quotation marks "" to search for an exact word or phrase. Quotation marks around a Boolean keyword will treat the keyword as a normal search term.
3. You can click the **Clear**  button on the right side of the Search field to remove anything typed in this field.
4. If you move your mouse pointer over the Search field, a Tool Tip will state the number of results of your search.
5. Right-click on an item in the Search Results list and select **Show in Browser** to view the item's location in the Directory list.

You can also search the contents of one or more specific catalogs and/or folders. Right-click on a catalog or folder level item or group-select multiple catalogs and/or folders and right-click on them, select **Search Folder** from the contextual menu, and proceed with step 2, above. See *Shift and Ctrl Select on page 144*.

Substrings are not included. For example, searching for "windows" will not produce "window" as a search result. On the other hand, searching for "window" will produce "windows" as a search result.

To search using custom filters

1. Click the **Search Filtering Options**  button.
 - Check **Keyword** to match the entered search keyword with an object's search attributes.
 - Check **Entire Word** to match the entire keyword or words with the complete name of the object.
 - Check **Folders** to include library folders in your search.
2. Click the arrow beside **Type**, **Style**, or **Manufacturer** to expand that category.
 - Check **Keyword** to match the entered search keyword with an object's search attributes.
 - Check **Entire Word** to match the entire keyword or words with the complete name of the object.
 - Check **Folders** to include library folders in your search.
3. Click the arrow beside **Type**, **Style**, or **Manufacturer** to expand that category.
 - Check the box beside one or more **Type** of library item that you want to include in your search.
 - Check the box beside one or more architectural or design **Style** to include items of that style in your search.

- Check the box beside one or more **Manufacturer** to include in your search. Manufacturer catalogs that were imported during the current program session will not be listed here until you exit out of and restart Home Designer.



To save time, check the box beside Type, Style, or Manufacturer to select all of the options in that category at once; uncheck the box to deselect all of the options.

4. Type a keyword in the **Search** field. The results will be filtered to match your selected filtering options.

Find in Library



You can find out whether a selected object is saved in the library and if so, where, using the **Find Original in Library** edit tool.

The **Find Original in Library** edit tool also allows you to locate any objects inserted into the selected object as well as any materials or moldings assigned to it. See *Inserted Objects on page 687*.

FIND IN LIBRARY DIALOG

The Find in Library dialog opens when you select one or more objects and click the **Find Original in Library**  edit button. This dialog lists all of the selected objects as well as all objects assigned to and inserted into them.

Highlighted line items are categories that may have multiple components beneath them.

- Check the box beside a line item to find that object in the library.
- Check the box beside a category heading to select all items in that category.

When you click OK, the dialog will close and one of three things will happen:

- If a single line item was selected in the Find in Library dialog was clicked, that item will be selected in the tree list of the Library Browser.
- If the single line item is not found in the library, a message box will inform you of this and give you the option of adding it to the library.
- If multiple line items were selected, the Show in Library Results dialog will open, summarizing the status of each.

SHOW IN LIBRARY RESULTS

If multiple line items are selected in the Find in Library dialog, the Show in Library Results dialog will report where, or if, they are found in the library.

Each line item selected in the Find in Library dialog is listed here.

- Click on a line item to select it. Multiple lines can also be selected. See *Shift and Ctrl Select on page 144*.
- Click the **Show in Library** button to locate and select the selected line item in the tree list of the Library Browser. Not available if the selected item is “Not Found in Library Browser”, or if multiple line items are selected.
- Click the **Add to Library** button to add the selected line item(s) to the User Catalog in the library.
- Click the **Done** button to close the dialog.

Library Content

The Home Designer Pro library has five categories: Home Designer Core Catalogs, Home Designer Bonus Catalogs, Manufacturer Catalogs, User Catalog and Trash.

HOME DESIGNER CORE CATALOGS

The Home Designer Core Catalogs category contains a wide selection of 3D symbols, images, and materials. If you install the program from USB drive, this library content will also be installed; if you download the software, you will be able to download the Core Catalogs separately, after the program is installed.

When you launch the program for the first time, it will ask if you want to download the Core Catalogs. Click Yes to begin the download. If you click No, you can download at any time by selecting **Library> Install Core Content** from the menu.

HOME DESIGNER BONUS CATALOGS

Chief Architect regularly posts new library catalogs available for download. Select **Library> Get Additional Content Online**  from the menu to access the bonus catalogs and content.

Most Bonus Catalogs can be purchased for a nominal fee, while others are available free of charge. In addition, some Bonus Catalogs are only available to Chief Architect Support and Software Assurance program members.

MANUFACTURER CATALOGS

A variety of name brand library catalogs is available for download on the Home Designer website with content ranging from materials to fixtures.

Select **Library> Get Additional Content Online**  to access these Manufacturer Catalogs.

As with the Bonus Catalogs, some Manufacturer Catalogs are available free of charge while others can be purchased, and some are available for Support and Software Assurance members only.

Note: Support and Software Assurance is an optional program for holders of Chief Architect Premier and Chief Architect Interiors software licenses and is not available for Home Designer licenses.

THE USER CATALOG

The User Catalog is the location for items that you add to the library either from a drawing or by importing. See [Adding Library Content on page 681](#).

You can create and organize custom library folders and imported items such as symbols, images, backdrops, and materials. See [Organizing the Library on page 682](#).

UPDATING LIBRARY CATALOGS

 The Home Designer Core Catalogs, Bonus Catalogs, and Manufacturer Catalogs are updated periodically to include new and improved content. You can update your installed catalogs to include the latest content by selecting **Library> Update Library Catalogs** at any time.

The program will gather information about the content in each of these three categories, and then download and replace any content that is not up to date, and you may see a progress indicator at the bottom of the Library Browser while it is doing so. See [Download Progress on page 679](#).

LIBRARY CONTENT LOCATION

All library content aside from your User Catalog is stored in the **System Library Database Folder**. By default, this folder is created in the directory intended for shared application data in your operating system (C:\ProgramData in Windows; /Library/Application Support in macOS).

The Home Designer User Catalog File, User_Library.calib, is saved in the **User Library Folder**, which is located in the Home Designer Pro 2022 Data folder by default. See [Home Designer Pro Data on page 33](#).

You can specify a different location for both if you wish in the Preferences dialog. If you choose a removable drive or network location, library slowness may result. See [Folders Panel on page 69](#).

If you choose to use a different location for your User Catalog, your existing User Library content as well as your Backdrops, Images, Patterns, and Textures folders will be moved there, as well. It is important that you specify a directory on a hard drive with sufficient space to hold these files.

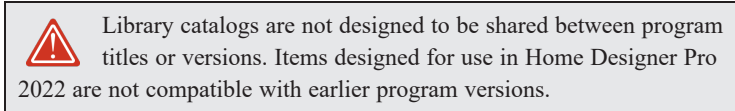

BACKING UP CUSTOM CONTENT

The best way to back up your custom library content is to export the items in your User Catalog, as this will ensure that the textures used by custom materials or imported symbols are not lost. See [Backing Up Your Files on page 39](#).

Exported libraries use the **.calibz** file format: a zipped file type that can include textures and images along with other library data.

To back up your custom library content

1. Launch Home Designer and open a plan file.
 2. If the Library Browser is not open, select **View > Library Browser**  from the menu.
 3. Right-click on a folder or item in the User Catalog.
 4. Select **Export Library** from the contextual menu.
 5. The Export Library Data dialog is a typical Save dialog. See [Exporting Files on page 38](#).
- Notice that the file type in the Save as type field is “Library File with Textures/Images (*.calibz)”.

Downloading Library Content

The Home Designer Core Catalogs, Home Designer Bonus Catalogs, Manufacturer Catalogs are all available for internet download.

CORE CATALOGS

When you launch Home Designer for the first time, you will be asked if you want to download the Core Catalogs. Click Yes to begin the download.

If you click No, you can download at any time by selecting **Library> Install Core Content** from the menu.

BONUS AND MANUFACTURER CATALOGS



Bonus and Manufacturer Catalogs can be downloaded from our website, www.HomeDesignerSoftware.com. Select **Library> Get Additional Content Online** to launch your default internet browser to our Content Resources page.

DOWNLOAD PROGRESS

When library content is downloading, a green progress bar will display at the bottom of the Library Browser. If you choose to download the Core Catalogs while the library is not open, the Browser will open so the progress indicator can display.

Click on the progress bar to display the name of the current file being downloaded, the total amount of data to be downloaded in KB, and the amount downloaded so far.

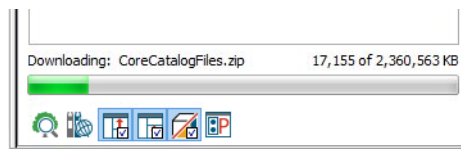

PAUSING AND RESUMING

Library downloads can only take place while Home Designer is running. If you close the program while a download is in progress, a dialog will confirm whether you wish to stop the download.

- Click **Stop Download and Close Program** to stop the download and close the program.
- Click **Cancel** to leave the program open and continue downloading.

Most catalogs are composed of a single file. If you stop the download midway, none of the downloaded data will be retained.

The Core Catalogs, on the other hand, contain a large volume of data saved in multiple files. If you close the program and stop the Core Catalogs download midway, only data associated with the file currently being downloaded will be lost. You can resume the download beginning with that file at a later time by selecting **Library> Install Core Content**.

DOWNLOAD ERRORS

If any problems occur during the library download process, a dialog box will notify you at the end of the download. Click **Retry Download** to repeat the download and correct any errors or click **Cancel** to discard the downloaded catalog.

Importing Library Catalogs

Home Designer library files have two different file extensions: **.calib** and **.calibz**. Both files can include any combination of Home Designer library items; in addition, **.calibz** files are able to save data associated with textures and images. Both file types can be imported into the Home Designer library.

There are several ways to import a **.calib** or **.calibz** file into the program library:

- Double-click on the file in an operating system window while a plan or layout file is open.
- Drag the file from an operating system window and drop it into the Home Designer program window.
- Select **Library> Import Library** from the program menu.

Although multiple versions of Home Designer can be installed on a computer, the operating system will only associate **.calib** and **.calibz** library files with one version. If they are not associated with Home Designer Pro 2022, click the **Associate Files with this Program** button in the Preferences dialog. See [File Management Panel on page 68](#).

Note: Library files cannot be imported if no plan or layout file is open, or when a Materials List window is active.

To import library files into the library

1. Select **Library> Import Library** to display the Import Library Data dialog.
2. Browse to the **.calib** or **.calibz** file(s) that you want to import and either single or group-select the files so that their names display in the **File Name** field.
 - To select a group of files, click on the first one, hold down the Shift key, then click on another file. The two files plus all files in between are selected.
 - To select multiple files individually, click on one, hold down the Ctrl key, then click on additional files. Only the files you click on are selected.
 - To select all files in the directory, click on one and press Ctrl + A. Only do this if you wish to import all files in the folder.
3. Click the **Open** button.
4. A progress bar will display, telling you the progress of each library data file as it is imported.
5. Once imported, each file will be listed in its corresponding library category and will be selected in the Library Browser tree list. See [Library Content on page 677](#).

When a **.calibz** file is imported into the program, any images or textures saved in it will be copied into the Home Designer Pro 2022 Data\ Images and Textures folders for backup purposes. The program will only reference these copies if it cannot locate the files in their original locations. See [Home Designer Pro Data on page 33](#).

LIBRARY CATALOG MIGRATION

If you have library catalogs from Home Designer Pro 2014 through 2021 installed on your computer, the initial startup of Home Designer Pro 2022 will give you the opportunity to migrate that content into the Version 2022 Library.

LEGACY LIBRARY CONVERSION

You can import **.calib** and **.calibz** files created in Home Designer versions 2012, 10, or 9 for use in Version 2022 at any time. See [Exporting Library Catalogs on page 686](#).

Note: Library content exported from Home Designer 10 will not include catalog names. Any subscribed content from Version 10 that has not been downloaded will not be included, either.

In addition, legacy **.alb** files created in Home Designer Versions 8.0 and 7.0 and prior can be converted for use in Version 2022. Conversion of legacy **.alb** files from Version 6 is not supported.

To convert legacy library files

1. Select **Library> Convert Legacy (.alb) Library Files**.
2. In the Select a Legacy Library File Folder dialog, select one or more **.alb** files that you want to bring in to Home Designer 2022.

3. The selected files' names will display in the **File name:** field.
4. Click the **Open** button to import these legacy library files into the User Catalog.
5. Organize the imported content to suit your needs. See [Organizing the Library on page 682](#).

Adding Library Content

In addition to downloading Home Designer Content and importing entire catalogs into the library, you can also add a variety of individual objects to the library.

ADD TO LIBRARY

Nearly any object imported into a plan or placed from the Library Browser can be added to the User Catalog in the library.

- Select one or more objects in your plan and click the **Add to Library**  edit button.
- Check **Add to Library** in the Import 3D Symbol dialog. See [Importing 3D Symbols on page 840](#).

A few objects cannot be added to the library: notably terrain objects, CAD objects, imported pictures, metafiles, and PDF files.

Any object created using a drawing tool in Home Designer will automatically be added to the User Catalog using the name of that tool, whereas a symbol will automatically use the Symbol Name. See [Native Objects vs Symbols on page 692](#).

If multiple identical objects are selected when the Add to Library button is clicked, only one instance will be added to the User Catalog.

Once added to the library, objects in the User Catalog can be renamed and edited. See [Renaming Library Items on page 683](#).

USING THE CONTEXTUAL MENU

A variety of new content can be added to the User Catalog by right-clicking on it or on a folder within it and selecting **New>** from the contextual menu:

- Backdrops - See [3D Backdrops on page 812](#).
- Fill Styles - See [Fill Styles on page 130](#).
- Images - See [Images on page 795](#).
- Line Styles - See [Line Style Specification Dialog](#).
- Materials - See [Creating Materials on page 721](#).
- Plant Image - See [Plant Image Specification Dialog on page 893](#).
- 3D Symbols - See [Importing 3D Symbols on page 840](#).

See also [Using the Contextual Menus on page 673](#) and [Adding New Folders on page 682](#).

CREATING A CUSTOMIZED LIBRARY ITEM

You can customize an existing library item and save your changes for future use by first copying the item into the User Catalog.

To customize a library object

1. Right-click on a library item and select **Copy to User Catalog** from the contextual menu.
2. If the library item is already located in the User Catalog, instead select **Duplicate** from the contextual menu.
3. Right-click on the copied item and select **Open Object**  from the menu.
4. The item's specification dialog opens, and you can make any changes that you wish to the item.
5. Make any needed changes to the item, then click OK. Your changes will be saved with this item for use in any plan.

Organizing the Library

Library folders and objects can be copied, pasted, moved, and deleted: allowing you to organize your User Catalog to best suit your work style and needs.

ADDING NEW FOLDERS

New folders can be added to the User Catalog or to any folder located within it. To add a new folder, right-click on User Catalog or one of its sub-folders and select **New> Folder** from the contextual menu.

The new folder is created inside the library item you right-clicked on and is initially named “Untitled”. Type a short, descriptive name and press Enter.

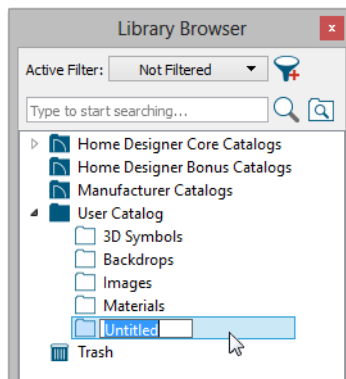

SELECTING LIBRARY ITEMS

To select a library object, folder, or category, simply click on it. You can also multiple-select library items:

- To select a group of items, click on the first one, hold down the Shift key, then click on another file. The two files plus all files in between are selected.
- To select multiple items individually, click on one, hold down the Ctrl key, then click on additional files. Only the files you click on are selected.

When an item is selected, preview images display in the Selection and Preview Panes and basic information about it also displays in the program's Status Bar. See [The Status Bar on page 23](#).

A selected library item can be modified in a number of ways to help meet your organizational needs. When multiple items are selected, these options may be limited depending on the specific selection set.

RENAMING LIBRARY ITEMS

Only folders and objects in the User Catalog can be renamed. There are several ways to do this from the tree list:

- Right-click on the item, select **Rename** from the contextual menu, and type a new name.
- Click once on the item, press F2 on your keyboard and type a new name.
- Click once on the item, pause for a moment, then click a second time and type a new name.

Library names are case-sensitive and can contain up to 63 characters. While you can have more than one library item that uses the same name, it is best to use short, descriptive and unique names.

MOVING LIBRARY ITEMS

Folders and objects in the User Catalog can be moved to new locations within the User Catalog. Folders and library objects are always organized alphabetically within each hierarchy.

To move one or more items to a different location, select it in the tree list, then click and drag it to the new location in the list. Directories and folders able to accept new content highlight as your mouse pointer moves over them. Release the mouse button to relocate the selected library item in the highlighted location.

You can also cut one or more library items from one location and paste them in another. When an item is cut, it is removed from its current location and saved to the system clipboard. To cut an item:

- Right-click on it and select **Cut** from the contextual menu.
- Click on the library item and press Ctrl + X on your keyboard.

To **Paste** the item, click on a library catalog or folder in the Library Browser tree view and either:

- Right-click on the new location and select **Paste** from the contextual menu.
- Press Ctrl + V on your keyboard.

COPYING LIBRARY ITEMS

All library folders and library objects can be copied and pasted to new locations in the User Catalog.

There are two ways to copy one or more library items to the system clipboard:

- Right-click on it and select **Copy** from the contextual menu.
- Click on the library item and press Ctrl + C on your keyboard.

To **Paste** the item, click on a library catalog or folder in the Library Browser tree view and either:

- Right-click on the new location and select **Paste** from the contextual menu.
- Press Ctrl + V on your keyboard.

When a library item is copied and pasted, the new item that results is independent of the original item. If you make changes to it, the original item is unaffected. Similarly, changes to the original item do not affect the copy.

LIBRARY SHORTCUTS

In addition to copying and pasting to create new, independent library items, you can copy and paste to create Library Shortcuts. Library Shortcuts are not independent items - they are linked to the original item and are affected if changes are made to the original.

Library Shortcuts are advantageous because you can place a given library item in multiple locations to suit your organizational style without increasing the size of the library database and without having to maintain multiple copies of the same item.

To create a Library Shortcut, copy a library item to the system clipboard. Then, right-click on the location where you would like to create a copy and select **Paste Shortcut** from the contextual menu. Library Shortcuts use the same name as their source item but use the Library Shortcut  icon.

To locate a Library Shortcut's source item, right-click on it in the tree list and select **Locate Shortcut Source**.

If you move or delete an item from the library, any shortcuts to it will not be updated or removed. If you try to use a "hanging" shortcut, a message about its status will display in the library preview panes.

DELETING LIBRARY ITEMS

The five installed library categories: Home Designer Core Catalogs, Home Designer Bonus Catalogs, Manufacturer Catalogs, User Catalog, and Trash cannot be deleted.

Catalog level folders in all categories can be deleted; however, individual subfolders and objects can only be deleted out of the User Catalog.

Items in the library that are eligible for deletion can be deleted in either of two ways:

- Right-click on it and choose **Delete** from the contextual menu.
- Select it and press the **Delete** key on your keyboard.

When items from the User Catalog are deleted, they are moved to the Library Browser Trash . Items in the Trash can be retrieved by clicking and dragging them into any location in the User Catalog.

To empty the Trash, right-click on it and select **Empty Trash** from the contextual menu.

Depending on how much content is in the Trash, emptying it can be time consuming. You can click the **Cancel** button to end the process if you wish.



 The Empty Trash command is both immediate and permanent. It cannot be undone, so use care when using it. You should back up all your library files regularly. See [Backing up Custom Content on page 678](#).

Filtering the Display of Library Content

 Depending on how much library content you have imported or customized, the tree list in the Directory Pane can be very large. You can control what content displays in the list using **Library Filters**.

Library Filters do not remove content from the library database. They do, however, affect the library Search: unless you check **Include Filtered** in the advanced Search options, library content that is not displaying is not included in your searches.

You can also set up filters for your library Search results, but these two types of filters are unrelated. See [To search using custom filters on page 675](#).

Library filters can be created, edited, and deleted in the Manage Library Filters dialog. Click the **Manage Library Filters**  button at the top of the Library Browser to open this dialog or select **Library > Manage Library Filters**  from the menu.

 You can also add the Manage Library Filters button to your toolbars and assign a hotkey to it. See *Toolbars and Hotkeys on page 89*.

Any filters that you create will be in the **Active Filter** drop-down list at the top of the Library Browser. Select a filter from the list to display content in the library tree list according to its settings. See *The Library Browser on page 669*.

MANAGE LIBRARY FILTERS DIALOG

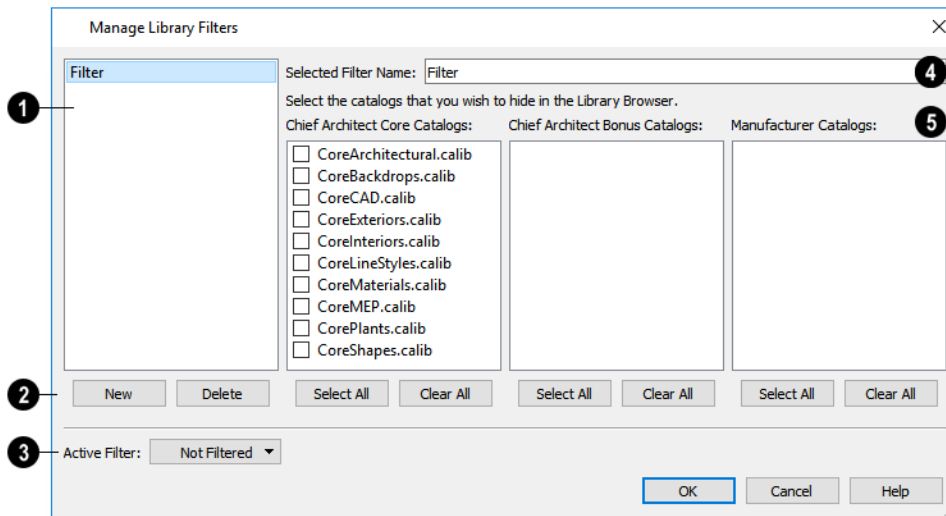

1 Filters

A list of available library filters displays here. Click on a name in the list to select it. The Selected Filter is highlighted and can be edited using the options to the right.

2 New / Delete

Click the **New** button to create a new filter or click the **Delete** button to remove the Selected Filter from the list.

3 Active Filter

Select the **Active Filter** from the drop-down list. This is the filter in use in the Library Browser when the Manage Library Filters dialog is closed.

4 Selected Filter

Specify the **Name** of the Selected Filter.

5 Catalogs

A list of all **Home Designer Core**, **Home Designer Bonus** and **Manufacturer Catalogs** installed in your library display here.

- Check the box beside a library catalog's name to prevent it from displaying in the Library Browser Directory Pane tree list.
- Click the **Select All** button below either list to prevent all catalogs in that list from displaying in the Directory Pane tree list.
- Click the **Clear All** button below either list to include all catalogs in that list in the Directory Pane tree list.

Exporting Library Catalogs

Exporting library files allows you to:

- Back up your custom library content.
- Transfer library content between computers.
- Share custom library content with colleagues.

Exporting is often preferable to simply copying library files because it allows you to include images and textures in the exported library.

To export content from the library

1. Locate an object, folder, or catalog that you want to export, right click on it, and select **Export Library**.
2. In the Export Library Data dialog:
 - Choose the appropriate **Save in:** location for your exported library file.
 - Type a short, descriptive name for your library file in the **File Name** field.
 - Click the **Save as type:** drop down list and select whether or not you want the library to include Textures/Images.



If any of the items being exported are images or use textures, be sure to select the .calibz file type.

- Click **Save**.
3. Your exported library file can now be copied to a network location or storage device in an operating system window.

Any Shortcuts  present in a catalog will be converted to regular library objects when exported. See [Library Shortcuts on page 683](#).

Placing Library Objects

Library objects are subject to placement restrictions based upon typical real-life placement. Most library objects require sufficient free space at the location where they are placed, for example, and some library objects have additional requirements. Library windows and doors, for example, must be placed in a wall just like standard windows and doors, and some fixtures are designed to be placed in cabinets.

There are three main categories of items available in the Library Browser:

- Stand-alone objects that can be placed directly into a plan. Examples include cabinet modules, furnishings and images.
- 3D objects designed to be inserted into another 3D object. Examples include cabinet fixtures, windows and doors. Some items, such as cabinet doors and fixtures and fence panels, can be inserted into another object or placed as stand-alone objects.
- Materials fill styles, and molding profiles, which cannot stand alone and must be assigned or applied to another object.

If a warning message displays when placing a library object, it will indicate where the object can be placed.

STAND-ALONE OBJECTS

Most library categories contain objects that can be selected in the Library Browser and placed directly in a 2D or 3D view.

- Most stand-alone objects are designed to rest on the floor or terrain.
- Some objects will rest on top of a cabinet, shelf, furniture or roof plane object if one is located at the point where they are first placed.
- A few objects, notably some light fixtures, will mount on the bottom of a wall cabinet or on the ceiling.
- In addition, some objects will attach to a wall if one is nearby.

To place a stand-alone library object

1. Click on an object in the tree view or Selection Pane of the Library Browser to select it for placement. See [The Library Browser on page 669](#).
2. Move your mouse pointer into the view area and notice that it displays an icon indicating the type of object selected instead of an arrow.
3. Click to place the selected object at that location.
4. Continue clicking to place as many instances of the selected object as needed. When you are finished, click the **Select Objects**  button.

Once a stand-alone object has been placed, it can be edited in a variety of ways. See [Editing Library Objects on page 691](#).

INSERTED OBJECTS

Some objects cannot stand alone and must be placed into other objects in a plan. For example, doors and windows must be inserted into a wall, while some appliances and plumbing fixtures are designed be placed inside a base cabinet. See [Doors on page 365](#), [Windows on page 393](#) and [Cabinets on page 431](#).

With the exceptions of doors, windows, and skylights, an inserted library object can only display in a 2D or 3D view if the object that contains it is set to display. This is the case even if the inserted object's layer is turned on. See [Displaying Library Objects on page 690](#).

To insert a library object

1. Click on an item in the tree view or Selection Pane of the Library Browser to select it for placement. See [The Library Browser on page 669](#).
2. Move your pointer into the drawing area.
3. Click on the object into which you wish to insert the selected library item. If the selected library item is designed to be inserted into that type of object, it will be placed into it.
4. Continue clicking on other objects to place as many instances of the selected item as needed. When you are finished, click the **Select Objects**  button.

When an object has been inserted into another object, it can be replaced directly from the library. See [Replace From Library on page 689](#).

If you try to insert an object into another object that is on a locked layer, nothing will be created. See [Object Creation and Layers on page 117](#).

ASSIGNED ITEMS

Some library items, such as fill styles, materials and moldings, are not objects in themselves but can be applied to objects in a variety of ways.

- Using the specification dialog of the containing object. See [Select Library Object Dialog on page 688](#).
- By selecting the item in the library and then clicking on the containing object.

- Fill styles, materials and moldings can be assigned to objects directly from the library in 3D views by selecting the library item and then clicking on an object. See [Eyedropper and Painter Tools on page 185](#) and [Replace From Library on page 689](#).

Select Library Object Dialog

The Select Library Object dialog is a modal version of the Library Browser that is accessible from many object specification dialogs. See [Specification Dialogs on page 19](#).

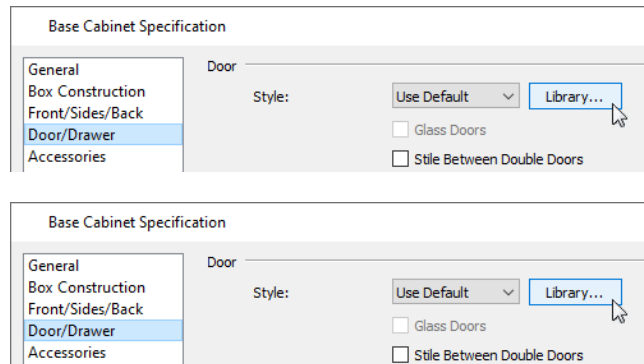

This dialog also opens when you select the **Fill Style Painter**  tool. See [Painter Tools on page 186](#).

The Select Library Object dialog only displays categories of items that are related to the object component being edited. For example, if this dialog is accessed from the DOOR/DRAWER panel of the Cabinet Specification dialog, only cabinet door and drawer symbols will be listed. If it is accessed from the Moldings panel, only moldings will be listed.

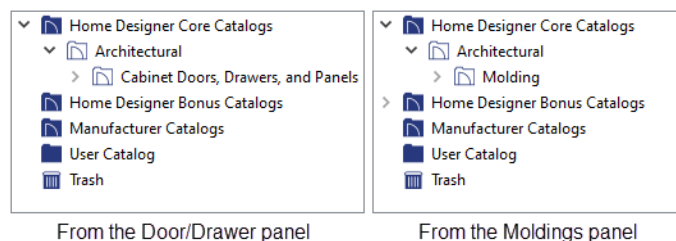

The Select Library Object dialog is similar to the LIBRARY MATERIALS panel of the Select Material dialog. See [Select Material/Library Object Dialog on page 717](#).

Place Library Object Button

 The **Place Library Object** button can be added to your toolbar and used for quick access and placement of frequently used library items.

If the **Place Library Object** button has not yet been assigned a library object, click it once to open the Library Object Button Specification dialog.

Double-click a **Place Library Object** button that has been assigned a library object to open the Library Object Button Specification dialog.

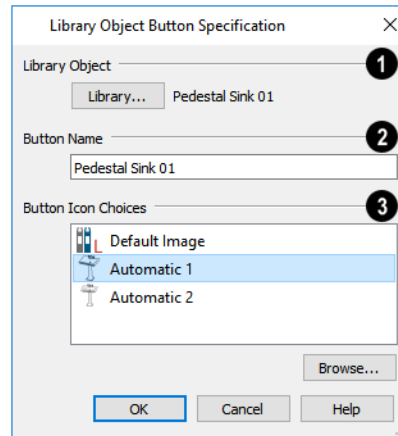

1 Library Object

Click the **Library** button to open the Select Library Object dialog and assign a library object to the button. If a library object has already been assigned, click this button to assign a new library object. See [Select Library Object Dialog on page 688](#).

2 Button Name

When a library object has been selected, type a **Button Name** in the text field.

3 Button Icon Choices

When a library object has been selected, assign a **Button Icon**. Choose from two automatically generated button icons or click **Browse** to browse your computer for a different icon.

Up to 100 **Place Library Object** buttons can be added to the same toolbar, each assigned a different object.

The library object assigned to the **Place Library Object** button is actually saved with that particular button. If you move or delete the library item from the library, the button will continue to function.

Replace From Library

There are two different ways to replace an object in a plan with another object from the library.

An inserted object or a molding profile can be replaced by a different item from the library with a single click. This approach is particularly effective in 3D views, where the results can immediately be seen. See [Inserted Objects on page 687](#).

To replace an inserted object

1. Open the Library Browser, and browse to an object of a type similar to the one you wish to replace.
2. Select the object and move the mouse pointer into the 3D view window.
3. The Replace from Library  icon will display near the mouse pointer when it passes over an object that can be replaced by the selection from the library.
4. Click once to replace the object in the plan with the selected object from the library.

Some types of inserted objects - notably, plants assigned to Garden Beds, cabinet doors and drawers, and doors - can also be replaced in this manner in plan view provided that the Alternate Edit Behavior is not active. The Replace from Library  icon does not display in plan view, however.

 In the Windows version of the program, you can temporarily override this replacement behavior in plan view by holding down the Alt key. A free-standing object will be created if there is space for it instead of an inserted object being replaced.

 The **Replace From Library** edit button is available for nearly any stand-alone object that can be added to the library and can be used in 2D and 3D views. Click this button to open the Replace From Library dialog and replace the selected object, and others like it if you choose, with an object of the same type from the library.

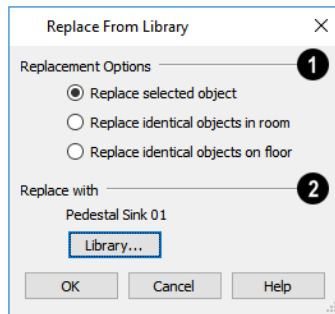



1 Replacement Options

- **Replace Selected Object** replaces only the currently selected object.
- **Replace Identical Objects in Room** replaces all objects that are in the same room as, and are identical to, the currently selected object. Not available for doors or windows.
- **Replace Identical Objects on Floor** replaces all objects that are on the same floor as, and are identical to, the currently selected object.

2 Replace With

Click the **Library** button to open the Select Library Object dialog and select an object to use as a replacement. The name of the object that is currently selected as a replacement displays above.

Replace From Library  cannot be used to replace a selected cabinet with a cabinet of a larger size. In addition, it is not available for backdrops and items assigned to other objects, such as materials.

 If the Replace from Library edit tool is used to replace an electrical object, any Connect Electrical splines attached to it will be deleted. See [Connect Electrical on page 473](#).

Displaying Library Objects

The display options available for library objects depend on the type of object in question, as well as the view.

If the display of an object is turned off in a 2D or 3D view, any objects inserted into it will not display in that view, either - even if the inserted object's layer is turned on. The exception to this rule is doors and windows, which can display in 3D views when their containing wall does not. See [Inserted Objects on page 687](#).

IN PLAN VIEW

All library objects except materials, doors and drawers applied to cabinets, and backdrops can display in plan view. Library objects are represented in plan view by 2D symbols that resemble the size and shape of the object when viewed from above.

As with other architectural objects, the display of library objects is controlled by layer in the Layer Display Options dialog. Each library category has its own layer. See *Layer Display Options Dialog on page 126*.

Like other objects, each library symbol is placed in a Drawing Group that affects whether it displays in front of or behind other objects. You can modify a selected symbol's place in the drawing order by clicking the **View Drawing Group Edit Tools**  edit button. See *Drawing Group Edit Tools on page 128*.

OBJECT LABELS

Free-standing library objects, including Architectural Blocks, can display labels in plan views when the appropriate layer is set to display in the Layer Display Options dialog. Fixture labels, for example, are located on the "Fixtures, Labels" layer. See *Label Panel on page 363*.

Library object labels use the Text Style assigned to their layer. See *Text Styles on page 360*.

You can specify a custom label for many library objects in its specification dialog. See *Symbol Object Specification Dialogs on page 693*.

IN 3D VIEWS

All library objects can display in 3D views.

By default, images rotate to face the camera in 3D views. For information about turning off image rotation, see *Image Specification Dialog on page 797*.

Doors, windows and cabinets from the library may also display opening indicators in Vector Views when the "Opening Indicators" layer is turned on. See *Layer Attributes on page 124*.

IN THE MATERIALS LIST

Most library objects are counted in the Materials List, as is any information added on the Components panel of their specification dialog. See *Components Panel on page 921*.

Note: Although the size and materials of many library objects can be edited, these changes are not reflected in the Materials List. See *Materials Lists on page 904*.

Editing Library Objects

The Core, Manufacturer, and Bonus Catalogs and the objects within them cannot be edited. Library objects can, however, be customized to suit your design needs. There are three approaches to doing so:

- Select an object in the User Catalog, edit it using any of the options in its contextual menu, and your changes will be reflected when you next place this library object in a drawing. See *Using the Contextual Menus on page 673*.
- Place an object in a drawing and then edit it using the various edit tools available for it. This will not affect the original object still saved in the library.

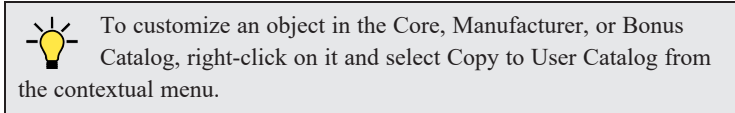

- Place an object in a drawing, edit it using the available edit tools, and then add it back to the library for future use. This will not replace the original object still saved in the library. See [Add to Library on page 681](#).



Stand-alone library symbols placed in a plan can be selected individually or as a group, like other objects in Home Designer. To select a symbol object inserted into the top of a cabinet, select that cabinet and click the **Select Next Object**  edit button. See [Selecting Objects on page 141](#).

Once selected, a library object can be edited in a variety of ways using dimensions, the edit handles, the Edit Toolbar buttons and its specification dialog. See [Symbol Object Specification Dialogs on page 693](#).

NATIVE OBJECTS VS SYMBOLS

In Home Designer, objects created using the program's standard tools, such as the **Door Tools**  and **Cabinet Tools** , are referred to as native objects.

On the other hand, objects placed from the library, such as fixtures and furnishings, are symbols. Symbols are typically more limited than native objects in how they can be edited.

In addition to the symbols available in the library, you can import additional symbols into the program from 3D **.dxf**, **.dwg**, **.obj**, **.3ds**, **.skp**, or **.dae** files. See [Importing 3D Symbols on page 840](#).

Any changes made to objects like fixtures and furniture will not be reflected in their Materials List Description, although they may be seen in other columns, such as Size. See [Materials Lists on page 904](#).

USING EDIT HANDLES

Most free-standing library symbols are box-based objects and can be edited as such once placed in a drawing. See [Editing Box-Based Objects on page 158](#). Depending on the type of view and the surface selected, the edit handles a symbol displays will vary.

When a typical symbol is selected in plan view or on the top surface in a 3D view, up to ten edit handles display. They are the Move handle at the center, the Rotate handle just outside the front indicator (a V) and a Resize handle on each edge and at each corner.

When a symbol is selected on a side in a cross section/elevation or 3D view, it displays six edit handles: the Move handle, a Rotate handle, and a Resize handle on each edge. See [Selected Side on page 143](#).

When a free-standing symbol is selected on its side and rotated, you will be prompted to choose whether to update its plan view symbol to reflect its new orientation, as viewed from above. See [In Plan View on page 691](#).

Symbols cannot be concentrically resized, even when the **Concentric**  edit behavior is enabled. See [Defaults, Preferences, and Edit Behaviors on page 137](#).

Fixtures and furniture placed in a plan are subject to bumping/pushing behavior when moved. See [Bumping/Pushing on page 166](#).

USING THE EDIT TOOLS

A selected library object placed in a plan will have a variety of edit tools available. See [The Edit Toolbar on page 91](#).

The specification dialog for an individual symbol, Rich Text object, Callout, Marker, Elevation Point, image, or plant image in the User Catalog can be edited from the Library Browser Directory Pane. Right-click on the item and select **Open Object** from the contextual menu. See *Specification Dialogs on page 19*.

Individual or multiple group-selected materials can be edited by right-clicking and selecting **Open Object** as well. See *Define Material Dialog on page 726*.

EDITING BUILT-IN FIXTURES AND APPLIANCES

A fixture installed into the front of a cabinet becomes a cabinet face item, like a door or drawer. It can be resized or deleted like other face items in the Cabinet Specification dialog. See *Front Panel on page 454*.

COMPONENTS

Many architectural objects have a COMPONENTS panel in their specification dialog that lets you control how that object displays in the Materials List. See *Components Panel on page 921*.

Changes made to the components of an object saved in the library do not affect instances of that object already placed in a plan: they are only applied to instances of the object placed in the future.

Terrain objects, moldings, images, backdrops, and materials do not display in the Materials List.

Symbol Object Specification Dialogs

The Fixture, Furniture, Geometric Shape, Hardware, Millwork, and Sprinkler and Plant Specification dialogs all feature the same options. The actual name of the dialog is determined by the type of object that is currently selected. For example, selecting a library object placed from the Interiors library catalog and clicking the **Open Object** edit button opens the Furniture Specification dialog.

GENERAL PANEL

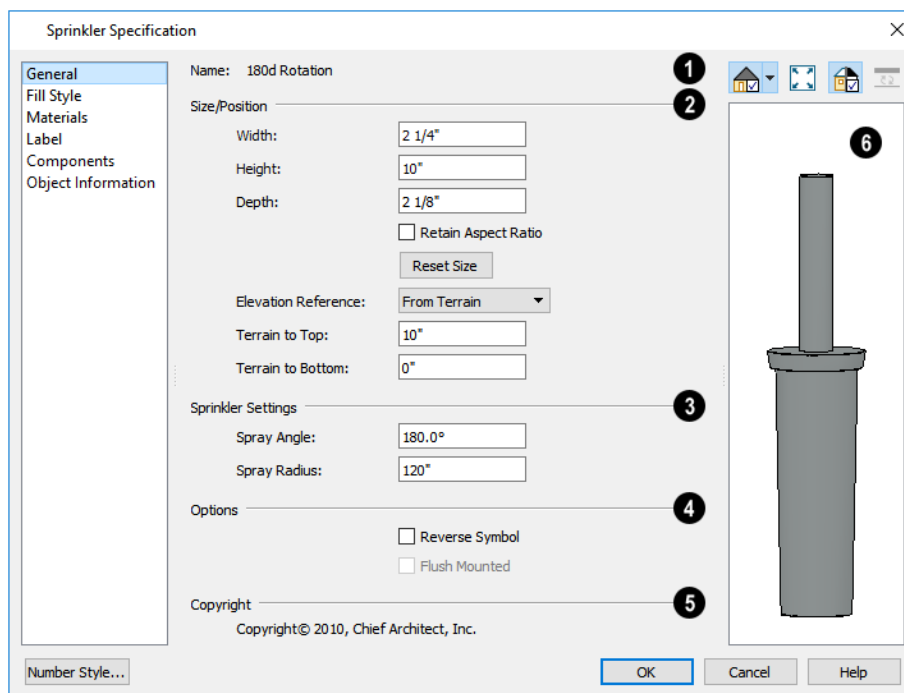

1 Name

The **Name** of the selected symbol object displays here.

2 Size/Position

- Specify the **Width**, **Height**, and **Depth** of the object.
- Check **Retain Aspect Ratio** to maintain the ratio between the object's Height, Width, and Depth when it is resized in the specification dialog. Does not affect the behavior of the object's edit handles.
- Click **Reset Size** to reset the symbol's original, unmodified size. The symbol's elevation is not affected by this option.
- Select the **Elevation Reference** from the drop-down list. This determines where the next two settings are measured from and also affects their setting labels.
- Specify the height **to Top**, measured from the selected Elevation Reference to the top of the object.
- Specify the height **to Bottom**, measured from the selected Elevation Reference to the bottom of the object.

3 Sprinkler Settings

The **Sprinkler Settings** are only available if the selected object is a sprinkler. See *Sprinkler Tools on page 897*.

- Specify the **Spray Angle**, which is the angle within which the sprinkler sprays. An angle of 360° forms a complete circle.
- Specify the **Spray Radius**, which is the distance from the sprinkler head that the spray reaches.

4 Options

Check **Reverse Symbol** to reverse the object's appearance, so that features on its left are positioned on its right, and vice versa. This turns a right-hand refrigerator, for example, into a left-hand refrigerator. This option has no effect on objects that are symmetrical.

- Check **Flush Mounted** to specify that the selected object follow the pitch of either the ceiling or roof. Only available when "From Ceiling" or "From Roof" is selected as the Elevation Reference, above.

5 Copyright

If the selected object has a **Copyright**, information about it displays here.

6 Preview

A preview of the selected library object displays here and updates with changes. If the selected symbol is inserted into another object, such as an appliance in a cabinet, the parent object will also display. See *Dialog Preview Panes on page 20*.

FILL STYLE PANEL

The FILL STYLE panel is available when the selected object is a sprinkler and controls how the area within its spray radius displays in plan view. It is similar to the FILL STYLE panel found in many dialogs. See *Fill Style Specification Dialog on page 131*.

MATERIALS PANEL

The settings on the MATERIALS panel affect the appearance of the selected object in 3D views. See *Materials Panel on page 716*.

LABEL PANEL

A variety of library objects can display labels in plan view. Labels use the Text Style assigned to the layer they are on.

For information about the settings on this tab, see *Label Panel on page 363*.

COMPONENTS PANEL

The information on the COMPONENTS panel can be used in the materials list. For more information, see *Components Panel on page 921*.

OBJECT INFORMATION PANEL

The information entered on the OBJECT INFORMATION panel can be used in the materials list. For more information, see *Object Information Panel on page 922*.

MANUFACTURER PANEL

The MANUFACTURER panel provides contact information for the selected object's manufacturer. Only available for symbols from Manufacturer library catalogs. See *Manufacturer Catalogs on page 677*.

Architectural Blocks

Chapter 27

An architectural block is a collection of individual 3D objects that are grouped together so that they can be placed and moved as a single object. Although blocked together, these objects retain many of their own attributes, such as materials.

Architectural blocks can also be exploded so that the individual sub-objects become independent of one another.

TOPICS

Creating Architectural Blocks	697
Displaying Architectural Blocks	697
Editing Architectural Blocks	698
Architectural Block Specification Dialog	699
Architectural Blocks, Sub-Objects, and Components	700

Creating Architectural Blocks



To create an architectural block, group-select multiple architectural objects, then click the **Make Architectural Block** edit button. Architectural blocks can be created in any view. See *Architectural vs CAD Objects on page 111*.

The following is a list of objects that can be included in architectural blocks:

- Cabinets (Base, Wall, Full Height)
- Custom Countertops
- Soffits, Shelves, Partitions
- Fixture and Furniture symbols
- Hardware symbols
- Millwork symbols
- Geometric Shapes
- Electrical objects
- Images
- Slabs and Foundation Slabs
- Roads, Driveways, Sidewalks
- Terrain Features and Terrain Modifiers

Once blocked, the set of blocked objects is contained in a bounding box, indicating that they are now an architectural block.

Displaying Architectural Blocks



As with individual objects, the display of architectural blocks is controlled in the Layer Display Options dialog. See *Layer Attributes on page 124*.

- If an architectural block is composed of objects that are on the same layer, the block will be placed on that layer, as well.
- If an architectural block is composed of objects on different layers, the block will be placed on the “Architectural Blocks” layer.

IN PLAN VIEW

You can control the appearance of the bounding box by changing the display properties of the architectural block’s layer or you can turn off its display in the Architectural Block Specification dialog. See *General Panel on page 699*.

Like other objects, an architectural block is placed in a Drawing Group that affects whether it displays in front of or behind other objects. You can modify a selected architectural block’s place in the drawing order by clicking the **View Drawing Group Edit Tools**  edit button. See *Drawing Group Edit Tools on page 128*.

ARCHITECTURAL BLOCK LABELS

Architectural blocks can display labels for both the block and any component objects that have labels in plan view. Labels for architectural blocks are placed on the “Architectural Blocks, Labels” layer and use the Text Style assigned to that layer. See *Label Panel on page 363*.

The label for an architectural block can be generated automatically, user-specified, or suppressed. See *Architectural Block Specification Dialog on page 699*.

Editing Architectural Blocks

Architectural blocks can be selected and edited in 2D and 3D views. See *Selecting Objects on page 141*.

Note: Moving an architectural block in 3D view regenerates the view. If the architectural block contains terrain objects, the terrain is rebuilt.

Once selected, an architectural block can be edited using its edit handles, edit toolbar buttons, and specification dialog. See *Architectural Block Specification Dialog on page 699*.

USING THE EDIT HANDLES

A selected architectural block displays a Move handle and a Rotate handle.

Architectural blocks cannot be resized, but the individual objects in a block can be.

IN THE SPECIFICATION DIALOG



Architectural blocks can be edited in their specification dialog. See *Architectural Block Specification Dialog on page 699*.

USING THE EDIT TOOLS

A selected architectural block or blocks can be edited in a variety of ways using the buttons on the Edit Toolbar. See *The Edit Toolbar on page 91*.

EDITING SUB-OBJECTS

The individual objects included in an architectural block can also be selected and edited. See *To select a sub-object on page 700*.

EXPLODE ARCHITECTURAL BLOCK



You can break an architectural block to make its objects independent. Select the architectural block and click the **Explode Architectural Block** edit button.

Note: If you open a plan created in another version of Home Designer and an architectural block includes an object that you cannot create in your version of the software, you cannot unblock it or edit its components.

ADDING ARCHITECTURAL BLOCKS TO THE LIBRARY



You can create your own architectural blocks and save them in the library. See *Add to Library on page 681*.

Architectural Block Specification Dialog

The Architectural Block Specification dialog controls the way architectural blocks display in plan view and in materials lists. Select one or more architectural blocks and click the **Open Object** edit button to open this dialog.

GENERAL PANEL

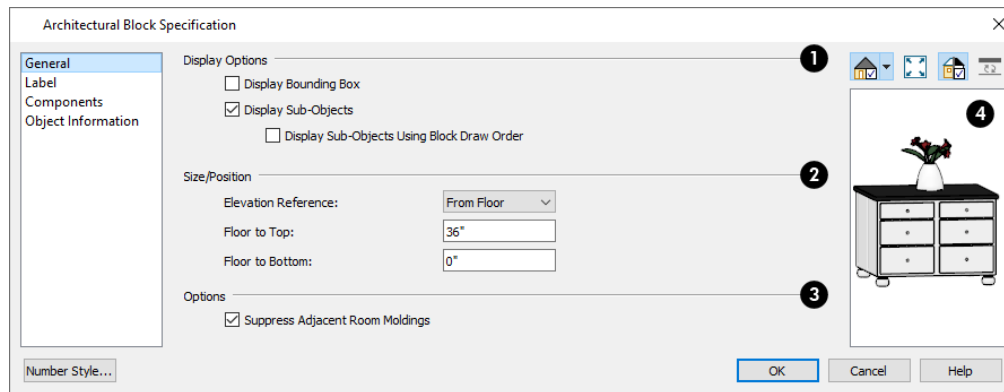

1 Display Options

These settings control the appearance of the selected architectural block in plan view. See [Displaying Architectural Blocks on page 697](#).

- Check **Display Bounding Box** to show the bounding box of the objects in the architectural block.
- Uncheck **Display Sub-Objects** to suppress the display of the sub-objects and display only the bounding box. If **Display Bounding Box** is unchecked, it will become checked.
- Check **Display Sub-Objects Using Block Draw Order** to display all component objects of the selected block using the block's drawing order. When unchecked, each component displays according to its individual drawing order. See [Drawing Groups on page 128](#).

2 Size/Position

These settings are not available if the selected block includes any objects such as electrical objects that do not have these settings in their individual specification dialogs.

- Select the **Elevation Reference** from the drop-down list. This determines where the next two settings are measured from and also affects their setting labels.
- Specify the height **to Top**, measured from the selected Elevation Reference to the top of the architectural block.
- Specify the height **to Bottom**, measured from the selected Elevation Reference to the bottom of the architectural block.

3 Options

- When **Suppress Adjacent Room Moldings** is checked, a room's base, chair, and/or crown moldings will not generate where the selected block's bounding box crosses them when positioned against a wall. When unchecked, room moldings are not affected by the block and generate normally. See [Room Moldings on page 300](#).

4 Preview

A preview of the selected cabinet displays on the right side of the panel. See *Dialog Preview Panes on page 20*.

LABEL PANEL

Labels for Architectural Blocks display in plan view when the “Architectural Blocks, Labels” layer is turned on and use the Text Style assigned to that layer. See *Architectural Block Labels on page 697*.

The LABEL panel is available for a variety of different objects. For more information, see *Label Panel on page 363*.

COMPONENTS PANEL

The information on the COMPONENTS panel can be used in the materials list. For more information, see *Components Panel on page 921*.

OBJECT INFORMATION PANEL

The information entered on the OBJECT INFORMATION panel can be used in the materials list. For more information, see *Object Information Panel on page 922*.



Architectural Blocks, Sub-Objects, and Components

An architectural block is composed of a group of sub-objects that have been blocked together. For example, a kitchen island architectural block may consist of cabinets, appliances, a custom countertop, and other accessories.



Each of the sub-objects in an architectural block may contain additional parts called components. The cabinets in a kitchen island, for example, may contain handles, hinges, and drawer glide.

SUB-OBJECTS

Certain attributes of an architectural block can be edited at the sub-object level. A sub-object can be edited by accessing its specification dialog in either of two ways:

- Explode the architectural block, select the sub-object, and click the **Open Object**  edit button.
- Select the sub-object while it is part of the architectural block and click the **Open Object**  edit button. Some attributes may not be editable while the object is part of a block. See *Editing Architectural Blocks on page 698*.

To select a sub-object

1. Click the **Select Objects**  button, then click on the sub-object that you would like to edit.
2. With the architectural block selected, click the **Select Next Object**  edit button or press the Tab key.
The selection switches to the individual object and it can be edited using its edit handles, edit toolbar and specification dialog.

The options for editing a sub-object may be more restricted than if the object were independent. If more extensive editing is required, the architectural block must be exploded. See *Explode Architectural Block on page 698*.

COMPONENTS

You can view and modify the components of an architectural block or group of blocks in the Architectural Block Specification dialog. The COMPONENTS panel lists all the sub-objects that comprise an architectural block, as well as the components that make up each sub-object. See *Components Panel on page 921*.

Other Objects

Chapter 28

Home Designer has additional objects that can be used to customize your design.

TOPICS

General Shapes	703
Soffits	703
Special Applications for Soffits	704
Soffit Specification Dialog	706
Material Layers Definition Dialogs	709

General Shapes



Items in the Home Designer Core Catalogs> Shapes library catalog allow you to create a variety of custom objects using basic geometric shapes. These shapes can be used individually or combined to create a wide variety of custom objects.

General Shape objects are placed and edited much like other library objects. See [Editing Box-Based Objects on page 158](#).

Soffits



Soffits typically fill the space between the tops of wall cabinets and the ceiling, but they are very versatile and can be used to create almost any other object that can be modeled as a 3D box. Select **Build> Cabinet> Soffit** to activate this tool.

SOFFIT DEFAULTS



The default settings for soffits are set in the Soffit Defaults dialog. The settings in this dialog are similar to those in the Soffit Specification dialog. See [Soffit Specification Dialog on page 706](#).

When a soffit is created, it is placed on the “Cabinets, Soffits” layer. See [Layer Attributes on page 124](#).

For best results when placing soffits above wall cabinets:

- The default soffit should be the same width as and 1" (20mm) deeper than the default wall cabinet. See [Cabinet Defaults on page 432](#).
- The default soffit **Floor to Bottom** value should equal the sum of the default wall cabinet's Floor to Bottom value plus its Height. See [General Panel on page 706](#).
- The default soffit **Height** should be equal to or greater than the space between the ceiling and the top of the wall cabinets.

If the sum of the default soffit's Floor to Bottom value and Height is larger than the ceiling height of the room in which a soffit is placed, the Floor to Bottom value will be retained and its Height will be adjusted so that it fits under the ceiling.

The maximum soffit width is 250 feet (48m), and the minimum width is 1/16" (1 mm).

Once a soffit is placed in a plan, you can change its size and position to meet a variety of needs. See [Special Applications for Soffits on page 704](#).

PLACING SOFFITS

Soffits can be created in both 2D and 3D views by simply clicking with the **Soffit**  tool active. See [Click-to-Create on page 115](#).

To create a corner soffit, click as close to an inside wall corner as possible. A corner soffit retains its shape when it is moved, edited, or copied.

When positioned against a wall in a room, soffits will automatically display any moldings present in that room that are at the same height as the soffit. Soffits can also have custom molding profiles assigned to them. See [Moldings Panel on page 309](#).

When positioned against the ceiling in a room, a soffit will prevent the Ceiling Finish layers directly above it from generating in 3D. See [Lowered Ceilings on page 297](#).

Special Applications for Soffits

Nearly any object with straight, flat sides can be represented by one or more Soffits. They can be resized to as small as 1/16" (1mm) per side, or as large as 250 feet (48m).

Soffits can have materials applied to them to represent simple mirrors, beams in exposed ceilings, posts, chimneys and so on. Following are some additional examples.

ROOF BEAMS AND COFFERED CEILINGS

Sloped soffits can be used to represent beams or rafters that follow the pitch of the roof in rooms with cathedral ceilings. See [General Panel - Sloped Soffits on page 707](#).



Soffits can also be used to create coffered ceilings. They will display any moldings assigned to the room it is in that are at its height. In addition, you can assign moldings directly to a soffit in its specification dialog. See [Moldings Panel on page 708](#).



ACCENT TILES

A material such as ceramic tile can be assigned to one or more soffits applied to the walls above tubs or in showers.



MASONRY VENEER

As an alternative to a pony wall, you can use a soffit to create a brick or stone veneer over part of a wall. Specify a soffit depth equal to the masonry material to be used.

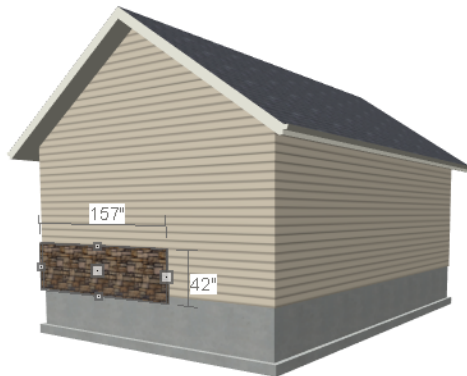

Soffits automatically stop at the floor platform when moved downward or at the ceiling platform when moved upward - even when the soffit is not located in a room. To move or resize a soffit through a floor or ceiling platform, select it and hold the Ctrl key down while dragging its edit handles. See [Unrestricted Movement on page 166](#).

CALCULATING MATERIALS ON SOFFITS

By default, soffit materials are not calculated in the Materials List. In order for a soffit's material to be counted, it must be edited so that it is not using the default material. See [Material Defaults on page 712](#).

The number of bricks, tiles, shingles, shakes or other materials applied to a soffit is calculated using the following rules:

- If the soffit depth is less than the larger of 4 inches (10 mm) or 1 ½ times the material thickness, then only the front area of the soffit is used. Thus if a soffit is 48"x48"x4" thick, and the Dark Red brick material is used (3"x 8" with 3/8" mortar joint), the front of the soffit is 48"x48"=2304 square inches. Including the mortar joint, each brick requires 3 3/8" x 8 3/8" = 28.26 square inches. 2304 sq. in. divided by 28.26 sq. in. per brick gives 81.5 bricks.

- If the soffit depth is greater than both 4 inches (10 mm) and 1 ½ times the material thickness, then the surface areas of the soffit back, sides and top are used in addition to the front, if these surfaces are not attached to a wall or other soffit. However, only those portions of the sides, top and bottom remaining after subtracting twice the material thickness are used. So, for Dark Red brick, which has a depth of 4", the sides, top and bottom surface areas cannot contribute to the brick count unless the soffit depth is greater than 8 inches.
- If surface materials such as brick are applied to a large soffit, the soffit center is assumed to be hollow, with only a single layer of the material applied to each applicable face.
- For shingles and shakes, the overlap amount should be subtracted from the height, as opposed to brick or tile, where the joint width is added to the size.
- For materials in the area category, the soffit area calculation above is used, with the material thickness treated as zero.
- For materials in the volume, concrete or earth categories, the true volume of the soffit is used.

Soffit Specification Dialog

To open the Soffit Specification dialog, select the soffit and click the **Open Object** edit button or double-click on a soffit using the **Soffit**  tool.

The settings in this dialog are similar to those in the Soffit Defaults dialog, but affect only the selected object(s).

GENERAL PANEL

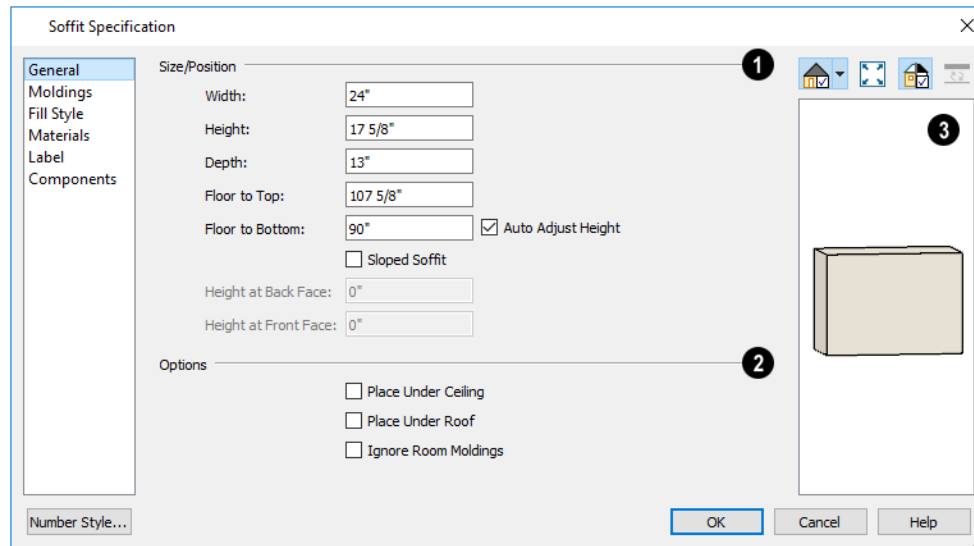

1 Size/Position

Define the **Size** and **Position** of the selected soffit relative to the floor or terrain.

- Specify the **Width** of the soffit.
- Define the vertical **Height** of the soffit.
- Define the **Depth**, which is the distance between the front and the back of the soffit. When selected in plan view, the front of a soffit has a “V,” and the back of the soffit has a triangular rotation handle.
- If the selected soffit is a corner soffit, the **Width** controls its left side width, and **Depth** controls its right side width.
- Specify the distance from **Floor to Top** of the soffit.
- Specify the distance from **Floor to Bottom** of the soffit.
- When the selected soffit is outside a room, its Floor to Bottom height is measured relative to the terrain. Check **Auto Adjust Height** to maintain the same distance above the terrain if the soffit is moved to a location with different terrain height. Uncheck this to maintain the same absolute height regardless of the terrain below. When **Auto Adjust Height** is checked, the Floor to Bottom value may automatically adjust if the soffit is moved.
- Check **Sloped Soffit** to slope the soffit vertically from the back up towards the front. This may become checked automatically if you check Place Under Ceiling or Place Under Roof, below. When you specify a soffit as sloped, the available options on this panel change. See *General Panel - Sloped Soffits on page 707*, below.
- The **Height at Back Face** and **Front Face** settings become enabled when Sloped Soffit is checked. See *General Panel - Sloped Soffits on page 707*, below.

2 Options

- Check **Place Under Ceiling** to adjust the soffit’s height so its top contacts the ceiling above. If the soffit is below a sloped ceiling plane, Sloped Soffit will become checked and the Height at Back and Front Face will adjust to match the pitch. Not available in the Soffit Defaults dialog, or if the soffit is not below a ceiling.
- Check **Place Under Roof** to adjust the soffit’s height so its top contacts the bottom of the roof above. Provided that the roof above does not have a pitch of 0, Sloped Soffit will become checked and the Height at Back and Front Face will adjust to match the pitch. Not available in the Soffit Defaults dialog, or if there is no roof above the soffit.
- Check **Ignore Room Moldings** to prevent the selected soffit from displaying moldings assigned to the room that it is placed in. See *Special Applications for Soffits on page 704*.

3 Preview

A preview of the soffit displays on the right side of the dialog box. See *Dialog Preview Panes on page 20*.

GENERAL PANEL - SLOPED SOFFITS

When a soffit is specified as sloped, the available options on the GENERAL panel of the Soffit Specification dialog change.

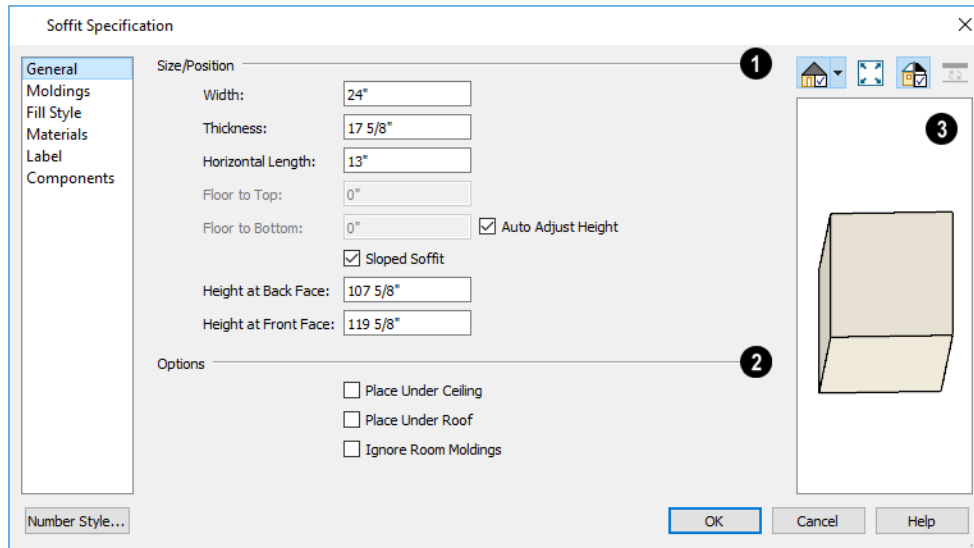

- **Width** is measured left to right across the soffit, parallel to the front of the soffit.
- **Thickness** is the top-to-bottom height of the front and back faces of the soffit.
- **Horizontal Length** is measured from back to front in plan view. When a soffit is sloped, this measurement is not the actual length of the soffit’s bottom or top edge. It cannot, for example, be used to determine the length of a sloped beam.

Both the front and back heights of a sloped soffit must be defined. Checking Place Under Ceiling or Place Under Roof will automatically adjust these values to match the slope of the ceiling or roof plane above.

- **Height at Back Face** is measured from the finished floor to the lowest point at the back of the soffit.
- **Height at Front Face** is measured from the finished floor to the underside of the soffit at the upper end.

MOLDINGS PANEL

The settings on the MOLDINGS panel allow you to assign one or more horizontal moldings around the selected soffit.

For information about the settings on this panel, see [Moldings Panel on page 665](#).

FILL STYLE PANEL

The settings on the FILL STYLE panel affect the selected soffit’s appearance in plan view. For information about the settings on this panel, see [Fill Style Specification Dialog on page 131](#).

MATERIALS PANEL

Soffits are not calculated in the Materials List unless a non-default material is specified. See [Calculating Materials on Soffits on page 705](#).

For information about the settings on this panel, see [Materials Panel on page 716](#).

LABEL PANEL

Soffit labels display in plan view when the “Cabinets, Labels” layer is turned on and use the Text Style assigned to that layer. The Automatic Label for Soffits is blank, but you can specify a custom label. See [Cabinet Labels on page 441](#).

For more information about the settings on this panel, see [Label Panel on page 363](#).

COMPONENTS PANEL

The information on the COMPONENTS panel can be used in the materials list. For more information, see [Components Panel on page 921](#).

OBJECT INFORMATION PANEL

The information entered on the OBJECT INFORMATION panel can be used in the materials list. For more information, see [Object Information Panel on page 922](#).

Material Layers Definition Dialogs

The Material Layers Definition dialogs allow you to define the layers that make up wall, floor, ceiling, slab, and roof assemblies. The names of these dialogs vary and are determined by the type of object or component being edited. They include:

- Backsplash Layers Definition Dialog
- Ceiling Structure Definition
- Floor Structure Definition

See [Custom Backsplashes on page 439](#) and [Floor and Ceiling Platforms on page 295](#).

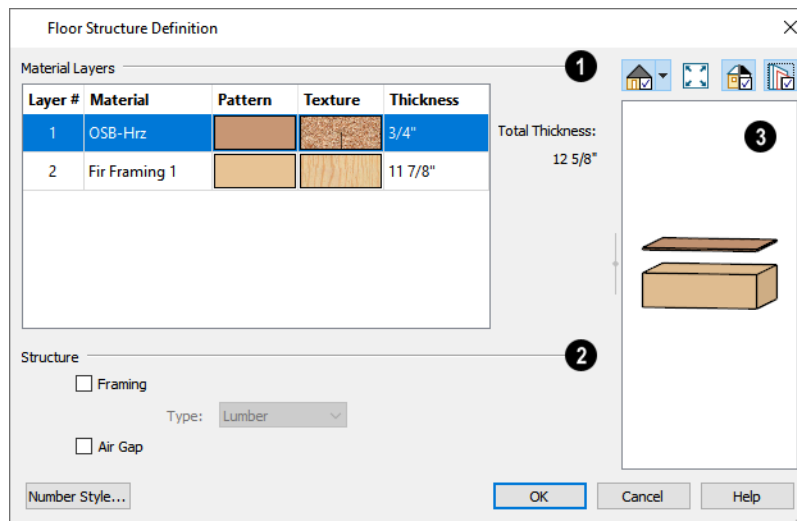

1 Layers

The selected assembly's layers are numbered and listed from the top of the structure to its bottom. To select a layer for editing, click in its row.

- Click in the **Material, Pattern, or Texture** column to open the Select Material dialog and choose a material for the selected layer. See *Select Material/Library Object Dialog on page 717*.
- Click in the **Thickness** column to type the selected layer's thickness or depth. Very thin layers can be created, but for best results avoid using a thickness of 0. For very small values, it can be helpful to temporarily change the dialog number format: click the **Number Style** button.
- The **Total Thickness** of the assembly displays to the right as a reference.
- Select a **Structure Type** from the drop-down list. Only available when the selected material is a Framing type. See *Framing Materials and Types on page 633*.

2 Structure

Specify whether the selected layer has special structural attributes.

- Check **Framing** to produce framing in the selected layer when framing is generated for the selected structural assembly's type. See *Build Framing Dialog on page 613*.
- Select the framing **Type** from the drop-down list. See *Displaying Framing on page 632*.
- Check **Air Gap** to prevent the selected layer from displaying in 3D views or being calculated in the Materials List. See *Creating an Accurate Materials List on page 906*.

3 Preview

A preview of the selected assembly displays here. See *Dialog Preview Panes on page 20*.

- By default, a gap is shown between each of the assembly layers. Click the **Explode Layers**  button to remove or restore these gaps.

Materials

Chapter 29

The objects used in Home Designer have a variety of 3D properties. These objects - walls, windows, doors, cabinets, roof planes, lot perimeters, etc. - can have materials assigned to them so that they look realistic in 3D views. These materials can also be used to generate materials lists that can help with cost estimations.

Designing with objects that look correct in 3D and calculate properly in the Materials List requires that you use realistic material definitions and apply them appropriately to objects in your plan.

Home Designer comes with many materials that are ready for use. From siding, roofing, flooring, masonry, tile, and paneling, to road surfaces, grass, water, and wood materials, Home Designer has materials for every application, inside and out. If you cannot find a material that suits your needs, you can customize the materials provided or create your own.

Learning how to create, manage, apply, and edit materials saves time and adds that professional touch to your designs.



Redefining only the visual properties of a material may create unexpected results. For example, changing the image of a brick material to represent siding does not cause the material to be considered as siding during material calculations.

TOPICS

About Materials	712
Material Defaults	712
Material Painter Tools	713
Materials Panel	716
Select Material/Library Object Dialog	717
Editing Materials	719
Creating Materials	721
Mapping Patterns and Textures	722
Materials and the Materials List	723
Managing Plan Materials	725
Define Material Dialog	726

About Materials

The materials that are assigned to objects in Home Designer perform two important roles:

- They determine what the surfaces of objects look like in 3D views.
- They influence how objects are calculated in the Materials List. See *Materials Lists on page 904*.

Materials are stored in the Library Browser and can be applied to objects in either of two ways:

- Using the **Material Painter** . See *Material Painter Tools on page 713*.
- In an object's specification dialog. See *Materials Panel on page 716*.

PATTERNS AND TEXTURES

In Home Designer Pro, materials have two attributes that determine what they look like in 3D views: Textures and Patterns.

- Textures are created using special image files that tile seamlessly when applied to surfaces and are visible in most Rendering Techniques. See *In Rendered Views on page 748*.
- Patterns are composed of CAD lines and are seen in Technical Illustration and Vector Views. Select **3D> Toggle Patterns**  to toggle the display of patterns on or off in these views in the current plan. See *Rendering Techniques on page 785*.

Often, the texture and pattern for a given material are both set up to represent the characteristics of the material in the real world and have similar sizing and angles. When customizing such a material, check **Keep Pattern/Texture in Sync** before making changes to maintain this consistency. See *Define Material Dialog on page 726*.

MATERIALS LIST CALCULATION METHODS

Every material can be assigned a Calculation method which defines how the material is calculated in the Materials List: for example, by piece, area, volume and so on. See *Materials and the Materials List on page 723*.

Material Defaults

 Most objects in the program have defaults dialogs which allow you to set up a variety of attributes, including materials, before the objects are created. These defaults dialogs are accessed by selecting **Edit> Default Settings**. See *Preferences and Default Settings on page 53*.

The Material Defaults dialog serves two purposes. It allows you to:

- Set the default materials for objects that do not have a defaults dialog: for example, fireplaces and furnishings from the library.
- Set the initial materials that can then populate a variety of defaults dialogs. Door, Window, and Cabinet Defaults are examples of defaults dialogs that can draw their material assignments from the Material Defaults dialog.

Material defaults are dynamic, which means that if you change a particular default material, all objects that are set to use that default will automatically update to use the new material. See *Dynamic Defaults on page 55*.

Because material defaults are dynamic, you can use the Material Defaults dialog to apply a material to multiple objects that share similar components. For example:

- The “Room Moldings” Material Default applies to the base, crown, and chair rail moldings that can be assigned to rooms, as well as to interior door and window casing. If you change this Material Default, all of these objects in the plan can be affected.
- The “Cabinet”, “Cabinet Door/Drawer”, “Countertop”, and “Hardware” Material Defaults can be used in your Cabinet Defaults dialogs to ensure that all cabinets use the same materials. See *Dynamic Cabinet Defaults on page 432*.

MATERIAL DEFAULTS DIALOG

Select **Edit> Default Settings**  from the menu, select “Materials”, and click the **Edit** button to open the Material Defaults dialog.

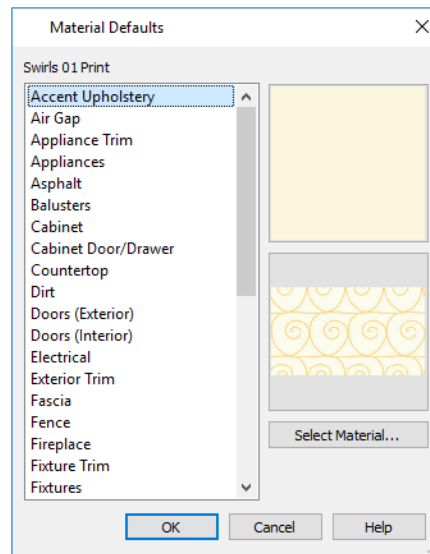

- Select a material category from the scrollable list. Select multiple line items using the Shift or Ctrl key. See *Shift and Ctrl Select on page 144*.
- Click the **Select Material** button or either material preview box to open the Select Material dialog. See *Select Material/Library Object Dialog on page 717*.

Material Painter Tools

 In a 3D view, select **3D> Material Painter** to access the **Material Painter Tools**, which are used to apply materials to object surfaces. The Material Painter tools are available in all Rendering Techniques except Glass House views. See *Glass House on page 786*.

 If you use the Material Painter to change a Deck room’s planking or framing will affect its floor structure definition. See *Floor and Ceiling Platform Definitions on page 296*.



MATERIAL PAINTER

 The **Material Painter** tool allows you to apply a selected material to other objects in 3D views. It can be activated in several ways:





- Select **3D> Material Painter> Material Painter** .
- Select a material in the Library Browser while a 3D view is active.
- The Material Painter also becomes active when the Material Eyedropper is used.

The **Material Painter**  is similar to the other Painter tools but has some additional considerations. See *Painter Tools on page 186*.

To use the Material Painter tool

1. In a 3D view, select **3D> Material Painter> Material Painter** .
2. Choose a material from the Select Material dialog. See *Select Material/Library Object Dialog on page 717*.
 - Check **Use Default Material** at the bottom left of the LIBRARY MATERIALS panel or select “Use Default” from the top of the list on the PLAN MATERIALS panel to apply the default material to any object that has a defaults dialog. See *Material Defaults on page 712*.
3. If you click the **Copy Selected Material**  button, a copy of the selected material is created and the Define Material dialog will open, allowing you to customize that copy. See *Copy Selected Material on page 715*.
4. Select one of the **Material Painter Modes** from the Edit Toolbar. See *Material Painter Modes on page 714*, below.



5. If you selected a solid color material, choose whether to use the **Blend Colors with Materials**  option and click the edit button to turn this feature on or off. See *Blend Colors With Materials on page 715*, below.
 - The mouse pointer displays a paint roller icon  when **Blend Colors With Textures** is active.
 - The mouse pointer displays a spray can icon  when the **Material Painter** is active and **Blend Colors With Textures** is not.
6. Note that the name of the material being painted displays on the left side of the Status Bar at the bottom of the program window. See *The Status Bar on page 23*.
 - Move your pointer over a surface in the 3D view. The Status Bar now states both the material being painted and the current material on the target surface.
7. Click on a surface to apply the selected material to that surface. The material is applied to surfaces in the model based on the active Material Painter Mode.
8. If either the **Component**  or **Object Mode**  is active, you can continue to click on surfaces to apply the selected material. When you are finished, select a different tool.

MATERIAL EYEDROPPER

 The **Material Eyedropper** tool allows you to load the material assigned to an existing object into the Material Painter and apply that material to other objects and is similar to other Eyedropper tools. See *Eyedropper Tools on page 185*.

MATERIAL PAINTER MODES

There are five Material Painter Modes, each specifying how broadly or narrowly the selected material will be applied to surfaces in your plan. They are similar to other Painter Modes in the program, but rather than modify instances of an object

type, the Material Painter Modes replace instances of a material based on the selected scope. See *Painter Modes on page 187*.

These Painter Modes are also available when the **Adjust Material Definition**  tool is used, allowing you to control how extensively a change to a material is applied throughout the current plan. See *Adjust Material Definition on page 719*.

 **Material Painter Component Mode** is unique to the Material Painter Tools. It is the default mode and applies the selected material to a single component on the target object. For most object types, using this tool is the same as opening an object's specification dialog and changing the material of one of its components on the MATERIALS panel. See *Materials Panel on page 716*.

 **Material Painter Object Mode** replaces all instances of a material on the target object.

 **Material Painter Room Mode** replaces all instances of a material in the room where the target object is located.

 **Material Painter Floor Mode** replaces all instances of a material on the floor where the target object is located.

 **Material Painter Plan Mode** replaces all instances of a material in the entire plan.

BLEND COLORS WITH MATERIALS

 The **Blend Colors With Materials** option allows you to apply a solid color to a surface displaying a texture or pattern and blend the two.

Blend Colors With Materials  works in all five Material Painter Modes. See *Blending Materials on page 721*.

COPY SELECTED MATERIAL



 The **Copy Selected Material** tool creates a copy of the selected material, gives you an opportunity to customize it as needed, and then lets you apply the new material to surfaces in the model. This option is helpful if you need slightly different versions of the same material - for example, to orient wood planks or tile in different directions.

When you click the **Copy Selected Material**  button, the Define Material dialog will open, allowing you to customize the new material. When you click OK, the customized material is loaded into the Material Painter. See *Define Material Dialog on page 726*.



Once you apply the material to one or more surfaces in the model, it will be listed in the Plan Materials dialog. See *Managing Plan Materials on page 725*.

MATERIAL PAINTER AND WALLS

Painting walls is an obvious use for the **Material Painter** ; however, it is important to note that the Material Painter Modes affect walls and rooms somewhat differently than they do other objects: particularly if a wall defines multiple rooms on the side that is being painted.

Component  and **Object Modes**  only paint the section of the wall that defines the room located where you click to apply a new material. Sections of the same wall that define other rooms are unaffected.

Room Mode  applies the material to all walls and solid railings that define the room where you click provided that they have the same original surface material as the one being painted. Any other objects in the room with that original material are also affected, but railings are not unless they are specified as Solid.

Floor  and **Plan Modes**  apply the material to all walls, all railings, and any other objects with the same original surface material as the one being painted: either on the current floor, or throughout the plan.

Note: Wall materials applied using the Material Painter tool are not calculated in the Materials List. See [In the Materials List on page 242](#).

Materials Panel

The specification dialogs for most objects include a MATERIALS panel. Select an object or a group of similar objects and click the **Open Object** edit button to open the specification dialog for that selection.

On the MATERIALS panel, you can specify material assignments for the components that make up that object. When a new material is assigned, the appearance of the preview image on the right side of the dialog updates.

If the selected object is using a material that is missing its texture, a Caution  symbol will display next to the Materials panel name in the list on the left side of the object's specification dialog. See [Referenced Files on page 43](#).

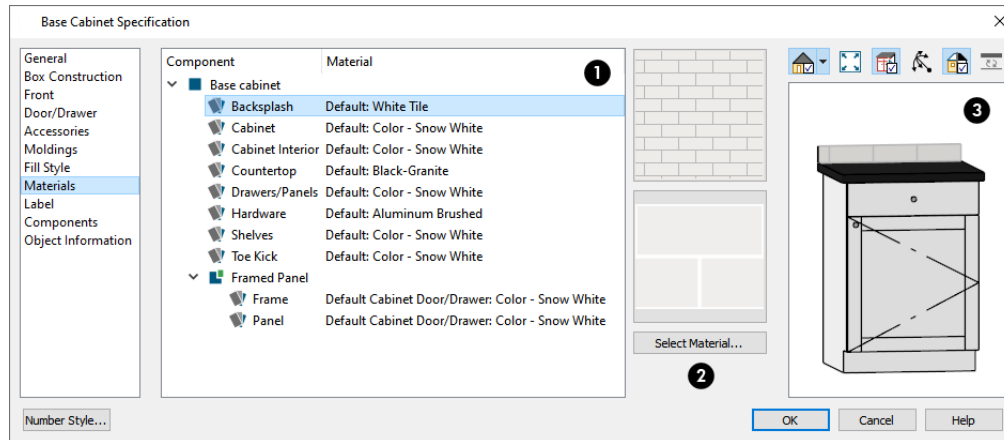

1 Object Components

The table on the left side of the panel lists the components of the selected object that can be assigned unique materials, along with the names of those materials and whether or not the default materials are used. Some objects may have only one component while more complex objects may have many. As changes are made to the selected object, components may be added to or removed from this table.

- Click on a Component in the table to select it. Multiple line items can be added to the selection set by holding down the Shift or Ctrl key. See [Shift and Ctrl Select on page 144](#).
- The selected component's Material is stated in the list, to the right of the component name. If the component is using the default material, the name will be preceded by the word "Default:". If it is using a Material Default, it will be preceded by the word "Default" followed by the name of an object type. See [Material Defaults on page 712](#).

Note: If the selected object is a wall or a room modified using the Material Painter, a component's Material may be described as "No Change". See [Material Painter and Walls on page 715](#).

2 Material Preview

The two boxes to the right of the table display previews of the color, pattern, and texture of the material assigned to the selected component. If “No Texture” displays in the preview window, the material has no texture assigned to it; if a Caution  symbol and the words, “Texture Missing” display, the texture file could not be found on the system.

There are several ways to open the Select Material dialog and choose a different material for one or more selected line items:

- Double-click on a line item in the table.
- Select one or more line items and click the **Select Material** button.
- Select one or more line items and click on either of the preview boxes.

See *Select Material/Library Object Dialog on page 717*.

3 Preview

A preview of the selected object displays on the right side of the panel. To view material textures, select **Standard** as the View Type; to view material patterns, select **Vector View**. See *Dialog Preview Panes on page 20*.

Select Material/Library Object Dialog

The Select Material dialog allows you to select a material to apply to one or more objects and is opened by clicking the **Select Material** button on the MATERIALS panel of most specification dialogs or by using the **Material Painter** . See *Materials Panel on page 716* and *Material Painter Tools on page 713*.

The similar Select Library Object dialog allows you to select an item from the library to either apply or insert into a currently selected object. See *Placing Library Objects on page 686*.

The Select Library Object dialog has a single panel; however, depending on how it is accessed, the Select Material dialog will have either two or three panels:

- The *Library Materials Panel on page 717* allows you to select materials from the Library Browser.
- The *Plan Materials Panel on page 719* lets you to select materials from the Plan Materials dialog.
- The *Material Defaults Panel on page 719* lets you associate an object component with a Material Defaults category rather than a specific material and is only available when the component of a library symbol is selected on the MATERIALS panel of the object’s specification dialog.

LIBRARY MATERIALS PANEL

The LIBRARY MATERIALS panel is a modal version of the Library Browser that lists only materials. See *The Library Browser on page 669*.

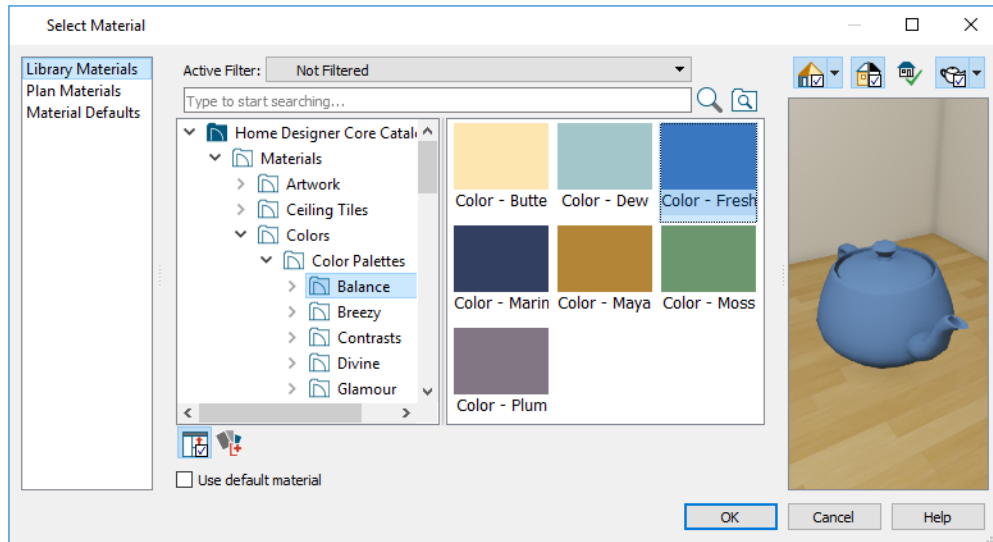

Most of the settings on this panel are also found in the Select Library Object dialog. See *Select Library Object Dialog on page 688*.





The LIBRARY MATERIALS panel has most of the functionality that the Library Browser has, including the search, search filtering options, and preview options.

- To locate a material, either search using keywords or browse the tree list. See *Searching the Library on page 675*.
- Located below the tree list, check **Use default material** to apply the default material to the selected object component (s), if one exists. See *Material Defaults on page 712*.
- A preview of the selected material displays on the right. See *Dialog Preview Panes on page 20*.
- To apply a material to an object, either click on the material and click **OK** or double-click on the item in the Selection Pane.

A selection of buttons below the tree list allows you to control the appearance of the panes in this dialog. The Selection and Preview panes are always present when the dialog is first opened. See *The Library Browser on page 669*.

- Click the **Show/Hide Selection Pane**  button to toggle the Selection Pane on and off.
- Click the **Show/Hide Preview Pane**  button to toggle the Preview Pane on and off. Not available for materials.
- Click the **Toggle Preview Display**  button to switch between Standard Render and Vector View images of a selected library object in the Preview Pane. This setting is remembered between visits to this dialog and is not available for materials.
- For materials, select an object shape to display the material on in the preview on the far right: Cube, Sphere, Teapot, or Plane.

An additional button allows you to add new content to the User Catalog. The available option varies depending on the type of library item being assigned or inserted into another object.

- Click the **Add New Fill Style**  button to open the Fill Style Specification dialog. See *Fill Style Specification Dialog on page 131*.
- Click the **Add New Backdrop**  button to open the Import Backdrop File dialog. See *3D Backdrops on page 812*.
- Click the **Add New Material**  button to open the Define Material dialog and create a new material saved in the User Catalog. See *Define Material Dialog on page 726*.

The OK button is only active when a library item is selected. If a library folder or catalog is selected, the OK button cannot be clicked.

PLAN MATERIALS PANEL

The PLAN MATERIALS panel is similar to the Plan Materials dialog and lets you select from a list of materials already present in the plan as well as manage that list. See [Managing Plan Materials on page 725](#).

Select “Use Default” from the top of the list to apply the default material to the selected object, if applicable.

MATERIAL DEFAULTS PANEL

The MATERIAL DEFAULTS panel will only be present if the Select Material dialog was accessed via an object specification dialog where a component of an inserted library symbol was selected.

Rather than apply a specific material to the selected component, you can dynamically associate it with a Material Default category. See [Material Defaults on page 712](#).

Editing Materials

Much like objects, materials in Home Designer can be edited so that they better suit your design needs. There are several ways to customize a material:

- Edit the original material and replace all instances of it in the current plan;
- Create and edit a copy of the original material and replace only some instances of the original in the current plan;
- Edit a material in the Library Browser and apply it in any plan as needed.



Editing the material applied to an object is not the same as applying a different material to that object. See [Material Painter Tools on page 713](#).

ADJUST MATERIAL DEFINITION



The **Adjust Material Definition** tool lets you to make changes to the materials seen in camera views.

Adjust Material Definition has five Painter Modes that allow you to control how extensively your changes to a given material are applied:



Material Painter Component Mode allows you to edit the material applied to a single component on a target object. If any other instances of the original material are present in the current plan, including on other components of the same object, you will be presented with the option of editing a copy of the original material on that component so those other instances can remain unchanged.



Material Painter Object Mode allows you to edit all instances of the material on a target object. If any other instances of the original material are present on other objects in the current plan, you will be presented with the option of editing a copy of the original material on the target object so those other instances can remain unchanged.



Material Painter Room Mode allows you to edit all instances of the material located in the same room as the target object. If any other instances of the original material are present in other rooms in the current plan, you will be presented with the option of editing a copy of the original material so those other instances can remain unchanged.



Material Painter Floor Mode allows you to edit all instances of the material located on the same floor level as the target object. If any other instances of the original material are present on other floors in the current plan, you will be presented with the option of editing a copy of the original material so those other instances can remain unchanged.



Material Painter Plan Mode allows you to edit all instances of the material in the current plan. When Plan Mode is selected, the original material is modified and creating a copy of it is not an option.

To use the *Adjust Material Definition* tool

1. Create a camera view in which a material that you would like to modify can be seen.
2. While the camera view is active, select **3D> Adjust Materials> Adjust Material Definition** .
3. Notice that the **Adjust Materials Painter Mode** buttons become available on the Edit Toolbar, and click on the Mode that suits your needs.
4. Select the material that you want to edit:
 - Move your mouse pointer over a surface and notice the Status Bar reports that material's name.
 - Click on a surface displaying the material you want to edit.
5. If the material is assigned to any objects outside of the scope set by the selected Mode, the Create Copy of Material dialog will open.

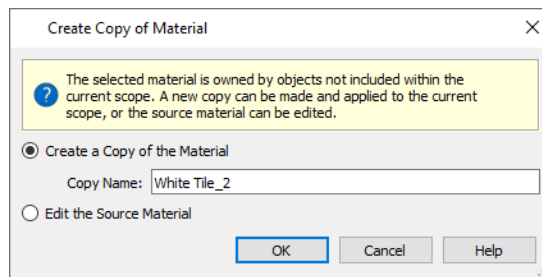

- Select **Create a Copy of the Material** to make a copy of the material and leave the original unchanged, then type a name for the new material in the **Copy Name** text field.
 - Select **Edit the Source Material** to modify the original material and apply your changes plan-wide.
6. The Define Material dialog opens next, allowing you to edit either the original material or a copy of it. See [Define Material Dialog on page 726](#).
 7. When you click OK, your customized material will be applied in the current plan according to the selected Mode.

Changing a material definition using the **Adjust Material Definition** tool only affects objects in the current plan that are using that material. It does not affect any materials saved in the library or materials used in other plans. See [Adding Library Content on page 681](#).

PLAN MATERIALS



You can also edit, copy, and create new materials in the Plan Materials dialog. Select **3D> Plan Materials** to open this dialog for the current plan.

IN THE LIBRARY BROWSER

Materials saved in the User Catalog of the Library Browser are editable: right-click on one and select **Open Object**  from the contextual menu to open the Define Material dialog for that material. See [Editing Library Objects on page 691](#).

Creating Materials

Home Designer provides a wide variety of materials - including numerous name brand material catalogs - that are ready to download and use. If you cannot find a suitable material, you can edit an existing material or create a new one. See [Editing Materials on page 719](#).

TEXTURE FILE MANAGEMENT

Materials often have a texture which is an image file that add realism to the material's appearance. In order to display a material's texture, Home Designer needs to be able to locate the image file associated with it on your computer. See [Referenced Files on page 43](#).

If a texture referenced by a newly created material is not located in either the Home Designer Pro 2022 Data folder or the installation folder for the program's library textures, a copy of the file will be made in Home Designer Pro 2022 Data\Textures\Material Data and the material will reference that copy. See [Home Designer Pro Data on page 33](#).

IN THE PLAN MATERIALS DIALOG

There are two ways to create a new material in the Plan Materials dialog. See [Managing Plan Materials on page 725](#).

- Click the **New** button to create a new material for use in the current plan file.
- Select a material and click the **Copy** button to make a new material based on the original, which can then be edited and used in the current plan.

IN THE LIBRARY BROWSER

Materials can be created in the Library Browser, making them available for use in any plan. See [Adding Library Content on page 681](#).

In the directory pane of the Library Browser, right-click on an unlocked folder and select **New> Material**  from the contextual menu. See [Using the Contextual Menus on page 673](#).

The Define Material dialog opens, allowing you to specify the new material's attributes. See [Define Material Dialog on page 726](#).

USING PASTE IMAGE

A new material can be created by copying an image that will serve as its texture to the system clipboard, then navigating to a Home Designer Pro window and selecting **Edit> Paste> Paste**  from the menu. See [Cut, Copy, and Paste on page 117](#).

COPYING MATERIALS

 When the **Adjust Material Definition** tool is used with any scoping mode other than Plan Mode, the program will prompt you to choose whether to edit the original material or create a copy of it. See [Adjust Material Definition on page 719](#).

BLENDING MATERIALS

 In 3D views, you can create a new material by blending a solid color such as a paint color with a textured and/or patterned material. Select **3D> Material Painter> Blend Colors With Materials** to toggle this feature on or off. See

Blend Colors With Materials on page 715.

The result is a new material that is saved in the current plan. It can be found in the Plan Materials dialog, edited as needed, and added to the library if desired. See *Managing Plan Materials on page 725.*

Materials created using the **Blend Colors With Materials**  tool are given the name of the patterned/textured material with the extension "--PAINTED:" followed by the name of the solid color material.

Component	Material
▼ Base cabinet	
Backsplash	Default: White Tile
Cabinet	Rustic Hickory--PAINTED: Color - Chocolate

Mapping Patterns and Textures

Materials have two attributes that determine what they look like in 3D views: patterns and textures. See *About Materials on page 712.*

Both patterns and textures have points of origin, which determine where the pattern or texture begins on an X/Y axis. By default, this origin is 0,0; however, you can specify a different origin for each in the Define Material dialog. See *Define Material Dialog on page 726.*

You can also specify whether a material's pattern and texture origins are set globally or independently for each object. By default, this mapping is per object; check **Global Symbol Mapping** on either the TEXTURE or PATTERN panel of the Define Material dialog to map all instances of the material throughout the plan from the same origins.

If a material is set to map globally, it may not look right on some surfaces in 3D views. If this is the case and you do not wish to map the material independently on each object, you can create a copy of the material for each surface that requires modification and specify its texture's origin.

 The fill styles of CAD objects are similar to material patterns and can also be mapped on an individual object basis. See *Fill Style Specification Dialog on page 131.*

DETERMINING THE ORIGIN

Before a new origin can be specified, the display of coordinates in the Status Bar should be enabled. See *The Status Bar on page 23.*

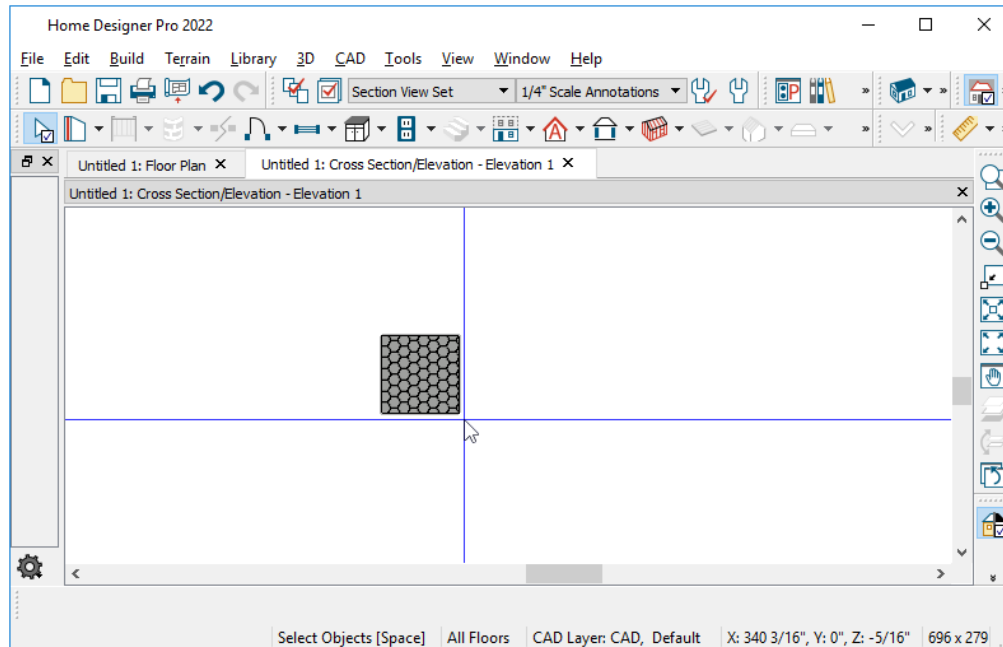

To determine origin coordinates on the horizontal plane, place your cursor over the origin location in floor plan view. When the pointer is in the position you want to establish as the material origin, take note of the coordinates that display in the Status Bar.

To determine origin coordinates on the vertical plane, place your cursor over the origin location in a cross section/elevation view.

Once you have taken note of the new origin coordinates, enter them as Horizontal and Vertical Offsets on either the PATTERN or TEXTURE panel of the Define Material dialog. See [Define Material Dialog on page 726](#).

A texture or pattern origin is a property of the material rather than of the object that the material is assigned to. When an object is moved, the pattern or texture maintains its absolute position and may not look right. It is a good idea to assign pattern or texture origins only after the position of the object has been finalized.

STRETCH TO FIT

Some special textures, often used for artwork, do not tile. Instead, these textures resize to stretch across any surfaces that they are applied to. Materials that behave this way are specified as **Stretch to Fit** in the Define Material dialog. See [Define Material Dialog on page 726](#).

To display an artwork texture, first place a wall or desk frame in your plan. A selection of both are available in the library. See [Placing Library Objects on page 686](#).

Next, simply apply a material specified as **Stretch to Fit** to the center portion of the frame. See [Material Painter Tools on page 713](#).

Materials and the Materials List

When applied to structural components like slabs or wall, floor and ceiling, or roof layers, materials determine how or whether those components are calculated in the Materials List. Each material's Structure Type and its Calculation Method are specified in the Define Material dialog. See [Materials List Panel on page 733](#).

MATERIAL STRUCTURE TYPES

The Material Structure Type controls how or whether certain structural features generate in the model.

- The Concrete type must be assigned to a wall type in order for a brick ledge to be cut into it. This type is also required to produce rebar and steel mesh in the Materials List. It is recommended for concrete walls, footings and monolithic slabs See [Foundations on page 481](#) and [Brick Ledges on page 231](#).
- The Masonry type must be assigned to the exterior layer of a wall type in order to generate a brick ledge in the wall below.
- The Steel Framing type is necessary in order to generate C-channel wall studs. Both Steel Framing and Framing types produce Lumber type framing in floor and ceiling platforms and roof plane assemblies.
- The Other type is useful for other structural applications such as sheathing and siding.

CALCULATION METHODS

A material's Calculation method controls how it is counted in the Materials List when it is applied to structural components like wall, ceiling, floor, layers, or slabs.

For walls, structural assembly layers, and slabs, "Area", "Count" and "Linear" calculations are based on the area of the assembly or the top of the slab. If a material is calculated by "Count", its Depth is not used; however, the thickness of the layer or slab is noted in the Size column of the Materials List.

For Soffits, "Area", "Count" and "Linear" calculations are made for all sides of the object. The Depth of materials calculated by "Count" is used, but thickness is otherwise not noted.

- "Area" calculates the total area of a material in structural layers and slabs in square feet (m).
- "Count" calculates a piece count based the material's Width, Height, and Depth.
- "Linear" calculates the total length of strips required to cover the area in feet (m).
- "Volume" calculates the total volume of a material in structural layers and slabs in cubic yards (m)
- "None" prevents the material from being calculated in the materials list at all.
- "Framing" calculates materials using the selected Structural Member Reporting method. It is only available when the "Framing" Material Structure Type is selected. See [Structural Member Reporting on page 907](#).

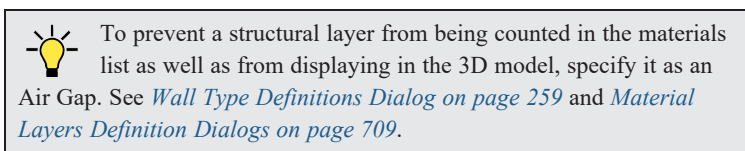

Once a Materials List has been created, the unit of measurement can be changed. See [Changing Count Units on page 914](#).

REPRESENTING OVERLAP

Any material using the Count or Linear Calculation method can be set up to account for material overlap in the Define Material dialog. To do this:

- On the PATTERN panel, set up the material's pattern so that it accurately represents the size and shape of the exposed portion of an individual piece or strip.
- On the TEXTURE panel, set the Scale to represent the appearance of the exposed material in rendered 3D views.
- On the MATERIALS LIST panel, specify the full size of the actual material, including the overlapped portion.

If a material is set up to represent overlapping pieces, it is important that you not click the **Update from Pattern** button. See [Materials List Panel on page 733](#).

Managing Plan Materials

 The Plan Materials dialog allows you to manage the materials used in the current plan. Select **3D> Materials> Plan Materials** to open this dialog. You can also access its settings in the Select Material dialog. See [Select Material/Library Object Dialog on page 717](#).

When a material is applied to an object in a plan, a copy of that material is created and saved with the plan. If you use the Define Materials dialog to modify that material, your changes affect it wherever it is found throughout that plan. All objects in that plan that use that material are affected, but objects placed in other plans are not.



All materials that come with Home Designer are stored in the Library Browser. You can create your own materials and save them there, as well. See [Creating Materials on page 721](#).

PLAN MATERIALS DIALOG

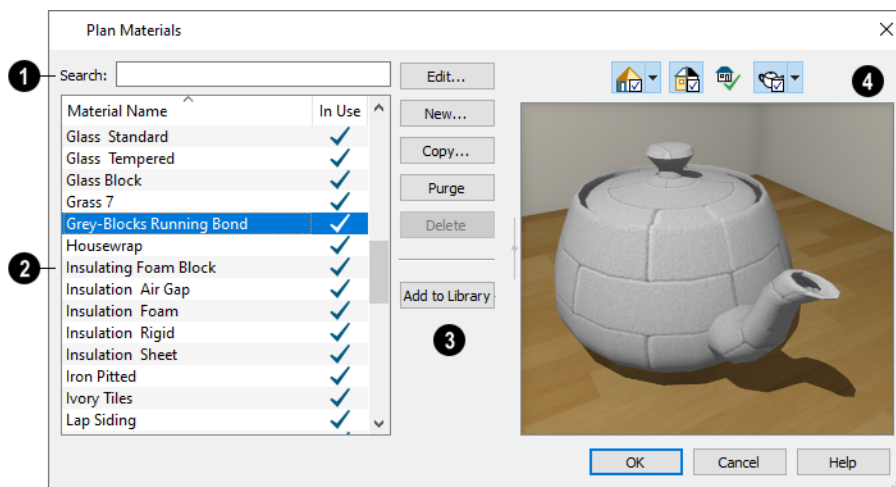

1 Search

Begin typing in the text field. As you type, the list below will be filtered to show only materials with names that contain your text.

2 Plan Materials

A sortable, scrollable list of the materials referenced by the current plan displays here. Click on the name of a material to select it. Select multiple materials by holding down the Shift or Ctrl key.

- If there is a check mark in the **In Use** column, the material is used by one or more objects in your plan or is defined as a default material for one or more objects in your plan.
- If the **In Use** column is empty, the material was used at one time but is no longer assigned to any objects or used as a default.

3 Management Options

The buttons on the right allow you to modify the selected material and manage the items in the list.

- Click **Edit** to open the Define Material dialog for the selected material. See [Define Material Dialog on page 726](#).
- Click **New** to open the Define Material dialog to create a new material.
- Click **Copy** to create a copy of the selected material and open the Define Material dialog where you can make changes to the copied material.
- Click **Purge** to remove all unused materials from the plan.
- Click **Delete** to remove the selected material from the plan. If the material is used in the model, you cannot delete it.
- Click **Add to Library** to add the selected material to the Library Browser, making it available for use in other plans. See [Adding Library Content on page 681](#).

4 Preview

A preview of the material applied to an object displays here. If multiple materials are selected at once, the first one in the list will display. Various options allow you to view different aspects of the material's attributes:



- Display the material in Physically Based, Standard rendering, or Vector View.
- Zoom and orbit the object in the view.
- Toggle Color on or off.
- Click the **Restore Original View**  button to reset the material preview to its original perspective.
- Select an object shape: Cube, Sphere, Teapot, or Plane.

The Rendering Technique and object shape selections in this dialog's preview are shared with the Define Material dialog. Unlike other dialog previews, these are retained when you close the dialog. The object shape selection is also shared with the Library Browser. See [Dialog Preview Panes on page 20](#) and [The Library Browser on page 669](#).

Define Material Dialog

The Define Material dialog allows you to adjust how materials look in 3D views as well as how they are calculated in the Materials List.

The Define Material dialog can be accessed in a number of ways:

- Use the **Adjust Material Definition**  tool. See [Adjust Material Definition on page 719](#).
- Select a material from the Plan Materials dialog and click **Edit**, **New**, or **Copy**. See [Managing Plan Materials on page 725](#).
- Right-click on a material in the User Catalog in the Library Browser and select **Open Object**  from the contextual menu. When multiple materials are selected, some settings will not be available. See [Using the Contextual Menus on page 673](#).
- You can also right-click on the User Catalog and select **New> Material**.

If you select a material from a Manufacturer Catalog, some options in the Define Material dialog may not be available and the panels may vary. See [Manufacturer Catalogs on page 677](#).

If you access the Define Material dialog through a menu or specification dialog, any changes you make will affect that material wherever it is found in the current plan. Other objects in that plan using that material will also be affected, but

objects outside the current plan will not. You can click the **Add to Library** button at the bottom of the dialog to add the material to the User Catalog for future use in any plan. See [Adding Library Content on page 681](#).

The Rendering Technique and object shape selections in this dialog’s preview are shared with the Plan Materials dialog and, unlike other dialog previews, are remembered during the current program session. See [Dialog Preview Panes on page 20](#).

The Define Material dialog has the following panels:

PATTERN PANEL

Patterns are used to represent materials in Technical Illustration and Vector Views. See [Patterns and Textures on page 712](#).

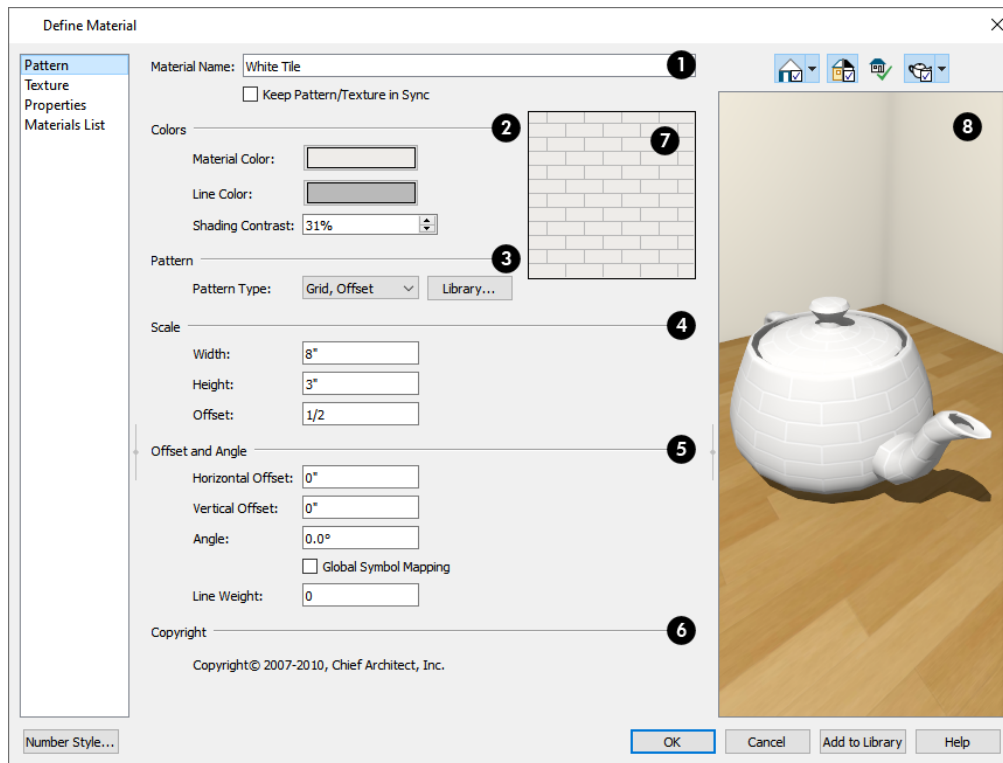

1 Material Name

The **Material Name** displays here. You can type a different name if you wish. Renaming the material does not create a new material: it redefines the existing material. See [Creating Materials on page 721](#).

- Check **Keep Pattern/Texture in Sync** to maintain consistent **Scale** and **Offset and Angle** settings for both the selected material’s pattern and its texture if any of these settings are modified.

2 Colors

Specify the **Colors** used to represent the material's pattern in Vector Views. Click either color box to open the Select Color dialog and select a color. See [Select Color Dialog on page 134](#).

- The **Material Color** displays in Vector Views and is also used if a material has no texture specified. See [In Vector Views on page 748](#).
- The pattern **Line Color** displays in Vector Views only.
- Specify the **Shading Contrast**, which is the amount of contrast between surfaces at different angles to each other in Vector Views. See [Vector View on page 785](#).

The following shows a curved wall with three different Shading Contrasts (created in a separate graphics program). Notice how the lowest contrast at the top appears almost flat.

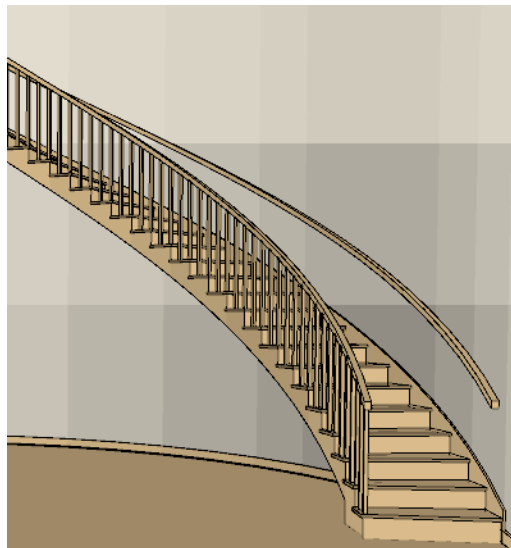

3 Pattern

When “No Pattern” is selected as the Pattern Type, the Scale, Offset and Angle settings are disabled.

- Select a **Pattern Type** from the drop-down list. Select “Library” or click the **Library** button to select a pattern from the library. When a pattern is selected from the library, its name will display in the list. See [Select Library Object Dialog on page 688](#).

4 Scale

- Specify the **Width** of the selected pattern. For Concrete and Sand materials, instead adjust the overall pattern **Spacing**.
- Specify the selected pattern's **Height**. Only available for Brick, Tile, Shingles, and U's patterns.
- Specify the pattern's **Scale**. If the pattern appears black in the square preview pane, this value should be increased. Only available for imported patterns and some patterns from the library.

5 Offset and Angle

- Specify the **Horizontal** and **Vertical Offsets**, if needed, so the pattern displays correctly on surfaces. See [Mapping Patterns and Textures on page 722](#).
- Specify the **Angle**, measured counterclockwise, in degrees.
- Check **Global Symbol Mapping** to map the pattern and texture using the same origin on all objects. When unchecked, the origin is defined individually for each object.
- Specify the **Line Weight**, which is the thickness of the pattern lines.

6 Copyright

If the selected pattern has a **Copyright**, information about it displays here.

7 Pattern Preview

A preview of the material's pattern displays in the square pane. It updates as you change the pattern's specifications.

8 Preview

A preview of the material applied to an object displays here and updates as changes are made to the material definition. Various options allow you to view different aspects of the material's attributes:

- Display the material in Standard rendering or Vector View.
- Zoom and orbit the object in the view.
- Toggle **Color** on or off.
- Click the **Restore Original View**  button to reset the material preview to its original perspective.
- Select an object shape: Cube, Sphere, Teapot, or Plane.

The Rendering Technique and object shape selections in this dialog's preview are shared with the Plan Materials dialog. Unlike other dialog previews, these are retained when you close the dialog. The object shape selection is also shared with the Library Browser. See [Managing Plan Materials on page 725](#).

TEXTURE PANEL

In most Rendering Techniques, materials are represented using textures. See [Rendering Techniques on page 785](#).

Transparency information may be contained on the alpha channel of a texture; if so, it is used in rendered views.

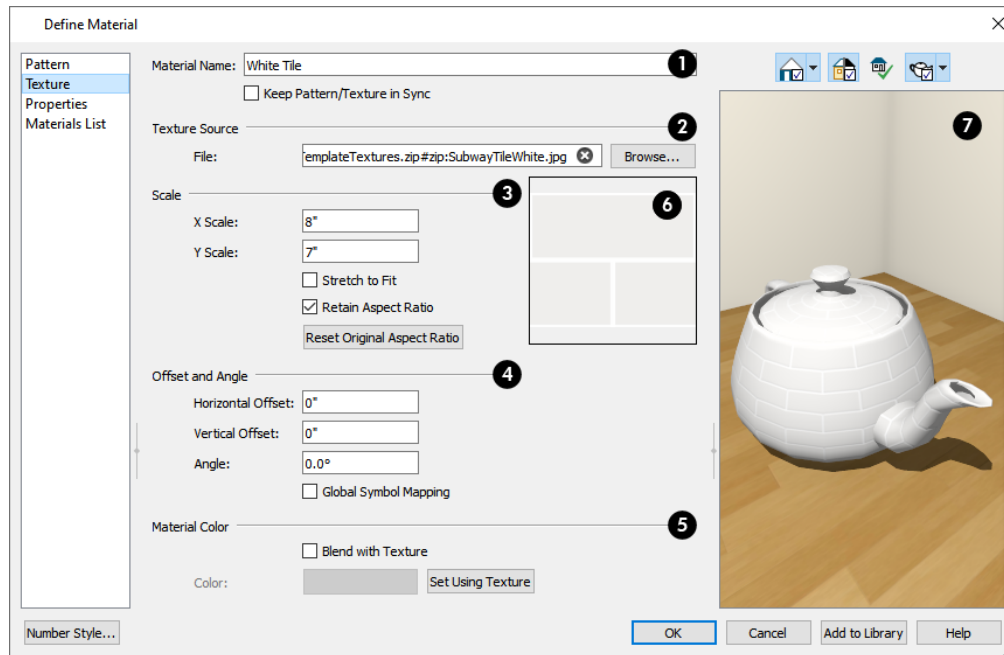

1 Material Name

The Material Name displays here and can be changed if you wish. Renaming the material does not create a new material: it redefines the existing material.

- Check **Keep Pattern/Texture in Sync** to maintain consistent **Scale** and **Offset and Angle** settings for both the selected material's pattern and its texture if any of these settings are modified.

2 Texture Source

Displays the path and file name of the selected texture.

- Click the **Browse** button to browse to a texture file saved on your computer. Supported file formats are **.jpg**, **.bmp**, **.png**, **.gif**, and **.tif**. See *Creating Materials on page 721*.
- You can also type or paste the full path name of a texture in the text field. To remove the file, click the **Remove**  button.
- Textures saved in **.zip** files can also be used. See *To use an image saved in a .zip file on page 731*, below.
- If the texture is not located in either the Home Designer Pro 2022 Data folder or the installation folder for the program's library textures, a copy of the file will be made in Home Designer Pro 2022 Data\Textures\Material Data. See *Home Designer Pro Data on page 33*.

3 Scale

- Adjust the **X Scale** and **Y Scale**, or height and width, of the selected texture.

If a rendered surface is larger than the area described by the Scale, the surface has "tiles" of the texture image. If it is smaller, only a portion of the texture is shown.

- Check **Stretch to Fit** to stretch the texture image to cover each surface it is applied to. Stretch to Fit is typically used for artwork or photography in a frame.

Note: Changing the scale or selecting Stretch to Fit can cause textures to appear distorted if applied to a surface with a different aspect ratio than the original texture image.

- Check **Retain Aspect Ratio** to maintain the ratio between the texture image’s height and width and prevent distortion when either its X or Y Scale value is adjusted.

4 Offset and Angle

See *Mapping Patterns and Textures on page 722*.

- Specify the **X and Y Positions** of the texture’s origin, **if needed**, to adjust its layout on surfaces.
- Specify the **Angle** of the texture on the surfaces of objects, in degrees.
- Check **Global Symbol Mapping** to map the texture and pattern using the same origin on all objects. When unchecked, the origin is defined individually for each object.

5 Material Color

Material Color can also be set on the PATTERN panel. See *Pattern Panel on page 727*.

- Check **Blend with Texture** to apply the Material Color over the material’s texture.

When a new material is created using the **Blend Colors With Materials**  tool, the resulting material has this box checked. See *Blend Colors With Materials on page 715*.

- Click the **Color** button to specify the Material Color.
- Click the **Set Material Color Using Texture** button to use the predominant color of the material’s texture. See *Patterns and Textures on page 712*.

6 Texture Preview

A preview of the material’s texture displays in the square pane. It updates as you change the material definition.

7 Preview

A preview of the material applied to an object displays here and updates as changes are made to the material definition. Various options allow you to view different aspects of the material’s attributes:

- Display the material in Standard rendering or Vector View.
- Zoom and orbit the object in the view.
- Toggle Color on or off.
- Click the **Restore Original View**  button to reset the material preview to its original perspective.
- Select an object shape: Cube, Sphere, Teapot, or Plane.

To use an image saved in a .zip file

1. Type or copy the full path name of the **.zip** file in the text field.
2. Directly after the path name, type #zip:, followed immediately by the name of the bump map file including its file extension.

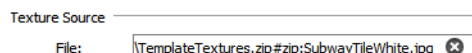

PROPERTIES PANEL

The PROPERTIES panel controls how the material appears in most rendered 3D views.

A material's rendered appearance is also affected by the Render settings in the Preferences dialog and the lights that have been placed in the model. See [Light Types on page 773](#).

For special lighting effects on an object, use at least one point or spot light.

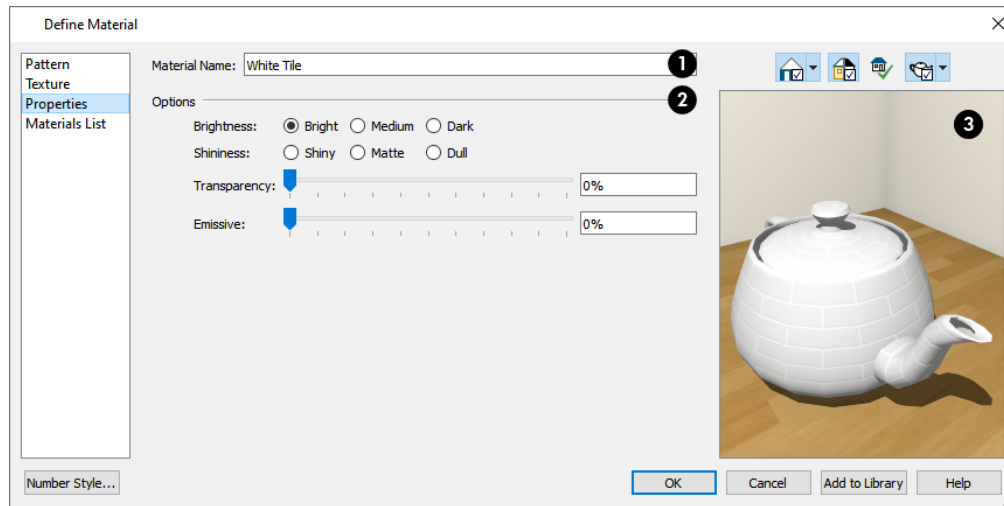

1 Material Name

The **Material Name** displays here. You can type a different name if you wish. Renaming the material does not create a new material: it redefines the existing material.

2 Options

- **Brightness** controls how bright the material appears. It can be used to get the desired appearance relative to other materials being used.
- **Shininess** controls the sheen of the material when it is rendered with a point or spot light source on it. Shiny materials appear to have a bright white spot on them which simulates reflection of light.
- **Transparency** - Use the slider bar or text field to control the materials transparency. A value of 0 is completely opaque and a value of 100 is completely transparent. Specifying materials with transparency can slow down rendering speed in some situations.
- **Emissive** - Use the slider bar or text field to control how bright a material appears independent of the lighting in the scene. It can be used to simulate surfaces that are glowing with their own light, such as the glass on a light fixture.

3 Preview

A preview of the material applied to an object displays here and updates as changes are made to the material definition. Various options allow you to view different aspects of the material's attributes:

- Display the material in Standard rendering or Vector View.
- Zoom and orbit the object in the view.
- Toggle **Color** on or off.
- Click the **Restore Original View**  button to reset the material preview to its original perspective.
- Select an object shape: Cube, Sphere, Teapot, or Plane.

MATERIALS LIST PANEL

The settings on the MATERIALS LIST panel control how the selected material is counted in the Materials List. See [Materials and the Materials List on page 723](#).

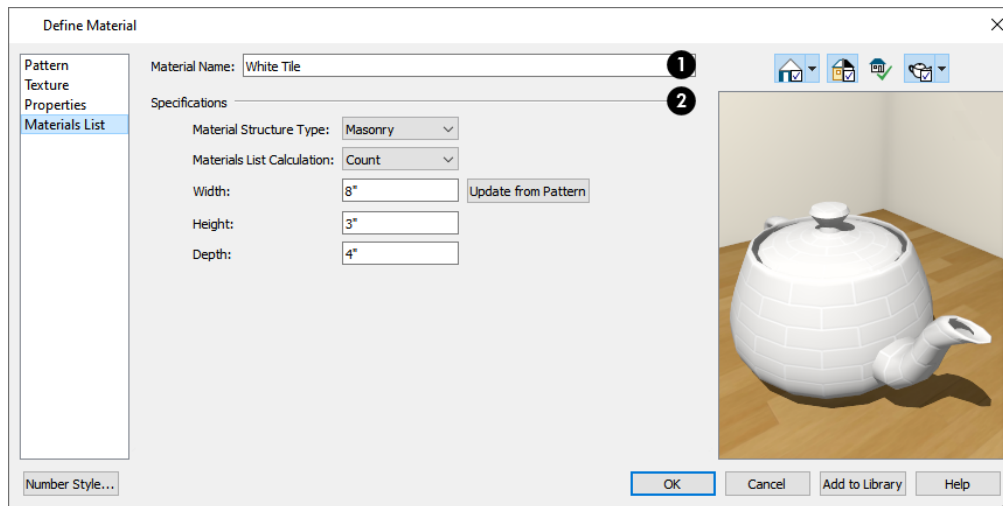

1 Material Name

The **Material Name** displays here. You can type a different name if you wish. Renaming the material does not create a new material: it redefines the existing material.

2 Specifications

- Select a **Material Structure Type** from the drop-down list. The selected Type defines how - or whether - the material is calculated in the Materials List. See *Material Structure Types on page 724*.
- Select a **Materials List Calculation** method. When “Framing” is the selected Structure Type, the only available Calculation Method will be “Framing”. See *Calculation Methods on page 724*.
- The settings that are available below depend on which Calculation method is selected.
- Specify the material’s **Width**. This value is available for Count and Linear Calculation methods.
- Specify the material’s **Height**. Only available for the Count Calculation method.
- Click the **Update from Pattern** button to make the Width and Height values here match those set on the PATTERN panel. Only available when Count or Linear is selected as the Calculation method.
- Specify the material’s **Depth**. Only available for the Count Calculation method, this value is only used for Materials List calculations when the material is applied to a Soffit. This value may also be used if the Material Painter is used to create a floor or ceiling finish. See *Floor and Ceiling Finishes and the Material Painter on page 296*.

MANUFACTURER PANEL

If the selected material is from a Manufacturer library catalog, the Define Material dialog will have a fifth panel: the MANUFACTURER panel, which lists contact information. See *Manufacturer Catalogs on page 677*.

3D Views

Chapter 30

Little preparation is needed to create a 3D view of a model: simply click a button to create an overview or click and drag to create a camera or cross section/elevation view.

To improve the quality of the rendering and create a custom look, you can adjust lighting and edit the materials used in the plan. See *3D Rendering on page 769*.

Many objects can be placed and edited in 3D views, and any camera view or overview can be saved or even used to record a walkthrough. See *Pictures, Images, and Walkthroughs on page 794*.

TOPICS

Types of 3D Views	736
3D View Defaults and Preferences	736
Camera Defaults Dialogs	737
3D View Defaults Dialog	739
3D View Tools	740
Creating Camera Views	741
Creating Overviews	742
Cross Section/Elevation Views	744
Clipped Section Views	745
Displaying 3D Views	747
Navigating in Camera Views	749
Editing 3D Views	754
Cross Section Slider	756
Working in 3D	757
Saving and Printing 3D Views	759
Camera Specification Dialogs	760
Cross Section/Elevation Specification Dialogs	765

Types of 3D Views

There are three categories of 3D views in Home Designer: camera views, overviews and cross section/elevation views. Each of these view types can be generated using a variety of Rendering Techniques. See [Rendering Techniques on page 785](#).

Every 3D view is also either orthographic or perspective in nature. Cross section/elevation views are always orthographic while camera views are always perspective. You can choose to generate overviews as either orthographic or perspective.

PERSPECTIVE AND ORTHOGRAPHIC VIEWS

Perspective views have a focal, or vanishing, point. Surface edges and lines that would be parallel in real life appear to converge towards that focal point, and objects closer to the camera appear larger while objects farther from the camera appear smaller.

Orthographic views do not have a focal or vanishing point. Parallel surface edges and pattern lines appear parallel in these views and objects appear to be the same size regardless of their distance from the camera.

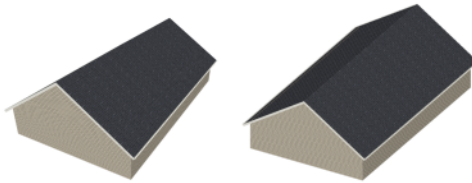

Perspective views display 3D objects much the way that they appear to the eye in real life, so they are ideal for presentation views. By default, perspective views are created using the Standard Rendering Technique.

Orthographic views, on the other hand, are useful for technical drawings. By default, orthographic views are created using the Vector View technique.

RENDERED AND VECTOR VIEWS

3D views can be generated using a variety of different Rendering Techniques. See [Rendering Techniques on page 785](#).

Most rendered views represent materials using textures. Surface edge lines are generally not drawn and lighting is often modeled, creating results that range from a photorealistic appearance to artistic painting styles.

Vector Views are non-photorealistic views in which objects are drawn using surface edge lines, or vectors. Limited lighting and shadows can be calculated and materials are represented using pattern lines and solid colors. Vector Views are ideal for layout drawings and high resolution printing. See [Vector View on page 785](#).

3D View Defaults and Preferences

There are a number of defaults and preference settings that allow you to control the initial characteristics of 3D views.



Camera positioning, field of view and related initial settings for camera views are specified in the Camera Defaults dialogs. See [Camera Defaults Dialogs on page 737](#).



The settings in the **3D View Defaults** dialog control a variety of functions that affect views created by all 3D View tools. See [3D View Defaults Dialog on page 739](#).



The default characteristics of the **Generic Sun** light source can be specified in the Generic Sun Defaults dialog. See [Adjust Sunlight Dialog on page 783](#).



As in plan view, the display of objects in 3D views can be controlled by layer. See [Layer Attributes on page 124](#).



3D views can be generated using any of the **Rendering Techniques**. See [Rendering Techniques on page 785](#).



The initial settings for each Rendering Technique can be set in the Rendering Techniques Defaults dialog. See [Rendering Technique Options on page 787](#).



The RENDER panel of the Preferences dialog has settings that affect 3D views. See [Render Panel on page 85](#).

Camera Defaults Dialogs



There are several defaults dialogs for cameras, which can be accessed by selecting **Edit> Default Settings** or by double-clicking either the **Orthographic or Perspective View Tools** parent button. Select an item in the submenu. In the Default Settings dialog, click the arrow next to “Camera tools”, then select a subheading and click the Edit button to open the defaults dialog associated with your selection.

The defaults dialog for Camera Tools other than Overviews can be accessed by double-clicking the associated toolbar button.

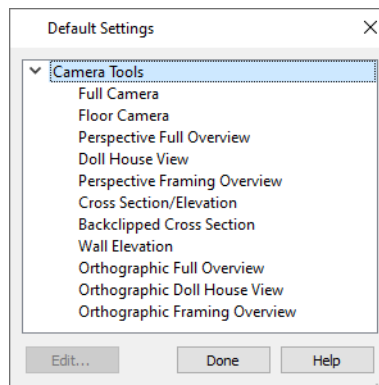

The various Camera Defaults in the list can be multiple-selected and then edited as a group by holding down the Shift or Control keys. Depending on the selection, not all settings may be available. See [Shift and Ctrl Select on page 144](#).

The settings in the Camera Defaults dialogs affect how each type of camera captures, clips, and renders views; how they display in plan view; how they are positioned; and how they move.

Once a camera is created, its attributes can be customized. See [Editing 3D Views on page 754](#).

FULL CAMERA DEFAULTS

Specify the initial attributes of cameras created using the **Full Camera**  tool. See [Camera Views on page 741](#).

The settings in this dialog are the same as those the Full Camera Specification dialog. See [Camera Specification Dialogs on page 760](#).

Note: The Reflections setting in the Full Camera Defaults is used by walkthroughs created using the Walkthrough Path tool. See [Recording a Walkthrough on page 823](#).

FLOOR CAMERA DEFAULTS

Specify the initial attributes of cameras created using the legacy **Floor Camera**  tool. This tool is not in the menus or default toolbars but can be added to the toolbars if you wish. See *Toolbars and Hotkeys on page 89*.

The settings in this dialog are the same as those in the Floor Camera Specification dialog.

PERSPECTIVE FULL OVERVIEW DEFAULTS

Specify the initial attributes of cameras created using the **Perspective Full Overview**  tool. See *Full Overview on page 743*.

The settings in this dialog are the same as those in the Perspective Full Overview Specification dialog.

DOLL HOUSE VIEW DEFAULTS

Specify the initial attributes of cameras created using the **Doll House View**  tool. See *Doll House View on page 743*.

The settings in this dialog are the same as those in the Doll House View Specification dialog.

PERSPECTIVE FRAMING OVERVIEW DEFAULTS

Specify the initial attributes of cameras created using the **Perspective Framing Overview**  tool. See *Overviews on page 741*.

The panels in this dialog are the same as their respective panels in the Orthographic Framing Overview Specification dialog.

CROSS SECTION/ELEVATION DEFAULTS

Specify the initial attributes of cameras created using the **Cross Section/Elevation**  tool. See *Cross Section/Elevation Views on page 741*.

The settings in this dialog are also found in the **Cross Section/Elevation Specification** dialog. See *Cross Section/Elevation Specification Dialogs on page 765*.

BACK CLIPPED CROSS SECTION DEFAULTS

Specify the initial attributes of cameras created using the **Back Clipped Cross Section**  tool. See *Cross Section/Elevation Views on page 741*.

The panels in this dialog are the same as their respective panels in the Cross Section/Elevation Specification dialog. See *Cross Section/Elevation Specification Dialogs on page 765*.

WALL ELEVATION DEFAULTS

Specify the initial attributes of cameras created using the **Wall Elevation**  tool. See *Cross Section/Elevation Views on page 741*.

The panels in this dialog are the same as their respective panels in the Wall Elevation Specification dialog. See *Cross Section/Elevation Specification Dialogs on page 765*.

ORTHOGRAPHIC FULL OVERVIEW DEFAULTS

Specify the initial attributes of cameras created using the **Orthographic Floor Overview**  tool. See [Full Overview on page 743](#).

The panels in this dialog are the same as their respective panels in the Orthographic Full Overview Specification dialog.

ORTHOGRAPHIC DOLLHOUSE VIEW DEFAULTS

Specify the initial attributes of cameras created using the **Orthographic Dollhouse View**  tool. See [Overviews on page 741](#).

The panels in this dialog are the same as their respective panels in the Orthographic Dollhouse View Specification dialog.

ORTHOGRAPHIC FRAMING OVERVIEW DEFAULTS

Specify the initial attributes of cameras created using the **Orthographic Framing Overview**  tool. See [Overviews on page 741](#).

The panels in this dialog are the same as their respective panels in the Orthographic Framing Overview Specification dialog.

3D View Defaults Dialog

 Select **3D > 3D View Defaults** or **Edit > Default Settings**  to open the 3D View Defaults dialog.

The settings in this dialog control a variety of functions that affect views created by all 3D View tools.

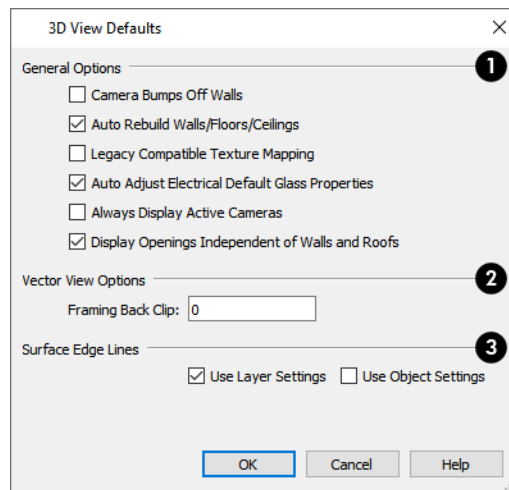

1 General Options

These settings affect all 3D views.

- Check **Camera Bumps Off Walls** to prevent cameras from moving freely through walls. When this setting is on, you can "walk" up a staircase by moving the camera using the Move Camera Tools. This should be unchecked when using a 3D mouse or gamepad. See [3Dconnexion® 3D Mice on page 750](#) and [Move Camera Tools on page 752](#).
- Check **Auto Rebuild Walls/Floors/Ceilings** to automatically rebuild floors and ceilings before a 3D view or elevation is displayed. When this is unchecked and the structure is not up to date, the Rebuild Walls, Floors, Ceilings  icon displays near your mouse pointer. See [Rebuilding Walls, Floors and Ceilings on page 506](#).
- Check **Legacy Compatible Texture Mapping** to use global texture mapping settings rather than texture mapping fixed to individual objects.



Legacy Compatible Texture Mapping should remain unchecked except in legacy plans with custom rotated textures.

- When **Auto Adjust Electrical Default Glass Properties** is checked, the program automatically adjusts the behavior of electrical fixture glass in Standard rendered views in response to interior and exterior lighting conditions. When this box is unchecked, these adjustments are not made.
- Check **Always Display Active Cameras** to turn on the display of active camera symbols, even when the "Cameras" layer is turned off. When unchecked, active camera symbols obey the layer setting.
- When **Display Openings Independent of Walls and Roofs** is checked, doors, windows, and skylights display in 3D views when their containing wall or roof plane does not. Uncheck this to prevent these objects from displaying in 3D when their parent objects do not.

2 Vector View Options

See [Vector View on page 785](#).

- **Framing Back Clip** defines the back clip for framing members in cross section views. Framing must be set to display to see the effects of this value. A zero value does not back clip at all. See [Displaying Framing on page 632](#).

3 Surface Edge Lines

Specify how the Surface Edge Lines display for all objects in 3D views.

- Check **Use Layer Settings** to display surface edge lines for objects using the display settings specified by layer in the Layer Display Options dialog. If this option is not checked, all edge lines are drawn black and solid with a line weight of 0. See [Layer Attributes on page 124](#).
- When **Use Object Settings** is checked, all objects that have non-default settings specified on the LINE STYLE panel of their specification dialog display using those settings, overriding the layer settings in the Layer Display Options dialog. See [Line Style Panel on page 204](#).

3D View Tools



Select **3D> Create Orthographic View** to display the Orthographic View Tools or **3D> Create Perspective View** to display the Perspective View Tools.

There are three types of 3D Views:

CAMERA VIEWS

Camera views are Perspective views. They are not scaled and cannot be annotated but are ideal for creating presentation views.



The **Full Camera** tool creates multi-floor views of the 3D model. It can be used to create interior and exterior perspectives, and is good for displaying cathedral ceilings, roofs, lofts, stairwell openings, and other variation in floor and ceiling levels.



The **Floor Camera** tool creates perspective views of the current floor only. Nothing above the ceiling surface is generated, and neither is anything below the floor. This legacy tool is not in the menus or default toolbars but can be added to the toolbars if you wish. See [Toolbars and Hotkeys on page 89](#).

OVERVIEWS

An overview can be either orthographic in nature or perspective, depending on the tool used to create it. See [Creating Overviews on page 742](#).



The **Orthographic** and **Perspective Full Overview** tools create views of the entire model including all floors, ceilings, and the roof.



The **Orthographic** and **Perspective Doll House View** tools create views of the current floor with the ceiling removed and all floors beneath it visible.



The **Orthographic** and **Perspective Framing Overview** tools create views of the framing in the model. Framing must be built in order for it to display in a framing overview. See [Framing Overview on page 743](#).

CROSS SECTION/ELEVATION VIEWS

Cross Section/Elevation views are similar to the traditional, scaled orthographic views often used in drafting. They are scaled and can be fully annotated. See [Cross Section/Elevation Views on page 744](#).



A **Cross Section/Elevation** view displays all floors of the model. If the view is created outside the structure looking toward it, the result is an exterior elevation. If the view is created inside the structure, or passes through any of the structure, a cross section is created.



The **Back Clipped Cross Section** tool includes only the objects between the starting point and stopping point of the cross section line.



The **Wall Elevation** tool creates an elevation of a wall on a single floor and in a single room. The **Wall Elevation** tool cannot be used to create exterior views.

Creating Camera Views

All Camera views are created using the same method.

To create a camera view

1. In plan view, select the desired camera tool. The mouse pointer displays the camera  icon.
2. Click and drag a line to define the view direction.

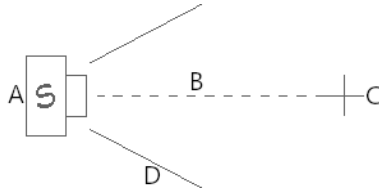

- A. Camera Position (click)
- B. Line of Sight (drag)
- C. Focal Point (release)
- D. Field of View

- The camera's position is where you click to begin the line.
 - The line that you drag defines the direction the camera is pointed.
 - The end of the line is the focal point of the view, the point the camera rotates around.
 - The Field of View is 55° by default.
3. When you release the mouse button, a view generates in a new window.
 4. Return to the plan view. A camera symbol now displays in plan view. See [Working in Multiple Views on page 103](#).

In order to create a camera view, you must click and drag at least as far as your current **Snap Distance**. See [Snap Properties Panel on page 78](#).

A new camera can also be created by copying and pasting an existing camera symbol selected in plan view. See [Copying and Pasting Objects on page 117](#).

CAMERA HEIGHT

By default, Cameras are created at a height of 60" (1500 mm). Where this height is measured from depends on the location of the camera:

- If the camera is inside of a room, it is measured from that room's subfloor.
- If the camera is outside of a room but inside of the Terrain Perimeter, it is measured from the terrain at the location of the camera.
- If the camera is located in neither a room nor within the Terrain Perimeter, it is measured from the default height of the subfloor for the current floor.

Once created, a camera's height can be modified in its Camera Specification dialog, and the default height value can be set in the Camera Defaults dialog. See [Camera Panel on page 760](#).

Creating Overviews

In Home Designer, there are three different overview types: Full, Doll House, and Framing Overviews.

Each type of overview can be generated as either an orthographic or perspective view. An overview window's title bar indicates whether it is perspective or orthographic. See [Perspective and Orthographic Views on page 736](#).

Overviews generate as soon as you select the tool and are always created at the same 120° angle. The initial focal point is located at the center of the architectural model: the terrain is not taken into consideration determining its position. The distance of the camera from the model will vary depending on its size: the larger the architectural model, the further away the camera will be from the focal point so that the entire model can be seen in the view.

A new overview camera can also be created by selecting an existing overview camera in plan view and then copying and pasting it. See [Copying and Pasting Objects on page 117](#).

Once generated, an overview window's title bar indicates its view type and a camera symbol in plan view represents its location. An overview camera can be edited much like regular camera views can. See [Editing 3D Views on page 754](#).

FULL OVERVIEW



Select **3D> Create Orthographic View> Orthographic Full Overview** or **3D> Create Perspective View> Perspective Full Overview** to generate an exterior view of the entire model.

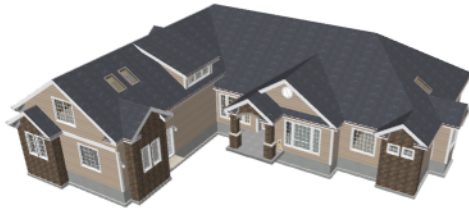



DOLL HOUSE VIEW

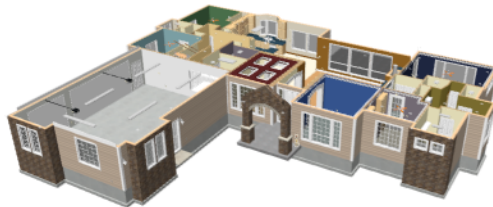

Select **3D> Create Orthographic View> Orthographic Doll House View** or **3D> Create Perspective View> Perspective Doll House View** to create a view of the current floor with the ceiling removed and all floors beneath it visible.

Doll House Views are an effective tool for illustrating traffic flow and the relationships between spaces.



To see a different floor, select **Tools> Floor/Reference Display> Up One Floor**  or **Down One Floor** . You can also return to plan view and make another floor current before generating the Doll House View.

If you prefer, you can specify in the Camera Defaults dialog that only the current floor be included in Floor Overviews. See [Camera Defaults Dialogs on page 737](#).

FRAMING OVERVIEW



Select **3D> Create Orthographic View> Orthographic Framing Overview** or **3D> Create Perspective View> Perspective Framing Overview** to create a view of the entire model, displaying only framing and the foundation.

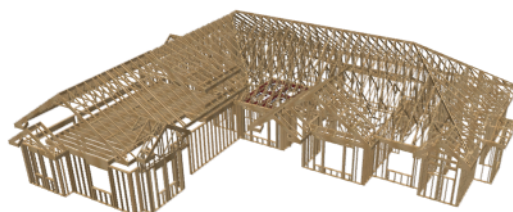



Framing overviews include all floor, wall, and roof framing as well as foundations. Unlike other overviews, which use the Camera View layer set, Framing Overviews use the 3D Framing Set. See [Layer Sets on page 127](#).

Framing must be built before generating this view or the view will be empty.

Cross Section/Elevation Views



The cross section/elevation tools produce the traditional, orthogonal views often used in drafting. Regardless of their distance from the camera, all lines and dimensions in these views are their true lengths, making it easy to accurately see the spatial relationships of the 3D objects in the model. Each of these tools has a specific function:

-  A **Cross Section/Elevation** view displays all floors of the model. The cross section begins at the point where the camera arrow is drawn and continues through the entire model.
-  The **Back Clipped Cross Section** tool includes only the objects or portions of objects between the starting point and stopping point of the camera's Line of Sight.
-  The **Wall Elevation** tool creates an interior elevation of a single wall defining the room that the camera is drawn in. It creates a 2D projection of that wall and the objects located between that wall and its Cross Section Line; does not cut through walls or show the ceiling, floor, or roof; and is used primarily for kitchen and bath elevations. This tool cannot be used to create exterior views.

Cross section/elevation views are the only 3D views that can be enhanced with the 2D CAD tools. They can be fully annotated and dimensioned and then printed to scale. See [Detailing Cross Section/Elevation Views on page 745](#), below.

Cross Section/Elevation, **Back Clipped Cross Section**, and **Wall Elevation** views are created in the same way.

To create a cross section/elevation view

1. Select the **Cross Section/Elevation** , **Back Clipped Cross Section** , or **Wall Elevation** tool. The pointer changes to a  with crosshairs marking the position of the pointer.
2. Click and drag a line in plan view.
 - If you selected the Wall Elevation tool, you must click inside a room area.
 - A Camera symbol displays where you click, along with a Cross Section Line indicating the plane of the camera's cross section cut line.

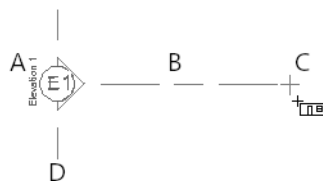

- A. Camera location (click)
- B. Line of Sight (drag)
- C. Focal Point (release)
- D. Cross Section Line

3. Drag in the direction of the Line of Sight to draw a camera arrow.
 - Always drag the camera arrow perpendicular to the wall to be viewed.
 - If the view is a Back Clipped Cross Section, a second Cross Section Line at the end of the Line of Sight indicates the furthest extent of the back clip.

4. When you release the mouse button, the view generates in a new window.
5. Once created, a cross section/elevation view's extents can be edited. See [Camera Panel on page 766](#).

As with camera views, you must click and drag at least as far as your current **Snap Distance** in order to create a Cross Section/Elevation view. See [Snap Properties Panel on page 78](#).

A new cross section/elevation view can also be created by copying and pasting an existing cross section/elevation camera symbol selected in plan view. See [Copying and Pasting Objects on page 117](#).

Once created, the clipping in all cross section/elevation views can be customized to control how much of the model is included in the view. See [Camera Panel on page 766](#).

If the Line of Sight does not cut through a 3D object and the object is within the back clipped distance, such as a window shown in elevation, the object retains its 3D definition and can be selected, moved, stretched, or otherwise modified in the view. The 3D model is updated in all views.

DETAILING CROSS SECTION/ELEVATION VIEWS



CAD objects, including Text and Dimensions, can be created in cross section/elevation views. These objects are superimposed on the view and have no effect on the 3D model itself. If CAD objects have been added to a cross section/elevation view, the program will prompt you to save the view before closing the window. This information is then stored in the view.

In cross section views, some objects, such as walls, may be represented using Cross Section lines. If a dimension line finds an object surface edge represented by a Cross Section line, a Point Marker will be placed at that location, and the dimension will locate it instead of the Cross Section line. See [Markers on page 357](#).

CAD objects will snap to the Snap Grid when **Grid Snaps**  are enabled. Note that the 3D model may obscure the display of the Snap Grid. See [Grid Snaps on page 115](#).

Annotated cross section/elevation views can be sent to layout. See [CAD and Text in Layout on page 926](#).

Clipped Section Views

The Cross Section/Elevation Specification dialog has Scene Clipping options that allow you to control the extents of the view and thus how much of the model it shows. See [Camera Panel on page 766](#).

In plan view, information about its front, back, and side clipping are indicated when a camera symbol is selected. In a clipped view, side and elevation clipping are indicated using Clip Lines on the "CAD, Clip Lines" layer. See [Displaying 3D Views on page 747](#).

FRONT AND BACK CLIPPING

All cross section/elevation views have a clipping plane positioned at the same location as the camera and running perpendicular to its Line of Sight. This front clipping plane is also referred to as the Cross Section Line, and is shown in plan view when the camera's symbol is selected. If an object is positioned so that it is cut by this plane, its edges will be drawn but the object will not be selectable in the view.

There are two ways to adjust the position of the front clipping plane:

- Specify the camera's **X and Y Position** value in the Cross Section/Elevation Specification dialog.
- Use the camera's edit handles in plan view to reposition the start point of its Line of Sight.

By default, Back Clipped Cross Section views also have a second clipping plane: the Back Clip plane, which controls how far into the model from the camera the view extends: objects located further from the camera than the Back Clip plane are not included in the view while those located between the front and back planes are. A Back Clip can be specified for any cross section/elevation view once it has been created.

There are two ways to specify the distance between the front and back clipping planes:

- Set a specific **Back Clip After** value in the Cross Section/Elevation Specification dialog.
- Use the camera's edit handles in plan view to move the end of its Line of Sight, changing its length.

SIDE CLIPPING

By default, cross section/elevation views include the entire width of the 3D model. You can instead choose to **Clip Sides** in the Cross Section/Elevation Specification dialog. There are three ways to specify a view's **Clip Width**:

- Set a specific value in the Cross Section/Elevation Specification dialog.
- Use the edit handles in plan view to change the length of the Cross Section Line, or front cutting plane.
- In the view itself, turn on the "CAD, Clip Lines" layer and adjust the position of the vertical Side Clip lines using the edit handles.



You can toggle side clipping in an active view by selecting **3D> Camera View Options> Clip Sides**. This option is not available for views set to Clip to Room.

TOP AND BOTTOM CLIPPING

By default, cross section/elevation views include the entire height of the 3D model. You can instead choose to **Clip Elevation** in the Cross Section/Elevation Specification dialog. There are two ways to specify the top and bottom extents of a clipped view:

- Set a specific **Bottom** and **Top Clip Elevation** values in the Cross Section/Elevation Specification dialog.
- In the view itself, turn on the "CAD, Clip Lines" layer and adjust the position of the horizontal Elevation Clip lines using the edit handles.



When both Side and Top/Bottom Elevation clipping are in use, the Make Parallel/Perpendicular edit tools can be used to customize the horizontal top and bottom clipping planes. These tools do not affect the vertical side clipping planes, however. See [Make Parallel/Perpendicular on page 169](#).



You can toggle elevation clipping in an active view by selecting **3D> Camera View Options> Clip Sides**. Not available for views set to Clip to Room.

CLIP TO ROOM

The **Clip to Room** option in the Cross Section/Elevation Specification dialog is only available when a selected view camera is located inside of a room. This option is the default for Wall Elevation views, and produces a view showing a single wall defining the camera's room along with any objects between the camera and that wall. When this setting is in use, the other clipping options are disabled.

Displaying 3D Views

A variety of tools and settings allow you to control the appearance of 3D views. There are also numerous ways to adjust a 3D view's position, focal point and field of view. See [Editing 3D Views on page 754](#).

The name of the current plan file and the type of view displays at the top of each view window in its title bar. If a 3D view is saved, its name also displays.

There is no limit to the number of 3D view windows that you can have open at a given time; bear in mind, though, that each window demands use of your computer's resources and that you may see poor performance if too many views are open. See [Working in Multiple Views on page 103](#).

 The 3D model will rebuild automatically as you draw; however, if you notice any anomalies in the model in 3D, select **3D> Rebuild 3D** to regenerate all 3D data associated with the current plan. All open views will remain open.

LAYER DISPLAY OPTIONS

As in plan view, the display of objects in 3D views can be controlled by layer. See [Layer Display Options Dialog on page 126](#).

Different view types use different layer sets when they are created. See [Layer Sets on page 127](#).

To show framing in a cross section/elevation view, framing must first be built using the Build Framing dialog and the appropriate framing layers must be turned on in the Section View layer set. See [Framing on page 605](#).

To show a view's Clip Lines, turn on the "CAD, Clip Lines" layer in that view. See [Clipped Section Views on page 745](#).

IN PLAN VIEW

Cameras are represented in plan view by symbols that indicate the camera's position, field of view and focal point.

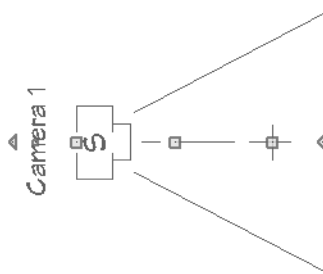



2D camera symbols are located on the "Cameras" layer. See [Layers on page 123](#).

By default, active camera symbols display regardless of whether the "Cameras" layer is on or off. If you prefer that their display be turned on or off with this layer, uncheck **Always Display Active Cameras** in the 3D View Defaults dialog. See [3D View Defaults Dialog on page 739](#).

Active camera symbols and callouts use the **Selection Line** color set in the Preferences dialog. All other display attributes are derived from the "Cameras" layer. See [Colors Panel on page 62](#).

You can also display camera symbols for saved cameras when the "Cameras" layer is turned on. See [Layers on page 123](#).

The symbols for Full Overviews, Cross Section/Elevation, and Back Clipped Cross Section views display on all floors, while those for Full Cameras, Floor Overviews, and Wall Elevations display only on the floor where they were created.

You can also move a camera to a different floor by clicking the **Up One Floor**  or **Down One Floor**  button while the camera view is active. Note that this may affect what is seen in the view as well as its display in plan view. See *Floor Up / Floor Down on page 508*.

Both saved and unsaved active cameras can have labels indicating the camera number or its name. Camera labels are located on the “Cameras, Labels” layer. See *Label Panel on page 363*.



Camera labels are numbered sequentially in each plan in the order they were created unless you rename them.

- Camera labels always use the Camera Name. Saved cameras’ names can be specified in the Camera Specification dialogs. See *Camera Panel on page 760*.

Camera symbols are an on-screen reference: they do not print unless **Print Image** is used and cannot be sent to layout except as an image. They are, however, included in views exported to .dxf

IN RENDERED VIEWS



There are a number of factors that contribute to the appearance of rendered 3D views:

- Select **View> Color**  to toggle between color and grayscale in 3D views. See *Color On/Off on page 129*.
- Select **3D> Rendering Technique** to select a technique to apply to the current view. See *Rendering Techniques on page 785*.
- Select **3D> Lighting> Adjust Lights**  to open the Adjust Lights dialog and edit the light sources in the current plan. See *Adjust Lights Dialog on page 775*.

Several other factors can contribute to the overall quality of a rendered 3D view. See *Rendering Tips on page 770*.

IN VECTOR VIEWS

There are also a number of factors that affect the appearance of 3D Vector Views:

- Select **3D> Toggle Patterns**  in a Technical Illustration or Vector View to turn on or off the display of the “Patterns, 3D Views” layer, which controls the display of material pattern lines. See *Layers on page 123*.
- Select **View> Color**  to toggle between color and black and white to control the display line and fill colors.
- The line style, color, and weight of objects in Vector Views can be specified by layer or, for some objects, individually in their specification dialogs. See *Line Style Panel on page 204*.
- The line weight, color, and style of material patterns are set in the Define Material dialog. See *Define Material Dialog on page 726*.
- Line weights display on screen when **Show Line Weights**  is enabled. See *Line Weights on page 947*.

3D BACKDROPS

A backdrop is an image, usually of an exterior view, that displays in the background of 3D views to help place the model into a realistic setting and add a sense of perspective. If a backdrop is not specified, Home Designer applies a background color. See *3D Backdrops on page 812*.

RENDERING TECHNIQUES

 Any 3D view can be assigned a Rendering Technique for a range of different purposes: from detail drawings to artistic presentation views. Select **3D> Rendering Techniques** to access these tools. See *Rendering Techniques on page 785*.

DELETE 3D SURFACE



The individual surfaces that make up objects can be temporarily removed from any 3D view by selecting **3D> Delete Surface** and then clicking on a surface. When the pointer is over a surface, that surface will become highlighted.

Surfaces removed in one view are removed in all 3D views, but are not permanently removed from the model. Continue clicking surfaces to remove them, then select another tool when you are finished.

Surfaces in 3D views are composed of multiple triangles. Hold the Alt key while clicking to delete one triangular face at a time rather than all triangles forming a surface. See [Edge Smoothing on page 771](#).

To restore the most recently deleted surface, select **3D> Delete Surface**  or click the toolbar button.

There are several ways to restore all deleted surfaces:

- Select **Build> Floor> Rebuild Walls/Floors/Ceilings** .
- Exit the 3D view and reopen it.
- Generate a new 3D view.

Navigating in Camera Views

Once a 3D view is created, there are many ways to manipulate the camera location and the direction of its line of site using the mouse, the keyboard, and the menus.

The Move Camera with Mouse buttons are included on the toolbars in 3D views by default; but, you can add the other tools your toolbars as well as customize their hotkeys. See [Toolbars and Hotkeys on page 89](#).

When the keyboard, toolbar buttons, or menu commands are used to move or rotate a camera, the adjustments occur in regular increments. The size of these increments is specified in the Camera Specification dialog:



- The **Incremental Move Distance** controls Panning movement and forward and backward Dolly movement.
- The **Incremental Rotate Angle** controls Orbit movement, Tilt movement, and side to side Dolly movement.

See [Camera Panel on page 760](#).

Each time you move the camera, the view is updated. If you are using either the toolbar or keyboard to move the camera, you can hold down the Shift key, suppressing the redraw of the view until the Shift key is released and allowing you to move multiple increments more quickly.



Press the Ctrl + Alt + S keys on your keyboard while in a camera view or overview to spin the view. To stop the spinning, press the Esc key.

You can also move a camera to a different floor by clicking the **Up One Floor**  or **Down One Floor**  button while the camera view is active. Note that this may affect what is seen in the view as well as its display in plan view. See [Floor Up / Floor Down on page 508](#).

MOUSE SCROLL WHEEL AND TRACKPAD

3D views can be panned and zoomed when any tool is active using the mouse scroll wheel or trackpad gestures. See [Trackpads on page 14](#).

The program adjusts the speed of these actions depending on characteristics of the camera:

- Zoom speed depends on how close the camera is to the object located behind the mouse pointer. When the target object is far from the camera, zooming is faster; as the camera gets closer to the target, zooming slows.
- Panning speed depends on the length of the camera's Line of Sight. In general, it is likely to be faster in an exterior view of a large model, slower in an interior view of a small room. See [Creating Camera Views on page 741](#).

By default, panning and zooming adjusts the position and direction of the camera. It does not, however, adjust the distances at which surfaces are clipped. This means that if you zoom in closely on an object, some of its surfaces may be removed from the view. One way to avoid this is to lower the camera's **Clip Surfaces Within** value in the Camera Specification dialog. See [Camera Panel on page 760](#).

3DCONNEXION® 3D MICE

3Dconnexion®'s 3D mice can be used to navigate in all views - including camera views and overviews.

In the Windows version of Home Designer, preprogrammed view direction hotkeys are supported on devices with buttons for that purpose. MacOS™ does not provide mapping support to the view direction commands. See [Hotkeys](#).

In Orthographic views, navigation is centered around the camera's focal point; for Perspective views, you can specify whether navigation is centered about the camera or its focal point in the Preferences dialog. See [Render Panel on page 85](#).

For best results when using a 3D mouse, uncheck **Camera Bumps Off Walls**. See [3D View Defaults Dialog on page 739](#).

Rolling is not supported in Home Designer, In addition, 3D mice cannot be used to move the mouse pointer. For details about using your 3D Connexion® mouse, refer to its documentation.

GAMEPADS



In the Windows version of Home Designer, gamepads can be used to navigate in camera views, overviews, and elevation views. To use a gamepad in Home Designer, Select **Tools> Toolbars and Hotkeys> Gamepad Settings**, then check **Enable Gamepad** in the Gamepad Settings dialog. You can also adjust the sensitivity and other aspects of thumbstick functionality when used in Home Designer. See [Gamepad Settings Dialog on page 99](#).





You can also specify whether navigation is centered about the location of the camera or its focal point in the Preferences dialog. See [Render Panel on page 85](#).

 You can add the Gamepad Settings and Toggle 3D Mouse and Gamepad Navigation buttons to your toolbars if you wish. See [To add a button to a toolbar on page 92](#).

MOVE CAMERA WITH MOUSE



An active camera's position can be edited using the mouse. Select **3D> Move Camera With Mouse** to access the Move Camera with Mouse modes, select a mode, and use the left mouse button for the primary behavior or the right mouse button for the secondary behavior. With the exception of Mouse Orbit Camera, which is available in Orthographic Overviews, these tools are not available in Orthographic views.

Tool	Primary Behavior (Left-Click)	Alternate Behavior (Right-Click)
<p>Mouse-Orbit Camera</p> 	<p>Left-click and drag to rotate the camera around its focal point. The camera's position and direction both change.</p> <p>You can temporarily activate Mouse-Tilt Camera by using the right mouse button while the Mouse-Pan Camera or Mouse-Tilt Camera mode is active.</p> <p>To continuously rotate the camera around its focal point, left-click in the 3D view, drag the mouse, and release the mouse button to "throw" the view. Click again in the view to stop it from rotating.</p>	<p>Right-click and drag to tilt the camera instead of orbiting.</p>
	<p>In the Mac version of the software, you can temporarily activate Mouse-Orbit Camera while another tool is active: hold down the Option + Shift keys, then left-click and drag. When the mouse button and keys are released, the previously active tool will again be active.</p>	
<p>Mouse-Pan Camera</p> 	<p>Left-click and drag to move the camera in any direction. The camera's position changes, but its direction does not.</p>	<p>Right-click and drag to orbit instead of panning.</p>
<p>Mouse-Dolly Camera</p> 	<p>Left-click and drag up and down to move the camera forward and backward or drag left or right to rotate the camera side to side.</p>	<p>Right-click and drag to tilt the camera instead of dollying.</p>
<p>Mouse-Tilt Camera</p> 	<p>Left-click and drag in any direction to tilt the camera, changing its view direction but not its position.</p> <p>You can temporarily activate Mouse-Tilt Camera by using the right mouse button while the Mouse-Orbit Camera or Mouse-Dolly Camera mode is active.</p>	<p>Right-click to orbit instead of tilting.</p>
<p>3D Center Camera on Point</p> 	<p>Lets you focus the camera at a particular point in the scene. This changes the camera's direction and focal point, but not its position.</p> <p>To use this tool, activate it and then click on any object in the scene.</p>	<p>N/A</p>

Tool	Primary Behavior (Left-Click)	Alternate Behavior (Right-Click)
3D Focus on Object 	Lets you focus on a specific object by changing the camera's position, direction, focal point, and the length of its line of sight. To use this tool, activate it and then click on an object in the scene. Alternatively, select an object in the view and click the Focus on Selected edit button.	N/A

MOVE CAMERA WITH KEYBOARD

An active camera's position can be changed using the Arrow keys on your keyboard. **Select 3D> Move Camera with Keyboard** to access the Move Camera with Keyboard modes. With the exception of Mouse Orbit Camera, which is available in Orthographic Overviews, these modes are not available in Orthographic views.

These modes use the Incremental Move Distance and Incremental Rotate Angle set in the active 3D view's Camera Specification dialog.

- **Keyboard-Orbit Camera** lets you use the keyboard to rotate the camera around the focal point. The camera's position and direction both change.
- **Keyboard-Pan Camera** lets you move the camera up, down, right, and left using the keyboard. The camera's position changes, but its direction does not.
- **Keyboard-Dolly Camera** lets you move the camera forward and back using the Up and Down Arrow keys, and rotate side to side using the Left and Right keys.
- **Keyboard-Tilt Camera** lets you use the Arrow keys to tilt the camera up, down, or side to side to change the focal point. The camera's direction changes, but its position does not.



MOVE CAMERA TOOLS





Select **3D> Move Camera** in a 3D view to access these tools. These tools change the active camera's position but not its direction, and are not available in Orthographic views.

 The Move Camera Forward and Move Camera Back tools allow you to "walk" up and down stairs when Camera Bumps Off Walls is checked. See [3D View Defaults Dialog on page 739](#).

These tools use the Incremental Move Distance set in the active 3D view's Camera Specification dialog.







	Description
	Move Camera Forward moves the camera and its focal point forward.
	Move Camera Back moves the camera and the focal point back.
	Move Camera Left moves the camera and the focal point to the left in a line perpendicular to the line of sight.

	Description
	Move Camera Right moves the camera and the focal point to the right in a line perpendicular to the line of sight.
	Move Camera Up moves the camera and the focal point up.
	Move Camera Down moves the camera and the focal point down.

ORBIT CAMERA TOOLS

 Select **3D> Orbit Camera** in a 3D view to access these tools. Orbiting the camera rotates it about the focal point using the Incremental Rotate Angle set in the active view’s Camera Specification dialog.

These tools are not available in Cross Section/Elevation, Back Clipped Cross Section, or Wall Elevation Defaults views.



	Description
	Move Camera In moves the camera closer to the focal point along the line of sight. The camera cannot move past the focal point using this tool.
	Move Camera Out moves the camera away from the focal point along the line of sight.
	Orbit Camera Upward rotates the camera up about the focal point. The camera cannot rotate past a vertical line looking straight down on the focal point.
	Orbit Camera Downward rotates the camera down about the focal point. The camera cannot rotate past a vertical line looking straight up at the focal point.
	Orbit Camera Left rotates the camera to the left about the focal point.
	Orbit Camera Right rotates the camera to the right about the focal point.

TILT CAMERA TOOLS

 Select **3D> Tilt Camera** to access these tools. Tilting keeps the camera in one place and pivots the camera about its vertical or horizontal axis. This movement uses the Incremental Rotate Angle set in the active view’s Camera Specification dialog and is similar to tilting your head up and down or turning it side-to-side.







These tools are not available in Orthographic views.

	Description
	Tilt Camera Upward tilts the camera up while keeping it in the same location. The camera cannot tilt beyond the vertical position.

	Description
	Tilt Camera Downward tilts the camera down while keeping it in the same location. The camera cannot tilt beyond the vertical position.
	Turn Camera Left turns the camera to the left while staying in the same location.
	Turn Camera Right turns the camera to the right while staying in the same location.

VIEW DIRECTION TOOLS

 The View Direction Tools allow you to view the model from a specific direction in a camera view or overview. While one of these views is active, select **3D> View Direction** to access these tools.

	Description
	Front View creates a front view of the model.
	Back View creates a back view of the model.
	Top View creates a top view of the model.
	Bottom View creates a bottom view of the model.
	Left Side View create a left side view of the model.
	Right Side View create a right side view of the model.
	Restore Original View restores the original view position.

Editing 3D Views

In addition to its position and direction, there are other ways to modify a 3D view.

If you make changes to an open camera view that was saved previously, you will be prompted to resave the view when you close it.

IN THE SPECIFICATION DIALOG

 You can make adjustments to a camera in the Camera Specification dialog. This dialog is particularly helpful for making fine adjustments to the camera's position, appearance, and other attributes. See *Camera Specification Dialogs* on page 760.

 Tile a 3D view and plan view and use the camera movement tools to see how they affect the camera. See *Tiling Views on page 104*.

USING THE EDIT TOOLS

A camera symbol or symbols selected in plan view can be edited in a variety of ways using the buttons on the Edit Toolbar. See *The Edit Toolbar on page 91*.

USING THE EDIT HANDLES

Return to plan view without closing the 3D view. See *Working in Multiple Views on page 103*.

Using the **Select Objects**  tool, select the camera object. When a camera symbol is selected, it displays four edit handles.

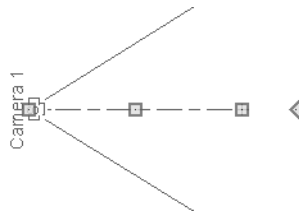

- Drag the **Line of Sight** handle to change the camera angle without moving the focal point.
- Drag the **Move** handle to relocate the camera while maintaining its relative angle.
- Drag the **Focal Point** handle to reposition the focal point and change the line of sight without moving the camera.
- Drag the **Rotate** handle to rotate the camera's line of sight about its center.

The 3D view corresponding to the camera symbol reflects changes made to the symbol in plan view.

Multiple camera symbols can be selected; however, their editing options are limited to being moved, rotated, and deleted.

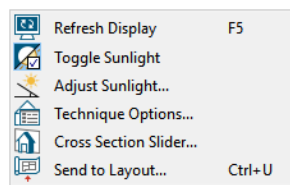

USING THE CONTEXTUAL MENU

In a 3D view, right-click in an empty space in which the backdrop or background color displays to access the contextual menu. See *Contextual Menus on page 18*.



- In Vector Views, the options are a selection of commonly used commands from the File, Edit, Tools and Window menus.
- In the other Rendering Techniques, the options are a selection of tools and toggles specific to the current view.

UP ONE FLOOR/DOWN ONE FLOOR



  You can move a camera to a different floor. While the camera view is active, select **Tools> Floor/Reference Display> Up One Floor** or **Down One Floor**. Note that this may affect what is seen in the view as well as its display in plan view. See *In Plan View on page 747*.

The position and movement of a camera is affected by its location within the model. When the camera is outside a building, its height is relative to the terrain and follows the terrain as it is moved. When inside a building, the camera height is relative to the floor of the room it is drawn in.

If the camera is on an upper floor and you move the camera outside of the building, the camera remains at the same height relative to the floor it was created on.

ZOOMING

 The Zoom Tools are available in all 3D views. See [Zoom Tools on page 106](#).

Selecting **Window> Zoom In** , **Zoom Out**  or **Fill Window**  does not change the camera's location or field of view. Instead, the extents of the view are expanded or cropped.

If you wish, you can instead set the **Zoom**  tools to change the Field of View when used in a 3D view. See [Render Panel on page 85](#).

FIELD OF VIEW

The Field of View refers to a camera's field of vision. A wider field of view makes the focal point appear further away, as more of the image is included in the same view window.

In plan view, the angled lines of a camera symbol indicate its field of view.

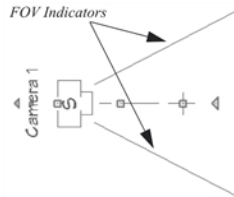

A camera's field of view can be adjusted in the Camera Specification dialog. See [Camera Panel on page 760](#).

Cross Section Slider

 Select **3D> Camera View Options> Cross Section Slider** when a camera view or overview is active to open the Cross Section Slider dialog.

Note: The Cross Section Slider is not available when the Vector View Rendering Technique is used. See [Rendering Techniques on page 785](#).

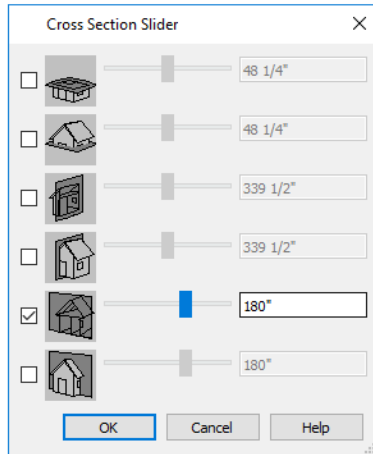

To use the Cross Section Slider

1. Check the box beside a cross section cutting plane to select it and make its Position slider and text box active.
2. Move the Position slider to adjust the position of the cutting plane.
 - The cutting plane Position is measured from the edge of the model that is cut first by the selected cutting plane.
 - Position the Cutting Plane with accuracy using the text field to the right of the slider.
3. Repeat steps 1-3 to use additional cutting planes if you wish.
4. Click **OK** to close the dialog. If the active camera is saved, its Cross Section Slider settings will also be retained. See [Saving 3D Views on page 759](#).

Working in 3D

A variety of tools are available in 3D views that allow you to edit your 3D model as well as annotate it.

ANNOTATING CROSS SECTION/ELEVATION VIEWS



The Text, CAD, and a selection of Dimension tools are available in cross section/elevation views, allowing you to add technical information, call attention to details, and other tasks in these views. See [Detailing Cross Section/Elevation Views on page 745](#).

CREATING OBJECTS IN 3D VIEWS

You can place windows, doors, cabinets, electrical objects, corner trim, and most library objects directly into 3D views. To do this, select the appropriate tool and click in the 3D view. You can then edit the object's size and placement.

When created in 3D, most objects must be placed against a wall, on a floor platform, or within the Terrain Perimeter.

You can also click and drag to draw some CAD-based objects such as custom countertops, roof planes, terrain features and roads in camera views and overviews.

The Build Framing and Build Roof dialogs are also accessible in 3D views, although the manual **Framing Tools**  and **Roof Tools**  are not.

SELECTING AND EDITING OBJECTS IN 3D VIEWS

Most objects can be selected and edited in 3D views. Select **Edit> Select Objects**  and click on the surface of an object to select it. Once selected, objects can be edited using their edit handles, buttons on the Edit Toolbar, and the object's specification dialog. See [Editing Objects on page 136](#).

When you select an object, edit handles and a handle surface display. The handle surface is a rectangle around the perimeter of the object that indicates the overall height and width of the selected surface. The edit handles that display depend on the type of object selected. Walls, for example, display two resize edit handles when selected while the top of a cabinet displays ten handles, allowing you to move, resize and reshape it.

Note: If the wall height of the Exterior Room is adjusted in a 3D view, the default Floor or Ceiling Height of the entire floor is changed. See [Floor and Room Defaults on page 280](#).

All moving or resizing is in the plane of the handle surface. You cannot move an object directly towards or away from the camera, for example, because that surface plane cannot be seen in the view.

By default, object movement is restricted to 1 inch (10 mm) increments, but this restriction can be set to custom increments in the Plan Defaults dialog and toggled off and on by selecting **Edit> Snap Settings> Grid Snaps** . See [Grid Snaps on page 115](#).

Unrestricted positioning can also be enabled by holding down the Ctrl key while moving or resizing an object. See [Unrestricted Movement on page 166](#).

Temporary dimension lines display when many objects are selected to help you resize the object and determine its height. These are sometimes easier to see when the color is toggled off. See [Temporary Dimensions on page 325](#).

Because cross section/elevation views are orthogonal and display objects at their actual dimensions, they are sometimes more suitable for editing objects than camera views or overviews. See [Cross Section/Elevation Views on page 744](#).

When several 3D views are open, changes made in the plan automatically rebuild the model in all views. Because of this, it is typically faster to make changes to your plan with as few windows open as possible.

EDITING MATERIALS IN 3D VIEWS



Select **3D> Materials> Adjust Material Definition**, then click on a surface in the 3D view to open the Define Material dialog for that material. See [Adjust Material Definition on page 719](#).



Select **3D> Material Painter** to apply materials to surfaces in the view using the Material Painter Tools. See [Material Painter Tools on page 713](#).



Select **3D> Material Painter> Material Eyedropper** to apply the material on a surface in the view to other surfaces in the view. See [Material Eyedropper on page 714](#).

CROSS SECTION LINES

Cross Section Lines are created in cross section views to represent any objects split by the cross section line of the camera. They are placed on the “Cross Section Lines” layer, which is locked by default, and they get deleted and replaced whenever the view is redrawn.

When a dimension is drawn to locate an object split by a camera's section line, it actually locates Cross Section Lines. So that dimensions can be retained when Cross Section Lines are regenerated, a **Point Marker**  is automatically created where a dimension meets a Cross Section Line and the dimension locates it instead of the Cross Section Line. See [Point Markers and Dimensions on page 358](#).

Cross Section Lines will print when their layer is turned on; however, they are not included when the view is sent to layout. The Point Markers created when dimensions locate Cross Section Lines, however, will both print and display in views sent to layout. See [Layout on page 924](#).

The “Cross Section Lines” layer can be unlocked, allowing Cross Section Lines to be selected and edited. Additional CAD objects can also be placed on this layer when it is unlocked, as well; however, when the view is redrawn, all CAD objects on this layer will be deleted and replaced with a fresh set of Cross Section Lines.

REBUILD 3D

 As changes are made to your plan, a 3D view automatically updates to reflect any changes visible in the view. If you find that a view is not updating as expected, select **3D> Rebuild 3D** to rebuild the entire 3D model.

Saving and Printing 3D Views

3D camera views, overviews, and cross section/elevation views can be saved with the plan in which they are created, exported and saved as image files, as well as sent to layout and printed.

SAVING 3D VIEWS



 Select **3D> Save Active Camera** to save the current camera in the plan. You can also save a camera view by checking the **Saved** box in the Camera Specification dialog. See [Camera Specification Dialogs on page 760](#).

Saved cameras can be closed and re-opened for later use, and retain their Cross Section Slider, Sunlight, Shadows, and Rendering Technique settings. See [Cross Section Slider on page 756](#), [Adjust Sunlight Dialog on page 783](#), [Shadows on page 770](#), and [Rendering Techniques on page 785](#).

In addition, if CAD or Text objects are drawn in a cross section/elevation view, you will be prompted to save the view when you close it. Any CAD or Text objects added to a cross section/elevation view are saved with the view as part of the plan file.

ACTIVATING SAVED VIEWS

There are several ways to open a saved 3D view:

- Select the camera symbol in plan view and click the **Open View**  edit button.
- Right-click on the camera symbol in plan view and select **Open View**  from the contextual menu.
- Double-click the camera symbol using the **Select Objects**  tool.

Unsaved cameras that are open in another view window can also be activated using the **Open View**  edit button.

If you open a saved camera view and then modify its location or direction using any of the tools available in that view, the program will confirm whether you want to re-save the camera using these new settings when you close it. See [Navigating in Camera Views on page 749](#).

EXPORTING 3D VIEWS

 All 3D views can be exported and saved as .bmp, .jpg, .png, or .tif files. Select **File> Export> Picture** to save the current screen image as an image file. See [To export a picture on page 801](#).

In addition, Vector Views can be exported and saved as .emf files. See [Metafiles on page 804](#).

Once saved, a picture can be opened and converted into many other formats using a graphics program. Picture files can be sent to layout or used in word processing, desktop publishing, and web development programs to create advertisements, brochures, etc.

PLAN BACKUP



When transferring a plan to another computer or to another user, it is helpful to include all the Images, Textures, and Backdrops used in the plan so that rendered views are complete. The **Backup Entire Plan** tool allows you to do so. See [Backup Entire Plan or Project on page 44](#).

PRINTING 3D VIEWS



Since all 3D views other than Vector Views are created using pixels instead of lines, **File> Print> Print Image** must be used when printing. Print Image is a special Home Designer function that prints the screen in picture format. The entire view prints, including images such as plants and textures.

3D views can also be sent to layout and then printed as part of your construction documents.



Select **File> Send to Layout** to send the current view to layout. See [Sending Views to Layout on page 927](#).



Select a saved, inactive camera symbol in plan view and click the **Send Camera's View to Layout** edit button to send the view to layout.

CLOSING 3D VIEWS

Although you can have any number of 3D views open at a time, to conserve resources on your computer it is a good idea to close views when you no longer need them. There are a number of different ways to do this. See [Closing Views and Files on page 108](#).

Camera Specification Dialogs



The Camera Specification dialog can be accessed in plan view by selecting one or more camera symbols and clicking the **Open Object** edit button. See [In Plan View on page 747](#).



This dialog can also be accessed while a camera view or overview is active by selecting **3D> Edit Active Camera**.

The settings in this dialog may vary somewhat depending on the tool used to create the selected view. This tool name is indicated in the dialog's title bar: the specification dialog for a **Full Camera** , for example, is named Full Camera Specification. See [3D View Tools on page 740](#).

The Camera Specification dialog has the following panels:

The settings in this dialog are also found in the Camera Defaults dialogs for each of the various camera tools. See [Camera Defaults Dialogs on page 737](#).

CAMERA PANEL

The CAMERA panel is also found in the Walkthrough Path Specification and Defaults dialogs. See [Walkthrough Path Specification Dialog on page 818](#).

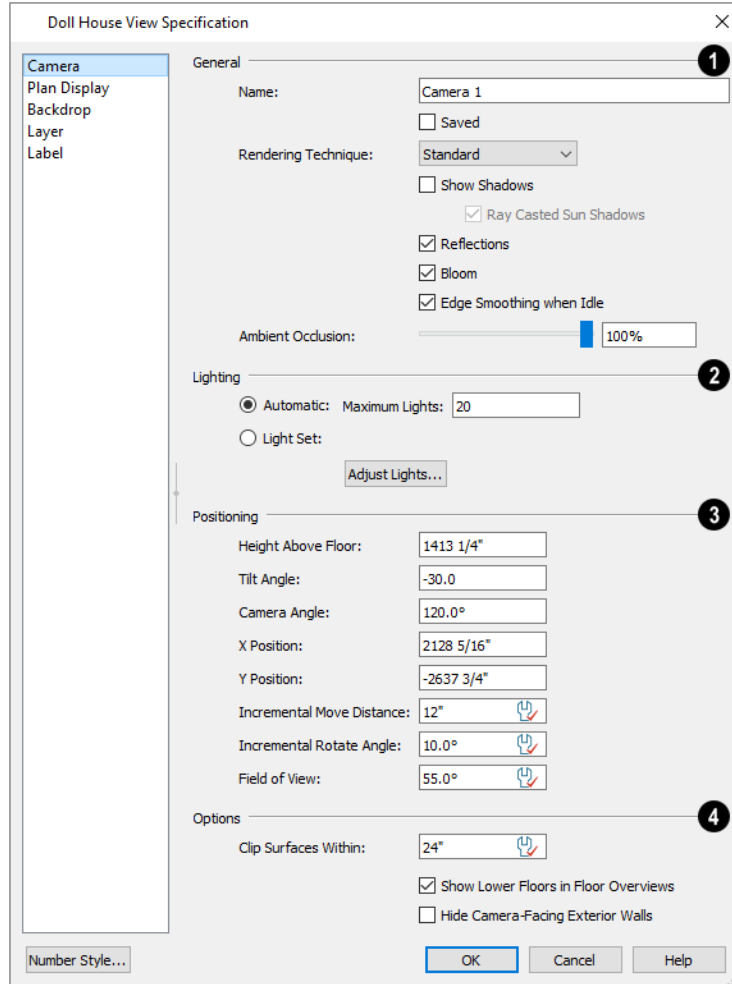

Some settings only affect some types of views. Depending on the type of camera view selected, not all the settings may be available.

1 General

- Specify the **Name** that displays in the camera label in plan view.
- Check **Saved** to save this view with the plan. As soon as you type anything in the text field, this box becomes checked. If you click OK while this box is checked, it will become checked permanently.
- Choose the selected camera or walkthrough path's **Rendering Technique** from the drop-down list. Click the **Define** button to open the Rendering Technique Options dialog. See *Rendering Techniques on page 785*.
- Uncheck **Show Color** to toggle the display off in the current view. See *Color On/Off on page 129*.
- Check **Show Watermark** to turn on the display of the default watermark. See *Watermarks on page 953*.
- Check **Show Shadows** to turn on shadows in the selected camera view. When unchecked, shadows are not generated. See *Shadows on page 770*.
- Check **Ray Casted Sun Shadows** for higher quality shadows cast by sun light. Ray Casted Sun Shadows take longer to generate than regular shadows and only refresh when the camera is not moving.

- Check **Reflections** to turn on reflections in the selected camera view. When unchecked, reflections are not generated. See [Reflections on page 770](#).
- Light **Bloom** occurs around areas of intense illumination and looks as though the light is ‘bleeding’ beyond the edges of the light source. It adds realism to the view but can take longer to render. Only affects Standard and Watercolor renderings. See [Rendering Techniques on page 785](#).
- Check **Edge Smoothing When Idle** to apply high quality edge smoothing to edge and pattern lines when the selected camera is not in motion. See [Edge Smoothing on page 771](#).
- Select the amount of **Ambient Occlusion** in the view using the slider bar or text field. Ambient Occlusion allows variation in the strength of the ambient light. It is more realistic than uniform ambient light, but can take longer to render. Only affects Standard, Watercolor, and Physically Based renderings. See [Ambient Lighting and Occlusion on page 773](#).

2 Lighting

The Lighting settings control which and how many light sources are used in the current view. See [Lighting Modes on page 775](#).

- Select **Automatic**, then specify the **Maximum Number** of lights that can be used in the current camera view.
- Select **Use Light Settings** to use all light sources in the entire plan provided that they are turned **On** .
- Click the **Adjust Lights** button to view a list of the light sources in the plan and modify their settings. See [Adjust Lights Dialog on page 775](#).

3 Positioning

The Positioning settings determine the position and orientation of the camera. See [Navigating in Camera Views on page 749](#).

- The **Height Above Floor** defines the height that the camera is above the floor level for the current floor. See [Camera Height on page 742](#).
- The **Tilt Angle** determines the vertical angle that the camera is tilted. The camera maintains its focal point and position in plan view, but if the camera is tilted, the focal point is above or below the current camera height.
- Specify the selected camera’s **Camera Angle**. This is an absolute value: an angle of 0° points the camera toward the left in plan view.
- Specify the **X Position** and **Y Position** for the selected camera. These are absolute coordinates. Specifying zero for both places the camera at the plan’s origin point (0,0).
- The **Incremental Move Distance** controls how far the camera moves each time you Pan in any direction or Dolly forwards or backward using the keyboard, toolbar buttons, or menu. For interior views a small number is good, but for exterior you may want a larger increment.
- The **Incremental Rotate Angle** defines how many degrees the camera rotates each time you Tilt, Orbit, or Dolly side to side using the keyboard, toolbar buttons, or menu. A setting of 90° would make one full rotation in four moves.
- The **Field of View** defines the camera’s field of vision in angular degrees. See [Field of View on page 756](#).

4 Options

- **Clip Surfaces Within** - Objects located within this distance from the camera do not display in the view. Decrease this value to display objects located close to the camera; increase it to improve the appearance of some surfaces in Overview cameras with very large extents.
- Uncheck **Show Lower Floors** to show only the current floor in the selected Floor Overview. When checked, the current floor plus any floors beneath it are included in the view. Only available for Floor Overviews. See [Doll House View on page 743](#).
- Check **Hide Camera-Facing Exterior Walls** to suppress the display of any exterior walls that face the camera. Interior walls set as Attic walls are also suppressed. This setting only has an effect when the selected camera's position is on the exterior of a structure and also has an associated toggle. See [Hide Camera-Facing Exterior Walls on page 771](#).

PLAN DISPLAY PANEL

The settings on the PLAN DISPLAY panel control the appearance of the selected camera's symbol in plan view. See [In Plan View on page 747](#).

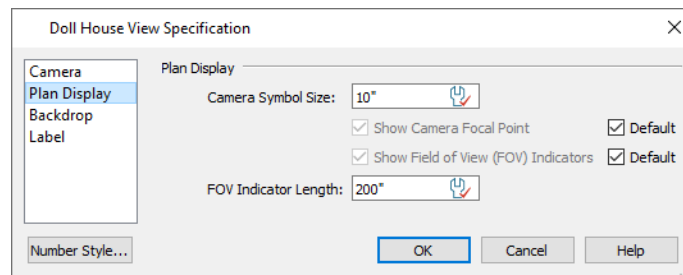

- The **Camera Symbol Size** is measured in plan inches (mm).
- Check **Show Camera Focal Point** to display the camera's focal point in plan view. When unchecked, the camera's line of sight and focal point are hidden until the camera is selected.
- Check **Show Field of View Indicators** to display the camera's field of view indicators in plan view.
- You can also change the **FOV Indicator Length**, which is measured in plan inches (mm).

BACKDROP PANEL

The settings on the Backdrop panel allow you to specify a backdrop image or color to display behind your model in the selected 3D view. See [3D Backdrops on page 812](#).

The BACKDROP panel is also found in the Walkthrough Path Specification and Defaults dialogs. See [Walkthrough Path Specification Dialog on page 818](#).

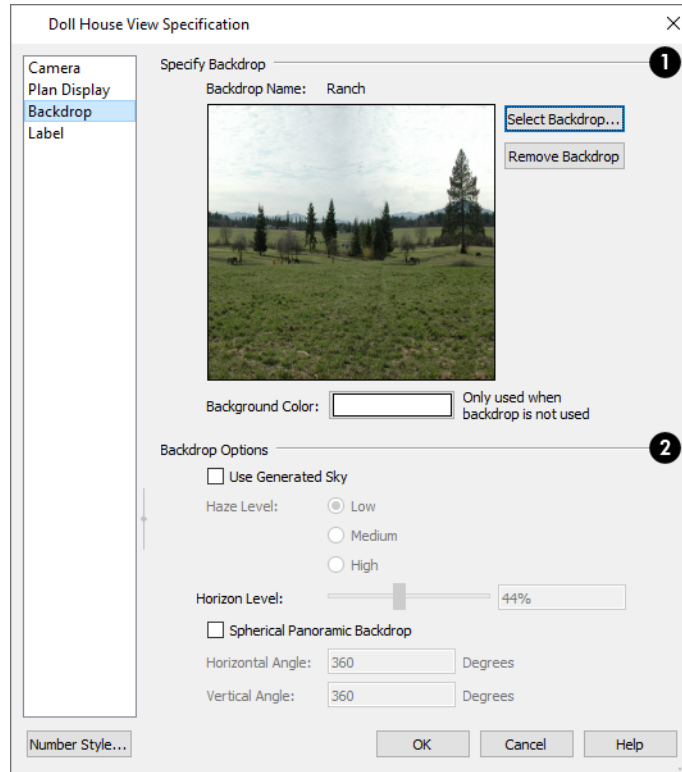

1 Specify Backdrop

A preview of the selected backdrop image is shown here. A backdrop cannot be selected or removed when Use Generated Sky is checked, below.

- **Backdrop Name** - The selected backdrop image's name displays for reference.
- Click **Select Backdrop** to choose a backdrop image from the library. See *Select Library Object Dialog on page 688*.
- Click **Remove Backdrop** to use a solid color instead of a backdrop image in all 3D views, then specify the color below.
- Click the Color bar to select the **Background Color** that displays when a backdrop image is not being used. See *Select Color Dialog on page 134*.

The Background Color for plan views is set in the Preferences dialog. See *Colors Panel on page 62*.

2 Backdrop Options

- Check **Use Generated Sky** to simulate a daytime sky backdrop. When checked, Spherical Panoramic Backdrop will also be checked and a preview of the Generated Sky will display above.

Note: If Use Generated Sky is in use as the backdrop in the current view and Sun Follows Camera is checked, the Generated Sky will not update if the camera is moved.

- Specify a **Haze Level** of **Low**, **Medium**, or **High**. This determines the degree to which light in the sky backdrop appears to be scattered by particles in the air.
- Specify a **Horizon Level** using the text field or slider bar. The default value of 44% works well in most situations.
- Check **Spherical Panoramic Backdrop** to place the selected backdrop onto a sphere that surrounds your model in camera views and overviews.
- The **Horizontal Angle** and **Vertical Angle** settings are the same as those in the Backdrop Specification dialog. If these values are changed here, the backdrop saved in the library will be unaffected. See *Backdrop Specification Dialog on page 813*.

LABEL PANEL

In the Camera Specification dialogs, the settings on the LABEL panel are limited to the **Suppress Label** check box and **Position** and **Orientation** settings.

Camera labels always use the **Camera Name** specified on the CAMERA panel. When callouts are used, the **Callout Label** and **Text Below Line** are specified on the PLAN DISPLAY panel.

For information about this panel, see *Label Panel on page 363*.

Cross Section/Elevation Specification Dialogs



The Cross Section/Elevation Specification dialogs can be accessed in plan view by selecting one or more cross section/elevation camera symbols and clicking the **Open Object** edit button. See *In Plan View on page 747*.



This dialog can also be accessed while a cross section/elevation camera view is active by selecting **3D> Edit Active Camera**.

The Cross Section/Elevation dialog has the following panels:

Most of the settings in this dialog are also found in the Cross Section/Elevation, Back Clipped Cross Section, and Wall Elevation Defaults dialogs. See *Camera Defaults Dialogs on page 737*.

CAMERA PANEL

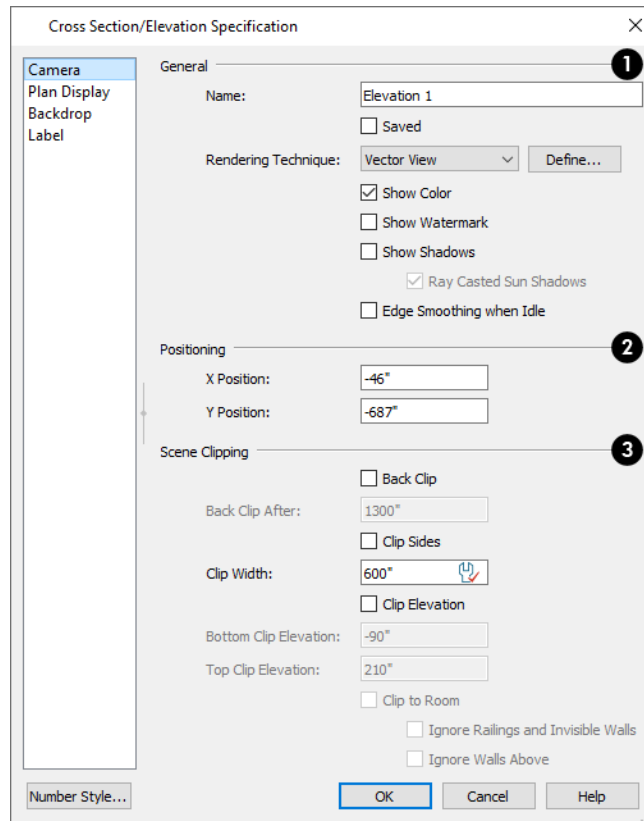

1 General

- The **Camera Name** displays in plan view.
- Check **Saved** to save this view with the plan. As soon as you type anything in the text field, this box becomes checked. If you click OK while this box is checked, it will become checked permanently.
- Choose the selected camera's **Rendering Technique** from the drop-down list. Click the **Define** button to open the Rendering Technique Options dialog. See [Rendering Techniques on page 785](#).
- Uncheck **Show Color** to toggle the display off in the current view. See [Color On/Off on page 129](#).
- Check **Show Watermark** to turn on the display of the default watermark. See [Watermarks on page 953](#).
- Check **Show Shadows** to turn on shadows in the selected camera view. When unchecked, shadows are not generated. See [Shadows on page 770](#).
- Check **Ray Casted Sun Shadows** for higher quality shadows cast by sun light. Ray Casted Sun Shadows take longer to generate than regular shadows and only refresh when the camera is not moving.
- Check **Edge Smoothing When Idle** to apply high quality smoothing to edge and pattern lines when the camera is not in motion. See [Edge Smoothing on page 771](#).

2 Positioning

These settings control the position of the camera and are not available in any of the Defaults dialogs. See [3D Drafting on page 11](#).

- Specify the **X Position** of the camera in absolute coordinates.
- Specify the **Y Position** of the camera in absolute coordinates.

3 Scene Clipping

These settings control the extents of the camera view. Only the Ignore Railings and Invisible Walls setting is available in the Wall Elevation Defaults dialog. See [Clipped Section Views on page 745](#).

- Check **Back Clip After** to include only the objects or portions of objects located between the start and end points of the camera's Line of Sight in the view. This box is checked by default for Back Clipped Cross Section views and is not available in any of the Defaults dialog.
- Specify the **Back Clip After** distance, which is the length of the camera's Line of Sight from the Cross Section Line at its start to the Back Clip Line at its end. This text field reports the length of the camera's Line of Sight even when Back Clip is unchecked above, and is not available in any of the Defaults dialogs.
- Check **Clip Sides** to limit the selected view's side-to-side extents to the Clip Width specified below. When unchecked, the full width of the model is included in the view.
- Specify the **Clip Width**, which is the width of the camera's side-to-side extents. This value also affects the length of the camera's Cross Section Line when its symbol is selected in plan view. When Clip Sides is checked, the Cross Section Line has end edit handles that adjust this value when they are dragged. See [Editing 3D Views on page 754](#).
- Check **Clip Elevation** to limit the selected view's vertical extents to the elevation values below. When unchecked, the full height of the model is included in the view.
- Specify the **Bottom Clip Elevation**, which is the bottommost extent of the view. Objects or parts of objects located below this elevation are not included in the view. When Clip Sides is checked and the bottom clipping plane has been edited, this value refers to the end point with the higher elevation.
- Specify the **Top Clip Elevation**, which is the topmost extent of the view. Objects or parts of objects located above this elevation are not included in the view. When Clip Sides is checked and the top clipping plane has been edited, this value refers to the end point with the lower elevation.
- Check **Clip to Room** to confine the extents of the current view to the room that the camera is located in. The view's clip values are reported above for reference. This box is checked by default for Wall Elevation views, is only available when the selected camera is located inside of a room, and is not available in any of the Defaults dialogs.

When **Clip to Room** is checked, two additional options are available:

- Check **Ignore Railings and Invisible Walls** to ignore the room definition created by these types of walls in a selected Wall Elevation view. When this is unchecked, Wall Elevation views only recognize room definition created by regular walls. See [Cross Section/Elevation Views on page 744](#).
- Check **Ignore Walls Above** to prevent any walls located above the selected camera's room from displaying in the view. This option typically has an effect only when the camera's room has Flat Ceiling Over This Room unchecked, or the room above has Floor Under This Room unchecked, in the Room Specification dialog. See [Structure Panel on page 302](#).

PLAN DISPLAY PANEL

The settings on the PLAN DISPLAY panel control the appearance of the selected camera in plan view. See *In Plan View on page 747*.

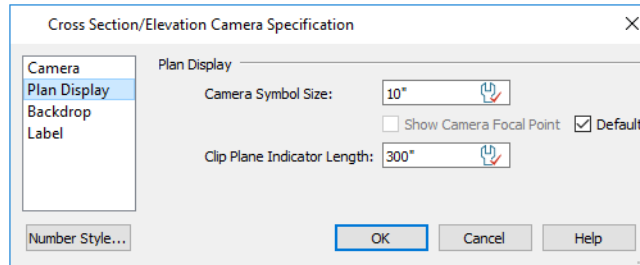

Plan Display

These settings allow you to specify the appearance of the selected camera's symbol. See *Dynamic Defaults on page 55*.

- Uncheck **Default** beside any of these options to modify it.
- The **Camera Symbol Size** is measured in plan inches (mm).
- Check **Show Camera Focal Point** to display the camera's focal point in plan view. When unchecked, the camera's line of sight, focal point, and clip plane indicators are hidden until the camera is selected.
- Specify the **Clip Plane Indicator Length** in plan inches (mm). See *To create a cross section/elevation view on page 744*.

BACKDROP PANEL

The settings on the BACKDROP panel allow you to specify a backdrop image or color to display behind your model in the selected 3D view. See *Backdrop Panel on page 763*.

LABEL PANEL

In the Cross Section/Elevation Camera Specification dialog, the settings on the LABEL panel are limited to the **Suppress Label** check box and **Position** and **Orientation** settings.

Camera labels always use the **Camera Name** specified on the CAMERA panel. When callouts are used, the **Callout Label** and **Text Below Line** are specified on the Plan Display panel.

For information about this panel, see *Label Panel on page 363*.

3D Rendering

Chapter 31

There are a variety of tools available to create 3D views of a model: simply click a button to create an overview, or click and drag to create a camera or cross section/elevation view. See *3D Views on page 735*.

To improve the quality of the rendering and create a custom look, you can adjust lighting, edit the materials used in the plan, choose from several rendering techniques, and fine-tune 3D view quality settings.

TOPICS

Rendering Tips	770
Lighting	772
Light Types	773
Displaying Lights	774
Lighting Modes	775
Light Specification Dialog	777
Sun Angles and Shadows	778
Sun Angle Specification Dialog	781
Adjust Sunlight Dialog	783
Rendering Techniques	785
Rendering Technique Options	787

Rendering Tips

There are a variety of factors which affect the appearance and quality of rendered 3D views. You can use these tools and settings to achieve renderings that meet your needs.

LIGHTING

Lighting is extremely important in most 3D renderings. Lighting controls the visibility of objects in a view, affects the appearance of surfaces, and influences the appearances of colors and textures on those surfaces. Even small changes to light intensity, direction and color can have a large impact on image quality. See [Lighting on page 772](#).

SHADOWS



Like lighting, shadows have an important effect on image quality. Shadows can be generated in any type of camera view using any Rendering Technique aside from Glass House. See [Rendering Techniques on page 785](#).

When shadows are enabled and the sun is shining directly at a window, its light can shine through the window and into an interior room. These shadows use **Ray Casted Sun Shadows** by default, but this option can be unchecked if it slows performance in 3D views. See [Generic Sunlight on page 773](#).

Shadows are enabled in Full Camera views by default. You can, however, check or uncheck **Show Shadows** and **Ray Casted Sun Shadows** in the defaults dialog for any camera tool or in the specification dialog for any camera view. In addition, you can select **3D> Camera View Options> Toggle Shadows**  in any camera view. See [Camera Panel on page 760](#).

Shadows are affected by the number of light sources in a plan, as well as what Rendering Technique is in use. In order for a light source to cast shadows, it must be **On** in the current view and have **Cast Shadows** checked in its specification dialog. See [Light Data Panel on page 478](#).

In addition to their appearance in camera views, sun shadows can also display in plan view to represent the shadows created by the sun at a particular date, time, and location. See [Sun Shadows on page 780](#).

REFLECTIONS



Reflections are another aspect of lighting that can increase a 3D view's realism. When a flat surface is assigned a Mirror material, it can display the reflections of other objects in the scene. Bear in mind that a Mirror surface cannot display the reflection of another mirror: when one mirror can be seen in another, its material is shown rather than a reflection.

Reflections in Mirrors only generate in Perspective 3D views using Rendering Techniques that show material textures. In some situations, they can slow down 3D view generation and responsiveness. See [Rendering Techniques on page 785](#).

When the **Physically Based**  Rendering Technique is in use, reflections on non-mirror surfaces are modeled, as well. See [Physically Based on page 786](#).

Reflections in Mirrors can be toggled on or off in a camera view by selecting **3D> Camera View Options> Toggle Reflections**  as well as in the Camera Specification dialog.

MATERIAL DEFINITIONS

Textures are graphic files that represent contoured surfaces of objects such as carpet, bricks, tile, and wood in rendered views. Textures are assigned to materials which in turn are assigned to objects. See [Patterns and Textures on page 712](#).

The display of materials in rendered views is controlled by settings on the TEXTURE and PROPERTIES panels of the Define Material dialog. See [Define Material Dialog on page 726](#).

For realistic rendered views, it is sometimes helpful to make adjustments to texture properties so that they map to surfaces correctly. See [Mapping Patterns and Textures on page 722](#).

Brightness, shininess and transparency control how light sources affect the display of surfaces in rendered views. See [Lighting on page 772](#).

If no texture is selected for a material or if the display of textures is turned off, affected surfaces are a solid color instead.

IMAGES

Image objects use picture files to represent individual objects such as trees, flowers, and vehicles in 3D views. Images are useful because they have only one 3D surface, allowing them to represent complicated 3D objects with a high degree of realism but with minimal cost in terms of performance. See [Placing Images on page 795](#).

BACKDROPS

A backdrop is an image, usually of an exterior view, that displays in the background of 3D views to help place the model into a realistic setting and add a sense of perspective. If a backdrop is not specified, Home Designer applies a background color. See [3D Backdrops on page 812](#).

EDGE SMOOTHING



Angled surface edges and pattern lines will sometimes display on screen as jagged or stair-stepped. Edge Smoothing softens this effect, producing cleaner looking lines.

You can specify how much Hardware Edge Smoothing occurs in 3D views in the Preferences dialog. Hardware Edge Smoothing is set to "High" by default. Using a lower setting will lower rendering quality but may improve performance on some systems. See [Render Panel on page 85](#).

Even higher quality Edge Smoothing can be produced by checking **Edge Smoothing When Idle** in the Camera Specification dialog. This setting does not affect a camera while its position or orientation are being changed, but applies additional smoothing to edge and pattern lines when the camera is not in motion. See [Camera Panel on page 760](#).

This high quality Edge Smoothing option is view-specific and can also be toggled on or off by selecting **3D> Camera View Options> Toggle Edge Smoothing When Idle** .

HIDE CAMERA-FACING EXTERIOR WALLS



Occasionally, it can be very helpful to view the interior of a structure from an exterior view. To achieve this, create an exterior camera view or overview and select **3D> Camera View Options> Hide Camera-Facing Exterior Walls**. This option is view-specific and can also be set in the Camera Specification dialog. See [Camera Panel on page 760](#).

Hide Camera-Facing Exterior Walls is also an option for Walkthrough Paths. See [Walkthrough Options Dialog on page 824](#).

Lighting

Lighting controls the visibility of objects in 3D views, affects the appearance of surfaces, and influences the appearances of colors and textures on those surfaces.

Each individual light source has a set of properties, such as intensity and color, that can be defined. See [Light Data Panel on page 478](#).

By default, a maximum of eight lights can display in a given camera view or overview. If more than eight are present, those with the highest intensity located in the same room as the camera are rendered. Lights in adjacent rooms may also be rendered, with the highest intensity lights rendered first.

- You can specify a different Maximum Lights number in the Camera Specification dialog. See [Camera Panel on page 760](#).
- You can also manually turn on and off individual lights in order to get the desired lighting effects. See [Displaying Lights on page 774](#).

When the camera is outside a building, the program normally uses sunlight for lighting calculations and turns off all other light sources. You can turn the sunlight off and use all the other exterior lights to simulate nighttime views.

There are five types of light sources in Standard rendered views:

DEFAULT INTERIOR LIGHTS

If you create a Standard interior camera in a room where no lights have been placed, the program creates a Default Light source within that room. The Default interior light acts like a central point light source but cannot be selected or edited.

Because the Default Light cannot be adjusted, if you want to control the light in an interior rendered view, you must add lights to the rooms in your plan by placing light fixtures and Added Lights.

LIGHT FIXTURES

An electric symbol that represents a Light Fixture can have one or more light sources associated with it. Properties for each light source such as light type, color, and intensity can be modified in the fixture's specification dialog. See [Electrical Service Specification Dialog on page 476](#).

If the light source is a Point or Spot Light, you can also adjust its Offset, or position relative to the fixture. If you choose to **Show Position in Camera View**, you can see where the light source is located.

Light sources look most realistic when they are offset from a surface.

ADDED LIGHTS



In plan view, select **3D> Lighting> Add Lights** to quickly add a light source to a plan. Added Lights and their labels are placed on the "Light Sources" and "Light Sources, Labels" layers.

Added lights only act as light sources in plan files that have at least one room defined. They display 2D symbols in plan view but do not display as objects in 3D views.

While Added Lights do not display as objects in 3D, you can specify that an Added Light's position be represented by a crosshairs in rendered views that use lighting. See [Light Data Panel on page 478](#).

Added lights can be placed into objects that normally do not generate light, such as a TV.

There are two types of added light sources: Point Lights and Spot Lights. See [Light Types on page 773](#).

GENERIC SUNLIGHT

When you create a rendered view and no Sun Angle exists, the program creates a Generic Sun light source.

The Generic Sun's default intensity, color, and angle can be set in the Generic Sun Defaults dialog, and can be modified in the Adjust Sunlight dialog. In addition, you can specify that it follow the camera in 3D views so surfaces are always illuminated. The Generic Sun's settings are view specific: each 3D view can have its own, unique settings. See [Adjust Sunlight Dialog on page 783](#).

When standard shadows are enabled, sunlight can shine through windows into interior rooms. See [Shadows on page 770](#).



If you place a **Sun Angle**  in plan view, the Generic Sun is no longer used as a light source in rendered views. Instead, sunlight is generated based on specific date, time, latitude, and longitude information. See [Sun Angles and Shadows on page 778](#).

You can specify that a particular Sun Angle or the Generic Sun be used in any active camera view in the Adjust Sunlight dialog. See [Adjust Sunlight Dialog on page 783](#).

AMBIENT LIGHTING AND OCCLUSION

Ambient lighting simulates the way light bounces around a scene, producing a basic level of uniform illumination on all surfaces. It is used in camera views and overviews using the Standard, and Watercolor Rendering Techniques.

There are three types of ambient light in Home Designer:

- **Interior Ambient** controls the ambient light in interior views.
- **Daytime Ambient** controls the ambient light in exterior views when **Toggle Sunlight**  is on. See [Sun Angles and Shadows on page 778](#).
- **Nighttime Ambient** controls the ambient light in exterior rendered views when **Toggle Sunlight**  is off.

You can control the brightness of each in the Rendering Technique Options dialog. See [Standard Panel on page 788](#).

Ambient occlusion adds shading to surfaces near corners which, because of their location, reflect less light compared to other surfaces. Too little ambient occlusion can result in a view having a flat appearance. You can specify the amount of **Ambient Occlusion** to use in Standard, Watercolor, and Physically Based renderings in the Camera Specification dialogs. See [Camera Panel on page 760](#).

Light Types

There are two types of light source, each of which generates light in a different way and allows you to create a variety of lighting effects:

- Point Light sources
- Spot Light sources

Any light source except a Sun Angle can be specified as a Point or Spot Light in the Electrical Service Specification dialog. See [Light Data Panel on page 478](#).

 In addition to being assigned to light fixtures, these two types of light sources can be placed in a plan as **Added Lights**, which are light sources that are not associated with a fixture. As with light fixtures, the lighting properties of Added Lights can be specified in their specification dialog. See [Light Specification Dialog on page 777](#).

POINT LIGHTS

Like a bare light bulb, a Point Light radiates light equally in all directions from its origin. Point lights are a realistic representation of non-directional electric lighting.

If no user defined light exists, Home Designer creates a Point Light source to represent a light within a room.

To create a Point Light source

1. In plan view, select **3D> Lighting> Add Lights** .
2. Click in plan view. Do not drag the pointer when you click the screen, or you will create a Spot Light.

SPOT LIGHTS

A Spot Light focuses the light in a specified direction. The Tilt and Direction Angles can be specified in a Spot Light's specification dialog.

To create a Spot Light source

1. In plan view, select **3D> Lighting> Add Lights** .
2. Click and drag in plan view no more than two plan feet (600 mm) in any direction.
3. As you drag, the light preview will look like a Spot Light icon.
4. When you release the mouse, a Spot Light pointing in the direction that you dragged is created.

You can also use a Spot Light's edit handles in plan view to move it, as well as change its direction and Cut Off Angle.

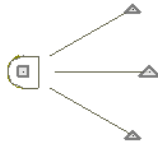

Displaying Lights



The display of light fixtures and Added Lights in floor plan and 3D views is controlled in the Layer Display Options dialog. Light fixtures are placed on the “Electrical” layer, and Added Lights, on the “Light Sources” layer. See [Layer Display Options Dialog on page 126](#).

In addition, they can serve as sources of light in rendered 3D views. They can be turned on and off, as well as set to cast shadows.

IN PLAN VIEW



In plan view, both light fixtures and Added Lights can display labels when the “Electrical, Labels” and/or “Light Sources, Labels” layers are turned on. See [Label Panel on page 363](#).

IN 3D VIEWS

Light fixtures and Added Lights can serve as sources of light in rendered views.

To turn a light on or off

There are several ways to turn a light fixture or Added Light on or off:

- Select one or more fixtures or Added Lights and click the **Turn Light(s) Off in 3D**  or **Turn Light(s) On in 3D**  edit button.
- Uncheck **On** in the object's specification dialog. See [Light Data Panel on page 478](#).
- Clear the **On/Off** check box in the Adjust Lights dialog. See [Adjust Lights Dialog on page 775](#).

Added Lights are not associated with a 3D fixture, but you can specify that any light source's location be represented in 3D views using crosshairs. See [Light Data Panel on page 478](#).

Light source position indicators will only display when the light is in use in the current 3D view. That is, it must be:

- Turned on.
- In-use in the current view.
- Either located in a room or in an exterior view with Sunlight toggled off.

Sunlight will shine through windows into interior rooms when shadows are enabled. See [Shadows on page 770](#).

Lighting Modes

By default, cameras use an Automatic Lighting Mode that allows a set number of lights to illuminate the view. This number can be specified in the Camera Specification and Adjust Lights dialogs. See [Camera Panel on page 760](#).

If more than the set number of lights are present, lights are prioritized in this order:

- Lights in the same room as the camera before those in different rooms.
- Higher intensity lights before lower intensity lights.
- Lights closer to the camera before those further away.
- Regardless of their intensity or proximity to the camera, lights on floors above the camera are not used in Floor Overviews. See [3D View Tools on page 740](#).

The Automatic Lighting Mode is useful because it is an easy way to produce reasonable lighting without taxing your video memory.

An alternative to the Automatic Lighting Mode is the **Use Light Settings** option. When **Use Light Settings** is selected, all lights in the current plan that are turned On are used in 3D views. This gives you control over which lights are used as light sources but may require more resources on your system.

ADJUST LIGHTS DIALOG

 Light fixtures and Added Lights in the current plan are listed and can be edited in the Adjust Lights dialog. Select **3D> Lighting> Adjust Lights** to open this dialog in floor plan or any 3D view. You can also open it by clicking the **Adjust Lights** button in the Camera Specification dialog. See [Camera Panel on page 760](#).

The Adjust Lights dialog is an efficient way to control which lights are turned on in 3D views.

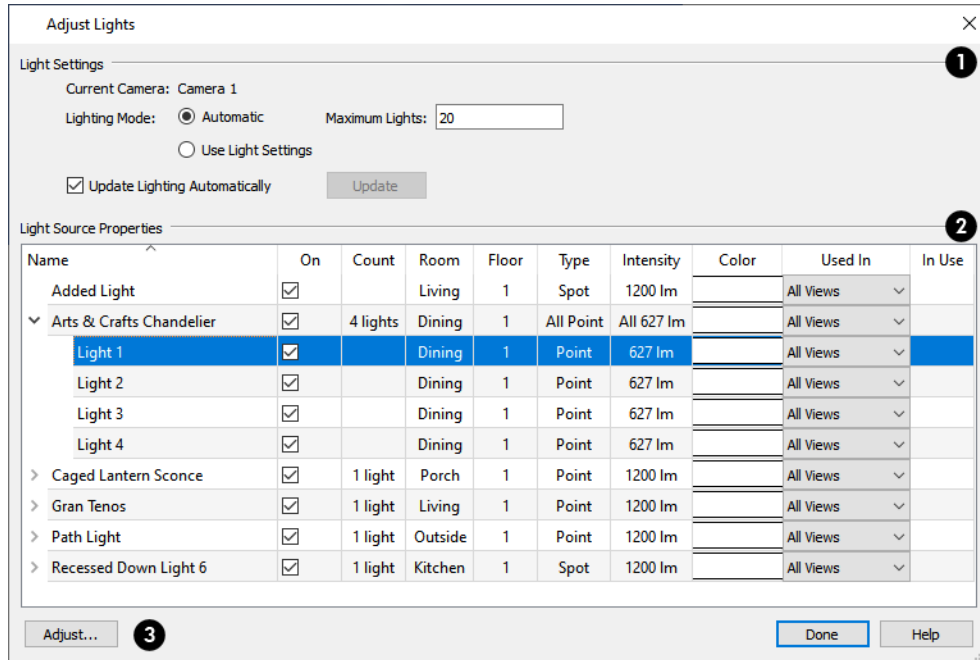

1 Light Settings

When the dialog is opened while a camera view is active, these settings are available:

- The name of the **Current Camera** is stated here for reference.
- Specify the desired **Lighting Mode**. **Automatic** uses the specified **Maximum Lights** while **Use Light Settings** uses the lights as specified below.

In some circumstances, performance in the Adjust Lights dialog can be slow when opened from a camera view.

- To avoid this, uncheck **Update Lighting Automatically**.
- When Update Lighting Automatically is checked, you can click the **Update** button to update the lights in the camera view.

2 Light Source Properties

All lights in the current plan are listed here using the same **Names** as their labels.

- If a line item is a light fixture, it will have an arrow to the left of its name. Click this arrow to show the fixture's light sources as individual line items.
- Check the box in the **On** column to turn it on or uncheck the box to turn it off. If a fixture has multiple light sources and only some are on, a solid square will display in its check box.
- The **Count** column lists the number of light sources assigned to each light fixture. This column is empty for Added Lights.
- The **Room** column states the location of each light. If a light is not in a room, "Outside" will be reported.
- The **Floor** column states the floor level that each light is on.
- The **Type** column states the type of light source used by each light. See *Light Types on page 773*.
- The **Intensity** column states the strength of each light.

- The **Color** column displays the light’s color. Click the button to choose a different color if you wish.
- The **In Use** column states whether each light is emitting light in the Current Camera view. If a fixture has multiple light sources and only some are in use, a blue box will display in its row.

3 Adjust

To adjust the properties of a light in the list, double-click on its name or select it and click the **Adjust** button. Make changes to the light in its specification dialog and click OK. For more information, see [Light Specification Dialog on page 777](#) or [Electrical Service Specification Dialog on page 476](#).

Multiple lights can be selected by holding down the Shift key. If multiple lights are selected, clicking the Adjust button opens the Light Data dialog, which is similar to the LIGHT DATA panel of a single object’s specification dialog.

If you are in a 3D view that displays lighting, the view will regenerate based on the new light settings.

The Generic Sun and Sun Angles are not listed in this dialog. See [Generic Sunlight on page 773](#).

Light Specification Dialog

Select one or more Point or Spot Lights and click the **Open Object** edit button to open the Light Specification dialog.

You can also select **3D> Lighting> Adjust Lights**  to access a list of the light sources present in the current plan and open the specification dialog for any of them. See [Adjust Lights Dialog on page 775](#).

LOCATION PANEL

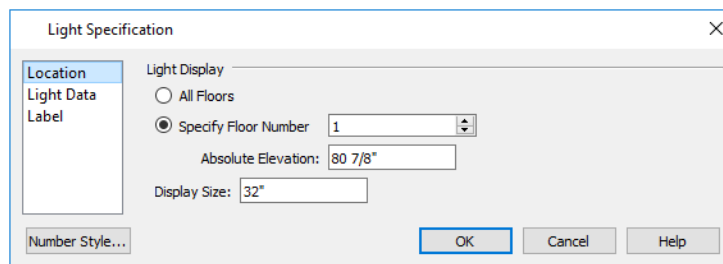

Light Display

Specify where the selected Added Light displays in plan and 3D views.

- Select **All Floors** to display the selected light on all floors in plan view. See [Multiple Floors on page 501](#).
- Select **Specify Floor Number** to display the light on one floor only, then choose a floor number from the drop-down list.

Note: The floor or floors that an Added Light displays on in plan view is totally independent of where it displays in 3D.

- Specify the selected light’s **Absolute Elevation**, measured relative to 0, which is the default height of Floor 1.
- Specify the **Display Size**, which is the diameter of the circle representing the Added Light in plan view.

LIGHT DATA PANEL

The settings on this panel are also found on the same panel of the Electrical Service Specification dialog. See [Light Data Panel on page 478](#).

Depending on the type of light selected, the options available here may vary.

LABEL PANEL

Labels for Added Lights display in plan view when the “Light Sources, Labels” layer is turned on and use the Text Style assigned to that layer. See [Text Styles on page 360](#).

For information about the settings on this panel, see [Label Panel on page 363](#).

Sun Angles and Shadows

In addition to the functional and aesthetic properties of ambient light and light sources in rendered views, the direction and angle of the sun’s light and shadows are an important consideration. Two tools allow you to generate sunlight and sun shadows with accuracy:



North Pointers allow you to specify the direction of true north in a plan.



Sun Angles let you specify an exact location, date, and time for sunlight and sun shadow generation.

NORTH POINTER

The North Pointer tool is used to define the direction of true north in a plan. The direction of north does not affect the orientation of the Snap and Reference grids, but it does affect the direction of sunlight and sun shadows, how conditioned area totals are calculated, and how bearing information is interpreted by the program.



Every bearing is defined relative to North, so it is best to establish this direction before entering survey information for a site plan.

If a North Pointer is not used, north is assumed to be straight up on screen in plan view.

Select **CAD> Lines> North Pointer** , then click and drag to draw the pointer, starting at the tail and dragging toward the point. Once it is drawn, you can define its exact length and angle in its specification dialog. See [Line Specification Dialog on page 202](#).

Multiple North Pointers can be drawn in a given plan file, and will always point in the same direction automatically. If you rotate one of them, the others will automatically rotate to match. Similarly, if you draw a new North Pointer at a different angle, existing North Pointers will rotate to that angle automatically.

If you choose to display line angles when a North Pointer exists, be sure to select the appropriate format in the CAD Defaults dialog. See [CAD Defaults and Preferences on page 193](#).

- If angles are set to **Bearings**, they are relative to the North Pointer.

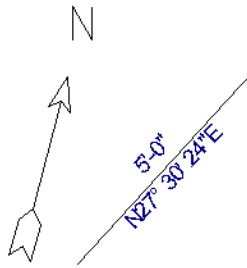

- If angles are set to show as **Degrees**, the angle relates to 0° (horizontal to the right) even if a North Pointer is present.

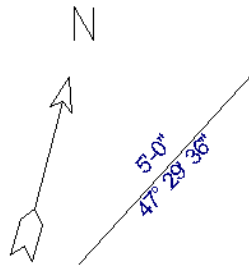

A North Pointer can be selected and edited using its edit handles and Edit Toolbar buttons. All attributes of the N aside from its size are drawn from the Text Style assigned to the “CAD, Default” layer. For more information, see [Editing Line-Based Objects on page 145](#).

SUN ANGLES

Sun Angles let you establish exactly where your plan’s building site is located, and a precise date and time. This information allows the program to determine the sun’s location in the sky and generate sunlight and sun shadows with accuracy.

Note: Sun Angle calculations do not adjust for elevation. They are based on formulas published by the United States Naval Observatory and have limited accuracy as documented by the USNO.

When an exterior 3D view is rendered, the program looks for an active Sun Angle. If it finds none, the Generic Sun is used. See [Generic Sunlight on page 773](#).

To create a Sun Angle

1. In plan view, go to Floor 1 or Floor 0. Sun Angles can only be created on these floor levels. See [Multiple Floors on page 501](#).
2. Select **CAD> Lines> Sun Angle**  and click in the drawing area to place a Sun Angle arrow at that location.
3. In the Sun Angle Specification dialog, specify the Sun Angle’s Earth Data and other information. See [Sun Angle Specification Dialog on page 781](#).
4. After it is created, a Sun Angle cannot be rotated; but it can be moved as well as resized using its edit handles. Shadows are not affected.

Multiple Sun Angles can be created, each with different specifications; however, only one can be used as a light source in a given 3D view. If more than one Sun Angle is present, specify the one to use in the current view in the Adjust Sunlight dialog. See [Adjust Sunlight Dialog on page 783](#).

Sun Angles can display their date and time in plan view and can also produce sun shadow polylines in plan view. Both Sun Angles and their shadows are on the “Sun Angles & Shadows” layer.

SUN SHADOWS

Sun Angles allow the program to produce shadows cast by a building that reflect the exact position of the sun in the sky in a particular location and at a specific date and time. This position and time information is specified in the Sun Angle Specification dialog; the date format is derived from your operating system settings. See [Earth Data Panel on page 781](#) and [Region and Language Settings on page 55](#).

In plan view, sun shadows are represented by polylines filled with a hatch pattern. If a Terrain Perimeter is present, the shape of a sun shadow polyline is affected by changes in terrain height. If no Terrain Perimeter exists, sun shadows fall on an imaginary plane at a height of zero, the default height for Floor 1. Sun shadows rebuild whenever the terrain is rebuilt. See [Build Terrain on page 848](#).

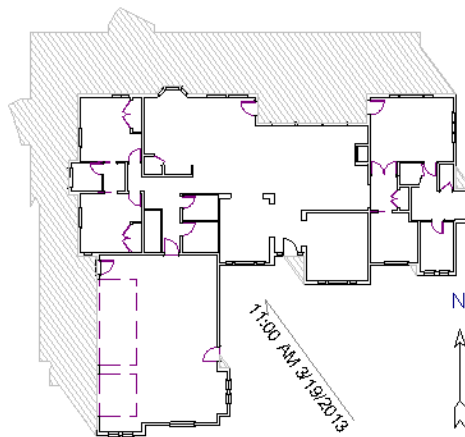

No sun shadow generates if the sun is below the horizon or if it is so low on the horizon that the shadow would be extremely long.

Multiple Sun Angles can be placed in the same plan to allow the simultaneous display of shadows cast at different times in plan view. Only one should be turned on in 3D views at any given time, however.

	<p>Specify different line colors and/or styles for shadows cast by multiple Sun Angles on the Line Style and Fill Style panels of the Sun Angle Specification dialog.</p>
---	---

To generate the sun shadows associated with a particular Sun Angle, select it and click the **Make Shadow**  edit button or click the **Make Shadow** button in the Sun Angle Specification dialog. See [Lighting Data Panel on page 782](#).

There are several ways to delete a sun shadow polyline:

- In plan view, select and delete the defining polyline.
- In plan view, select and delete the Sun Angle arrow.
- In plan view, select the Sun Angle arrow and click the **Delete Shadow**  edit button.
- In the Sun Angle Specification dialog, click the **Delete Shadow** button. See [Earth Data Panel on page 781](#).
- In the Sun Angle Specification dialog, click the **Make Shadow** button to delete existing shadows and create new ones.

Sun Angle Specification Dialog



Select **CAD> Lines> Sun Angle**, then click in plan view to open the Sun Angle Specification dialog and create a new Sun Angle. See [Sun Angles and Shadows on page 778](#).

To open the Sun Angle Specification dialog for an existing Sun Angle, select it and click the **Open Object** edit button. This dialog can also be accessed by clicking the **Edit** button in Adjust Sunlight dialog. See [Adjust Sunlight Dialog on page 783](#).

EARTH DATA PANEL

The settings on the EARTH DATA panel let you establish exactly where your plan's building site is located, and exactly when the sun's light should be calculated. This information allows the program to generate sunlight and sun shadows with accuracy.

1 Solar Angles

The Solar Angles display for reference and may update as changes are made to the settings on this panel.

- The **Solar Altitude** is the angle of the sun above the horizontal plane, in degrees.
- The **Solar Direction** is the angle between true North and the sun's direction. This is the angle the Sun Angle arrow points in plan view relative to the direction of North. See [North Pointer on page 778](#).

2 Location

Specify the Location of the selected Sun Angle. The initial location can be set in the Preferences dialog. See [CAD Panel on page 74](#).

- Specify the **Latitude**, which is measured either **North** or **South** of the equator, depending on which radio button you select.
- Specify the **Longitude**, which is measured either **East** or **West** of the Greenwich meridian, depending on which radio button you select.

3 Date and Time

Specify the Date and Time of the selected Sun Angle. The initial time zone can be set in the Preferences dialog.

- Specify a **Date** for the selected Sun Angle. Select a month from the first drop-down list, a day from the second, and a year from the third.
- Specify a **Time** for the selected Sun Angle. Select an hour from the first drop-down list; minutes in 15 minute increments can be selected from the second list.
- If you want the Sun Angle to observe **Daylight Savings Time**, check this box.
- Specify the **Time Zone** that the building site is located in.

4 Plan View Display

Specify the Plan View Display of the selected Sun Angle.

- Specify the **Length of Plan Symbol**, which is the length of the Sun Angle arrow in plan view.
- Check **Show Date on Sun Angle** to have the date and time display on the Sun Angle arrow in plan view. This label uses the Text Style assigned to the “Sun Angle & Shadows” layer. See *Text Styles on page 360*.
- Check **Auto Rebuild Terrain** to rebuild the terrain automatically whenever you create a sun shadow. If this is unchecked and you regenerate sun shadows, the program will prompt you to rebuild the terrain. >See *Building the Terrain on page 860*.

When you use the Build Terrain command in plan view, all sun shadows in the plan are automatically updated.

- Click the **Make Shadow** button to create or regenerate the sun shadow in plan view. See *Sun Shadows on page 780*.
- Click the **Delete Shadow** button to remove the sun shadow from plan view.
- Check **Always Update** to have the program update the selected Sun Angle’s shadow whenever any of the defining information is changed. When this is checked, the program may be slower when changes are made in this dialog.
- If Always Update is unchecked and you make changes in this dialog, click the **Make Shadow** button to generate a new shadow.

Note: The Make Shadow option does not toggle Shadows, but may cause 3D views to update if they are using the selected Sun Angle. See *Shadows on page 770*.

LIGHTING DATA PANEL

A Sun Angle can be used as a light source in 3D views. The settings on the LIGHTING DATA panel control attributes of the sunlight associated with the selected Sun Angle.

The settings defined on the LIGHTING DATA panel do not affect the sun shadow in plan view: they only affect 3D views in which lighting and shadows can display.

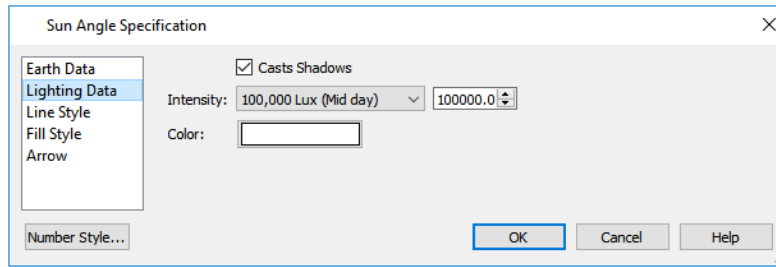

- When **Casts Shadows** is checked, the light source associated with the selected Sun Angle casts shadows. These shadows are similar to the shadow shown in plan view, but may render differently based on the presence of other light sources. See [Shadows on page 770](#).
- Select an **Intensity** from the drop-down list or specify a value using the text field to define the relative strength of the light source. The time of day as set on the EARTH DATA panel does not affect how the Sun Angle renders as a light source, but this does.
- Click the **Color** bar to select a color for the sunlight associated with the selected Sun Angle. See [Select Color Dialog on page 134](#).

LINE STYLE PANEL

For information about the LINE STYLE panel, see [Line Style Panel on page 204](#).

FILL STYLE PANEL

The settings on the FILL STYLE panel control the appearance of the selected Sun Angle's shadow in plan view. For information about these settings, see [Fill Style Specification Dialog on page 131](#).

ARROW PANEL

For information about the settings on the ARROW panel, see [Arrow Panel on page 205](#).



Adjust Sunlight Dialog

 The Adjust Sunlight dialog allows you to control the intensity, direction and color of the Generic Sun light source in the currently active 3D view or to select a Sun Angle to serve as the source of sunlight in the currently active view. See [Generic Sunlight on page 773](#).

The settings in this dialog are view specific. Any changes made to them affect the sun in the currently active 3D view only. Other 3D views can have their own unique settings.

The initial sunlight attributes used in a newly created camera are set in the Sunlight Defaults dialog. See [3D View Defaults and Preferences on page 736](#).

There are three ways to open the Adjust Sunlight dialog:

- From the menu, select **3D> Lighting> Adjust Sunlight**.
- From the toolbar, click **Camera View Lighting Tools** , then click the **Adjust Sunlight**  button.
- Right-click in an empty space in the background area, then select **Adjust Sunlight** from the contextual menu.

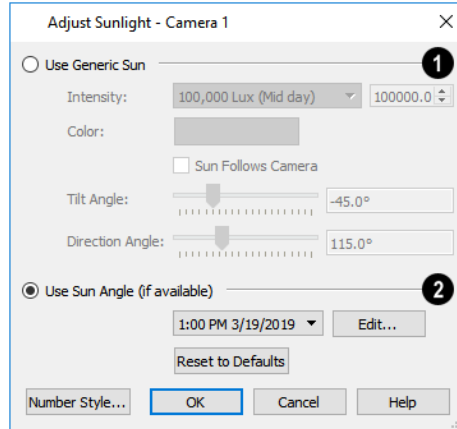

1 Use Generic Sun

Select Use Generic Sun to represent the sun in the currently active 3D view using the settings that follow.

- Use the **Intensity** slider bar or text field to control how bright the Generic Sun light appears.
- Click the **Color** bar to define the color of the light being modeled. Colored sunlight may be used to achieve special lighting effects, but may alter the appearance of your material colors and textures.
- Check **Sun Follows Camera** to adjust the position of the Generic Sun so that it is always behind the camera, illuminating surfaces in the view. When this is checked, the Tilt and Direction Angle settings that follow are disabled.

Note: If Use Generated Sky is in use as the backdrop in the current view and Sun Follows Camera is checked, the Generated Sky will not update if the camera is moved.

- Specify the **Tilt Angle**, which is the angle of the sunlight with respect to the horizon. A value of 90° means that the light points straight up, while a value of -90° means that the light points straight down. 0° is parallel to the horizon.
- Specify the **Direction Angle**, which is the direction that the sunlight points toward. 0° is measured horizontally on screen, pointing to the right. Positive values rotate in a counter-clockwise direction from there, while negative values rotate clockwise.
- Click the **Reset to Defaults** button to restore the settings set in the Sunlight Defaults dialog in the current view.
- In the Sunlight Defaults dialog, the **Restore Initial Settings** button is available instead. Click this to reset the options in that dialog to the originally installed settings.

2 Use Sun Angle

Select Use Sun Angle to represent the sun using a light source defined by a **Sun Angle** . See [Sun Angles and Shadows on page 778](#).

- Select a Sun Angle from the drop-down list to serve as the source of sunlight in the currently active 3D view. If no Sun Angle is present, the Generic Sun is used.
- Click the **Edit** button to open the Sun Angle Specification dialog for the selected Sun Angle.

By default, the Generic Sun light color is pure white, which has the least effect on the appearance of material colors and textures. See [Materials on page 711](#).

Rendering Techniques

 Any camera view, cross section/elevation view, or overview can be generated using one of several Rendering Techniques to produce views for a range of different purposes: from detail drawings to artistic presentation views. To access these tools, while a 3D view is active, select **3D> Rendering Techniques**, then select one of the following techniques:

There are two ways to create a view using a particular Rendering Technique:

- Create a 3D view, then select the desired rendering technique from the menu.
- Select the desired rendering technique in the Camera Defaults dialog, then create a 3D view. See *Camera Defaults Dialogs on page 737*.

Once a view is created, the effects of the selected rendering technique can be adjusted in the Rendering Technique Options dialog. See *Rendering Technique Options on page 787*.

If a camera view is saved, its Rendering Technique settings are saved, as well. See *Saving and Printing 3D Views on page 759*.

 The Watercolor technique requires more time to generate than other Rendering Techniques. To save time, adjust the camera's perspective before using one of these techniques. See *Editing 3D Views on page 754*.

STANDARD RENDERING

 Standard rendering is a photo-realistic technique that represents materials using textures, models lighting and shadows, and can also display reflections. Surface edge lines are not drawn and no special colors or effects are applied.



In plan view, the camera symbol for a view using the Standard technique displays an S in its center. See *Displaying 3D Views on page 747*.

VECTOR VIEW

 In Vector Views, surface edge lines are drawn and pattern lines and colors are used to represent materials while textures are not. Shadows are supported, and when in use a single light source is used to produce them. Shading Contrast can be applied to surfaces, but other special colors or effects are not.

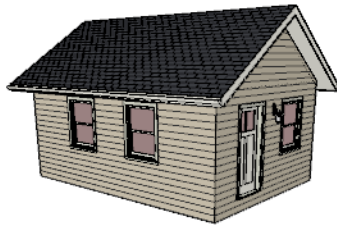

In plan view, the camera symbol for a view using the Vector View technique displays a V in its center.

PHYSICALLY BASED



Physically Based rendering is similar to the photo-realistic Standard technique: it represents materials using textures, does not draw surface edge lines, models lighting, and can display shadows.

Physically Based rendering models material properties and light propagation more accurately than other rendering techniques and is best used when a focus on lighting and finish materials is the goal.



In plan view, the camera symbol for a view using the Physically Based technique displays a Ph in its center.

GLASS HOUSE



Glass House rendering uses different shades of a single color to display the model with surface edge lines and semi-transparent surfaces. Lighting and shadows are not modeled, and materials are not represented, so neither pattern lines nor textures are used.

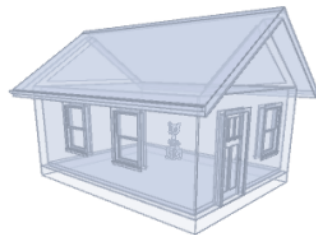

In plan view, the camera symbol for a view using the Glass House technique displays a G in its center.

TECHNICAL ILLUSTRATION



Technical Illustration rendering draws surface edge and pattern lines, and uses shades of two colors, Warm and Cool. The warm shade is applied to surfaces that face the light source in the view, and the cool shade, to surfaces that face away from it.

Only one light source is used: the light with the highest Intensity found in the room containing the camera. In exterior views, this light is always the Generic Sun. If no lights are on, a fallback light is used. Lighting is modeled as non-photorealistic, stylized highlights and shadows are supported. See [Lighting on page 772](#).

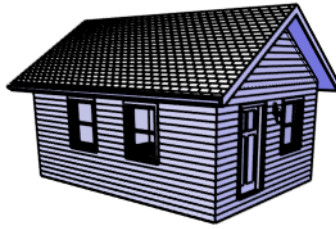

In plan view, the camera symbol for a view using the Technical Illustration technique displays a T in its center.

WATERCOLOR



Watercolor rendering approximates the effects of watercolor painting such as pigment pooling and flow. It uses textures to represent materials and models lighting, shadows, and reflections.



In plan view, the camera symbol for a view using the Watercolor technique displays a W in its center.

Note: In some plans, the Watercolor techniques may take a considerable amount of time. You can press the Esc key to cancel the rendering.

Rendering Technique Options



The settings in the Rendering Technique Options dialog allow you to control the specific effects of each rendering technique on an active 3D view. To access this dialog, create a camera view, cross section/elevation view, or overview and select **3D> Rendering Techniques> Technique Options**.

The Rendering Technique Options dialog can also be accessed by double-clicking the **Rendering Techniques**  parent button.

The settings in the Rendering Technique Defaults dialog are the same as those in this dialog, but control the initial settings of each technique when it is first applied.

In the Rendering Technique Options dialog, select a technique from the list on the left to make its options active on the right. When this dialog is first opened, the technique currently used by the view is selected.

As changes are made in the Rendering Technique Options dialog, the 3D view automatically updates to reflect those changes for all techniques except Watercolor. To update views using these techniques, which take more time to draw than the others, click the **Update** button in the dialog.

When a 3D view is saved, its Rendering Technique Options settings are saved, as well. See *Saving 3D Views on page 759*.

The Rendering Technique Options dialog has the following panels:

STANDARD PANEL



The active 3D view immediately updates to reflect any changes made to the Rendering Technique Options for Standard renderings.

There are a variety of other tools that affect the appearance of Standard rendered views, as well. See [Displaying 3D Views on page 747](#).

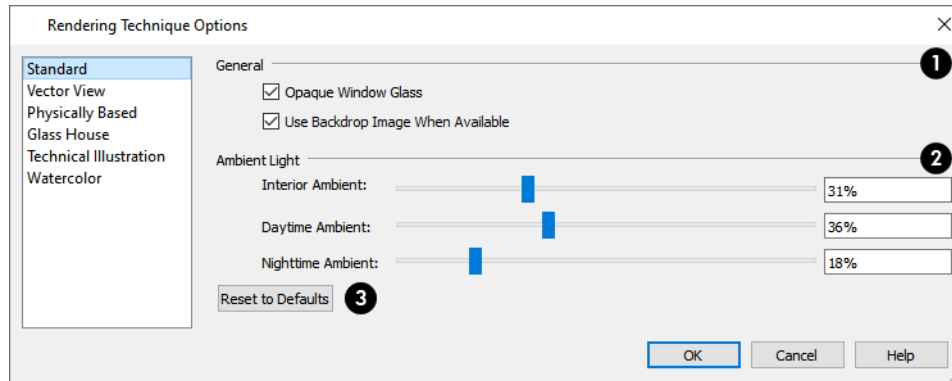

1 General

- Check **Opaque Window Glass** to make the glass in windows and doors opaque. When unchecked, door and window glass is transparent.
- When **Use Backdrop Image When Available** is checked, the backdrop image specified for this view is used. When unchecked or if no backdrop image is specified for the current view, the specified Backdrop Color is used instead. See [3D Backdrops on page 812](#).

2 Ambient Light

Specify the amount of Ambient light to use in different situations in Standard and Watercolor renderings. See [Ambient Lighting and Occlusion on page 773](#).

- **Interior Ambient** affects interior views.
- **Daytime Ambient** affects exterior views.
- **Nighttime Ambient** affects nighttime exterior views.

3 Reset

- Click **Reset to Defaults** to apply the Standard settings defined in the Rendering Technique Defaults dialog.
- In the Rendering Technique Defaults dialog, the **Restore Initial Settings** button is available instead. Click this to reset the options on this panel to the system defaults.

VECTOR VIEW PANEL



The active 3D view immediately updates to reflect any changes made to the Rendering Technique Options for Vector Views.

Additional settings that affect the appearance of Vector Views can be found in the 3D View Defaults dialog. See [3D View Defaults Dialog on page 739](#).

There are a variety of other tools that affect the appearance of Vector Views. See [Displaying 3D Views on page 747](#).

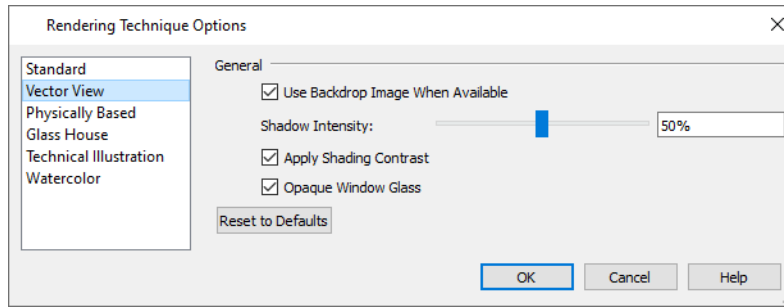

- Check **Use Backdrop Image When Available** to use the backdrop image specified for this view. When unchecked or if no backdrop image is specified for the current view, the specified Backdrop Color is used instead.
- Specify the **Shadow Intensity**, which is how dark or light shadows appear. A value of 100% creates shadows that hide any objects located within them; a value of 0% effectively produces no shadows.
- Check **Apply Shading Contrast** to use different levels of shading on surfaces oriented at different angles to the camera. When unchecked, unmodified material Colors are shown on all surfaces. Each material's Shading Contrast can be set individually. See [Pattern Panel on page 727](#).
- Check **Opaque Window Glass** to make the glass in windows and doors opaque. When unchecked, door and window glass is transparent.
- Click **Reset to Defaults** to apply the Vector View settings defined in the Rendering Technique Defaults dialog.
 - In the Rendering Technique Defaults dialog, the **Restore Initial Settings** button is available instead. Click this to reset the options on this panel to the system defaults.

PHYSICALLY BASED PANEL



The active 3D view immediately updates to reflect any changes made to the Rendering Technique Options for Physically Based renderings.

There are a variety of other tools that affect the appearance of Physically Based rendered views, as well. See [Rendering Tips on page 770](#).

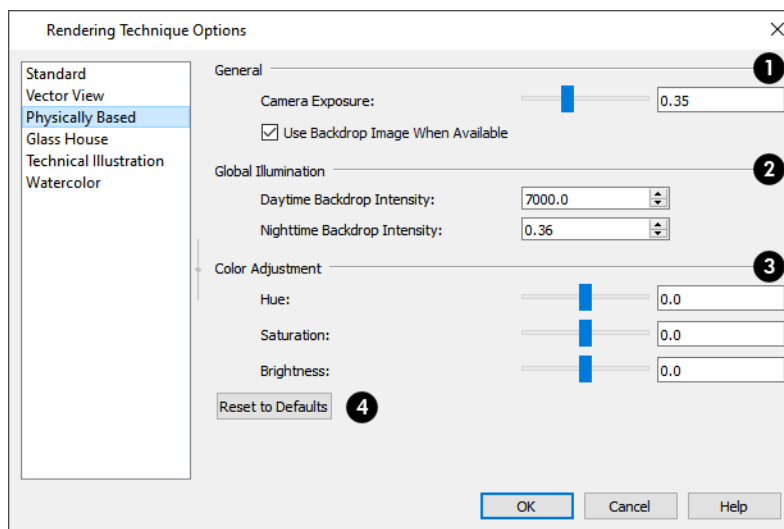

1 General

- Specify the **Camera Exposure**, which is the amount of light in the scene that is captured by the camera. A low value produces a darker view; too high a value can make the scene look washed out.
- When **Use Backdrop Image When Available** is checked, the backdrop image specified for this view is used. When unchecked or if no backdrop image is specified for the current view, the specified Backdrop Color is used instead.

2 Global Illumination

- Specify the **Daytime Background Intensity**, which is the brightness of the view's background color or backdrop image when the Sunlight is toggled on. See [Backdrop Panel on page 763](#).
- Specify the **Nighttime Background Intensity**, which is the background brightness when the Sunlight is toggled off. See [Generic Sunlight on page 773](#).

3 Color Adjustment

You can adjust the **Hue**, **Saturation**, and **Brightness** of the view, if needed.

4 Reset

- Click **Reset to Defaults** to apply the Physically Based settings defined in the Rendering Technique Defaults dialog.
- In the Rendering Technique Defaults dialog, the **Restore Initial Settings** button is available instead. Click this to reset the options on this panel to the system defaults.

GLASS HOUSE PANEL



The active 3D view immediately updates to reflect any changes made to the Rendering Technique Options settings for Glass House renderings.

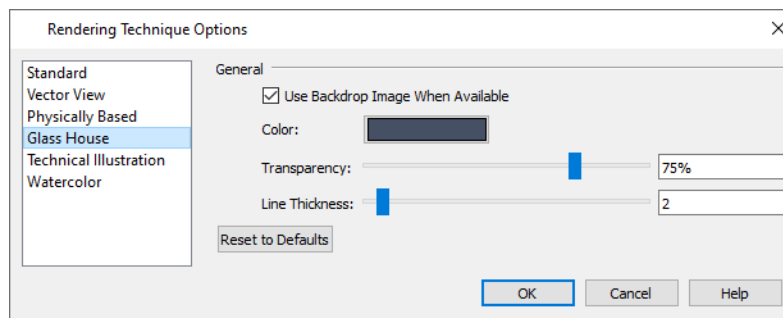

- When **Use Backdrop Image When Available** is checked, the backdrop image specified for this view is used. When unchecked or if no backdrop image is specified for the current view, the specified Backdrop Color is used instead. See [3D Backdrops on page 812](#).
- Click the **Color** bar to select a color for the semi-transparent surfaces and lines in a Glass House view. See [Select Color Dialog on page 134](#).
- Specify the **Transparency** of the surfaces in Glass House view. For example, to create a wireframe line drawing of your structure, turn transparency to full and minimize line thickness.
- Specify the **Line Thickness** of surface lines in Glass House view.

- Click **Reset to Defaults** to apply the Glass House settings defined in the Rendering Technique Defaults dialog.
 - In the Rendering Technique Defaults dialog, the **Restore Initial Settings** button is available instead. Click this to reset the options on this panel to the system defaults.

TECHNICAL ILLUSTRATION PANEL

 The active 3D view immediately updates to reflect any changes made to the Rendering Technique Options settings for Technical Illustration renderings.

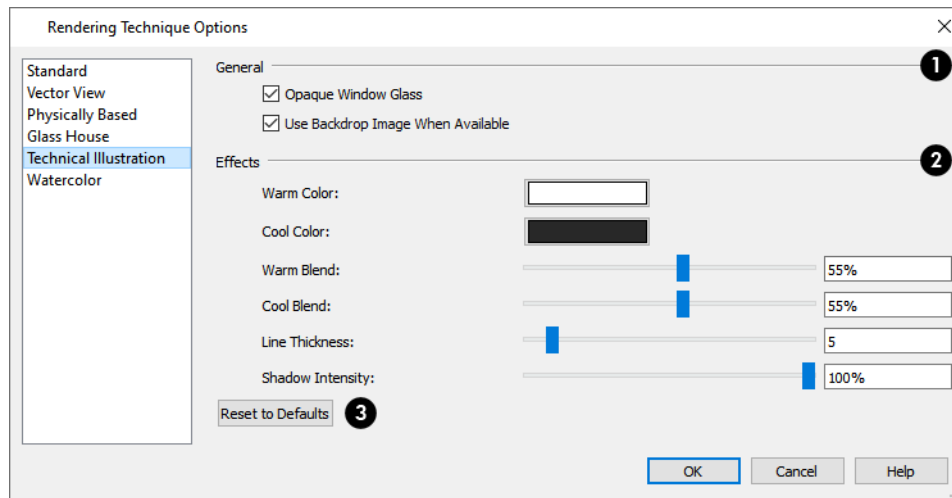

1 General

- Check **Opaque Window Glass** to make the glass in windows and doors opaque. When unchecked, door and window glass is transparent.
- When **Use Backdrop Image When Available** is checked, the backdrop image specified for this view is used. When unchecked or if no backdrop image is specified for the current view, the specified Backdrop Color is used instead. See [3D Backdrops on page 812](#).

2 Effects

- Click the **Color** bar to select a **Warm Color** for surfaces that face the light source and a **Cool Color** for surfaces that face away from the light. See [Select Color Dialog on page 134](#).
- Specify the **Warm Blend**, which is the degree to which the selected Warm Color is blended with original colors on well-lit surfaces in the view.
- Specify the **Cool Blend**, which is the degree to which the selected Cool Color is blended with original colors on shaded surfaces in the view.
- Specify the **Line Thickness** of all surface edge and pattern lines in the view.
- Check **Opaque Window Glass** to make the glass in windows and doors opaque. When unchecked, door and window glass is transparent.
- Check **Use Backdrop** to use the backdrop image specified for this view. When unchecked, the specified Backdrop Color is used.

3 Reset

- Click **Reset to Defaults** to apply the Technical Illustration settings defined in the Rendering Technique Defaults dialog.
- In the Rendering Technique Defaults dialog, the **Restore Initial Settings** button is available instead. Click this to reset the options on this panel to the system defaults.

WATERCOLOR PANEL



In order for the active 3D view to reflect changes made to the Rendering Technique Options settings for Watercolor renderings, you must click either the OK button or the **Update View** button in the dialog. This may take several moments.

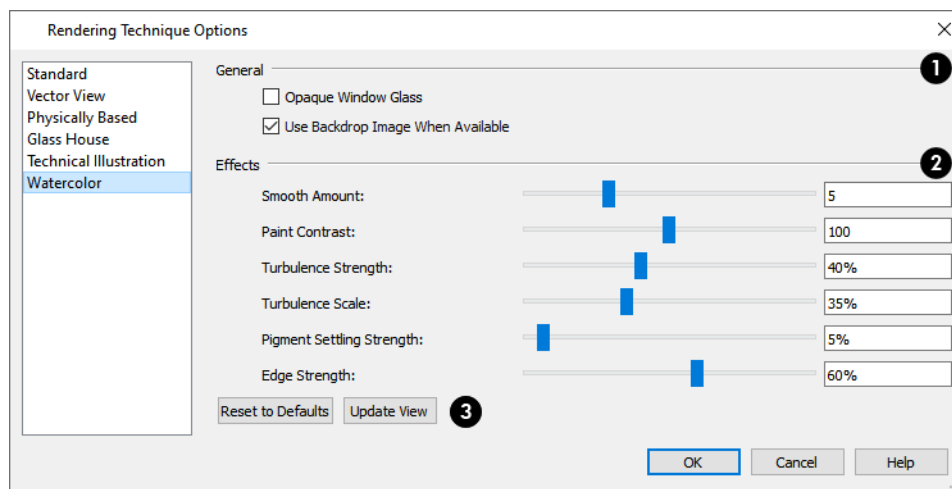

1 General

- Check **Opaque Window Glass** to make the glass in windows and doors opaque. When unchecked, door and window glass is transparent.
- When **Use Backdrop Image When Available** is checked, the backdrop image specified for this view is used. When unchecked or if no backdrop image is specified for the current view, the specified Backdrop Color is used instead.

2 Effects

- Specify the **Smooth Amount**, which is the degree to which details are removed from the original view.
- Specify the **Paint Contrast**, which determines the extent to which variations in pigment color are used.
- Specify the **Turbulence Strength**, which produces “pooling”, or variations in the strength of pigment colors.
- Specify the **Turbulence Scale**, which controls the size of the areas of pooling.
- Specify the **Pigment Settling Strength**, which is creates the appearance of pigment settling into low areas in paper.
- Specify the **Edge Strength**, which is how well-defined surface edge lines are.

3 Reset

- Click **Reset to Defaults** to apply the Watercolor settings defined in the Rendering Technique Defaults dialog.
- In the Rendering Technique Defaults dialog, the **Restore Initial Settings** button is available instead. Click this to reset the options on this panel to the system defaults.
- Views using the Watercolor technique do not update as changes are made to the settings here as they do with most Rendering Techniques. Click **Update View** to apply any changes to these settings to the current view.

Pictures, Images, and Walkthroughs

Chapter 32

Home Designer uses picture files in a variety of ways to enhance your drawings.

The Library Browser contains images of real world objects like plants and vehicles that can display in 3D views.

Picture files can also be imported into Home Designer and shown in most views.

You can save any view using a variety of picture file formats. In addition, Home Designer allows you to create virtual tour videos that can be played back later and shared with others.

TOPICS

Picture Files vs Pictures and Image Objects	795
Images	795
Displaying Images	796
Editing Images	797
Image Specification Dialog	797
Pictures	801
Picture File Box Specification Dialog	802
Metafiles	804
Metafile Box Specification Dialog	806
PDF Files	807
PDF Box Specification Dialog	808
Displaying Pictures, Metafiles, and PDF Boxes	809
Editing Pictures, Metafiles, and PDF Boxes	810
3D Backdrops	812
Backdrop Specification Dialog	813
Walkthrough Paths	815
Walkthrough Path Specification Dialog	818
Walkthrough Previews	820
Recording a Walkthrough	823

Picture Files vs Pictures and Image Objects

In common computer language, picture files, pictures and images are more or less synonymous. In the Home Designer environment, however, there are some notable differences between these terms.

In Home Designer, a two dimensional image file such as a .bmp, .jpg, .gif, or .png is referred to as a picture file or an image file. Examples of these files are saved on most computers and can be opened in a variety of applications.

A Picture, on the other hand, is a file that has been imported into the program. Pictures can be imported into plan view, cross section/elevation views, and layout pages. They are two-dimensional only and do not display in camera views or overviews.

An Image object is also based on a picture file, but it does display in both 2D and 3D views. Images have 3D width and height data associated with them, as well as a 2D symbol which displays in plan view.

Picture files have additional uses in Home Designer, as well:

- Backdrops are picture files that display behind 3D views. See [3D Backdrops on page 812](#).
- Textures are picture files that realistically represent materials in 3D views. See [About Materials on page 712](#).

Images

Images add realistic detail to 3D views without adding many surfaces to the model. For example, a tree image with a single surface can be used instead of a tree symbol with thousands, dramatically improving realism without compromising drawing time.

There are two types of Images in Home Designer:



Images rotate so that they always face the camera in 3D views.



Billboard Images do not rotate to face the camera. An example of when this may be useful is an image of a trellis, which might look awkward when facing a camera from a side view.

PLACING IMAGES





A selection of Images are available in the Library Browser. Select one and click in a plan view, camera view or overview to place it. See [Placing Library Objects on page 686](#).

CREATING IMAGES

Custom Images can be added to the User Catalog in the library, as well as created in plan files. Home Designer can use any image with a *.bmp, *.jpg, *.png, *.gif, or *.tif extension.

Generally, .png files work best as Images because this format has good compression and allows for the Image to contain transparency information.

To create an Image in plan view

1. In plan view, select **Build> Image> Create Image**  or **Billboard Image**  to open the Image Specification dialog. See [Image Specification Dialog on page 797](#).
2. On the IMAGE panel:

- Click the **Browse** button to select a picture file on your computer or enter the path to a valid picture file in the **Image File** field. If the file is not located in the Home Designer Pro 2022 Data folder, a copy of the file will be created at Home Designer Pro 2022 Data\Images\My Images and the Image object will reference that copy. See *Home Designer Pro Data on page 33*.
 - Select a **2D Plan Symbol** from the drop-down list or click the **Library** button and select a symbol from the library. The selected symbol represents the image in plan view. See *Image Panel on page 798*.
 - Specify the **Size** and **Position** of the image.
3. Specify transparency information on the TRANSPARENCY panel.
 4. Click OK to close the Image Specification dialog.
 5. Click to place the new Image in plan view.

To create an image in the Library Browser

1. In the Library Browser, right-click on an unlocked folder.
2. Select **New> Image** from the contextual menu to open the Image Specification dialog.
3. Browse to the image file you want to add and select your other options. See *Image Specification Dialog on page 797*.
4. Once created, the image is listed in the library folder that you right-clicked on. Size and other data is saved.

USING PASTE IMAGE



You can also import an image by first copying it to the system clipboard, then navigating to a Home Designer window and selecting **Edit> Paste> Paste**. See *Paste Special on page 121*.

Displaying Images



The display of images in floor plan and 3D views is controlled in the Layer Display Options dialog. See *Layer Attributes on page 124*.

Images are placed on the “Images” layer.

IN PLAN VIEW

In plan view, most images are represented by an Image  symbol. You can specify a different symbol to represent an image if you wish. See *Image Specification Dialog on page 797*.

IN 3D VIEWS

The actual picture associated with an image object can be seen in 3D views, as can any transparency data associated it. See *Image Specification Dialog on page 797*.

Images can be set to either rotate so that they always face the camera or remain stationary, like billboards. See *Images on page 795*.

IN LAYOUT VIEWS

Images can be included in all views sent to layout with the exception of those using Plot Lines. See *Plot Line Views on page 931*.

Editing Images

Images can be selected in 2D and 3D views and edited using the edit handles, edit tools and the Image Specification dialog. See [Image Specification Dialog on page 797](#).

USING THE MOUSE

In plan view, a selected image can be rotated, moved, and resized. In 3D views, a selected image only has two edit handles: the circular Resize handle and square Move handle.



When an image is resized using the edit handle, its aspect ratio is retained and 2D symbol resizes proportionally.

USING THE EDIT TOOLBAR

A selected image or images can be edited in a variety of ways using the buttons on the Edit Toolbar. See [The Edit Toolbar on page 91](#).

Image Specification Dialog

 Select an image and click the **Open Object** edit button to open the Image Specification dialog.

IMAGE PANEL



1 General

General information about the selected Image can be specified here.

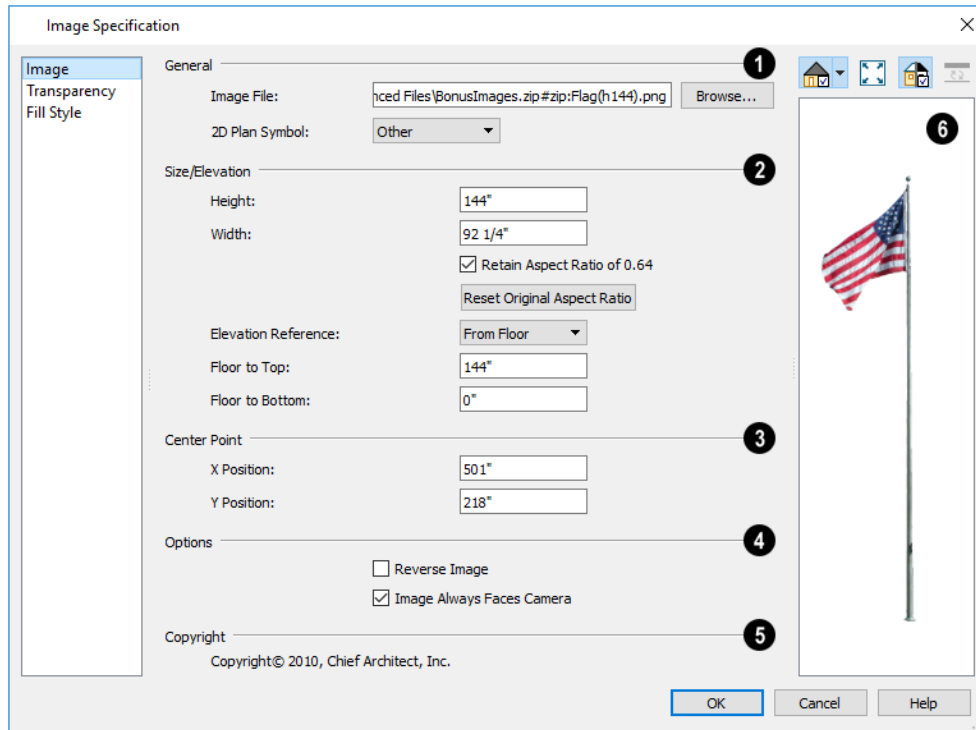
- The **Image File** associated with the Image can be specified. Click **Browse** to choose a file saved on your computer or type the file's full pathname in the text field.
- Select a **2D Plan Symbol** from the drop-down list to represent the Image in plan view. See [Displaying Images on page 796](#).

2 Size/Elevation

Specify the **Size/Elevation** of the image as it displays in 3D views.

- Enter a **Height** for the selected image.
- Enter a **Width** for the selected image.
- Uncheck **Retain Aspect Ratio of X** if you would like to modify the Height or Width without affecting the other value. If you do this, the image may appear distorted.
This check box does not affect editing performed outside of this dialog and is an action rather than a state: the next time you open this dialog, it will be checked.
- Click **Reset Original Aspect Ratio of** to reset the image's original aspect ratio and remove any distortion caused by resizing.
- Select the **Elevation Reference** from the drop-down list. This determines where the next two settings are measured from and also affects their setting labels.
- Specify the height **to Top**, measured from the selected Elevation Reference to the top edge of the image.
- Specify the height **to Bottom**, measured from the selected Elevation Reference to the bottom edge of the image.

3 Center Point

Specify the location of the **X and Y Coordinates** of the selected image's **Center Point**.

4 Options

Check **Reverse Image** to reflect the appearance of the image about an imaginary vertical line through its center.

Check **Image Always Faces Camera** to prevent the image from rotating to face the camera in 3D views. This box is unchecked for Billboard Images. See *Images on page 795*.

5 Copyright

Any **Copyright** information associated with the selected Image will be stated here.

6 Preview

A preview of the selected Image displays here. The Glass House Rendering Techniques is not available for images. See *Dialog Preview Panes on page 20*.

TRANSPARENCY PANEL

The settings on the TRANSPARENCY panel let you specify portions of the selected image as transparent.

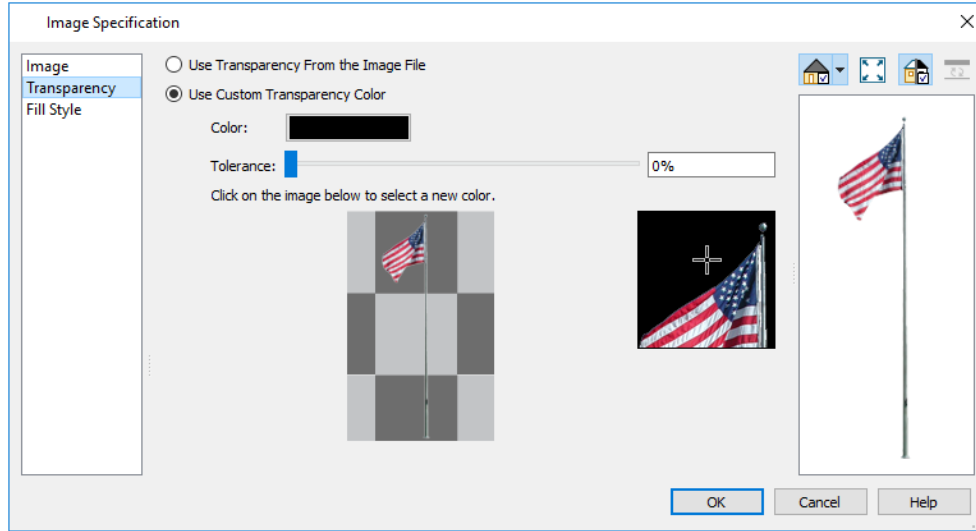

- Click the **Use Transparency From The Image File** radio button to use any transparency data included in the image file.
- Click the **Use Custom Transparency Color** radio button to specify a color in the image to represent the transparency and enable the settings below.
- Click the Color bar to select a color in the Select Color dialog. See [Select Color Dialog on page 134](#).
- Use the slide bar or enter a value to specify a level of **Tolerance** to be applied to colors that are almost the same as the specified transparency color.
- Move your pointer over the small preview image below. The pointer changes to an eyedropper and a magnified preview displays to its right. Click to select the color of the pixel your pointer is over as the Transparency color. The selected color displays in the Color bar, below.
- A magnified preview of the area in the preview image above displays here, allowing for accurate pixel selection.

Note: The image preview will display its original orientation, even if Reverse Image is checked on the Image panel.

THE TRANSPARENCY COLOR

If the portion of the image file that you wish to use contains the transparency color, that part of the image also becomes transparent. If this happens, the image may appear partially disintegrated.

You may need to experiment to find the best transparency color and tolerance for the image.

FILL STYLE PANEL

The settings on the FILL STYLE panel affect the appearance of the selected image's **2D Plan Symbol** in plan view, provided that the selected symbol is a closed shape. For information about these settings, see [Fill Style Specification Dialog on page 131](#).

COMPONENTS PANEL

The information on the COMPONENTS panel can be used in the materials list. For more information, see [Components Panel on page 921](#).

Pictures

A variety of picture file types can be imported into and exported out of Home Designer.

Metafiles are also types of picture files that can be imported and exported. See [Metafiles on page 804](#).

EXPORTING PICTURES

There are several ways to save a picture of a view in Home Designer:



Using the **Export Picture** tool is similar to creating a screen capture of everything in the current view window.

Pictures can be saved in various file formats and used in other applications. **Export Picture** is best suited for rendered views. When exporting a line-based view, best results can be achieved by saving it as a metafile. See [To export a metafile on page 805](#).



The **Export 360 Panorama** tool creates a spherical panoramic image file. See [Export 360 Panorama on page 844](#).



Use the **Print Image** tool to either print or save the current view as a PDF file. See [Print Image Dialog on page 958](#).

To export a picture

1. Open the view that you would like to export as a picture file.
2. Zoom, pan or otherwise adjust the view so that what you see on screen suits your needs. See [Displaying 3D Views on page 747](#).
3. Select **File> Export> Export Picture (BMP, JPG, PNG)**  to open the Export Picture dialog, below, and specify the desired image size and other properties.
4. In the Export Picture File dialog, which opens next, give the new picture file a name, file type, and save location. See [Exporting Files on page 38](#).

EXPORT PICTURE DIALOG

The settings in this dialog are retained between program sessions.

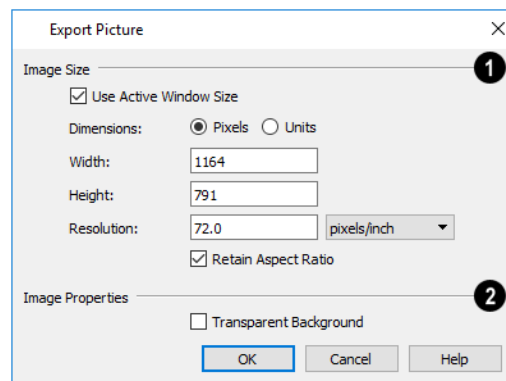

1 Image Size

Specify the exported file's **Image Size** in pixels or inches (mm).

- Check **Use Active Window Size** to export the picture at the same size as the active view window. The window's Width and Height are described below. In camera views only, these values can be changed, in which case this box becomes unchecked automatically.
- Select either **Pixels** or **Units** as the method by which the picture's dimensions are measured.
- Specify the **Width** and **Height** of the image. The initial values correspond to the view window's size. In plan view, they display for reference only.
- Specify the **Resolution** of the image. Select **Dots/Inch** or **Dots/mm** from the drop-down list.
- Uncheck **Retain Aspect Ratio** if you would like to modify the Height or Width without affecting the other value. Leave this box checked to prevent the image from becoming distorted.

2 Image Properties

Check **Transparent Background** to produce alpha transparency in the spaces between all objects that can be seen in the current view. Transparency associated with Fill and Text Styles is retained, as well. Note that the **.png** and **.png** file types support transparency, while the **.jpg** and **.bmp** file types do not.

When you click OK, the Export Picture File dialog will open, allowing you to specify a name, file type, and save location for the picture file.

IMPORTING PICTURES



Pictures can be imported into and displayed in plan view, cross section/elevation views, and layout pages. Pictures do not display in camera views or overviews. See *Displaying Pictures, Metafiles, and PDF Boxes on page 809*.

There are several ways to import a Picture into Home Designer:

- Select **File> Import> Import Picture (BMP, JPG, PNG)** to open the Import Picture File dialog, which is a typical open file dialog. See *Importing Files on page 42*.
- Click and drag an image file from an operating system window into the Home Designer window.
- In any application, copy an image to the system clipboard, then select **Edit> Paste> Paste Special**  from the program menu in an eligible view window. See *Paste Special on page 121*.

Note: Importing large, or multiple, Pictures into a plan or layout file can result in program slowness.

An imported picture is placed in the center of the current view. Once imported, pictures can be selected and edited. See *Editing Pictures, Metafiles, and PDF Boxes on page 810*.

If the file referenced by a picture object is modified outside of Home Designer, its appearance will not update in Home Designer until you close and reopen the plan or layout file it was imported into.

Picture File Box Specification Dialog



Select an imported picture file and click the **Open Object** edit button to open the Picture File Box Specification dialog.

GENERAL PANEL

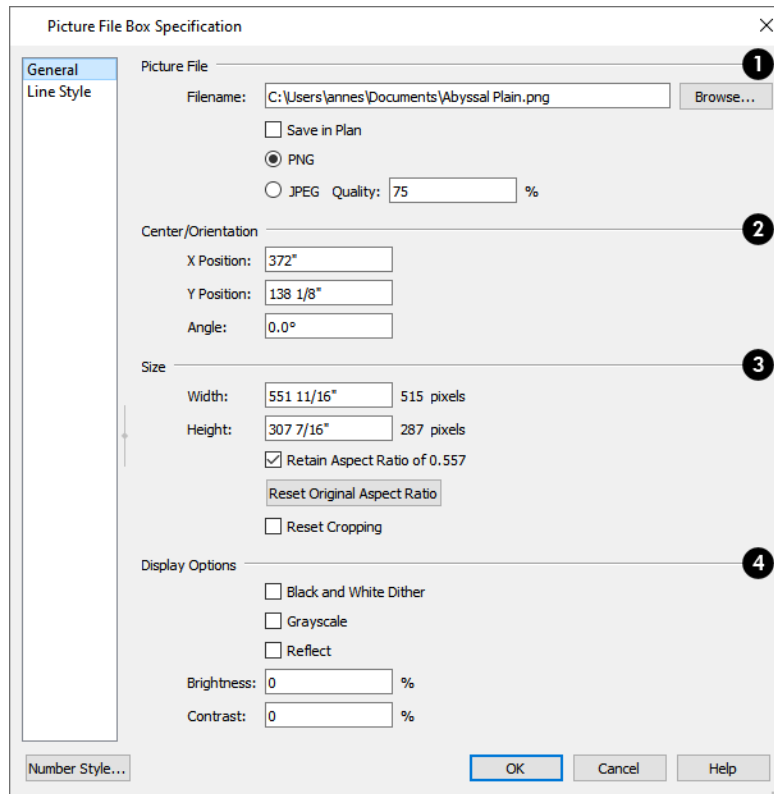

1 Picture File

Information about the selected **Picture File** can be specified here.

- The **Filename** of the picture file displays here. You can type a new pathname to change the picture assigned to this box if you wish.
- Click the **Browse** button to choose a new picture file or to relink to a missing file.
- Check **Save in Plan** to embed the picture in the plan or layout file. If a picture file is embedded, you do not need to include it when sending the plan or layout to a different computer.
- Click the radio button beside either **PNG** or **JPEG** to specify how to save the embedded picture data.
- Specify the picture's **Quality %** when **JPEG** is selected. A lower value results in better compression, while a higher value reduces data loss.

Note: PNG is the better option for pictures of line drawings, text, or large areas of a single color. In addition, PNG files support alpha channel transparency. JPEG is the better option for photos.

2 Center/Orientation

Specify the position of the selected Picture's center point and its angle. See [3D Drafting on page 11](#).

- Specify the **X and Y Positions** of the picture box's center point relative to the absolute origin.
- Specify the **Angle** of the picture box relative to a horizontal line pointing towards the right-hand side of the screen.

3 Size

Specify the **Size** of the picture in plan inches (mm).

- Specify the **Width** of the picture box. The original width in pixels displays to the right.
- Specify the **Height** of the picture box. The original height in pixels displays to the right.
- Uncheck **Retain Aspect Ratio of X** if you would like to modify the Height or Width without affecting the other value. If you do this, the picture may appear distorted. This check box does not affect editing performed outside of this dialog and is an action rather than a state: the next time you open this dialog, it will be checked.
- **Reset Original Aspect Ratio** - If the aspect ratio is changed, you can click this button to return the picture to its original aspect ratio.
- Check **Reset Cropping** to fill the extents of the selected Picture box with the image associated with it. If the box has been resized, the image may appear distorted. See [Editing Pictures, Metafiles, and PDF Boxes on page 810](#).

4 Display Options

A variety of **Display Options** are available.

- Check **Black and White Dither** to dither the selected picture file. Dithering creates a two tone effect that may produce better results when printed.
- Check **Grayscale** to replace the color in the selected picture with shades of gray.
- Check **Reflect** to reverse the image.
- Enter a degree of **Brightness** from 1 - 100%.
- Enter a degree of **Contrast** from 1 - 100%.

LINE STYLE PANEL

The settings on this panel are similar to those on the **LINE STYLE** panel in numerous other dialogs, with one exception: check **Show Outline** to turn on the display of the picture's border polyline. For more information, see [Line Style Panel on page 204](#).

Metafiles

A metafile (**.emf**, **.wmf**) is a special picture file format made up of vectors (lines) that allow the image to be rescaled without loss of quality. High resolution pictures of line-based views can be exported as a metafile.



Note: Metafiles are not supported in Mac operating systems and cannot be imported or exported in Mac versions of the software.

EXPORTING METAFILES

 An enhanced metafile (.emf) can be exported from any line-based view: that is, from plan view and 3D Vector Views.

Only objects that display on screen are included in an exported metafile.

To export a metafile

1. Accurately position the view on screen.
2. Select **File> Export> Export Metafile (EMF)** .
3. Drag a marquee  from corner to corner, defining the area that will included in the metafile.
4. Release the mouse button to open the Export Metafile dialog, which is a typical Save As dialog. See [Exporting Files on page 38](#).
5. When you click the Save button, the Metafile Size dialog opens.

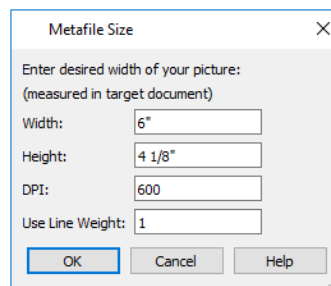

6. Specify the desired **Width** or **Height** of the metafile. When one value is edited, the other changes to maintain its aspect ratio.

Specify, too, the desired **Dots Per Inch (DPI)** for the metafile. A larger value results in a higher quality metafile, but also a larger file size.

7. When a metafile is exported from a 3D Vector View, you can also specify the printed thickness of lines in the view. To increase the printing line weight, type a larger number in the **Use Line Weight** field. See [Vector View on page 785](#).

Metafiles exported from plan view use the line weights defined in the Layer Display Options dialog. See [Layer Display Options Dialog on page 126](#).

IMPORTING METAFILES

 Metafiles can be imported into and displayed in plan view, cross section/elevation views, and layout pages. Metafiles do not display in camera views or overviews. See [Displaying Pictures, Metafiles, and PDF Boxes on page 809](#).

There are two ways to import a metafile into Home Designer:

- Select **File> Import> Import Metafile (EMF, WMF)**  to open the Import Metafile dialog, which is a typical open file dialog. See [Importing Files on page 42](#).
- You can also click and drag a metafile file from an operating system window into the Home Designer window to import it.

An imported metafile is placed in the center of the current view. Once imported, metafiles can be selected and edited. See [Editing Pictures, Metafiles, and PDF Boxes on page 810](#).

Metafile Box Specification Dialog



Select an imported metafile and click the **Open Object** edit button to open the Metafile Box Specification dialog.

GENERAL PANEL

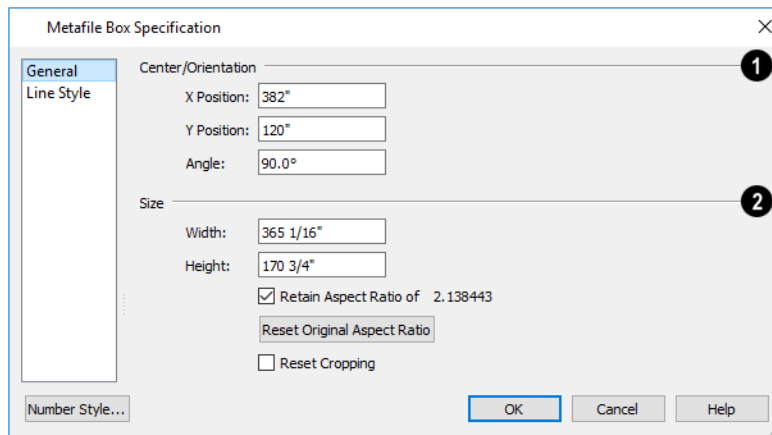

1 Center/Orientation

Specify the position of the selected metafile's center point and its angle. See [The Home Designer Pro Environment on page 11](#).

- Specify the **X** and **Y Position** relative to the absolute origin.
- Specify the **Angle** of the metafile box relative to a horizontal line pointing towards the right-hand side of the screen.

2 Size

Specify the **Size** of the metafile in plan inches (mm).

- Specify the **Width** of the metafile box.
- Specify the **Height** of the metafile box.
- Uncheck **Retain Aspect Ratio of X** if you would like to modify the Height or Width without affecting the other value. If you do this, the metafile may appear distorted.
This check box does not affect editing performed outside of this dialog and is an action rather than a state: the next time you open this dialog, it will be checked.
- **Reset Original Aspect Ratio** - If the aspect ratio is changed, you can click this button to return the picture to its original aspect ratio.
- Check **Reset Cropping** to fill the extents of the selected metafile box with the image associated with it. If the box has been resized, the image may appear distorted. See [Editing Pictures, Metafiles, and PDF Boxes on page 810](#).

LINE STYLE PANEL

The settings on this panel are similar to those on the LINE STYLE panel in numerous other dialogs, with one exception. Check **Show Outline** to turn on the display of the picture's border polyline. For more information, see [Line Style Panel on page 204](#).

PDF Files

Portable Document Format (.pdf) files are a special type of file that can be viewed on nearly any computer and can include a wide variety of visual information.

PRINTING AND EXPORTING PDF FILES

 You can save any view as a 2D .pdf file by selecting **File> Export> Export PDF**. This will open either the Print View or Print Image dialog, depending on the view type.

You can also save any view as a 2D .pdf file by selecting “Chief Architect Save as PDF” as the Destination printer **Name** in either of these dialogs. See [Printing to a PDF File on page 950](#).

IMPORTING PDF FILES

 To import a .pdf file, select **File> Import> Import PDF**. You can also import a .pdf file by dragging it from an operating system window into the Home Designer window.

You can import .pdf files into Home Designer Pro in plan view, cross section/elevation views., and in layout. Once imported, PDF boxes behave and can be edited similar to imported pictures and metafiles. See [Editing Pictures, Metafiles, and PDF Boxes on page 810](#).

Some .pdf files can contain both 2D and 3D information; however, Home Designer can only support 2D data in an imported .pdf file. When a 3D .pdf file is imported, it may display text, a static image of the 3D model, or it may not import at all.

Note: Importing large, or multiple, .pdf files into a plan or layout file can result in program slowness.

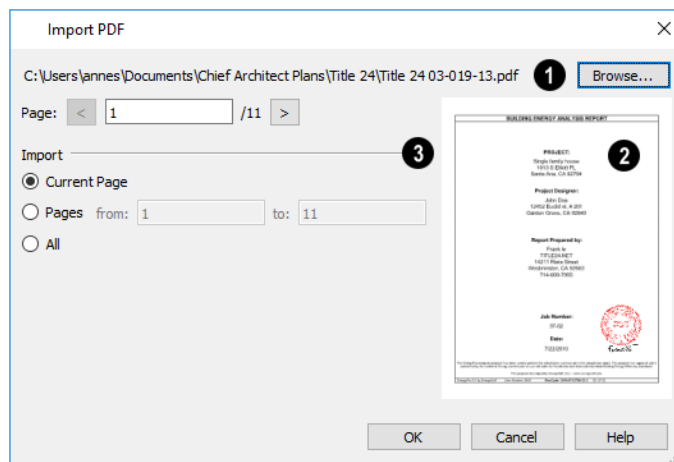

1

The full pathname of the **.pdf** file displays here. If the pathname is not that of a valid **.pdf** file, this text will display in red.

- Click the **Browse** button to choose a new **.pdf** file or to relink to a missing file.
- Specify the **Page** of the **.pdf** file that displays in the preview on the right. Type a page number in the text field or use the spin control arrows to browse the pages sequentially.

2 Preview

A preview of the page selected above displays on the right.

3 Import

Specify how much of the **.pdf** file you wish to **Import**. When multiple pages are imported, a separate PDF box is created for each one.

- Select **Current Page** to import only the page specified above and shown in the preview to the right.
- Select **Pages**, then specify the starting page in the **From** field and the ending page in the **To** field.
- Select **All** to import the entire **.pdf** file.

PDF Box Specification Dialog

 Select an imported PDF box and click the **Open Object** edit button to open the PDF Box Specification dialog.

GENERAL PANEL

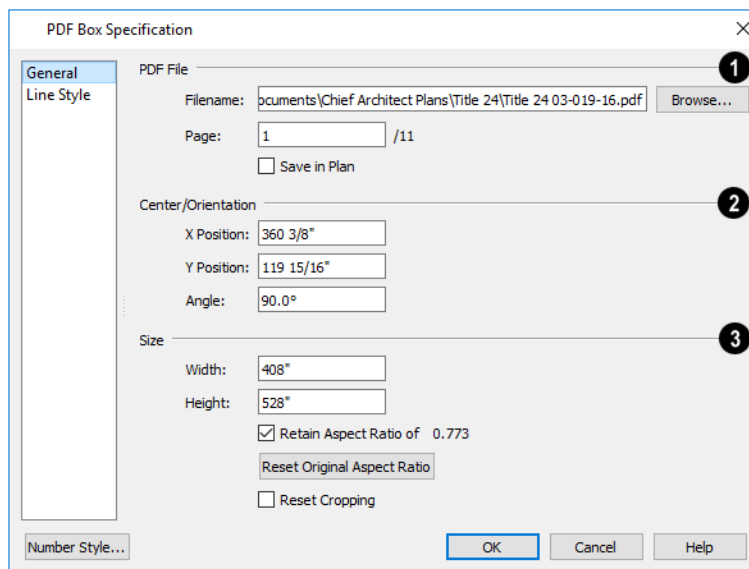

1 PDF File

The full **Filename** of the **.pdf** file displays here. Type a new name to associate the selected PDF box with a different **.pdf** file.

- Click the **Browse** button to choose a new **.pdf** file or to relink to a missing file.
- Specify the **Page** of the **.pdf** file that displays in the selected PDF box.
- Check **Save in Plan** to embed the **.pdf** in the plan or layout file. If a **.pdf** is embedded in a file, you do not need to include it when sending the file to a different computer. If the **.pdf** file is modified, however, the PDF box in Home Designer Pro will only update automatically if this is unchecked.

2 Center/Orientation

Specify the position of the selected PDF box's center point and its angle. See *3D Drafting on page 11*.

- Specify the **X and Y Positions** of the PDF box's center point relative to the absolute origin.
- Specify the **Angle** of the PDF box relative to an imaginary horizontal line pointing towards the right-hand side of the view window.

3 Size

Specify the **Size** of the PDF box in plan inches (mm).

- Specify the **Width** of the PDF box.
- Specify the **Height** of the PDF box.
- Uncheck **Retain Aspect Ratio of X** if you would like to modify the Height or Width without affecting the other value. If you do this, the PDF box may appear distorted.
This check box does not affect editing performed outside of this dialog and is an action rather than a state: the next time you open this dialog, it will be checked.
- **Reset Original Aspect Ratio** - If the aspect ratio is changed, you can click this button to return the picture to its original aspect ratio.
- Check **Reset Cropping** to fill the extents of the selected PDF box with the image associated with it. If the box has been resized, the image may appear distorted. See *Editing Pictures, Metafiles, and PDF Boxes on page 810*.

LINE STYLE PANEL

The settings on this panel are similar to those on the **LINE STYLE** panel in numerous other dialogs, with one exception: Check the **Show Outline** box to turn on the display of the PDF box's border polyline.

See *Line Style Panel on page 204*.

Displaying Pictures, Metafiles, and PDF Boxes



The display of Pictures, Metafiles, and PDF Boxes is controlled in the **Layer Display Options** dialog. See *Layer Attributes on page 124*.

Pictures, Metafiles, and PDF Boxes are placed on the “CAD, Default” layer.

Pictures, Metafiles, and PDF Boxes can be imported into and displayed in plan view, cross section/elevation views, and layout pages. A Picture, Metafile, or PDF Box can only be seen in the view where it was imported and cannot be imported into a camera view or overview.

DRAWING GROUPS

Each object in a plan or layout file is included in a Drawing Group, which influences whether it displays in front of or behind other objects. By default, imported pictures and PDF Boxes are placed in the Back Group, and imported metafiles are placed in the same Drawing Group as CAD objects.

Once imported, the drawing order of pictures, metafiles, and PDF Boxes can be customized. See [Drawing Groups on page 128](#).

IN LAYOUT

Pictures, metafiles, and PDF boxes are included when a view is sent to layout, and can also be imported directly onto a layout page. See [Pictures, Metafiles, and PDFs in Layout on page 927](#).

Editing Pictures, Metafiles, and PDF Boxes

Pictures, Metafiles, and PDF Boxes can be selected and edited using the edit handles, the Edit Toolbar, and their specification dialogs.

IN THE SPECIFICATION DIALOG

Pictures, Metafiles, and PDF Boxes can be customized in their specification dialog. See:

USING THE EDIT HANDLES

Pictures, Metafiles, and PDF Boxes have edit handles similar to other box-based objects. See [Editing Box-Based Objects on page 158](#).

- The corner Resize handles do not behave the same for Pictures, Metafiles, and PDF Boxes as they do for CAD boxes, however. If you drag a corner handle of one of these objects while the Default Edit Behavior is active, its contents will resize and height to width ratio will be retained.
- If you drag an Extend handle along a Picture, Metafile, or PDF Box's edge, the contents of the box will not be resized. If you resize it larger, an empty space will be created between that edge and the contents; if you resize it smaller, the contents will be cropped.

USING DIMENSIONS

Pictures, Metafiles, and PDF Boxes can be relocated relative to other objects with precision using dimensions.

To avoid changing the selected object's aspect ratio, make sure you choose to move the entire object rather than the selected edge. See [Moving Objects Using Dimensions on page 332](#).

USING THE EDIT TOOLS



A selected Picture, Metafile, or PDF Box can be edited in a variety of ways using the buttons on the Edit Toolbar. See [The Edit Toolbar on page 91](#).

POINT TO POINT RESIZE



A selected picture, metafile, or PDF box can be resized in either the X or Y direction with the **Point to Point Resize** edit tool.

To use the Point to Point Resize tool

1. Select a picture box, metafile box, or PDF box.
2. Click the **Point to Point Resize**  edit button. When you move the mouse pointer into the drawing area, it displays the Point A  icon.
3. Click on the first of two points in the selected object's area that have a known distance between them.
4. Notice:
 - A temporary CAD point is created at the point where you clicked.
 - The mouse pointer now displays the Point B  icon.
 - As you move the mouse pointer, an extension line extends either horizontally or vertically from Point A.
5. Click on the second of the two points with a known distance between them.
 - Regardless of where the mouse pointer is positioned, Point B will be at the end of the extension line so for best results Points A and B should be on the same X or Y plane.
6. After you click on the second point, the Point to Point Resize dialog opens.

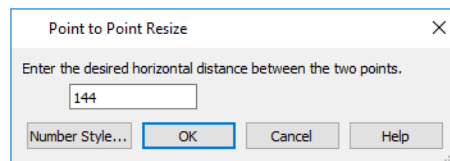

7. The current distance between the two points populates the text field. Enter a new dimension that matches the desired distance between the points.
8. When **Retain Aspect Ratio** is checked, the ratio between the selected object's height and width is maintained when you click OK and the object is resized. When this is unchecked, the object may become distorted-looking. If the selected object has been rotated, this box will be disabled and its aspect ratio will be retained.
9. Click **OK** to resize the picture, metafile, or pdf.

RESIZE FACTOR

With a bit of calculation, an imported picture, metafile, or PDF box can be resized to scale using the Transform/Replicate Object dialog. Once resized, the information in the object box can be traced using Home Designer Pro's drawing tools and then deleted.

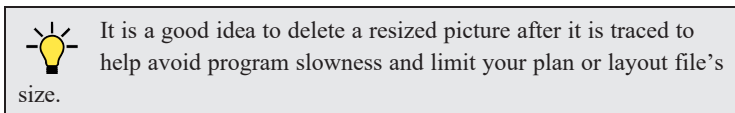

To calculate the Resize Factor

1. Find two items in the imported object that are separated by a known horizontal or vertical distance, such as two walls or plot lines.
2. Draw parallel CAD lines on top of these two items. See *The CAD Drawing Tools on page 194*.
3. Find the distance between the CAD lines. See *The Manually Drawn Dimension Tools on page 323*.
4. The Resize Factor for the image is the distance described in the picture divided by the distance between the CAD lines.

For example, if the items are supposed to be 10 feet apart on the picture, but the distance between the two CAD lines drawn on them is only 2 feet, you need to set the Resize Factor for the picture to 5. (10' divided by 2' equals 5). When the picture is 5 times the original size, the items on the picture are at the actual scale shown on the picture.

5. Select the picture and click the **Transform/Replicate Object**  edit button.
6. In the Transform/Replicate Object dialog, select the **Resize Factor** check box.
7. Enter the Resize Factor calculated above, then click **OK**.

3D Backdrops

A backdrop is an image, typically of an exterior view, that displays in the background of 3D views to help place the model into a realistic setting and add a sense of perspective.



Backdrops automatically adjust to fit each view window, so they look best when they are created with a height to width ratio that is similar to the window you are working in.



You can create digital photos of a building site for use as a backdrop.

SPECIFYING A BACKDROP IMAGE

Backdrop images are view specific. You can select a backdrop image for a camera view from the library in either of two ways:

- In a 3D view, open the Library Browser. Select a Backdrop image, then move your mouse pointer  into the view window. Click anywhere in the view to apply the selected backdrop.
- Open the Camera Specification dialog, and on the BACKDROP panel, click the **Select Backdrop** button. See *Backdrop Panel on page 763*.

When a backdrop image is not applied, Home Designer applies a background color instead. This color can be specified on the BACKDROP panel of the Camera Specification dialog, as well.

SPHERICAL PANORAMIC BACKDROPS

Spherical Panoramic Backdrops are a special type of backdrop that wraps around the model in 3D views as though it were applied to a sphere surrounding it. It takes an image processing program or special camera to generate spherical panoramic backdrops.

If you have such a file, you can specify it as your Backdrop image, then check **Spherical Panoramic Backdrop** in the camera's specification dialog.

The **Use Generated Sky** option produces a special Spherical Panoramic Backdrop that simulates a daytime sky using the Generic Sun or active **Sun Angle**  data. See [Sun Angles and Shadows on page 778](#).

BACKDROP DEFAULTS

By default, Home Designer uses backdrop images in Perspective Full Cameras only. You can, however, specify which types of views use backdrops by default, and also select the default backdrop images for each, in the Camera Tools Defaults dialogs. See [Camera Defaults Dialogs on page 737](#).

Similarly, backdrop images are only used by default in a few Rendering Techniques: Standard, Watercolor, and Physically Based. You can choose whether a backdrop is used in any technique in the Rendering Technique Options dialog. See [Rendering Technique Options on page 787](#).

ADDING NEW BACKDROPS

A new backdrop image can be created using a variety of graphic file formats and can be imported into Home Designer in several ways:

- Select **File> Import> Backdrop**  to open the Import Backdrop File dialog, which is similar to the Import Picture File dialog. See [Importing Pictures on page 802](#).
- Right-click on the User Catalog and select **New> Backdrop** from the contextual menu.
- Copy and paste an image into Home Designer. See [Copying and Pasting Objects on page 117](#).

Backdrop Specification Dialog



To open the Backdrop Specification dialog, select **File> Import> Import Backdrop** or right-click on the User Catalog in the Library Browser and select **New> Backdrop** from the contextual menu. See [Adding New Backdrops on page 813](#).

You can also open this dialog by right-clicking on a backdrop image in the User Catalog in the Library Browser and selecting **Open**  from the contextual menu.

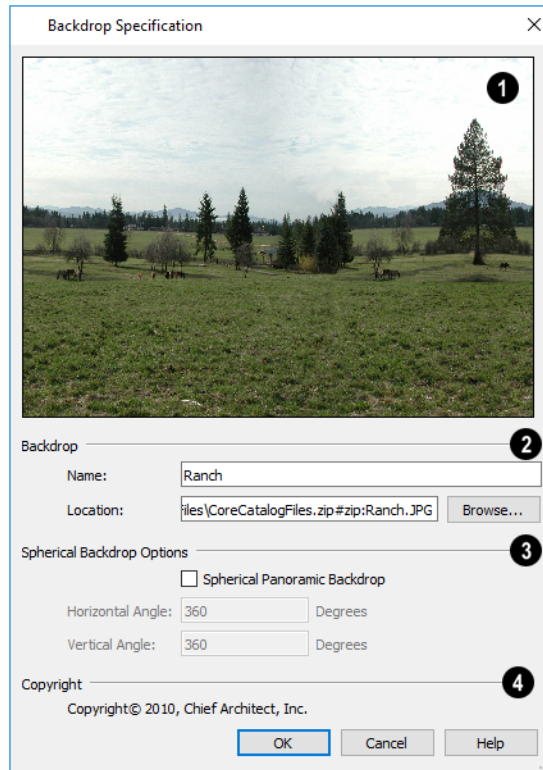

1 Preview

A preview of the selected image displays here.

2 Backdrop

Specify backdrop's Name and the image file associated with it.

- Type a **Name** for the selected backdrop, to be used in the Library Browser and 3D View Defaults dialog.
- In the **Location** field, type the full pathname of the image file or click the **Browse** button and browse to the file on your computer. If the file is not located in the Home Designer Pro 2022 Data folder, a copy of the file will be created at Home Designer Pro 2022 Data\Backdrops\My Backdrops and the program will reference that copy. See *Home Designer Pro Data on page 33*.

3 Spherical Backdrop Options

The **Spherical Backdrop Options** should only be used if the selected backdrop was specially created to serve as a spherical panoramic backdrop.

- Check **Spherical Panoramic Backdrop** to project the image onto a sphere that surrounds the model in camera views and overviews.
- The **Horizontal Angle** controls how many times the backdrop appears as you rotate in a full circle around the model. A value of 360° wraps the image around once; a value of 720°, twice; and a value of 180° makes only half the image wrap around the sphere.
- The **Vertical Angle** determines how much of the backdrop stretches up and down. To have it stretch from the highest point in the sky to the lowest point below the ground, use a value of 180°. To have the backdrop stretch from just below a horizontal render to just above, use a smaller value, such as 100°.

Some experimenting with the **Angle** values may be necessary to achieve the desired results. You may prefer to do this after adding the backdrop to a plan. See [Backdrop Panel on page 763](#).

4 Copyright

If the selected image has a **Copyright**, information about it will display here.

Walkthrough Paths

 A 3D Walkthrough is a series of pictures saved as an **.mp4**, **.wmv**, or **.avi** file that can be played as a video by media player applications. Although you can record a walkthrough video directly from a camera view, Walkthrough Paths offer more options and flexibility and are the preferred way to create a walkthrough video in Home Designer.



CREATING WALKTHROUGH PATHS

There are two ways to create a Walkthrough Path:

 The **Create Walkthrough Path** tool allows you to define the route that a walkthrough video travels through a plan as well as specify details like camera height, angle, and speed before actually recording.

 Available in plan view, the **Create Orbital Walkthrough Path** edit tool creates a circular walkthrough path around a selected full overview or camera's focal point. The path's radius is equal to the length of the camera's line of sight, and all frames are pointed at the camera's focal point. **3D> Walkthroughs> Create Orbital Walkthrough Path** is also an option when a camera view or overview is active.

To use the Create Walkthrough Path tool

1. Begin by choosing a codec for recording walkthroughs. See [Selecting a Codec on page 826](#).
2. In plan view, select **3D> Walkthroughs> Create Walkthrough Path** , then click and drag to draw a Walkthrough Path. See [To use the Spline tool on page 219](#).
3. Edit the direction and curvature of the spline's segments, as needed. See [Editing Spline-Based Objects on page 160](#).
4. Add **Key Frames**  to the path and modify their specifications. See [Key Frames on page 816](#).

5. Select the path and click the **Record Walkthrough Along Path**  edit button. See *Record Walkthrough Along Path on page 823*.



In plan view, you can convert a CAD polyline or spline into a Walkthrough Path. See *Convert Polyline on page 179*.

DISPLAYING AND EDITING WALKTHROUGH PATHS

Walkthrough Paths display in plan view only and are located on the “Walkthrough Paths” layer. Walkthrough Paths display in front of most other objects, will print, and are included in views sent to layout or exported to **.dxf/.dwg**. See *Layers on page 123*.

Before a Walkthrough Path can be edited, it must be selected. The Key Frame closest to the point where you clicked will be the Selected Key Frame. See *Selecting Objects on page 141*.

Walkthrough Paths can be edited like other spline-based objects using the edit handles, edit toolbar, and specification dialog. See *Editing Spline-Based Objects on page 160*.

In addition to the standard edit handles for splines, Walkthrough Paths also have an edit handle for each Key Frame. The Key Frame closest to the point where you click displays the Selected Edge Handle Fill color, while the other Key Frame handles use the Secondary Handle Fill color. Both are set in the Preferences dialog. See *Colors Panel on page 62*.

To reverse the direction of the entire walkthrough, select it and click the **Reverse Direction**  edit button. See *Reverse Direction on page 178*.





KEY FRAMES

 Key Frames are points along a Walkthrough Path that allow you to change:

- Camera direction, tilt angle, and height;
- Changes in walkthrough speed;
- The floor that the walkthrough is on.

These changes are applied as the camera moves along the Walkthrough Path from one Key Frame to another.

To add a Key Frame to a Walkthrough Path

1. Select the path and click the **Add Key Frame**  edit button.
2. If you wish to add multiple Key Frames, click the **Sticky Mode**  edit button. See *Sticky Mode on page 120*.
3. Click on the selected path to add a Key Frame at that location. The new Key Frame receives height and angle attributes based on its position on the path and the attributes of the Key Frames before and after it.
4. If you clicked the **Sticky Mode**  button, continue clicking to create additional Key Frames. When you are finished, click the **Main Edit Mode**  edit button or select a different drawing tool.

In plan view, each Key Frame is represented by a camera symbol centered along the walkthrough path. It displays its Key Frame number, is pointed in the direction of its **Camera Angle**, and its position along the path corresponds to its **Time** setting.

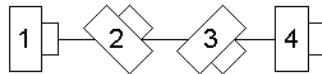

Key Frame **Time**, **Angle**, and other properties can be edited in the Walkthrough Path Specification dialog. See [General Panel on page 818](#).



You can also select a Walkthrough Path and move and rotate each Key Frame using its edit handles.

To remove a Key Frame from a Walkthrough Path, click on its symbol to select it and click the **Delete Key Frame**  edit button. The selected Key Frame can be identified by the color of its Move edit handle. This edit tool can be used to delete the Start and End Key Frames; however, if only two Key Frames are present it will not be available. Key Frames can also be deleted in the Walkthrough Path Specification dialog. See [Selected Edge on page 142](#) and [General Panel on page 818](#).

WALKTHROUGH PATHS AND STAIRS

If you draw a Walkthrough Path up or down a staircase or ramp, it will follow the height of the stairs or ramp and continue on the next floor.

To create a multiple floor walkthrough

1. Draw a Walkthrough Path so that it extends into a staircase or ramp in the same direction as its Direction Arrow. See [Displaying Stairs, Ramps, and Landings on page 516](#).
 - Do not drag the Walkthrough Path across the entire length of the stairs or ramp. If you do, its height will remain relative to the current floor.
2. When you release the mouse button, the program will automatically display a dashed line with an arrow extending past the last Key Frame on the current floor.
 - If it follows stairs or a ramp going upward, the path will also extend to the top end of the staircase or ramp.
3. Go up or down one floor, select the Walkthrough Path, and resize and reshape it as needed. You can use the **Create Walkthrough Path**  tool to draw more segments and use the **Add Key Frame**  edit tool, as well.

PREVIEWING A WALKTHROUGH



Depending on the quality settings and length of a Walkthrough Path, it may take a considerable amount of time to record a walkthrough video. The Walkthrough Preview side window allows you to preview part or all of an existing walkthrough path to confirm that it meets your needs prior to actually recording it. Select **View> Walkthrough Preview** to open or close this side window. See [Walkthrough Previews on page 820](#).

PLAYING A WALKTHROUGH

Once a walkthrough has been recorded, it can be played using a media player on your system.

To play a walkthrough

1. Select **3D> Walkthroughs> Play Walkthrough**  to open the Select Video File dialog.
2. Browse to the **.mp4**, **.wmv**, or **.avi** file on saved on your computer. Your system's default video player plays the walkthrough video.

Walkthrough Path Specification Dialog

Select a Walkthrough Path and click the **Open Object** edit button to open the Walkthrough Path Specification dialog. See *Walkthrough Paths* on page 815.

Most of the settings in this dialog are also found in the Walkthrough Path Defaults dialog.

The Walkthrough Path Specification dialog has the following panels:

GENERAL PANEL

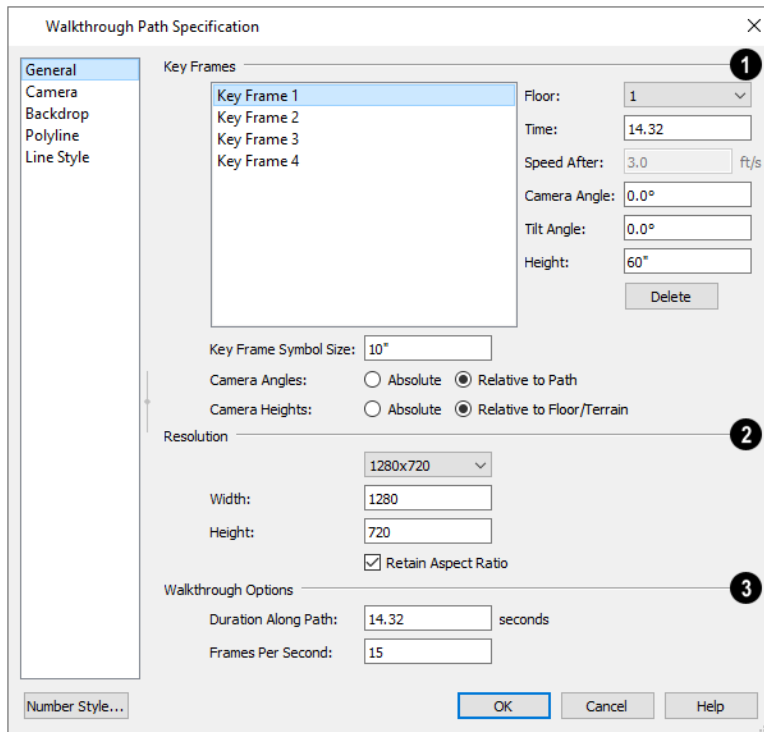

1 Key Frames

A list of the selected path's Key Frames displays on the left. Click on a Frame in the list to select and edit it using the settings on the right. When the dialog is opened, the Key Frame selected in plan view will be selected in the list automatically. See *Key Frames on page 816*.

- Specify the **Floor** that the selected Key Frame is located on. See *Multiple Floors on page 501*.
- Specify the **Time** in seconds at which the selected Key Frame is found in the duration of the walkthrough. The Times of the walkthrough path's first and final frames cannot be moved.
- Specify the **Speed After (ft/s)**, which is how fast the camera moves along the walkthrough path from the current Key Frame to the next. Not available if the last Key Frame is selected.
- Specify the **Camera Angle** at the selected Key Frame.
- Specify the **Tilt Angle** of the camera at the selected Key Frame.
- Specify the **Height** of the camera at the selected Key Frame.
- Click the **Delete** button to remove the selected Key Frame from the path. Key Frames can also be deleted in plan view using the **Delete Key Frame**  edit tool. This option can be used to delete the Start and End Key Frames; however, if only two Key Frames are present it will not be available.
- Specify the **Key Frame Symbol Size**, which is the size of the symbols representing the selected walkthrough path's Key Frames in plan view. See *Key Frames on page 816*.

Specify how the **Camera Angles** associated with each key frame are measured:

- Select **Absolute** to measure the Camera Angles relative to the plan's X and Y axes.
- Select **Relative to Path** to measure the Camera Angles frame relative to the direction of the path at that location.

Note: When Relative Angles are used, a Camera Angle of 0° points in the direction of the Walkthrough Path. When Absolute Angles are used, 0° always points in the positive direction along the X axis.

Specify how the **Camera Heights** associated with each key frame are measured:

- Select **Absolute** to measure camera height relative to the plan's Z axis.
- Select **Relative to Floor/Terrain** to measure camera height relative to the floor or terrain at each Key Frame location.

2 Resolution

Control the size of the selected walkthrough's frames.

- Select a size from the drop-down list. If the Width or Height is modified below, the selected Resolution will be "Custom".
- The current **Width**, based on the selected Resolution, is stated here. If you change this value, the selected Resolution will be "Custom".
- The current **Height**, based on the selected Resolution, is stated here. If you change this value, the selected Resolution will be "Custom".

3 Walkthrough Options

- Specify the **Duration**, or total length of the walkthrough video in seconds.
- Specify the desired number of **Frames per Second**, between 1 and 100. A higher number results in a higher quality recording but also a larger file size.
- In the Walkthrough Path Defaults dialog only, specify the **Video Codec** to use when recording walkthroughs. See [Selecting a Codec on page 826](#).

CAMERA PANEL

The settings on the CAMERA panel let you specify lighting, a Rendering Technique, and more. These settings are also found in the Camera Specification dialog. See [Camera Panel on page 760](#).

BACKDROP PANEL

The settings on the BACKDROP panel are also found in the Camera Specification dialog. See [Backdrop Panel on page 763](#).

POLYLINE PANEL

The POLYLINE panel states the length of the path's **Perimeter**. The **Area** and **Volume** of a walkthrough path will always be described as "Not closed". See [Polyline Panel on page 215](#).

SELECTED LINE/ARC PANEL

The SELECTED LINE panel is available when the selected path is a spline or the selected edge is a line as opposed to an arc. See [Line Panel on page 203](#).

The SELECTED ARC panel is available when the selected path edge is an arc as opposed to a spline or line. See [Arc Panel on page 210](#).

See, too, [Selected Edge on page 142](#) and [Change Line/Arc on page 174](#).

LINE STYLE PANEL

This panel is similar to the LINE STYLE panel in the Line Specification dialog. See [Line Style Panel on page 204](#).

Walkthrough Previews



Depending on the quality settings and length of a Walkthrough Path, it may take a considerable amount of time to record a walkthrough video. The Walkthrough Preview side window allows you to preview part or all of an existing walkthrough path to confirm that it meets your needs prior to actually recording it. Select **View > Walkthrough Preview** to open or close this side window. See [Side Windows on page 16](#).

You can also open or close this side window by selecting a Walkthrough Path and clicking the **Walkthrough Preview**  edit button.

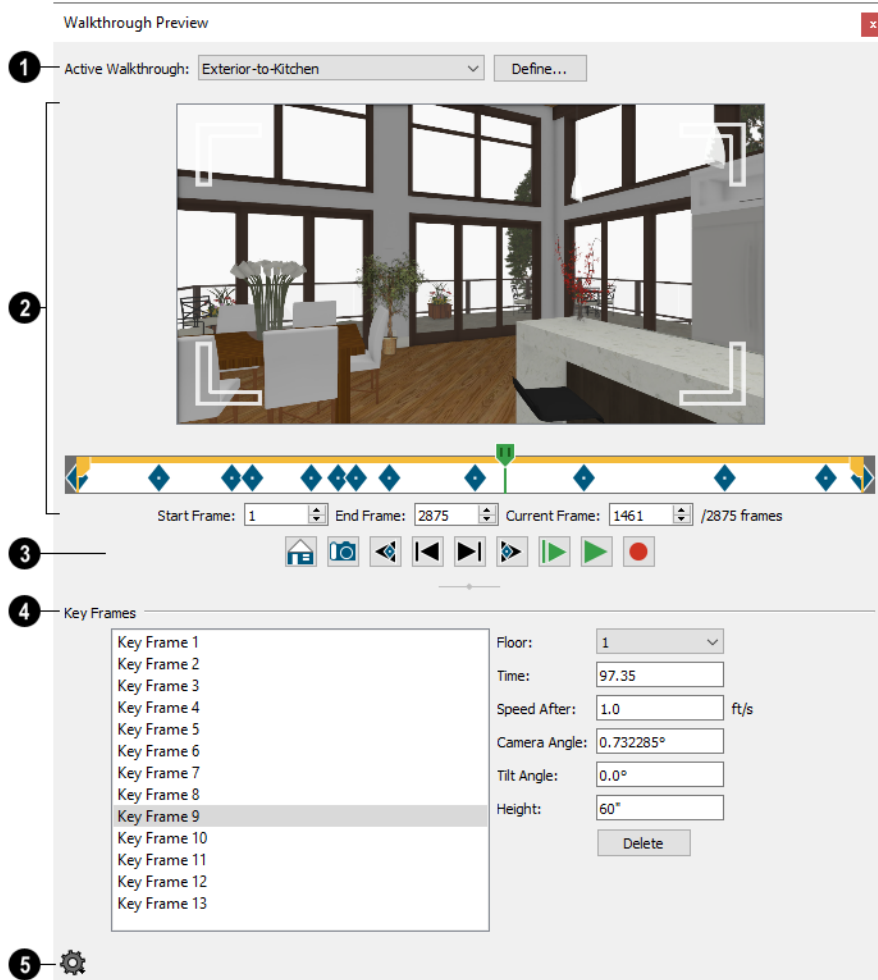

1 Active Walkthrough

Select the walkthrough path that you would like to see in the preview from the drop-down list. All walkthrough paths present in the current plan are listed, and are described using their Label.

- Click the **Define** button to open the selected path's Walkthrough Path Specification dialog. See *Walkthrough Path Specification Dialog* on page 818.

2 Preview

A preview of the selected walkthrough displays here. When a preview is not playing, the Current Frame displays.

- Click and drag in the preview window to adjust the Camera Angle and Tilt Angle of the Current Frame.
- Click and drag the green slider bar to control which frame of the walkthrough displays in the preview pane. You can also click anywhere along the slider to move the bar to that location or use the Current Frame setting, below.
- The yellow bar at the top of the slider indicates the duration of the walkthrough and the location of the Start and End Frames selected below. Click and drag the handles at each end to move the Start and End Frames.
- Blue diamonds along the slider show the location of the selected walkthrough's Key Frames, defined below.
- Specify the **Start Frame** of the walkthrough video. This will be the first frame of the walkthrough video when it is recorded using **Custom Frames to Record**, and is Frame 1 by default. See [Record Walkthrough Along Path on page 823](#).
- Specify the **End Frame** of the walkthrough video. This will be the final frame of the walkthrough video when it is recorded using **Custom Frames to Record**, and is the last frame of the walkthrough path by default.
- Specify the **Current Frame**, which displays in the preview pane above and can also be specified using the slider bar. The Current Frame cannot be located before the Start Frame.

3 Preview Controls



Use Recording Quality shows the preview using the same level of quality as set on the CAMERA panel of the Walkthrough Path Specification dialog. This option is selected by default but may cause slow performance in the preview pane. See [Camera Panel on page 820](#).



Use Standard Quality may improve performance if you encounter slowness in the preview pane. This option shows the preview using without shadows, bloom or reflections. In addition, Watercolor and Physically Based Renderings are shown using the Standard Rendering Technique. This setting is retained during the current program session but is reset when the program is relaunched.



Create Camera View creates a camera view window using the location and angle of the current frame.



Jump to Previous Key Frame moves the preview back one Key Frame. Not available if the Current Frame is located before the Start Frame.



Go to Previous Frame moves the preview back one frame. Not available if the Current Frame is located before the Start Frame.



Go to Next Frame advances the preview ahead one frame. Not available if the Current Frame is located after the End Frame.



Jump to Next Key Frame advances the preview ahead one Key Frame. Not available if the Current Frame is located after the End Frame.



Play Walkthrough Preview from Beginning plays a preview of the walkthrough from the Start Frame through the End Frame.



Play Walkthrough Preview from Current Frame plays a preview of the walkthrough from the Current Frame through the End Frame.



Record Walkthrough records a preview of the walkthrough from the Start Frame through the End Frame.

4 Key Frames

Make adjustments to the selected walkthrough path's Key Frames. These settings are also found in the Walkthrough Path Specification dialog. See [General Panel on page 818](#).

- Click on a Key Frame in the list on the left to select and edit it.
- Specify the **Floor** that the selected Key Frame is located on.
- Specify the **Time** in seconds at which the selected Key Frame is found in the duration of the walkthrough. The Times of the walkthrough paths' first and final frames cannot be moved.
- Specify the **Speed After**, which is how fast the camera moves along the walkthrough path from the current Key Frame to the next, in feet per second. Not available if the last Key Frame is selected.
- Specify the **Camera Angle** at the selected Key Frame.
- Specify the **Tilt Angle** of the camera at the selected Key Frame.



The Camera Angle and Tilt Angle can also be adjusted by clicking and dragging in the preview pane, above.

- Specify the **Height** of the camera at the selected Key Frame. You can specify where the Heights are measured from in the Walkthrough Path Specification dialog, which is accessible by clicking the Define button, above.
- Click the **Delete** button to remove the selected Key Frame from the path.

5 Walkthrough Preview Control Options

Click the Options  button at the bottom of the side window to specify what settings are presented as well as their layout.

- Select **Preview Pane** to toggle the display of the Preview Panel that plays the walkthrough preview or shows the Current Frame
- Select **Key Frame Settings** toggle the display of the Key Frames settings.
- Select **Horizontal Layout** to position the Key Frames settings to the right of the other settings, or select **Vertical Layout** to position the Key Frame settings below the other settings. The side window's shape does not adjust when you switch between layout options, so you may need to resize it by clicking and dragging its edges.

Recording a Walkthrough

There are two approaches to recording a walkthrough of a plan: using a Walkthrough Path, and recording frame by frame, directly from a camera view.

RECORD WALKTHROUGH ALONG PATH

Once a Walkthrough Path has been drawn, you can use it to record a walkthrough video. See [Creating Walkthrough Paths on page 815](#).

To record a walkthrough along a path

1. In plan view, select a Walkthrough Path.
2. Click the **Record Walkthrough Along Path**  edit button.
3. In the Walkthrough Options dialog, specify the desired Quality, Resolution, Rendering Options, and Video Codec, then click OK.

Note: You can specify your preferred settings, including Key Frame Symbol Size, Compression, and Video Codec in the Walkthrough Path Defaults dialog. See [Default Settings on page 54](#).

4. In the Save Video As dialog, specify a name and saved location for your walkthrough file. The available file type will vary depending on the Codec you are using. See [Exporting Files on page 38](#).
5. When you click Save, a camera view will open, showing the progress of the recording.

To cancel the recording as it is being created, press the ESC key on your keyboard.

WALKTHROUGH OPTIONS DIALOG

Most of the settings in this dialog are also found in the Walkthrough Path Defaults dialog.

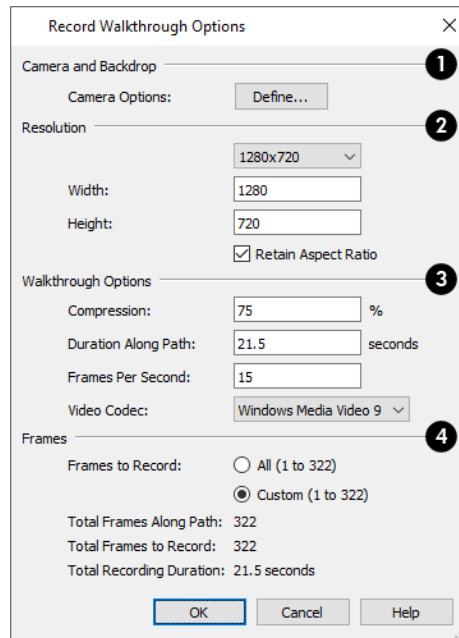

1 Camera and Backdrop

Click the **Define** button to open the Record Walkthrough Camera Options dialog, where Rendering Technique, lighting, backdrop, and more for the current walkthrough can be specified. The settings in this dialog are also found in the Camera Specification dialog. See [Camera Specification Dialogs on page 760](#).

2 Resolution

Specify the size of the walkthrough's frames.

- Select a resolution from the drop-down list. If you modify the Width or Height below, "Custom" will become selected.
- The current **Width**, based on the selected Resolution, is stated here. If you change this value, the selected Resolution will become "Custom".
- The current **Height**, based on the selected Resolution, is stated here. If you change this value, the selected Resolution will become "Custom".
- Check **Retain Aspect Ratio** to retain the original ratio between the frame Width and Height. If you modify either value while this is unchecked, the walkthrough may appear distorted.

3 Walkthrough Options

- Specify a **Compression** percentage between 0 and 100. A value of 0 gives the highest quality images and largest file sizes.
- Specify a **Duration Along Path**, in seconds.
- Specify the desired number of **Frames Per Second**, between 1 and 100. A higher number results in a higher quality recording but also a larger video file.
- Select a **Video Codec** from the drop-down list. See *Selecting a Codec on page 826*.

4 Frames

This setting is retained between sessions and is also global, affecting all walkthroughs in all plan files.

- Specify the **Frames to Record** by choosing either **All** or a **Custom** range, which is set in the Walkthrough Preview side window. See *Walkthrough Previews on page 820*.
- The **Total Frames Along Path**, **Total Frames to Record**, and **Total Recording Duration** display for reference.

When you click OK, the Save Video As dialog will open, allowing you to specify the name, location, and file format for the walkthrough file. The available file formats may vary, depending on which codec you selected.





FRAME BY FRAME WALKTHROUGHS

You can also create a walkthrough by recording it frame by frame. Although time-consuming and lacking many of the options that a Walkthrough Path provides, creating a walkthrough in this manner lets you see exactly what is being recorded as you record it.

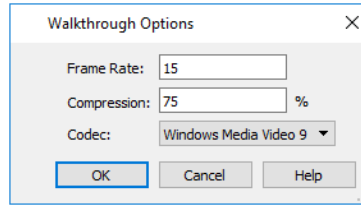
To record a walkthrough frame by frame

1. Create a camera view. This view is the first frame of the walkthrough.
2. While the camera view is active, select **3D> Walkthroughs> Record Walkthrough** .
3. In the Walkthrough Options dialog:



- Select a **Frame Rate** between 1 and 100. The value entered is the number of frames per second.
 - Select a **Compression Percent** between 0 and 100. A value of 0 gives the highest quality images and the largest file size.
 - Select a **Codec** from the drop-down list. See *Selecting a Codec on page 826*, below.
 - Click **OK**.
4. In the Save Video As dialog, specify the name, location, and file format for the walkthrough file, then click **Save**. The available file formats will vary, depending on the codec you selected.
 5. Use the camera movement tools to navigate the view. Each time the screen redraws, it is recorded as the next frame in sequence. See *Editing 3D Views on page 754*.
 6. To move the camera without saving a view, select **3D> Walkthroughs> Pause Recording**  to temporarily stop recording.
 - You can then select **3D> Walkthroughs> Save Frame**  button to control what views are saved.
 - You can start recording again by selecting **Pause Recording**  once more.
 7. When the walkthrough sequence is complete, select **3D> Walkthroughs> Stop Recording**  or close the view.

Note: Zooming in and out and using the scrollbars does not change the viewpoint and does not produce a frame for the walkthrough.

If you resize the current view window while recording a walkthrough, the program will stop recording.

SELECTING A CODEC

A codec is a utility that compresses and decompresses media files, and is used when both recording and viewing videos such as walkthroughs. When you record a walkthrough in Home Designer, you can choose which of the codecs installed on your system you want to use. This selection is universal and is retained between program sessions: when you choose a codec in the Walkthrough Path Defaults or either Walkthrough Options dialog, it will become selected the next time you open either dialog, even if you do so in another plan.

“Windows Media Video 9” is the default codec in the Windows version and “H.264”, in the Mac version; but any codecs installed on your system will be available to use.

To choose the codec that best suits your needs, it is a good idea to create a test walkthrough using each of the codecs installed on your system to see how well their walkthrough quality and file compression meet your requirements. Note that your choice of codec may affect the file formats in the Save Video As dialog.

For more information about codecs, visit HomeDesignerSoftware.com.

Importing and Exporting

Chapter 33

Importing is the process of opening a file that was produced in a different program in Home Designer. Exporting, on the other hand, is the process of saving information in a Home Designer file to a format that can be read by another program.

Home Designer allows you to import and export a variety of information from and to other applications. This chapter focuses on importing and exporting 2D .dwg/.dxf files and a variety of 3D file formats. Other importing and exporting options are described in the chapters in which those objects or settings are discussed. See *Pictures, Images, and Walkthroughs on page 794*.

TOPICS

Chief Architect Account Login	828
Export Chief Architect 3D Viewer File	828
Import Room Planner File	830
DXF vs DWG File Formats	830
Importing 2D Drawings	831
Import Drawing Assistant	832
Exporting 2D DXF/DWG Files	836
Additional 2D Export Information	837
3D Data Import Requirements	839
Importing 3D Symbols	840
Symbol Specification Dialog	840
3D Symbols and Materials	842
Exporting a 3D Model	843
Export 360 Panorama	844
Export Thermal Envelope Data	845

Chief Architect Account Login

Your online Chief Architect Account allows you to take advantage of a variety of valuable resources including catalog downloads, license management, and technical support. See [Creating a Chief Architect Account](#).

In order to import a drawing from the Room Planner mobile app, you must first log in your Chief Architect cloud account. See [Import Room Planner File on page 830](#).

If you try to do this while you are logged out of your cloud account, the Chief Architect Account Login dialog will open, giving you an opportunity to log in.

You can also log into or out of your online account at any time by selecting **Help> Log in to Chief Architect Account** or **Help> Log out of Chief Architect Account**.

CHIEF ARCHITECT ACCOUNT LOGIN DIALOG

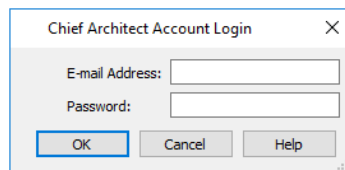

In order to import Room Planner files, you should enter the same **E-mail Address** and **Password** that you used to save the drawing to the cloud in Room Planner.

Export Chief Architect 3D Viewer File



The **Chief Architect 3D Viewer** allows a model created in Chief Architect to be viewed in either:

- A web browser on a computer.
- The 3D Viewer app on a mobile device.

In order to export a Chief Architect 3D Viewer file, you must be logged in to your Chief Architect cloud account.

For more information about the Chief Architect 3D Viewer, visit HomeDesignerSoftware.com.

To export a file to the cloud for viewing with either option, select **File> Export> Export Chief Architect 3D Viewer File**  while a 3D view is active.

Any light sources that are On in the current view, as well as ambient light, will be exported along with the model. See [Lighting on page 772](#).

3D VIEWER EXPORT OPTIONS

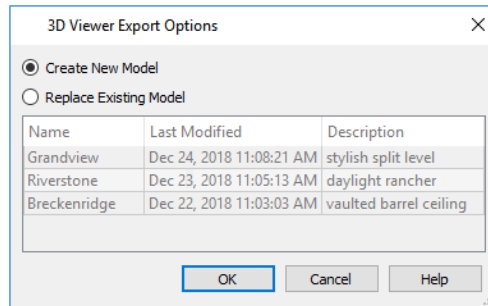

- Select **Create New Model** to export a new model without affecting any previously exported files.
- Select **Replace Existing Model** to select a previously-exported model in the list and replace it with the model being exported now.
- To select an existing model to replace, click on its line item in the list.

When you click OK, the Export 3D Viewer File dialog opens, where you can specify the exported model’s name, description, and other details.

EXPORT 3D VIEWER FILE DIALOG

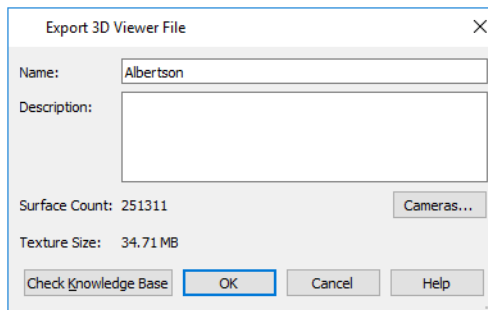

- The **Name** of the current plan file populates this field by default. Specify a different name for the exported 3D Viewer file if you would like.
- Type a brief **Description** of the model.
- Click the **Cameras** button to open the Select Cameras to Export dialog and specify which saved cameras to export with the model. See [3D Views on page 735](#).
- The **Surface Count** and **Texture Size** display here for reference. Large Surface Count and/or Texture Size values can impact performance in the app.

To reduce Surface Count and Texture Size, consider turning off unnecessary layers in the current 3D view before exporting. See [Layers on page 123](#).

When you click OK, the 3D model is exported using the layer settings in the camera view that was active when the model was exported.

On the 3D Viewer page, you can also choose to share an exported model with someone so that it can be opened in a 3D Viewer page or in the 3D Viewer mobile app.

SELECT CAMERAS TO EXPORT DIALOG

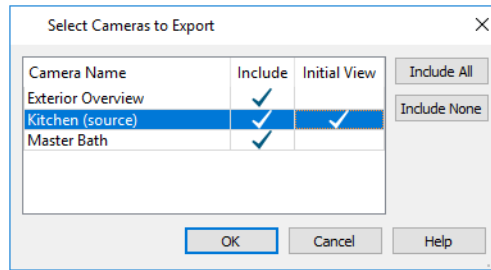

- The **Camera Name** of each saved Perspective Camera and Overview in the plan is listed here. The camera that is active when you export the model, if listed, is followed by “(source)”. Doll House Views can be exported; however, they behave like Full Overviews in the 3D Viewer.
- In the **Include** column, click to add or remove a check mark for each camera that you would like to export. By default, only cameras of the same type, on the same floor, and using the same layer set are Included.
- In the **Initial View** column, add a check mark for the camera that you would like to be active when the model is opened in 3D Viewer.
- Click the **Include All** button to export all saved cameras with the model. A large number of saved cameras may slow down the interface of the 3D Viewer app.
- Click the **Include None** button to export no saved cameras with the model. When the model is opened, an unsaved 3D Overview will be the initial view.

Import Room Planner File



Select **File> Import> Import Room Planner File**, then select and download a Room Planner file from the cloud.

When prompted to log in, use the same credentials you used to save a plan to the cloud in Room Planner. See *Chief Architect Account Login on page 828*.

Files created in Room Planner version 2 and newer can be imported into Home Designer 2022.

Note that the exterior walls in an imported Room Planner drawing will inherit their thickness and other properties from the Exterior Wall Defaults dialog in the current plan, while interior walls will retain the thickness that was set in Room Planner. See *Exterior and Interior Wall Defaults Dialogs on page 224*.

Unless a custom ceiling height has been specified in Room Planner, rooms in an imported file use the Default ceiling height set in the Floor Defaults dialog. See *Floor Level Defaults on page 281*.

By default, window sizes in imported Room Planner drawings are measured from the outside of their frames, just as their Height and Width are in the Window Specification dialog. If you prefer, you can specify that windows are measured from the inside of the frames in the Preferences dialog. See *General Panel on page 66*.

Visit roomplanner.chiefarchitect.com for more information about the Room Planner mobile app.

DXF vs DWG File Formats

.dwg is the native AutoCAD® file format. Originally a proprietary format, it is now widely used with many different products.

.dxf (Drawing eXchange Format) is a standard file format created by Autodesk for the transfer of data between other programs.

Many design programs can read and write **.dxf** and **.dwg** files. Both formats interpret data as CAD objects such as lines, polylines, and circles. Both formats can also contain 3D data which can be imported into Home Designer Pro, as well.

Binary **.dxf** format is another related file format. It is easier for computers to read, is more accurate, and occupies less disk space and regular **.dxf** files. When exporting, however, bear in mind that not all applications support binary **.dxf**.

Importing 2D Drawings

2D drawings are imported by reading entities from a **.dxf** or **.dwg** file and creating the equivalent CAD objects in Home Designer Pro.

Home Designer Pro 2022 can import 2D **.dxf** or **.dwg** files compatible with AutoCAD® through version 2021. See [Import Drawing Assistant on page 832](#).

A **.dxf** or **.dwg** file can be imported into plan view or a cross section/elevation view.

Only drawings created in AutoCAD®'s Model Space can be imported into Home Designer. Entities drawn in Paper Space are not recognized.

External references (xrefs) are not recognized by Home Designer, either.

In general, all Z coordinates are mapped to zero. If an entity in an imported drawing has thickness, Home Designer ignores it.

SUPPORTED ENTITIES

The following is a list of the entities that are imported and how they are converted. All other entities are ignored:

- **Lines** - Both 2D and 3D lines.
- **Circles** - Fully supported in 2D.
- **Arcs** - Fully supported in 2D.
- **Ellipses** - Fully supported in 2D.
- **Spline entities** - Fully supported as 2D polylines.
- **Polylines and Lightweight Polylines** - Polylines are imported as polylines. Bumps are converted to arcs. Line widths are ignored.
- **Lightweight Polylines** - Fully supported in 2D.
- **Points** - Points are not supported unless the layer they are on is converted to Elevation Data. See [Importing Elevation Data on page 876](#).
- **Text and Multi-line Text** - Both are imported as Rich Text and mapped to the Text layer. Multi-line text objects retain their original width. The first font in a multi-line text object is applied to the entire object. If that font is unavailable, Arial is used.
- **Multileaders** - Fully supported in 2D.
- **Unicode** - Fully supported in text objects only.
- **Blocks and Block Inserts** - A block is a named group of CAD entities that have been joined together to behave as a single object. A block insert is a reference to such a block. Blocks are loaded by name. If a duplicate name is found, you can specify whether a block is imported under a new name, replaces an existing block or simply uses the existing block of the same name.

Note: Blocks imported into Home Designer Pro cannot be exploded into their individual component objects. See [CAD Blocks on page 832](#), below.

- **Hatch entities** - If **Import Hatch entities** is selected on the SELECT FILE page of the Import Drawing Assistant for a **.dwg** file, Hatch patterns are imported as a CAD block consisting of solid black filled polylines.
- **2D Solids** (Not ACIS Solids) - Fully supported in 2D.
- **Solids** - A solid is a 3 or 4-sided filled area. These are imported as 2D faces.
- **3D Faces/Polyface Meshes** - A 3D face has its Z coordinate mapped to zero, and imports as a polyline.
- **Dimensions** - Rotated, aligned and 3-point angular dimensions are supported. All other dimension types are imported as lines and text rather than functioning dimensions.
- **Attributes** - Attributes are text objects associated with other items, like blocks. These are imported as text objects at the appropriate location but the association with the original object is broken.
- **Line Styles** - Line styles are not imported. Instead, if a style of the same name displays in the Home Designer line styles, that line style is used. Otherwise, a solid line style is used.
- **Layers**- You can specify which layers in the imported drawing to import into your Home Designer file. See [Layers on page 123](#).

CAD BLOCKS

A block is a group of CAD objects that has been joined together to behave as a single object. Although blocks can be imported into Home Designer Pro, they cannot be exploded and have no specification dialog. They can, however, be selected, moved, and deleted. See [CAD Objects on page 192](#).

Import Drawing Assistant



A 2D **.dxf** or **.dwg** file can be imported into any orthographic view: plan view, cross section/elevation views, and layout. For information about supported entities, model and paper space, and other considerations, see [Importing 2D Drawings on page 831](#).

To import a 2D drawing file, open the view in which you would like to place the drawing and select **File> Import> Import Drawing (DWG/DXF)** to open the welcome page of the Import Drawing Assistant. Click **Next** to continue.

You can also launch the Import Drawing Assistant by dragging a **.dxf/.dwg** file from an operating system window into the Home Designer Pro window.

SELECT FILE

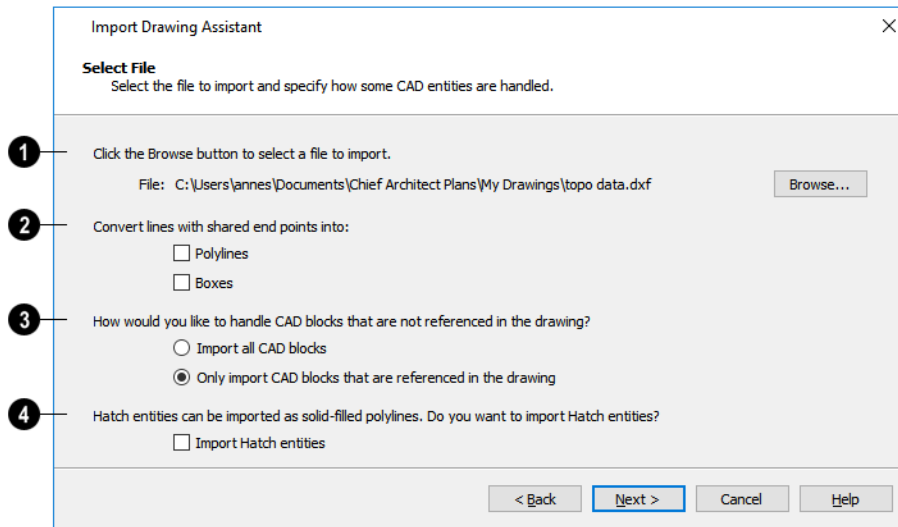

1

Click the **Browse** button to select the file that you wish to import. When a file is selected, its full pathname displays to its left. The directory containing the last file selected using the Import Drawing Assistant displays here otherwise. If the pathname is not a valid dxf/.dwg file, this text will display in red.

Note: If the file you are importing is password protected, you will be prompted to enter the password before continuing.

2

If you want to convert lines with shared end points to polylines and/or boxes, check the appropriate options. Polylines are not affected by these settings, nor are lines that do not share end points.

- Check **Polylines** to import lines with shared end points as polylines.
- Check **Boxes** to import lines with shared end points that form a closed rectangular shape as boxes.

3

Specify how to treat CAD blocks associated with the selected drawing.

- Select **Import all CAD blocks** to include all CAD blocks associated with the file being imported whether or not they are in use.
- Select **Only import CAD blocks if they are referenced in the drawing** to reduce the volume of transferred data.

4

Check **Import Hatch entities** to import areas of hatching as solid-filled polylines.

Click **Next** to load the file into memory so that Home Designer Pro can present information about the contents of the file. This can take a while for larger files.

SELECT LAYERS

In Home Designer Pro, all drawing file layers are mapped to the “CAD, Default” layer. Original layer attributes are lost, but line color, styles, and weight are preserved on a per-object basis.

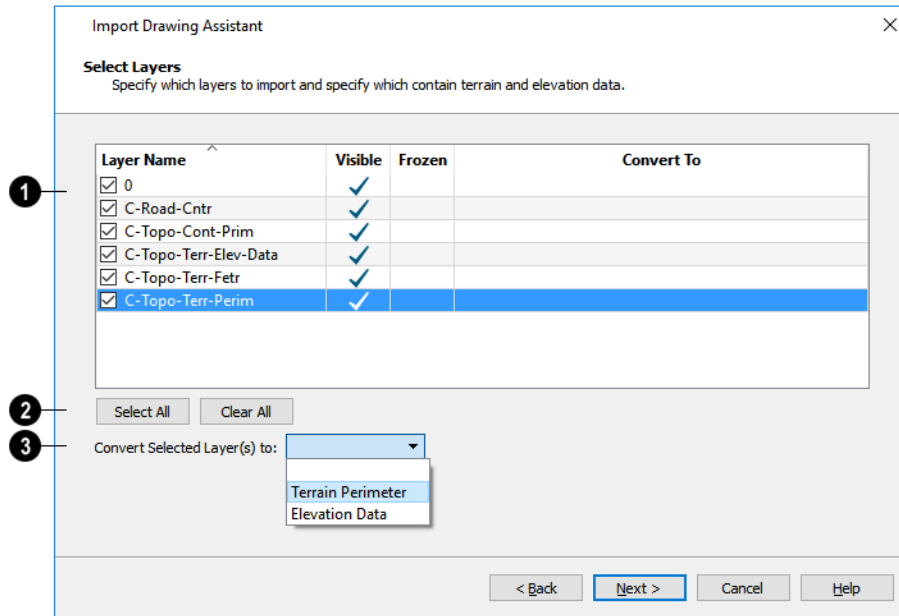

1

A list of the layers found in the imported file and information about each layer displays in this table. See [Layers on page 123](#).

- In the **Layer** column, check the box to the left of each layer name to specify which layers you want to import. Layers with checked boxes are imported; those with unchecked boxes are not.
- Layers that were **Visible** in the original program are checked by default. You can include a layer that is not visible by checking the box to the left of its name.
- Layers that were **Frozen** in the original program are not checked by default. You can include a frozen layer by checking the box to its left.
- If a layer is set to **Convert To** a Terrain Perimeter or Elevation Data, it will be indicated in this column provided that you are importing into plan view.

2

Click **Select All** to check the box to the left of all layer names in the table. Click **Clear All** to clear the checkbox to the left of all layer names in the table.

3

The **Convert To** drop-down list allows you convert the data on any layer into a Terrain Perimeter or Elevation Data. See [Terrain Perimeter on page 847](#) and [Importing DWG/DXF Elevation Data on page 881](#). Only available when importing into plan view.

To convert a layer to a Terrain Perimeter or Terrain Data, click on its name in the table and then select an option from the **Convert To** drop-down list. The option you choose will then display in the **Convert To** column in the table.

Note: If an open polyline is converted into a Terrain Perimeter, the program will draw an additional edge to close the gap.

DRAWING UNIT

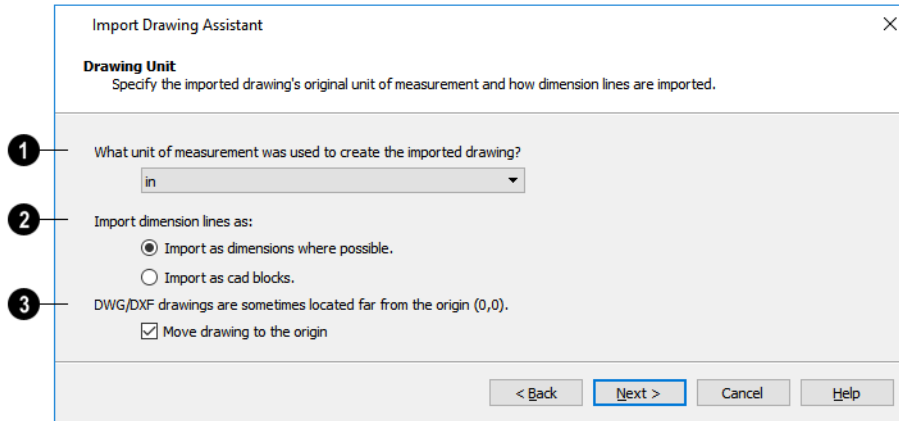

1

Select a unit of measurement from the drop-down list. Selecting the correct unit helps ensure that your imported drawing is accurately sized.

Note: During the import process, Home Designer Pro defaults to inches or millimeters. If you are importing a site plan or topo prepared by a surveyor, or importing a metric drawing into an imperial plan (or vice versa), you may need to change units.

If the file being imported was drawn at a scale other than 1:1, you can compensate for this scaling by creating a custom unit of measurement and specifying it here. See [Unit Conversions Panel on page 71](#).

2

Specify how dimensions are imported.

- Select **Import as dimensions where possible** to import dimensions as Home Designer-supported dimension lines.
- Select **Import as CAD blocks** to import dimensions as CAD entities that are not recognized by Home Designer as dimensions.

3

Check **Move drawing to the origin** to place the drawing at 0,0. When this is unchecked, it is imported to the same location as it was drawn in the original application. See [3D Drafting on page 11](#).

IMPORT COMPLETE

When a **.dxf/.dwg** file is imported into Home Designer Pro, all of its components are selected as a group. The selection set has Move and Rotate edit handles available for relocating the entire drawing, as well as a variety of edit tools. Once another object or tool is selected, the drawing components are no longer group-selected.

If you do not see your imported drawing, select **Window> Fill Window** , as it may have been placed at a location not currently visible on screen. When the drawing can be seen, move your mouse pointer over it and note its coordinates in the

Status Bar. If any coordinate value has more than six digits, use the **Transform/Replicate Object**  edit button to move it closer to the origin. See *Transform/Replicate Object Dialog on page 180*.

Imported CAD objects can be selected and edited just like objects that were drawn in the program. See *Editing Objects on page 136*.

Exporting 2D DXF/DWG Files

Line-based 2D files can be exported from Home Designer in both **.dxf** and **.dwg** file formats. You can specify the version of AutoCAD® to export to. Compatibility with other software may vary.

There are two ways to export a 2D drawing file in Home Designer: Export Current View and Export All Floors.

EXPORT CURRENT VIEW



To export the currently active plan view or 3D view, select **File> Export> Current View (DWG/DXF)**.

Bear in mind that Orthographic views are drawn to scale and will produce a 2D drawing that can be accurately dimensioned. Perspective views, on the other hand, are not scaled and do not produce drawings that can be dimensioned accurately. See *Perspective and Orthographic Views on page 736*.

EXPORT ALL FLOORS



To export the plan view for all floor plans simultaneously, select **File> Export> All Floors (DWG/DXF)** from any floor of the plan. The floor plans are exported to a single **.dxf** or **.dwg** file.

If you choose to export all floors, the file will contain all floors superimposed on each other. Upon export, each layer in your Home Designer drawing is divided into separate layers: one for each floor. For example: “Electrical-2” contains objects on Floor 2 that were originally on the “Electrical” layer.

EXPORT DRAWING DIALOG

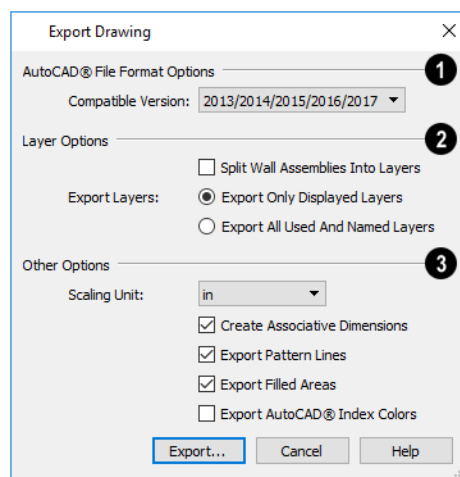

1 AutoCAD® File Format Options

.dxf and **.dwg** files created by Chief Architect can be compatible with a variety of AutoCAD® versions. Specify which version from the drop-down list.

2 Layer Options

The **Layer Options** settings allow you to control the layers associated with the file being exported. See *Layers on page 123*.

- **Split Wall Assemblies Into Layers** - The lines that represent wall layers can be exported onto different layers, allowing them to be displayed separately. See *Wall Type Definitions on page 256*.
- Select **Export Only Displayed Layers** to export only those layers that are displayed on screen. This is what always occurs when exporting from layout, but is not an available option in layout files.
- Select **Export all used and named layers** to export all layers that either have something on them or have a layer name specified. Not available in layout files.

3 Other Options

- **Scaling Unit** - Select the unit of measurement to be used. For best results, choose inches or feet for Imperial plan or layout files, or metric units for metric files. See *Dimension Preferences and Defaults on page 312*.
- Uncheck **Create Associative Dimensions** to export dimensions as simple CAD entities that are not recognized dimensions by other programs. Associative dimensions are recognized by AutoCAD® and many other CAD programs.

When exporting a layout page, it is often best to uncheck this box.

- Check **Export Pattern Lines** to export pattern lines. Pattern lines are exported as normal CAD lines.
- Check **Export Filled Areas** to export filled areas as AutoCAD® 2D solid entities.

Dimension lines using non-default formatting will lose their changes and will use the default format upon export.

When you are satisfied with your selections, click the **Export** button to save the exported file as either a **.dwg**, **.dxf**, or **binary .dxf** file.

Note: Binary .dxf is easier for computers to read, is more accurate, and occupies less disk space, but some applications do not support binary .dxf.

Additional 2D Export Information

The export process converts high level Home Designer objects (doors, windows, etc) into simple, CAD-based objects (lines, arcs, etc). Home Designer exports all data to AutoCAD®'s Model Space.

SUPPORTED ENTITIES

The following entity types are currently supported for 2D export:

- **Line** - The simplest entity. In AutoCAD®, lines are 3 dimensional with the Z coordinate set to zero.
- **Arc** - Arcs have a start angle, end angle and radius.
- **Circle** - Fully Supported.
- **Multi Line Text** - If exporting to an AutoCAD® release that supports multi-line text, Home Designer writes the file as multi-line text. If exporting to a version that does not support multi-line text, the file is written as simple text.
- **Unicode Text** - Fully supported.

- **Polylines** - Polylines are a collection of points with lines or arcs connecting them. Home Designer supports both lines and arcs. Arcs are referred to as bulges in AutoCAD®.
- **Block Insert** - A block insert is a reference to a block, which is a named collection of entities. A block can also contain block inserts.

DIMENSIONS

Aligned, rotated, and angular dimensions can all be exported.

Each dimension has an associated block containing a representation of the dimension as it is drawn in Home Designer. It also contains all the data to recreate that information.

- When an exported dimension is modified in AutoCAD® or other CAD program, its appearance changes.
- Home Designer does not support arrowhead styles or fonts.
- Three kinds of dimensions are generated: Aligned, Rotated and 3 Point Angular.
- Please refer to AutoCAD® documentation for more information.

Note: Uncheck “Use Associative Dimensions” in the Export Drawing File dialog if the CAD program you are using does not support AutoCAD® Associative dimensions. See [Export Drawing Dialog on page 836](#).

LAYERS

Layers in other systems are similar to Home Designer layers, but there are some subtle differences. Layer information is mapped as follows:

Home Designer	Other Systems
Name	Name
Color	Nearest AutoCAD® Color. Home Designer uses the default AutoCAD® color table to determine this mapping.
Display	On
Size	Line Weight. In AutoCAD®, line weights are determined by a table of mm line widths. Home Designer maps to the closest match in this table based the current view’s Line Weight Scale. See Drawing Sheet Setup Dialog on page 943 .
Style	Line type
Lock	Lock

LINE TYPES

A line type, or line style, is used by layers and entities to determine how lines are drawn. Home Designer line types installed with the program are supported on export.

3D Data Import Requirements

Importing a symbol that can be used by Home Designer is a relatively simple process that begins with previously created 3D data. This 3D data often comes from a program other than Home Designer. If you use another 3D modeling program to create the 3D data, be aware of the following requirements before attempting to create symbols.



Chief Architect does not provide support for any third party software.

There are a number of requirements that must be met before any 3D data can be used to create a symbol in Home Designer Pro:

- The 3D data must be stored in a standard Drawing Exchange File (.dxf), AutoCAD® Drawing (.dwg), object (.obj), 3D Studio® Mesh (.3ds), stereolithography (.stl), COLLADA (.dae), or SketchUp version 2021 and prior (.skp) file format. If you have 3D data in another format, you must convert it into one these formats first.
- Geometry and material information stored in .3ds files are imported; cameras and lights are not.
- The 3D model must be composed of 3D DWG or 3DSOLID solid entities, or face data. Faces are typically referred to as 3D faces, polygonal faces, or poly meshes. Other types of entities such as lines, curves, circles, polylines, and free form surfaces can exist in the file but are not imported when the symbol is created. This is true for all (.dxf/.dwg/.obj/.3ds/.skp) file types.
- The face data should be assigned to different layers so that you can map them to the correct materials when viewing them in 3D. It is helpful to name your layers using a convention that identifies that materials should be assigned to each sub-component.
- Pay attention to the origin and orientation of the 3D data when designing symbols. Home Designer allows some adjustment when creating the symbol, but it is easier to build the 3D data correctly before importing it into Home Designer. For more information about defining the origin, see [Symbol Origin](#).
- If a symbol with faces that have more than four vertices is imported, the faces are truncated, resulting in an object that appears to have holes. The best remedy is to re-export the model from the original application using only triangular or quadrilateral faces.
- Home Designer does not support grouped objects in symbols imported from .3ds files.

SURFACE NORMALS

If you use third party software to create a .dxf/.dwg/.obj/.3ds/.skp file that will be imported as a symbol, you should be familiar with the concept of surface normals.

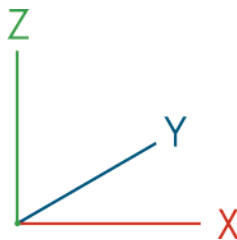

A surface normal is a vector that is perpendicular to the plane of a surface. This vector points in one direction, determined by the way the face is drawn.

If a face is drawn clockwise, the surface normals are directed outward; if a face is drawn counter-clockwise, the surface normals point inward. Home Designer assumes that the face on the positive side of the normal vector is the outside face.

Many objects can be drawn using only one side of each face. A cube is a good example: the inside of a cube is not visible, so it is not necessary to create its inside faces. When inside faces are not calculated, 3D views in Home Designer can generate more quickly.

Importing 3D Symbols



Home Designer Pro supports the import of 3D surface and 3D solid objects saved in **.dwg**, **.dxf**, **.3ds**, **.obj**, **.stl**, **.dae**, and **.skp** formats. See [3D Data Import Requirements on page 839](#).

For most file types, there are three ways to import a 3D symbol into Home Designer Pro:

- By selecting **File> Import> Import 3D Symbol**.
- By selecting **New> 3D Symbol** from the contextual menu in the Library Browser. See [Using the Contextual Menus on page 673](#).
- By dragging and dropping the file from an operating system window into plan view.

3D **.dxf/.dwg** files can only be imported by selecting **File> Import> Import 3D Symbol**.

Symbols imported by clicking and dragging are imported for use in the current plan, while those imported using the Import 3D Symbol dialog can also be saved in the library. See [The Library on page 668](#).

To drag and drop a 3D symbol file

1. Open the plan in which you would like to import a 3D symbol and remain in plan view.
2. Open an operating system window in front of the Home Designer program window.
3. Resize and position the window so that the Home Designer program window can be seen behind it.
4. Click on the desired **.3ds**, **.obj**, **.stl**, **.dae**, or **.skp** file and drag it into the Home Designer program window.
5. When your cursor changes to a +, click in the drawing area to place as many copies of the symbol as desired. When you are finished, select a different tool.

Symbols imported by clicking and dragging cannot be edited in the Symbol Specification dialog. If a symbol needs to be rotated, or its unit of measurement specified, use the **Import 3D Symbol**  tool to import it.



If the symbol you are importing has a high surface count, it may impact program performance. When this is a possibility, the program will warn you and present you with an option to cancel the import operation.

Symbol Specification Dialog

To import a symbol object, select **File> Import> Import 3D Symbol** .

Home Designer Pro supports the import of 3D surface and 3D solid objects saved in **.dxf**, **.dwg**, **.obj**, **.3ds**, **.stl**, **.skp** and **.dae** file formats. When imported, these symbols are treated as stand-alone fixtures.

The Import 3D Symbol File dialog, which opens first, is a typical Open File dialog in which multiple files can be group-selected for import. See [Importing Files on page 42](#).

3D PANEL

The options on the 3D panel primarily affect the symbol's appearance in 3D views.

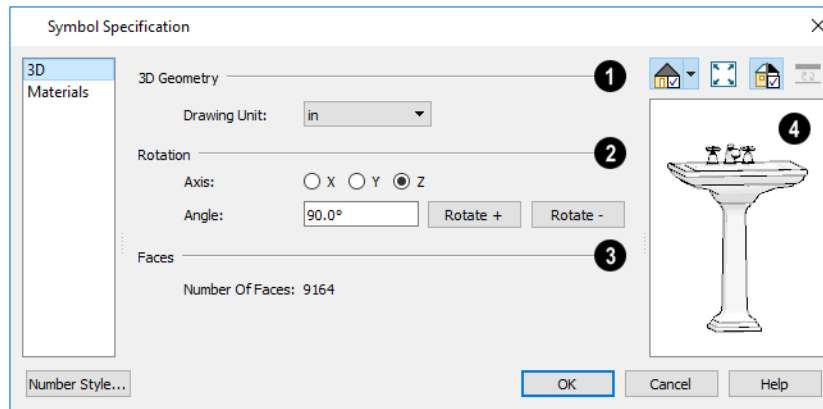

1 3D Geometry

- Select the **Drawing Unit** that was used to create the symbol. If any units other than inches or mm are selected, the program will convert the data into units appropriate for Home Designer. To apply a change to this setting, you must also click the Browse button and reload the symbol data from the original file.

Note: SKP files are always imported using inches, regardless of the default units used in the plan file.

2 Rotation

These settings allow you to rotate the selected symbol(s) about the X, Y, and Z axes. Note that rotating a symbol will affect the location of its top, bottom, front, and /or back - and thus the location of its default origin. It may affect the size of the bounding box, as well; however, it does not affect the bounding box's orientation. See [Bounding Boxes](#).

- Select the **X, Y, or Z Axis** that you wish to rotate the symbol about.
- Specify the **Angle** to rotate the symbol in the text field. 90° is set by default.
- Click the **Rotate +** button to rotate the symbol around the selected axis in a clockwise direction.
- Click the **Rotate -** button to rotate the symbol around the selected axis in a counterclockwise direction.

3 Faces

- The **Number Of Faces** that a selected symbol has displays here for reference. When multiple symbols are being imported, nothing displays. Although there is no limit to the number of faces, large numbers can increase rendering time significantly.

4 Preview

A preview of the symbol's appearance displays here and updates as changes are made to the settings in this dialog. When multiple symbols are selected, the most recently selected symbol displays. See [Dialog Preview Panes on page 20](#).

MATERIALS PANEL

The MATERIALS panel allows you to assign materials to the symbol's components and is similar to the Materials panel in many specification dialogs. See [Materials Panel on page 716](#).

If the selected symbol is in the process of being imported, bear in mind that **.dxf/.dwg** files do not include material information, so the symbol's components will not have materials assigned to them. See [3D Symbols and Materials on page 842](#).

3D Symbols and Materials

When a symbol is imported into Home Designer, material definitions may be included with it. Whether and how material information is included depends on the symbol's file format. See [About Materials on page 712](#).

DXF/DWG and STL Files

.dxf/.dwg and **.stl** files do not include information about material definitions. When imported, default materials for interior fixtures will be assigned.

OBJ Files

Material definitions for most **.obj** files are saved in a separate file with the **.mtl** file extension. If such a file exists, the materials associated with the **.obj** file display in the list on the left side of the MATERIALS panel of its specification dialog.

If Home Designer does not receive material definition information in an accompanying **.mtl** file, default material properties are assigned.

Material definitions for **.obj** files can also include texture information in the form of image files (**.jpg**, **.png**, etc).

In order to properly import an **.obj** file, Home Designer needs the **.obj** file, the **.mtl** file, and any referenced texture files. If a texture file is not available, the material it is associated with is created without a texture.

The material definitions associated with an imported **.obj** symbol are not available for use by other objects in Home Designer until that symbol has been placed into a plan. The associated texture files are then copied to the user's Textures folder. See [Home Designer Pro Data on page 33](#).

3DS and DAE Files

Material definitions for **.3ds** and **.dae** files refer to texture information in separate image files.

In order to properly import a **.3ds** and **.dae** file, Home Designer needs these referenced image files. If a texture file is not available, the material it is associated with will be created without it. The associated texture files are copied to the user's Textures folder.

SKP Files

The textures associated with a **.skp** file are saved in the file. After you import a symbol and either place it in a plan or add it to the Library, these textures are saved in the user's Textures folder.

Home Designer does not support deformed textures. If a texture associated with a **.skp** file is deformed, it will be imported without the deformations.

TEXTURE FILENAME CONFLICT

If a texture of the same name already exists in the plan when an **.obj**, **.3ds**, or **.skp** file is imported, the Texture Filename Conflict dialog displays.

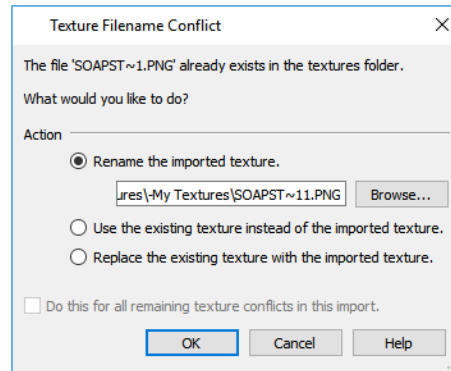

- Select **Rename the imported texture**, then click the **Browse** button to create a copy of the texture’s image file with a new name that you specify.
- Select **Use the existing texture instead of the imported texture** to keep the existing texture.
- Select **Replace the existing texture with the imported texture** to replace the texture already present in the plan with the new, imported one.
- Check **Do this for all remaining textures in this object** to use the same selection for all textures with filename conflicts associated with this symbol.

Exporting a 3D Model

The entire 3D model, or any part that you choose, can be exported from Home Designer into either of two formats:

- *DAE Format on page 843*
- *STL Format on page 844*

To export a 3D model

1. A camera view or overview must be active. See *Types of 3D Views on page 736*.
2. Make sure that everything that you want to export is set to display in the current view, and everything you do not want to export is not set to display. See *Layers on page 123*.
 - Any surfaces removed using the **Delete Surfaces**  tool will not be exported. See *Displaying 3D Views on page 747*.
3. When the model is ready, select **File> Export>** and choose the file format that you want to use.
4. Give the file a name, making sure to save it in the desired location. See *Exporting Files on page 38*.

DAE FORMAT



A **.dae** file can be opened by any program that uses COLLADA™’s **.dae** format. When the model is ready, select **File> Export> 3D COLLADA Model** to export to this format.

The Export COLLADA Model dialog is a typical File Save dialog.

Any light sources that are On in the current view, as well as ambient light, will be exported to a **.dae** file along with the model. See *Lighting on page 772*.

Any material textures used in the model are saved as image files in a folder in the same location as the saved **.dae** file. The folder has the same name as the **.dae** file, appended with “_textures”.

STL FORMAT

 An **.stl** file can be opened by any program that uses Stereolithography format, and can be printed using a stereolithography machine, or 3D printer. When the model is ready, select **File> Export> 3D Model (STL)**.

The Export STL Model dialog is a typical File Save dialog.

A 3D model exported to an **.stl** file does not include any material or texture information.

Export 360 Panorama

 The **Export 360 Panorama** tool creates a spherical panoramic image that can be opened in various panorama viewers. Select **File> Export> Export 360 Panorama** while a 3D view is active to access this tool.

For best results, position the camera as near as you can to the center of the scene before exporting.

EXPORT 360 PANORAMA FILE

All of the settings in this dialog are retained during the current program session.

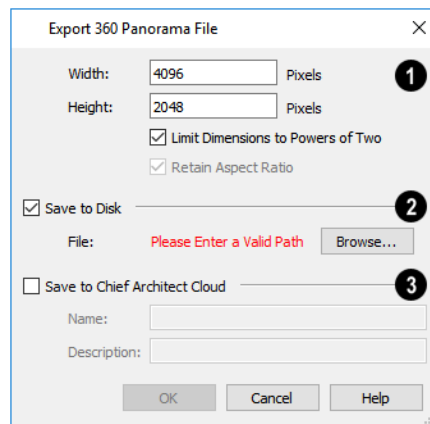

1

Specify the size of the exported image, in pixels.

- Specify the **Height** and **Width** of the exported image file, in pixels.
- Check **Limit Dimensions to Powers of Two** to restrict the Width and Height to values that are powers of two. When this is checked and an ineligible value is entered, it will adjust up or down to the nearest power of two. Although not required, this option is recommended for best results in some panoramic image viewers.
- The **Retain Aspect Ratio** check box displays for reference and cannot be changed. The ratio between Width and Height is 2 to 1 when Limit Dimensions to Powers of Two is unchecked, above.

2

Save to Disk

Check **Save to Disk** to save the exported panoramic image file on the local computer system.

- Specify the full pathname of the **File** you wish to export, or click the **Browse** button to open the Export 360 Panorama File dialog, which is a typical File Save dialog. See [Exporting Files on page 38](#).

3 Save to Chief Architect Cloud

Check **Save to Chief Architect Cloud** to save the exported panoramic image file to your Chief Architect Cloud Account. See [Chief Architect Account Login on page 828](#).

- Type a short, descriptive **Name** for the exported panoramic image file.
- Type a brief **Description** of the file.

When you click OK, a panoramic image is created and a progress dialog may display. Because spherical panoramas are composed of multiple images stitched together, they may take longer to create than a standard exported picture.

Note: You can also upload a previously saved panoramic image file to the cloud on the 360 Panoramas page of your online account.

Export Thermal Envelope Data

A thermal envelope is a three dimensional boundary built around a structure's conditioned space that separates it from the unconditioned space around it. Thermal Envelopes are composed of floor platforms, ceiling platforms, walls, doors, and windows. You can export information about the thermal envelope of the current plan by selecting **File> Export> Thermal Envelope Data**. This data is organized by floor level; notes the direction of walls, doors, and windows; and reports the area of each envelope component.

Thermal Envelope Data is exported to a comma delimited **.csv** text file which can be opened in a text editor or spreadsheet application. Once exported, it will automatically open in the application associated with **.csv** files on your system.

Terrain

Chapter 34

Home Designer Pro allows you to model the terrain around a house. Begin by specifying elevation data that creates the surface contours, and then add surface features such as planting areas and water features in level terrain around your house plan.

You can import terrain data from a variety of sources and use this data to produce your 3D model.

Once the terrain is modeled, shadows that follow the terrain can be created using the Sun Angle tool. See *Sun Angles and Shadows on page 778*.

Driveways, parking lots, and sidewalks as well as plants and sprinklers are among the objects that can be placed in your terrain and are discussed in *Plants and Sprinklers on page 889* and *Roads, Driveways and Sidewalks on page 883*.

TOPICS

Terrain Toolbar Configuration	847
Terrain Perimeter	847
Elevation Data Tools	849
Terrain Modifier Tools	854
Terrain Feature Tools	855
Garden Bed Tools	856
Water Feature Tools	857
Stepping Stone Tools	858
Terrain Wall and Curb Tools	858
Sun Shadows	859
Terrain Objects in the Library	859
Displaying Terrain	860
Editing Terrain Objects	861
Terrain Specification Dialog	861
Elevation Point Specification Dialog	865
Elevation Line/Region Specification Dialog	866
Flat Region Specification Dialog	868
Hill / Valley Specification Dialog	868
Raised / Lowered Region Specification Dialog	869
Terrain Feature Specification Dialog	869
Garden Bed Specification Dialog	871
Terrain Break Specification Dialog	874
Terrain Path Specification Dialog	874
Importing Elevation Data	876
Import Terrain Assistant	877
Import GPS Data Assistant	879
Importing DWG/DXF Elevation Data	881
Converting CAD Objects to Terrain Data	882

Terrain Toolbar Configuration



The Terrain and Road Tools can be accessed through the Terrain menu. You can also display these tools on your toolbar using the **Terrain Configuration**. See *Toolbar Configurations on page 91*.

The Terrain Configuration and Terrain menu both display the following Terrain, Road, Plant, and Sprinkler parent tools:



Elevation Data Tools on page 849 allow you to add elevation data to your terrain.



Terrain Modifier Tools on page 854 model changes in elevation within a defined area.



Terrain Feature Tools on page 855 let you add materials over the top of the terrain.



Garden Bed Tools on page 856 create Terrain Features with a mulch material.



Water Feature Tools on page 857 create Terrain Features with a water material.



Stepping Stone Tools on page 858 are used to create paths composed of multiple Terrain Features.



Terrain Wall and Curb Tools on page 858 let you draw walls and curbs that follow the terrain.



Road, Driveway, and Sidewalk Tools on page 884 allow you to create paved areas that can form intersections.



Plant Tools on page 890 allow you to place plant images and 3D plant symbols.



Sprinkler Tools on page 897 are used to lay out sprinkler symbols and irrigation lines.

Terrain Perimeter



The Terrain Perimeter is a closed polyline defining the boundary of the terrain that generates in 3D views and of the contour lines that generate in plan view. Select **Terrain> Create Terrain Perimeter** to create a terrain perimeter.

A CAD polyline can also be converted into a terrain perimeter. See *Editing Terrain Objects on page 861*.

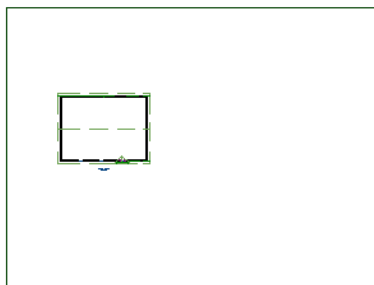



If you create a terrain perimeter in plan view but do not see it, select **Window> Fill Window** . See *Zoom Tools on page 106*.

When created in a new, blank plan, a new terrain perimeter will be 50' x 100'. If you create a terrain perimeter after you have drawn all or part of a 3D model, it may increase in size as needed to encompass everything in plan view.

Once created, the terrain perimeter can be resized and edited like other polyline-based objects. See [Editing Closed Polyline-Based Objects on page 155](#).

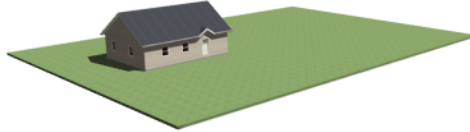
When a terrain perimeter is first created, it is completely flat and is placed at a height of 0'-0", or sea level.



The terrain perimeter by itself does not have elevation data associated with it. You can use the **Elevation Data**  and **Terrain Modifier**  tools to create terrain that slopes in a wide variety of ways. If you do not create elevation data within the terrain perimeter, the terrain remains flat at an elevation of 0' - 0". See [Elevation Data Tools on page 849](#) and [Terrain Modifier Tools on page 854](#).

The Terrain Perimeter has a variety of editable properties, including many that affect the appearance of the terrain in 2D and 3D views. See [Terrain Specification Dialog on page 861](#).

PLOT PLANS

Using the CAD drawing and editing tools, you can create an accurate plot plan of any building site.

TERRAIN HEIGHT VS FLOOR HEIGHT

Home Designer always defines the default height of Floor 1 at 0'-0". This height value is the constant by which the heights of structural elements in the program like walls, floors, and ceilings are measured. The heights of architectural object can be measured relative this absolute height, as well. See [Floor 1 Default Height on page 281](#).

The default height of Floor 1 is not, however, the absolute by which terrain elevation is measured. Instead, elevation data is measured relative to sea level. This means that if you want to, you can use real-world elevation data to generate a 3D terrain model without also having to measure floor and ceiling heights from sea level. See [Importing Elevation Data on page 876](#).

The program automatically positions Floor 1 a set distance above the terrain. To do this, it first calculates the average elevation of the building footprint's perimeter and then assigns that average elevation to the center point of the building footprint. Finally, it adds the thickness of the floor platform and any sill plates to this value plus either 6" (150 mm) or 8" (200 mm) depending on the foundation type. The resulting value, referred to as the automatic Subfloor Height Above Terrain, is how far the default height of Floor 1 is above sea level in the current plan. See [Foundations and the Terrain on page 491](#).

The Subfloor Height Above Terrain distance is stated and can be modified in the Terrain Specification dialog. You can specify a custom value to produce a daylight or walkout basement. See [General Panel on page 862](#).

BUILD TERRAIN

 Select **Terrain> Build Terrain** to generate the terrain surface based on the elevation data you have provided. Build Terrain also updates the Building Pad Elevation value in the Terrain Specification dialog. See [Building the Terrain on page 860](#).

AUTO REBUILD TERRAIN

By default, terrain will automatically build any time a 3D view is created, ensuring that the terrain in the view is up-to-date. If your terrain is large and/or highly detailed and has not been modified, and you find that this unnecessarily slows down the generation of 3D views, consider turning this behavior off in the Terrain Specification dialog. See [General Panel on page 862](#).

When Auto Rebuild Terrain is turned off, the Auto Rebuild Terrain  icon will follow your mouse pointer. See [Pointer Icons on page 15](#).

CLEAR TERRAIN



To remove the generated terrain contours, select **Terrain > Clear Terrain**. When the terrain is cleared, contours do not display in 3D and contour lines do not display in plan view.

Clear Terrain does not remove the terrain perimeter, elevation data, or terrain features from the model. Rather, it deletes all program-generated 2D contour lines and 3D contours.

TERRAIN SURFACE TRIANGLES

Home Designer generates 3D terrain surfaces by dividing them into triangles. The size of the triangles determines how detailed contour lines and terrain surfaces in the 3D model can be. You can specify triangle size in the Terrain Perimeter Specification dialog. See [General Panel on page 862](#).

Increasing the triangle count decreases triangle size, yielding more detailed contour lines and a better 3D approximation of the terrain. Smaller triangles demand longer terrain generation time and increased memory requirements. If you select a large number of small triangles for a large site, you may wait a long time for the calculation.

Decreasing the triangle count increases triangle size. Elevation lines are sampled less frequently, speeding up terrain generation. If you specify a small number of triangles for a plan with detailed elevation data, contour lines and 3D surfaces may not generate correctly.



When a large terrain perimeter is used, consider increasing the Triangle Count to help make sure all Elevation Data and Terrain Modifiers generate contours.

Elevation Data Tools



Select **Terrain > Elevation Data** to add elevation information to your terrain.

When terrain is generated, this data is used to calculate the surface of your site and is represented by contour lines in plan view and a curved surface in 3D. See [Displaying Terrain on page 860](#).

Elevation data can be specified using the **Elevation Point** , **Elevation Line** , **Elevation Spline** , **Elevation Region** , and **Terrain Break**  tools.

Elevation data can also be imported. See [Importing Elevation Data on page 876](#).

The elevation of each Elevation Line, Spline, and Region is specified relative to sea level.

In order to create rising and/or falling terrain, multiple terrain data objects with different elevation values must be used. If only one terrain data object is placed, the terrain will be flat regardless of the object's specified elevation.

 To avoid unexpected results, do not draw Elevation Data objects with different elevation information at the same location.

ELEVATION POINTS

 An **Elevation Point** contains the absolute elevation data for one point in the terrain model. Typically, Elevation Points are imported rather than placed manually.

Home Designer requires many points to make an accurate approximation of your site. Even small sites may require over a hundred points to generate an accurate model of the terrain if it is sloped. For the sake of illustration, the following example shows only a few elevation points.

To place an elevation point

1. Select **Terrain > Elevation Data > Elevation Point**  and click in plan view at the point where you would like to place elevation data. See [Place Point on page 196](#).
2. The Elevation Point Specification dialog opens. Enter an elevation value and click **OK**. See [Elevation Point Specification Dialog on page 865](#).
3. Click somewhere else in plan view and the Elevation Point Specification dialog opens again with the last elevation value entered.

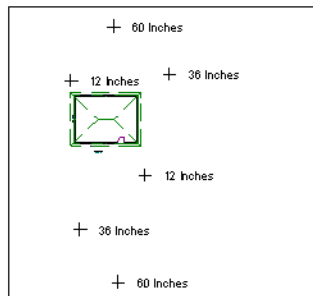

4. Repeat steps 1, 2 and 3 to place additional elevation points with varied elevation values as needed.
5. Select **Terrain > Build Terrain** . See [Building the Terrain on page 860](#).

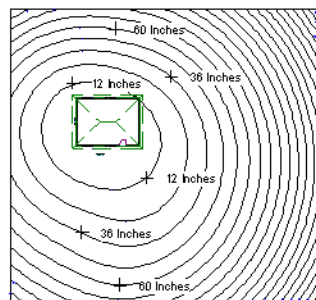



 Elevation Points are most effective when they are imported. When adding elevation data manually, use Elevation Lines and Splines instead. See [Importing Elevation Data on page 876](#).

ELEVATION LINES

¹—
²—
³— An **Elevation Line** contains absolute elevation data for many points along a line at a constant elevation. Elevation lines can be connected to create a polyline with many straight sections. For the sake of illustration, the images in the following example show single-section elevation lines.

To draw an elevation line

1. Select **Terrain > Elevation Data > Elevation Line** , then click and drag a line inside the Terrain Perimeter in plan view.
2. Click on the elevation line to select it, then click the **Open Object**  edit button.
3. At first, an elevation line is at elevation 0' - 0". In the Elevation Line Specification dialog, specify the desired elevation and click OK. See [Elevation Line/Region Specification Dialog on page 866](#).
4. Repeat steps 2 and 3 to draw additional elevation lines as needed.

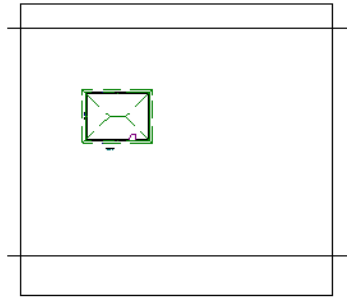

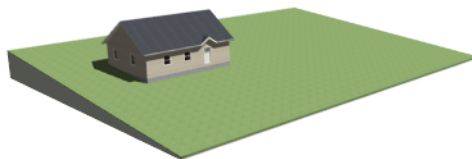
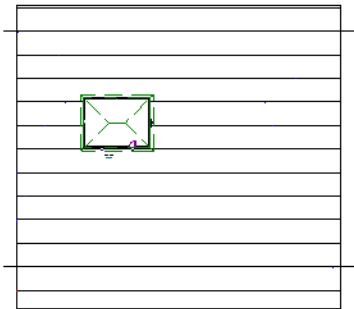

5. Select **Terrain > Build Terrain** . See [Building the Terrain on page 860](#).



After it is drawn, an Elevation Line can be edited much the way other line-based objects can. See [Editing Line-Based Objects on page 145](#).

ELEVATION SPLINES

 **Elevation Splines** can be used to form complex curves and shapes. Like elevation lines, elevation splines contain absolute elevation data for many points along a constant elevation.

To place an elevation spline, select **Terrain> Elevation Data> Elevation Spline**  and click and drag multiple sections in plan view. See [Splines on page 219](#).

Elevation splines are initially placed at elevation 0' - 0" and must be opened and assigned an elevation. See [Elevation Line/Region Specification Dialog on page 866](#).

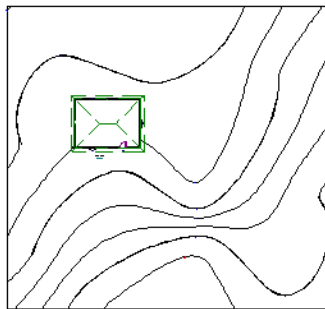
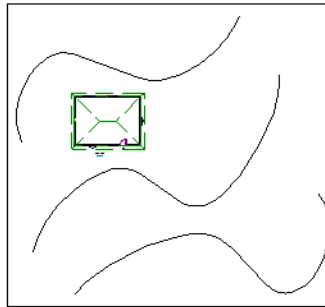

After it is drawn, an Elevation Spline can be edited much the way other spline-based objects can. See [Editing Spline-Based Objects on page 160](#).

ELEVATION REGIONS





An **Elevation Region** contains absolute elevation data for an enclosed region and is ideal for creating a flat surface in your terrain.

Elevation Regions are similar to Flat Regions in that they produce an area with a flat surface; however, they differ in that an Elevation Region affects the contours of the terrain outside of its perimeter and may also have some sloping within its perimeter. See [Flat Regions on page 855](#).

To create an elevation region

1. Select **Terrain> Elevation Data> Elevation Region** .
2. There are two ways to add a Terrain Modifier to your plan:
 - Click once to place an 8' (0.6 m) square feature at that location.
 - Click and drag from end-to-end to draw a feature sized as needed. See [Rectangular Polyline on page 217](#).

1. Click on the region to select it, then click the **Open Object**  edit button.
2. At first, an elevation line is at elevation 0' - 0". In the Elevation Region Specification dialog, specify the desired elevation and click OK. See [Elevation Line/Region Specification Dialog on page 866](#).
 - Click once to place an 8' (0.6 m) square feature at that location.
 - Click and drag from end-to-end to draw a feature sized as needed. See [Rectangular Polyline on page 217](#).
1. Click on the region to select it, then click the **Open Object**  edit button.
2. At first, an elevation line is at elevation 0' - 0". In the Elevation Region Specification dialog, specify the desired elevation and click OK. See [Elevation Line/Region Specification Dialog on page 866](#).

After it is drawn, an Elevation Region can be reshaped much the way other closed polyline-based objects can. See [Editing Closed Polyline-Based Objects on page 155](#).

An **Elevation Region**  can also be created by drawing a closed polyline using **Elevation Lines** .

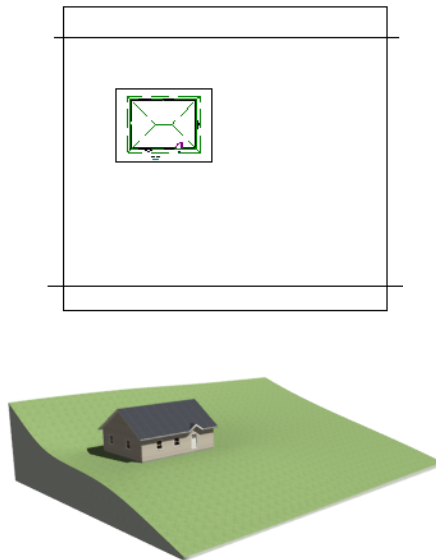



TERRAIN BREAKS

 A **Terrain Break** creates a division along the terrain surface that affects terrain generation. Elevation data on one side of the terrain break does not affect the terrain generation on the other side, allowing you to create immediate drops in terrain.

To place a Terrain Break, select **Terrain > Elevation Data > Terrain Break**  and click and drag a line in plan view.

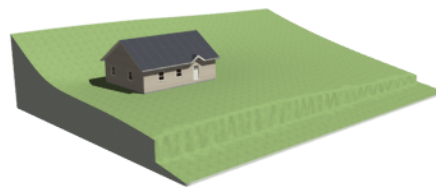
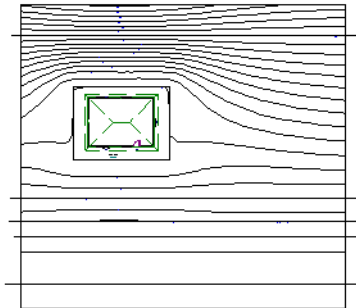
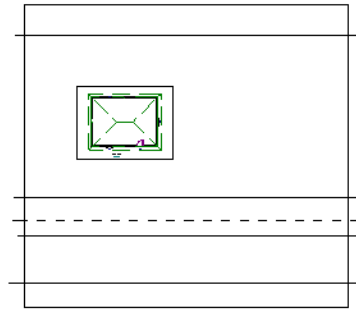
- If the Terrain Break divides the terrain perimeter into two separate pieces, the terrain data on either side is calculated independently and smoothed separately, resulting in sharp terrain contours.
- If the Terrain Break does not extend completely from one side of the terrain perimeter to the other, the areas near each end of the Terrain Break are blended.





The **Retaining Wall**  tool creates a similar effect by drawing a Terrain Break as well as a retaining wall that rests against the break. By default, the top height of the retaining wall matches the terrain on the high side of the break and the bottom matches the low side. See *Terrain Wall and Curb Tools on page 858*.

Terrain Modifier Tools

 Select **Terrain > Modifier** to access tools that allow you to modify the existing elevation data by drawing a closed polyline. Their height is relative to the terrain surface generated from the Elevation Data provided in your plan.

The elevation data associated with a Terrain Modifier only affects the terrain within its perimeter. The rest of the terrain is unaffected.

RAISED AND LOWERED REGIONS

  The **Raised Region** tool creates a raised area with a top surface that is flattened like a plateau but follows the surface of the terrain. The **Lowered Region** tool creates a depression with a bottom that follows the terrain and is flattened.

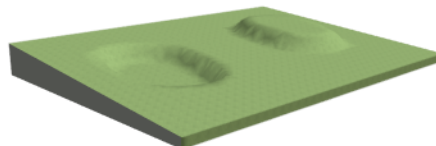

HILLS AND VALLEYS



The **Hill** and **Valley** tools create raised and lowered areas in the terrain that come to a point rather than flattening at their highest or lowest elevations.

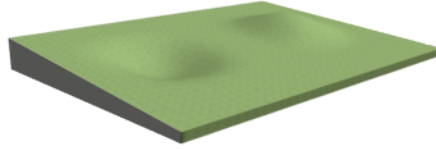

FLAT REGIONS



The **Flat Region** tool creates an area with a surface that is flattened like a plateau but is level rather than following the contours of the terrain.

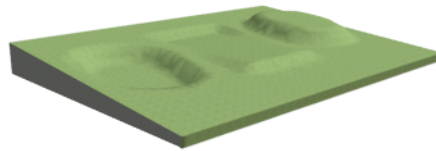

There are two ways to add a Terrain Modifier to your plan:

- Click once to place a modifier with endpoints that form a 10' (4 m) square at that location.
- Click and drag from end-to-end to draw a feature sized as needed. See [Rectangular Polyline on page 217](#).

Terrain Modifiers can only be drawn when a Terrain Perimeter is present, and will only display in 3D when they are drawn within the perimeter. See [Displaying Terrain on page 860](#).

Once created, Terrain Modifiers can be selected and edited in a variety of ways. See [Editing Spline-Based Objects on page 160](#).

Terrain Feature Tools



Select **Terrain > Feature** to access tools for drawing bounded areas that follow the contours of the terrain rather than modifying them.

Terrain Features are useful for creating landscaping features because they have specified heights and materials. You can, for example, create paths and planting beds with gravel or mulch materials that stand out in a grassy Terrain Perimeter.

In fact, **Garden Beds**  are special Terrain Features with material and height attributes already applied to them, saving you time when drawing these objects.

Terrain Features can only be drawn when a Terrain Perimeter is present, and will only display in 3D when they are drawn within the perimeter. See [Displaying Terrain on page 860](#).

Terrain Features can be created in either of two ways:

- Click once to place a feature with endpoints that form a 10' (4 m) square at that location.
- Click and drag from end-to-end to draw a feature sized as needed. See [Rectangular Polyline on page 217](#).

Once created, Terrain Features can be edited into nearly any shape you require. See [Editing Closed Polyline-Based Objects on page 155](#) and [Editing Spline-Based Objects on page 160](#).

 Terrain Features can be drawn in 2D and 3D views.

RECTANGULAR FEATURES

 The **Rectangular Feature** tool can be used to create straight-sided features that can be edited into a wide variety of shapes.

Rectangular Features can also be edited like other closed polyline-based objects. See [Editing Closed Polyline-Based Objects on page 155](#).

SPLINE FEATURE

 The **Spline Feature** tool can be used to create features with rounded edges and smoothly curved corners.

Spline Features can be edited like other closed spline-based objects. See [Editing Spline-Based Objects on page 160](#).

KIDNEY SHAPED FEATURES

 The **Kidney Shaped Feature** tool allows you to quickly create features with curved edges, smooth corners and a right angle bend in its shape.

Kidney Shaped Features can be edited like other closed spline-based objects. See [Editing Spline-Based Objects on page 160](#).

Terrain features can also be converted from closed 2D polylines or splines using the **Convert Polyline** edit tool. See

 [Convert Polyline on page 179](#).

For information about adding height and material information to Terrain Features, see [Terrain Feature Specification Dialog on page 869](#).

TERRAIN HOLES

By default, the program automatically cuts a hole in the terrain around any structures located within and on the same floor as the Terrain Perimeter. The shape of these holes follow the exterior surfaces of the walls and will automatically update if any of those walls are moved.

 A **Terrain Hole** is a Terrain Feature that cuts a hole in the terrain. Using this tool is the same as creating a Terrain Feature and checking **Make Hole** in the Terrain Feature Specification dialog. See [Terrain Feature Specification Dialog on page 869](#).

Terrain Holes are useful for manually clipping the terrain around a foundation that does not match the footprint of the first floor.

Garden Bed Tools

 Select **Terrain> Garden Bed** to access tools that can be used to place garden bed features in your terrain.

Garden Beds are a special type of **Terrain Feature** with material and height attributes typical of planting beds. See [Terrain Feature Tools on page 855](#).

You can specify a Garden Bed's material and height in its specification dialog. See [Terrain Feature Specification Dialog on page 869](#).

In addition, you can choose to distribute copies of a plant image within a Garden Bed. See [Distributed Plant Panel on page 870](#).

POLYLINE GARDEN BED



This tool draws a garden bed with straight sides and four right angles. See [Rectangular Features on page 856](#).

ROUND GARDEN BED



Use this tool to draw garden beds with rounded edges and smoothly curved corners. See [Spline Feature on page 856](#).

KIDNEY SHAPED GARDEN BED



You can draw a kidney shaped garden bed with this tool. See [Kidney Shaped Features on page 856](#).

Water Feature Tools



Select **Terrain > Water Feature** to access tools for drawing ponds and streams in your terrain.

Ponds are basically **Terrain Features** with material and height attributes typical of bodies of water. See [Terrain Feature Tools on page 855](#).

Similarly, Streams are Terrain Curbs with a water material. See [Terrain Wall and Curb Tools on page 858](#).

ROUND POND



Use this tool to draw a pond with rounded edges. See [Spline Feature on page 856](#).

KIDNEY SHAPED POND



This tool draws a kidney shaped pond. See [Kidney Shaped Features on page 856](#).

STREAM



Select the **Stream** tool, then click and drag to draw a stream. Streams are drawn and edited the same way that splines are. See [Splines on page 219](#) and [Editing Spline-Based Objects on page 160](#).

Streams follow the contours of the terrain, so they may appear to flow uphill if they are not drawn correctly in the terrain. Try to draw them so that they follow a downward course for their entire length.

Once drawn, Water Features can be selected and edited just like any other Terrain Feature.

Specify the material and set the height of Water Features in their specification dialogs. See [Terrain Feature Specification Dialog on page 869](#) and [Terrain Path Specification Dialog on page 874](#).

Stepping Stone Tools



Select **Terrain > Stepping Stone** to place a walkway made of individual stepping stones.

Stepping Stones are basically **Terrain Features** with material and height attributes typical of walking paths. See [Terrain Feature Tools on page 855](#).

There are two ways to draw Stepping Stones:

- Click once to place a stepping stone with endpoints that form a 1' (300 mm) square at that location.
- Click and drag from end-to-end to draw a stepping stone sized as needed. See [Rectangular Polyline on page 217](#).

POLYLINE STEPPING STONE



The **Polyline Stepping Stone** tool draws rectangular stepping stones. See [Rectangular Features on page 856](#).

ROUND STEPPING STONE



The **Round Stepping Stone** tool draws stepping stones with rounded edges. See [Spline Feature on page 856](#).

Once drawn, Stepping Stones can be selected and edited just like any other Terrain Feature.

By default, Stepping Stones have a concrete material; however, you can specify the material and set the height of Stepping Stones in the Terrain Feature Specification dialog. See [Terrain Feature Specification Dialog on page 869](#).

Terrain Wall and Curb Tools



Select **Terrain > Terrain Wall and Curb** to draw landscaping walls and curbs that follow the contours of the terrain.

Straight and curved Terrain Walls and Curbs are drawn just as other walls are. See [Creating Walls on page 236](#).

Terrain Walls and Curbs are examples of Terrain Paths. Other examples include Sidewalks and Streams. See [Terrain Path Specification Dialog on page 874](#).

TERRAIN WALLS



Use the **Straight Terrain Wall** tool to draw a wall that sits on top of and follows the terrain.



Use the **Spline Terrain Wall** to draw a curved terrain wall. This wall is drawn the same way as a CAD Spline. See [Splines on page 219](#).

Once drawn, a Terrain Wall can be like other line-based objects. See [Editing Line-Based Objects on page 145](#) and [Editing Spline-Based Objects on page 160](#).

Terrain walls are 5' (1500 mm) high and concrete by default, but you can specify the material, height and more in the Terrain Path Specification. See [Terrain Path Specification Dialog on page 874](#).

RETAINING WALLS

The **Retaining Wall** tools function similarly to Terrain Breaks, but include a wall. See [Terrain Breaks on page 853](#).



Use the **Straight Retaining Wall** tool to draw a straight wall that holds back sloped terrain.



Use the **Curved Retaining Wall** tool to draw a curved retaining wall.

A Retaining Wall's height is determined by the elevation of the terrain on each side. By default, the height of the wall matches the terrain on the high side of the break and the bottom matches the low side. If you insert a Retaining Wall into flat terrain, it looks like a concrete strip in 3D views.

Once drawn, a Retaining Wall can be edited much like other walls. See [Editing Walls on page 244](#).

TERRAIN CURBS

Terrain Curbs are useful for creating curbs around planting beds and along paths.



Use the **Straight Terrain Curb** tool to draw a straight landscaping curb.



Use the **Spline Terrain Curb** tool to draw a curved landscaping curb. This curb is drawn the same way as a CAD Spline. See [Splines on page 219](#).

Once drawn, a Terrain Curb can be like other line-based objects. See [Editing Line-Based Objects on page 145](#) and [Editing Spline-Based Objects on page 160](#).

You can specify the height of straight and spline terrain curbs on the GENERAL panel of the Terrain Path Specification. See [Terrain Path Specification Dialog on page 874](#).



You can also add Fencing to your terrain, complete with gates from the Doors Library. See [Fencing Tools on page 230](#).

Sun Shadows

Sun shadows are generated by the program and represent shadows cast at a particular location on the Earth and at a specific date and time. See [Sun Angles and Shadows on page 778](#).

Sun shadows are computed based on the contour of the terrain. If a terrain perimeter exists, the sun shadow adjusts to the terrain.

A sun shadow is automatically rebuilt whenever terrain is rebuilt. If you generate a sun Shadow and the terrain is not up-to-date, the terrain automatically rebuilds. You can turn off the automatic rebuild. See [Sun Angle Specification Dialog on page 781](#).

Terrain Objects in the Library



The Library Browser contains a variety of objects that can be placed in a plan's terrain, including plants, exterior fixtures, accessories and roadway objects. See [The Library Browser on page 669](#).

Displaying Terrain



The display of terrain objects in 2D and 3D views is controlled in the Layer Display Options dialog. See [Layer Display Options Dialog on page 126](#).

Like other objects, terrain objects are placed in Drawing Groups that affect whether they display in front of or behind other objects. You can modify a selected object's place in the drawing order by clicking the **View Drawing Group Edit Tools**  edit button. See [Drawing Group Edit Tools on page 128](#).

You can customize appearance of Terrain Features, Roads, and other terrain objects in plan view by changing their line and fill styles.

Plant images are represented in plan view by 2D CAD symbols. You can select a plant's symbol in the Plant Image Specification dialog. See [Image Panel on page 894](#).

CONTOUR LINES

When elevation data has been drawn or imported into a plan, contour lines will display in plan views. See [Elevation Data Tools on page 849](#).

Home Designer Pro can produce both primary and secondary contours. They are on two different layers so you can control their display separately. Contour line labels use the Text Styles assigned to the "Terrain, Primary Contours" and "Terrain, Secondary Contours" layers.

By default, all contour lines are set to be primary, but you can specify secondary contours, frequency and other attributes of contour lines in the Terrain Specification dialog. See [Contours Panel on page 863](#).

IN 3D VIEWS

In order for objects such as Terrain Features and Roads to be visible in 3D views, they must be drawn within the Terrain Perimeter. Any portions of these objects drawn outside of the Terrain Perimeter will not be seen in 3D views. See [Terrain Feature Tools on page 855](#).

A variety of tools are available to help you adjust the perspective of your 3D views. See [Editing 3D Views on page 754](#).



BUILDING THE TERRAIN



When terrain is generated, Home Designer gathers all elevation data that has been added to the model and creates a terrain surface. The program interpolates the data to produce smooth contours.

A terrain perimeter with no additional elevation data drawn within it generates terrain that is flat at the elevation 0' - 0", or sea level.

By default, the terrain is automatically built before a 3D view is generated and when a Sun Shadow is created. This process takes a variable amount of time, depending on the amount of elevation data and number of terrain features in the plan. The Building Terrain progress dialog displays as terrain is generated, sometimes only briefly, indicating the progress.

You can turn off **Auto Rebuild Terrain** in the Terrain Specification dialog as well as in the Sun Angle Specification dialog, and rebuild the terrain manually when needed by selecting **Terrain > Build Terrain** . When **Auto Rebuild Terrain** is turned off and the terrain is not up to date, the Build Terrain  icon displays near your mouse pointer. See [Terrain Specification Dialog on page 861](#) and [Earth Data Panel on page 781](#).

TERRAIN AND 3D DRAWING TIME

Terrain is typically large with many surface triangles, which often increases the drawing time of 3D views. The time required is affected by the quality of the terrain, the amount of elevation data and number of terrain features present. For information about surface triangles and how they influence terrain quality, see [General Panel on page 862](#).

Lights and symbols can be placed outdoors and included in 3D views when the terrain is generated. These objects can also contribute to the time needed to generate 3D views. See [Rendering Tips on page 770](#).

Editing Terrain Objects

Before a terrain object can be edited, it must be selected. All terrain objects can be selected in plan view. In addition, the Terrain Perimeter and Terrain Features can be selected in 3D views. See [Selecting Objects on page 141](#).

A selected terrain object can be edited using its edit handles, edit tools and specification dialog. See [Specification Dialogs on page 19](#).

Any time elevation data is changed, the terrain must be rebuilt. This can be done by selecting **Terrain > Build Terrain** , and occurs automatically when a 3D view is created.

USING THE EDIT HANDLES

Terrain objects can be moved, resized, and reshaped using their edit handles. How a selected object can be edited depends on what type of object it is. See [Editing Objects on page 136](#).

- The Terrain Perimeter can be moved, resized, and reshaped like a polyline-based objects.
- Elevation Points can be moved in plan view using the Move edit handle.
- **Elevation Lines, Elevation Splines** and **Terrain Breaks** are edited like other line- and spline-based objects.
- The shape of a **Raised Region, Lowered Region, Hill, Valley**, and **Flat Region** can be edited like a spline.
- Terrain Features are edited like other spline- and polyline-based objects.

USING THE EDIT TOOLS

A selected terrain object can be edited in a variety of ways using the buttons on the Edit Toolbar. The edit tools available for a terrain object depends on the type of object selected. See [The Edit Toolbar on page 91](#).

Note: If you copy terrain objects from one plan to another, you cannot view the pasted objects in 3D unless a Terrain Perimeter exists.

USING DIMENSIONS



- Like many other types of objects, terrain objects can be resized and moved using dimensions. For more information see [Moving Objects Using Dimensions on page 332](#).

Terrain Specification Dialog

The Terrain Specification dialog controls how your terrain is modeled, as well as its appearance. It can be accessed in any of three ways:



Select **Terrain**> **Terrain Specification**;



Select the Terrain Perimeter and click the **Open Object** edit button;



Double-click the Terrain Perimeter using the **Select Objects** tool.

GENERAL PANEL

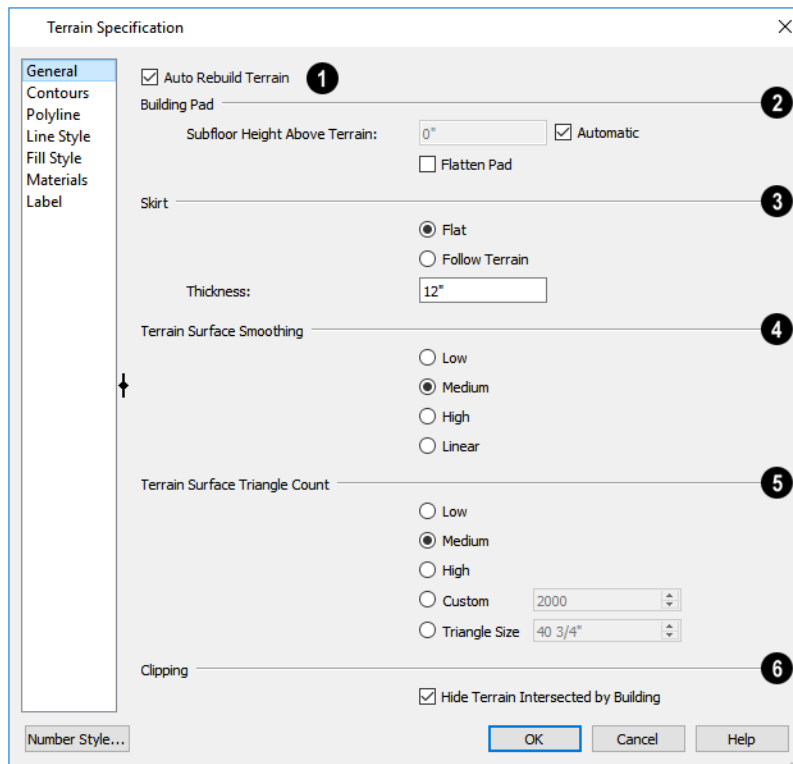

1 Auto Rebuild Terrain

Check **Auto Rebuild Terrain** to automatically rebuild terrain to reflect recent changes before generating a 3D view or a Sun Shadow. If this option is unchecked and the terrain is not up to date, the Rebuild Terrain  icon displays near your mouse pointer. See [Building the Terrain on page 860](#).

2 Building Pad

Specify how the **Building Pad** is generated beneath the structure. See [Foundations and the Terrain on page 491](#).

- To specify the distance between Floor 1 and the terrain at the building footprint center, uncheck **Automatic** and enter a value in the **Subfloor Height Above Terrain** field.
- Check **Automatic** to have Home Designer automatically lower the terrain relative to the first floor. See [Terrain Height vs Floor Height on page 848](#).
- Check **Flatten Pad** to flatten the area beneath the building. To create a walkout basement, uncheck this box.

3 Skirt

Define the thickness of the **Skirt** added to the terrain. The skirt is only visible in 3D views and gives the viewer a sense of depth when viewing the terrain.

- **Flat** specifies that the skirt be flat at its base. Home Designer determines the lowest point in the terrain and then offsets this value by the user specified thickness value. The resulting value is used as a uniform elevation for the base of the skirt.
- **Follow Terrain** specifies that the skirt base maintains a consistent distance below the terrain. The distance is equivalent to the specified Thickness value.

4 Terrain Surface Smoothing

The **Terrain Surface Smoothing** settings control the amount of curvature applied to terrain edges.

- **Low** produces terrain that has sharp peaks and abrupt changes in slope, while **High** results in terrain that flows continuously from point to point but may take longer to generate.
- Select **Linear** to apply no smoothing to the Terrain. Instead, flat triangular surfaces are created between elevation points. This option is only recommended when large amounts of closely spaced elevation data is present.

5 Triangle Count

Specify the number of surface triangles used to generate the terrain in 3D views. A lower count value will generate more quickly but have reduced quality.

- Specify a **Custom** triangle count value.
- Specify the maximum **Triangle Size** in the terrain surface. Smaller triangles produce better quality results in 3D but take longer to generate.

Home Designer builds 3D terrain surfaces by splitting them into triangles. See [Terrain Surface Triangles on page 849](#).

Triangles are computed roughly as follows:

Size of Triangle = Area of Terrain Perimeter / Number of Triangles

The Low (1000), Medium (2000), and High (4000) values work well for a terrain perimeter of approximately 20,000 sq ft (1858 m²). If your terrain perimeter varies greatly from this, consider defining the number of triangles using the **Custom** setting or the **Triangle Size** setting.

6 Clipping

Check **Hide Terrain Intersected by Building** to cut out the portion of the terrain that is intersected by the first floor footprint. Checking this box prevents the generation of contour lines inside the house.

If your foundation footprint differs from your first floor footprint, you may need to use the **Terrain Hole**  tool for custom clipping instead. See [Terrain Feature Tools on page 855](#).

CONTOURS PANEL

Home Designer Pro identifies two types of contour lines: Primary and Secondary. They are drawn on different layers, so you can control how they display in plan view. See [Contour Lines on page 860](#).

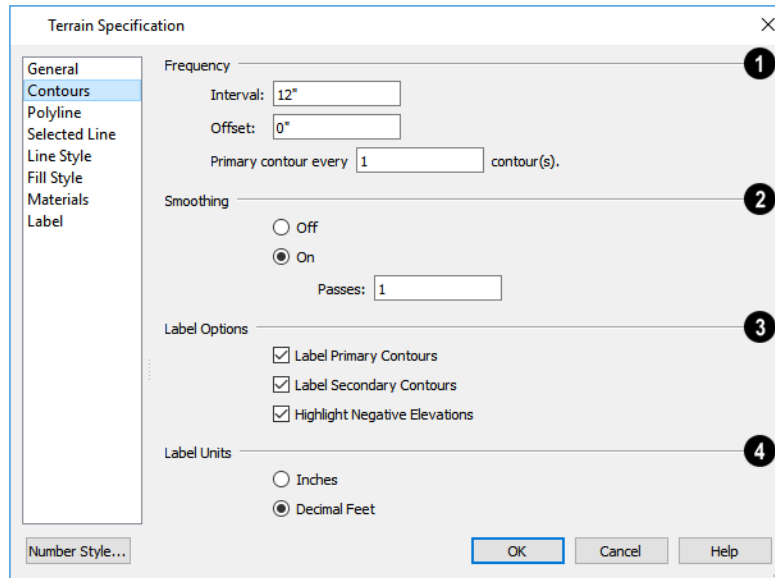

1 Frequency

Specify the **Frequency** at which contour lines are generated.

- Define the **Interval** between contour lines, which is the change in elevation between contours. If the interval is set to 12”, a contour line is computed for each elevation change of 12”.
- Specify the **Offset** value. When the Offset is 0, a contour line will be drawn at zero elevation and additional contours will generate based on the Interval value. If the Offset is changed to 5, a contour line will be drawn 5 units from zero elevation rather than at 0, and additional contours will generate from there.
- **Primary contour every__contours** - Specify the interval for primary contours. A value of 1 produces only primary contours, while a value of 5 defines every fifth contour line as a primary contour.

2 Smoothing

If contour **Smoothing** is turned on, Home Designer attempts to remove sharp bends and jagged sections from the 2D contour lines.

- Specify the number of **Passes** to perform when smoothing. The more passes, the smoother the contour lines become, but contours become less accurate.

3 Label Options

Control the display of **Contour Labels** in plan view.

- Check **Label Primary Contours** to label primary contour lines with their elevation data using the Units specified below.
- Check **Label Secondary Contours** to label secondary contour lines with their elevation data.
- Check **Highlight Negative Elevations** to display labels of contour lines with elevations below 0 in red. When unchecked, they use the color set in the Text Style assigned to their layer.

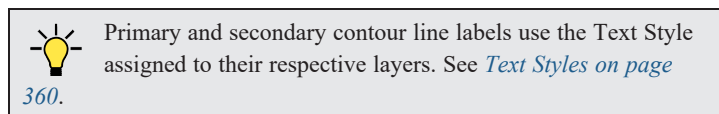

4 Label Units

Specify the **Label Units** used by contour labels. Select either **Inches** or **Decimal Feet** (**Millimeters** or **Meters** for metric).

POLYLINE PANEL

The POLYLINE panel states the length of the Terrain Perimeter's **Perimeter**, its enclosed **Area**, and its **Volume**.

The settings on this panel are available for a variety of other objects in the program. For information about these settings, see *Polyline Panel on page 215*.

SELECTED LINE/ARC PANEL

The SELECTED LINE panel is available when the selected edge is a line as opposed to an arc. See *Line Panel on page 203*.

The SELECTED ARC panel is available when the selected edge has been converted into an arc. See *Arc Panel on page 210*.

See, too, *Selected Edge on page 142* and *Change Line/Arc on page 174*.

LINE STYLE PANEL

The settings on the LINE STYLE panel are available for a variety of other objects in the program. See *Line Style Panel on page 204*.



FILL STYLE PANEL

The settings on the FILL STYLE panel affect the appearance of the Terrain Perimeter in plan view. See *Fill Style Specification Dialog on page 131*.

MATERIALS PANEL

The settings on the MATERIALS panel let you specify the terrain surface and terrain skirt materials used in 3D views. These materials are not calculated in the Materials List. See *Materials Panel on page 716*.

Elevation Point Specification Dialog

 To open the Elevation Point Specification dialog, select an elevation point and click the **Open Object** edit button, or double-click on an Elevation Point using the **Select Objects**  tool.

Use the Elevation Point Specification dialog to define the selected elevation point and control its appearance in plan view.

GENERAL PANEL

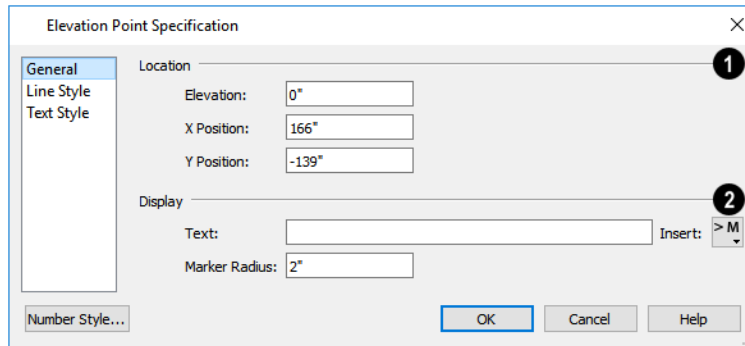

1 Location

Specify the exact location of the elevation point.

- Specify the **Elevation** of the selected Elevation Point.

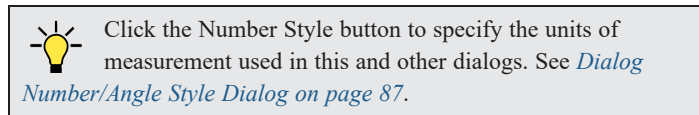

- **X Position** - Enter the x coordinate of the elevation point.
- **Y Position** - Enter the y coordinate of the elevation point.

2 Display

- In the **Text** field, type any notes that you would like to display beside the selected Elevation Point in plan view.
- Enter the **Marker Radius**, which is the size of the point marker, measured from the center to an edge.

LINE STYLE PANEL

The settings on the LINE STYLE panel are available for a variety of other objects in the program. For information about these settings, see [Line Style Panel on page 204](#).

TEXT STYLE PANEL

The settings on the TEXT STYLE panel control the appearance of the selected Elevation Point's text. For more information, see [Text Style Panel on page 361](#).

Elevation Line/Region Specification Dialog

To open the Elevation Line or Elevation Region Specification dialog, select an Elevation Line, Spline, a polyline composed of Elevation Lines or Splines, or an Elevation Region and click the **Open Object** edit button. You can also double-click an Elevation Line/Spline using the **Select Objects**  tool.

The Elevation Line Specification dialog is used to define the selected Elevation Line /Spline and controls its appearance in plan view.

The settings in this dialog are the same as those in the Elevation Region Specification dialog. See [Elevation Regions on page 852](#).

ELEVATION PANEL

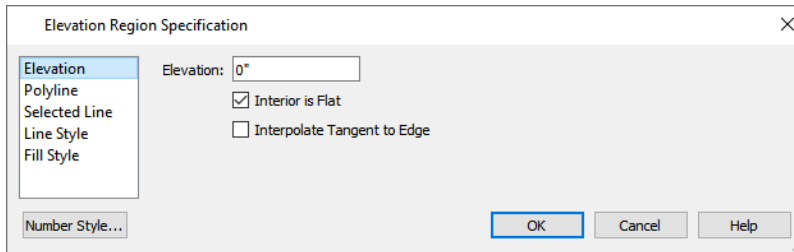

- Specify the **Elevation** of the selected Elevation Line, Spline, or Polyline.

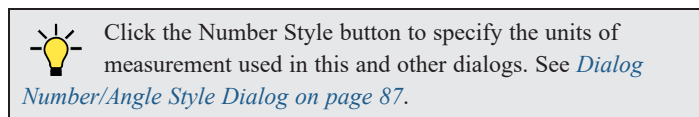

- Check **Interior is Flat** to maintain a flat surface at the specified Elevation. When unchecked, the perimeter of the region maintains the specified Elevation, but the interior elevation may vary depending on other elevation data in the drawing. Only available for closed Elevation Regions.
- Check **Interpolate Tangent to Edge** to flatten the terrain surface as it approaches the edges of the Elevation Region. This option is only available for closed Elevation Regions, and only when Interior is Flat is unchecked.

POLYLINE PANEL

The POLYLINE panel states the **Length** of an open polyline or the **Perimeter** of a closed polyline. If multiple Elevation Line /Spline segments form a closed Elevation Region, its Area will be calculated. Elevation Lines /Splines do not have a thickness, so they have no Volume.

SPLINE PANEL

The SPLINE panel has a single option and is only available when the selected object is an Elevation Spline. See [Splines on page 219](#).

New Segment Angle:

New Segment Angle - Specify the angle between line segments that are used to draw the spline. Specifying a smaller angle makes the spline smoother. Specify a larger angle to draw the spline faster.

SELECTED LINE/ARC PANEL

The SELECTED LINE panel is available when the selected edge is a line as opposed to an arc. See [Line Panel on page 203](#).

The SELECTED ARC panel is available when the selected edge has been converted into an arc. See [Arc Panel on page 210](#).

See, too, [Selected Edge on page 142](#) and [Change Line/Arc on page 174](#).

LINE STYLE PANEL

The settings on the LINE STYLE panel are available for a variety of other objects in the program. See [Line Style Panel on page 204](#).

Flat Region Specification Dialog

 To open the Flat Region Specification dialog, select a Flat Region and click the **Open Object** edit button, or double-click a Flat Region using the **Select Objects**  tool. See *Flat Regions on page 855*.

The options in the Flat Region Specification dialog are similar to those a number of other dialogs in the program.

POLYLINE PANEL

The POLYLINE panel states the length of the region's **Perimeter** and its enclosed **Area**. Flat Regions do not have a Volume measurement. See *Polyline Panel on page 215*.

SPLINE PANEL

The SPLINE panel has a single option and is only available when the selected object is a spline. See *Splines on page 219*.

New Segment Angle:

New Segment Angle - Specify the angle between line segments that are used to draw the spline. Specifying a smaller angle makes the spline smoother. Specify a larger angle to draw the spline faster.

SELECTED LINE/ARC PANEL

The SELECTED LINE panel is available when the selected edge is a line as opposed to an arc. See *Line Panel on page 203*.

The SELECTED ARC panel is available when the selected edge has been converted into an arc. See *Arc Panel on page 210*.

See, too, *Selected Edge on page 142* and *Change Line/Arc on page 174*.

LINE STYLE PANEL

The settings on the LINE STYLE panel are available for a variety of objects in the program. See *Line Style Panel on page 204*.

FILL STYLE PANEL

The settings on the FILL STYLE panel affect the appearance of the selected object in plan view. See *Fill Style Specification Dialog on page 131*.

Hill / Valley Specification Dialog

 The Hill/Valley Specification defines the selected Hill or Valley and controls its appearance in plan view.

To open the Hill/Valley Specification dialog, select one or more Hills or Valleys and click the **Open Object** edit button, or double-click the region(s) using the **Select Objects**  tool.

HILL / VALLEY PANEL

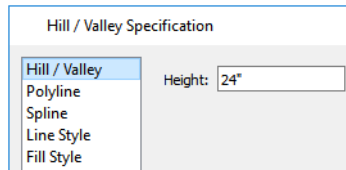

- Enter a **Height** for the selected Hill or Valley. This height is relative to the terrain surface that is generated from the Elevation Data in your plan. See [Terrain Modifier Tools on page 854](#).

POLYLINE PANEL

The POLYLINE panel states the length of the hill or valley's **Perimeter** and its enclosed **Area**. Hills and Valleys do not have a volume measurement.

SPLINE PANEL

The SPLINE panel has a single option. See [Splines on page 219](#).

New Segment Angle:

New Segment Angle - Specify the angle between line segments that are used to draw the spline. Specifying a smaller angle makes the spline smoother. Specify a larger angle to draw the spline faster.



LINE STYLE PANEL

The settings on the LINE STYLE panel are available for a variety of other objects in the program. See [Line Style Panel on page 204](#).

FILL STYLE PANEL



The settings on the FILL STYLE panel affect the appearance of the selected object in plan view. See [Fill Style Specification Dialog on page 131](#).

Raised / Lowered Region Specification Dialog

 To open the Raised/Lowered Region Specification dialog, select one or more raised or lowered regions and click the **Open Object** edit button, or double-click the region(s) using the **Select Objects**  tool.

The Raised / Lowered Region Specification dialog is similar to the Hill / Valley Specification dialog. See [Hill / Valley Specification Dialog on page 868](#).

Terrain Feature Specification Dialog

 To open the Terrain Feature Specification dialog, select a Terrain Feature or group of Terrain Features and click the **Open Object** edit button, or double-click the Terrain Feature(s) using the **Select Objects**  tool.

Most of the panels in this dialog are similar to those for a variety of other objects in the program, including Ponds, Stepping Stones, Driveways, and Parking Lots.

Garden Beds are also a type of Terrain Feature and have an additional Distributed Plant panel in their specification dialog.

The panels that are available in the Terrain Feature Specification dialogs will vary, depending on the type of Terrain Feature that is selected.

GENERAL PANEL

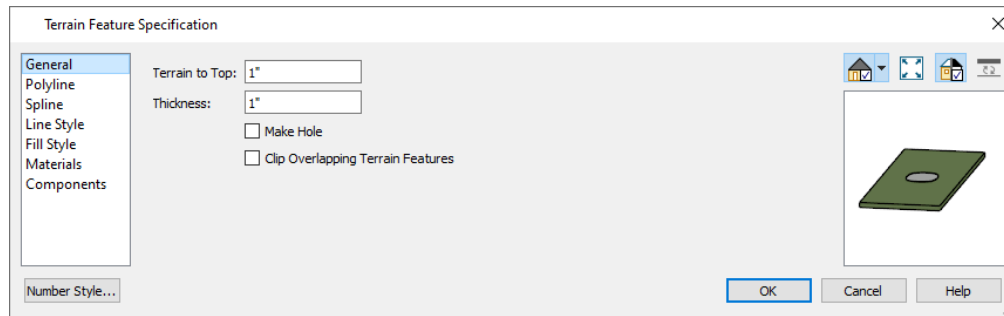

- Specify the **Terrain to Top** value, which is the distance from the top surface of the terrain to that of the terrain feature. If this value is a negative number, the feature sinks into the terrain.
- Specify the feature's **Thickness**.
- Check **Make Hole** to specify the selected Terrain Feature as a Terrain Hole. See [Terrain Holes on page 856](#).
- Check **Clip Overlapping Terrain Features** to suppress the 3D display of any part of the selected Terrain Feature intersected by other Terrain Features with a lower Terrain to Top value. Clipping is useful for creating features that contain other features such as planters or swimming pools.

DISTRIBUTED PLANT PANEL

This panel is only available when the selected Terrain Feature is a Garden Bed. See [Distributed Plant Panel on page 872](#).

POLYLINE PANEL

The POLYLINE panel states the length of the garden bed's **Perimeter**, its enclosed **Area**, and its **Volume**. See [Polyline Panel on page 215](#).

SPLINE PANEL

The SPLINE panel has a single option and is only available when the selected object is a spline. See [Splines on page 219](#).

New Segment Angle:

New Segment Angle - Specify the angle between line segments that are used to draw the spline. Specifying a smaller angle makes the spline smoother. Specify a larger angle to draw the spline faster.

SELECTED LINE/ARC PANEL

The SELECTED LINE panel is available when the selected edge is a line as opposed to an arc. See [Line Panel on page 203](#).

The SELECTED ARC panel is available when the selected edge has been converted into an arc. See [Arc Panel on page 210](#).

See, too, [Selected Edge on page 142](#) and [Change Line/Arc on page 174](#).

LINE STYLE PANEL

The settings on the LINE STYLE panel are available for a variety of other objects in the program. See *Line Style Panel on page 204*.

FILL STYLE PANEL

The settings on the FILL STYLE panel affect the appearance of the selected object in plan view. See *Fill Style Specification Dialog on page 131*.

MATERIALS PANEL

The settings on the MATERIALS panel affect the appearance of the selected object in 3D views. See *Materials Panel on page 716*.

COMPONENTS PANEL

The information on the COMPONENTS panel can be used in the materials list. For more information, see *Components Panel on page 921*.

Garden Bed Specification Dialog

 Select a Garden Bed and click the **Open Object** edit button to open the Garden Bed Specification dialog. This dialog is similar to the Terrain Feature Specification dialog; however, the DISTRIBUTED PLANT panel is unique to Garden Beds. See *Terrain Feature Specification Dialog on page 869*.

DISTRIBUTED PLANT PANEL

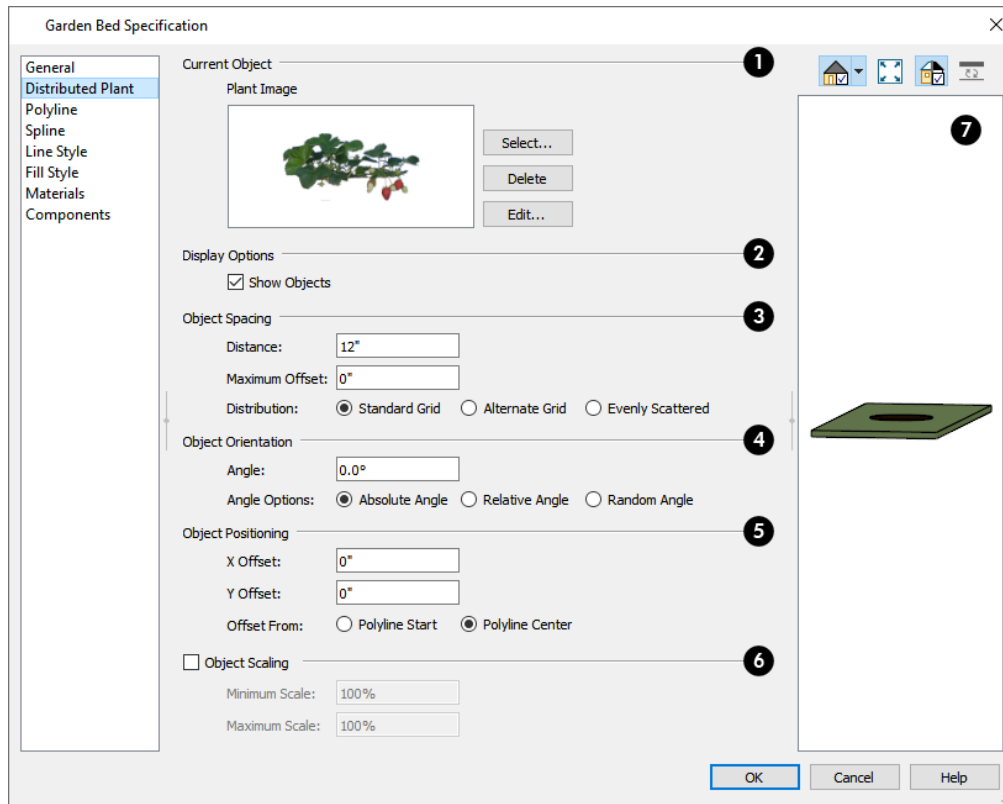

1 Current Object

Specify the **Current Object** assigned to the selected region. When an object is assigned, its name and a preview of a single instance of it display here.

- Click the **Select** button to choose an object from the library. See [Select Library Object Dialog on page 688](#).
- Click the **Delete** button to unassign the Current Object from the selected region.
- Click the **Edit** button to open the Current Object's specification dialog. Changes made here affect all objects generated within the region. See [Specification Dialogs on page 19](#).

 You can replace the plant assigned to a Garden Bed by applying a new one directly from the library. See [Replace From Library on page 689](#).

2 Display Options

- Check **Show Objects** to display the distributed objects in plan view.
- Check **Show Region** to display the distribution region outline in plan view.

3 Object Spacing

Specify how the objects in the region are spaced.

- Specify the **Distance** between the objects in the region, as measured from their center points.
- Objects in the region can be randomly offset from their default positions if you wish. Specify their **Maximum Offset**, measured from their center points. Not available when Evenly Scattered is selected, below.
- Select **Standard Grid** to position the objects in rows and columns based on the standard X/Y grid in the program. This grid is affected by **Rotate Plan View**. See *Rotate Plan View on page 103*.
- Select **Alternate Grid** to position the objects in rows and columns based on the shape of the region.
- Select **Evenly Scattered** to distribute the objects evenly but not on a grid layout.

4 Object Orientation

Specify how or if the objects in the region are rotated. These settings do not affect the region itself or its edges.

- Specify the **Angle** that the distributed objects should be placed at.
- Select **Absolute Angle** to rotate the objects relative to an imaginary horizontal line drawn in the positive X direction from the origin. See *3D Drafting on page 11*.
- Select **Relative Angle** to rotate the objects relative to the angle of the region's first edge or, if that edge is curved, to the angle of its chord. The first edge is typically located at the top of the region when it is first created; however, this can change as the region is edited.
- Select **Random Angle** to rotate the objects in the region at a variety of random angles.

5 Object Positioning

Specify the positioning of the distributed objects relative to a point of origin within the region.

- Specify the **X Offset**, the horizontal distance in plan view from the region's specified point of origin.
- Specify the **Y Offset**, the vertical distance in plan view from the region's specified point of origin.
- Select **Offset From Polyline Start** to measure the offset from the region's start point. This start point is typically located at the top left of the region when it is first created; however, this can change as the region is edited.
- Select **Offset From Polyline Center** to measure the offset from the region's center point.

6 Object Scaling

Check **Object Scaling** to specify a range of size variation of the objects in the region.

- Specify the **Minimum Scale**, which is the smallest resize of the objects allowed.
- Specify the **Maximum Scale**, which is the largest resize of the objects allowed.

7 Preview

A preview of the region displays on the right side of the dialog box. If no object has been assigned to the selected region, Plan View will be the default preview type. See *Dialog Preview Panes on page 20*.

Terrain Break Specification Dialog

To open the Terrain Break Specification dialog, select a Terrain Break or group of Terrain Breaks and click the **Open Object** edit button or double-click the Terrain Break(s) using the **Select Objects**  tool. See [Terrain Breaks on page 853](#).

GENERAL PANEL

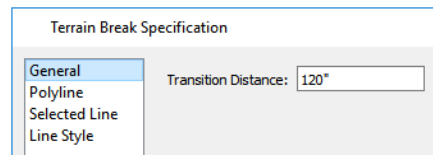

- Define the **Transition Distance**, which is the distance from the edge of the terrain break to where the break stops affecting the terrain.

POLYLINE PANEL

The POLYLINE panel states the **Length** of an open polyline or the **Perimeter** of a closed polyline. If multiple Terrain Break segments form a closed polyline, its **Area** will be calculated. Terrain Breaks do not have a thickness, so they have no **Volume**. See [Polyline Panel on page 215](#).

SELECTED LINE/ARC PANEL

The SELECTED LINE panel is available when the selected edge is a line as opposed to an arc. See [Line Panel on page 203](#).

The SELECTED ARC panel is available when the selected edge has been converted into an arc. See [Arc Panel on page 210](#).

See, too, [Selected Edge on page 142](#) and [Change Line/Arc on page 174](#).

LINE STYLE PANEL

For information about the LINE STYLE panel, see [Line Style Panel on page 204](#).

FILL STYLE PANEL

The FILL STYLE panel is only available when multiple Terrain Break segments enclose an area. The settings on this panel affect the appearance of the closed shape in plan view. See [Fill Style Specification Dialog on page 131](#).

Terrain Path Specification Dialog

To open the Terrain Path Specification dialog, select one or more Sidewalks, Streams, Terrain Walls, or Terrain Curbs and click the **Open Object** edit button, or double-click the terrain path(s) using the **Select Objects**  tool.

Most of the panels in this dialog are similar to those for a variety of other objects in the program.

GENERAL PANEL

The settings on the GENERAL panel are also found in the Road Specification dialog. See [General Panel on page 887](#).

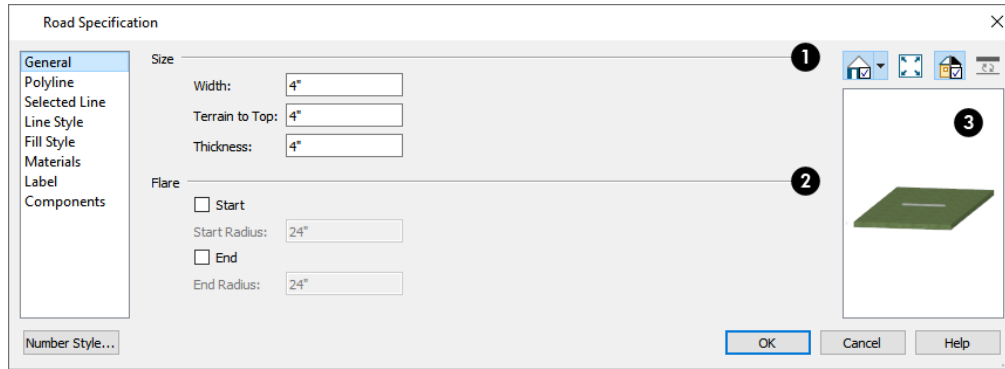

1 Size

- Specify the path's **Width**.
- Specify the **Terrain to Top** value, which is the distance from the top surface of the terrain to that of the path. If this value is a negative number, the object sinks into the terrain.
- Specify the path's **Thickness**.

2 Flare

When one terrain path joins another, you can flare the intersection.

- Check **Start** to create a flare at the starting end of the selected terrain path, then specify the **Radius** of that flare.
- Check **End** to create a flare at that end of the terrain path, then specify the Radius of that flare.

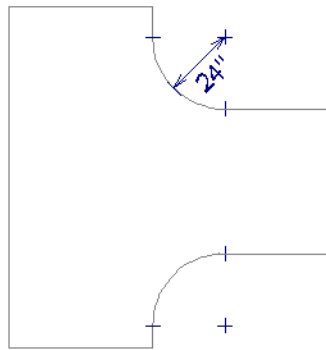

3 Preview

A preview of the selected cabinet displays on the right side of the panel. See [Dialog Preview Panes on page 20](#).

POLYLINE PANEL

The POLYLINE panel states the length of the Terrain Path's **Perimeter**, its enclosed **Area**, and its **Volume**. See [Polyline Panel on page 215](#).

SPLINE PANEL

The SPLINE panel has a single option and is only available when the selected object is a spline path. See [Splines on page 219](#).

New Segment Angle:

- **New Segment Angle** - Specify the angle between line segments that are used to draw the spline. Specifying a smaller angle makes the spline smoother. Specify a larger angle to draw the spline faster.

SELECTED LINE/ARC PANEL

The SELECTED LINE panel is available when the selected edge is a line as opposed to an arc. See [Line Panel on page 203](#).

The SELECTED ARC panel is available when the selected edge has been converted into an arc. See [Arc Panel on page 210](#).

See, too, [Selected Edge on page 142](#) and [Change Line/Arc on page 174](#).

LINE STYLE PANEL

The settings on the LINE STYLE panel are available for a variety of other objects in the program. See [Line Style Panel on page 204](#).

FILL STYLE PANEL

The settings on the FILL STYLE panel affect the appearance of the selected object in plan view. See [Fill Style Specification Dialog on page 131](#).

MATERIALS PANEL

The settings on the MATERIALS panel affect the appearance of the selected object in 3D views. See [Materials Panel on page 716](#).

COMPONENTS PANEL

The information on the COMPONENTS panel can be used in the materials list. For more information, see [Components Panel on page 921](#).

Importing Elevation Data

Elevation data can be added to a plan using the tools and techniques described in this chapter or it can be imported from a file. See [Elevation Data Tools on page 849](#).

Home Designer Pro can import elevation data saved in DXF/DWG, GPS Exchange (.gpx) and a variety of text file formats (.txt, .csv, .prn, .xyz, .auf and .nez). If your terrain data is not saved in one of these file formats, there are third party programs available that can convert to these formats.

DXF/DWG FILES

If you have a model of your terrain created on another program that contains contour lines and elevation data, that information can be imported directly as elevation data into Home Designer Pro as a .dxf or a .dwg file. See [Importing DWG/DXF Elevation Data on page 881](#).

TEXT FILES

Elevation data can be saved in text files as x, y, and z coordinates where x and y define the location of a point on a Cartesian grid, and z defines the elevation for that point. Each data point must be on a separate line in the text file.

Importable text files can come from surveyors, other software programs, or you can create your own using a GPS system.

Elevation data saved in text files can be imported using the Import Terrain Assistant. See *Import Terrain Assistant on page 877*.

GPS EXCHANGE FILES

Elevation data in standard format **.gpx** files created using a GPS system can also be imported using the Import GPS Data Assistant. See *Import GPS Data Assistant on page 879*.

GPS data may include three types of points - Way, Track, and Route. Home Designer Pro can only import a **.gpx** file if it includes one or more Way Points, and cannot use Route Points at all. If a **.gpx** file does not include any Way Points, it will not be imported, and if it includes any Route Points, they will be ignored.

Home Designer supports the import of data in standard **.gpx** files that adhere to the GPX 1.1 Schema. Files that do not follow this standard cannot be imported.

Import Terrain Assistant



The Import Terrain Assistant allows you to import elevation data saved in text (**.txt**) file format into a plan.

Each data point in this format has information about its X-axis (East to West location), Y-axis (North to South location), and Z-axis (elevation). It might also have a brief description. In order to import elevation data from a text file, you need to know how the data in the file is organized.

To launch the Import Terrain Assistant, select **File> Import> Terrain Data** . Click **Next**.

SELECT FILE

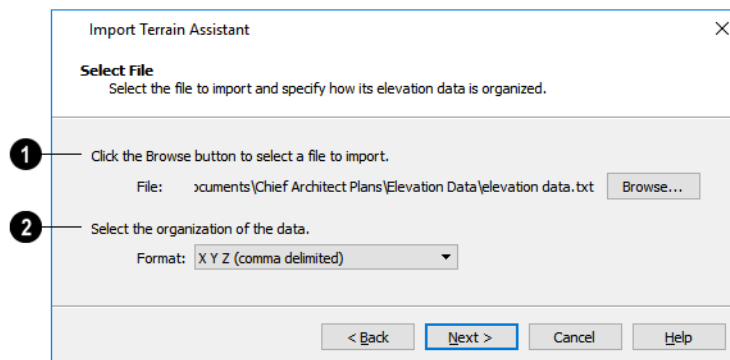

1 Select a file to import

- Click the **Browse** button to locate a file on your computer. See *Importing Files on page 42*.
- If a file has been selected, its full pathname displays here for reference; if a file has not been selected, the directory of the last file imported displays. If the pathname is not that of a valid **.txt** file, this text will display in red.

2 Select the organization of the data

- Elevation information can be organized in one of six different ways, and can be separated by either a comma (comma delimited) or a space (space delimited).
- **XYZ** - Information in this format begins with the X coordinate, followed by the Y coordinate and the Z coordinate.
- **#XYZ** - Information in this format begins with a number that belongs to each data point followed by the X coordinate, the Y coordinate, and the Z coordinate.
- **#XYZ Description** - Information in this format begins with a number that belongs to each data point followed by the X coordinate, the Y coordinate, the Z coordinate, and a description.
- **YXZ** - Information in this format begins with the Y coordinate followed by the X coordinate and the Z coordinate.
- **#YXZ** - Information in this format begins with a number that belongs to each data point followed by the Y coordinate, the X coordinate, and the Z coordinate.
- **#YXZ Description** - Information in this format begins with a number that belongs to each data point followed by the Y coordinate, the X coordinate, the Z coordinate, and a description.

Click **Next** to continue.

SCALE DATA

The screenshot shows the 'Import Terrain Assistant' dialog box with the 'Scale Data' tab selected. The dialog contains the following elements:

- 1** - A text box indicating the imported data contains 15 elevation points with ranges: X = 1.000000 to 3.000000, Y = 2.000000 to 4.000000, and Z = 3.000000 to 5.000000.
- 2** - A section for specifying units for each axis (X, Y, Z). All three are currently set to 'ft'.
- 3** - A checkbox labeled 'Map this elevation point to the origin (0,0):'. Below it are input fields for X (0.0) and Y (0.0).
- 4** - A checkbox labeled 'Multiply the coordinate values of each axis to change the scale of the terrain.'. Below it are input fields for X (1.0), Y (1.0), and Z (1.0).
- 5** - A checkbox labeled 'Rotate North Counterclockwise:'. Below it is an input field for the rotation angle (0.0°).

At the bottom of the dialog are four buttons: '< Back', 'Next >', 'Cancel', and 'Help'. The 'Next >' button is highlighted with a blue border.

1 Imported Data

- The total number of data points to be imported and the ranges of their coordinates are described here.

2 Units

- Select the **Units** of measurement used for each axis.

3 Map

- **Map** a data point in the file to the origin in Home Designer to position the terrain data relative to your plan. See *3D Drafting on page 11*.

4 Scale

- To change the scale of the terrain, multiply the coordinates of each axis by a specific number to decrease or increase the relative size or relief of your terrain.

5 Rotate North Counterclockwise

- Specify an amount to rotate the terrain data counterclockwise, or to the left.

Click **Next** to finish.

Import GPS Data Assistant



The Import GPS Data Assistant allows you to import terrain data from the standard **.gpx** file format. See *GPS Exchange Files on page 877*.

Select **File> Import> GPS Data** to open the Import GPS Data Assistant, then click **Next** to continue.

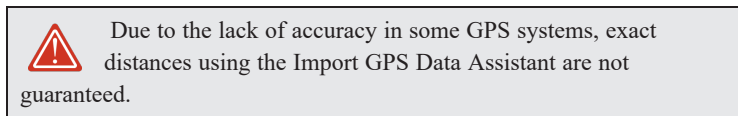

SELECT FILE

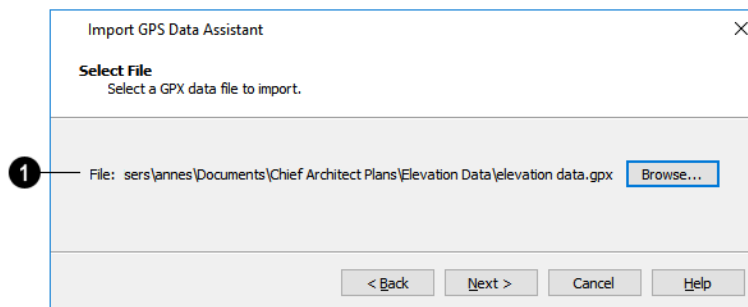

1 Select a file to import

- Click the **Browse** button to locate a **.gpx** file on your computer. See *Importing Files on page 42*.
- If a file has been selected, its full pathname is reported here for reference; if a file has not been selected, the directory of the last file imported displays. If the pathname is not that of a valid **.gpx** file, this text will display in red.

Note: Not all GPS programs use the standard **.gpx** file format; however, only files using the standard format can be imported.

Click **Next** to continue.

IMPORT DATA AS

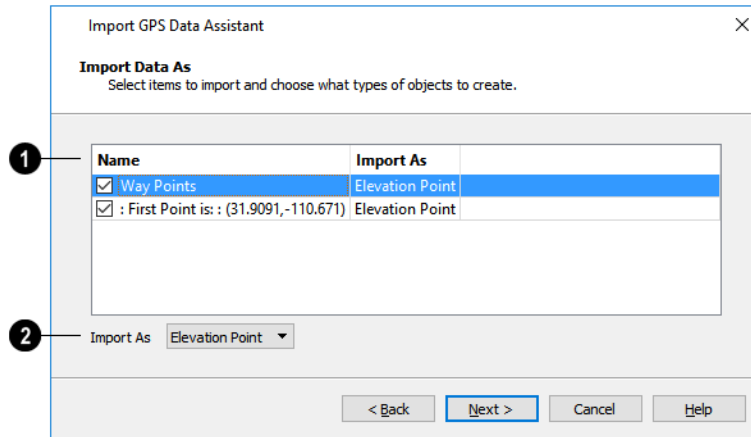

1 Name

Specify which items you want to import by checking the box to the left of the **Name**. Items with unchecked boxes are not imported.

2 Import As

Specify what you would like the selected item to **Import As** from the drop-down list.

- Only Way Points have elevation data associated with them. To import this data, import them as “Elevation Points”.
- Select “Marker” to import either Way Points or Track Points as location markers. Markers have no elevation data associated with them.
- Select “Polyline” to create an open CAD polyline based on the position of Way Points or Track Points. The points themselves are not imported. Polylines have no elevation data associated with them.
- Select “Terrain Perimeter” to create a closed Terrain Perimeter polyline based on the position of either Way Points or Track Points. The points themselves are not imported. A Terrain Perimeter has no elevation data associated with it. See [Terrain Perimeter on page 847](#).

 Way Points are typically imported as “Elevation Data”, while Track Points are imported as “Markers”, “Polylines”, or “Terrain Perimeter”.

Click **Next** to continue.

TRANSFORM COORDINATES

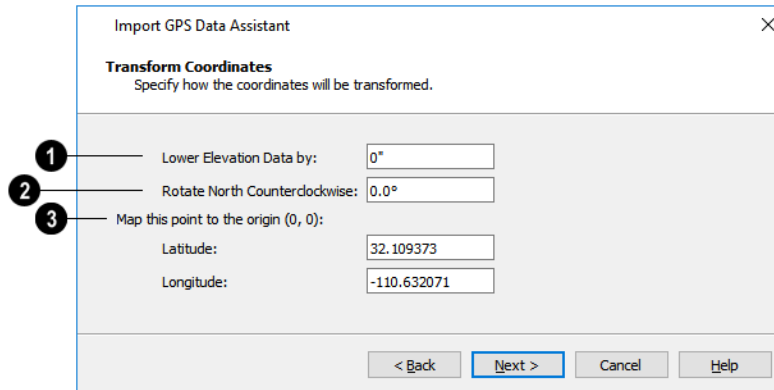

1 Lower Elevation Data by

- Specify the amount that you would like to lower all imported elevation data.

2 Rotate North Counterclockwise

- Specify an amount to rotate the terrain data counterclockwise, or to the left.

3 Map this point to the origin

- Specify a point in the imported terrain data, defined by degrees **Latitude** and **Longitude**, that you would like to locate at the origin in the Home Designer plan.

Click **Next** to finish.

If you do not see the imported terrain, select **Window > Fill Window** .

Importing DWG/DXF Elevation Data



Select **File > Import > Drawing (DWG/DXF)** to open the Import Drawing Assistant, which you can use to import elevation data in **.dwg/.dxf** format. See *Import Drawing Assistant on page 832*.

By default, the Import Drawing Assistant imports entities as regular CAD objects; however, you can specify that any layer in the drawing be converted to either a Terrain Perimeter or Elevation Data. If a layer is converted to Elevation Data, any points and lines on that layer are converted to Elevation Points and Lines, and any elevation data associated with them is preserved.

- If an imported line has vertices with the same Z values, an Elevation Line is created.
- If the vertices have differing Z values, an Elevation Point is created for each vertex.
- Imported points are converted to Elevation Points.
- Other imported entities (solids, faces, etc.) are imported normally.



To avoid unexpected results when importing a drawing, only convert layers with elevation information to Elevation Data.

If a Terrain Perimeter does not exist in the plan or if a layer in the **.dwg/.dxf** file is not converted to a Terrain Perimeter, a Terrain Perimeter is created around the extents of the Elevation Data when it is imported.

Converting CAD Objects to Terrain Data



CAD lines, splines, and polylines - either imported or drawn using Home Designer Pro's CAD Tools - can be selected and converted to terrain data using the **Convert Polyline** edit tool.

In plan view, select a CAD line, spline, or polyline and click the **Convert Polyline**  edit button to open the Convert Polyline dialog. See [Convert Polyline on page 179](#).

A Terrain Perimeter must exist before any other types of terrain object can be created. If no Terrain Perimeter is present in the current plan, this will be the only terrain item available in the Convert Polyline dialog.

When you click **OK**, the terrain object's specification dialog opens, allowing you to specify elevation data or other attributes.

Roads, Driveways and Sidewalks

Chapter 35

Roads, sidewalks, driveways and parking lots are modeled in 3D like other terrain objects in Home Designer. Because they have much in common with terrain objects and rely upon terrain data to be viewed in 3D, it is helpful to be familiar with terrain modeling before using these tools. See *Terrain on page 846*.

TOPICS

Road, Driveway, and Sidewalk Tools	884
Displaying Road Objects	885
Editing Road Objects	886
Road Specification Dialog	886

Road, Driveway, and Sidewalk Tools



Roads objects can be drawn in plan view, camera views and overviews, but only when a Terrain Perimeter exists in the plan. See [Terrain Perimeter on page 847](#).

Straight and Spline road objects:

- Are typical line- and spline-based objects, and can be edited as such.
- Are flat along their widths, which makes it easy to create roads on sloping terrain.
- Can be joined end-to-end to form intersections and networks.
- Have a consistent width that can be defined in their specification dialogs. See [Road Specification Dialog on page 886](#) and [Terrain Path Specification Dialog on page 874](#).

Driveways and Parking Lots, on the other hand, are actually Terrain Features which follow the contours of the terrain rather than cut into them. They are drawn as rectangles but can be edited to any shape. See [Terrain Feature Tools on page 855](#) and [Editing Closed Polyline-Based Objects on page 155](#).



Once road objects have been placed, they can be edited individually or as a group. See [Editing Road Objects on page 886](#).

ROAD TOOLS



Select **Terrain > Road and Sidewalk > Straight Road**, then click and drag to draw a line within the Terrain Perimeter to draw a Straight Road.

The ends of multiple road sections can be connected together. Roads are edited along their center line and can be edited much like other line-based objects. See [Editing Line-Based Objects on page 145](#).



Select **Terrain > Road and Sidewalk > Spline Road**, then click and drag to draw a curved road composed of spline segments.

Spline roads are drawn and edited like other spline-based objects. See [Editing Spline-Based Objects on page 160](#).

SIDEWALK TOOLS



To create a sidewalk with no curves, select **Terrain > Road and Sidewalk > Straight Sidewalk**, then click and drag a line within the Terrain Perimeter.

Sidewalks are edited along their center line like line-based objects. See [Editing Line-Based Objects on page 145](#).



Select **Terrain> Sidewalk> Spline Sidewalk**, then click and drag to draw a curved sidewalk composed of spline segments.

DRIVEWAY AREA



A **Driveway Area** is a terrain feature with a concrete material assignment. To create a driveway, select **Terrain> Road and Sidewalk> Driveway Area**, then click and drag from corner to corner to draw a rectangle. See [Rectangular Polyline on page 217](#).

Height, thickness and material information can be specified in a driveway's specification dialog. See [Terrain Feature Specification Dialog on page 869](#).

Driveways can be edited like other closed polylines. See [Editing Closed Polyline-Based Objects on page 155](#).

PARKING LOT



A **Parking Lot** is a terrain feature with an asphalt material assignment. To place a parking lot, select **Terrain> Road and Sidewalk> Parking Lot**, then click and drag from corner to corner to draw a rectangle. See [Rectangular Polyline on page 217](#).

Height, thickness and material information can be specified in a parking lot's specification dialog. See [Terrain Feature Specification Dialog on page 869](#).

Displaying Road Objects



Roads and sidewalks display in floor plan and 3D views based on the settings for their layers in the Layer Display Options dialog. See [Layers on page 123](#).

IN 3D VIEWS

In order for Road objects to be visible in 3D views, they must be drawn within the Terrain Perimeter. Any portions of these objects drawn outside of the Terrain Perimeter will not be seen in 3D views.

By default, the terrain rebuilds automatically when road objects are added, removed or edited. If it does not, you can select **Terrain> Build Terrain** . See [Terrain Perimeter on page 847](#).







Editing Road Objects

Road objects can be selected in 2D and 3D views and edited using the edit handles, the Edit Toolbar, and their specification dialogs.

Terrain Walls  and **Terrain Curbs** are also Road objects. See *Terrain Wall and Curb Tools on page 858*.

USING THE EDIT HANDLES

The edit handles available for a selected road object depend on the type of object selected.

- **Straight Roads** , straight **Terrain Walls** , and straight **Terrain Curbs**  are edited along their centerline like a line or open polyline. See *Editing Line-Based Objects on page 145*.
- **Spline Roads** , **Spline Sidewalks**, **Spline Terrain Walls**  are edited along their centerline like CAD splines. See *Editing Spline-Based Objects on page 160*.
- **Driveway Areas**  and **Parking Lots**  are edited like other closed polyline based objects. See *Editing Closed Polyline-Based Objects on page 155*.

IN THE SPECIFICATION DIALOG

 Road objects can be customized in their specification dialogs. See *Road Specification Dialog on page 886*, *Terrain Feature Specification Dialog on page 869*, and *Terrain Path Specification Dialog on page 874*.

USING THE EDIT TOOLS

A selected road object can be edited in a variety of ways using the buttons on the Edit Toolbar. See *The Edit Toolbar on page 91*.

Road Specification Dialog

 To open the Road Specification dialog, select a Straight Road or Spline Road and click the **Open Object** edit button.

Many of the settings in this dialog are similar to those in the Terrain Path Specification dialog. See *Terrain Path Specification Dialog on page 874*.

GENERAL PANEL

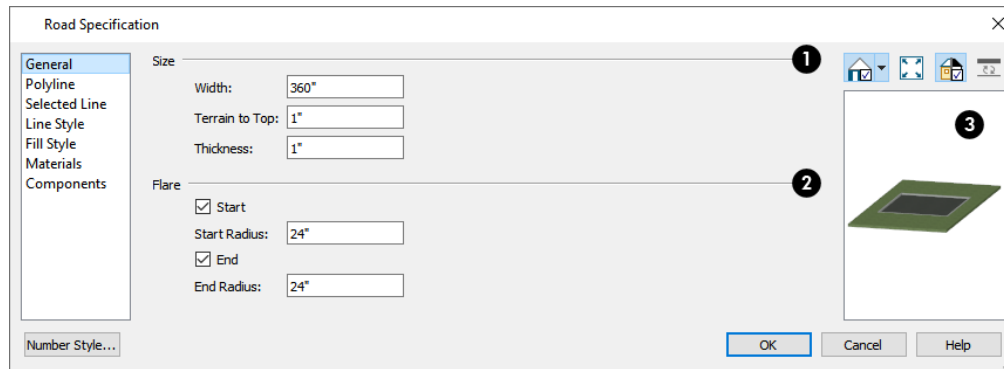

1 Size

- Specify the road's **Width**.
- Specify the **Terrain to Top** value, which is the distance from the top surface of the terrain to that of the road. If this value is a negative number, the road sinks into the terrain.
- Specify the road's **Thickness**.

2 Flare

When one road intersects another, flares can be specified.

- Check **Start** to create a flare at the starting end of the selected road, then specify the **Radius** of that flare.
- Check **End** to create a flare at the end of the selected road, then specify the **Radius** of that flare.

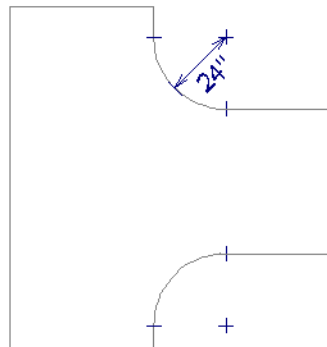

3 Preview

A preview of the selected road displays on the right side of the panel. See [Dialog Preview Panes on page 20](#).

POLYLINE PANEL

The POLYLINE panel states the length of the road's **Perimeter**, its **Area** and its **Volume**. For more information, see [Polyline Panel on page 215](#).

SELECTED LINE/ARC PANEL

The SELECTED LINE panel is available when a Straight Road is selected. For more information, see [Line Panel on page 203](#).

The SELECTED ARC panel is available when the curved segment of a Straight Road is selected. See *Arc Panel on page 210*. See, too, *Selected Edge on page 142* and *Change Line/Arc on page 174*.

SPLINE PANEL

The SPLINE panel is available when a Spline Road is selected. Specify the angle between the line segments used to draw the spline. For more information, see *Spline Panel on page 216*.

LINE STYLE PANEL

This panel is the same as the LINE STYLE panel in many other specification dialogs. See *Line Style Panel on page 204*.

FILL STYLE PANEL

The settings on the FILL STYLE panel affect the appearance of the selected object in plan view. For information about these settings, see *Fill Style Specification Dialog on page 131*.

MATERIALS PANEL

The settings on the MATERIALS panel affect the appearance of the selected object in 3D views. For information about these settings, see *Materials Panel on page 716*.

COMPONENTS PANEL

The information on the COMPONENTS panel can be used in the materials list. For more information, see *Components Panel on page 921*.

Plants and Sprinklers

Chapter 36

The Plant Tools and sprinklers from the Library Browser allow you to create planting designs and irrigation systems in your terrain.

The Terrain Tools are discussed in their own chapter. See *Terrain on page 846*.

TOPICS

Plant Tools	890
Plant Chooser Dialog	891
Hardiness Zones	893
Plant Image Specification Dialog	893
Sprinkler Tools	897
Sprinkler Specification Dialogs	897
Plant Schedules	898
Schedule Numbering and Columns	899
Plant Schedule Specification Dialog	899

Plant Tools



Select **Terrain> Plant** to add plants to your landscaping plan. Plants can also be placed in a plan directly from the library. See [Placing Library Objects on page 686](#).

Plant objects are actually images, which provide realism while avoiding high 3D surface count. Once created, plant images can be selected and edited much like other image objects. See [Editing Images on page 797](#).



Select **Terrain> Plant> Plant Chooser** to open the Plant Chooser dialog and find plants based on their characteristics and requirements. See [Plant Chooser Dialog on page 891](#).



Select **Terrain> Plant> Create Plant Image** to create a plant image. See [Plant Image Specification Dialog on page 893](#). Once a plant image is created, it can be added to the library for future use. See [Creating Images on page 795](#).



Select **Terrain> Plant> Grow All Plants** to open the Grow Plants dialog.

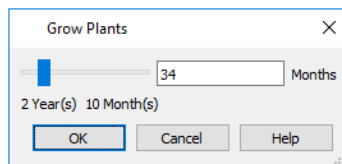

Click and drag the slider bar and select a growth period from zero to twenty years. This only works for plants that have a mature height and mature age specified in the Plant Image Specification dialog. See [Plant Information Panel on page 895](#).



Select **Terrain> Plant> Show Hardiness Zones** to access regional climate zone maps. See [Hardiness Zones on page 893](#).



Select **Terrain> Plant> Plant Schedule**, then click to create a plant schedule. See [Plant Schedules on page 898](#).

Home Designer's Library Browser features a Plants category with a selection of plant, shrub and tree images which you can place in your plan. See [The Library on page 668](#).

Once placed in your plan, these plant images can be selected, moved, copied and resized to produce a wide variety of unique landscaping designs. See [Editing Images on page 797](#).

GARDEN BEDS



Garden Beds are a special type of **Terrain Feature** with material and height attributes typical of planting beds. In addition, you can choose to distribute copies of a plant image within a Garden Bed. See [Garden Bed Tools on page 856](#).

PLANTS LIBRARY CATALOGS



In the Library Browser, browse to Home Designer Core Catalogs> Plants to access a selection of plant images. Select the library object you want, then click in any view to place it in the plan. See [The Library on page 668](#).

A selection of Bonus Catalogs of plants is also available for download. See [Home Designer Bonus Catalogs on page 677](#).

In addition, you can add single plants and blocked groups of plants to the library. See [Adding Library Content on page 681](#) and [Architectural Blocks on page 696](#).

PLANT SCHEDULES



The **Plant Schedule** tool allows you to create customizable plant schedules and plant labels that display schedule numbers. See *Plant Schedules on page 898*.

Plant Chooser Dialog



Select **Terrain > Plant > Plant Chooser** or click the **Plant Chooser** button at the bottom of the Library Browser window to open the Plant Chooser.

Use this dialog to search the library for plant images that match your search parameters. You can search using any or all of the options in the Plant Chooser.

The search parameters in this dialog correspond to the settings on the PLANT INFORMATION panel of the Plant Image Specification dialog. See *Plant Information Panel on page 895*.

The screenshot shows the Plant Chooser dialog box with the following sections and callouts:

- 1** Name: Common Name: oak, Variety Name: [empty], Scientific Name: [empty], Pronunciation: [empty]
- 2** Type: Annual, Perennial/Biennial, Tree, Shrub, Bulb, Cactus/Succulent
- 3** Sub-Type: Fruit, Vegetable, Herb, Nut, Turf, Ornamental Grass, Evergreen, Deciduous, Houseplant, Groundcover, Climber, Aquatic
- 4** Needs: Sun (Sun, Cloud, Rain), Water (Water drop icons), Soil pH (pH scale icons), Hardiness Zone from: Unknown to: 15, View Map...
- 5** Flowers and Foliage: Flower Color (color icons), Bloom Time (season icons), Leaf Color (color icons)
- 6** Height: From: 0"-12" To: 24'+, Height at Maturity: 0", Starting Age: 0 months, Age at Maturity: 0 months
- 7** Special Characteristics: Easy To Grow, Fast Growing, Self-Sowing, Container, Fragrant, Attracts Birds & Butterflies, Deer Resistant, Winter Interest, Cut Flowers, US Native/Wildflower, Fall Color, Attractive Foliage
- 8** Object Type: 3D Plants, Plant Images, Both
- 9** Search button
- 10** List of search results: Oakleaf Hydrangea, White Oak, Charter Oak, Texas Red Oak Spanish Oak Spotted, Turkey Oak (highlighted), Sessile Oak, Durmast Oak, Pyrenean Oak, English Oak, Truffle Oak, Peduncula
- 11** View Item button

1 Name

Type the **Name** of a plant that you would like to find.

- Specify the plant's **Common Name**, **Scientific Name**, or its **Variety Name**.
- A **Pronunciation** field is also provided. In the Plant Image Specification dialog, it is populated with a phonetic pronunciation guide for the plant's scientific name.

2 Type

Check one or more boxes to indicate selected plant **Type** to search for.

3 Sub-Type

Check one or more boxes to specify the selected **Sub-Type** to search for.

4 Needs

Specify the plant **Needs** to search for. These include the **Sun**, **Water**, **Soil pH**, and **Hardiness Zone** range. See *Hardiness Zones on page 893*.

5 Flowers and Foliage

-

- Specify the **Flower Color** to search for. Multiple colors can be selected.
- Specify the **Leaf Color** to search for. Multiple colors can be selected.
- Specify the **Bloom Time** to search for, which is the season when the plant produces flowers.

6 Height

Specify the plant **Height** at maturity to search for. This is used with the Grow Plants feature. See *Plant Tools on page 890*.

- An average mature height range can be entered using the **From** and **To** drop-down lists.
- A specific **Height at Maturity** to search for can be entered in the text field.
- A specific **Starting Age**, in months, can be entered in the text field.
- A specific **Age at Maturity**, in months, can be entered in the text field.

7 Special Characteristics

Check one or more boxes to search for plants with **Special Characteristics**.

8 Object Type

Select which types of plant **Object Type** to search for. 3D Plants are symbol objects, while Plant Images are two dimensional images.

9 Search

Click the **Search** button at the bottom of the dialog to search for plants that meet your search criteria. The search results display to the right.

10 Search Results

Your search results display here.

- The **Number of Items** that match your search criteria is stated.
- Specify whether you want the search results to use the **Common Name** or **Scientific Name**.
- Click on the name of a plant in the list to see its location in the Library Browser.

11 View Item

Click the **View Item** button to see more information about the selected plant in the Plant Information dialog. See *Plant Image Specification Dialog on page 893*.

Hardiness Zones



Select **Terrain> Plant> Show Hardiness Zones** to view a selection of regional Hardiness Zone Maps. Click the drop-down list at the top left to select various regions.

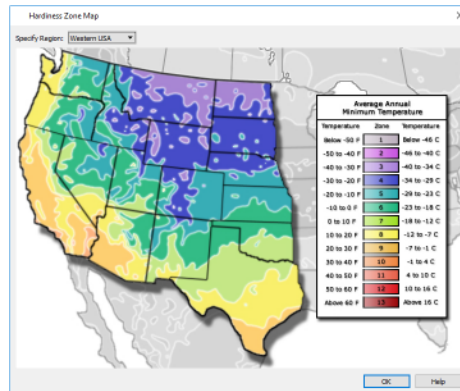

Plant Image Specification Dialog



Select one or more plant images in a plan view or 3D view and click the **Open Object** edit button to open the Plant Image Specification dialog.

This dialog can also be accessed by selecting **Terrain> Plant> Create Plant Image** or by selecting **New> Plant Image** from the Library Browser contextual menu.

The **PLANT INFORMATION** and **PLANT DESCRIPTION** panels are also found in the Plant Information dialog, which can be accessed from the Plant Chooser dialog. See *Plant Chooser Dialog on page 891*.

IMAGE PANEL

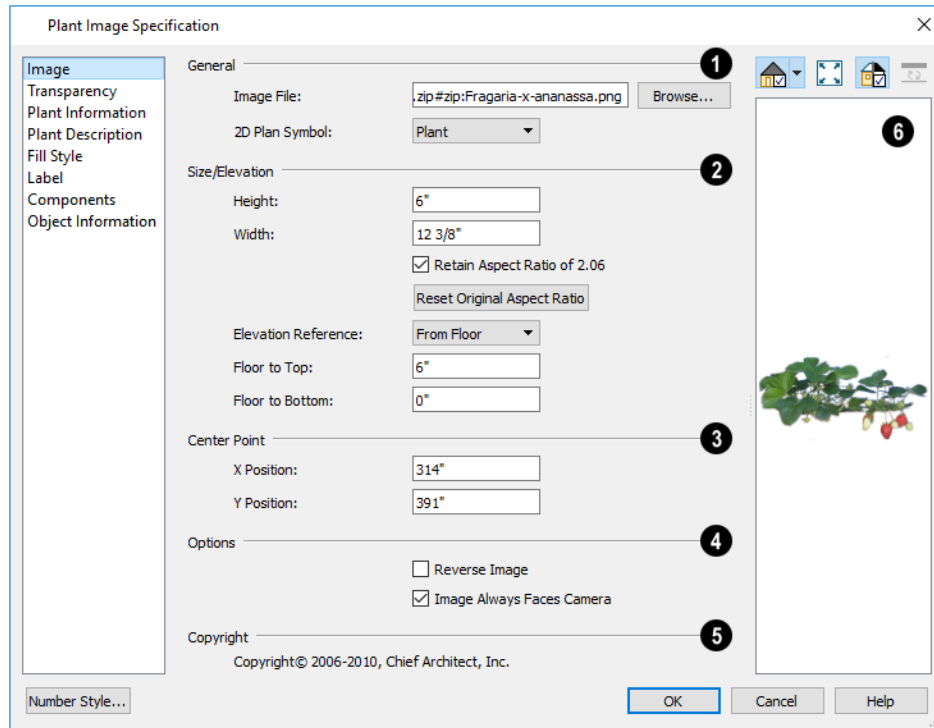

1 General

- The path and name of the selected plant's **Image File** displays here.
- Click **Browse** to specify the saved location on your computer of the image that represents the plant in 3D views.
- A number of **2D Plant Symbols** are available to represent the image in plan view. Select one from the drop-down list.

2 Size/Elevation

Specify the **Size/Elevation** of the plant image, as seen in 3D views.

- Specify the **Height** and **Width** of the image.
- When **Retain Aspect Ratio of** is checked, if you change either the Height or Width, the other value changes to maintain this ratio. If this is unchecked and you resize the plant image, it may become distorted.
- Click **Reset Original Aspect Ratio of** to reset the image's original aspect ratio and remove any distortion caused by resizing.
- Select the **Elevation Reference** from the drop-down list. This determines where the next two settings are measured from and also affects their setting labels.
- Specify the **to Top** distance, measured from the Elevation Reference to the top edge of the image.
- Specify the **to Bottom** distance, measured from the Elevation Reference to the bottom edge of the image.

3 Center Point

Specify the location of the selected plant image's **Center Point**.

- Position the selected plant image in reference to the plan coordinates by specifying its **X Coordinate** and **Y Coordinate**.

4 Options

- Check **Reverse Image** to reflect the appearance of the image about an imaginary vertical line through its center.
- Check **Image Always Faces Camera** to prevent the plant image from rotating with the camera.

5 Copyright

If the selected plant image has been copyrighted, its **Copyright Information** displays here.

6 Preview

A preview of the selected plant image displays here. The Glass House Rendering Technique is not available for plant images. See [Dialog Preview Panes on page 20](#).

TRANSPARENCY PANEL

The settings on the Transparency panel of this dialog are similar to those on the same panel of the Image Specification dialog. For more information, see [Transparency Panel on page 799](#).

PLANT INFORMATION PANEL

The settings on the Plant Information panel correspond to the search parameters in the Plant Chooser. See [Plant Chooser Dialog on page 891](#).

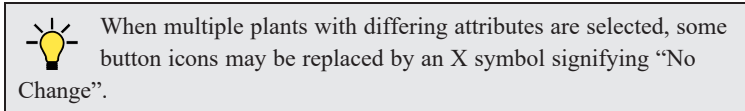

PLANT DESCRIPTION PANEL

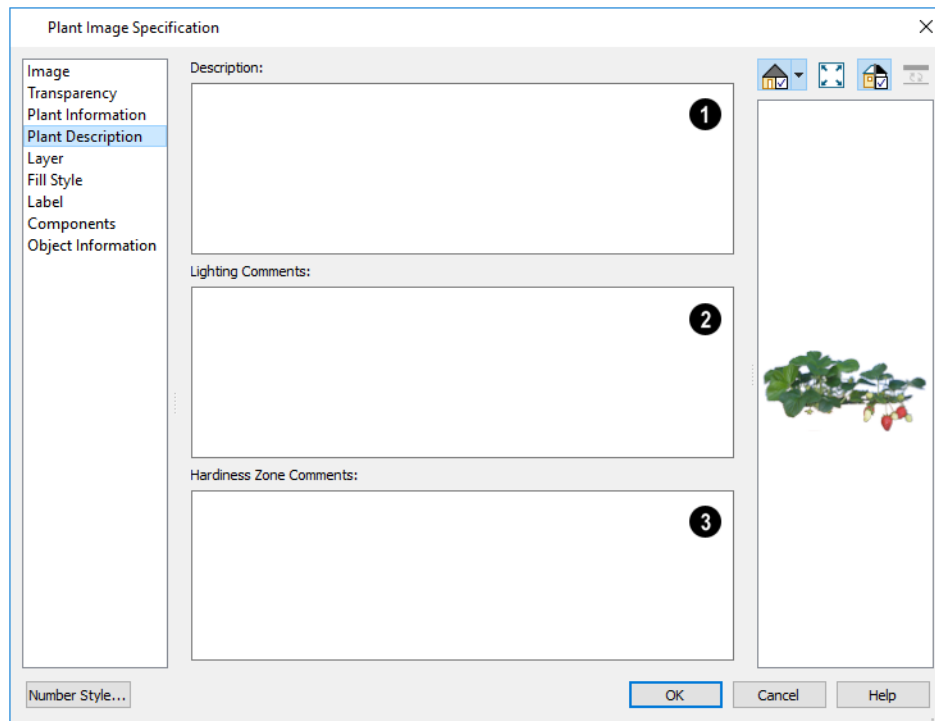

1 Description

A detailed **Description** of the plant displays in this text field.

2 Lighting Comments

Information in the **Lighting Comments** fields describes the plant’s light requirements.

3 Hardiness Zone Comments

Hardiness Zone Comments are given here. See *Hardiness Zones on page 893*.

FILL STYLE PANEL

The Fill Style panel controls the appearance of the selected plant’s 2D Plant Symbol in plan view. By default, plant images’ fill style is None (Transparent). For information about the settings on this panel, see *Fill Style Specification Dialog on page 131*.

If the plant’s 2D Plan Symbol does not form a closed shape, the settings on the Fill Style panel will have no effect on the appearance of the plant in plan view.

LABEL PANEL

Plant labels display in plan view when the “Plants, Labels” layer is turned on and use the Text Style assigned to that layer. See *Label Panel on page 363*.

COMPONENTS PANEL

The information on the COMPONENTS panel can be used in the materials list. For more information, see [Components Panel on page 921](#).

OBJECT INFORMATION PANEL

The information entered on the OBJECT INFORMATION panel can be used in the materials list. For more information, see [Object Information Panel on page 922](#).

Sprinkler Tools



Use the **Sprinkler Tools** to design a sprinkler system in your plan.



Select **Terrain > Sprinkler > Sprinkler Head** to open the Select Library Object dialog. Browse to a sprinkler type in the library, click OK, then click in the drawing area to place as many as you need. Once drawn, sprinkler heads can be selected and edited. See [Sprinkler Specification Dialogs on page 897](#).



Select **Terrain > Sprinkler > Sprinkler Line** to draw sprinkler lines in your plan. Sprinkler lines are 2D objects and are drawn and edited much like CAD Lines. See [Line Tools on page 199](#).

DISPLAYING SPRINKLERS

The display of Sprinkler Heads, Lines and Splines can be controlled in the Layer Display Options dialog. See [Layer Attributes on page 124](#).

In plan view, Sprinkler Head symbols indicate the spray angle.

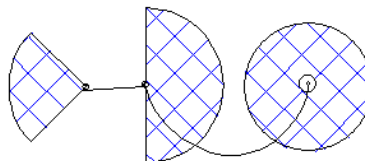

Sprinkler head display in 3D views; however, Sprinkler Lines and Splines do not.

Sprinkler Heads are counted in the Materials List, as is the total length of Sprinkler Lines and Splines. See [Materials Lists on page 904](#).

EDITING SPRINKLERS

Sprinklers can be edited much the way other objects from the library can: using their edit handles, edit tools, and in their specification dialog. See [Editing Library Objects on page 691](#).

Sprinkler Specification Dialogs





To open the Sprinkler Specification dialog, select a sprinkler or group of sprinklers and click the **Open Object** edit button. You can also double-click the sprinkler(s) using the **Select Objects**  tool.

The Sprinkler Specification dialog an example of a Symbol Object Specification dialog. See [Symbol Object Specification Dialogs on page 693](#).

Sprinkler Lines and Sprinkler Splines also have a specification dialog which is very similar to the Polyline Specification dialog. See [Polyline Specification Dialog on page 215](#).

Plant Schedules

 A Plant Schedule is a table that lists all of the plants in your plan and can include a variety of information about them, including quantities, common and scientific names, and growing needs. Schedules are dynamically linked to the plants in your plan and update as they are created, deleted, moved, or modified.

In plan view, select **Terrain> Plant> Plant Schedule** , then click anywhere in the view to place a schedule at that location. You can continue clicking to place additional copies of the schedule. See [Click-to-Create on page 115](#).

Schedules can be edited using the edit handles, the Edit Toolbar buttons, and the Plant Schedule Specification dialog.

USING THE EDIT HANDLES

A selected schedule has edit handles similar to those of a CAD box. See [Editing Box-Based Objects on page 158](#).

In addition, schedules have edit handles that let you control column width:

Plant Schedule		
Number	Qty	Common Names
P01	1	Mint
P02	1	Lavender
P04	1	Thyme



- **Resize Column** edit handles are located in the Title row, centered on the grid lines that divide the columns, and can be dragged left or right. If a column is resized sufficiently small, the text within will wrap to multiple rows.
- **Move Column** edit handles are located in the Heading row, centered in each cell, and can be dragged left or right.
- **Move Row** edit handles are located in the first column, centered in each cell, and can be dragged up or down. See [Editing Schedule Order](#).

 The behavior of edit handles may depend on the currently active Edit Behavior. See [Defaults, Preferences, and Edit Behaviors on page 137](#).

IN THE SPECIFICATION DIALOG

 The contents, Text Style, and other attributes of schedules can be modified in the Plant Schedule Specification dialog. See [Plant Schedule Specification Dialog on page 899](#).

You can control how objects are listed in a plant schedule by specifying which Columns to Include. For example, if you were to include "Flower Color" but exclude "Common Names" and "Scientific Names" in the Schedule Specification dialog, the resulting plant schedule would list all red flowers in one line item, regardless of their species.

You can also control the appearance of the callout labels associated with plants listed in a schedule. See [Object Labels on page 362](#).

USING THE EDIT TOOLS

A schedule can be edited in a variety of ways using the buttons on the Edit Toolbar. See [The Edit Toolbar on page 91](#).

The **Align Left**, **Align Right** , **Center** , or **Justify**  edit tools allow you to specify how the contents of schedule columns are aligned. See [Aligning Text on page 349](#).

Schedule Numbering and Columns

How plants are listed in a schedule is influenced by the order in which they are placed into the plan, as well as by which columns are in use in the schedule.

SCHEDULE NUMBERING

The numbering of plants in schedules is dependent on the order in which they are placed in the plan, as well as the floor they are on.

- Any plants present in your plan before a schedule is created will be listed first in ascending alphanumeric order, according to their Label information.
- A new, unique plant placed in the plan after the schedule is created will be added to the bottom of the schedule in the order that they are placed, regardless of its Label information.

When an object is edited, its schedule number may or may not change:

- If an object with a Quantity of 1 in the schedule is edited, its position in the schedule will not change.
- If a group of objects listed on the same row in a schedule are edited simultaneously, their position will not change.
- If an object listed on the same row in a schedule with other similar objects is edited so that it is no longer similar enough to share the same row, it will move to the bottom of the schedule.

COLUMNS TO INCLUDE



Every schedule has a selection of **Columns to Include** in its specification dialog. See [General Panel on page 900](#).

Information in the **Code**, **Comment**, **Description**, **Manufacturer**, and **Supplier** columns is drawn from an object's specification dialog. See [Object Information Panel on page 922](#).

It is important to remember that the columns you choose to include in a schedule can influence the number of separate line items that will be listed in the schedule.

For example, if you were to include "Flower Color" but exclude "Common Names" and "Scientific Names" in the Plant Schedule Specification dialog, the resulting schedule would list all red flowers in one line item, regardless of their species.

Plant Schedule Specification Dialog

 Plant Schedules and the object labels associated with them can be edited in the Schedule Specification dialog. To open this dialog, either select a schedule and click the **Open Object** edit button or double-click the schedule using the **Select Objects**  tool.

The Schedule Specification dialog has the following panels:

GENERAL PANEL

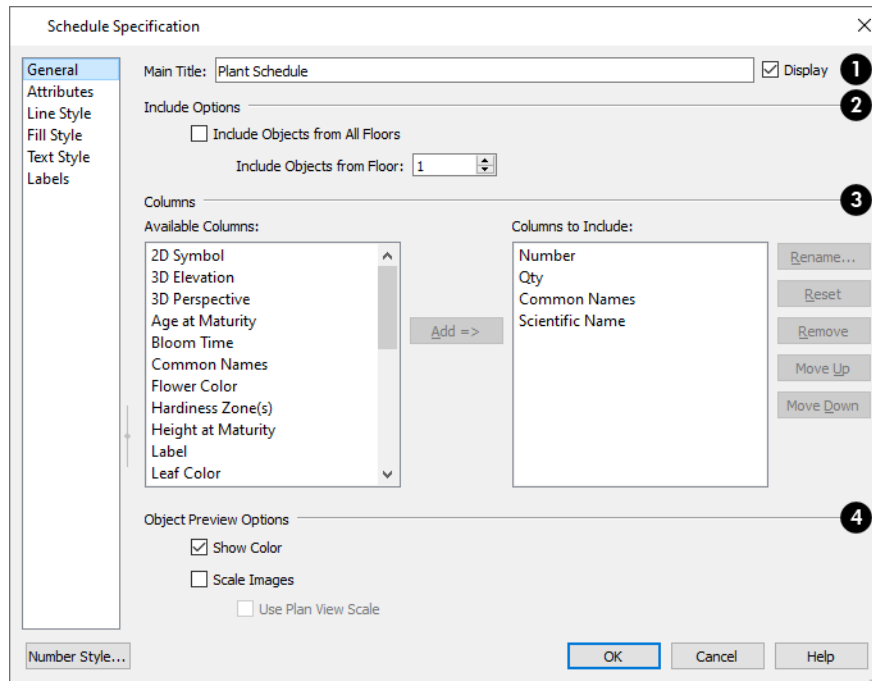

1 Main Title

- Specify a **Main Title** for the selected schedule.
- Check **Display** to include the Main Title at the top of the schedule.

2 Include Options

- To create a schedule of objects on a single floor, uncheck **Include Objects from All Floors** and then specify the floor. When this box is checked, objects from all floors are included.

3 Columns

Specify which columns are included in the selected schedule. See *Schedule Numbering and Columns on page 899*.

- An alphabetical list of **Available Columns** displays on the left.
- Select one or more names in the list of **Available Columns**, then click the **Add** button to add them to the Columns to Include list on the right. See *Shift and Ctrl Select on page 144*.
- You can also double-click on an item in the list to add it to the Columns to Include list on the right.
- A list of the **Columns to Include** in the selected schedule displays on the right. The top-to bottom order in this list corresponds to the columns' left-to-right order in the schedule. At least one column must be included to create a schedule.
- Select or double-click on an item in the list and click the **Rename** button to specify a new name.
- Click the **Reset** button to restore the default names for all Columns to Include in the current schedule.
- Select one or more items in the list, then click the **Remove** button to remove those items from the list.
- Select one item in the list and click the **Move Up** button to adjust its position upward in the list.
- Select one item in the list and click the **Move Down** button to adjust its position downward in the list.

4 Object Preview Options

These options affect the appearance of previews in the 2D Symbol, 3D Elevation, and 3D Perspective Columns, when included in the schedule. See *Schedule Numbering and Columns on page 899*.

- Check **Show Color** to draw 3D Elevation and 3D Perspective object previews using colored lines. When this is unchecked, lines are black and 3D plant previews are shown in grayscale.
- Check **Scale Images** to display object previews at the same relative scale. When unchecked, each preview fills its cell to the extent possible.
- Check **Use Plan View Scale** to apply the same scale used in plan view to the 2D Symbol column.

ATTRIBUTES PANEL

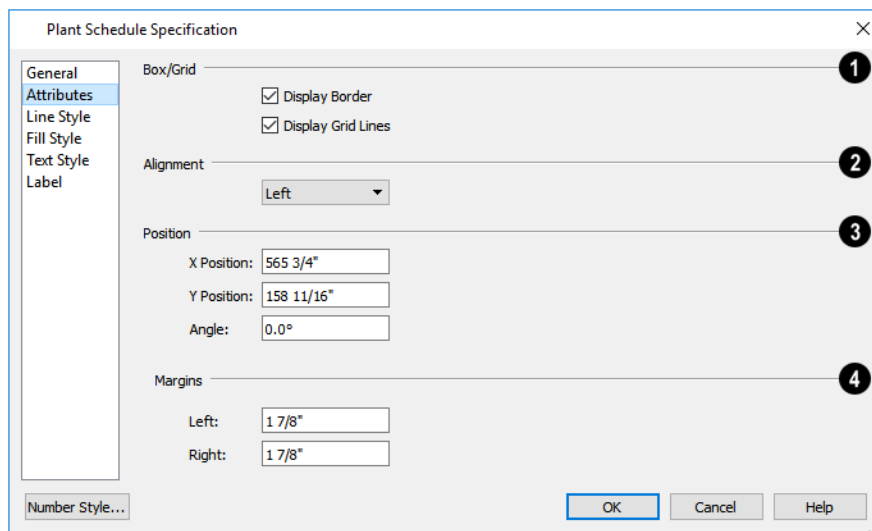

1 Box/Grid

Specify the appearance of the selected schedule's border and grid.

- Check **Display Border** to display lines around the outside of the schedule.
- Check **Display Grid Lines** to display lines around the rows and columns of schedule, forming boxes around each item, or cell.

2 Alignment

Specify the selected schedule's text alignment within its columns by choosing an option from the drop-down list.

3 Position

Define the position of the selected schedule. Not available in the Schedule Defaults dialogs.

- Specify the **X and Y Positions** of the schedule's center point.
- Specify the schedule's **Angle**.

4 Margins

Specify the **Left** and **Right Margins**, which are the distance between the text and border of each schedule cell.

LINE STYLE PANEL

The LINE STYLE panel is found in the specification dialogs for many different objects. For more information, see [Line Style Panel on page 204](#).

FILL STYLE PANEL

For information about the settings on this panel, see [Fill Style Specification Dialog on page 131](#).

TEXT STYLE PANEL

The settings on this panel control the appearance of the selected schedule's text. For more information, see [Text Style Panel on page 361](#).

LABELS PANEL

The LABELS panel of the Schedule Specification dialog controls the type, size and appearance of the labels that display in plan view.

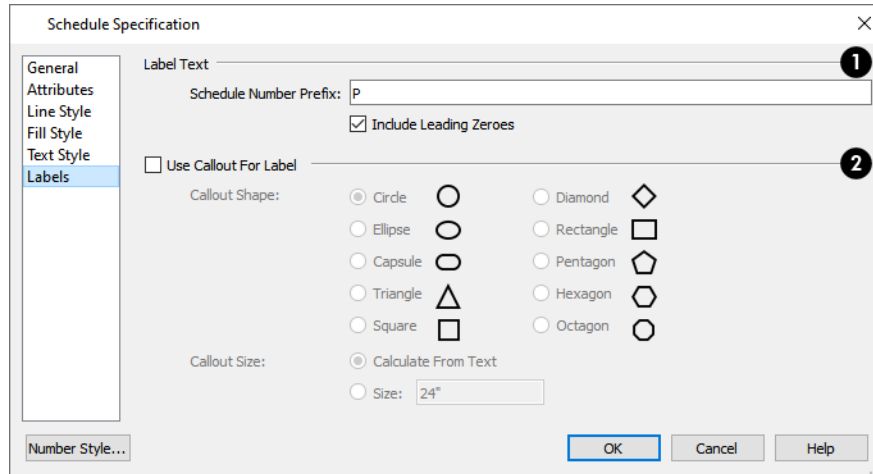

1 Label Text

Additional **Label Text** options are available here.

- **Schedule Number Prefix** - Specify the leading characters used in callout labels or when Include Schedule Number is checked in the object's specification dialog. See [Label Panel on page 363](#).
- When **Include Leading Zeroes** is checked, single-digit callout labels include a zero in front of the callout number. Uncheck this box to remove these leading zeroes from the labels.

2 Use Callout For Label

When **Use Callout For Label** is checked, the callout shape and size can be specified below. When this option is unchecked, Automatic or user specified labels are used. See [Label Panel on page 363](#).

- Select a **Callout Shape**. There are ten shapes to choose from.

When callout labels are used, the schedule numbers are reported in the labels. Like other object labels, callout labels use the Text Style assigned to the layer they are on. See [Text Styles on page 360](#).

Specify the label **Callout Size**:

- Select **Calculate from Text** for callout labels that are sized to accommodate the text within them.
- Select **Size** and then type the radius in inches (mm). This radius will be used regardless of the size of the label text.

Materials Lists

Chapter 37

Home Designer can calculate a Materials List in three ways: **for All Floors, From Area, or for Room.**

Materials Lists can be created, edited, and printed directly from the program. They can also be exported as text, **.xml**, or **.html** files for use in other programs.



The Materials List’s calculations are based on assumptions that may not match your building style. Chief Architect Software makes no representation as to the accuracy or reliability of the Materials List generated by Home Designer Pro. Always compare the Materials List with a manual take-off before providing a quote or ordering materials for a job.

TOPICS

The Materials List Tools	905
Creating an Accurate Materials List	906
Structural Member Reporting	907
Organizing Materials Lists	908
Materials List Specification Dialog	909
Materials List Columns	912
Editing Materials Lists	914
Find Object in Plan	915
Saving and Managing Materials Lists	916
Printing and Exporting the Materials List	916
The Master List	918
Object Components	920
Object Information Panel	922

The Materials List Tools



A Materials List is like a snapshot of the current plan at the time that the list is made. Any changes made to the model after a Materials List is generated are not included in that list. Create a new Materials List if you would like it to include these changes. Select **Tools> Materials List** to access the Materials List tools.

It is not necessary to wait until the plan is complete to generate a Materials List. In fact, you can create a series of Materials Lists reflecting costs at various stages of a project.

When you close a Materials List window, the program will ask if you want to save the Materials List. Type a name and click **Yes** to save the list or click **No** to close the list without saving it. See *Saving and Managing Materials Lists on page 916*.

CALCULATE FROM ALL FLOORS



Select **Tools> Materials List> Calculate Materials for All Floors** to generate a Materials List for the entire model.

Materials lists calculated from all floors can be lengthy, and only a portion of the list may display on your screen at one time. Use the scrollbars to scroll through the complete list. Move the pointer to cells in the list and click to make changes.

CALCULATE FROM AREA



In plan view only, select **Tools> Materials List> Calculate From Area** to produce a Materials List for the portion of a plan on a single floor that is included within a temporary rectangular Materials List Polyline.

To use Calculate from Area

1. In plan view, select **Tools> Materials List> Calculate from Area**.
2. Click and drag to draw a rectangular marquee around the area of the current floor that you would like to produce a Materials List for.
3. When the mouse button is released, a Materials List for the area within the rectangle will display.

Calculate From Area rectangles are temporary and do not display in plan view after the list is created.

CALCULATE MATERIALS FROM SELECTION

Select one or more objects and click the **Calculate Materials From Selection** edit button to create a Materials List that calculates only the selected object(s) and their components.

When the selected object is a room, its moldings and wall, floor, and ceiling finish materials are counted, as is its subflooring; but doors, windows, and structural materials like framing and other structural materials are not.

CALCULATE MATERIALS IN ROOM



To create the Materials List for a room, select the room and then select **Tools> Materials List> Calculate Materials for Room**.

Calculate Materials in Room  is also available on a selected room's edit toolbar. See *Editing Rooms on page 286*.

A Materials List calculated from a room is created for only the contents of that room: wall materials are not included. An object will be counted in the Materials List if its center point is located inside of the room.

CALCULATE STRUCTURAL MATERIALS FOR DECK

 The structural materials for a selected deck can be calculated in a Materials List by clicking the **Calculate Structural Materials for Deck** edit button. Any accessories added on the COMPONENTS panel of a deck's Room Specification dialog will be included in a Materials List created using this tool. See *Decks on page 292* and *Components Panel on page 921*.

MASTER LIST

 Select **Tools> Materials List> Master List** to open the Master List, a list of previously used materials and any added information such as price or manufacturer. See *The Master List on page 918*.

MATERIALS LIST MANAGEMENT

 Select **Tools> Materials List> Materials List Management** to open a list of saved Materials Lists associated with the current plan. See *Saving and Managing Materials Lists on page 916*.

MATERIALS LIST PREFERENCES

 A number of settings that affect the appearance and contents of Materials Lists are found in the Preferences dialog. See *Preferences Dialog on page 59*.

- The MATERIALS LIST panel lets you specify which Categories are initially included in new Materials Lists.
- The REPORT STYLE panel lets you specify which columns are initially included in new Materials Lists, as well as modify the appearance of all Materials Lists.
- The MASTER LIST panel lets you specify the current Master List file and the columns used in it.

Creating an Accurate Materials List

In order to take full advantage of Home Designer's Materials List capabilities, there are several things to keep in mind.

- The accuracy of your Materials List is directly related to the accuracy of your model. Floor and ceiling heights, wall lengths, and structural settings all directly affect Materials List calculations.
- It takes more than just making your drawing look right to generate an accurate Materials List. If, for example, you use CAD lines to draw an item on a floor plan, that item will not be included in the Materials List. A better way would be to use a symbol or structural element. See *Architectural vs CAD Objects on page 111*.
- Specify Components and Object Information before creating a Materials List. Ideally, specify this information in objects' defaults dialogs or in the Library Browser before placing the objects in the plan. See *Object Information Panel on page 922* and *Components Panel on page 921*.
- If you use custom materials, make sure their material definitions are set up correctly. See *Creating Materials on page 721* and *Materials and the Materials List on page 723*.
- Bear in mind that using generic objects like Geometric Shapes from the library can result in items being calculated in the Materials List in a manner that you might not expect. See *Other Objects on page 702*.

OBJECT INFORMATION AND COMPONENTS

Code, Comment, Manufacturer, and Supplier information can be specified for many objects before a Materials List is created. See *Object Information Panel on page 922*.

Price, Extra, Markup, Labor, and Equipment information can also be specified in an object's specification dialog. See [Components Panel on page 921](#).

You can add this information to some objects before they are created in their defaults dialogs. See [Default Settings on page 54](#).

You can also add this information to objects placed from the library. See [Editing Library Objects on page 691](#).

MATERIAL DEFINITIONS

The material assigned to structural components like walls, floors and ceilings, roofs, and slabs determines how each component is calculated in the Materials List. See [Calculation Methods on page 724](#).

FRAMING IN THE MATERIALS LIST

You can specify whether framing materials are calculated by linear foot, as a cut list, or as a buy list in the Structural Member Reporting dialog. See [Structural Member Reporting on page 907](#).

For more information about how framing appears in the Materials List, see [Framing and the Materials List on page 636](#).

Structural Member Reporting



The Structural Member Reporting dialog allows you to specify the default method used to calculate framing members in the Materials List. There are four options to choose from:

There are four Reporting Methods to choose from:

- **Buy List** calculates the framing materials of the different structural components of the plan by counting individual pieces and matching them to common board lengths.
- **Cut List** calculates the framing materials of the different structural components of the plan by counting the individual pieces present in the model.
- **Linear Length** calculates the framing materials of the different structural components of the plan in linear lengths.
- **Mixed Reporting** calculates framing materials using a combination of linear lengths and piece counts and is recommended for saved Materials Lists in legacy plans.

When a Materials List is active, you can use the **Structural Member Reporting Control** drop-down list in the toolbar to choose which method the Materials List uses. This control is not available in the Master List.

STRUCTURAL MEMBER REPORTING DIALOG



To open the Structural Member Reporting dialog, select **Edit> Default Settings**, then select “Structural Member Reporting” from the tree list and click the **Edit** button. See [Default Settings vs Preferences on page 54](#).



You can also open this dialog by selecting **Tools> Materials List> Structural Member Reporting** or by clicking the **Structural Member Reporting** button, which can be added to your toolbars. See [To add a button to a toolbar on page 92](#).

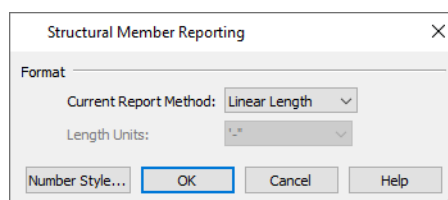

Format

- Select the current **Reporting Method**. The selected method will affect subsequently created Materials Lists, but not any that may already exist.
- Select the **Length Units** that you want to use in the Materials List. Not available when **Mixed Reporting** or **Linear Length** is selected.

Organizing Materials Lists

You can control what items are calculated in the Materials List by specifying which categories are used.

In addition, you can control how much information about each item is included by specifying which columns to display.

You can also use the **Structural Member Reporting Control** drop-down list in the toolbars to choose which method the Materials List uses. See *Structural Member Reporting on page 907*.

There are some parts of a model that cannot be excluded from the Materials List. Floor and ceiling platforms are prime examples. If you need to generate a Materials List for only part of a plan, such as an addition, consider making a copy of the plan file. In the copy, delete the as-built portion of the plan and then generate a Materials List.

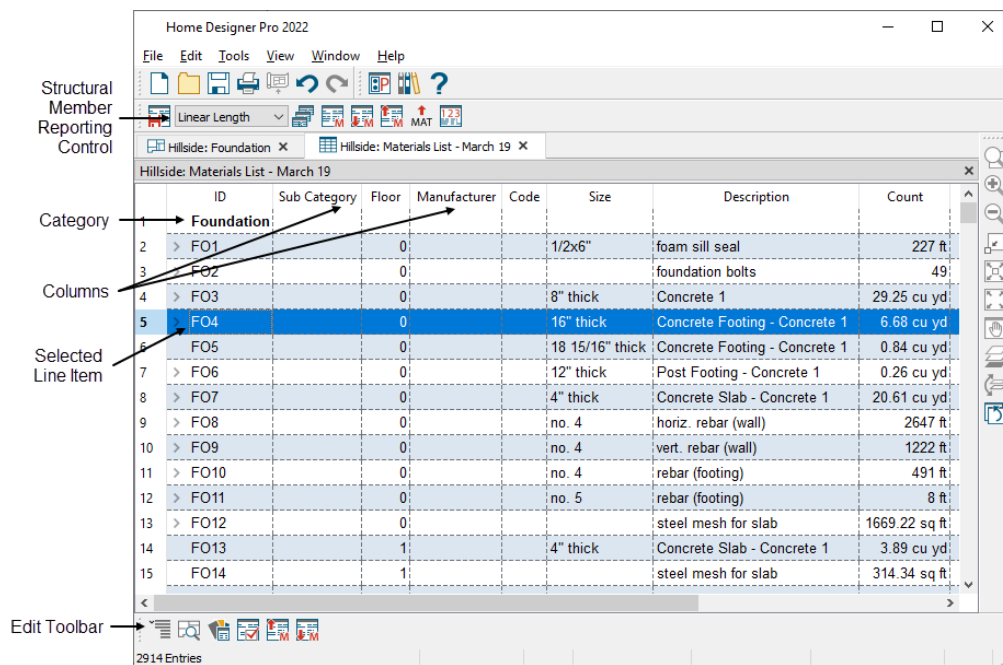

CATEGORIES

The line items in the Materials List and Master List are organized into a set of predefined categories, such as Electrical and Framing, which display in the **ID** column.

You can specify which category each item belongs to in the Materials List and Master List. In addition, many objects can be assigned to a category prior to generating a Materials List in their specification dialog. See *Components Panel on page 921*.

To specify a line item's category

1. Create a Materials List, open the Master List, or open an object's specification dialog and go to the COMPONENTS panel.
2. Click in the cell in the ID column for a line item.
3. Select the desired category from the drop-down list that becomes available.

The categories that are available cannot be altered; however, you can specify which categories are included in the Materials List in either of two ways:

- Globally, in the Preferences dialog. See [Materials List Panel on page 81](#).
- For individual lists in the Materials List Specification dialog. See [Materials List Specification Dialog on page 909](#).

SUBCATEGORIES

By default, the Subcategory column of the Materials List is empty for all line items. You can add text to any Subcategory cell by clicking in the cell and typing.

Items can be assigned to a subcategory in the Materials List and, for many items, in their object's specification dialog in the same manner that they can be assigned to a category. See [Components Panel on page 921](#).

MATERIALS LIST COLUMNS

Each column in the Materials List reports a different category of information about objects in the list. You can specify most of this information for a variety of objects prior to generating a Materials List. See [Object Components on page 920](#).

There are two ways to specify which columns are included in the Materials List as well as the order in which they display:

- Globally, in the Preferences dialog. See [Report Style Panel on page 82](#).
- For individual lists in the Materials List Specification dialog. See [Materials List Specification Dialog on page 909](#).

DETAILS DIALOG

 For information about one or more selected line items in a Materials List, click the **Details** edit button. The Details dialog displays all Materials List columns for reference, which can be helpful when not all columns are in use in the Materials List. It also lists the Source Object of the selected line item or items.

This dialog will also open when multiple objects located on more than one floor are selected in a Materials List and you click the **Find Object in Plan**  edit button. See [Find Object in Plan on page 915](#).

When one or more line items located on the same floor are selected, click the **Find** button at the bottom of the dialog to view their location in a plan view window.

Materials List Specification Dialog

 When a Materials List or the Master List is open, select **Tools> Materials List Specification** to open the Materials List Specification dialog for the current list.

The Master List Specification dialog is similar to this dialog, but only the COLUMNS panel is available. See [The Master List on page 918](#).

CATEGORIES PANEL

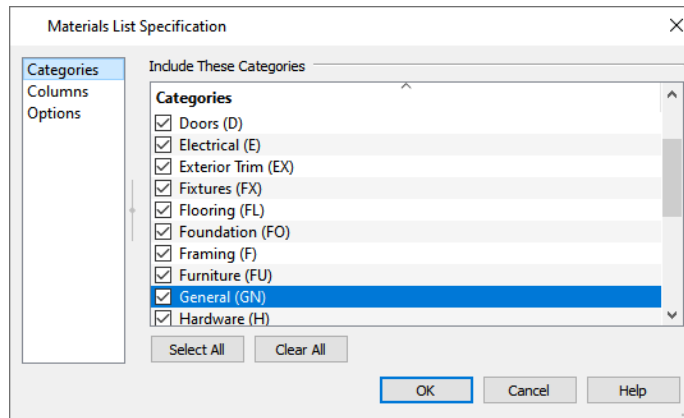

The Categories listed here appear in the ID column of the Materials List in the order they are presented here.

- Check the box beside the name of each category that you want to display in the currently active Materials List.
- Click the **Select All** button to display all categories in the active Materials List.
- Click the **Clear All** button to suppress the display of all categories in the active Materials List.
- Multiple rows can also be selected together using Shift and Ctrl keys. See *Shift and Ctrl Select on page 144*.

Note: The information in a suppressed category is still part of the Materials List. If the Materials List is exported, suppressed categories are exported, as well.

COLUMNS PANEL

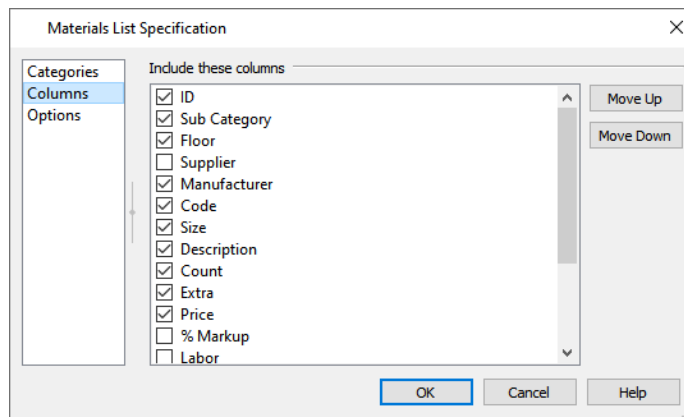

- Check the box beside each column you want to include in the Materials List. To suppress a column's display, remove the check mark next to its name. Columns appear in the Materials List in the order that they display in this list.
- **Move Up** - Click on a column name, then click this button to move that item up one place in the list.
- **Move Down** - Click this button to move the selected column down in the list.

OPTIONS PANEL

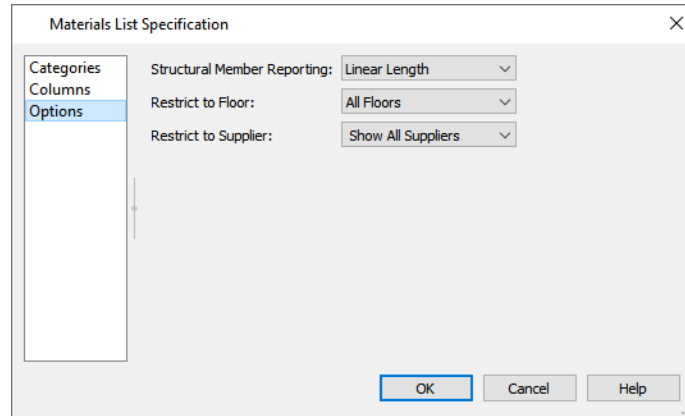

- Select a saved **Structural Member Reporting** default from the drop-down list to specify how framing members are counted and reported. See *Structural Member Reporting Dialog on page 907*.
- Select a floor level from the **Restrict to Floor** drop-down list to limit the current Materials List to objects on that floor. When "All Floors" is selected, the Materials List includes objects from all floors.
- If you plan to buy materials from multiple suppliers, you can create a Materials List for each. Select an option from the **Restrict to Supplier** drop-down list to only list items associated with the selected supplier; select "Show All Suppliers" to list all items, including those with no supplier; or select "Show Only No Supplier" to only list items that do not have a supplier. Suppliers can be added to this list in the specification dialog for various objects. See *Object Information Panel on page 922*.

Materials List Columns

The columns in the Materials List and the Master List are very similar, but not all columns appear in all places.

The following table lists the capabilities of each column:

Column	Available In	Editable In	Description
ID	Materials List, Master List, Components Panel	Materials List, Components Panel	Displays an automatically generated identifier for each line item. Select the cell in this column to change an item's category.
Use	Master List	Master List	A check box beside for line item indicates if it is included in the Materials List.
Sub Category	Materials List, Components Panel	Materials List, Components Panel	Select a cell in this column to change a line item's subcategory.
Floor	Materials List	N/A	States the floor that the line item is located on. See <i>Multiple Floors on page 501</i> .
Label	Materials List, Master List, Components Panel	Materials List	Lists the label that displays in plan view for most items that have labels associated with them. See <i>Label Panel on page 363</i> .
Supplier	Materials List, Master List, Components Panel	Materials List, Master List, Components Panel	Specify a supplier for the item. A Supplier in the Master List is not used if one has been entered in the object's specification dialog.
Manufacturer	Materials List, Master List, Components Panel	Materials List, Master List, Components Panel	Specify a manufacturer for the item. A Manufacturer in the Master List is not used if one has been entered in the object's specification dialog.
Code	Materials List, Master List, Components Panel	Materials List, Master List, Components Panel	Specify a Code, such as an SKU, for the item. A Code in the Master List is not used if one has been entered in the object's specification dialog.
Size	Materials List, Master List, Components Panel	Materials List, Components Panel	Click in a cell to edit the size description of the line item. To restore the original size, delete the text you typed in. For a blank cell, type a single blank space.
Description	Materials List, Master List, Components Panel	Materials List, Components Panel	Click in a cell to edit the description of the line item in the same way that the Size can be edited.



Column	Available In	Editable In	Description
Quantity	Master List	Master List	Specify how many of an item must be found before information from the Master List is applied to it in a Materials List. If at least this many items are found, price, supplier, and other information is used.
Count	Materials List, Components Panel	Components Panel	This is the actual number of an item, either associated with the selected object or in the Materials List. Count can be increased for accessories added to a selected object.
Extra	Materials List, Components Panel	Materials List, Components Panel	Specify an additional amount of the line item. Changes made in the object's specification are reflected in the Count column in the Materials List.
Price	Materials List, Master List, Components Panel	Materials List, Master List, Components Panel	This is the per-unit price of an item. A Price in the Master List is not used if one has been entered in the object's specification dialog.
% Markup	Materials List, Master List, Components Panel	Materials List, Master List, Components Panel	Specify a markup percentage for the item. A markup in the Master List is not used if one has been entered in the object's specification dialog.
Labor	Materials List, Master List, Components Panel	Materials List, Master List, Components Panel	Specify a labor cost for the item. A Labor value in the Master List is not used if one has been entered in the object's specification dialog.
Equipment	Materials List, Master List, Components Panel	Materials List, Master List, Components Panel	Specify an equipment cost related to the item. An Equipment value in the Master List is not used if one has been entered in the object's specification dialog.
Total Cost	Materials List, Components Panel	Materials List, Components Panel	This is the total cost based on Count, Price, % Markup, Labor and Equip values.
Default	Master List	Master List	Click in this column to specify the line item as the default when more than one item is available.
Comment	Materials List, Master List, Components Panel	Materials List, Master List, Components Panel	Additional information related to the item can be entered here. A Comment in the Master List is not used if one has been entered in the object's specification dialog.

Column	Available In	Editable In	Description
Accounting Code	Materials List, Master List, Components Panel	Materials List, Master List, Components Panel	The Accounting Code information is used if a plan file is opened in Chief Architect X13 and a materials list is exported for use in BuilderTREND software.

Editing Materials Lists

Materials lists can be edited in a variety of ways. You can adjust the width of a column by clicking and dragging the bar on the right side of the column name.

EXPAND AND COLLAPSE ROWS

  If a line item has an arrow to the left of its name in the ID column, it represents multiple individual objects. Click the **Expand** edit button to display these individual objects as separate line items; click the **Collapse** edit button to hide them. You can also click the arrow to the left of the name to expand or collapse the line items.

ADDING INFORMATION

You can enter information in the Price, Supplier, Code, Comment and Manufacturer columns for each line item.

Adding price or other information for any item is straightforward. Simply click in the cell and type the desired information. When the information is correct, you can add it to the Master List. See [Adding to the Master List on page 919](#).

You can switch between several existing suppliers or manufacturers for a given item by double-clicking on the right side of the cell in an appropriate column. A drop-down arrow displays to the left of the cell. Click it to view a list of suppliers or manufacturers for that item and select one.

When a Materials List is calculated, you can have the program search the Master List for Price, Supplier, and Code information for each item by selecting **Tools> Update From Master** . The information used is marked as “Default” in the Master List.

CHANGING INFORMATION

Although the information in some columns cannot be saved to the Master List, you can change the information in any column in an individual Materials List. As with added information, click in a cell to select the existing text, then type in the desired text.

To move an item in a Materials List to a new category, select the cell in the **ID** column and choose a new category from the drop-down list that becomes available. You can also select a subcategory by clicking in the cell in the **Sub Category** column. See [Categories on page 908](#).

CHANGING COUNT UNITS

The material for a given object component will be counted either by piece; linear feet or meters; square feet or meters; or cubic yards or meters. The same method and unit used in the Count column will be used in the Extra column.

When the Count is linear, area, or volume, you can choose a different unit of measurement:

- Double-click in a cell in the Count column to select and edit it, then choose a unit of measurement from the drop-down list to the right of the selected cell.
- You can also click the **Number Formatting**  button when a Count cell is selected to specify the units and accuracy of the value in the selected field. The specified unit is also used in the Extra field for that row. See *Number Formatting Dialog*, below.

TOOL TIPS

Whenever you mouse over a cell in the Count column, a Tool Tip will display, providing information about the cell's contents. When the Count is a total length, area, or volume, it may be rounded. The Tool Tip will show the value with greater accuracy.

TOTAL COST

Total Cost for a line item is calculated using the Count, Price, % Markup, Labor and Equipment columns to calculate the cost. The formula used is:

$$(\text{Count} + \text{Extra}) * \text{Price} * (1 + (\% \text{ Markup}/100)) + ((\text{Count} + \text{Extra}) * \text{Labor}) + ((\text{Count} + \text{Extra}) * \text{Equipment})$$

If a column does not appear, 0 is used for the value of that column with the exception of Count and Price, which are always used in the calculation even if they are not shown.

COPYING INFORMATION

Portions of a Materials List can be copied and then pasted into a **Text**  object or into a word processing program or spreadsheet program using the standard Windows Copy (Ctrl + C), Cut (Ctrl + X), and Paste (Ctrl + V) commands. See *Copying and Pasting Text on page 350*.

CHANGING THE FONT

The font used for Materials Lists and the Master List can be specified in the Preferences dialog. See *Font Panel on page 64*.

The size of this font can also be specified in the Preferences dialog. See *Report Style Panel on page 82*.

Find Object in Plan

 To find out where a line item in the Materials List is located in the model, select its row or any cell in its row and click the **Find Object in Plan** edit button. This tool opens a view window and selects the object or objects associated with that line item.

If a plan view showing the floor that the object is on is open, that view will become active and the object will be selected. If no such view is open, a new view showing the object's floor will be created. See *View Windows on page 102*.

If the selected item is a component of a complex object like an Auto Dormer, Mulled Unit, Bay Window, or Architectural Block, the parent object will be selected in the plan instead of the individual component.

If the selected row or rows in a Materials List refer to objects on different floors, the Details dialog will open when you click the **Find Object in Plan**  edit button. See *Details Dialog on page 909*.

Saving and Managing Materials Lists



To save an open Materials List, select **Tools > Save Active Materials List**. If the Materials List has not been previously saved, the Save Materials List dialog will open, allowing you to type a short, descriptive name for the list. You will also be prompted to save a Materials List when you close its window.

Once a Materials List has been saved, it is listed in the Materials List Management dialog.

MATERIALS LIST MANAGEMENT DIALOG



Select **Tools> Materials List> Materials List Management** to open the Materials List Management dialog.

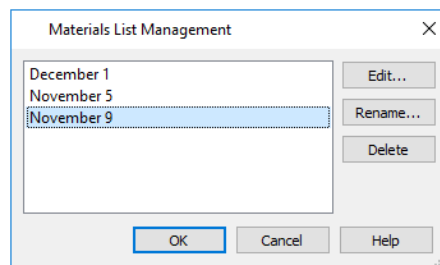

Click on the name of a saved Materials List in the list on the left to select it.

- **Edit** - Open the selected Materials List. You can also double-click an item in the list.
- **Rename** - Open the Rename Materials List dialog and type a new name for the list.
- **Delete** - Remove the selected Materials List from the current plan.

Printing and Exporting the Materials List



To print a Materials List, select **File> Print** while the Materials List window is active. See *Print View Dialog on page 955*.



A Materials List can also be exported into a one of several different file formats that can be opened by various programs. In a Materials List window, or in the Master List, select **File> Export Materials List** to open the Export Materials List dialog.

EXPORT MATERIALS LIST DIALOG

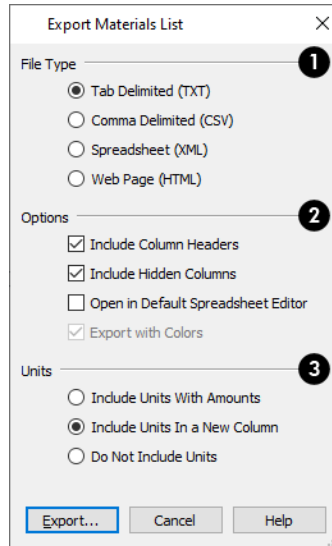

1 File Type

Specify the **File Type** that you would like to export to.

- Select **Tab Delimited (TXT)** to create a text file with a tab between each field entry in the Materials List, and a carriage return between each row.
- Select **Comma Delimited (CSV)** to create a text file with a comma between each field entry in the Materials List and a carriage return between each row.
- Select **Spreadsheet (XML)** to create a file that can be opened by Microsoft Excel.
- Select **Web Page (HTML)** to create an html file that you can view with a web browser.

2 Options

Additional export options are available here.

- Uncheck **Include Column Headers** to prevent column headings from appearing in the first row of the exported file. Column headers are always included in HTML files.
- Uncheck **Include Hidden Columns** to only export columns currently displayed in the active Materials List. When this is checked, all columns are exported, regardless of whether they are currently displayed.
- Check **Open in Default Spreadsheet Editor** to open the exported file with the program specified on your computer when you finish exporting.
- When XML or HTML is selected above and **Export with Colors** is checked, the Color Theme or Custom Colors used in the Materials List are exported. When unchecked, the default system colors are exported. See [Report Style Panel on page 82](#).

3 Units

Specify how **Units** of measurement are exported. Currency information is always exported, regardless of the option chosen here.

- Select **Include Units with Amounts** to include units in the same column as the associated value.
- Select **Include Units in a New Column** to report units as text in a new column.
- Select **Do Not Include Units** to not export units at all.

When you click OK, the Write Materials Export File dialog will open. This is a typical File Save dialog. See [Exporting Files on page 38](#).

ESTIMATING SOFTWARE

You can export a Materials List to a word processor or spreadsheet program to arrange it in your estimating format. You can also export the Materials List to a number of commercial estimating programs in whose databases you can keep your current pricing, labor costs, and markups and generate reports based on this data.

Before purchasing an estimating software program, be sure that the program supports the direct import of Chief Architect Materials Lists.

Any questions regarding estimating software packages and how they interact with Home Designer should be directed toward the company providing the estimating software. Chief Architect Software is unable to provide any technical support for third party programs.

The Master List



The **Master List** saves price, supplier, manufacturer, and other information about items in your Materials Lists and allows you to apply that information to items in future Materials Lists. Select **Tools> Materials List> Master List** to open the Master List.

Home Designer Pro allows you to have more than one Master List. Only one can be active, however, and only the active list is updated with new information. You can specify which Master List is active in the Preferences dialog. See [Report Style Panel on page 82](#).

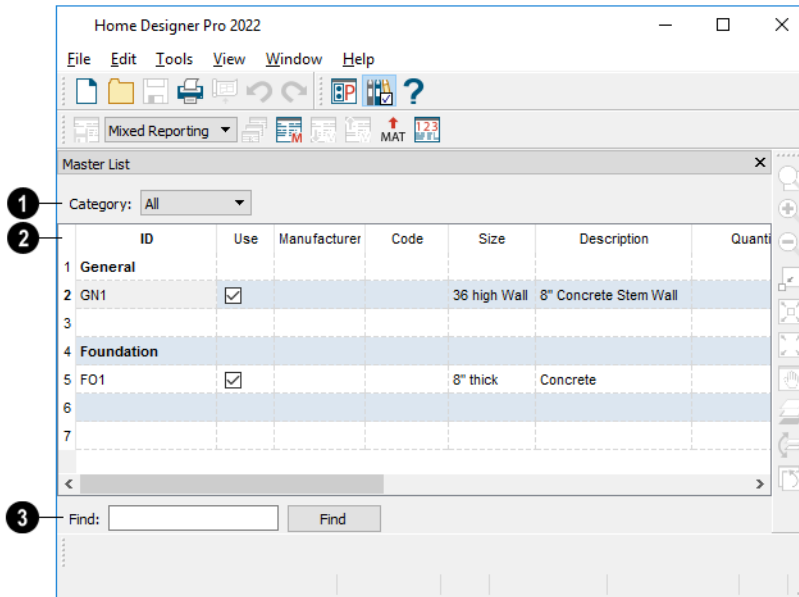

1 Category

The **Category** drop-down list at the top left corner of the window lets you select one particular category for display, or all categories.

2 Columns

As with individual Materials Lists, you can specify which columns display in the list. See *Materials List Specification Dialog on page 909*.

3 Find

Use the **Find** field near the bottom of the window to search for text in the Master List.

The search starts from the currently selected cell and moves to the right, then moves down to the next row starting at the left column, and so on, until it finds an instance of the text you entered.

ADDING TO THE MASTER LIST

You can edit line items in a Materials List and then add them to the Master List for future use.

To use Update to Master

1. Create a Materials List and change or add information in any editable column of a line item.
2. Select the line item by clicking on its line number on the left side of the list. When selected, then entire line becomes highlighted.
3. Select multiple adjacent rows by holding down the Shift key while clicking.
4. Select **Tools> Update to Master**. The information in the selected line is saved in the Master List.
 - If an item in the Master List has the same ID, Size, Description, and Label information as the selected line item, it will be updated.
 - If no item in the Master List matches the selection, a new line item in the Master List will be created.

Once Master List information exists for a particular item, you do not need to enter it again until you want to update it.

UPDATE FROM MASTER

Similarly, items in a Materials List can be updated to include information in the Master List.

To use Update from Master

1. When a Materials List is active, click on a row number to select the row.
2. Select **Tools> Update from Master** to have the program search the Master List for a record for the selected line item. If an identical record is available, its information is included in the Materials List.
 - Multiple rows can be selected by clicking on one row number, then holding down the Shift key and clicking on additional row numbers.
 - Select all rows by clicking the cell at the top left corner of the Materials List, above the row numbers.

If the Master List contains more than one record for an item, the program references the last one entered. You can override this by defining one specific entry as the default. This is achieved by clicking on the check box in the Def column.

The **Master List** is almost identical to a Materials List, but has a few additional controls to help with viewing.

EDITING THE MASTER LIST

In the Master List, existing line items can be modified or deleted.

Often, the Master List will include items that you may not want to include in all Materials Lists.

- Check boxes in the **Use** column indicate whether each item is included in the Materials List. If **Use** is unchecked, the item is not included. This is useful in cases where several line items will be purchased as a single unit.
- This **Quantity** column is used to specify how many of an item must be found before information from the Master List is applied to it in a Materials List. If at least this many of the item are found, price, supplier, and other information is used. **Quantity** is useful for applying a quantity discount.
- When more than one line item is available for a specific component or accessory, the **Default** column indicates which item is to be used. Click this column to specify this item as the default. This is useful when a line item has been updated to the Master List more than once with different price, supplier or other information.

To delete a row from the Master List, click on the row number at the far left. The entire row highlights. Select **Edit> Delete**, click the **Delete** button, or press the Delete key on your keyboard.



You should regularly back up your Master List (mmaster.mat) or lists. See [Backing Up Your Files on page 39](#).

Object Components

Many architectural objects in the program, from walls to cabinets to images, have components associated with them that are calculated in the Materials List. For example, base cabinets have cabinet box and countertop components.

In addition to their components, some objects also have subcomponents. Cabinet boxes, for example, have doors, drawers and hardware.



Component information for Plant images can be listed in Plant Schedules. See [Plant Schedules on page 898](#).

Components and subcomponents are specified on the COMPONENTS panel of many object specification dialogs.

You can also add and edit information for objects and their accessories in the Materials and Master Lists. See [Editing Materials Lists on page 914](#).

COMPONENTS PANEL

Select one or more objects of the same type and click the **Open Object** edit button to open their specification dialog.

The information on the COMPONENTS panel can also be edited for objects in the User Catalog of the Library Browser. See [Editing Library Objects on page 691](#).

The information on the COMPONENTS panel is the same as the Materials List line item(s) for the selected object.

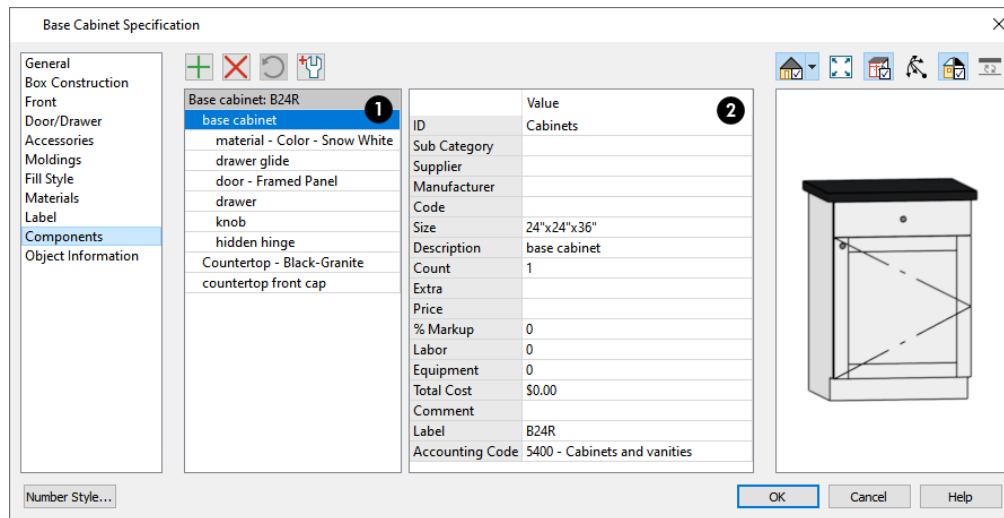





The selected object's components and their attributes are listed in two tables.

1 Components

The selected object's components and subcomponents are listed here.

- Subcomponent names are indented to help distinguish them from main components.
- Click on a line item to select it and display its Materials List information to the right.

The buttons above the table allow you to manage this list.

- When a component is selected, click the **Add Line Item**  button to add a new component to the list. When a subcomponent is selected, a new subcomponent is created instead.
- Click the **Remove Line Item**  button to remove the selected line item from the list.
- Click the **Restore**  button to return to the list any previously removed components or subcomponents. Only available when line items have been removed. User-created line items that have been removed are not affected by this option.
- Click the **Revert**  button to reset any Values customized below. In the Cabinet Specification dialogs, they are reset to the values set in the corresponding Cabinet Defaults dialog; in the Cabinet Defaults dialogs, they are reset to the system defaults.

2 Materials List Data

- The left column is a list of column headings found in the Materials List. See *Materials List Columns on page 909*.
- The **Value** for each Materials List column can be specified in the right column.

Additional information about how values are calculated may display below the table for some objects: notably, rooms and terrain features.

Note: The Label can be edited on the Label panel of the object's specification dialog. See *Label Panel on page 363*.

Object Information Panel

The OBJECT INFORMATION panel is found in the specification and defaults dialogs for a variety of different objects. The settings on this panel let you specify information that can then be included in the Materials List and in Plant Schedules. See *Materials List Columns on page 912* and *Schedule Numbering and Columns on page 899*.

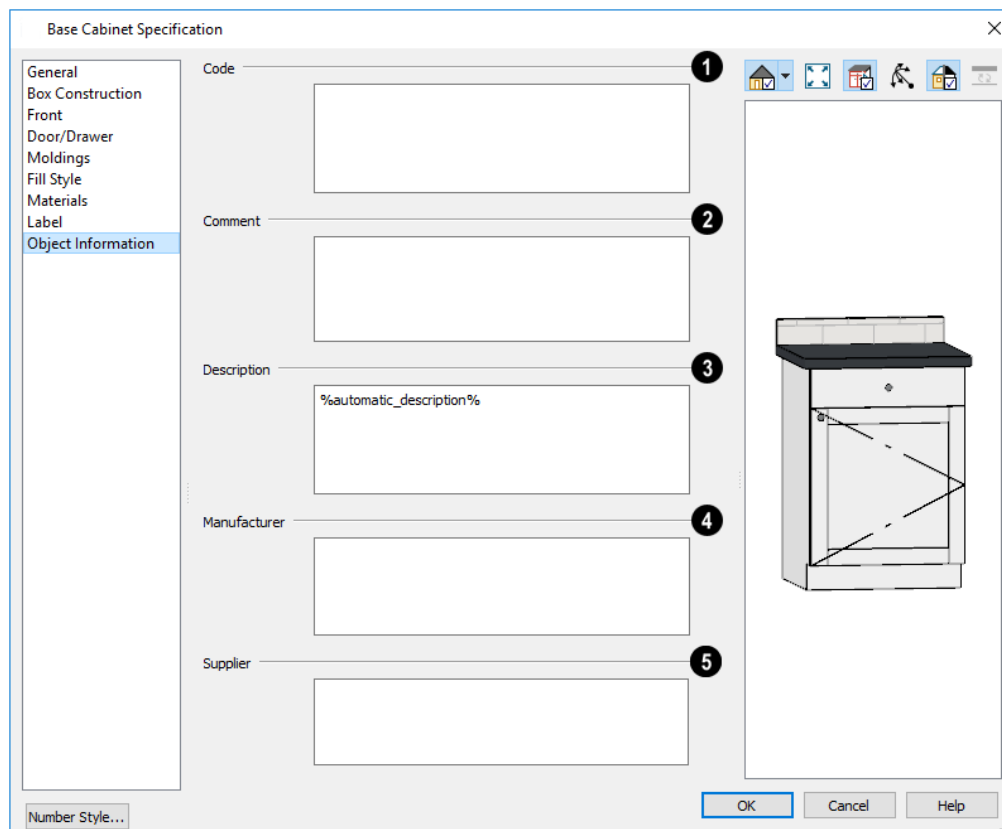

1 Code

Specify a **Code**, such as an SKU, for the selected object.

2 Comment

Specify a **Comment** for the selected object.

3 Description

Specify a **Description** for the selected object.

4 Manufacturer

Specify the selected object's **Manufacturer**.

5 Supplier

Specify the selected object's **Supplier**.

Layout

Chapter 38

The Home Designer Pro layout facility provides a set of easy to use tools for creating printed construction documents. You can create your own title block and border, then arrange multiple views of a plan, notes, and more on a page for printing.

Each layout file has a single page, which can contain multiple views, details, images, CAD objects, or text.

For detailed information about printing in Home Designer Pro, see *Printing and Plotting on page 939*.

TOPICS

Layout Preferences and Defaults	925
The Layout Tools	925
Creating a Layout File	926
CAD and Text in Layout	926
Pictures, Metafiles, and PDFs in Layout	927
Sending Views to Layout	927
Keeping Layout Views Current	929
Displaying Layout Views	932
Editing Layout Views	932
Layout Box Specification Dialog	934
Opening Layout Views	935
Managing Layout Links	936
Printing Layout Files	938
Exporting Layout Files	938

Layout Preferences and Defaults



You can specify the background color of the drawing area in layout files on the **COLORS** panel of the Preferences dialog. See *Colors Panel on page 62*.



To access the layout defaults for the current layout file, select **Edit> Default Settings**. The options in the Default Settings dialog are similar to those found in this same dialog in a plan file, although there are fewer choices in the list. See *Default Settings on page 54*.

DRAWING SHEET SETUP

The settings in the Drawing Sheet Setup dialog are file-specific and are particularly important considerations in layout files. See *Drawing Sheet Setup Dialog on page 943*.

LAYOUT PAGE DISPLAY OPTIONS



Select **Tools> Layer Settings> Display Options** to open the Layout Page Display Options dialog.

This dialog is similar to the Layers Display Options dialog, but controls only the display of objects drawn on the layout page, such as CAD objects, text, dimensions, and imported objects. The display of layout view boxes is also controlled by the Layout Page Display Options - but not the objects within those views.

For information about how to use this dialog, see *Layer Display Options Dialog on page 126*.

For information about controlling the display of objects in views sent to layout, see *Displaying Layout Views on page 932*.

The Layout Tools



There are a variety of tools available to send views to layout and edit them, as well as manage links.

Many of the tools available in layout are described in the Printing chapter. See *The Printing Tools on page 942*.



Select **File> Send to Layout** to open the Send to Layout dialog and send the current view to layout. See *Sending Views to Layout on page 927*.



In plan view, select a saved cross section/elevation view symbol and click the **Send Camera's View to Layout** edit button. See *Saving and Printing 3D Views on page 759*.



Select a layout view and click the **Open View** edit button to open the view that was originally sent to layout. This tool is only available for dynamic views. See *Editing Dynamic Views on page 933*.



Select **Edit> Delete Objects** to delete categories of objects from the current layout file. See *Delete Objects Dialog on page 188*.



Select **Window> Swap Views** to switch between the current view and the view that was current before it. See *Working in Multiple Views on page 103*.

Creating a Layout File



To open an existing layout file, select **File> Open Layout**. Browse to a directory and select the layout file to open. See [Opening and Importing Files on page 41](#).

As with plan view windows, when a layout file is open, it is listed at the bottom of the Window menu as an open view. See [Working in Multiple Views on page 103](#).

In order to create a layout file, you must open a new file and then save it.



Choose **File> New Layout** to create a blank layout file. A layout file is created with the name **untitled.layout**.



Select **File> Save** to save the layout file. It is important that you save the layout in the same directory as the plan file from which views will be or have been sent to the layout pages. See [Organizing Your Files on page 33](#).

Although it is possible to use multiple plan files with a layout, it is generally best to associate only one plan file with a layout and to use the same file name for both. If more than one plan file is used, all should be saved in the same directory as the layout file.

When you save your layout, take a moment to also save the plan file associated with it.



When a view is sent to layout, the plan and layout files become linked. If you rename or move either file, this link will be broken and the view will not display. See [Managing Layout Links on page 936](#).

CAD and Text in Layout



CAD objects, text objects, as well as dimensions can be incorporated into your layout by both including them in your views sent to layout and by drawing them on the layout page.

ON THE LAYOUT PAGE

CAD and text can be drawn directly on the layout page, allowing you to create a title block, border, as well as notes and other annotations.

You can draw dimension lines on the layout page to help position CAD and text objects, as well. Dimensions that locate objects in a view sent to layout, however, should be drawn in the original view. See [Dimensions on page 311](#).

CAD, text, and dimensions created in layout can be selected, edited, and deleted just as they can in other views. See [Editing Text on page 347](#) and [CAD Objects on page 192](#).

Pictures and PDFs can also be imported into layout. See [Pictures, Images, and Walkthroughs on page 794](#).

IN VIEWS SENT TO LAYOUT

CAD, text, and dimensions in views sent to layout are scaled just like other objects in the view. If you want text in a layout view to print at a particular size, specify its size based on the scaling you will use when you send the view to layout. See [Character Size on page 339](#).

If you rotate a view on the layout page, any text in that view will rotate as well, provided that its Text Style is using the **Rotate with Plan** setting. See [Text Styles on page 360](#).

Pictures, Metafiles, and PDFs in Layout

Picture files, metafiles, and PDF files can be included in views sent to layout or imported directly onto a layout page. See [Displaying Pictures, Metafiles, and PDF Boxes on page 809](#).

Views can also be sent to layout as pictures embedded in the layout file. See [Static Views on page 931](#).

A picture or metafile imported onto the layout page can be selected and edited using its edit handles, edit tools and specification dialog. See [Editing Pictures, Metafiles, and PDF Boxes on page 810](#).



Embedded pictures and pdf files increase layout file size. Limit the number of large and/or multiple pictures.

Sending Views to Layout

 Layout files can contain multiple views sent from one or more plan files. To send the active view from a plan file to layout, select **File> Send to Layout**.

 You can also send one or more saved, closed cross section/elevation views to layout by selecting the camera symbol and clicking the **Send Camera's View to Layout** edit button. This edit tool is only available when the selected view has been saved, has not previously been sent to layout, and is not open. See [Saving and Printing 3D Views on page 759](#).

To send a view to layout

1. Prepare the view so that the desired layer, default, and other settings are in use. See [Dynamic Views on page 930](#) for more details.
2. Select **File> Send to Layout** . In the Send to Layout dialog, the available options vary depending on the type of view being sent to layout.
3. Click **OK** to send the view to the specified layout page. Depending on the type of view and size of the model, you may see a progress indicator in the Status Bar. See [The Status Bar on page 23](#).

SEND TO LAYOUT DIALOG

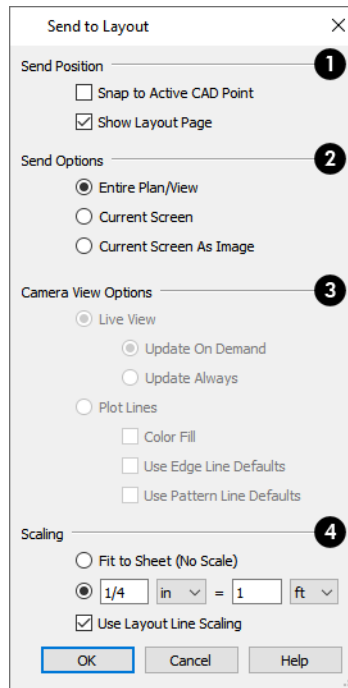

1 Send Position

These options are available for all types of views.

- Check **Snap to Active CAD Point** to snap the view you are sending to layout to the active CAD Point. See [Point Tools on page 195](#).
- Check **Show Layout Page** to go to the layout page when you click OK. When this is unchecked, the current view remains active.

2 Send Options

The options available here depend on the type of view being sent to layout. The last settings used for cross section/elevation views are retained during the current program session, as are the last settings used for camera views and overviews, and those used for plan views.

- Select **Entire Plan/View** to send to layout the extent of the plan that is visible when you click **Fill Window** . This option is not available for Perspective 3D views. See [Types of 3D Views on page 736](#).
- Select **Current Screen** to send only what is shown on screen to layout. This option is available for all view types.
- Select **Current Screen As Image** to send only what is shown on screen to layout as an embedded image. See [Picture File Box Specification Dialog on page 802](#). This option is available for all views, and is the only option available for rendered views.

3 Camera View Options

These options are available for cross section/elevation, camera views, and overviews sent to layout - provided that **Current Screen as Image** is not selected, above. The last settings used for cross section/elevation views are retained during the current program session, as are the last settings used for camera views and overviews.

- Select **Live View** to make the view dynamically linked to the plan file.
- Select **Update on Demand** to update the view only when prompted. See *Keeping Layout Views Current on page 929*.
- Select **Always Update** to update the view any time a change is made to the model. This option ensures that the view is always current but may cause program slowness.
- Select **Plot Lines** to send a Vector View to layout that uses automatically generated Plot Lines to represent surface edges and material pattern lines in the model. See *Plot Line Views on page 931*.
- Check **Color Fill** to include colors that correspond to the materials used in the model.
- Check **Use Edge Line Defaults** to use the line weight and color set in the view's Layout Box Specification dialog for all object edge lines. See *Camera View Panel on page 934*.
When unchecked, the view uses layer- and/or object-specific settings, per the **Surface Edge Lines** settings in the 3D View Defaults dialog. See *3D View Defaults Dialog on page 739*.
- Check **Use Pattern Line Defaults** to use the line weight and color set in the view's Layout Box Specification dialog for all material pattern lines. See *Camera View Panel on page 934*.
When unchecked, the pattern line weight and color settings set in the Define Material dialog are used. See *Pattern Panel on page 727*.

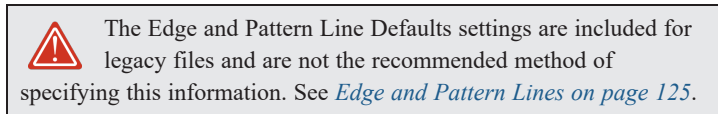

4 Scaling

Select a radio button to specify how the view sent to layout is subjected to scaling.

- Select **Fit to Sheet (No Scale)** to send the view to layout at approximately half the size of the layout drawing sheet. Once on the layout page, the view can be resized.
- Specify the **exact scale** for the view in layout. Both Imperial and metric units of measurement are available and can be selected independently.
- When views are sent to layout at different scales, line weights and line styles are subject to the same scaling. In most cases this is not desirable. When **Use Layout Line Scaling** is checked, the lines in views sent to layout appear the same as lines drawn directly on layout. This option is not available for rendered views. See *Line Weights and Scaling on page 951*.

Keeping Layout Views Current

It is not uncommon for changes to be made to a plan after views have been sent to layout. In order to make sure that your layout file is up-to-date, it is important to recognize that there are four types of layout views:

- *Dynamic Views on page 930*, which update automatically every time changes are made to the original view in the plan.
- *Semi-Dynamic Views on page 930*, which fully update when printed or prompted by you.

- *Static Views on page 931*, which do not reference the plan and cannot be updated: only replaced.
- *Plot Line Views on page 931* have elements that are Dynamic or Semi-Dynamic and others that are Static.



Semi-Dynamic and Plot Line Views can be updated using the **Update Layout View** tools. Select **Tools> Update Layout Views**. In addition, a selected view can be updated using the **Update View**  edit tool.

DYNAMIC VIEWS

Dynamic views reference the original view in the plan and update automatically whenever changes are made to that view, including:



- Changes to the model.
- Changes to annotations in the view.
- Changes to the layer settings used by the layout view. See *Layout View Layers on page 932*.

In order for a view to be Dynamic, it must be sent to layout using either the **Entire Plan/View** or **Current View** Send Option. In addition, camera views must have **Update Always** specified. See *Send To Layout Dialog on page 928*.

While convenient, Dynamic views require use of your computer's resources and may slow program performance. Consider sending cameras, overviews, and cross section/elevations to layout as Semi-Dynamic views.

For the most part, plan views sent to layout are Dynamic; however, a number of elements are Static

In order to modify these elements in a view, you need to delete the view and resend it.

- The default **Display in Plan View** and **Display of Openings in Non-Displayed Parts of Walls** settings for pony walls are a permanent part of the layout view. See *Pony Wall Defaults on page 225*.
- The floor level shown in a view sent to layout does not change if you move to a different floor in the plan. See *Multiple Floors on page 501*.
- The **Reference Display**  setting in a view sent to layout is unaffected if the Reference Display is turned on or off in the plan. See *The Reference Display*.
- The **Color**  setting in a view sent to layout is unaffected if Color is toggled on or off in the original view. See *Color On/Off on page 129*.
- The **Rotate Plan View**  angle is a permanent part of the layout view. See *Rotate Plan View on page 103*.

For information about controlling the display of dynamic views in layout, see *Displaying Layout Views on page 932*.



SEMI-DYNAMIC VIEWS

Camera views, overviews, and cross section/elevation views can all be sent to layout as Semi-Dynamic views. Semi-Dynamic views reference the original view in the plan but no information about the model or the view's layer settings update unless you prompt the layout view to update.

When a cross section/elevation view has been sent to layout, CAD objects, text, and dimensions in that view are fully Dynamic - even if the view is set to **Update on Demand**. See *Detailing Cross Section/Elevation Views on page 745*.

In order for a view to be Semi-Dynamic, it must be sent using either the **Entire Plan/View** or **Current View** Send Option and have **Update on Demand** specified. See *Send To Layout Dialog on page 928*.

There are several ways to update a Semi-Dynamic view:

- Select it and click the **Update View**  edit button;
- Select **Tools> Update Layout Views> Update All Views** ; or

- Select **Tools> Update Layout Views> Update All Live Views** .
- Update on Demand views also update automatically when you print the layout page that they are on.

Views set to **Update on Demand** may experience a loss in quality as you zoom and pan on the layout page. To restore a view's resolution, simply update it.

STATIC VIEWS

Static views are like a snapshot of the model taken at a specific time: they do not update when the plan changes. If changes to the plan need to be shown in a Static view, that view must be deleted and resent to layout.

All views sent to layout using the **Current Screen as Image** option are Static. They are treated as imported images embedded in the layout file. See *Picture File Box Specification Dialog on page 802*.

PLOT LINE VIEWS

Camera views, overviews, and cross section/elevation views using the Vector View Rendering Technique can be sent to layout as Plot Lines. See *Rendered and Vector Views on page 736*.

In Plot Line views, the lines in the layout view that represent the 3D model are automatically generated copies of those in the original view, allowing them to maintain the line weights that were specified in the plan. See *Line Weights on page 950*.

- Plot Line views are Semi-Dynamic in that they are linked to the original view and can be updated.
- Plot Line views are Static in that they will not update automatically when printed: they can only be updated manually by you.
- Any CAD objects, text, or dimensions drawn in a cross section/elevation view sent to layout will not be copied and represented by Plot Lines. These objects are fully Dynamic and will update immediately in the layout view if changes are made to them. See *Detailing Cross Section/Elevation Views on page 745*.
- The **Color**  setting in a Plot Line view is unaffected if Color is toggled on or off in the original view in the plan. See *Color On/Off on page 129*.
- Image objects are not included in Plot Line views. See *Images on page 795*.

Plot Line views do not automatically update when printed, nor can they be set to update automatically. In order to update a Plot Line view, you must do one of the following:

- Select it and click the **Update View**  edit button;
- Click the **Update All Views**  button; or
- Click the **Update All Plot Line Views**  button.

In addition, if a camera view sent to layout using the **Plot Lines** option and the camera view is later closed while the layout sheet is open, you will be asked to choose whether to update the view on the layout page.

- If the layout view is up-to-date with the 3D model or if you do not want your changes to be seen in the layout view, select **No**.
- To update the view on the layout page choose **OK**.

Displaying Layout Views

Just as some elements in a view window do not print, they are not included when a view is sent to layout: for example, the Reference Grid and camera symbols in plan view. See [Print Preview on page 947](#).

LAYOUT VIEW LAYERS

When a view is sent to layout, the current layer display settings are used. See [Layer Attributes on page 124](#).

The layer settings of a selected Dynamic or Semi-Dynamic layout view can be edited if you click the **Open View**  edit button to open the original view in the plan. Please be aware that if you open the original view in this manner and then Save the plan, the layout view and the original view will share the same layer settings going forward. You should only do this if you want a layout view with layer settings that update whenever changes are made in the plan.

If you would like to change the layer settings of a layout view, consider deleting it and sending a new view to layout with the desired layer settings.

LAYOUT BOX BORDERS AND LABELS

A border will display around each layout box when the “Layout Box Borders” layer is set to display in the Layout Page Display Options dialog. See [Layout Page Display Options on page 925](#).

Layout boxes can also display labels when the “Layout Box Labels” layer is set to display. See [Label Panel on page 363](#).

Automatic layout box labels display basic information about the original view in the plan. For example, plan view sent to layout from Floor 1 will have an automatic label that says, “1st Floor”. A camera view sent to layout will have a label that states the camera’s name. Layout box labels can be customized in the Layout Box Specification dialog. See [Label Panel on page 935](#).

MISSING LAYOUT VIEWS

If a view on the layout page can be selected but cannot be seen, its link to the plan from which it was sent may have been broken. See [Managing Layout Links on page 936](#).

Editing Layout Views

To edit a layout view, first select its layout box using the **Select Objects**  tool. Once selected, the view box can be edited using its edit handles, edit toolbar or specification dialog.

USING THE EDIT HANDLES

Layout view boxes can be edited like closed polyline-based objects. See [Editing Closed Polyline-Based Objects on page 155](#).

Plan views can be rotated. Both the layout box and the view inside it rotate. Cross section/elevation and 3D views sent to layout cannot be rotated.

IN THE SPECIFICATION DIALOG

Layout view boxes can be customized in their specification dialog. See [Layout Box Specification Dialog on page 934](#).

USING THE EDIT TOOLS

A selected layout view or views can be edited in a variety of ways using the buttons on the Edit Toolbar. See *The Edit Toolbar on page 91*.

USING DIMENSIONS

Like other CAD based objects, layout views can be moved and resized using dimensions. See *Moving Objects Using Dimensions on page 332*.

COPYING VIEWS

Just like many objects, views sent to layout can be copied and pasted into different layout files.

As a general rule, though, if multiple copies of a view are needed, it is best to send the view to layout as many times as necessary because each view can then be controlled independently.

Bear in mind, too, that if a layout has views copied from a different layout file and is later moved to a different location on your computer, the link to the original plan file may be broken. See *Keeping Layout Views Current on page 929*.

EDITING DYNAMIC VIEWS

Select a Dynamic or Semi-Dynamic view and click the **Open View**  edit button to open the original view that was sent to layout. You can also double-click a view of either type in layout to open the original view. See *Opening Layout Views on page 935*.

RESIZING SCALED VIEW BOXES

Scaled views retain their scale regardless of how you resize the border. If the border is increased in size, blank spaces may be created; if the border is made smaller, the view may become cropped.

RESIZING NON-SCALED VIEW BOXES

If the view was sent to layout using the **Fit to Sheet** setting, or if a view is set to **No Scale** in the Change Scale dialog, resizing may have one of two results:

- Drag a corner edit handle using the **Alternate**  Edit Behavior to resize both the border and the image proportionally. See *Alternate on page 138*.
- If you use any other Edit Behavior or if you drag a side edit handle, the perimeter of the layout box changes but the view inside it stays the same size. If you make the border smaller, the view may become cropped.
- Choose **No Scale** to remove any specific scale factor associated with the selected view.
- Select the second option to specify a scale for the view. When its scale is changed, the layout view will resize. In most cases, you should specify a scale for plan views, CAD Details, and cross sections/elevation views. Typical scales are ¼ in = 1ft and 1 m = 50 m.
- When a view is sent to layout at a scale other than that of the original view, line weights and line styles are affected. In many cases, this is not desirable. Check **Use Layout Line Scaling** to make lines in the selected view appear the same as lines of the same weight drawn on the layout page. See *Line Weights and Scaling on page 951*.

Layout Box Specification Dialog

Select a layout view and click the **Open Object** edit button to open the Layout Box Specification dialog.

PLAN VIEW PANEL

The PLAN VIEW panel is only available when the selected view is a plan view. See *Dynamic Views on page 930*.

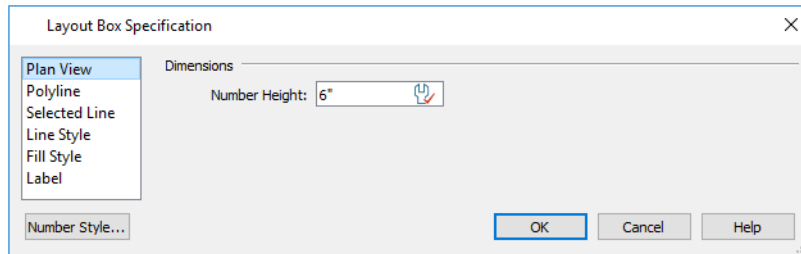

Dimensions

Specify the **Number Height** for **Dimensions** in the selected view. This setting is only available for views sent to layout from plan view. It affects the size of dimension numbers in the layout view but not in the original view in the plan file.

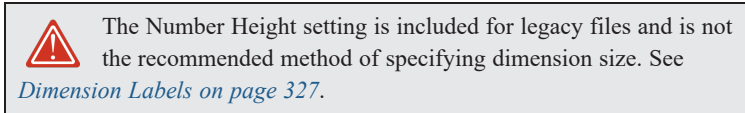

CAMERA VIEW PANEL

The CAMERA VIEW panel is only available when the selected view is a Live View or Plot Lines view. See *Dynamic Views on page 930*.

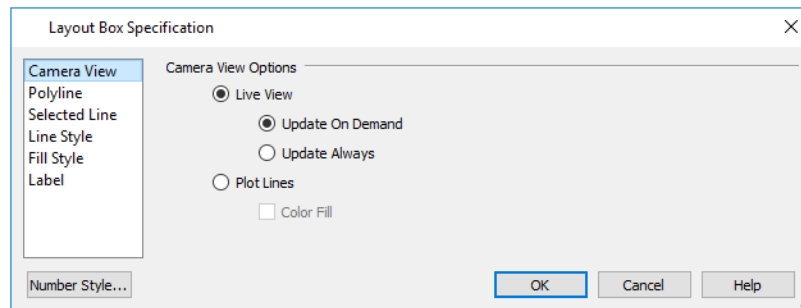

Camera View Options

The **Camera View Options** are available for Dynamic and Semi-Dynamic cross section/elevation, camera views, and overviews sent to layout. See *Keeping Layout Views Current on page 929*.

- Select **Live View** to make the view dynamically linked to the plan file.
- Select **Update on Demand** to update the view only when prompted. See *Keeping Layout Views Current on page 929*.
- Select **Always Update** to update the view any time a change is made to the model. This option ensures that the view is always current but may cause program slowness.
- Select **Plot Lines** to use automatically generated Plot Lines to represent surface edges and material pattern lines in the model. See *Plot Line Views on page 931*.
- When Plot Lines is selected, check **Color Fill** to include colors that correspond to the materials used in the model.

POLYLINE PANEL

The POLYLINE panel states the length of the countertop's **Perimeter**, its **Area**, and its **Volume**. See *Polyline Panel on page 215*.

SELECTED LINE/ARC PANEL

The SELECTED LINE panel is available when the selected edge is a line as opposed to an arc. For more information, see *Line Panel on page 203*.

The SELECTED ARC panel is available when the selected edge has been converted to an arc. For more information, see *Arc Panel on page 210*.

See, too, *Selected Edge on page 142* and *Change Line/Arc on page 174*.

LINE STYLE PANEL

The settings on the LINE STYLE panel let you to set the properties of the selected layout box's border and to specify what layout page it is located on.

For more information, see *Line Style Panel on page 204*.

FILL STYLE PANEL

For information about the FILL STYLE panel, see *Fill Style Specification Dialog on page 131*.

LABEL PANEL

Layout box labels display in layout when the "Layout Box Labels" layer is turned on and use the Text Style assigned to that layer. See *Layout Box Borders and Labels on page 932*.

For more information about the settings on this panel, see *Label Panel on page 363*.

Opening Layout Views



Dynamic and Semi-Dynamic views sent to layout refer to an original view in a plan. From the layout page, you can

access that original view by selecting a layout box, then clicking the **Open View** edit button. The original view can also be opened by double-clicking the layout view using the **Select Objects**  tool.

Changes made in this view update in the original layout view when the plan file is saved. Be aware that depending on the changes you make, other views may also be affected.

LAYER SETS

Always remember that when you open a view to edit it, any changes that you make to your layer settings will be reflected on the layout page. When you are finished making changes to your layout view and wish to resume work on the plan, save your work, close the plan, and then open it again. This will help avoid unintended changes to your layout view.

Managing Layout Links

Careful file management is needed to avoid missing files and disrupted layout links. See *Organizing Your Files on page 33*.

The following guidelines can help prevent layout links from being broken:

- Save plan files in the same folder as the layout, or in a sub-folder in that folder.
- Custom graphics included in a plan or layout should be embedded in the file or saved in the same folder as the layout.
- Plan files should never be renamed. If a new name is desired, make a copy of the file and rename the copy. Changes made in the copy do not affect views sent to layout from the original plan.
- Avoid sending cross section/elevations to layout more than once. Changes made to the view can affect layout views in unintended ways.
- Layout files should never be moved. If a layout file must be moved, the entire folder it is saved in should be moved or copied and then moved.
- Use **File> Backup Entire Plan**  to create an independent copy of the original layout. Avoid use of “Save As.” See *Backup Entire Plan or Project on page 44*.

 When a layout box is selected, the name of the plan file and basic information about view it is linked to are reported in the Status Bar. See *The Status Bar on page 23*.

FINDING MISSING FILES

When a layout file is opened, the program performs a breadth-first search for dynamically linked views. This means that it:

- Looks first in the same folder as the layout.
- Looks next in the folders located closest to the layout’s folder.
- If a missing file is not found, it expands its search further from the location of the layout file until the files with the linked views are located.
- If a missing file is not found, a second breadth-first search will be performed, searching all zipped files found in the first search.

If a file remains missing after the program performs a search of your system, a Warning message will indicate that the program could not successfully open all of the layout’s associated plan files. When you click OK, the Referenced Plan Files dialog will open, allowing you to relink the layout to its missing associated files.

REFERENCED PLAN FILES DIALOG

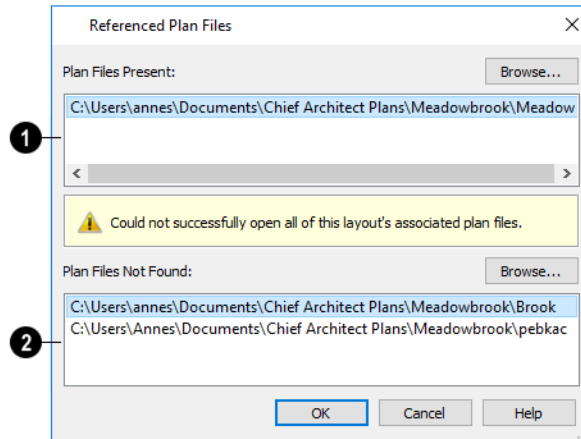

1 Plan Files Present

This section lists all files with intact links to the layout.

If you want, you can select a file and click the **Browse** button just above the **Plan Files Present** field and replace the selected plan with a different plan saved on your system.

2 Plan Files Not Found

This section lists the names of files with disrupted links to the layout. Any files listed here have been moved, renamed, or deleted and cannot be found by the program. Intervention is required to find these files and reestablish their links to the layout.

Select a missing file and click the **Browse** button just above the **Plan Files Not Found** field to open the Browse For Missing File dialog, which is a typical Open dialog. See *Opening and Importing Files on page 41*.

- Locate the missing file in your system’s directory structure. When the missing file is selected, click **Open** to link it to the layout.
- You can also redirect an intact link to from a File Present in Layout to a different file in the same manner.

Be sure to choose **File> Save**  in the layout file when the missing files have been located to save their links to the layout file.

RESULTS OF MISSING FILES

If all missing files are correctly redefined, the layout opens when you click **OK**.

If an error message displays, one or more of the missing files could not be replaced by the redefined file. Click **OK** to continue. The layout opens, but with the following characteristics:

- Any plan views associated with the missing file(s) are blank. Only the border displays if the “Layout Box Borders” layer is set to display. See *Layout Page Display Options on page 925*.
- Any elevations or cross sections associated with the missing file(s) show the automatically generated lines, but any added CAD objects are absent.

Printing Layout Files



Printing layout files is similar to printing a view in a plan file. Select **File> Print> Print** to open the Print dialog. See [Print View Dialog on page 955](#).

As in plan views, printing options for layouts are set in the Drawing Sheet Setup dialog for that layout file. See [Drawing Sheet Setup Dialog on page 943](#).

PRINTING TO SCALE

A layout file's drawing scale is specified in the Drawing Sheet Setup dialog. While you can specify any drawing scale that you wish, in nearly all circumstances, you will want the scale to be **1 in = 1 in** or **1 mm = 1 mm** for all layout files.

The views sent to your layout pages have already been assigned a scale, and if you select a scale other than one-to-one for the layout, these views will be scaled a second time when printed.



Layout views will print at their specified scales only when the drawing scale for the layout file is 1 in = 1 in or 1 mm = 1 mm.

When a view is sent to layout at a scale other than that used by the original view, line weights may be affected. See [Line Weights and Scaling on page 951](#).

PRINTING SERVICES

If you plan to use a printing service, you may want to install a PDF writer. See [Printing to a PDF File on page 950](#).

You can also print to file using the driver for the printer that the service will use. See [Printing to File on page 941](#).

Find out what paper size the print service uses and select it in the Drawing Sheet Setup dialog. See [Drawing Sheet Setup Dialog on page 943](#).

CHECK PLOTS

When a large drawing sheet size has been specified, you can print a check plot at a reduced scale so that it can be printed on a smaller printer. This allows you to make final checks before printing to the larger size. See [Check Plots on page 949](#).

Exporting Layout Files



A layout can be exported to a **.dxf** file much like any other vector-based view.

The main difference is in the scale of the output, which is in scaled paper units rather than model units. If a 50" line in a plan would be scaled to 1" inch when printed, it is exported as a 1" line instead of its length before prior to scaling. See [Exporting 2D DXF/DWG Files on page 836](#).

Printing and Plotting

Chapter 39

Home Designer provides a variety of printing options, from printing scaled plan views and 3D perspectives, to a set of templates that can be assembled into a 3D model.

To create working drawings, you can use the program’s Layout facility. Multiple views of the model can be arranged on pages along with a border and title block. For more information, see *Layout on page 924*.

Home Designer also allows you to save your drawings in **.pdf** file format that can then be sent to a printing service.

Note: Screen captures are provided for illustrative purposes only and are not an endorsement of any products.

TOPICS

Introduction to Printing	940
Printers and Plotters	940
Printing Defaults	941
The Printing Tools	942
Drawing Sheet Setup Dialog	943
Print Preview	947
Printing to Scale	948
Printing Across Multiple Pages	950
Printing to a PDF File	950
Line Weights	950
Watermarks	953
Print View Dialog	955
Print Image Dialog	958

Introduction to Printing

Home Designer Pro offers printing options to suit a variety of needs. It is helpful to be familiar with these options and choose the one that makes the most sense for the project at hand.

OUTPUT OPTIONS

Printing From Layout - For professional quality documents with a title block, border, and multiple views of the model, printing from layout provides the best results. For more information, see [Layout on page 924](#).

Printing Directly From a View - You may prefer to print individual drawings directly from a view. See [Print Tools on page 942](#).

Printing to PDF - Plans can be printed to a .pdf file and printed remotely. See [Printing to a PDF File on page 950](#).

Export to STL - Exports an .stl file that can be printed on a stereolithography machine, or 3D printer. See [STL Format on page 844](#).

TERMINOLOGY

Drawing Sheet Size - The dimensions of the final printed output. This may or may not be the same as the printer paper size. If the sheet and paper sizes are the same, only one page is required per sheet. See [Drawing Sheet Setup Dialog on page 943](#).

Paper Size - The dimensions of the paper to be printed on. Specifying a paper size that is smaller than the Sheet Size allows large drawings to be printed across multiple pages.

Check Plot - A test printing, typically at a smaller scale, made before final output to large paper format. For more information, see [Check Plots on page 949](#).

Line Weight - The thickness of a line. A thicker line weight is easier to see, but may not show as much detail. See [Line Weights on page 950](#).

Drawing Scale - Drawings are often printed to scale for accuracy. $\frac{1}{4}'' = 1'$ and $1\text{ m} = 50\text{ m}$ are examples of common scales. You can specify this scale in the Drawing Sheet Setup dialog. See [Drawing Sheet Setup Dialog on page 943](#).

When a particular scale is not important, drawings can also be sized to fill a particular area. See [Printing to Scale on page 948](#).

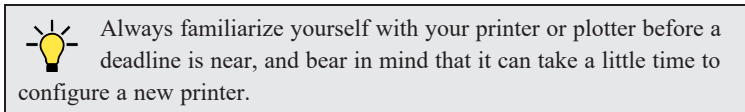

Printers and Plotters

There are many different types of printers and plotters. In general, a printer is smaller, normally outputting 8½ x 11" (Letter or ANSI A size), 8½ x 14" (Legal Size) or sometimes as large as 11 x 17" (Tabloid or ANSI B size).

Plotters are typically used to output larger sheets of paper such as 17 x 22" (ANSI C), or 18" x 24" (ARCH C).

PRINTER DRIVERS

A printer driver is a program that allows a printer to communicate with the rest of the computer system. Drivers are usually created by the printer manufacturer, are typically updated regularly, and can usually be downloaded free of charge from the manufacturer's website.

In addition to interpreting between the printer and the rest of the system, printer drivers save default page size, orientation, margin size, and other information that Home Designer refers to unless you specify otherwise. See [Print View Settings on page 941](#).

If you experience printing problems, consider installing updated drivers for your printer. Visit your printer manufacturer's website for more information.

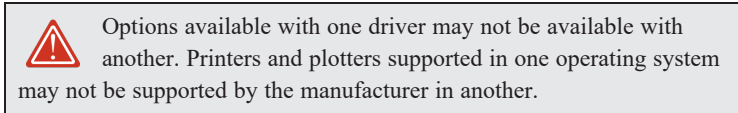

PRINTING TO FILE

If your print service requires you to print to a file that can be read by their plotter, you can install that printer's drivers on your system and then use the Windows System Print dialog to Print to File. See [Print View Dialog on page 955](#).

Printing to a file is not an option in the Mac System Print dialog.

CLEARING PRINTER INFORMATION

Some information specific to individual printers, such as available paper sizes, is saved with each plan file. You can select **File> Print> Clear Printer Info** to clear the printer-specific information stored with the plan file.

Printing Defaults

You can print to any printer or plotter that is supported on your operating system and can specify the current printer at any time in either the Drawing Sheet Setup or Print View dialog.

DRAWING SHEET SETUP

 When any orthographic view is active, you can specify its Drawing Sheet size, margins, orientation, printed Drawing Scale, and more in the Drawing Sheet Setup dialog. Select **File> Print> Drawing Sheet Setup** to open this dialog. See [Drawing Sheet Setup Dialog on page 943](#).

The settings in the Drawing Sheet Setup dialog are view-specific. This means that in a plan file, they can be set up one way for plan views and a different way for each cross section/elevation view. When a new view is created, its initial settings are derived from the current plan view settings.

The Drawing Scale set in the Drawing Sheet Setup dialog acts as the default scale for the active view's Print, Printed Size Input, and Send to Layout dialogs. See [Send To Layout Dialog on page 928](#).

PRINT VIEW SETTINGS

 When you are ready to print an orthographic view, select **File> Print> Print**. The initial settings in the Print View dialog are drawn from the Drawing Sheet Setup for the view. The system's default printer is selected and if possible, the paper size and orientation are set to match those of the Drawing Sheet.

Once a view has been printed, most of the settings in the Print View dialog are saved and will be applied to all views of the same type, in all Home Designer Pro files. View types with separate Print View settings are:

- Plan view
- Cross Section/Elevation views
- Layout
- Materials Lists

If you prefer that the Print View settings not be retained in this manner, uncheck **Remember Print Settings after Printing** in the Drawing Sheet Setup dialog.

DISPLAYING OBJECTS



You can control the display of objects when printing directly from a view in the Layer Display Options dialog. See *Layer Display Options Dialog on page 126*.

Objects must be visible in order for them to print; however, not all items that are visible will print. See *Print Preview on page 947*.

To control the display of objects in a camera view sent to layout, turn layers on/off in the view before it is sent to layout.

PRINT PREVIEW



To get a sense of whether your current settings will meet your needs when printed, you can use the **Print Preview** toggle to view the printed output on screen before any paper is used. See *Print Preview on page 947*.

The Printing Tools



Select **File> Print** to view the Print Tools submenu. These tools fall into four categories.

PRINT SETUP TOOLS



Drawing Sheet Setup - Opens the Drawing Sheet Setup dialog. See *Drawing Sheet Setup Dialog on page 943*.



Scale to Fit - Automatically selects a scale that fits your plan to the drawing sheet. See *Printing to Scale on page 948*.



Center Sheet - Automatically centers the drawing sheet on your drawing. See *Center Sheet on page 948*.



Print Preview - Shows on screen how the current view will appear printed, based on the current scale and other settings. See *Print Preview on page 947*.

PRINT TOOLS



Print - Prints the current plan view, Vector View, or layout sheet to a specified scale. See *Print View Dialog on page 955*.



Print Image - Prints the current view including images, textures, and backdrop. Views printed with Print Image are not scaled. See *Print Image Dialog on page 958*.



You can also select **File> Export> Export PDF** to open the Export PDF dialog. See *Print View Dialog on page 955*.

DISPLAY TOGGLES

A number of toggles allow you to turn various aspects of the display on or off. See *Interface Toggles on page 12*.



Color - Turn the on-screen display of color on or off in all views except perspective views. See *Color on page 947*.



Line Weights - When this is on, line weights appear on screen as they will print. See *Line Weights on page 947*.



Drawing Sheet - Turn this on for a preview of your plan relative to the current Drawing Sheet. See *Drawing Sheet on page 947*.



Reference Grid - The Reference Grid does not print, so you can turn this off to get a better sense of what the view will look like printed. See *Reference Grid on page 947*.

ADDITIONAL PRINT TOOLS

Customize Sheet Sizes - Allows you to create custom sheet sizes. See *Customize Sheet Sizes Dialog on page 946*.

Clear Printer Info - Some information specific to individual printers, such as available paper sizes, is saved with each file. This clears the printer-specific information associated with the current page setup.

Drawing Sheet Setup Dialog



Select **File> Print> Drawing Sheet Setup** to open the Drawing Sheet Setup dialog.

The Drawing Sheet Setup dialog is only available when a plan view, cross section/elevation view, or layout is active.

The settings in this dialog are specific to the current view and are saved with the .plan or .layout file. See *Printing Defaults on page 941*.

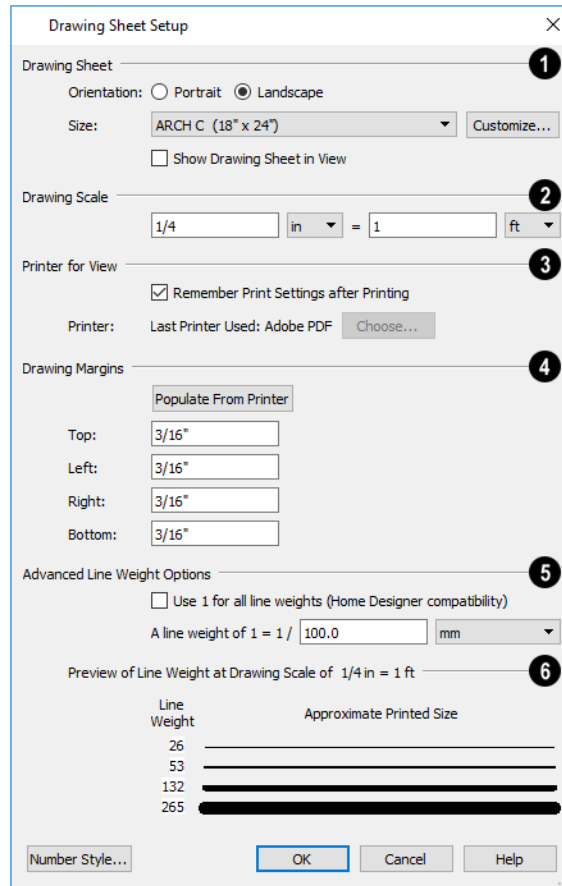

1 Drawing Sheet

Specify the **Orientation** and **Size** of the **Drawing Sheet**, which is the final printed output.

- Click the **Customize** button to open the Customize Sheet Sizes dialog. See *Customize Sheet Sizes Dialog on page 946*.



Paper can often be inserted into plotters in either of two orientations. Refer to your plotter's documentation to find out which way to insert the paper for correct results.

- Check **Show Drawing Sheet in View** to turn on the display of the Drawing Sheet in orthographic views. See *Drawing Sheet on page 947*.

2 Drawing Scale

Specify the **Drawing Scale** for the active view. This scale is applied only when the view is printed.

The scale is specified in two parts, which by default are 1 ft = 1 ft or 1 m = 1 m for layout views, and ¼ inch = 1 ft or 1 m = 50 m for all other views. Both imperial and metric units of measurement are available and can be selected independently.

The **Drawing Scale** acts as the default scale for the active view's Print, Print Size Calculator, and Send to Layout dialogs.

3 Printer for View

Specify the **Printer for View** which is the printer for the active view in the current file. These settings are global, affecting all plan and layout files.

- Uncheck **Remember Print Settings after Printing** to enable the Choose button, below. When this is checked, the printer is selected in the Print View dialog. See *Printing Defaults on page 941*.
- Click the **Choose** button to select a printer and edit its paper settings in the Default Printer for View dialog.

The **name** of a **Printer** displays to the left of the Choose button for reference.

- If the **Remember** box is checked, the last printer used in the current view type is shown; if no printer has been used in the current view, “None” will display.
- If the **Remember** box is unchecked, the system’s default printer will be shown.

If you have questions about your printer’s settings, consult its documentation.

4 Drawing Margins

Specify the **Drawing Margins** which define the extents of the printable area of the active view’s Drawing Sheet.

- Click the **Populate from Printer** button to set the margins based on the selected printer’s default settings. See *Printers and Plotters on page 940*.
- Specify the width of the **Top, Bottom, Left, and Right** margins.

5 Advanced Line Weights

The **Advanced Line Weight Options** allow you to specify the active view’s line weight scale. A layout file’s line weight scale should always be the same as that of any plan views associated with it. See *Line Weights and Scaling on page 951*.

- Check **Use 1 for all line weights (Home Designer compatibility)** to have the program maintain a consistent line thickness and dash size when the drawing scale is changed. When checked, the Line Weight Scale is based on a 1/4 inch = 1 foot drawing scale and 1= 1/300 inch line weight scale. This option is not available for layouts and is not normally recommended. See *Line Weights on page 950*.
- Select the **Line Weight Scale**. See *Line Weights and Scaling on page 951*. This setting should always be the same for both a given layout file and any plan views associated with it.

6 Preview of Line Weight

A line weight **Preview** illustrates how changes to the line weight scale affect the printed size of various line weights at the current Drawing Scale.

DEFAULT PRINTER FOR VIEW DIALOG

To open the Default Printer for View dialog, click the **Choose** button in the Drawing Sheet Setup dialog.

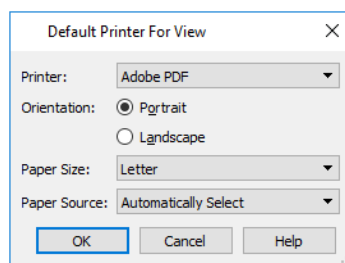

- Select a **Printer** from the drop-down list.
- Choose the **Orientation** of the paper used by the selected printer.
- Select a **Paper Size** from the drop-down list. The options available will depend on the selected printer.
- Select a **Paper Source** from the drop-down list. The options available will depend on the selected printer.

CUSTOMIZE SHEET SIZES DIALOG

To open the Customize Sheet Sizes dialog, select **File> Print> Customize Sheet Sizes**, or click the **Customize** button in the Drawing Sheet Setup dialog.

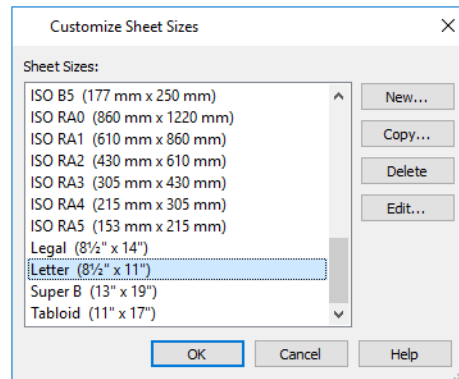

Several options are available:

- Click **New** to create a new sheet size.
- Select a sheet size and click **Copy** to create a duplicate sheet size.
- Click **Delete** to remove the selected sheet size.
- Select a sheet size and click **Edit** to open the Edit Paper Size dialog and change its description, dimensions, and units of measurement.

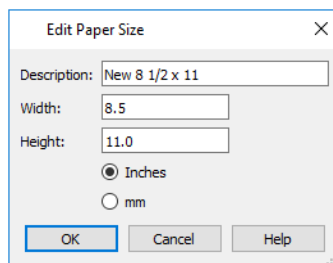

- Click **OK** to close the dialog. Any new sheet sizes created are now available in the Drawing Sheet Setup dialog.
- The data for this dialog is stored in the “sheetSizes.sheet” file in the program’s Data folder.

CLEARING PRINTER INFORMATION

Select **File> Print> Clear Printer Info** to clear the printer-specific information stored in the Drawing Sheet Setup dialog. See *Printers and Plotters* on page 940.



Print Preview

Print Preview and its related display toggles allow you to get a sense of what the current view will look like when it is printed.

PRINT PREVIEW



Select **File> Print> Print Preview** for an on-screen representation of how the current view will appear when printed. Print Preview is only available in views that can be scaled. See [Printing to Scale on page 948](#).

When **Print Preview** is on, the Drawing Sheet and line weights are displayed, and the **Drawing Sheet**  and **Line Weights**  toggles are overridden.

Objects such as camera symbols, CAD points, text and dimension objects appear on-screen as they will on the printed page.

When **Print Preview**  is enabled, color will display depending on whether **Print in Color** is selected in the Print View dialog. See [Print View Dialog on page 955](#).

The Reference Display does not print if it is visible. See [The Reference Display](#).

COLOR



The **Color** toggle turns the on-screen display of color on or off in all views. When Color is toggled off, views print in either black and white or grayscale depending on your **Preferences** setting. See [Colors Panel on page 62](#).

REFERENCE GRID



The **Reference Grid** is an on-screen grid composed of regular squares that can be used to convey a sense of scale while drawing. It does not print, and its size can be specified in the General Plan Defaults dialog. See [General Plan Defaults Dialog on page 56](#).

LINE WEIGHTS



Select **View> Line Weights** for an on-screen representation of line weights and line styles. Turning **Line Weights** on or off does not affect the final printed output.

- When **Line Weights** is turned on, you can **Zoom In**  to see the location of lines and dashed lines as they will appear on the printed page.
- When **Line Weights** is off, dashed lines look the same, regardless of the zoom factor.

Line Weights can also be turned on or off in the Preferences dialog. See [Appearance Panel on page 60](#).

DRAWING SHEET



The Drawing Sheet is a representation of the size and orientation of the final printed output. It is different from the printed page size, which means that you can print a large Sheet to multiple smaller pages. Select **View> Drawing Sheet** to show the Drawing Sheet on screen.

The Drawing Sheet size and orientation are specified in the Drawing Sheet Setup dialog. See [Drawing Sheet Setup Dialog on page 943](#).

When the Drawing Sheet is set to display, a blue border representing the margins of the printable area will also display for reference. If the margins have been set to populate from the selected printer, this border may not display on all edges of the drawing sheet. See *Printer Drivers on page 941*.

When **Drawing Sheet**  is on, the drawing sheet behaves as an object.

- When selected at its border the sheet has edit handles, allowing it to be moved. See *Editing Objects on page 136*.
- You can also resize the sheet using its edit handles; however, for best results, it is recommended that you instead select an available sheet size in the Drawing Sheet Setup dialog. See *Drawing Sheet Setup Dialog on page 943*.
- Dimension lines can locate the edges of the sheet and can be used to position other objects relative to it. See *Moving Objects Using Dimensions on page 332*.



Note: Specifying a sheet size in the Drawing Sheet Setup dialog is preferable to editing the sheet size on-screen.

The drawing sheet cannot be rotated or copied.

CENTER SHEET



Select **File> Print> Center Sheet** to center the drawing sheet on the drawing. This moves the sheet relative to the drawing but does not affect the coordinates of objects in the drawing. The location of the drawing sheet is independent for each floor of the model.

Printing to Scale

Several different print scaling options are available. The type of view that you are printing determines which options you may choose from.

ORTHOGONAL VIEWS

Plan views, Orthographic 3D views, and layout pages are orthogonal views, which means:

- Your line of sight is at a right angle to all objects in the view.
- Objects do not appear to decrease in size as their distances from the viewer increase.

Orthogonal views can be printed to scale; however, Orthographic 3D views can only be printed to scale when the Vector View Rendering Technique is used.

The scale set in the Page Setup dialog is inherited by the Print and Send to Layout dialogs. This scale can be overridden on an individual basis in either of these dialogs. See *Print View Dialog on page 955* and *Sending Views to Layout on page 927*.

Select **File> Print> Scale to Fit**  in an orthogonal view to select a suitable scale and re-center the drawing sheet so that everything fits on the sheet.

Imperial drawing scales are typically noted in inches per foot. Larger scales, such as 1 inch = 50 feet or 1:200m, are often used for property layouts.

PERSPECTIVE VIEWS

Camera views and Perspective overviews display the model much the way the eye would see it and cannot be scaled.

- Objects in the view may be at any angle relative to your line of sight.
- Objects seem to decrease in size as their distances from the viewer increase.

Perspective views can only be printed using the **Print Image**  tool. See [Print Image Dialog on page 958](#).

While perspective views cannot be scaled, you can control the printed size of the view. If **Fit to Paper** is selected in the Print View dialog, a percent value can be set that defines how much of the printed page to fill. See [Print View Dialog on page 955](#). 50% causes the print to be 50% of both the height and width of the paper, including the non-printable border.

For example, if printing to an 8½ x 11 page with a 1" non-printable border in each direction:

- 100% would print an area 8½ x 11. This is not recommended, as part of the output could fall outside the printable area.
- 50% would print an area 4¼ x 5½.
- Each printer may vary slightly.

CHECK PLOTS

A check plot is a test print that allows you to print at a reduced scale on smaller, less expensive paper so you can check that the drawing will print as expected. The drawing scale is temporarily adjusted to a specified fraction of its true value. Both drawing scale and line weights are subject to this scale adjustment.

For example, if a layout has a border designed to fit on a Drawing Sheet of 24" x 36", a check plot at 1/2 scale would allow it to fit on a 12" x 18' page. A view sent to that layout at a Drawing Scale of 1/4" = 1' would be scaled at 1/8" = 1' when printed at 1/2 scale.

To create a check plot

1. Select **File> Print> Print View** . In the Print View dialog:
 - Click the **Check Plot at** radio button, then choose the desired scale fraction from the drop-down list.
 - The **Paper Size** will automatically adjust to fit the selected Check Plot Scale.
 - Confirm that the **Paper Size** is the size you wish to use, then click **Print**.
2. The next time you print a view, remember to choose **To Scale** or **Fit to Paper** again in the Print View dialog.

PRINTING TEXT, DIMENSIONS, AND LINE STYLES

As with other objects your drawings, text and dimension numbers are subject to scaling when views are sent to layout or printed. See [Scaling Text on page 349](#).

Printed text size is also influenced by the selected font and the method used to specify its size. See [Character Size on page 339](#).

Text may not print exactly as it appears on-screen. To get a better idea of how text and dimension characters will print, you may find it helpful to **Zoom In**  on them.

For best printed results, using true-type or open-type fonts is recommended.





Text may not appear accurately on screen when the font used by the printer is different from the font used on screen. Consult your printer documentation for more information on font substitution.

The line styles assigned to CAD and a variety of other objects are subject to scaling when printed as well. They are only subject to scaling when sent to layout, however, under specific circumstances. See [Line Weights and Scaling on page 951](#).

Printing Across Multiple Pages

When printing directly from a plan view, cross section/elevation view, or layout it is possible to print at a scale that does not fit the drawing on one page.

When printing to a paper size that is smaller than the sheet size, a 2% overlap is used. Crop marks print where the paper needs to be cut between pages. A solid line is drawn at the drawing sheet boundary on the sides that need to be cut.

To see on-screen what the drawing will look like when printed, select **View> Drawing Sheet**  and then **Window> Fill Window** . Grey lines across the drawing sheet indicate where the page breaks will occur. See [Drawing Sheet on page 947](#).

Printing to a PDF File

Portable Document Format, or **.pdf** files, are one of the most universally compatible and efficient file formats and can be viewed and printed on most computer platforms.

You can save any view as a **.pdf** file by selecting “Chief Architect Save as PDF” or any other PDF writer installed on your system as the Destination printer **Name** in either the Print View or Print Image dialog. See [Print View Dialog on page 955](#) and [Print Image Dialog on page 958](#).

You can also print to **.pdf** from any view by selecting **File> Export> Export PDF** . See [PDF Files on page 807](#).

When you print to **.pdf**, you will be asked to create a file name and choose a destination to save it in the Save as PDF File dialog. See [Exporting Files on page 38](#).

You can also import **.pdf** file into Home Designer. See [Importing PDF Files on page 807](#).

Line Weights

The weight of a line refers to its thickness on the printed page and is described in absolute terms as a fraction of a unit, often 1/100th of a millimeter or 1/1000 of an inch. In Home Designer Pro, line weights are assigned to objects, patterns, and layers using whole numbers that correspond to the numerator of this fraction.



You can specify the Line Weight Scale by defining the denominator and the unit used in this fraction in the Drawing Sheet Setup dialog. See [Drawing Sheet Setup Dialog on page 943](#).

The method for specifying an object’s line weight depends on the object and the type of view.

- Most objects’ line weights can be set by layer. See [Layer Display Options Dialog on page 126](#).
- Some objects’ line weights can be set in their specification dialogs. See [Line Style Panel on page 204](#).
- The line weights for walls in plan view are defined by wall type in the Wall Type Definitions dialog. See [Wall Type Definitions Dialog on page 259](#).
- The line weights of material pattern lines, which are visible in Vector Views, can be set in the Define Material dialog. See [Define Material Dialog on page 726](#).
- The line weight for fill patterns is set for individual objects in their specification dialogs. See [Fill Styles on page 130](#).
- The line weight applied to surface edges in Vector Views can be set in the Print dialog. See [Print View Dialog on page 955](#).
- The end cap length of dashed lines in plan view is set in the Preferences dialog. See [CAD Panel on page 74](#).

- An assigned line weight of 0 draws a line weight of 1 pixel, the thinnest line weight a printer allows. How thick this is varies from printer to printer. See *Printers and Plotters on page 940*.

LINE WEIGHTS AND SCALING

Line weights and line styles are subject to scaling when printed. You can see an on-screen approximation of what lines will look like when a view is printed by toggling on either **Line Weights**  or **Print Preview** . See *Print Preview on page 947*.

When a view is sent to layout, line weights and styles may be further affected by the drawing scale selected for the layout view. This occurs when the layout view's scale is different from the Drawing Scale of the original view.

For example, assume that you have an object in a view with a line weight of 20, and that the view's Drawing Scale is 1 mm = 50 mm.

- If you send the view to layout at 1 mm = 25 mm scale, twice the original scale, the resulting printed line weight for this object will increase to 40 instead of 20.
- If you send the view to layout at 1 mm = 100 mm scale, half the original scale, the resulting printed line weight for this object will decrease to 10 instead of 20.

Line weight scaling affects both line weights and line styles and can be particularly noticeable with dashed line styles.

You can specify the drawing scale for any orthogonal view by opening the Drawing Sheet Setup dialog while in that view. See *Printing to Scale on page 948*.

For any layout view, you can specify whether the original line weight is maintained or not in the Send to Layout dialog. See *Send To Layout Dialog on page 928*.

Note that in order to produce exact line weights, a Vector View must be sent to layout using the **Plot Lines** option. See *Plot Line Views on page 931*.

Note: Under most circumstances, you should select Use Layout Line Scaling when sending views to layout.

In the following image, the same plan view has been sent to layout twice, at two different scales. The view on the left was sent at the same scale as the original view, 1/8" = 1'. The view on the right was sent at 1" = 1', or magnified eight times, to show an area of the plan in greater detail.

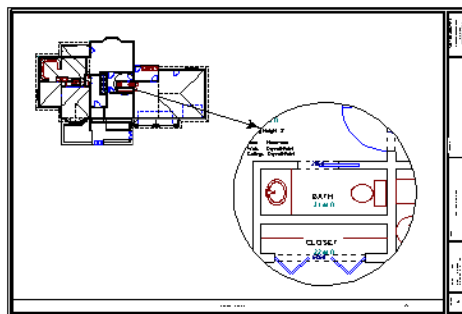

Because the view on the right was sent to layout at a scale other than that of the original, it is subject to layout line scaling.

The solid lines representing walls, cabinets and doors are rescaled to be eight times thicker than in the original view.

Similarly, the dashed lines representing the door jambs are rescaled so that the dashes and the spaces between them are eight times larger than in the original view.

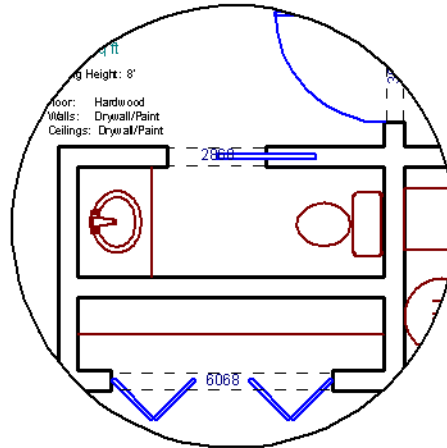

If **Use Layout Line Scaling** is enabled, line weights are no longer scaled and the dashed lines display at the same size as in the original view.

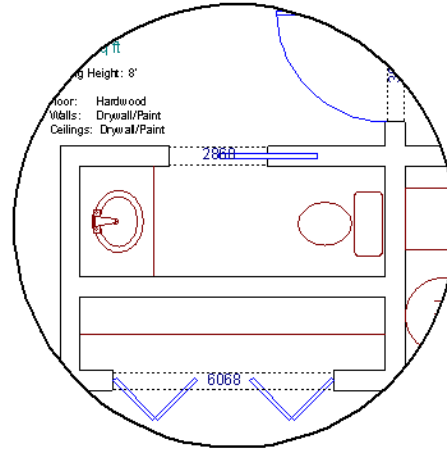

Because the view in this example is scaled eight times larger in this case, the dashes and line weights look relatively small and fine when **Use Layout Line Scaling** is enabled. Were the view rescaled to be smaller instead, the line weights would look relatively large and thick.

PRINTERS AND LINE WEIGHT

Line weight and print scaling are subject to the limitations of the printer being used. For example, you will not be able to see the difference between a line that is 1/150th of an inch wide and one that is 1/300th of an inch wide when they are printed using a printer that prints 150 dots per inch (DPI).

That is, a CAD line with a line weight of 1 will look the same as a CAD line with a line weight of 4 when the Line Weight Scale is set at 1 = 1/600th of an inch and you print to a printer capable of 150 DPI.

Setting an object's or group of objects' line weight to zero causes the lines to print as thinly as possible.

 The default Line Weight Scale of 1 = 1/100 mm makes it easy to meet many professional drawing standards and in most cases should not be changed.

Watermarks



A customizable watermark containing text or the image of your choice can be added to any plan view or layout. To toggle the watermark on or off in the current view, select **View > Watermark**.

In layout files, the watermark will display on all pages when it is toggled on. In plan files, on the other hand, the Watermark toggle can be set on a view by view basis and can be saved in the Camera Specification and Cross Section/Elevation Specification dialogs. See *View Specification Dialogs on page 102*.

Watermarks also are file specific, so you can have a different watermark in each plan and layout file if you wish.

The method for printing a view with a watermark varies depending on the view type:

- For most types of views, check **Show Watermark** in the Print View dialog. See *Print View Dialog on page 955*.
- For perspective cameras and overviews, toggle the watermark on before printing. See *Saving and Printing 3D Views on page 759*.

WATERMARK DEFAULTS DIALOG

A watermark can be customized in the Watermark Defaults dialog. To open this dialog, select **Edit > Default Settings** and in the Default Settings dialog, click on “Watermark” and click the **Edit** button.

You can also open this dialog by clicking the **Define** button in the Print View dialog. See *Print View Dialog on page 955*.

When the Watermark Defaults dialog is open, the watermark will display in the view window behind the dialog and will update as changes are made to its settings.

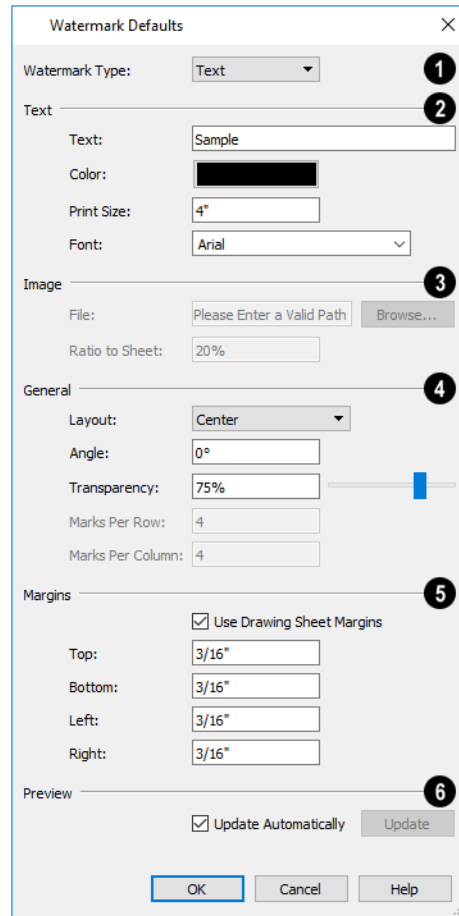

1 Watermark Type

Select a **Watermark Type** from the drop-down list.

2 Text

The **Text** settings are available when “Text” is the Watermark Type selected above.

- Type the desired watermark **Text** in the text field.
- Click the **Color** bar to select a color for the watermark text. See *Select Color Dialog on page 134*.
- Specify the **Print Size** of the watermark text, as measured from the baseline to top of the capital letter A in the selected Font.
- Select a **Font** from the drop-down list.

3 Image

The **Image** settings are available when “Image” is the Watermark Type selected above.

- When an image **File** has been specified, its pathname displays here. You can type a different pathname if you wish.
- Click the **Browse** button to open the Watermark Image File dialog, which is a typical Open dialog. See *Importing Files on page 42*.
- Specify the **Ratio to Sheet**, which is how far the image extends across the sheet. Not available when “Fit to Sheet” Layout is selected, below.

4 General

- Specify the **Layout** of the watermark from the drop-down list.
- Specify the watermark’s **Angle**, measured relative to a horizontal line pointing towards the right-hand side of the screen.
- Use the **Transparency** slider bar or text field to control how transparent the watermark is.
- The Marks Per settings are only available when “Tile” or “Border” is selected as the Layout, above.
- Specify the **Marks Per Row**, which is the number of instances of the watermark across the width of the Drawing Sheet.
- Specify the **Marks Per Column**, which is the number of instances of the watermark from top to bottom of the Drawing Sheet.

5 Margins

Specify the watermark **Margins**, measured in from the edges of the Drawing Sheet.

- Check **Use Drawing Sheet Margin** to use the same margins for the watermark that are specified for the Drawing Sheet or uncheck this box to enable the settings that follow. See *Drawing Sheet Setup Dialog on page 943*.
- Specify the width of the **Top, Bottom, Left, and Right** watermark margins.
- Check **Update Automatically** to have the watermark update in the current view as changes are made in the dialog.
- Click the **Update** button to update the watermark in the view behind the dialog. Not available if Update Automatically is checked above.

6 Preview

- Check **Update Automatically** to have the watermark update in the current view as changes are made in the dialog.
- Click the **Update** button to update the watermark in the view behind the dialog. Not available if Update Automatically is checked above.

Print View Dialog



To print from plan view, 3D Vector Views, layout, or the Materials List, select **File> Print> Print**. The Print View Print Layout, or Print Materials List dialog opens. The settings that are available will vary depending on which version of the dialog is open.



Select **File> Export> Export PDF** to open the similar Export PDF dialog.

Note: 3D views that are not Vector Views can be printed using Print Image. See *Print Image Dialog on page 958*.

If **Remember Print Settings after Printing** is checked in the Drawing Sheet Setup dialog, most settings in this dialog will be saved and applied globally to all views of the same type in all Home Designer files. There are three exceptions: **Sheets** and **Copies** are always reset, and the **Print Source** is determined by whether or not the **Drawing Sheet**  is toggled on. See *Print View Settings on page 941*.

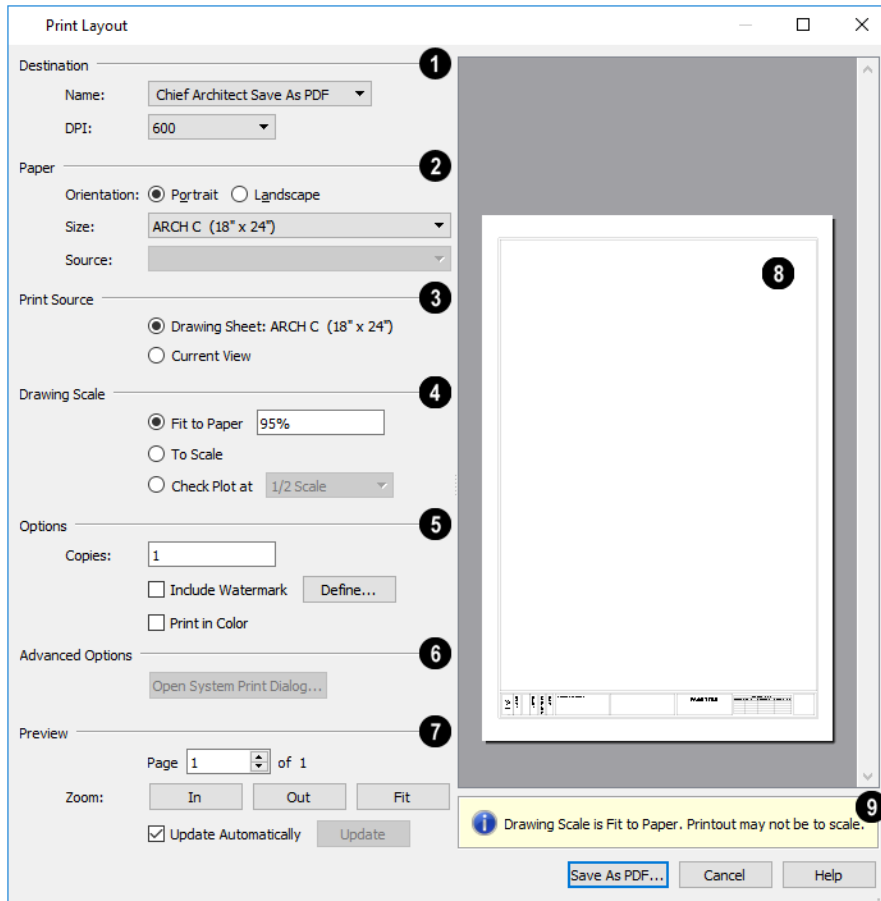

1 Destination

- Select the **Name** of the printer you would like to use from the drop-down list. To print to **.pdf**, select “Chief Architect Save as PDF” from the list, or choose a **.pdf** writer installed on your system. See *Printing to a PDF File on page 950*.
- Select the **DPI**, or Dots Per Inch to use when printing, from the drop-down list. The available options may vary depending on the selected printer.

2 Paper

Select the **Paper Orientation, Size, and Source**. The available Size and Source options are controlled by the selected printer's driver. See *Printer Drivers on page 941*.

- When possible, the program will automatically set the Size and Orientation to match those of the Drawing Sheet. See *Drawing Sheet Setup Dialog on page 943*.
- The Paper Size may be automatically adjusted if the Drawing Scale option is changed, below.

3 Print Source

Not available in the Print Materials List dialog.

- Select **Drawing Sheet** to print the entire sheet even though you may be zoomed in on a portion of the view. This is selected by default when the Drawing Sheet is set to display in the current view.
- Select **Current View** to print only that portion of the active view that is currently visible on screen. If you are zoomed out, any blank space outside of the printable objects in the view is ignored. This is selected by default when the Drawing Sheet is not displaying in the current view.

4 Drawing Scale

Changes to these options may cause the Paper Size to change, above. Not available in the Print Materials List dialog or in camera views or overviews. See *Printing to Scale on page 948*.

- **Fit to Paper** prints the view on one page. The program uses whatever scale is necessary to fit the plan on one page.
- When **Fit to Paper** is selected, specify the percentage of the paper to be used. The default value is 95%.

Note: The Fit to Paper percentage value is global - affecting all views in all files, and is retained between sessions.

- Select **To Scale** to print at the scale specified in the Drawing Sheet Setup dialog. See *Drawing Sheet Setup Dialog on page 943*.
- To print a check plot, select **Check Plot at** and choose a scale adjustment from the drop-down list. See *Check Plots on page 949*.

5 Options

- Specify the number of **Copies** you would like to print.
- Check **Include Watermark** to include a watermark in the printed output. Click the **Define** button to open the Watermark Defaults dialog. See *Watermark Defaults Dialog on page 953*.
- Check **Print in Color** to print in color or clear the check box to print in either grayscale or black and white. In the Print Materials List dialog, system default colors are used when this box is unchecked.
- To print in grayscale, check **Obey Color On/Off Setting** in the Preferences dialog before printing, then uncheck **Print in Color**. See *Appearance Panel on page 60*.
- To print in black and white, uncheck **Obey Color On/Off Setting** in the Preferences dialog before printing, then uncheck **Print in Color**. Lines and fill colors print as either black or white, depending on which is closer to the line or fill's actual color.
- Most black and white printers print a grayscale approximation of the colors if **Print in Color** is selected.

6 Advanced Options

Click the **Open System Print Dialog** button to close the Print View dialog and print using your operating system's Print dialog instead. Not available when No Printer is selected.

7 Preview

Control the appearance of the print job preview on the right side of the dialog.

- Specify the **Page** that displays in the Preview area.
- Click the buttons to **Zoom In**, **Zoom Out**, or **Fit** the selected Page to the extents of the Preview area.
- Uncheck **Update Automatically** to turn off the print job Preview and prevent it from updating as changes are made to the settings in this dialog.
- Click the **Update** button to update the print job Preview to reflect the current settings in this dialog. If Update Automatically is unchecked, clicking Update may force the Preview to be blank.

8 Preview Pane

- When **Update Automatically** is checked, a preview of the current print job displays here. The drawing sheet displays as a white rectangle, and if multiple sheets are required, you can scroll through them. If the print job is large, a progress dialog may display briefly as the preview draws or updates.

9 Information

To help prevent unwanted printed output, information messages regarding page size, resolution, and scale may display below the preview pane, depending on the settings in this dialog.

Print Image Dialog



Any view can be printed by selecting **File> Print Image**. This is the only way to print most 3D views. See [3D Rendering on page 769](#).

The Print Image dialog is similar to the Print View dialog; however, the printing process is different. **Print Image** prints individual pixels as opposed to vectors (lines).

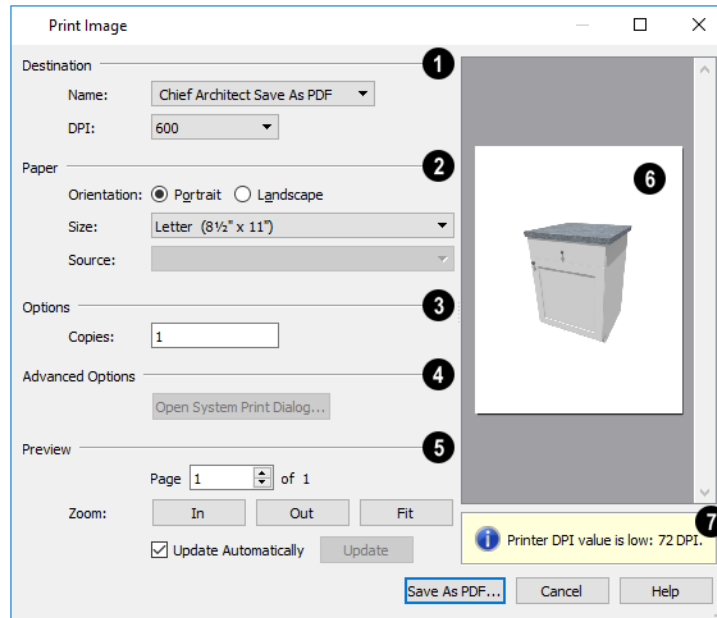

1 Destination

Select the Name of the **Printer** you wish to use from the drop-down list. To print to **.pdf**, select “Chief Architect Save as PDF” from the list, or choose a **.pdf** writer installed on your system. See [Printing to a PDF File on page 950](#).

- Select the **DPI**, or Dots Per Inch to use when printing, from the drop-down list. The available options may vary depending on the selected printer.

2 Paper

Select the **Paper Orientation**, **Size**, and **Source**. The available Size and Source options are controlled by the selected printer’s driver. See [Printer Drivers on page 941](#).

3 Options

Specify the number of **Copies** you would like to print.

4 Advanced Options

Click the **Open System Print Dialog** button to close the Print View dialog and print using your operating system’s Print dialog instead. Not available when No Printer is selected.

5 Preview

Control the appearance of the print job **Preview** on the right side of the dialog.

- Specify which **Page** displays in the Preview area.
- Click the buttons to **Zoom In**, **Zoom Out**, or **Fit** the selected Page to the extents of the Preview.
- Uncheck **Update Automatically** to turn off the print job Preview and prevent it from updating as changes are made to the settings in this dialog.
- Click the **Update** button to update the print job Preview to reflect the current settings in this dialog. If Update Automatically is unchecked, clicking Update may force the Preview to be blank.

6 Preview Pane

When **Update Automatically** is checked, a preview of the current print job is displayed to the right. If the print job is large, a progress dialog may display briefly as the preview draws or updates.

7 Information

To help prevent unwanted printed output, information messages regarding page size and resolution may display here, depending on the settings in this dialog.

Resources and Support

Chapter 40

Chief Architect technical support and training resources to help you be successful using our software.

TOPICS

Learning and Inspiration	962
Contacting Technical Support	963
Error Messages	963
Program Paths Dialog	964

Learning and Inspiration

Chief Architect offers a variety of resources that help you learn how to use the software, discover new drawing techniques, and connect with other Home Designer users.

HOME DESIGNER WEBSITE



The Home Designer website has an array of resources, including downloadable library content, program updates and more. Select **Help> Visit Home Designer Web Site** from the program menu to launch your default internet browser to HomeDesignerSoftware.com.

REFERENCE MANUAL



The Home Designer Pro 2022 Reference Manual is a comprehensive source of information about the entire program interface. This manual is available online in .pdf format by selecting **Help> View Reference Manual**.

USER'S GUIDE

Written for new Home Designer users, but a helpful reference for users of all experience levels as well, the User's Guide walks you through the process of creating a complete model, from the first wall to the interior design and landscaping.

This guide is available online by selecting **Help> View User's Guide**.

ONLINE HELP VIDEOS

Another resource that illustrates Home Designer's tools is the collection of tutorial videos available on our website. To view the online videos, select **Help> View Online Help Videos** from the program menu or visit www.homedesignersoftware.com/videos.

ONLINE KNOWLEDGE BASE

The Home Designer Knowledge Base is a collection of online articles that address common technical issues as well as a range of how-to questions with illustrations and step-by-step instructions. To access these resources, visit HomeDesignerSoftware.com.

HOME TALK ONLINE FORUM

The HomeTalk User Forum hosts ongoing discussion on a variety of topics related to the use of Home Designer. It is rich with useful tips and available free of charge to all registered Home Designer users.

- Discussions are initiated and carried out by users.
- Experienced users share knowledge with each other and beginners.
- Chief Architect Software team members post announcements, advice and technical information.

To visit HomeTalk, select **Help> HomeTalk** or go to hometalk.chiefarchitect.com.

ONLINE SAMPLES GALLERY



A collection of plans and renderings is available for viewing and download on our website. Select **File> Download Sample Plans** to launch your internet browser to HomeDesignerSoftware.com.

Contacting Technical Support

Chief Architect's world class technical support services can be accessed both online and by telephone. Select **Help> Technical Support** from the program menu to visit HomeDesignerSoftware.com.

Before contacting Technical Support, take a moment to see if the answer to your question is found in the program's Help, Training Videos, or other online resources. When you contact us, you will be referred to these resources if the answer can be found there.

There are a number of things you can do to ensure a speedy answer to your question when you contact Technical Support.

- Select **Help> About Home Designer (PC)** or **Home Designer> About Home Designer (Mac)** and make a note of the first characters of your Product Key and the program's Build number.
- We periodically release updates to the current program version. Before contacting Technical Support, select **Help> Download Program Updates** and make sure you are running the most current update for your program version.
- When you encounter an error message, click the **Send Report** button if possible and copy the message's exact wording. See *Error Messages on page 963*.
- When calling Technical Support, have Home Designer running on the computer where the problem occurs. This is necessary in order to troubleshoot the issue and verify that a solution is found.
- Be prepared to reproduce and describe the problem in detail. If we cannot reproduce the problem, there is a reduced chance that we will be able to resolve it.

TELEPHONE SUPPORT

Our Technical Support team is committed to answering your questions as quickly as possible and in the order received. We can resolve most issues in just a few minutes and are happy to help you find the best resource to answer your questions. So that we can quickly answer all calls, though, we may ask that you limit your inquiry to one question.

ONLINE SUPPORT

If a Support technician needs to see a copy of a plan, layout, or other file, they will ask you submit it to us using the Chief Architect [Online Support Center](#).

Questions can also be submitted directly to the Technical Support department using the Online Support Center as well. Be sure to provide a detailed description of the problem you are encountering in your ticket.

Error Messages

Most common error messages have a known cause and simple resolution. When you encounter an error or warning message in Home Designer, you can click the **Check Knowledge Base** button in the message box to launch your default internet browser to the Home Designer Knowledge Base on our website, HomeDesignerSoftware.com.

If the message is discussed in an article it will display, providing information about the message and how best to avoid it.

It is important that abnormal errors be reported to Chief Architect Technical Support so that we can identify and resolve any problems.

The content of an error message is useful in diagnosing its cause. If you encounter an error message, make a note of the error number and the full text of the message. You can also click the **Details** button and copy the text into a text document or *Online Support on page 963* Center ticket.

If you encounter the error more than once, make a note of your steps prior to receiving the message.

Finally, check to see if there are program updates available. Program updates contain enhancements and other changes that allow the software to perform at an optimum level. Select **Help> Download Program Updates** from the Home Designer menu and follow the instructions on our website, HomeDesignerSoftware.com.

ERROR REPORTING

When an error occurs, you may have the option in the message box to send the report to Chief Architect by clicking the **Send Report** button in the error message box. A report containing technical details about the error, but no personal information, is sent to our Testing team for evaluation.

When you click the Send Report button, the **Automatically Send Error Reports** option will be enabled so that a report will be sent automatically should you encounter additional errors in the future. When Automatically Send Error Reports is enabled, error message boxes will not have a Send Report button. You can enable or disable Automatically Send Error Reports in the Preferences dialog. See *General Panel on page 66*.

After clicking the **Send Report** button, please contact [Technical Support](#) with any additional information that you may have about the circumstances of the error: for example, the type of view that was open and the tool that was active.

Program Paths Dialog

Some technical issues can be caused by problems with support files used by Home Designer Pro. In the event of such an issue, Chief Architect Technical Support may direct you to the Program Paths dialog. This dialog displays a list of files utilized by the software along with the pathname of each.

To avoid unintended problems that could prevent you from using the software, it is strongly recommended that you make no changes to any of the files in this list except with the direct assistance of Technical Support.

What's New in Home Designer 2022

Chapter 41

Welcome to Home Designer 2022. This topic has been written to help our upgrading customers make a smooth transition from earlier versions of Home Designer to Home Designer 2022.

TOPICS

Getting Started Checklist	966
Migrating Legacy Content	967
Migrating Legacy Settings	967
Migrating Legacy Templates	968
Considerations for Legacy Files	968
New and Improved Features by Chapter	973

Getting Started Checklist

There are many new features in Home Designer 2022, and many existing features have changed. The following checklist suggests steps you should take before migrating your files to Home Designer 2022. More information about each of these steps can be found after the checklist.

1. Review the List of New and Improved Features by Chapter

There are a number of important reasons why you should familiarize yourself with the new and improved features in Home Designer 2022:

- New and improved features allow you to produce drawings more efficiently, so it is to your advantage to use them.
- Some changes to existing functionality may affect your accustomed drawing style and thus your productivity if you are not aware of them.
- New features may affect your choice of settings in your template files, as well as your preferred Preferences settings.

See *New and Improved Features by Chapter* on page 973.

2. Review Migrating Legacy Content

Legacy users of Home Designer often have library catalogs and other custom content that they want to continue using. See *Migrating Legacy Content* on page 967.

3. Review Migrating Legacy Settings

Before migrating Preferences or Toolbars, bear in mind that legacy settings may not be best suited for using the new program version. See *Migrating Legacy Settings* on page 967.

4. Review Migrating Legacy Templates

Before migrating Templates, bear in mind that they may not be set up to take advantage of new tools in the new program version. See *Migrating Legacy Templates* on page 968.

5. Review the Considerations for Legacy Files

Before opening a plan or layout file created in a previous version of Home Designer, be aware of potential changes to the file that could occur in the new program version. See *Considerations for Legacy Files* on page 968.

6. Launch Home Designer 2022

Once you have learned about the new features in Version 2022 and decided whether to migrate any custom settings from a legacy program version, launch Home Designer 2022. The first time you launch, the Migrate Settings dialog will give you the opportunity to bring legacy settings and content forward into Version 2022.

Migrating Legacy Content

Legacy users of Home Designer Pro often have a wealth of library catalogs and other custom content that they have built over time and want to continue using.

LEGACY LIBRARY CONTENT

There are several ways that legacy library catalogs can be brought into Home Designer 2022.

If you have Home Designer version 2014 through 2021 installed on your computer, the Migrate Settings dialog will display after you activate the license, allowing you to migrate library content as well as a selection of other settings for use in Home Designer 2022. If multiple legacy versions are present on the system, only the data associated with the most recent will be migrated.

You can import library files from Versions 8 through 2014 at any time by selecting **Library > Import Library (.calib, .calibz)** from the program menu.

In addition, library files from Versions 7 and prior can be imported by selecting **Library > Convert Legacy (.alb) Library Files** from the program menu. Bear in mind, though, that older content may not be of the same quality as currently offered catalogs and that legacy Manufacturer catalogs may be out of date.

CUSTOM GRAPHICS FILES

Home Designer can use graphics files regardless of where they are stored on your system; however, it is a good idea to keep your data organized in one location. If you have custom graphics files, including textures, images or backdrops that you used in a previous program version, you can copy them manually using your operating system for use in Home Designer 2022.

- Copy custom texture files to the Home Designer 2022 Textures folder located in the Home Designer 2022 Data folder.
- Copy custom image files to your Home Designer 2022 Images folder located in the Home Designer 2022 Data folder.
- Copy custom backdrop files to your Home Designer 2022 Backdrops folder located in the Home Designer 2022 Data folder.

In Home Designer 8 through 2021, custom graphics were saved in the Home Designer Data folder, as they are in version 2022. In version 7, they were located in the program's installation directory, in folders that began with "My". Custom backdrops, for example, were saved in "My Backdrops".

Texture and image files are not listed in the Library Browser. These files can be assigned to material and image objects, however, which are stored in the library so it is important to retain them. There are several tools available for adding materials and images to the library.

Migrating Legacy Settings

The Migrate Settings dialog lets you migrate settings from the most recent legacy installation of your Home Designer title into Version 2022. If you have extensively customized your Preferences or Toolbars, you may want to continue using those settings. Before doing so, though, it is important to consider that you may make it harder to take advantage of new tools and functionality in Version 2022.

PREFERENCES SETTINGS

Although you can migrate your Preferences settings from Versions 2014 through 2021 into Version 2022, the settings that are available in Version 2022 may differ from previous program versions. You should review all the settings in the Preferences dialog to make sure that they are set to suit your drawing needs. For more information, see *Preferences Dialog on page 59*.

CUSTOM TOOLBARS

It is possible to migrate toolbars from previous program versions into Version 2022; however, it is also possible that your migrated toolbars will be missing new tools available in Version 2022.

Additionally, obsolete toolbar buttons are occasionally removed from the program and will also be removed from migrated legacy toolbars. See *New and Improved Features by Chapter on page 973* for information about new features as well as removed or deprecated tools.

We recommend that you set up your custom toolbars the way you would like them in Version 2022. You may find it most effective to customize your toolbars as you get used to working in the new program version, rather than beforehand.

Migrating Legacy Templates

Home Designer 2022 installs a selection of template plan and layout files that have been set up to take advantage of the program's updated tools and features. Although you can migrate your template files for use in Version 2022, for best results it is recommended that you use the templates installed with Home Designer 2022.

If you choose to continue using template files that you used in a previous program version, it is very important that you take the time to review all the default settings in the file, making sure that they will continue to suit your needs in Version 2022. See *New and Improved Features by Chapter on page 973*.

Next, make sure that you are aware of changes in Version 2022 that may affect legacy files: including templates. See *Considerations for Legacy Files on page 968*.

Considerations for Legacy Files

As in all software, every new program version introduces changes to its functionality as well as to the user interface. If you choose to bring a project forward, be sure to take a few moments to look it over in the new version and confirm that the new functionality does not require you to make any modifications. Particularly if you have an approaching deadline, you may find it best to finish the current project in the version of the software in which you began it.



Be sure to read this section before opening any plans created in earlier versions of Home Designer.

Home Designer 2022 can open the **.plan** and **.layout** files from prior versions. Files with the older **.pl** and **.la** file extensions are no longer supported, however, and cannot be opened by Home Designer 2022. Before opening any files created in earlier versions of Home Designer, it is important to be aware of changes made in the newest version and the effect they may have on your legacy plan and layout files.

Please note that files saved in the latest program version cannot be read by older versions of the software. When a legacy file is saved in the version 2022, an unaltered copy of the original file is created in the Home Designer 2022 Data folder, under Archives, which can still be opened in the original version.

FOR FILES CREATED IN VERSION 2021 AND PRIOR

In addition to the above recommendations, if you wish to open files created in Home Designer Version 2021 or prior, bear in mind the following:

1. Default 110V Ceiling Outlet

In Home Designer 2021 and prior, the 110V Outlet tool did not have the ability to place outlets in ceilings. In Version 2022, this ability was added, as was the new GFCI Outlet tool. When a legacy file is opened in Version 2022, the new Electrical Defaults settings for these items will automatically refer to objects in the Version 2022 Core Catalogs. You should confirm that these defaults meet your needs. If these default objects are not present in your library, a warning message will inform you of the issue.

2. Gable Lines

In Home Designer 2021 and prior, Gable Lines with a Pitch value of 90° were allowed but did not affect automatic roof generation. In Version 2022, they are not supported. When a legacy file is opened in Version 2022, any Gable Lines with a Pitch of 90° will be removed automatically. This will not affect the current roof or automatic roof generation.

FOR FILES CREATED IN VERSION 2020 AND PRIOR

In addition to the above recommendations, if you wish to open files created in Home Designer Version 2020 or prior, bear in mind the following:

1. Perspective Crop Mode

In Home Designer 2017 through 2020, Perspective Crop Mode allowed older functionality governing zooming in cameras from Version 2016 and prior to be preserved in saved cameras in legacy plans migrated forward. This deprecated tool has been removed from the program's menu and toolbars in Version 2021, although it can be migrated with legacy toolbars and hotkeys. Saved cameras in legacy plans with this behavior enabled may become distorted if you pan or zoom in the view. To permanently disable this behavior in a camera view and resolve the resulting distortion, select **Window> Fill Window** or press the F6 key.

2. Units of Measurement

In Home Designer 2020 and prior, units of measurement used by the program, including user-defined units, were stored in a file called Units.dat located in the Home Designer Data folder. Beginning in version 2021, this information is saved with other Preferences settings.

FOR FILES CREATED IN VERSION 2019 AND PRIOR

In addition to the above recommendations, if you wish to open files created in Home Designer Version 2019 or prior, bear in mind the following:

1. Marker and Elevation Point Heights

In Home Designer 2019 and prior, the # sign could be added to the label of a Marker or Elevation Point and the label would report the height of the Marker or the Elevation Point's elevation. In Version 2022, text macros are used to report this information instead. In legacy plans, any # signs in Marker or Elevation Point labels will be replaced by the %height% or %elevation% macro.

2. Glass Shower Walls

In Home Designer 2019 and prior, the "Glass Shower" wall type was included in installed template files and like other wall types, built to the structural layer of floors and ceilings and to the Main Layer of adjacent walls. In Version 2022, this wall type has the new Partition Wall attribute and instead builds to floor, ceiling, and wall surfaces. When a legacy

file is opened in Version 2022, this wall type will be modified to have Partition Wall checked automatically and existing walls will be affected by this change.

FOR FILES CREATED IN VERSION 2018 AND PRIOR

In addition to the above recommendations, if you wish to open files created in Home Designer Version 2018 or prior, bear in mind the following:

1. Parallel Lights

In Home Designer 2018 and prior, Parallel Light sources could be specified for electrical light fixtures and Added Lights. In Version 2022, Parallel Lights are no longer supported. In legacy plans opened in Version 2022, any Parallel Light sources will be converted to Spot Lights.

2. Joist Direction Lines

In Home Designer 2018 and prior, Joist Direction Lines described all platform framing as “joists” and used nominal lumber sizes in whole inches in US Unit plans. In Version 2022, the platform’s framing Structure Type is reported and in US Unit plans, the size is described in fractional inches. When a legacy file is opened in Version 2022, Joist Direction Lines will use the new, more accurate labeling.

FOR FILES CREATED IN VERSION 2016 AND PRIOR

In addition to the above recommendations, if you wish to open files created in Home Designer Version 2016 or prior, bear in mind the following:

1. Boxed Eaves

In Home Designer 2017, improvements to the generation of Boxed Eaves ensure that they extend into exterior rooms with “Use Soffit Surface for Ceiling” specified when located between the roof baseline and an interior room. In some legacy plans opened in Version 2022, the **Length** value for Boxed Eaves may need to be modified in the Roof Plane Specification dialog.

2. Uppercase Text

The Uppercase option was added to Text Styles in Version 2017, whereas in Version 2016 and prior, it was an option for Room Labels only. In legacy plans opened in Version 2017, Room Label Defaults will be assigned a Custom Text Style if any Room Labels are present in the drawing. The Room Labels will be assigned a Custom Text Style, as well. If a given Room Label has been sent to layout more than once and was set to use different Text Styles in each layout view, it is possible that its appearance may be affected in some views.

FOR FILES CREATED IN VERSION 2015 AND PRIOR

In addition to the above recommendations, if you wish to open files created in Home Designer Version 2015 or prior, bear in mind the following:

1. Built-in Appliances

In Home Designer 2015 and prior, some appliance symbols designed to be inserted into base cabinets had incorrect sizing data. In legacy plans opened in Version 2022, these appliances will not fit into the cabinet correctly and will need to be replaced. Built-in dishwashers are particularly affected.

2. Formatting of Bulleted and Numbered Lists

In Version X7, various improvements were made to the way lines of Rich Text are spaced. In legacy plans opened in Version X7, Rich Text objects with bulleted and numbered lists may require adjustments.

3. Chief Blueprint Font

The Chief Blueprint font was improved for Version X6, with decreased top and bottom spacing. The change in spacing may increase the overall height of text objects using this font in X6 files opened in Version 2022. X5 and prior legacy files will not be affected by this change.

FOR FILES CREATED IN VERSION 2012 AND PRIOR

In addition to the above recommendations, if you wish to open files created in Home Designer Version 2012 or prior, bear in mind the following:

1. Roof Overhangs and Framing

In Home Designer 2012 and prior, roof overhangs were measured to the outside of the subfascia, whereas in Version 2014 and later, they are measured to the outside of the fascia. In legacy plans opened in Version 2022, this will not affect the appearance of roof planes in floor plan view because in 2012 and prior, roof plane polylines represented the projected framing area whereas in Version 2022 they represent the total projected area. But, the position of the fascia and subfascia will shift, as will the length of the rafters.

2. Door Swing Direction and Materials

In Home Designer X4 and prior, exterior doors that swing outward display interior material on exterior side of door. This was corrected in Version 2022. Doors modified to work around the old behavior could be affected in legacy plans opened in Version X5.

3. Door Swing Direction and Louvers

Improvements to door louver direction may affect louvers in all doors with the exception of bifold doors.

4. Wrapped Door/Window Lintels and Window Sills

In Home Designer 2012 and prior, wrapped lintels and sills extended out further than those that were not wrapped. In legacy plans opened in Version 2022, the extents of wrapped lintels and sills will be adjusted so that they equal their **Extend** setting.

5. Invisible Beams

The legacy **Invisible Beam** check box was removed from the Wall Specification dialog. When legacy plans are opened in Version 2022, any **Invisible Beam** walls will be converted to Invisible Walls.

FOR FILES CREATED IN VERSION 10 AND PRIOR

In addition to the above recommendations, if you wish to open files created in Home Designer Version 10 or prior, bear in mind the following:

1. Text Styles

The appearance of a number of objects that include text - including object labels, the North Pointer, Sun Angles, Joist Direction Lines, the Up/Down arrows for stairs and ramps - can now be controlled using Text Style. Their appearance may be altered somewhat in legacy plans opened in Home Designer 2022.

2. Light Sources

The illumination created by light fixtures and Added Lights was improved in Home Designer 2022. Lighting in legacy plans may appear noticeably brighter when viewed in version 2022.

FOR FILES CREATED IN VERSION 9 AND PRIOR

If you wish to open files created in Home Designer Version 9 or prior, bear in mind the following file management changes and structural enhancements:

1. Legacy file formats

Home Designer7 files were saved in .pl and .la the file formats. These file formats files are no longer supported and cannot be opened in version 2022.

2. Material textures, images, and backdrops

Home Designer9 and prior installed with a catalog of library content, including a selection of material textures, images, and backdrops. This library catalog is no longer installed with the program because it is now available for download on-demand, so it will be possible to open a legacy plan in version 2022 and encounter numerous missing file warnings. To avoid this, we recommend using the **Export Entire Plan** feature in the original program version to create a folder that includes the plan and all associated textures, images, and backdrops before opening this file in 2022. This tool is renamed Backup Entire Plan in version 2022.

3. Floor and ceiling finish thicknesses

In Home Designer 9 and prior, floor and ceiling finish layers were not modeled in 3D, and objects such as railings, stairs, landings, cabinets, fixtures, and furnishings measured their Floor to Bottom height from the subfloor. These objects now measure their Floor to Bottom height from the floor finish surface, so it is possible that you may notice height changes for these objects - particularly in saved, annotated cross section/elevation views.

4. Riser heights and landing thicknesses

The default Best Fit Riser Height for stairs that do not reach the next level has been updated from 9" (225 mm) in version 9 and prior to 6 3/4" (169 mm) in Home Designer 2022. This may affect the riser heights of stairs, as well as the thicknesses of landings attached to those stairs.

5. Auto Adjust Height

The Follow Terrain option in some specification dialogs was replaced by the Auto Adjust Height check box. If a cabinet, fireplace, fixture, furniture, or other library symbol had Follow Terrain unchecked in version 9 or prior and was located in a room with a floor height other than the default for the current floor, then the object's Floor to Bottom Height will change to equal that room's floor height. The object's position in the model will not change, however.

6. Adjustable Thickness Walls

In Home Designer 9 and prior, generic, single-layer wall types were available for use. When a legacy plan file is opened in version 2022 and these wall types are detected, they are replaced by an updated, non-generic wall type. Framed walls and Railings will also acquire 1/2" (13 mm) thick layers of sheetrock on each side. Railings that define a Deck room with Advanced Deck Framing Built will not acquire sheetrock layers.

7. Stairwells defined by railings

Interior railings that used a generic, single-layer wall type drawn in older program versions will acquire layers of sheetrock when the plan is opened in version 2022. This can affect the appearance of staircases where they join to a floor platform. To address this issue, select the railing and move it 1/2" (13 mm) away from the top edge of the staircase.

8. Deck rooms

In legacy plans opened in Home Designer 2022, Deck rooms with Advanced Deck Framing built retain the framing but have Automatic Deck Framing turned off by default. Decks with no Advanced Deck Framing built are converted to Balcony rooms.

9. Structural Member Reporting

When a plan created in Home Designer 9 or prior is opened in Home Designer 2022, Materials Lists are set to calculate **Total Linear Length**. For a combination of linear length and piece count, select **Mixed Reporting** in the Structural Member Reporting dialog.

10. Fill New Framing Members

In Home Designer 9 and prior, Fill New Framing Members was view-specific; in Home Designer 2022 it applies to the entire plan. As a result, it is turned off by default in legacy plans opened in version 2022.

New and Improved Features by Chapter

The following is a list of new and improved features in Pro Version 2022. Where possible, cross-references to additional information has been provided.

FILE MANAGEMENT

- The **Save** and **Save As** commands are now available in Materials Lists.
- Auto Save files are now created for unsaved plan and layout files.

PROJECT MANAGEMENT

- Improved snapping and drawing order of Space Planner Room Boxes.

PREFERENCES AND DEFAULT SETTINGS

- The Width of the crosshairs can now be specified.
- New **Automatically Send Error Reports** option in the Preferences dialog.
- New **Pinch Zoom Sensitivity** setting in the Preferences dialog.
- The obsolete Use Enhanced Lighting and Use Global Illumination Troubleshooting options were removed from the Preferences dialog.

WINDOW AND VIEW TOOLS

- New **Fill Window Selected Objects**  tool.
- The name of a saved plan view is now reported in its Plan View Specification dialog.

CREATING OBJECTS

- The **Center Object** edit tool has been added to the Copy/Paste edit toolbar.

DISPLAYING OBJECTS

- The **Height** of Herringbone fill patterns can now be specified.

EDITING OBJECTS

- The **Convert Polyline** tool can now be used to create a Custom Backsplash in cross section/elevation views.

CAD OBJECTS

- New **Match Line Color** option for arrowheads.
- The **Center Object** edit tool can now be used to center CAD objects in cross section/elevation views.

WALLS, RAILINGS, AND FENCING

- New **Material Layer** settings in the Wall Type Definitions dialog.
- Wall type definitions are no longer limited to ten layers.
- New **Horizontal Framing** option for wall framing layers.
- The **Platform Intersection** settings for walls that create standard or balloon framing have been improved.
- New **Ignored by Hide Exterior Walls** option in the Wall Specification dialog.
- Wall Hatching now has a defaults dialog and can also be assigned a label.
- The **Object Eyedropper** tool now works with walls.
- Wall Hatching can now be copied and pasted.
- Improved feedback when it appears that a wall's layers may be oriented incorrectly.

ROOMS

- New Crawl Space Room Type.
- Rooms with a Ceiling Height of less than 48" (1200 mm) are now automatically excluded from the Living Area calculation by default.
- Room moldings can now be suppressed behind cabinets and architectural blocks.
- The Room Type and Structure can now be specified when multiple rooms are selected.
- The Living Area label can no longer be deleted: the Plan Check tool is no longer needed to generate a new one.

DIMENSIONS

- The default **Angular Format** of Angular Dimensions can now be specified.
- Manually drawn dimension lines in cross section/elevation views can now be edited to locate cabinet doors, drawers, panels, and openings - including the openings associated with front appliances.
- Dimension lines can now locate **Wall Steps**.
- New **Display Wall Widths** option in the Dimension Line Specification dialog.
- New option to display dimension numbers in inches only rather than formats that use feet when less than or equal to a specified value.
- The Locate Objects settings can now be set independently for different manual and automatic dimension tools.
- The Auto Dimension Defaults for Auto Exterior and Auto Interior Dimensions have been consolidated into a single Dimension Defaults dialog.
- When selected, dimension lines drawn with the Interior Dimension tools are now described as such in the Status Bar.
- The Interior Dimension tool can now be set to locate objects besides walls.
- New **Inner Dimension** option allows you to suppress the inner dimension strings created by the Auto Exterior Dimension tool.
- Temporary Dimensions now always generate when toggled on, regardless of whether dimension lines already locate the selected object.

TEXT, CALLOUTS, AND MARKERS

- Text objects can now be added to the library without first including them in a CAD Block.





DOORS AND WINDOWS

- Wall Niches now have automatic labels.
- Wall Niches can now be placed in pony walls with railings.
- New **Opening Indicators** settings for doors, windows, and cabinets.
- Opening indicator arrows can now display on sliding doors and windows.
- The direction of **Opening Indicators** in Vector Views can now be set in the Plan Defaults dialog instead of the Preferences dialog.
- New setting for opening indicator direction in legacy files in the Preferences dialog.
- Interior doors now retain their attributes when copy/pasted placed from the Library into an exterior wall.
- New **Bottom Sill** options for door and window framing.

CABINETS

- The **Generate Custom Countertop** edit tool now applies a selected base cabinet's non-default counter material to the new countertop rather than applying the default counter material.
- Door and drawer **Front Height** and **Front Width** values are now reported for reference in the Cabinet Specification dialogs.
- Automatic countertop overhangs are now clipped and toe kicks suppressed on any cabinet side positioned near a Partition or free-standing appliance.
- A cabinet's bottom Separation can now be resized past the bottom of the cabinet itself.

ELECTRICAL

- New **GFCI Outlet**  tool.
- New **Change to GCI Outlet**  and **Change to 110V Outlet**  edit tools.
- The **110V Outlet**  tool can now be used to place ceiling outlets in Garage and Slab rooms in plan view; in camera views, it can place ceiling outlets in all room types.
- Electrical objects can now be group-selected by type when the drawing tool used to create them are active.

FOUNDATIONS

- New Slab Defaults and Slab with Footing Defaults dialogs.
- Foundations with a **Basement Ceiling Height** of less than 48" (1200 mm) are no longer included in the Living Area.
- The **Minimum Garage Height** setting in the Foundation Defaults dialog no longer includes a sill plate measurement.

ROOFS

- The Convert to Plain Polyline edit tool is now available for Roof and Ceiling Planes.

FRAMING AND TRUSSES

- Wall, roof, and floor/ceiling platform layers no longer have to be assigned a Framing material in order to generate framing.
- The Roof and Floor/Ceiling Truss Specification dialogs now have an object preview pane.

- New **Allow Automatic Balloon Framing** option in the Build Framing dialog controls how wall framing adjacent to Open Below rooms is generated. Uncheck this to generate plates and rim joists instead of balloon framing when wall framing is built.
- The **Reflect About Object** edit tool is now available for Joist and Roof Blocking.
- A Roof Truss drawn over a Full Gable Wall now has **End Truss** and **Reduced Gable** checked automatically.

TRIM AND MOLDINGS

- New **Replace Molding**  tool.
- New **Type** setting for cabinet moldings which is reported in the Materials List.

THE LIBRARY

- The Library Search now supports Boolean keywords: AND, OR, NOT, as well as parentheses.
- New symbols, fill styles, and backdrops can now be added to the library from the Select Library Object dialog.
- New **Copy to User Catalog** option in the contextual menu in the Library Browser.
- New **Duplicate** option in the Library Browser allows you to copy an item in the User Catalog and immediately paste the duplicate in the same location.
- **Update Library Catalogs**  is now available as a button at the bottom of the Library Browser side window.
- When multiple identical objects are added to the library, only one instance is now created in the User Catalog.

MATERIALS

- New **Copy Selected Material**  option for the Material Painter.
- The "Air Gap" **Material Structure Type** has been removed from the program.
- The Plan Materials dialog is now searchable.
- New scoping modes for the **Adjust Material Definition** tool.
- The Status Bar now reports information about materials highlighted when the **Adjust Material Definition** tool is active.
- New **Add to Library** button in the Define Material dialog.
- The Select Material dialog can now be opened by double-clicking on a line item on the Materials panel of various specification dialogs.
- The obsolete Toggle Textures tool has been removed from the program.

3D VIEWS







- New **Show Color** and **Show Watermark** options in the Camera Specification dialog.
- New **Scene Clipping** options for cross section/elevation views.
- Wall Elevation views can now include or ignore walls located on the floor above: for example, the gable walls associated with cathedral or vaulted ceilings.
- Overview cameras now ignore the terrain when determining their initial position.
- The right mouse button can now be used to temporarily activate **Mouse-Tilt Camera** mode while Mouse-Orbit Camera mode is in use.
- New Framing Overview Defaults dialogs.
- Cross section/elevation views can now be copied and pasted.

- The Auto Adjust Default Glass Properties setting no longer applies to door and window glass and was renamed to Auto Adjust Electrical Default Glass Properties.
- Obsolete View Types with Colors On settings removed from the 3D View Defaults dialog.

3D RENDERING AND RAY TRACING

- The obsolete Update View button was removed from the PHYSICALLY BASED panel of the Rendering Technique Options dialog. .

PICTURES, IMAGES, AND WALKTHROUGHS

- New Walkthrough Preview side window.
- New **Create Orbital Walkthrough Path**  tool.
- A camera view of a single frame of a Walkthrough Path can now be created.
- Rendering Technique, lighting and more can now be set in the Walkthrough Path Specification dialog.
- The Backdrop image can now be set in the Walkthrough Path Specification dialog.
- A Walkthrough Path's **Duration Along Path** and **Frame Rate** can now be set in the Walkthrough Path Specification dialog.
- Walkthrough Path Key Frames are now easier to select, have their own edit handles, and the selected Key Frame in plan view is also selected for editing when the Walkthrough Path Specification dialog is opened.
- New **Delete Key Frame**  edit tool for Walkthrough Paths.
- The Start and End Key Frames of a Walkthrough Path can now be deleted provided that at least two Key Frames remain.
- The **Add Key Frame**  edit tool now has **Sticky Mode** .
- New Key Frames now have height and angle settings basing on those of adjacent Key Frames.
- The **Reverse Direction**  edit tool is now available for Walkthrough Paths.
- The **Complete Break**  edit tool is now available for Walkthrough Paths.
- The obsolete Edit Key Frames button for Walkthrough Paths was removed from the program.
- The **Record Walkthrough Along Path** edit tool is no longer available for plain CAD polylines and splines.
- The settings in the Export Picture dialog are now retained between program sessions.

IMPORTING AND EXPORTING

- New warning allows option to cancel import of extremely large 3D symbols.
- Added support for AutoCAD® version 2021 file import and export.
- Added support for SketchUp version 2021 file import and export.
- New Export Thermal Envelope Data option.



TERRAIN

- Terrain Paths now have separate **Terrain to Top** and **Thickness** settings, and their materials are calculated in the Materials List.
- The Terrain Path Specification dialog now has a COMPONENTS panel and an object preview pane.

ROADS AND SIDEWALKS

- Roads now have separate **Terrain to Top** and **Thickness** settings, and their materials are calculated in the Materials List.
- The Road Specification dialog now has a COMPONENTS panel and an object preview pane.

MATERIALS LIST

- Materials Lists created using the **Calculate Structural Materials for Deck**  edit tool now include accessories added to the deck room.
- To **Revert all Line Items to Defaults**  option on the **Components** panel of various object specification dialogs resets any customized formulas values.
- Materials Lists using the Linear Length Reporting Method no longer include length information in the Size column.
- Thermal envelope information is no longer reported in the Materials List.

LAYOUT

- The Send to Layout dialog now preserves the 'Send Options' and 'Camera View Options' settings for different view types last used within the same session.
- The Delete Objects dialog is now available in layout.
- Plan file name and view information for a selected layout box is now reported in the Status Bar. .

Index

- 3
- 360 Panorama Export 844
- 3D
 - Backdrops 763
 - Data Import 839
 - Delete Surface 749
 - Mice 14
 - Symbols, Importing 840
- 3D Roof Designer 573
- 3D View Defaults Dialog 739
- 3D Views
 - Display 747
 - Doll House 742-743
 - Editing 757
 - Framing Overview 743
 - Full Overview 743
 - Line Weights 950
 - Overviews 741
 - Save 759
 - Working in 757
- 3D Wall Designer 236
- A**
- Absolute Location
 - New point 196
- Add Break
 - partial 172
- Added Lights 772
- Adding
 - Floor Between Existing Floors 504
 - to the Library 681
 - Toolbar Buttons 95
- Adjust
 - Material Definition 719
 - Wall Angle 73
- Adjust Lights Dialog 775
- Alcove Roofs 591
- Align
 - Curved Stairs Between Floors 170
 - Curved Walls Between Floors 251
 - Objects 168
 - Pony Walls Between Floors 251
 - Roof Edges 575
 - Text 349
 - Walls 249
- Allowed
 - Angles Dialog 184
- Alpha Channel 729
- Alphabets
 - International 339
 - Unicode 339
- Ambient Light
 - Daytime 773
 - Interior 773
 - Nighttime 773
- Angle Snaps 114
- Angled Front Cabinets 450
- Angles
 - Entered as bearings 201
- Angular Dimensions 176, 324, 334
- Appearance Preferences 60
- Appliances
 - Built into cabinets 435
- Arc
 - Creation Modes 206
 - Panel 210
 - Specification Dialog 209
 - Tools 207
 - with Arrow 209
- Architectural Block
 - Specification Dialog 699
- Architectural Blocks 696
 - Components 701
 - Displaying 697
 - Edit Sub-Objects 698
 - Explode 698
 - Sub-objects 700
- Architectural Preferences 73
- Archive Files 40
- Arcs
 - Aligning Centers 170
 - Arc About Center 207
 - Arc Creation Modes 206
 - Show Arc Centers 151
 - Start and End Points 76
- Area
 - Living Area calculation 283
 - of a Polyline 215
 - of Roof Planes 581
 - of Rooms 288
- Arrow
 - Auto Positioning 353
 - Panel 205
- Artwork
 - Creating textures 723
- Attic
 - Floor 509
 - Rooms 282
 - Trusses 650
 - Walls 254
- Auto
 - Archive 40
 - Check for Program Updates 67
 - Dormer Tool 597
 - Dormers, Editing 598
 - Floating Dormer 596
 - Floating Dormer Tool 596
 - Interior Dimensions 326
 - Place Corner Boards 660
 - Place Outlets 472
 - Place Quoins 662
 - Roof Returns 601
 - Save Files 41, 68
 - Stairwell 536
- Auto Rebuild
 - Attic Walls 224
 - Framing 609
 - Roofs 561
 - Terrain 860
 - Walls/Floors/Ceilings 506
- Automatic
 - Framing 608
 - Roofs 557
 - Roofs vs. Manual Roofs 557
- B**
- Back Clipped Cross Section 744
- Backdrops 812
 - 3D 763
 - Definition 812
 - Generated Sky 765
 - Panoramic 813
- Background Color 62

- Backup
 - Entire Plan or Project 44
 - Files 39
- Balloon Through Ceiling 265
- Balusters 274
 - Definition 512
- Base
 - Cabinets 434
- Baseline
 - Polylines (Roofs) 583
 - Roofs 570
- Basements
 - Daylight 492
 - Walkout 492
- Bay Windows 395
- Bay/Box Window
 - Specification Dialog 426
- Beams
 - Bearing 639
 - Floor/Ceiling 613
 - Roof 612
 - Roof, exposed 704
- Bearing
 - Beam 639
 - Line 631
- Bearings 201
- Behaviors Preferences 76
- Birdsmouth
 - Cut 574
- Blend Colors with Materials 715
- Blind Cabinets 450
- Blocking
 - Joist 612
 - Roof 612
 - Wall 619
- Blocks
 - Architectural 696
- Bonus
 - Library Catalogs 677
 - Rooms 509
- Bow
 - Window Specification 426
- Bow Windows 395
- Box
 - Tools 217
- Windows 395
- Break
 - Line 172
 - Line, complete 173
 - Terrain Breaks 853
- Brick Ledges 231
- Build
 - Foundation 485, 504
 - Framing Dialog 613
 - House 48
 - New Floor 503
 - Roof Dialog 562
 - Terrain 860
- Bumping/Pushing 166
- C**
- Cabinet
 - Defaults 432
 - Designer 431
 - Modules Library 435
 - Shelf Specification Dialog 461
 - Specification Dialog 450
 - Tools 434
- Cabinets
 - Angled front 448
 - Backsplash 452
 - Base 434
 - Bevel 459
 - Blind 450
 - Built-in appliances 435
 - Corner 448
 - Countertop, custom 435, 438
 - Countertops 438
 - Delete face items 455
 - Dimension to corners/sides 318
 - Door/Drawer Overlay 454
 - Door/drawer style 435
 - Doors, diagonal 453
 - Doors, glass 458
 - Editing 444
 - End cabinets 448
 - Fillers 436
 - Frameless 454
 - Front Indicators 440
 - Front Panel 454
 - Full Height 434
 - General Defaults 433
 - Glass doors 458
 - Island 450
 - Labels 441
 - Lazy Susan 453
 - Minimum Width 433
 - Module Lines 440
 - Module lines, partial 433
- Moving, with Wall 446
- Opening Indicators 440
- Peninsula radius 448
- Radius end 448
- Resize Increment 433
- Reverse Appliance 457
- Separation 454
- Shelves 461
- Special shapes 448, 451
- Stile 458
- Toe kick 453
- Wall 434
- CAD**
- Angle Snaps 114
- Angles in Degrees/Bearings 193
- Blocking box 217
- Box 217
- Circle about center 212
- Circle Tools 212
- Circles 212
- Convert to Terrain 882
- Cross box 217
- Current Point 197
- Delete Current Point 198
- Drawing Tools 194
- Ellipses 213
- Fillet 174
- In Layout 926
- Line Length Format 194
- Lines 199
- Ovals 213
- Points, moving 198
- Polylines 214
- Preferences 74
- Rectangular Polyline Tool 217
- Resize 77
- Rotate around 77
- Rotate items 77
- Rotate Jump 77
- Stretch 184
- Temporary Points 197
- CAD Box**
 - Specification Dialog 218
- CAD Defaults** 193
- CAD Objects**
 - Converting 179
 - Dimensions to 319
 - Displaying 220
- Calculate**
 - From All Floors 905
 - From Room 905
 - Loan 51
 - Materials on soffits 705

- Callout
 - Arrows 354
 - Defaults 338
 - Size and Shape 355
 - Specification Dialog 355
- Callouts 354
- Camera
 - Activating 759
 - Clip Surfaces Within 767
 - Create Views 741
 - Defaults 737
 - Field of View 756
 - Move Tools 752
 - Move Up/Down One Floor 755
 - Orbit Tools 753
 - Plan Display Panel 763
 - Specification Dialog 760
 - Tilt Tools 753
- Casing
 - Door 373, 383
 - Window 404
- Cathedral Ceilings 298
- Ceiling
 - Break Lines 299
 - Framing 614
 - Heights 293
 - Plane 586
 - Shelf 295
 - Trusses 642
- Ceiling Finish Dialog 306
- Ceiling Plane
 - Specification Dialog 587
- Ceiling Structure Definition 709
- Ceilings
 - Automatic 614
 - Basement 484
 - Cathedral 298
 - Coffered 299
 - Dropped 294
 - Lowered 297
 - Over this room 304
 - Special 297
 - Tray 298
 - Vaulted 298
- Center
 - Doors 373
 - Object edit tool 169
 - Sheet 948
 - Snapping to 80
 - Text 349
- Chamfer
 - Footings 269
 - Two Lines 175
- Change
 - Door Swings 374
 - Floor/Reference 508
 - Line to arc 520
 - Wall Types for Pony Walls 233
- Check
 - Plots 940, 949
- Chief Architect
 - Viewer 28
- Chimneys 500
- Circle
 - Specification Dialog 213
 - Tools 212
- Circles 212
 - Aligning Centers 170
 - Circle about center 212
 - Draw using center and radius 212
 - Ovals 213
- Clear Terrain 849
- Click Stairs 511
- Close
 - Plans and Views 108
 - Program 45
 - Views 108
- Color
 - Off/On 129
- Colors
 - Selecting 134
- Compatibility
 - with other programs 32
- Components 693
- Compound Raked Walls 256
- Concentric
 - Resizing 139
- Configurations Panel 97
- Connect
 - Electrical 473
 - Walls 238
- Contextual Menus 60
 - In Render views 755
- Contour Lines 860
- Convert
 - CAD Lines to Terrain Data 882
 - CAD Objects 179
 - Polyline 179
 - Special Polylines into Polylines 180
- Copy
 - Floors 506
 - Folders and Library Objects 683
 - Views 933
- Copy Selected Material 715
- Copy/Paste
 - Main Edit Mode 120
 - Sticky Mode 120
- Corner
 - Boards 660
 - Windows 397
- Corner Board
 - Specification Dialog 661
- Countertops
 - Custom 435, 438
 - Edge Profiles 438
 - Edit Custom 438
 - Holes in 435
- Create
 - New Plan Dialog 34
 - Plant Image 893
- Cross Section Lines
 - In Camera Views 758
- Cross Section Slider 756
- Cross Section Views
 - Clipping 745
- Cross Section/Elevation
 - Specification Dialog 765
- Cross Section/Elevation Views 744
- Cross Section/Elevations 741
 - Detailing 745
 - Sent to Layout 929
- Crosshairs 15
 - Aligning with 168
- Crown Molding
 - Cabinets 447
- Current
 - CAD Point 197
 - Floor 508
 - Floor, Delete 506
 - Layout Page 28

- Curved
 - Deck Edge 228
 - Deck Railing 228
 - Stairs 511
 - Walls, Draw 238
- Custom
 - Counterholes 435
 - Countertops 435
 - Countertops, Editing 438
- Custom Backsplash
 - Specification Dialog 466
- Custom Countertop
 - Specification Dialog 463
- Customize
 - Sheet Sizes Dialog 946
 - Toolbars 95
- D**
- Deck 292
 - Designer 228
 - Edges 228
 - Framing 293, 306
 - Planking 306
 - Railing 228
 - Railing Defaults 225
 - Roof Over 292
- Decks 292
- Default
 - Lights 772
 - Wall Heights 264
- Defaults
 - Cabinet 432
 - Camera 737
 - DeckRailing 225
 - Dimension 312
 - Door 366
 - Dormer 558
 - Dynamic 55
 - Electrical 469
 - Fencing 225
 - Floor 281, 502
 - Foundation 482
 - Framing 606, 613
 - General Plan 56
 - Layout 925
 - Material 712
 - Railing 225
 - Reset 56
 - Roofs 557
 - Room 280
 - Settings 54
 - Structural Member Reporting 907
 - Wall 224

- Window 394
- Define Material Dialog 726
- Delete
 - 3D Surface 749
 - Built-in Fixtures and Appliances 693
 - Current Floor 506
 - Current Point 198
 - Floors 506
 - Foundation 490
 - Framing 635
 - Gable Over Opening 591
 - Library Content 684
 - Objects 188
 - Objects, warning before 58
 - Roof Planes 559, 575
 - Temporary Points 197
 - Tools from Toolbars 92
 - Wall Hatching 235
- Details
 - Cross section/elevations 745
- Dialog Number/Angle Style 87
- Dimension
 - Defaults 313
 - Tools 323
- Dimension Defaults 312
 - Dialog 313
- Dimension Line
 - Specification Dialog 334
- Dimensions
 - Angular 176, 324, 334
 - Auto Interior 326
 - Display size 62
 - Editing 328
 - End to end 324
 - Interior 325
 - Locate Objects 315
 - Locating railings 263
 - Move Objects Using 332
 - Moving Labels 328
 - Number Height 335
 - Point to point 325
 - Printing 949
 - Rounding Method 314
 - Tape Measure 325
 - Temporary 325
 - To electrical items 319
 - Wall Layers 258
 - Wall Widths 335
 - Zeroes in 321
- Disconnect Edges 142

- Display
 - 3D Views 747
 - Arc Centers and Ends 194
 - CAD Objects 220
 - Drawing Groups 128
 - Drawing Sheet 947
 - Electrical 474
 - Foundations 487
 - Images 796
 - Line Weights 947
 - Objects 124
 - Options, Layout 925
 - Pointer CAD Coordinates 61
 - Pony Walls in Floor Plan
 - View 233
 - Roof Planes 572
 - Room labels 288
 - Terrain 860
 - Walls, Railings, and Fences 240
- Distributed Object Tab 870
- Distributed Plant Panel 871
- Doll House View 742-743
- Door
 - Casing 373
 - Defaults 366
 - Specification Dialog 378
 - Swing Angle 379
 - Tools 367
 - Trim 373
- Doors
 - Arched 386
 - Bifold Doors 368
 - Casing 383
 - Center 373
 - Change Opening/Hinge Side 375
 - Change Swing Side 375
 - Doorways 367
 - Double-swing 382
 - Frame 385
 - Framing 620
 - Gables Over 590
 - Garage 368
 - Garage, opening direction 376
 - Garage, panels 381
 - Handles 388
 - Hardware 388
 - Hinged Doors 367, 374
 - Hinges 388
 - Ignore Casing when Resizing 58
 - Labels 371
 - Library 369, 379
 - Lites 385
 - Locks 388
 - Opening Indicators 370

- Openings in railings 377
 - Plinth Blocks 383
 - Pocket Doors 368
 - Recessed 377, 382
 - Rough opening 379
 - Size 379
 - Sliding Doors 375
 - Style 379
 - Swing from Center 382
 - Swing, change 374
 - Threshold lines 369
 - Transoms 376
 - Type 379
 - Wrapped Openings 376
- Doorways
 - Adding a Door 369
 - with Railing 377
 - Dormer
 - Defaults 558
 - Specification Dialog 599
 - Dormers 596
 - Auto Dormer 597
 - Auto Floating 596
 - Explode 599
 - Framing 625
 - Gable Over Door/Window 590
 - Manually drawn 597
 - Windows in 598
 - Double
 - Trusses 649
 - Draw
 - Arc About Center 207
 - Circle About Center 212
 - Curved Railing 238
 - Curved wall 238
 - Lines 199
 - Roof Planes 570
 - Drawing Group
 - Edit Tools 128
 - Move to Back 128
 - Move to Front 128
 - Select 129
 - Drawing Groups 128
 - Drawing Sheet
 - Center 948
 - Select 947
 - Show 947
 - Driveways 885
 - DWG
 - File Format 830
- DXF
 - File Format 830
 - DXF/DWG
 - DXF vs. DWG 830
 - Files, Import 2D 832
 - Dynamic
 - Defaults 25, 55
 - Print Preview 947
 - Views 929
- E**
- Earth Data Panel 781
 - Eaves
 - Boxed 602
 - Fascia 624
 - Framing 624
 - Plumb Cut 568
 - Square cut 568
 - Edit
 - Files in Home Designer 58
 - Handles 21
 - Paper Size Dialog 946
 - Preferences 75
 - Edit Area
 - (All Floors) 183
 - (All Floors) Visible 183
 - Polyline as marquee 183
 - Tools 182
 - Visible 183
 - Edit Behaviors 137
 - Alternate 138
 - Concentric 139
 - Default 137
 - Edit Indicators 78
 - Fillet 140
 - Resize 138
 - Edit Handles
 - Same Line Type 202
 - Size 76
 - Tolerance 76
 - Egress Windows 407
 - Electrical
 - Auto Place Outlets 472
 - Connections 473
 - Defaults 469
 - Deleting 476
 - Dimension to 319
 - Displaying 474
 - Editing Objects 475
 - General 468
 - Labels 474
 - Library 474
 - Lights 471
 - Outlets 470
 - Switches 471
 - Tools 470
 - Wiring 473
 - Electrical Service
 - Specification Dialog 476
 - Elevation
 - Data Tools 849
 - Points 850
 - Regions 852
 - Splines 852
 - Tab 867
 - Elevation Data
 - Importing from DXF/DWG 881
 - Tools 849
 - Elevation Line
 - Specification Dialog 866
 - Elevation Point
 - Specification Dialog 865
 - Elevation Region
 - Specification Dialog 866
 - Elevation Views 744
 - Elevations
 - Interior 741
 - Elevations, Wall 744
 - Ellipse 213
 - Specification Dialog 213
 - End
 - Cabinets 449
 - Caps 75
 - To-End Dimensions 324
 - Trusses 654
 - Energy Heel 649
 - Enhanced Metafiles 804
 - Enter
 - Coordinates 201
 - Error Messages 963
 - Estimating Software 918
 - Exit Program 45
 - Expand/Collapse All 674
 - Explode
 - Architectural Blocks 698
 - Dormers 599

- Export
 - 2D Drawings 836
 - 360 Panorama 844
 - 3D Viewer File 828
 - All Floors 836
 - Current View 836
 - Drawing File Dialog 836
 - EMF 805
 - From the Library 686
 - Layout Files 938
 - Materials List 916
 - Picture Files 801
 - Windows Metafiles 805
 - Windows Metafiles Dialog 805
 - WMF 805
- Extend
 - Slope Downward 253
- Extension Lines
 - Adding 330
 - Deleting 331
 - Edit Extensions tool 332
 - Editing 329
- Extension Snaps 113
- Extensions Panel 321
- Exterior
 - Room types 282
 - The Exterior Room 285
 - Walls 230
- Eyedropper
 - Object 187
- F**
- F6 Key
 - Fill Window 107
- Fascia 603
- Fence Designer 230
- Fencing
 - Defaults 225
- Field of View 756
- File
 - Backing Up Your Files 39
 - Create New 34
 - Management 31
 - Open 41
 - Organization 33
 - Recent File List 69
- File Management Preferences 68
- Fill
 - Patterns 130
- Window 107
- Window Building Only 107
- Fill Style Panel 131
- Fillet 140
- Fillet Lines 174
- Filter
 - Library Search 675
 - Library Tree View 684
- Find Object in Plan 915
- Finding Objects 50
- Fire Box Panel 499
- Fireplace
 - Library 499
 - Masonry 496
 - Specification Dialog 497
 - Symbol 499
- Fireplaces 496
 - Chimneys 500
 - Foundations 497
 - Freestanding 497
 - In walls 496
 - Types 496
- Fix
 - Roofs 560
 - Wall Connections 239
- Fix Off Angle Walls 236
- Fixtures
 - Lights 471
- Flare/Curve Stairs 524
- Flat Region 855
 - Specification Dialog 868
- Floating Auto Dormer 596
- Floor
 - 3D Overview 741
 - Build New Floor 503
 - Camera 741
 - Defaults 281, 502
 - Framing 614
 - Heights 293
 - Overview 741
 - Tools 502
 - Trusses 642
- Floor Plan
 - Drawing 25
 - View 26
- Floor Structure Definition 709
- Floor/Ceiling
 - Beam 613
- Floor/Ceiling Truss
 - Specification Dialog 656
- Floors
 - Adding 503
 - Attic 509
 - Change Floor/Reference 508
 - Copying 506
 - Current Floor 508
 - Deleting 506
 - Exchange With Floor Above 505
 - Exchange With Floor Below 505
 - Floor Up/ Floor Down 508
 - FloorTabs 614
 - Insert New Floor 504
 - Maximum number 503
 - Raised 294
 - Reference Floor 509
- Focus on Object 750
- Folders Preferences 69
- Follow Terrain 863
- Font
 - Materials List 64
 - Preferences 64
- Fonts 339
 - and Alphabets 339
- Footings
 - Alignment 251
 - Chamfer 269
 - Editing 489
 - Monolithic Slab 269
 - Size 269
 - Stem wall 251
 - Stepped 255
- Foundation
 - Defaults 482
 - Panel 268
 - Thickness 268
 - Walls 231
- Foundations
 - Alignment 251
 - Build 485
 - Daylight Basement 492
 - Delete 490
 - Display 487
 - Footing size 269
 - Garage 490
 - Mixed Types 486
 - Piers 484
 - Rebar 485

- Slab at top of stem wall 484
- Slab thickness 484
- Slab Tools 493
- Stem Wall 484
- Step markers 483
- Stepped 492
- Types 483
- Use Mesh 485
- Walkout Basement 492
- Framing
 - 3D Overview 743
 - Auto Rebuild 609
 - Automatic 608
 - Barge Rafter 626
 - Beams 622-623
 - Bearing Line 631
 - Blocking Box 217
 - Build Framing Dialog 613
 - Butt Joints 614
 - Ceiling 614
 - Cross Box 217
 - Deck 293, 306
 - Default Fill Style 627
 - Defaults 606
 - Defaults Dialog 613
 - Deleting 635
 - Dimensions to 319
 - Displaying 632
 - Doors 620
 - Dormer Holes 625
 - Editing 634
 - Floor 614
 - Joist Spacing 616
 - Joists 612
 - Keeping current 635
 - Lap Joints 614
 - Lookouts 624
 - Manual vs. Automatic 608
 - Materials List 636
 - Mitered Joints 635
 - Mixing Trusses with Rafters 647
 - Plates 619
 - Platforms 614
 - Posts 623
 - Reference Marker 628
 - Represented by single line 628
 - Rim Joist 614
 - Roof 624
 - Rough Openings 620
 - Sill Plates 607
 - Specification Dialog 637
 - Steel 635-636
 - Structural Member Reporting 907
 - Stud Spacing 619
 - Stud Thickness 619
 - Tools 611
 - Trimmers 621

- Trusses 626
- Types 636
- Wall Blocking 619
- Wall Layer 257
- Walls 618
- Windows 620
- Full
 - Height Cabinets 434
 - Overview 741, 743
- G**
- Gable
 - Gable/Roof Line Tool 590
 - Over Door/Window 590
- Gamepad
 - Enable 99
- Gamepad Settings 99
- Gamepads 750
- Garage
 - Door panels 381
 - Door Tool 368
- Garages
 - Foundation 490
- Garden Bed
 - Distributed Plant Panel 871
 - Kidney Shaped 857
 - Polyline 857
 - Round 857
 - Specification Dialog 871
 - Tools 856
- General
 - Cabinet Defaults 433
 - Framing Tool 611
 - Preferences 66
 - Wall Defaults 223
- Getting Help 28
- Girder Trusses 651
- Glass
 - Stained 398
- GPS
 - Importing 879
- Grade beams 483
- Grayscale
 - On Screen 61
 - Printed 957
- Grid
 - Materials list reports 82
 - Snaps 115

- H**
- Half
 - Walls 274
- Half-Walls 227
- Hardiness Zone Maps 893
- Hardware
 - for Doors 388
- Hatch
 - Fill Patterns 130
 - Wall 235
- Height
 - Basement ceiling 484
 - Railings 276
- Help
 - Tool Tips 28
- Hill / Valley
 - Specification Dialog 868
- Hill/Valley 855
- Hip
 - Truss 648
- Holes
 - In terrain 856
- Home Designer
 - Allow editing in 58
 - Product Key 29
 - Version Number 29
- Hotkeys 98
 - Create List 98
 - Snap Behaviors 113
- House Wizard
 - Editing Rooms 47
 - Multiple Floors 48
 - Placing Rooms 47
- I**
- Image
 - Specification Dialog 797
- Images 771
 - Adding to Library 796
 - Creating 796
 - Displaying 796
 - Editing 797
 - In Schedules 901
 - Place 795
 - Printing 958

Transparency Color 800

Import

2D DXF/DWG Files 832
3D Data 839
3D Symbols 840
Drawing Wizard 832
DXF/DWG Elevation Data 881
GPS Data 879
PDF 807
Terrain Assistant 877
Terrain Data 876

Input

Arc 207
Line 199
Point 196

Insert

Floor Dialog 504

Insulation 218

Interior

Dimension Tool 325
Dimensions, Auto 326
Room types 282

Invisible Walls 233

J

Join Roof Planes 576

Joist

Direction Line 630

Joist Direction

Specification Dialog 630

Joists 612

Bearing Line 631
Blocking 612
Spacing 616
Use Framing Reference 615

K

Key Frames 816

Keyboard

Commands 98, 674

Kidney Shaped

Garden Bed 857
Pond 857
Terrain Features 856

Kingpost 654

Kitchen Island 450

Knee Walls 254, 267

L

Label Panel 363

Labels 362

Cabinet 441
Display size 62
Displaying 363
Door 371
Electrical 474
Plant 896
Roof Plane 572
Room 288
Trusses 647
Window 402

Landing 521

Landings

Height 522

Landscape Designer 846

Layer

Display Options Dialog 126
Layer Sets 127

Layers

Colors 127
Locking 125
Primary and Secondary 124

Layout

CAD 926
Create 926
Cross Section/Elevations 929
Current Page 28
Defaults 925
Editing Views 932
Exporting 938
Files, Opening 41
Floor plan view 930
Links, Managing 936
Missing Files 936
Open View 925, 933
Page Display Options 925
Pictures in 927
Printing 938
Resizing, Non-Scaled Views 933
Resizing, Scaled Views 933
Saving 36
Sending views to 927
Text 926

Layout Box

Labels 932
Specification Dialog 934

Layout Line Scaling 929

Layout Views

Copy 933
Keeping views current 929

Left Mouse Button

Definition 13

Legacy Plans

Text Conversion 64

Legends 341

Library

Adding Folders 682
Bonus Catalogs 677
Content 677
Deleting Content 684
Export 686
Filter Tree View 684
Manage Library Filters
Dialog 685
Manufacturer Libraries 677
Renaming Libraries 683
Search 675
Shortcuts 683
Trash 684

Library Browser 669

Adding Items 681
Docking 674
Panels 669
Preferences 64

Library Object

Specification Dialog 693

Library Objects

and the Materials List 691
Editing 691
Placing 686

Light

Ambient 773
Specification Dialog 777

Light Data Panel 478

Light Sources 772

Added Lights 772
Default Lights 772
Default Sun Light 773
Fixtures 772
Point Lights 774
Spot Lights 774
Sun Angles 778

Lights

Added 772
Adjust 775
Color 479
Cut Off Angle 479
Direction 479

Drop Off Rate 479
Fixtures 471, 772
Floor Number 777
Height 777
Intensity 479
Show Position in 3D 480
Turn On/Off 775
Types of sources 773

Line
Angle Format 193
CAD Drawing Tools 199
Endcaps 75
Length Format 194
Panel 203
Specification Dialog 202
Start and End Points 76
Weight 940, 950
Weight Scaling 951
Weights, Show 61, 947
with Arrow 201

Line Style
Panel 204
Reverse direction 178

Lines
Reverse direction 178

Lites
Craftsman 415
Diamond 415
Doors 385
Normal 415
Prairie 415

Living Area 289
and Room Types 283
Calculation 289
Delete label 289
Label 289
Restore label 289
Show 59
vs. Footprint 289

Loan Calculator 51

Locate
Roof Plane Intersections 577

Lock
Layers 125
Roof planes 575
Tread Depth 523

Lock Toolbars 93

Lookouts 624

M

Main
Edit Mode 120
Layer 257

Make
Parallel Dialog 177
Parallel/Perpendicular 169, 177

Manage
Layout Links 936
Library Filters 685
Materials Lists 916

Manual
Dimensions 324
Roofs 557, 570

Manufacturer Libraries 677

Marker 357
Defaults 338
Editing 359
Framing Reference 628
Specification Dialog 358
Types 358

Marquee Select 143

Marquee Select Similar 144

Masonry
Fireplace 496
Stairs 535

Master List 918
File Location 85
Name of file 84
see also Materials List 84
Update to Master 919

Material
Defaults 712
Eyedropper 714

Material Painter 713
and Walls 715
Blending 715
Modes 714
Using 714

Materials
Add to Library 681
Artwork 723
Blending 721
Calculating amounts 705
Creating 721
Define Material Dialog 726
Editing 719

Mapping 722
On Soffits 705
Panel 716
Patterns 727
Plan Materials Dialog 725
Render properties 732
Stained glass 398
Textures 729, 771
Types 723
Walls 241

Materials List 904
Calculate from All Floors 905
Calculate from Room 905
Categories 81
Columns, editing 912
Display Options Dialog 909
Editing 914
Estimating software 918
Export 916
Font 64
Framing 636
Grid display on reports 82
Library Objects 691
Manage 916
Master List Preferences 84
Preferences 81
Report Style Preferences 82
Restrict to Floor 911
Restrict to Supplier 911
Save 916
Saving 905

Menus 17

Mesh, in Foundations 485

Message Boxes
Reset 23

Metafile Size Dialog 805

Metafiles 804

Middle Mouse Button 14, 106

Mitre Ends of Angle Walls 620

Molding
Profiles, changing 665

Moldings Panel 309, 665

Mouse
3D 14
Pointer Icons 15

Mouse Buttons
Using 13

Move
Along Rails 246

- CAD Points 198
- Camera with Mouse 750
- Folders and Library Objects 683
- Nudging 167
- Object Using Dimensions 332
- Objects 165
- Restrictions 166
 - to be Coplanar 578
 - to Framing Reference 168
 - Walls with Cabinets Attached 446

- Move Point Dialog 198

- Mulled Unit
 - Specification Dialog 404

- Mulled Units
 - Framing 407
 - Labels 364
 - Mullion Depth 407
 - Treat as Door 407

- Mullions
 - Window 413

- Multiple
 - Select 143

- Muntins
 - Window 413

N

- New
 - CAD Arc Dialog 208
 - CAD Line Dialog 200
 - CAD Point Dialog 196
 - Plans Preferences 71
 - Polygon Shaped Room 234

- Newels
 - Definition 512

- Newels/Balusters Panel 276

- Niche 396

- No Locate Wall 263

- North Pointer 778

- Nudging 167

- Number Style/Angle Style
 - Dialog 87

O

- Object
 - Based Design 12

- Object Snaps 113
 - Extension Snaps 113
 - Object locations 113

- Preferences 78

- Off Angle Walls 236

- One-Click Stairs 511

- Open
 - Below 283
 - Layout 41
 - Object 19
 - Plan Files 41
 - Symbol 840
 - View 759

- Openings
 - Dimensions to 319

- Organizing
 - your Files 33

- Orthogonal Views 948

- Outlets 470
 - Above cabinet 470
 - Automatic 472
 - Dishwasher 470
 - Manually placed 470
 - Place 472
 - Sink 470
 - WP 471

- Oval 213
 - Specification Dialog 213

- Overview 9
 - Full 743

P

- Page Setup Dialog 943

- Painting
 - Over Materials 721

- Pan
 - Pan Window Tool 108
 - the Display 107
 - Using the Keyboard 107
 - Using the Mouse 107
 - Using the Scrollbars 108

- Panorama Export 844

- Paragraph Options Dialog 344

- Partition Tool 434

- Pass-Through 396

- Paste 117
 - Hold Position 120
 - Special 121

- Paste Image 117

- Pattern Panel 727

- Patterns
 - Mapping 722

- Patterns and Textures 722

- PDF 807
 - Importing 807
 - Print to 950

- Peninsula Radius Cabinets 449

- Picture File Box
 - Specification Dialog 802

- Picture Files
 - Export 801
 - Import 802
 - Scale 810

- Piers
 - and Pads 493
 - Foundation 484

- Piers and Pads
 - Editing 495

- Pitch
 - Above Wall 252

- Place
 - Gable Over Window(s) 398
 - Images 795
 - Library Object Button 688
 - Library Objects 686
 - Outlets 472

- Plan
 - Create New 34
 - Drawing 25
 - Files, Opening 41
 - General Defaults 56
 - Materials Dialog 725
 - Saving 36
 - Trace 811
 - View 26

- Plan Check 50
 - and room labels 284
 - Dialog 50
 - Hold 51
 - Restart 51

- Plan View
 - New 103

- Plant
 - 2D Symbols 894
 - Chooser Dialog 891
 - Encyclopedia 891
 - Labels 896
 - Tools 890

- Plant Image
 - Create 893
 - Specification Dialog 893
- Plant Shelf 295
- Plinth Blocks 383
- Plot Plan
 - North pointer 778
- Plotters 940
- Point
 - Light 774
 - Markers 197
- Point to Point
 - Dimensions 325
 - Move 167
 - Resize 811
- Pointer
 - Coordinates 23, 61
 - Crosshairs 15
- Polygon
 - Shaped Deck 229
- Polyline
 - Area 215
 - Definition 214
 - Edit Area 183
 - Garden Bed 857
 - Panel 215
 - Specification Dialog 215
- Ponds 857
 - Round 857
- Pony Walls 232
 - Change wall types 233
 - Display 233
- Post 611
 - With Footing 611
- Preferences
 - Appearance Panel 60
 - Architectural Panel 73
 - Behaviors Panel 76
 - CAD Panel 74
 - Colors Panel 62
 - Definition of 55
 - Dialog 59
 - Edit Panel 75
 - File Management Panel 68
 - Folders Panel 69
 - Font Panel 64
 - General Panel 66
 - Global settings 59
 - Library Browser Panel 64
 - Master List Panel 84
 - Materials List Panel 81
 - New Plans Panel 71
 - Render Panel 85
 - Report Style Panel 82
 - Reset preferences 86
 - Snap Properties Panel 78
 - Text Panel 66
 - Unit Conversion Panel 71
- Print 939
 - 3D Views 948
 - Across Multiple Pages 950
 - Center Sheet 948
 - Check Plots 940, 949
 - Clear Printer Info 941, 943
 - Color or Black and White 957
 - Custom Sheet Size 946
 - Dialog 955
 - Dimensions 949
 - Drawing Scale 940
 - Drivers 941
 - Layout 938
 - Line Weights 950
 - Line Weights and Scaling 951
 - Options 942
 - Paper Size 940
 - Perspective Views 948
 - Plotters 940
 - Preview 947
 - Printable Area 948
 - Scale to Fit 948
 - Services 938
 - Sheet Size 940, 946
 - Terminology 940
 - Text 949
 - Tiled 950
 - To File 941
 - to PDF File 950
 - To Scale 948
- Print Image 760
 - Dialog 958
- Print Size Calculator 349
- Printers 940
 - Select Printer 956
- Program Updates
 - Auto Check 67
- Property lines
 - North pointer 778
- Q**
- Quoin
 - Specification Dialog 662
- Quoins 662
- R**
- Radius
 - End Cabinets 449
- Rafters 611
 - Barge 626
 - Bearing Line 631
 - Blocking 612
 - Mixing with Trusses 647
 - Use Framing Reference 624
- Rail Style Panel 274
- Railing
 - Defaults 225
- Railings 227
 - Balusters 274
 - Cable 229
 - Decks 228
 - for Stairs 544
 - Glass 229
 - Half Walls 227
 - in a Doorway 377
 - Locate with dimensions 263
 - Middle Rail 275
 - Newels 277
 - Open 275
 - Openings 377
 - Solid 274
 - Stairs 531, 549
 - Type 274
- Raised / Lowered Region
 - Specification Dialog 869
- Ramp
 - Slope 551
 - Specification Dialog 550
- Rebar
 - In Foundations 485
- Rebuild 561
 - 3D 759
 - Roof Framing 586
 - Roofs 561
 - Walls/Floors/Ceilings 506
- Recent File List 69
- Recessed
 - Doors 377, 382
 - Windows 398, 408
- Rectangular Polyline 217
- Redo 191
- Reduced Gable 654

- Reference
 - Grid 59
- Referenced Plan Files Dialog 937
- Reflect
 - About Object 178
 - Objects 177
- Relative
 - to Current Point, new point 196
- Remove
 - Backdrop 764
- Render
 - Added Lights 772
 - Daytime Ambient 773
 - Interior Ambient 773
 - Light Fixtures 772
 - Light Sources 772
 - Nighttime Ambient 773
 - Preferences 85
 - Status 86
 - Tips 770
- Rendering Techniques 785
 - Defaults 787
 - Options 787
- Replace from Library
 - Button 690
 - Dialog 690
- Report Style Preferences 82
- Reset
 - Defaults 56
 - Message Boxes 23
 - Preferences 86
- Reshape objects 171
- Resize
 - Factor 811
 - House using Dimensions 333
 - Objects 171
 - Point to Point 811
- Restore
 - Toolbars 94
- Restrictions
 - Moving objects 166
- Retain
 - Wall Framing 266
- Retaining Wall 859
- Reverse
 - Plan 103
- Reverse Direction 178

- Rich Text
 - Border Color 345
 - Defaults 338
 - Specification Dialog 342
 - Text Color 343
- Right Button Definition 13
- Rim Joist 614
- Road
 - Specification Dialog 886
- Road Tools 884
- Roads
 - Displaying 885
- Roof 556
 - Automatic 557
 - Baseline Polyline 583
 - Baseline Polyline, Example
 - Using 584
 - Baseline, Angled 581
 - Baselines 570
 - Beams 612
 - Birdsmouth Cut 574
 - Birdsmouth Depth 581
 - Extend Slope Downward 267
 - Full Gable Wall 267
 - Groups 560
 - Over this room 304
 - Panel 266
 - Pitches in Degrees 604
 - Second pitch 267
 - Styles, Automatic 560
 - Tools 558
 - Truss 642
 - Truss Specification Dialog 652
- Roof Baseline
 - Specification Dialog 584
- Roof Beams 704
- Roof Designer 559
- Roof Hole/Skylight
 - Specification Dialog 594
- Roof Plane
 - Labels 572
 - Specification Dialog 578
- Roof Planes 559, 570
 - Aligning 575
 - Area 581
 - Delete 575
 - Display 572
 - Edit 573
 - Intersections, Locate 577
 - Join 576

- Low roof planes 565
- Move to be Coplanar 578
- Roof Truss
 - Specification Dialog 652
- Roofs 556, 561
 - Auto Rebuild 561, 564
 - Auto Roof Return 267
 - Automatic vs. Manual 557
 - Boxed Eaves 602
 - Build Roof Dialog 562
 - Crickets 598
 - Defaults 557
 - Dormers 596
 - Eaves, aligning 577
 - Energy Heel 649
 - Fascia 603
 - Fix Roofs Tool 560
 - Framing 624
 - Gutters 603
 - Heights 579
 - Hip Trusses 648
 - Hole for skylights 593
 - Ignore Top Floor 565
 - Knee walls 254
 - Lock roof planes 565, 575
 - Manual 570
 - Minimum Alcove Size 566
 - Over Alcoves 591
 - Over curved walls 560
 - Overhang 564
 - Pitch 252, 579
 - Plumb Cut Eaves 568
 - Raise off plate 566
 - Retain edits 581
 - Returns 601
 - Roof Group 302
 - Roof Plane 559
 - Show pitch as degrees 580
 - Skylights 593
 - Square Cut Eaves 568
 - Step Down Hip 648
 - Story-and-a-half 254
 - Subgirders 649
 - Trusses 564
 - Vertical Rafter Depth 581
- Room
 - Defaults 280
 - Specification Dialog 300
- Room Label
 - Specification Dialog 290
- Room Labels 288
 - Custom 288
 - Defaults 282
 - Display 288

- Edit 289
- Interior room area 288
- Interior room dimensions 288
- Room area 288
- Standard room area 288
- Rooms
 - Area 288
 - Attic 282
 - Below Stairs 537
 - Editing 286
 - Exterior types 282
 - Flat Ceiling over 304
 - Interior 282
 - Interior area 288
 - Interior dimensions 288
 - Living Area 283
 - Moldings 309
 - Name for PlanCheck 51
 - Open Below 283
 - Polygon Shaped 234
 - Roof over 304
 - Room Definition 280
 - Room Types 282
 - Selecting 284
 - Standard area 288
 - The Exterior Room 285
 - Types 282
- Rotate
 - CAD items 77
 - Jump 77
 - Plan View 103
- Rotate objects 175
- Rough Openings 620
- Round
 - Garden bed 857
 - Pond 857
- S
- Same
 - Height Eaves 565
 - Roof Height at External Wall 565
- Same Line Type edit handles 202
- Sample Plans
 - Download 962
- Save
 - 3D Views 759
 - and Save As 36
 - Layout 36
 - Materials Lists 916
 - Plan 36
 - Thumbnail Image 39

- Scale
 - Picture Files 810
 - Printing to 948
 - Terrain Data 878
 - Text Size 349
 - to Fit 948
- Schedule
 - Specification Dialog 899
- Schedules
 - Images in 901
- Schematics, Wiring 473
- Scissors Trusses 651
- Scrollbars 108
- Seat
 - in Bay Window 423
- Section Views 744
- Segment Angle at Curved Wall 566
- Select
 - Backdrop 764
 - Library Object Dialog 688
 - Marquee 143
 - Material Dialog 717
 - Multiple Objects 143-144
 - Next Object 143
 - Objects button 141
 - Objects in 3D Views 758
 - Room 284
 - Selected Edge 142
 - Similar Objects 141
- Select Color Dialog 134
- Select Drawing Group 129
- Selection Fill Color 63
- Send
 - to Layout Dialog 928
 - Views to layout 927
- Set Angular Dimension Dialog 176, 334
- Set Baseline Height Dialog 578
- Set Chamfer Distance 175
- Set Fillet Radius 175
- Shadows 770
 - Ray Casted 770
 - Sun 780
- Shelf 434
- Shelf Ceiling 295

- Shelf Tool 434
- Shelf/Partition
 - Specification Dialog 462
- Shelves in Cabinets 461
- Shift Key
 - Marquee selection 143
- Shortcut Keys 98
- Show
 - Arc Centers 151
 - Line Weights 61, 947
 - Living Area 59
 - Reference Grid 59
 - Sheet 947
- Shutters 419
- Side Windows 16
- Sidewalk 884
- Sill Plates 607
- Skylights 559, 593
- Slab
 - At top of stem wall 484
 - Foundation 484
 - Monolithic, Footings 269
 - Specification Dialog 494
- Slabs
 - and the Materials List 493
 - Interior Footings 489
 - Slab Tool 493
 - Tools 493
- Sliding Doors 368
- Sloped Soffits 707
- Snap Behaviors 112
 - Angle Snaps 114
 - Extension Snaps 113
 - Grid Snaps 115
 - Hotkeys 113
 - Object locations 113
 - Object Snaps 113
- Snap Properties
 - Preferences 78
- Soffit
 - Defaults 703
 - Specification Dialog 706
- Soffits 434, 703
 - Calculating Materials 705
 - Corner 703
 - Sloped 707

- Special applications 704
- Space Planner
 - Toolbar Configuration 91
- Space Planning 47
- Spacing
 - Joists 616
 - Wall Framing 619
- Specification Dialogs
 - Arc 209
 - Architectural Block 699
 - Bay/Box Window 426
 - Bow Window 426
 - Cabinet 450
 - Cabinet Shelf 461
 - CAD Box 218
 - CAD Circle 213
 - CAD Ellipse 213
 - CAD Oval 213
 - Callout 355
 - Camera 760
 - Ceiling Plane 587
 - Corner Boards 661
 - Cross Section/Elevation 765
 - Custom Backsplash 466
 - Custom Countertop 463
 - Dimension Line 334
 - Door 378
 - Dormer 599
 - Electrical Service 476
 - Elevation Line 866
 - Elevation Point 865
 - Elevation Region 866
 - Fireplace 497
 - Flat Region 868
 - Framing 637
 - Hill / Valley 868
 - Image 797
 - Joist Direction 630
 - Layout Box 934
 - Library Object 693
 - Light 777
 - Line 202
 - Marker 358
 - Plant Image 893
 - Polyline 215
 - Quoins 662
 - Raised/Lowered Region 869
 - Ramp 550
 - Rich Text 342
 - Road 886
 - Roof Baseline 584
 - Roof Hole/Skylight 594
 - Roof Plane 578
 - Room 300
 - Room Label 290

- Schedule 899
- Shelf/Partition 462
- Slab 494
- Soffit 706
- Sprinkler 897
- Stair Landing 553
- Staircase 538
- Sun Angle 781
- Symbol 840
- Terrain 861
- Terrain Break 874
- Terrain Feature 869
- Terrain Path 874
- Wall 262
- Wall Hatch 278
- Window 404
- Splines 219
- Split
 - Level Entries 507
 - Level Floor Plans 507
- Spot Light 774
- Sprinkler
 - Designer 897
 - Specification Dialog 897
 - Tools 897
- Stacked Windows 398
- Stair
 - Landing Specification Dialog 553
 - Sections Move Independently 74
 - Tools 511
- Stair Designer 511
- Stair Landing
 - Specification Dialog 553
- Stair Landings
 - Height 522
- Stair Railing
 - Middle Rail 534
 - Panels 534
 - Partial 533
 - Solid 531
- Stair Treads
 - Automatic 539
 - Depth 540
 - Lock Number 539
 - Lock Tread Depth 539
 - Number 540
 - Overhang 541
 - Thickness 541
- Staircase
 - Specification Dialog 538

- Stairs
 - Align Curved Stairs 170
 - Auto Stairwell 536
 - Balusters 547
 - Change Line/Arc 520
 - Click 511
 - Concrete 534
 - Curved 511, 514
 - Curved Treads 526
 - Deck to ground 515
 - Direction 513
 - Down 515
 - Edit Handles 517
 - Editing 517
 - Flare Radius 525
 - Flared 524
 - Handrails 549
 - Landings 521
 - Large Stringer Base 544
 - Lock Tread Depth 523
 - Make Reach 538
 - Masonry 535
 - Merge Sections 519
 - Newels 547-548
 - Railings 531
 - Reach Next Floor 538
 - Rooms Below 537
 - Section Width 540
 - Stairwell 535
 - Starter Treads 527
 - Straight 511
 - Stringers 541
 - Stringers, steel 535
 - Subsections 523, 538
 - Symmetrically Flared 525
 - Terminology 512
 - Tread Depth 523
 - Treads 538
 - Walk Line 523
 - Winders 529, 540
 - Wrapped 530
- Stairwell
 - Automatic 536
- Startup Options 10
- Static Views 929
- Status Bar 23, 61
 - Angle style 87
- Steel
 - Framing 635
- Stem Walls 484
- Stepped Foundations 492
- Stepping Stones 858

- Stick Framing
 - Mixing with Trusses 647
- Sticky Mode 120
- Story-and-a-half 254
- Straight
 - Deck Edge 228
 - Stairs 511
- Streams 857
- Stretch CAD 184
- Structural Member Reporting 907
- Structural Member Reporting
 - Contrl 907
- Stud
 - Spacing 619
 - Thickness 619
- Subgirders 649
- Sun
 - Shadows 859
- Sun Angle 778
 - Create 779
 - Render Data 782
 - Specification Dialog 781
- Sun Shadows 780
- Swap
 - Views 103
- Switch
 - Three way 473
- Symbol
 - Open Symbol 840
 - Specification Dialog 840
 - Surface Normals 839
 - vs. Native Objects 692
- T**
- Tab Key 143
- Tape Measure 325
- Technical Support
 - Contact 963
 - Error Messages 963
 - Online 963
 - Online Knowledge Base 962
 - Telephone 963
- Temporary
 - CAD Points 195
 - Dimensions 325
 - File Directories 70

- Temporary Dimensions 325
- Terrain
 - and 3D Draw Time 861
 - Auto Rebuild 860
 - Breaks 853
 - Build 860
 - Clear 849
 - Contour Lines 860
 - Contour Smoothing 864
 - Contours Panel 863
 - Displaying 860
 - Editing 861
 - Elevation Data Tools 849
 - Feature Tools 855
 - Flat Region 855
 - Grow All Plants Dialog 890
 - Hill 855
 - Holes 856
 - Modifier Tools 854
 - Specification Dialog 861
 - Sprinkler Tools 897
 - Sun Shadows 859
 - Toolbar Configuration 91, 847
 - Valley 855
 - Wall and Curb Tools 858
- Terrain Break
 - Specification Dialog 874
- Terrain Data
 - Convert CAD Lines to 882
 - Import 876
- Terrain Feature
 - Specification Dialog 869
- Terrain Features
 - Height 869
- Terrain Modeler
 - 3D Views 861
- Terrain Path
 - Specification Dialog 874
- Terrain Perimeter 847
- Text
 - Aligning 349
 - Arrows 352
 - Bullets 345
 - Character Size 339
 - Copy, Cut and Paste 350
 - Creating 341
 - Displaying 341
 - Editing 347
 - Layer 341
 - Layout 926
 - Line Spacing 344
 - Lists 345

- Move 348
- Numbering 345
- Paragraph Options 344
- Printed Size 349
- Printing 949
- Reshape 348
- Resize 348
- Rotate 348
- Scaling 349
- Text Style Defaults Dialog 360
- Text Styles 360
- Texture
 - Filename Conflict Dialog 842
 - Panel 729
- Textures 771
 - Mapping 722
- Thumbnails 39
 - Creating 39
 - Enable 69
 - Size 69
- Tiling Views 104
- Toolbars
 - Add Tools 95
 - Configurations 91, 94
 - Customize 95
 - Delete Tools 92
 - Drop-Down 90
 - Hide 90
 - Lock 93
 - Parent-Child 90
 - Restore 94
- Transform/Replicate Object
 - Dialog 180
- Transom Windows 376
- Transparency
 - Color 800
- Treated
 - Lumber 639
 - Sill Plates 607
- Trim
 - Door 373
 - Window 404
- Trimmers 621
- Truss
 - Envelope 646
- Trusses 564, 626
 - Attic trusses 650
 - Copy 642

- Create 642
- Double 649
- Drop Hip truss 654
- Edit 644
- End truss 654
- Energy Heel 649
- Floor and Ceiling 642
- Force truss rebuild 657
- Force Truss Rebuild 655
- Girder 651
- Hip 648
- Hip jack 648
- Jack 648
- Kingpost 654
- Labels 647
- Laying out 642
- Lock Envelope 655
- Member Depth 653, 656
- Mixing with Rafters 647
- Reduced Gable 654
- Roof 642
- Scissors 651
- Shape, editing 646
- Sloping Flat 652
- Special Snapping 655, 657
- Step Down Hip 648
- Subgirders 649
- Webbing 653, 657

U

- Undo 191
 - Undo Zoom 106
- Unit Conversions 71
- Unrestricted Movement 166
- Updates
 - Auto Check 67
- Use Layout Line Scaling 929

V

- Valley 855
- Vaulted Ceilings 298
- Vents 398
- Video Card
 - Status 86
- Videos
 - View Online Help Videos 962
- Views
 - Static and Dynamic 929
 - Tiling 104
- Virtual Graph Paper 56, 59

- Visual CAD Snaps 56

- Volume
 - Of a Polyline 215

W

- Walk Line 523
- Walkthroughs 815
 - Along a Path 815
 - Codecs 826
 - Create Path 815
 - Key Frames 816
 - Pause Recording 826
 - Playing 817
 - Recording 825
 - Save Frame 826
 - Stop Recording 826

Wall

- Angles 236
- Assemblies 256
- Blocking 619
- Cabinets 434
- Defaults 224
- Elevation 741
- Layer Fill Style 260
- Niche 396
- Specification Dialog 262
- Tools 226
- Type Definitions Dialog 259
- Types Tab 270

- Wall Elevation 744

- Wall Hatch
 - Specification Dialog 278

- Wall Type Definitions Dialog 259

Walls

- Align between floors 250
- Align collinear 250
- and Material Painter 715
- Attic Walls 254
- Compound Raked 256
- Connecting 238
- Curved 238
- Curved, align between floors 251
- Delete hatching 235
- Dimensioning to 258
- Display surfaces only 240
- Drawing 236
- Editing 244
- Exterior and Interior 230
- Fix Connections 239
- Flip layers 236
- Footing size 269
- Foundation 231
- Foundation thickness 268

- Framing 618
- Framing Layer 257
- Full Gable Wall 267
- Grid snapping 237
- Half 274
- Half Walls 227
- Hatching 235
- Heights 246
- Invisible 233
- Knee Wall 267
- Layers 257
- Layers, Resize About 224
- Length 247
- Main Layer 257
- Materials 241
- Move Along Rails 246
- No Locate 263
- No Room Def 263
- Opening with Railing 377
- Openings in 237
- Pony Wall 232
- Raked 255
- Removing Breaks 240
- Resizing Using Dimensions 333
- Retain wall framing 266
- Retaining Wall 859
- Reverse Layers 236
- Roofs over curved 560
- Same Wall Type handles 248
- Show length when editing 224
- Solid Railings 274
- Split 232
- Stepped 255
- Thickness 246
- Wall Coverings 272
- Widths, Dimensioning 335

- Water Features 857

- Watermark 953

- Waterproof Outlets 471

- Webbing
 - Thickness 657

- Winders 529, 540
 - Definition 513

- Window
 - Casing 404
 - Casing, reveal 409
 - Defaults 394
 - Seat 423
 - Specification Dialog 404
 - Trim 404

- Windows
 - Bay and Bow dimensions 422
 - Bay, Box, Bow 422

Bench Seat *423*
Component *395, 423*
Corner *397*
Egress *407*
Framing *620*
Gables Over *590*
Labels *402*
Levels *399*
Library *396*
Match roof *417*
Minimum Separation *394*
Mulled Units *399*
Mullions *413*
Muntins *413*
Opening Indicators *402*
Pass-Through *396*
Recessed *398, 408*
Shape *416*
Shutters *419*
Special Shapes *397*
Stacked *398*
Stained glass material *398*
Standard *395*
Transom *376*
Trapezoid *416*
Treatments *418*
Types *394*
Vents *398*

Windows Metafiles *804*

Wiring Schematics, Creating *473*

Wrapped

Openings *376*

Stairs *530*

Z

Zero

in Dimensions *321*

Zoom *106*

Fill Window *107*

Mouse Wheel *14, 106*

Tools *106*

Undo Zoom *106*