

# Roof Tutorial

The majority of Roof Tutorial describes some common roof styles that can be created using settings in the **Wall Specification** dialog and can be completed independent of the other tutorials. It also explains how to add gables over doors and windows, how to create dormers automatically and manually, and how to create skylights.

The Adding a Roof to the Stucco Beach House section continues where the House Design Tutorial left off and explains how to add a roof to that plan.

For more information about Roof Tools, see “Roofs” on page 373 of the Reference Manual.

In this tutorial you’ll learn about:



- Getting Started with Automatic Roof Styles
- Hip Roofs
- Gable Roofs
- Shed Roofs
- Offset Gable Roofs
- Gambrel Roofs
- Gull Wing Roofs
- Half Hip Roofs
- Mansard Roofs
- Finding the Start of an Upper Pitch
- Roof Style Quick Reference
- Roof Returns
- Adding Gables over Doors and Windows
- Automatic Dormers
- Crickets and Dormer Vents
- Manually Drawn Dormers
- Skylights
- Using the Break Wall Tool to Modify Roofs
- Adding a Roof to the Stucco Beach House
- Troubleshooting Automatic Roof Issues

---



## Getting Started with Automatic Roof Styles

This tutorial uses a simple, rectangular structure to explain how to create common roof styles using roof style directives assigned to the exterior walls.

### *To begin a new plan*

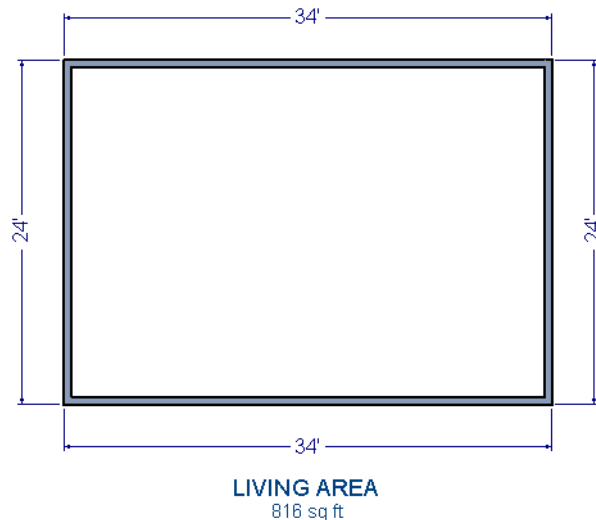
1. If any plans are open, select **File> Close All** from the menu.
2. Select **File> New Plan**  to open a new plan. In the **Create New Plan** dialog, select the Default Style template.
3. Select **Build> Wall> Straight Exterior Wall**  and draw a rectangular floor plan, measuring about 34 feet by 24 feet (approximately 10.4 m by 7.3 m), in a clockwise direction. See “Drawing Walls” on page 200 of the Reference Manual.



4. Select **3D> Create Perspective View> Perspective Full Overview**  to create a 3D overview of the house.
  - If you wish, you can select **3D> Toggle Textures**  from the menu to turn off the display of material textures and represent all materials using solid colors.
5. Select **Window> Tile Vertically**  to see both views at the same time.

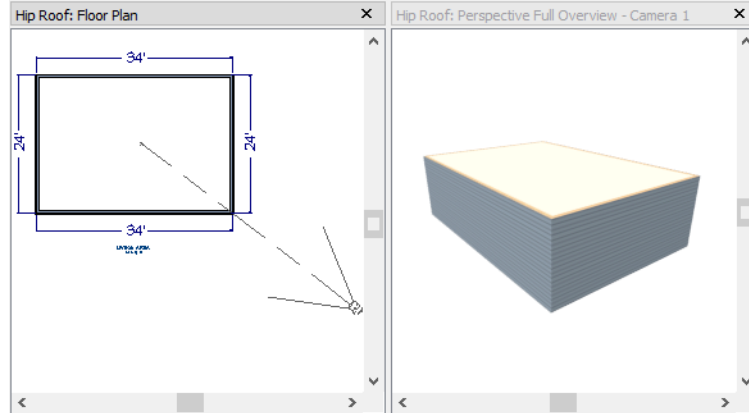



## Roof Style Directives in Walls

By default, the program will generate a roof plane bearing on each exterior wall that does not have a room-defining wall directly above it, and will use the pitch specified in the **Build Roof** dialog. The result is a hip style roof; however, if you need a different condition over a particular wall to produce another roof style, you can define it in that wall's specification dialog.

Individual walls can be selected and edited in both 2D and 3D views. When multiple walls are to be edited, however, it is usually quicker and easier to work in floor plan view: in part, because you can hold down the Shift key and group-select walls. See “Editing Walls” on page 208 of the Reference Manual.

### *To set a wall's roof directives*

1. Click the **Select Objects**  button, then click on a wall to select it.
  - To select multiple walls, hold down the Shift key on the keyboard and click on additional walls to add them to the selection set.
2. Click the **Open Object**  button to open the **Wall Specification** dialog.
3. On the Roof panel:
  - The **Roof Options** control how the roof builds over the selected wall.
  - The **Pitch Options** control how steep the roof that bears on the selected wall is.
  - The **Overhang** setting lets you specify how far the roof above extends past the wall's exterior.
  - The **Auto Roof Return** settings let you specify and customize automatic roof returns.
  - **Lower Wall Type if Split by Butting Roof** lets you create a lower wall type that follows the underside of an adjacent roof plane, if one is present.

The Roof Styles described in this tutorial use only the **Roof** and **Pitch Options**.

*To reset all roof directives*

1. Select **Edit> Reset to Defaults**.
2. In the **Reset to Defaults** dialog, set the Reset Scope to **All Floors**, check **Roof Directives in Walls**, and click **OK**.

## Attic Walls

When a roof is generated, attic walls may also be generated. An Attic wall fills the space between the walls that define a room and the roof above. The triangular-shaped wall of a gable, for example, is created using an Attic wall.



If you do not want to see attic walls in floor plan view, you can turn off their display.

*To turn off the display of attic walls*

1. In floor plan view, select **Tools> Display Options**  (or press the ~ key) to open the **Layer Display Options** dialog.
2. Find "Walls, Attic" in the Name column, remove the check from the Display column for this item, and click OK. For more information, see "Layer Display Options Dialog" on page 114 of the Reference Manual.

## Deleting Roofs

Whether a roof was drawn manually or automatically generated, deleting roof planes is easy:

- Select an individual roof plane and **Delete**  it.
- Select **Build> Roof> Delete Roof Planes**  to delete all roof planes in the plan.
- Select **Edit> Delete Objects**  and in the **Delete Objects** dialog, select either **All Rooms On This Floor** or **All Floors**; place a check beside **Roof Planes**; and click **OK** to delete all roof planes either on the current floor or in the plan.

If a warning message states that roofs cannot be deleted while **Auto Rebuild Roof** is on, click the **Yes** button to turn off **Auto Rebuild Roof** and delete the roof.

## Auto Rebuild Roofs

Auto Rebuild Roofs is a convenient feature in Home Designer Pro that automatically rebuilds the roof in a plan whenever the exterior walls or floor/ceiling heights are changed. Auto Rebuild Roofs is turned off by default, and this tutorial is presented with this feature disabled; however the information presented here also applies when it is enabled.

*To turn on/off Auto Rebuild Roofs*

1. Select **Build> Roof> Build Roof**  from the menu.
2. On the Roof panel of the **Build Roof** dialog, check or uncheck **Auto Rebuild Roofs** and click **OK**.

## Hip Roofs

When roofs are automatically generated, a roof plane is built over every exterior wall in the plan that does not have another wall drawn above it. The result is referred to as a hip roof.

*To create a hip roof*



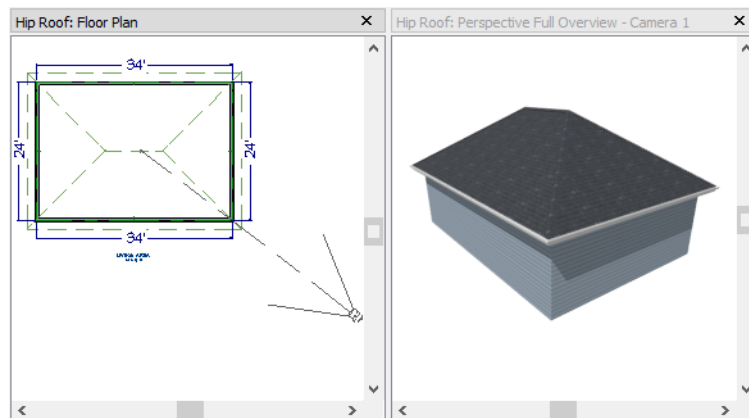

1. Begin with the basic rectangular structure described in “Getting Started with Automatic Roof Styles” on page 2.
2. Select **Build> Roof> Build Roof**  from the menu to open the **Build Roof** dialog.
3. Check **Build Roof Planes** and click **OK** to generate a hip roof.



## Gable Roofs

If you would like a gable over a particular wall rather than a roof plane bearing on it, you can specify it as a **Full Gable Wall** in the **Wall Specification** dialog. To create basic gable roof, two walls should be specified as **Full Gable Wall**.

*To create a gable roof*

1. Begin with the basic rectangular structure described in “Getting Started with Automatic Roof Styles” on page 2.
2. Click the **Select Objects**  tool, select the vertical wall on the left, hold down the Shift key, and select the vertical wall on the right. The two walls should be group-selected.
3. Open the **Wall Specification** dialog and on the Roof panel, check **Full Gable Wall** and click **OK**. See “To set a wall’s roof directives” on page 3.
  - Alternatively, you can click the **Change to Gable Wall(s)**  edit button.
  - To remove the Full Gable Wall attribute from a selected wall, click the **Change to Hip Wall(s)**  edit button.
4. Select **Build> Roof> Build Roof**  to open the **Build Roof** dialog, check **Build Roof Planes**, and click **OK**.

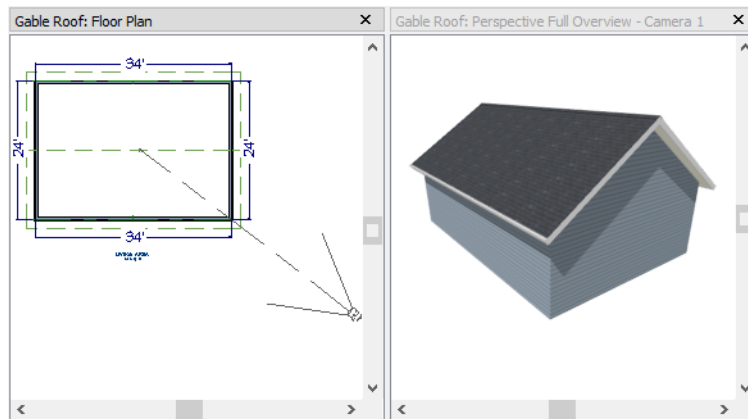

---

## Shed Roofs

To create a single, sloping roof plane, or shed roof, two walls must be specified as **Full Gable Walls**, and one must be a **High Shed/Gable Wall**.

*To create a shed roof*

1. Begin with the basic rectangular structure described in “Getting Started with Automatic Roof Styles” on page 2.
2. As in the Gable Roofs example, specify the left and right vertical walls as **Full Gable Walls**.

3. Select the lower horizontal wall and open its **Wall Specification** dialog. On the Roof panel, check **High Shed/Gable Wall** and click **OK**. See “To set a wall’s roof directives” on page 3.
4. Select **Build> Roof> Build Roof**  to open the **Build Roof** dialog, specify a **Pitch** of 2 in 12, check **Build Roof Planes**, and click **OK**.

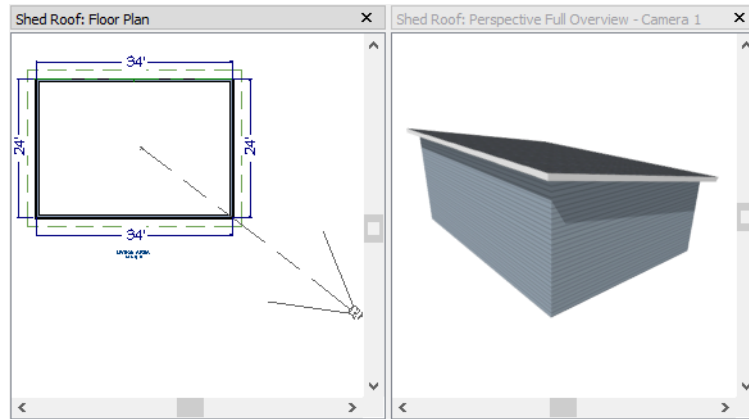



---

## Offset Gable Roofs

An offset gable is a type of gable roof with different pitches on each of the two roof planes and an ridge that is offset from the building’s center line. Assign a different pitch to the two roof planes in the **Wall Specification** dialog for the wall supporting each one.

### *To create an offset gable roof*

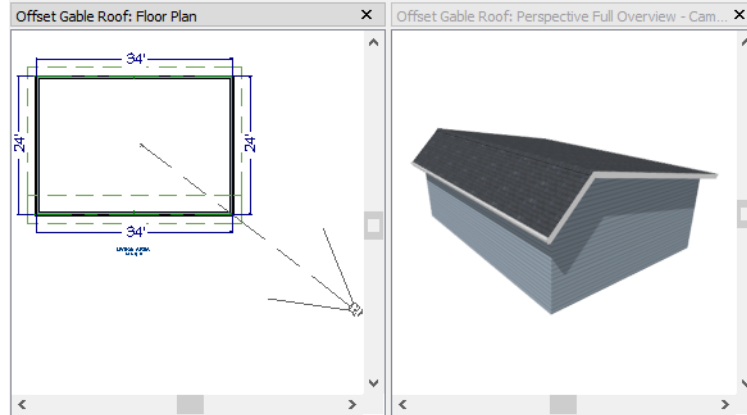
1. Begin with the basic rectangular structure described in “Getting Started with Automatic Roof Styles” on page 2.
2. As in the Gable Roofs example, specify the left and right vertical walls as **Full Gable Walls**.
3. Select the lower horizontal wall and open its **Wall Specification** dialog. On the Roof panel, leave the **Roof Options** unchecked and change the **Pitch** to 12 in 12. See “To set a wall’s roof directives” on page 3.
4. Select **Build> Roof> Build Roof**  to open the **Build Roof** dialog, check **Build Roof Planes**, specify the **Pitch** as 2 in 12, and click **OK**.



---

## Gambrel Roofs

A gambrel or barn style roof has two pitches on each side of the ridge. The first (lower) pitch on either side is steeper than the pitch near the ridge.

### *To create a gambrel roof*

1. Begin with the basic rectangular structure described in “Getting Started with Automatic Roof Styles” on page 2.
2. As in the Gable Roofs example, specify the left and right vertical walls as **Full Gable Walls**.
3. Click the **Select Objects**  tool, select the horizontal wall on the top, hold down the Shift key, and select the horizontal wall on the bottom. The two walls should be group-selected.
4. Open the **Wall Specification** dialog and on the Roof panel, change the following settings:
  - Make sure that the **Pitch** value is followed by (D), which means that is set to use the default.
  - Check the box beside **Upper Pitch**.
  - Specify the **Upper Pitch** as 6 in 12 and the **Start Height** as 156".
  - To learn more, see “Finding the Start of an Upper Pitch” on page 12.
5. Click **OK** to close the **Wall Specification** dialog. See “To set a wall’s roof directives” on page 3.
6. Open the **Build Roof** dialog, check **Build Roof Planes**, specify the **Pitch** as 12 in 12, and click **OK**.



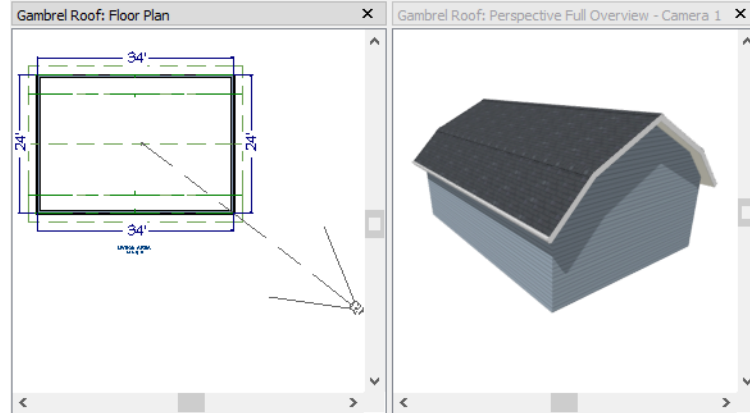

Experiment with alternate pitches and overhangs. Also, try varying the height at which the second pitch begins so that you can see the effect it has on the gambrel roof design.

---

## Gull Wing Roofs

A gull wing roof has two pitches on either side of the ridge, as a gambrel does; but the first pitch of a gull wing is shallower than the steeper upper pitch.

### *To create a gull wing roof*

1. Begin with the basic rectangular structure described in “Getting Started with Automatic Roof Styles” on page 2.
2. As in the Gable Roofs example, specify the left and right vertical walls as **Full Gable Walls**.
3. Click the **Select Objects**  tool, select one of the horizontal walls, hold down the Shift key, and select the other horizontal wall. The two walls should be group-selected.
4. Open the **Wall Specification** dialog and on the Roof panel, and change the following settings:
  - Make sure that the **Pitch** value is followed by (D), which means that is set to use the default.
  - Place a check in the box beside **Upper Pitch**.
  - Keep the **Upper Pitch** as 12 in 12 and change the **Start Height** to 125".
  - To learn more, see “Finding the Start of an Upper Pitch” on page 12.
5. Click **OK** to close the dialog. See “To set a wall’s roof directives” on page 3.

- Click the **Build Roof**  tool, specify a **Pitch** of 3 in 12, check **Build Roof Planes**, and click **OK** in the **Build Roof** dialog.

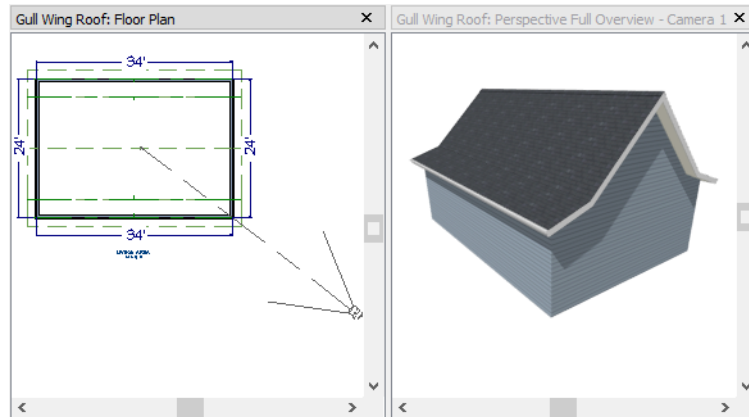

Experiment with the height at which the second pitch begins so that you can see the effect it has on the gull wing roof design.

---

## Half Hip Roofs

A half hip roof has two gable ends. At the top of each gable is a small hip that extends to the ridge.

### *To create a half hip roof*

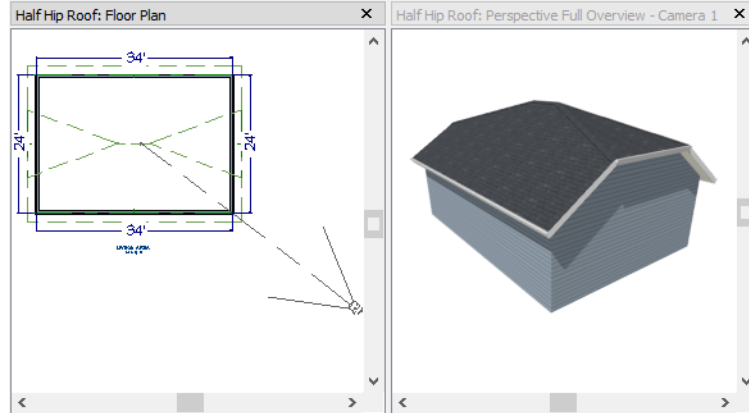

- Begin with the basic rectangular structure described in “Getting Started with Automatic Roof Styles” on page 2.
- As in the Gable Roofs example, specify the left and right vertical walls as **Full Gable Walls**. In addition, change the following **Pitch Option** settings:
  - Check the box beside **Upper Pitch**.
  - Specify the **Upper Pitch** as 3 in 12 and set the **Start Height** at 170”.
- Click the **Build Roof**  tool, check **Build Roof Planes**, and click **OK** in the **Build Roof** dialog.



## Mansard Roofs

A mansard roof is a hip roof with two pitches on the roof sections above each exterior walls: an extremely steep lower pitch and a gently sloping upper pitch.

### *To create a mansard roof*

1. Begin with the basic rectangular structure described in “Getting Started with Automatic Roof Styles” on page 2.
2. Click the **Select Objects**  tool, select one of the exterior walls, hold down the Shift key, and click on the remaining walls to select them as a group.
3. Open the **Wall Specification** dialog and on the Roof panel, and change the following settings:
  - Check the box beside **Upper Pitch**.
  - Specify the **Upper Pitch** as 1.5 in 12 and the **Start Height** as 132".
  - To learn more, see “Finding the Start of an Upper Pitch” on page 12.
4. Click **OK** to close the dialog. See “To set a wall’s roof directives” on page 3.
5. Click the **Build Roof**  tool, specify a **Pitch** of 24 in 12, check **Build Roof Planes**, and click **OK** in the **Build Roof** dialog.

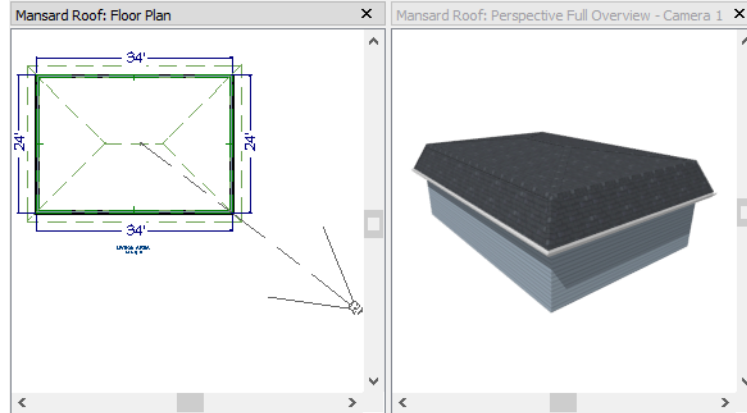



---

## Finding the Start of an Upper Pitch

When creating a roof style with lower and upper pitches, you can determine the exact Starts at Height or In From Baseline values that you need in an elevation view.

### *To find the start of an upper pitch*

1. Generate the roof using only the first, lower pitch. Be sure to define all the roof information for each wall (gable, hip, first pitch, etc.).
2. Create a cross section view that includes the roof plane that will have the second pitch. See “Cross Section/Elevation Views” on page 716.
3. Select **CAD> Points> Place Point** , click to place a temporary point near the location where you want the second pitch to start, and then either:
  - Using the **Point-to-Point Dimension**  tool, drag a dimension line from the floor on Floor 1 (which has a height of 0 by default) to the temporary point.
  - Using the **Point-to-Point Dimension**  tool, drag a dimension line from the baseline to the vertical plane of the temporary point.

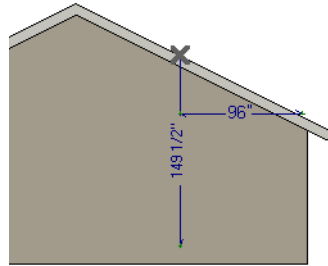

4. Enter either of these values in the **Wall Specification** dialog. You can press the Tab key to update the other value. Click **OK** to close the dialog.

Pitch Options

Pitch  in 12

Upper Pitch

Pitch  in 12

Starts at Height

In from Baseline

5. Open the **Build Roof** dialog, check **Build Roof Planes** and click **OK** to rebuild the roof.

## Roof Style Quick Reference

The following chart provides a quick reference for building the roof styles described in this tutorial. The chart shows which walls to change and what to change on the Roof panel of the **Wall Specification** dialog for each wall. These parameters are based on a 34x24-foot model. For different size plans, adjust these numbers.

Roof Type	Wall to Change	Set as Full Gable	Set as High Shed Gable	Lower Pitch	Upper Pitch	Start Height
Gable Roof	Vertical Wall 1					
	Vertical Wall 2					
	Horizontal Wall 1	X				
	Horizontal Wall 2	X				
Shed Roof	Vertical Wall 1	X				
	Vertical Wall 2	X				
	Horizontal Wall 1		X			
	Horizontal Wall 2					
Offset Gable Roof	Vertical Wall 1	X				
	Vertical Wall 2	X				
	Horizontal Wall 1			12 in 12		
	Horizontal Wall 2			3 in 12		
Gambrel Roof	Vertical Wall 1	X				
	Vertical Wall 2	X				
	Horizontal Wall 1			12 in 12	6 in 12	156
	Horizontal Wall 2			12 in 12	6 in 12	156
Gull Wing Roof	Vertical Wall 1	X				
	Vertical Wall 2	X				
	Horizontal Wall 1			3 in 12	12 in 12	125
	Horizontal Wall 2			3 in 12	12 in 12	125
Half Hip Roof	Vertical Wall 1	X			3 in 12	170
	Vertical Wall 2	X			3 in 12	170
	Horizontal Wall 1			6 in 12		
	Horizontal Wall 2			6 in 12		
Mansard Roof	Vertical Wall 1			12 in 12	1.5 in 12	132
	Vertical Wall 2			12 in 12	1.5 in 12	132
	Horizontal Wall 1			12 in 12	1.5 in 12	132
	Horizontal Wall 2			12 in 12	1.5 in 12	132

## Roof Returns

A roof return is a small decorative roof plane that connects to the low side of a gable roof overhang and extends below the upper triangular portion of the gable wall. While you can build these manually, the following pictures illustrate the three styles of roof returns that can be produced automatically in Home Designer Pro.



The first two are called **Gable** and **Hip** returns, since the returns themselves end in either a gable or a hip. The third is called a **Full** return because it extends under the entire gable, connecting both sides. Full roof returns are sometimes referred to as water tables.

The Auto Roof Return settings are found on the Roof panel of the **Wall Specification** dialog. Roof returns can be specified for any wall, but they will only generate on **Full Gable Walls**.

Auto Roof Return

Length:

Extend:

Roof Type:  Gable  Hip  Full



Slope:  Sloping  Flat

Specify the horizontal **Length** of the returns in inches; the distance to **Extend** the returns past the main roof overhang; the style of roof return; and whether the returns are sloping or flat. As long as your model has a roof, the specified roof returns will be generated when you click **OK**. For more information, see “Roof Returns” on page 420 of the Reference Manual.



## Adding Gables over Doors and Windows

You can add a gable roof over a door or window.



*To create a gable roof over a door or window*

1. Select a door or window, then click the **Gable Over Door/Window**  edit button.
2. Click the **Build Roof**  tool, check **Build Roof Planes**, and click **OK** in the **Build Roof** dialog.
3. A gable is created with an overhang of one foot on each side of the door or window.

*To remove a gable roof over a door or window*

1. Select the door or window and click the **Delete Gable Over Opening**  edit button.
2. Click the **Build Roof**  tool, check **Build Roof Planes**, and click **OK** in the **Build Roof** dialog.
3. When you rebuild the roof, the gable will be removed.



*To create a gable over several doors and/or windows*

1. Select a door, window, or mullied unit.
2. Hold down the Shift key and click on additional doors and/or windows to add them to your selection set.
3. Click the **Gable Over Door/Window**  edit button.
4. Click the **Build Roof**  tool, check **Build Roof Planes**, and click **OK** in the **Build Roof** dialog to create a gable over the selected wall openings.







## Automatic Dormers

The **Auto Dormer**  and the **Auto Floating Dormer**  tools offer a quick and convenient alternative to drawing dormers manually. With just a few clicks an entire dormer is placed, complete with roof, roof hole, walls, and window.

There is a limit to how low the roof pitch can be set when creating dormers. Generally, 9 in 12 is the lowest pitch that will provide enough elevation to contain a dormer.

### Auto Floating Dormer

An **Auto Floating Dormer**  can be placed anywhere within a roof plane, as long as there is enough space to contain it. Floating dormers are sometimes referred to as decorative because they do not tie in with the structure of the building or require support walls.

Select **Build> Roof> Auto Floating Dormer**  and click within an existing roof plane to place a floating dormer at that location. Once a dormer is created, it can be moved, resized and opened for specification. For more information, see “Editing Auto Dormers” on page 416 of the Reference Manual.



An Auto Floating Dormer cannot initially be placed so that its walls align with an exterior wall. Once it is created, its front wall can often be aligned with an exterior wall below; however, its side walls must remain inside the exterior walls.

### Auto Dormer

The **Auto Dormer**  tool places a standard dormer, which has the same space and structural requirements as a manually drawn dormer. If you have not drawn dormers manually, you may benefit from learning how. For information, see “Manually Drawn Dormers” on page 18.

- Dormers can only be placed in roofs that are large and steep enough to contain them. You may need to change the pitch and/or size of a roof plane before an automatic dormer can be placed. If a warning message stating that some walls are outside the roof plane appears when you try to place an automatic dormer, try decreasing the **Height** value in the **Dormer Defaults** dialog.
- A knee wall must be present for the dormer to connect to. A knee wall will create attic space and offer structural support. A wall must be present, but it does not necessarily have to be designated as a **Knee Wall** in the **Wall Specification** dialog.
- Dormers cannot be in conflict with the ceiling on the same floor. If you need to create an open, attic condition, check **Ignore Top Floor** in the **Build Roof** dialog and generate roof planes based on the floor below the dormer. If necessary, you can then use **Raise Off Plate**

in the **Build Roof** dialog to move roof planes up. See “Build Roof Dialog” on page 379 of the Reference Manual.

Once placed in your model, an automatic dormer can be repositioned and its width adjusted using its edit handles. Double-click on an automatic dormer to open the **Dormer Specification** dialog, which looks just like the **Dormer Defaults** dialog but only affects the selected dormer. You can also select the dormer window separately; resize it with its edit handles; and open it for specification. For more information about dormers, see “Dormers and Crickets” on page 414 of the Reference Manual.





---

## Manually Drawn Dormers



To create dormers in an upper floor, create a new floor for your plan and modify this floor with knee walls and windows to form gables. This example starts with a new 40 x 30 foot plan.

As with automatic dormers, roof pitches of 9 in 12 or greater generally work better than shallow pitches when creating dormers because they provide enough vertical space to build the dormer within.

### *To create a new plan*

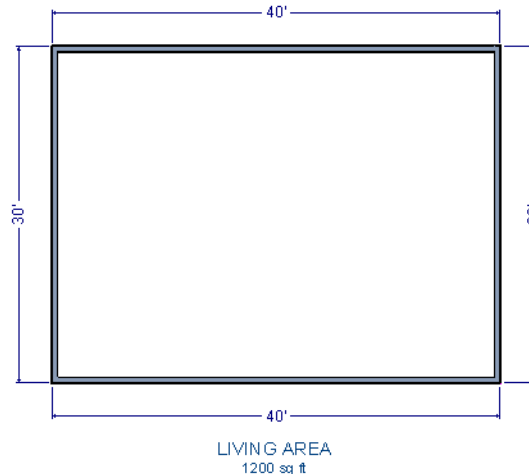
1. Select **File> Close All** from the menu to close any open plans.
2. Select **File> New Plan**  to open a new plan. In the **Create New Plan** dialog, select the Default Style template.
3. Select **File> Save**  from the menu, save the file to an easy to find location, such as Documents, and give the plan a short, descriptive name like Dormer Tutorial.
4. Select **Build> Wall> Straight Exterior Wall**  and draw a rectangular floor plan, 40 feet by 30 feet, in a clockwise direction.
5. Click the **Fill Window Building Only**  button to zoom in on the house.



6. As in the Gable Roofs example, specify the left and right vertical walls as **Full Gable Walls**. See “To set a wall’s roof directives” on page 3.
7. Select **Build> Floor> Build New Floor** .
8. Choose the **Derive new 2nd floor plan from 1st floor plan** option in the **New Floor** dialog and click **OK**. In the Floor 2 Defaults dialog, which opens next, click **OK** without making any changes.
9. Select **Build> Roof> Build Roof**  to open the **Build Roof** dialog. On the Roof panel, check **Build Roof Planes**, change the **Pitch** to 12 in 12, and click **OK**.

### *To create two knee walls*



A knee wall is a short wall on an upper floor that is cut off by a roof plane rather than building up to full ceiling height. They are often used to separate loft areas from attic space.

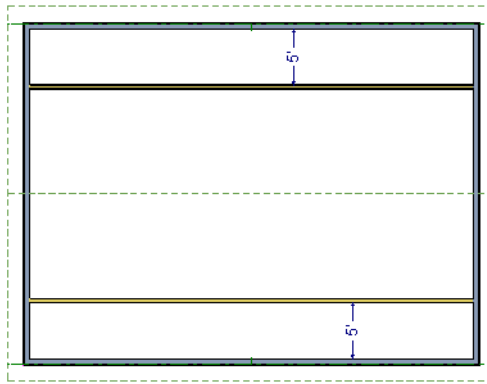

You can create a custom wall type for the knee walls, such as a wall with only a framing layer and one sheetrock layer. See “Wall Type Definitions Dialog” on page 222 of the Reference Manual.

1. Select **Build> Wall> Straight Interior Wall**  and draw a horizontal interior wall from left to right. Position this knee wall so that it is 5 feet from the top exterior wall.
2. Draw another horizontal interior wall and position it 5 feet from the bottom exterior wall. You can reposition the knee walls using dimensions. For more information, see “Moving Objects Using Dimensions” on page 783 of the Reference Manual.



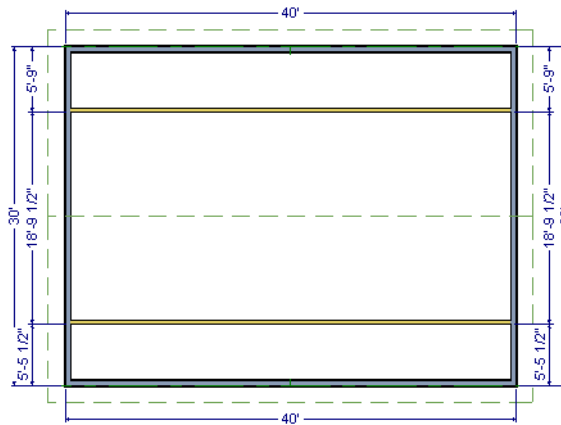

3. Group select both interior walls and click the **Open Object**  edit button. Check the box beside **Knee Wall** on the Roof panel of the **Wall Specification** dialog and click **OK**.
4. Select **CAD> Dimensions> Automatic Exterior Dimensions**  to create exterior dimension lines for your plan, which should now look like this:

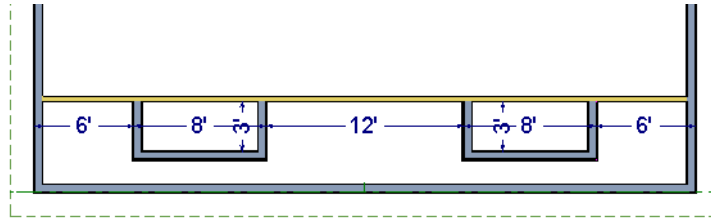

***To draw the dormer walls and windows***

1. Select **Build> Wall> Straight Exterior Wall**  and draw two rectangular boxes on the outside of the lower knee wall, as shown in the following image.



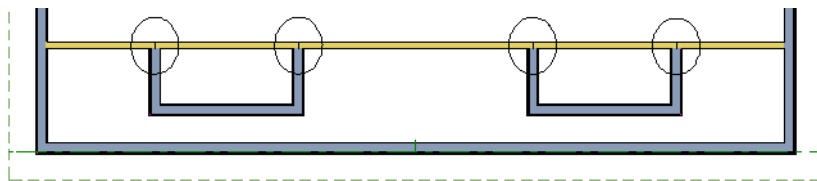

2. Position the front walls of each dormer box 2 feet from the bottom exterior wall. The front dormer walls are those parallel to the bottom wall.
3. Use dimension lines to position the dormer side walls so that the dormers are 6 feet from each vertical exterior wall and 8 feet wide.
4. Select **Build> Wall> Break Wall**  and click along the lower knee wall to place wall breaks where it intersects each of the dormer side walls.



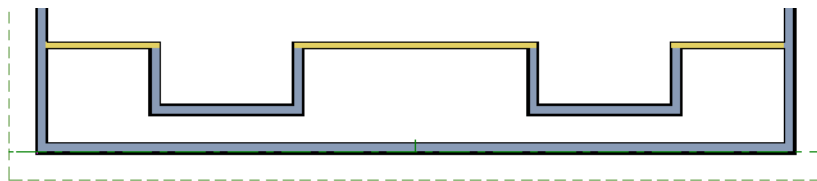

5. Delete the segments of the knee wall located behind the dormers, as in the following image:





6. Select **Build> Window> Window**  and click on each dormer front wall to place a window.
  - When **Midpoint**  **Object Snaps** are enabled, a "sticky point" will exist at the midpoint of the dormer front wall when you move your mouse along the front wall. For more information, see "Object Snaps" on page 120 of the Reference Manual.
  - You can also use the **Center Object**  edit button to center each window along the wall after it has been placed. See "Using Center Object" on page 166 of the Reference Manual.

*To build the roof*

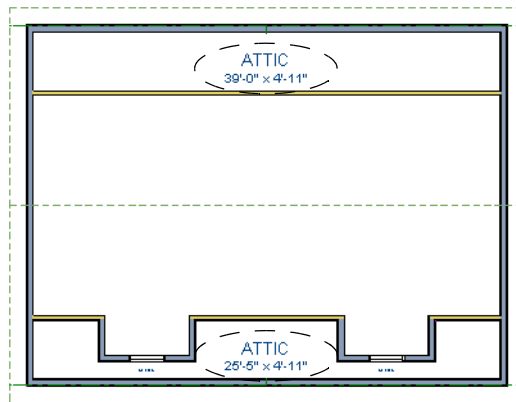
1. Group select the two dormer front walls with windows and open their **Wall Specification** dialog. On the Roof panel, check **Full Gable Wall** and click **OK**.
2. Group select the four dormer side walls and open their **Wall Specification** dialog. On the Roof panel, confirm that **Pitch** is 12 in 12, and click **OK**.
  - Earlier, a pitch of 12 in 12 was specified in the **Build Roof** dialog: that pitch will be in use here by default and will work well for these dormers.
1. Click the **Select Objects**  button, then click in the narrow room between the top knee wall and the top exterior wall to select it.
2. Click the **Open Object**  edit button to open the **Room Specification** dialog. On the General panel, select "Attic" as the **Room Type** and click **OK**.
3. Do the same for the lower attic room.



4. Select **Build> Roof> Build Roof**  from the menu.
5. In the **Build Roof** dialog, check **Build Roof Planes**, and click **OK** to rebuild the roof.
6. Select **3D> Create Perspective View> Perspective Full Overview**  to create a 3D overview of the house and see the results.



7. Notice that there are small gaps in the dormer side walls. This gap is caused by the difference between the position of the knee walls and the point at which the ceiling intersects the roof plane. This location is marked by the black dotted Ceiling Break Line in floor plan view.

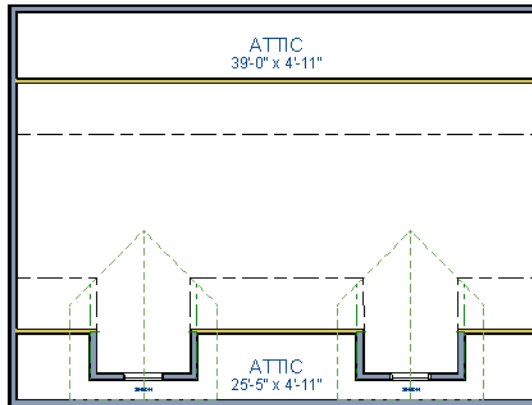

8. Select each of the knee walls and move them back so that they are in alignment with the ceiling plane. When **Object Snaps** are enabled, the walls will snap into position when they are close to the Ceiling Break Lines.

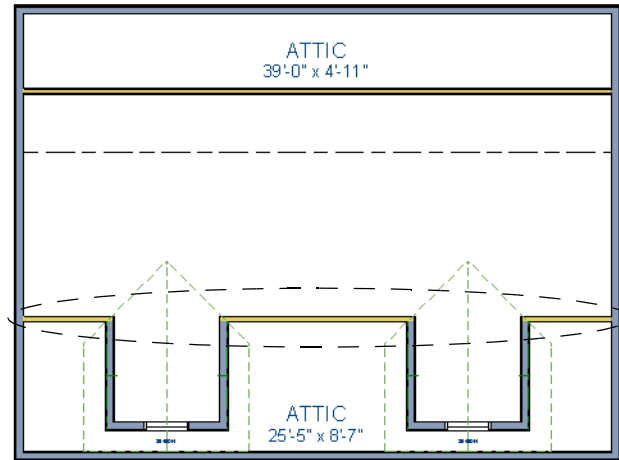

9. Create a 3D view to see how the roof and dormers look now.



You can move the interior walls closer to or further from the outside walls to change the dormers' elevation, or change the pitch for the roof to make the dormers longer. You can create dormers in more complex plans the same way, but you may want to experiment with wall placement and pitch to achieve the desired effect.



## Crickets and Dormer Vents



Roof crickets, sometimes called saddles, are raised roof planes built to divert water or snow. When a roof is generated automatically, crickets will not be produced, but they can be drawn manually using the **Roof Plane**  tool.

Dormer vents can be created using a similar technique.

### *To create a manually drawn chimney cricket*

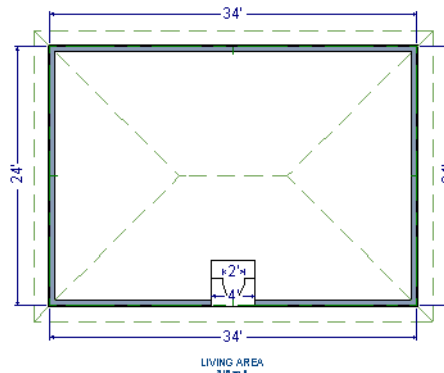
1. Create a basic rectangular structure with a hip roof. See “To create a hip roof” on page 5.
  - In this example, the display of Roof Plane Labels is turned off. See “Roof Plane Labels” on page 389 of the Reference Manual.
2. Select **Build> Fireplace**  and click on one of the exterior walls to place a masonry fireplace at that location in the wall.



- **Midpoint**  Object Snaps or the **Center Objects**  edit tool can be used to center the fireplace along the wall, if desired. See “Using Center Object” on page 166 of the Reference Manual.

3. Make any required changes to the fireplace.

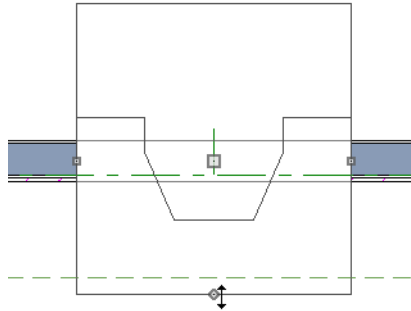

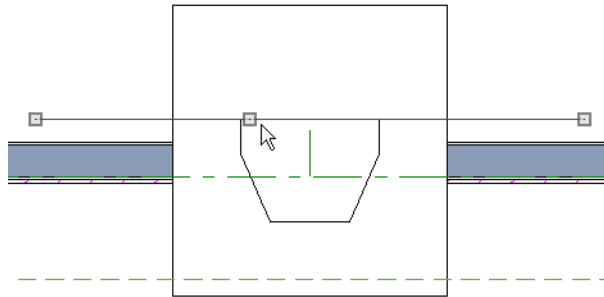

- In this example, the default 48" wide fireplace is used, but its Depth edit handle is used to offset the fireplace 6" towards the exterior. See "Chimneys" on page 370 of the Reference Manual.

4. Select **CAD > Line > Draw Line**  and draw a CAD line along the inside surface of the fireplace's firebox.



- You can also draw the CAD line near the desired location and then move it into place using dimensions. See "Moving Objects Using Dimensions" on page 783 of the Reference Manual.
- Make sure that the CAD line extends past the fireplace in both directions.

5. Select **Build> Roof> Build Roof**  from the menu, and in the **Build Roof** dialog, specify the Pitch, Framing, and any other attributes that you will need for the cricket.
  - In this example, a Pitch of 12:12 and 1 1/2" x 5 1/2" rafters are specified. See “Build Roof Dialog” on page 379 of the Reference Manual.
  - Do not check Build Roof Planes. Here, the **Build Roof** dialog is being used to set the defaults for manually drawn roof planes. See “Roof Defaults” on page 375 of the Reference Manual.
6. Select **Build> Roof> Roof Plane**  from the menu, then:

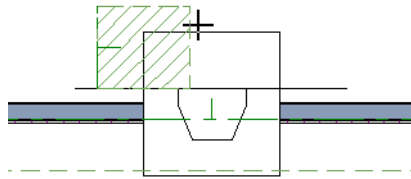

- Click on the CAD line near one of its endpoints and drag to draw a roof baseline perpendicular to the line, towards the structure’s interior.
- Release the mouse button and move the mouse parallel to the CAD line and in the direction of the fireplace’s center and click once.
- The roof plane that is created will draw its height from the top of the roof below at the point where you first clicked to begin drawing.

Note: In this example, the cricket roof plane is assigned an angled fill pattern to make it easier to see.

7. Use dimensions to resize the new roof plane so that it measures half the width of the fireplace from its low edge to its ridge. In this example, that distance is 24".
8. Use Roof Intersection Points to find the intersection point for the edge of the roof plane opposite the fireplace. See “Locating Intersections” on page 392 of the Reference Manual.

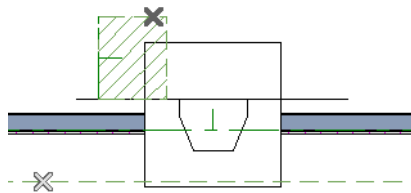

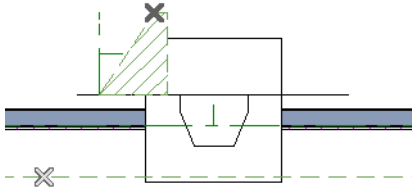

- If the program creates an Intersection Point that is not located on the roof plane edge, move that edge so that it is closer to the fireplace and the roof plane is more narrow and try again..
9. Use the roof plane's edit handles to:
- Angle the low edge of the roof plane up to the Intersection Point.

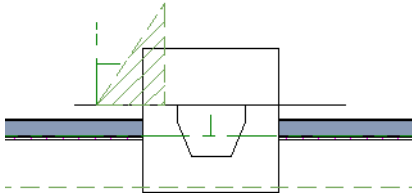

- Drag the short edge of the roof plane outward until it disappears and the roof plane becomes a triangle.



10. Use the **Copy/Paste**  edit tool in combination with the **Reflect About Object**  edit tool to create a copy of the cricket roof plane. See “Reflect About Object” on page 174 of the Reference Manual.

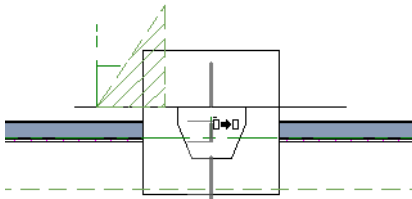

- Copy/reflect the roof plane about the fireplace to produce a roof plane that slopes in the opposite direction as the original.

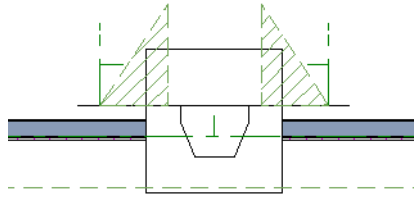

11. Use the **Point to Point Move**  edit tool to move the new roof plane so that its ridge edge is adjacent to the original roof plane's ridge. See "Point to Point Move" on page 164 of the Reference Manual.

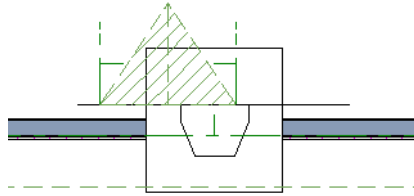

12. Center the cricket behind the fireplace:
- Shift+select the two cricket roof planes.
  - Click the **Center Objects**  edit button.

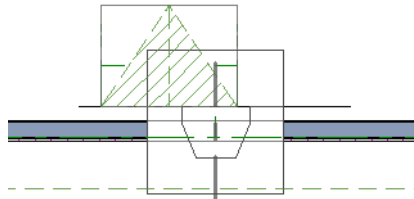

- Move the mouse pointer over the fireplace. When a center axis displays over the fireplace, click once.

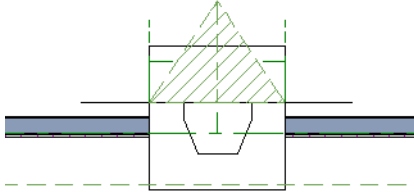





13. Create a 3D view to see the results.





Remember to restore the settings in the Build Roof dialog if you intend to draw more structural roof planes in your plan.

The cricket created above can easily be converted into a dormer vent. Begin by closing the 3D view and returning to floor plan view.

***To create a dormer vent***

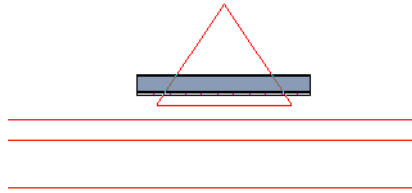
1. Select the fireplace positioned in front of the cricket and click the **Delete**  button.
2. Go **Up One Floor**  and select **Tools > Reference Floors > Reference Floor Display** .
3. Select **Build > Wall > Exterior Wall**  and draw a wall inside the area of the roof cricket on the floor below, parallel to its front.





- If you draw the wall in the wrong direction and its siding layer faces the interior, select it and click the **Reverse Layers**  edit button.
4. Click on the wall to select it and click the **Open Object**  edit button. On the Roof panel of the **Wall Specification** dialog, check the box beside **Roof Cuts Wall at Bottom** and click **OK**. See “Roof Panel” on page 230.
  5. With the wall still selected, use its edit handles to move it the desired distance from the eaves of the roof cricket.
  6. Create a 3D view to see the results.



A selection of attic vents is available in the Library Browser. See “Vents” on page 303 of the Reference Manual.

---

## Skylights

Skylights can easily be added using the **Skylight**  tool. In floor plan view, select **Build> Roof> Skylight**  then click and drag a rectangular shape within an existing roof plane. When you release the mouse button, a skylight is created and can be repositioned and resized using its edit handles. For more information, see “Skylights and Roof Holes” on page 411 of the Reference Manual.

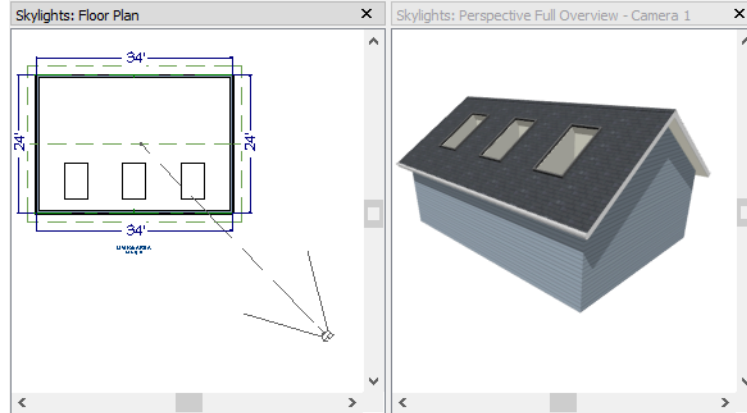

---

## Using the Break Wall Tool to Modify Roofs

Many homes have more than one roof type built above a single exterior wall. One common example is a reverse gable roof, created when a house has gable walls that are perpendicular to one another, as in an L-shaped home.

We can create a reverse gable roof on an L-shaped home using the **Break Wall**  tool.

### *To create an L-shaped home*

1. Select **File> Close All** from the menu.
2. Select **File> New Plan**  to open a new plan. In the **Create New Plan** dialog, select the Default Style template.
3. Draw an L-shaped house with the following dimensions:
  - Left wall - 30 feet long
  - Upper wall - 45 feet long.
  - Right wall 18 feet long.
  - Lower wall extending left from the right wall - 25 feet long.
  - Vertical wall connecting two lower walls - 12 feet long.
  - Lower wall extending right from the left wall - 20 feet long.
4. If desired, turn off **Auto Rebuild Roof** and delete the roof.



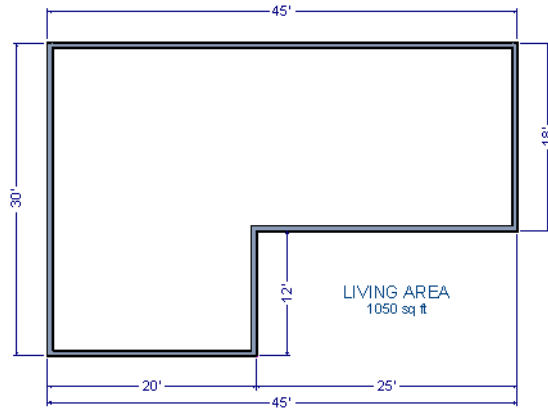

To create a reverse gable in this plan, three gable walls are required: two running vertically and one horizontally.

**To add a gable roof to the plan**

1. Check **Full Gable Wall** on the Roof panel of the **Wall Specification** dialog for these three walls:
  - The far left vertical wall
  - The far right vertical wall
  - The bottom left horizontal wall
2. Click the **Build Roof**  button to open the **Build Roof** dialog, check **Build Roof Planes**, and click **OK** to build the roof. The roof will look like this:

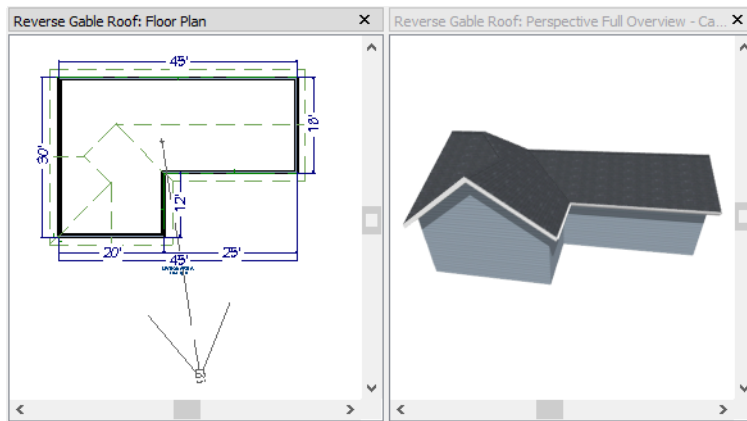

The gable wall on the left produces roof planes that extend too high and interfere with the roof over the front extension of the house. To avoid this, use the Break Wall tool to divide the left wall into two different sections. The upper section can then be specified as a Full Gable without affecting the lower section.

***To use the Break Wall tool***

1. Select **Build> Wall> Break Wall**  and click the far left wall at a point even with the lower right wall.

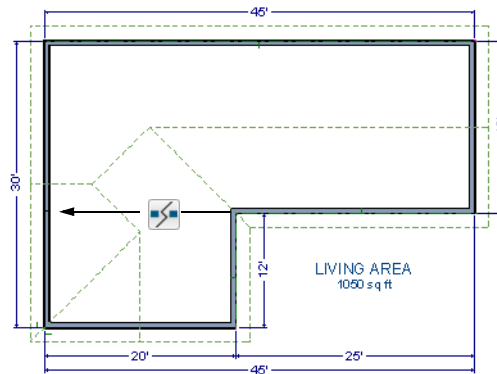

2. Open the lower portion of the wall for specification and on the Roof panel of the **Wall Specification** dialog, clear the **Full Gable Wall** checkbox and click **OK**.
3. Click the **Build Roof**  button, check **Build Roof Planes**, and click **OK** to build a roof based on the new wall specifications.

You now have two full gable roof sections meeting to form your L-shaped roof. Your plan should look like the following image:

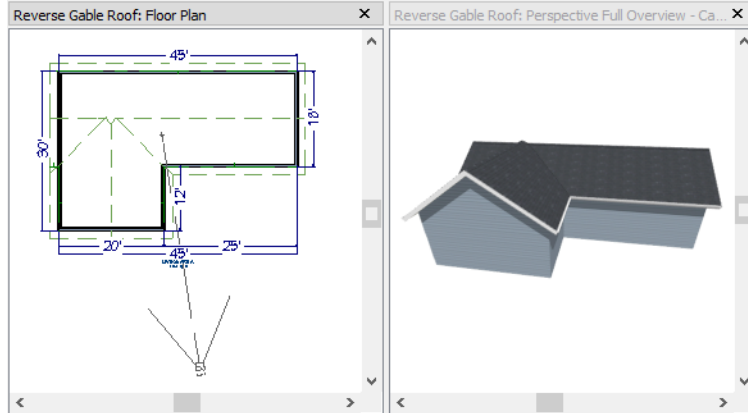

Notice the step in the ridge line. This can be corrected by resizing the lower gable wall. Select the vertical wall to the right of the bottom gable wall and move it to the left 2 feet, reducing the length of the gable wall from 20 to 18 feet. When you are finished, rebuild the roof.

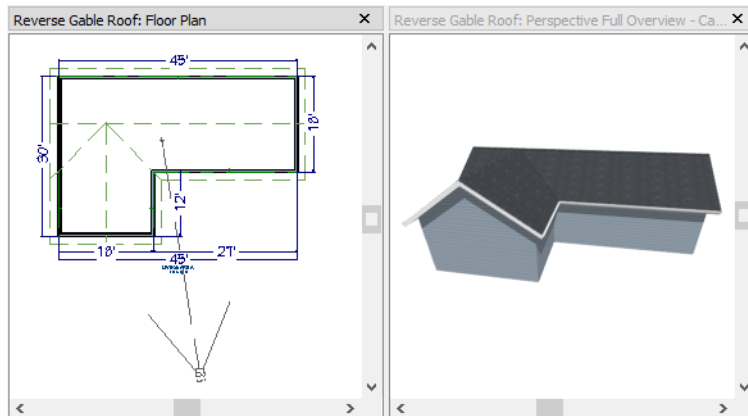

This completes this Roof Tutorial. You can use any combination of the techniques described here to create a wide variety of roof designs.

---

## Adding a Roof to the Stucco Beach House





With a basic understanding of how automatically generated roofs work, you can return to the Stucco Beach House plan and add a roof. Select **File> Save As**  and give this plan a new name, such as "Beach House Roof Tutorial" before continuing.

Individual walls can be selected and edited in both 2D and 3D views; however, when multiple walls must be edited, it is usually quicker and easier to work in floor plan view: in part, because you can hold down the Shift key and group-select walls. See “Editing Walls” on page 208 of the Reference Manual.

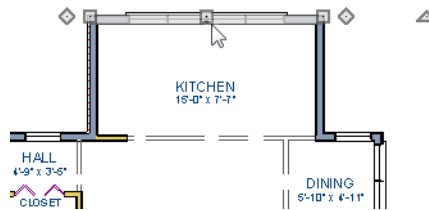
***To edit the default roof***

1. Close any 3D views that you may have open and work in floor plan view.
2. Starting on Floor 1, use the **Select Objects**  tool to select the top horizontal exterior Kitchen wall:



3. Click the **Open Object**  edit button and specify this wall as a **Full Gable Wall**. See “Gable Roofs” on page 5.
4. Click **Up One Floor**  to go to the second floor.
5. Using the **Select Objects**  tool, select the Balcony room, then click the **Open Object**  edit button. On the Structure panel of the **Room Specification** dialog, uncheck **Roof Over This Room**, then click **OK**.

- Assign the **Full Gable Wall** and **Extend Slope Downward** settings to the exterior walls, as shown in the following image. See “To set a wall’s roof directives” on page 3.

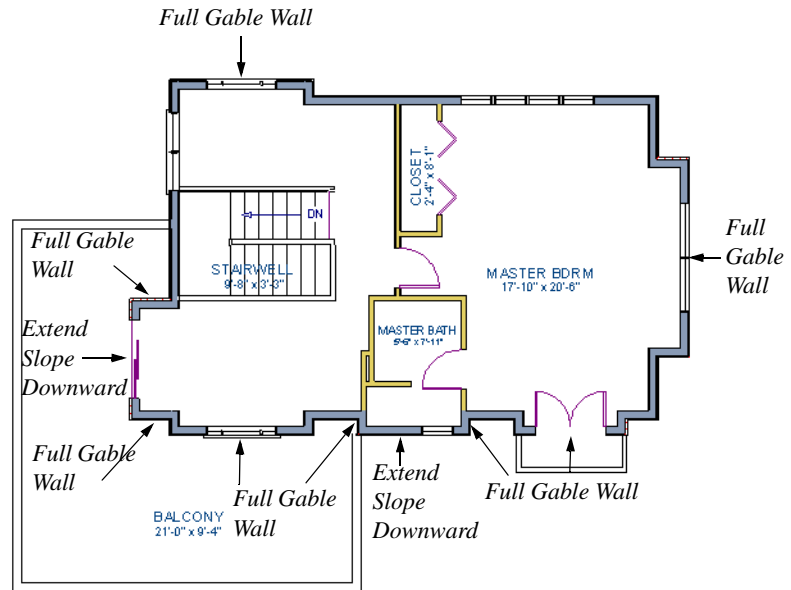

- Once these roof directives have been assigned, the roof can be generated.

**To turn on automatic roof generation**

- Select **Build> Roof> Build Roof**  to open the **Build Roof** dialog.
- On the Roof panel, check **Auto Rebuild Roofs and Build Roof Planes**. See “Build Roof Dialog” on page 379 of the Reference Manual for more information.
- Set the **Pitch** to 3 in 12.
- You can go to the **Materials** panel to change the material of your roof. Here, an Earth Roof Tile material.
- Click **OK** to close the dialog and generate a roof.

The additional walls that are created are attic walls. See “Attic Walls” on page 4.

6. Select **3D> Create Perspective View> Perspective Full Overview**  to create an exterior view of your plan.

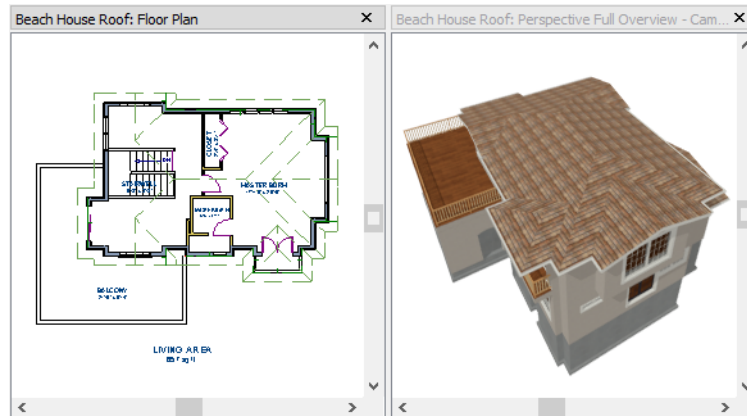

7. Remember to **Save**  your plan as you work.

When you are ready, you can continue working on this plan in the Interior Design Tutorial.

---

## Troubleshooting Automatic Roof Issues

Creating a roof automatically can require experimentation and practice. Here are some suggestions for troubleshooting a problematic roof design.

Bear in mind that some complicated roof plans can only be produced by manually drawing and/or edited roof planes. See “Automatic vs. Manual Roofs” on page 374 of the Reference Manual.

### Roof Directives in Walls

As discussed in this chapter and in the Roofs chapter of the Home Designer Pro 2016 Reference Manual, the program will automatically generate a roof plane bearing over each exterior wall in a plan to produce a hip roof. If you require a different condition over a particular wall, such as a triangular gable or side wall of a shed roof, you can specify that condition on the Roof panel of the **Wall Specification** dialog. See “Roof Panel” on page 230 of the Reference Manual.

Specifying roof directives that do not reflect what you require directly above a selected wall, however, can often result in drastic and unwanted changes to your roof. For example, when two parallel walls are specified as Full Gable Walls, a single ridge will be created between them.

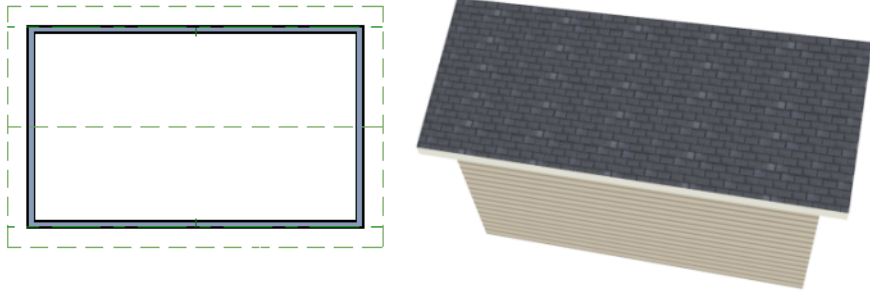

If a wall that is perpendicular to these walls is also specified as a Full Gable Wall, the roof becomes more complex with an additional ridge, two valleys, and two hips.

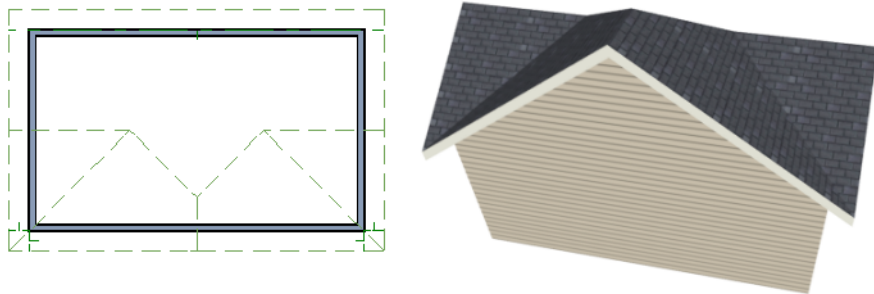

If you are seeing hips or valleys in your roof where you do not expect them, revisit the Roof panel of the walls supporting the affected roof planes.

To review how to restore wall directives back to their default state, see “To reset all roof directives” on page 4.

## Roof Heights

The heights of all automatically generated roof planes are based on the heights of the walls that they bear on. Wall heights, in turn, are determined by the ceiling heights of the rooms that they define. See “Floor and Ceiling Heights” on page 252 of the Reference Manual.

For example, the hip roof over a simple rectangular structure with a consistent ceiling heights (in this case, 109 1/8") has four roof planes.

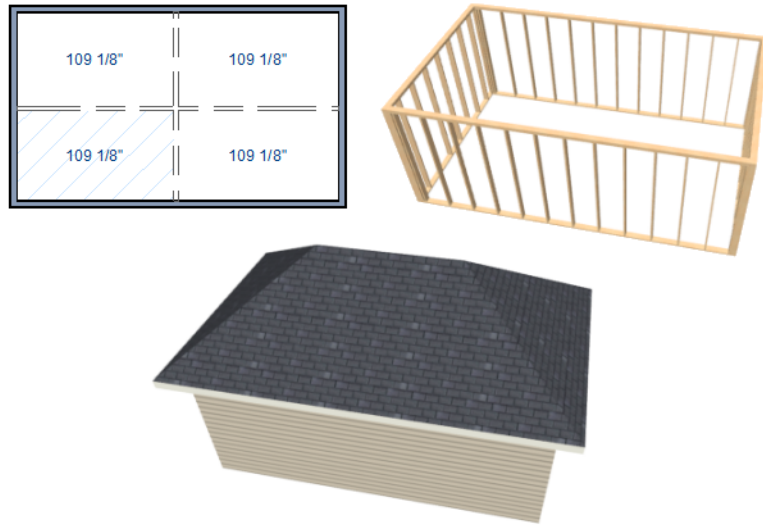

This roof will become considerably more complex if one room inside is given a lowered ceiling height (in this case,  $97\frac{1}{8}$ " ).

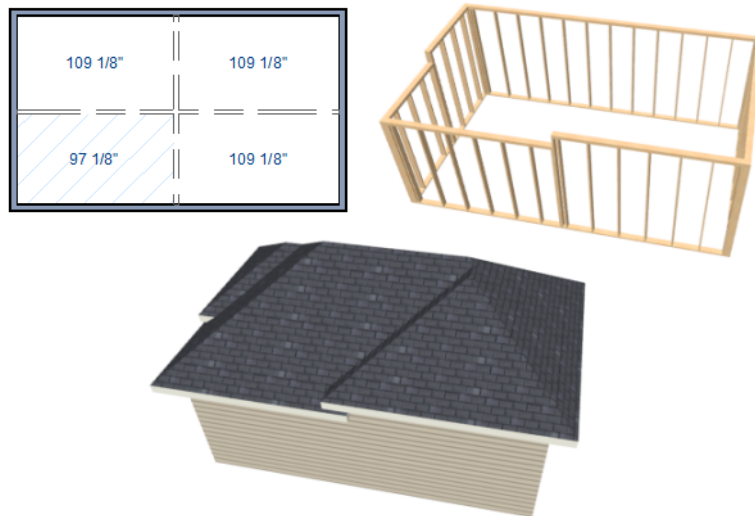

If you generate a roof and it seems to be more complicated and has more roof planes than it should, take a look at the ceiling heights of the rooms in the plan. Often, the correct way to



create a lowered ceiling condition will be to set the ceiling at the default height create a lowered Ceiling Finish. See “Lowered Ceilings” on page 258 of the Reference Manual.

## Controlling Roof Ridges

A single roof ridge will generate for as long as the bearing walls that support the roofs on either side of the ridge are the same distance apart. When alcoves or bump outs are introduced along either bearing wall, the ridge is likely to become broken.

For example, a simple rectangular structure with Full Gable Walls at each end generates a roof with a ridge that runs from Full Gable Wall to Full Gable Wall.

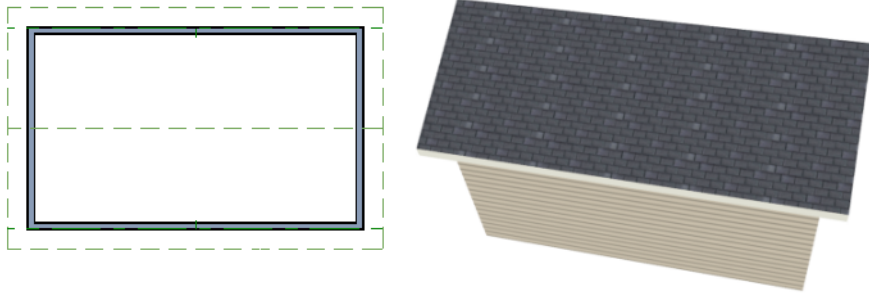

If a bump out is added that affects the length of either Full Gable Wall, or if an alcove is added anywhere along the length of the structure, the ridge will no longer follow a straight line.

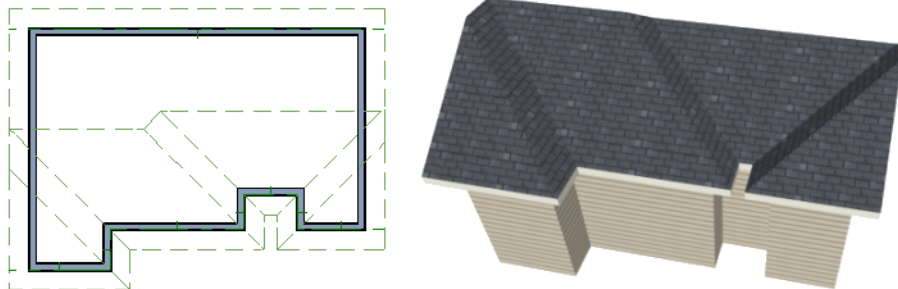

There are a number of ways to maintain a single ridge line in the presence of alcoves or bump outs:

- Use the **Break Wall**  tool to control the length of a Full Gable Wall section. See “Using the Break Wall Tool to Modify Roofs” on page 32.

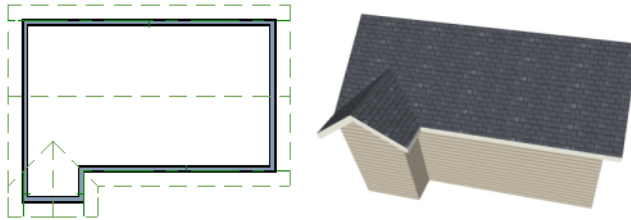

- Increase the **Minimum Alcove Size** to specify what size alcoves are roofed. See “Roof Panel” on page 381 of the Reference Manual.

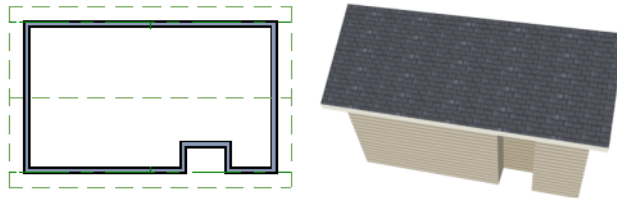

- Use the **Extend Slope Downward** roof directive to allow the roof over a bump out to extend lower than the ceiling height in that area. See “Roof Directives in Walls” on page 215 of the Reference Manual.

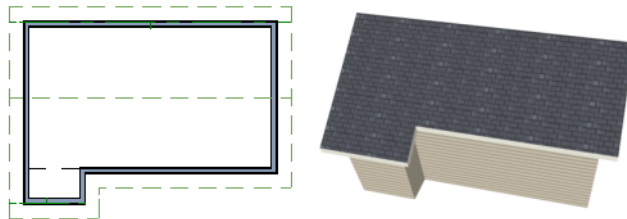

- Specify the area inside of an alcove as an "Open Below" room with a roof but no ceiling, and **Use Soffit Surface for Ceiling** specified. See “Room Types” on page 247 and “Structure Panel” on page 262 of the Reference Manual.

