

Roof Tutorial

The first portion of this tutorial can be completed independent of the previous tutorials. We'll go over some common roof styles that can be created using settings in the **Wall Specification** dialog. We'll also learn how to add gables over doors and windows and how to create skylights. For additional information about using the Roof Tools, see "Roofs" on page 179 of the Reference Manual.



In this tutorial you'll learn about:

- Getting Started with Roofs
- Deleting Roofs
- Auto Rebuild Roofs
- Hip Roofs
- Gable Roofs
- Shed Roofs
- Saltbox Roofs
- Gambrel Roofs
- Gull Wing Roofs
- Half Hip Roofs
- Mansard Roofs
- Roof Type Quick Reference
- Adding Gables over Doors and Windows
- Creating Dormers
- Skylights
- Using the Break Wall Tool to Modify Roofs
- Troubleshooting Roof Issues

Getting Started with Roofs

To gain a basic understanding of roofs and how they function with Home Designer Landscape and Deck, we'll begin this section of the tutorial with a new plan.

To begin a new plan

1. If any plans are open, select **File> Close All** from the menu.
2. Select **File> New Plan**  to open a new plan. In the **Create New Plan** dialog, select the Default Style template.
3. Select **Build> Wall> Straight Wall**  and draw a rectangular floor plan, measuring about 34 feet by 24 feet (approximately 10.4 m by 7.3 m), in a clockwise direction. We'll use this outline to build a number of different roof styles. See "Drawing Walls" on page 99.

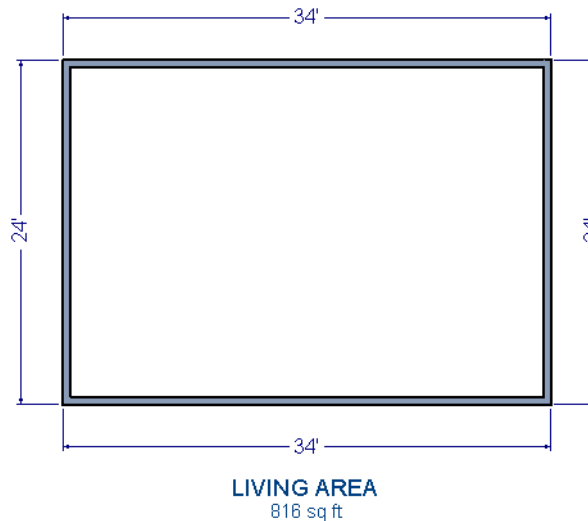

Auto Rebuild Roofs

Auto Rebuild Roofs is a convenient feature in Home Designer Landscape and Deck that automatically rebuilds the roof in a plan whenever the exterior walls or floor/ceiling heights are changed. Auto Rebuild Roofs is turned on by default, but this tutorial is presented with this feature disabled; however the information presented here also applies when it is enabled.

To turn on/off Auto Rebuild Roofs

1. Select **Build> Roof> Build Roof**  from the menu.
2. In the **Build Roof** dialog, check/uncheck **Auto Rebuild Roofs** and click **OK**.

Deleting Roofs

Roof planes can be easily deleted in either of two ways.

To delete a roof

1. Select **Build> Roof> Delete Roof** .
 - Select **Edit> Delete Objects**  and in the **Delete Objects** dialog, select **All Rooms On This Floor**; place a check beside **Roof**; and click **OK**.

If a warning message states that roofs cannot be deleted while **Auto Rebuild Roof** is on, click the **Yes** button to turn off **Auto Rebuild Roof** and delete the roof.



Hip Roofs

When roofs are automatically generated, the default roof type is a hip roof, which means that a roof plane is built over every exterior wall in the plan that does not have another wall drawn above it.

To create a hip roof

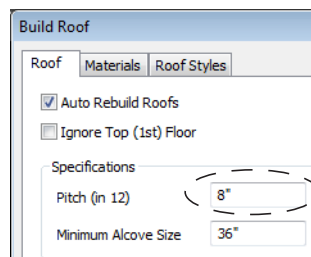
1. Select **Build> Roof> Build Roof**  from the menu to open the **Build Roof** dialog. The **Pitch** is set at 8 in 12 inches.



2. Click **OK** to generate a hip roof.
3. Select **3D> Create > Overview**  to create a 3D overview of the house. If you wish, you can select **3D> Toggle Textures**  from the menu to turn off the display of textures.
4. Select **Window> Tile Vertically**  to see both views at the same time.

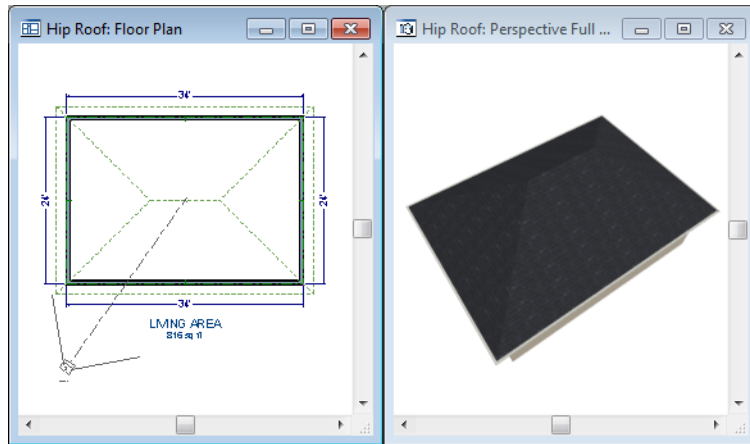



Gable Roofs



If you would like a gable over a particular wall rather than a roof plane bearing on it, you can specify it as a **Full Gable Wall** in the **Wall Specification** dialog.

To create a gable over a wall, specify it as a **Full Gable Wall**. To create basic gable roof, two walls must be specified as such.

To create a gable roof

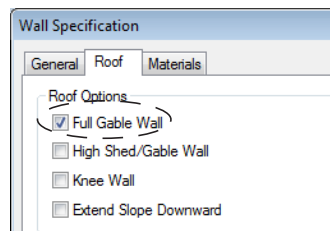
1. Click on the floor plan view window to make it the active view.
2. Select **Build > Roof > Delete Roof** .
3. Use the **Select Objects**  tool to select one of the walls drawn vertically on screen.
4. Click the **Open Object**  edit button and on the Roof tab of the **Wall Specification** dialog, check **Full Gable Wall** and click OK.



- Alternatively, you can click the **Change to Gable Wall(s)**  edit button.
 - To remove the Full Gable Wall attribute from a wall, you can select it and click the **Change to Hip Wall(s)**  edit button.
5. Modify the other vertically-drawn wall in the same manner.
 6. Select **Build> Roof> Build Roof**  to open the **Build Roof** dialog and click **OK**.

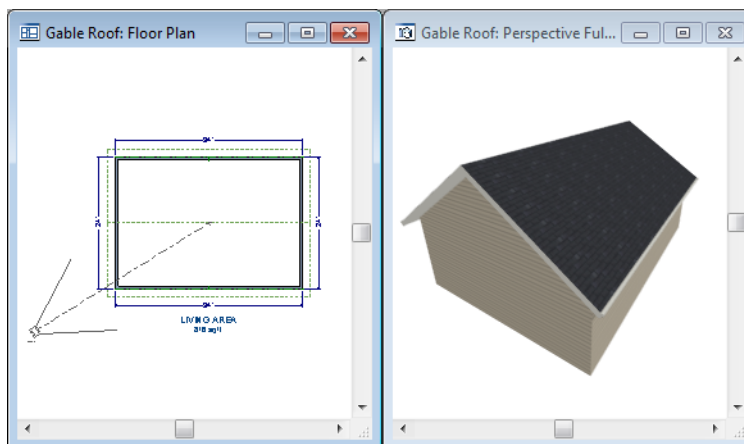

Attic Walls

When a roof is generated, attic walls are also generated. An attic wall fills the space between the first floor walls and angled roof planes above. To see this in floor plan view, take a look at the second floor.

If you do not want to see attic walls in floor plan view, you turn off their display.



To turn off the display of attic walls

1. In floor plan view, select **Tools> Display Settings> Display Options**  (or press the ~ key) to open the **Display Options** dialog.
2. Find Walls, Attic in the Name column, remove the check from the Disp column for this item, and click OK. For more information, see “Display Options Dialog” on page 57 of the Reference Manual.

Shed Roofs

To create a single, sloping roof plane, or shed roof, two walls must be specified as **Full Gable Walls**, and one must be a **High Shed/Gable Wall**.

To create a shed roof

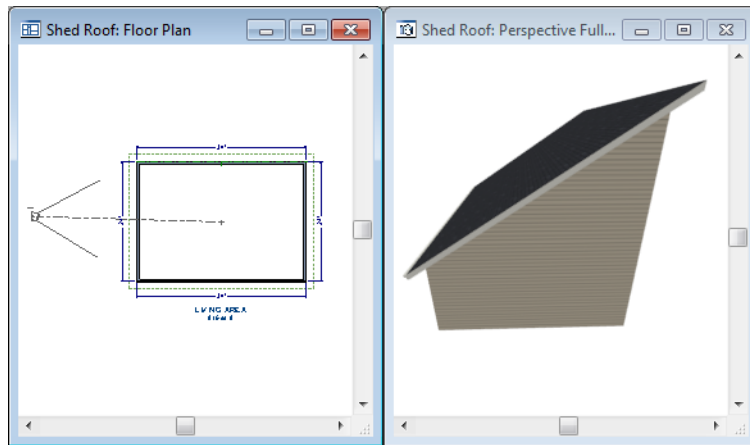

1. Click on the floor plan view window to make it the active view.
2. Select **Build> Roof> Delete Roof** .
3. With the **Select Objects**  tool, double-click the lower horizontal wall and on the Roof tab of the **Wall Specification** dialog, check **High Shed/Gable Wall** and click OK.
4. As in the Gable Roof example, specify the left and right vertical walls as **Full Gable Walls**.
5. Select **Build> Roof> Build Roof**  to open the **Build Roof** dialog and click **OK**.



Saltbox Roofs

A saltbox is a type of gable roof with different pitches on each of the two roof planes and an offset ridge. Assign a different pitch to the two roof planes in the **Wall Specification** dialog for the wall supporting each one.

To create a saltbox roof

1. Click on the floor plan view window to make it the active view.
2. Select **Build> Roof> Delete Roof** .
3. With the **Select Objects**  tool, double-click the lower horizontal wall. On the Roof tab of the **Wall Specification** dialog, remove the check from **High Shed/Gable Wall** and change the pitch to 12 in 12. Click OK to close the **Wall Specification** dialog.

4. Leave the **Full Gable Wall** box checked for the two vertical walls.
5. Select **Build> Roof> Build Roof**  to open the **Build Roof** dialog, specify the pitch as 3 in 12, and click **OK**.

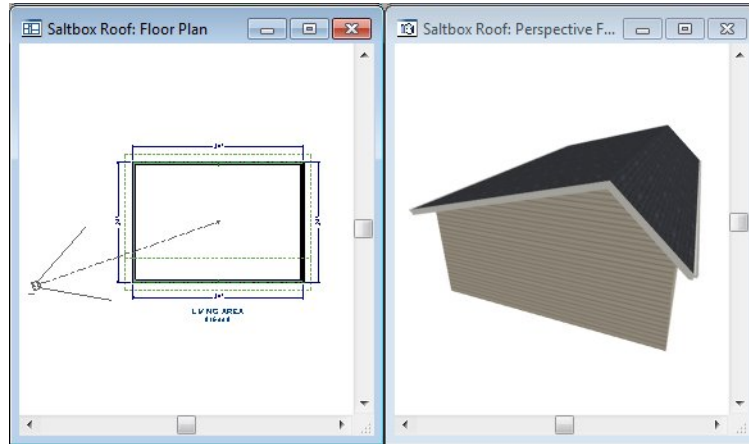

Gambrel Roofs

A gambrel or barn style roof has two pitches on each side of the ridge. The first (lower) pitch on either side is steeper than the pitch near the ridge.

To create a gambrel roof

1. Click on the floor plan view window to make it the active view.
2. Select **Build> Roof> Delete Roof** .
3. Select the horizontal walls and open them for specification. On the Roof tab:

Pitch Options

Pitch in 12

Upper Pitch

Pitch in 12

Starts at Height

In from Baseline

- Specify the lower **Pitch** as 12 in 12.
- Place a check in the box beside **Upper Pitch**.

- Keep the **Upper Pitch** as 6 in 12 and change the **Start Height** to 156.
4. Click OK to close the **Wall Specification** dialog.
 5. The two vertical walls should remain Full Gable Walls.
 6. Open the **Build Roof** dialog, specify the **Pitch** as 6 in 12 once again, and click **OK**.

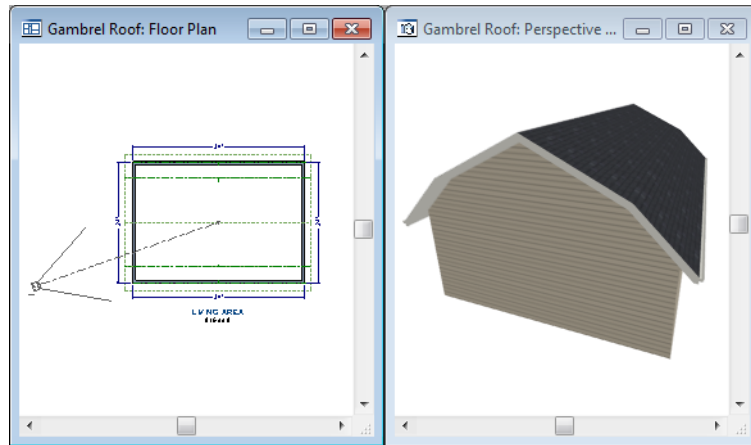

Experiment with alternate pitches and overhangs. Also, try varying the height at which the second pitch begins so that you can see the effect it has on your gambrel roof design.

Gull Wing Roofs

A gull wing roof has two pitches on either side of the ridge, as a gambrel does; but the first pitch of a gull wing is shallower than the second.

To create a gull wing roof

1. Click on the floor plan view window to make it the active view.
2. Select **Build> Roof> Delete Roof** .
3. Change the following settings for each of the horizontal walls on the Roof tab of the **Wall Specification** dialog:

Pitch Options

Pitch in 12

Upper Pitch

Pitch in 12

Starts at Height

In from Baseline

- Specify the lower **Pitch** as 3 in 12.
 - Place a check in the box beside **Upper Pitch**.
 - Keep the **Upper Pitch** as 12 in 12 and change the **Start Height** to 125".
4. The two vertical walls remain Full Gable Walls.
 5. Click the **Build Roof**  tool and click **OK** in the **Build Roof** dialog.

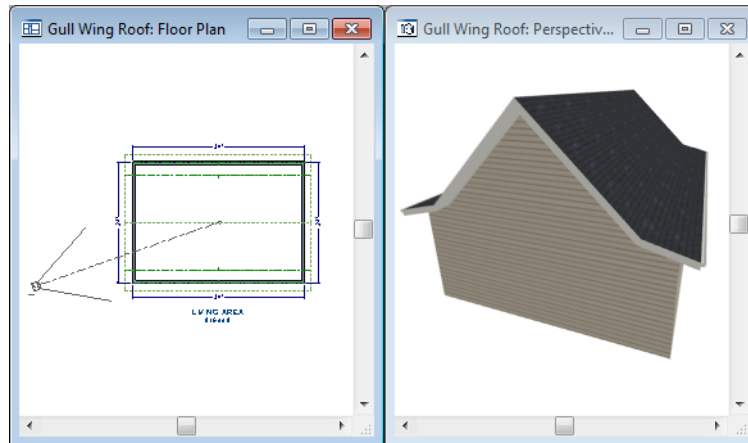



Experiment with the height at which the second pitch begins so that you can see the effect it has on your gull wing roof design.

Half Hip Roofs

A half hip roof has two gable ends. At the top of each gable is a small hip that extends to the ridge.

To create a half hip roof

1. Click on the floor plan view window to make it the active view.
2. Select **Build> Roof> Delete Roof** .

3. With the **Select Objects**  tool, double-click each wall and make these changes on the Roof tab of the **Wall Specification** dialog:

For the two Horizontal walls:

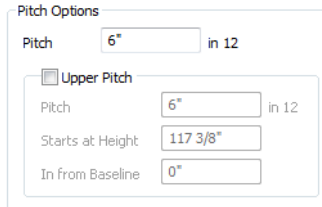

Pitch Options

Pitch in 12

Upper Pitch

Pitch in 12

Starts at Height

In from Baseline

- Specify the lower **Pitch** as 6 in 12.
- Uncheck the box beside **Upper Pitch**.

For the two Vertical walls:

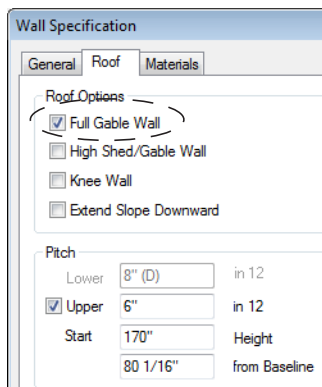

Wall Specification

General Roof Materials

RoofOptions

Full Gable Wall

High Shed/Gable Wall

Knee Wall

Extend Slope Downward

Pitch

Lower (D) in 12

Upper in 12

Start Height

from Baseline

- Leave the **Full Gable Wall** box checked.
 - Check the box beside **Upper Pitch**.
 - Specify the **Upper Pitch** as 3 in 12 and set the **Start Height** at 170".
4. Click the **Build Roof**  tool and click **OK** in the **Build Roof** dialog.

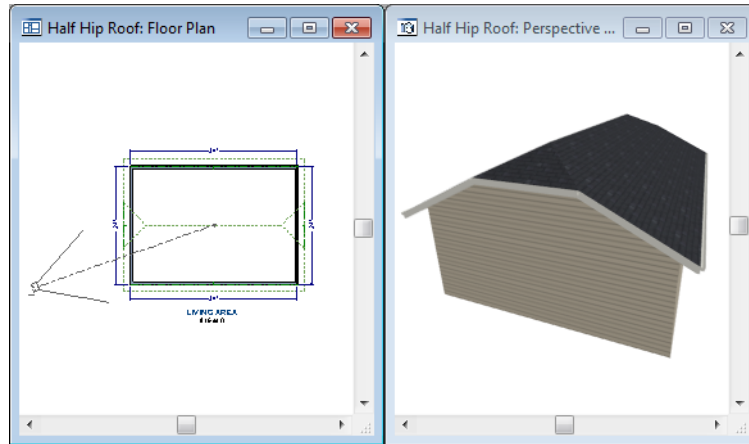



Mansard Roofs

A mansard roof is a hip roof with two slopes on the roof sections above each of the four walls. The second slope begins at the same height above each wall. The upper slope is usually quite gentle and the lower slope, much steeper.

To create a mansard roof

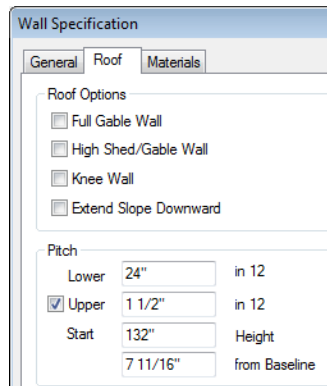
1. Click on the floor plan view window to make it the active view.
2. Select **Build> Roof> Delete Roof** .
3. Select all four walls, open them for specification, and on the Roof tab of the **Wall Specification** dialog specify the following settings:



- Clear the **Full Gable Wall** checkbox.
 - Specify the lower **Pitch** as 24 in 12.
 - Place a check in the box beside **Upper Pitch**.
 - Keep the **Upper Pitch** as 1.5 in 12 and change the **Start Height** to 132".
4. Click the **Build Roof**  tool and click **OK** in the **Build Roof** dialog.

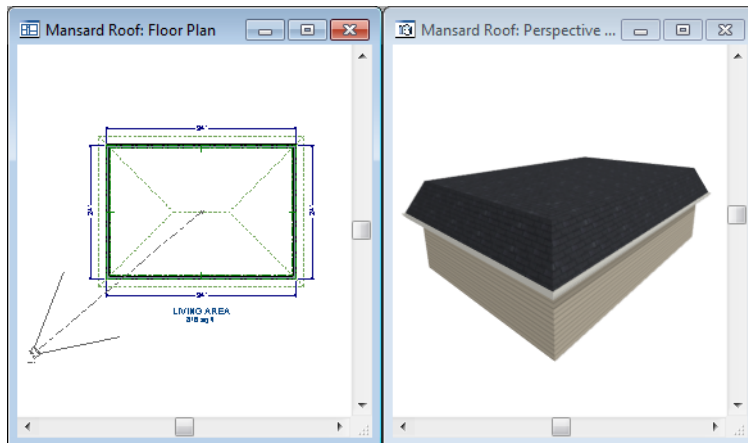

Roof Type Quick Reference



The following chart provides a quick reference for building the roof styles described in this tutorial. The chart shows which walls to change and what to change on the Roof tab of the **Wall Specification** dialog for each wall. These parameters are based on a 34x24-foot model. For different size plans, adjust these numbers.

Roof Type	Wall to Change	Set as Full Gable	Set as High Shed Gable	Lower Pitch	Upper Pitch	Start Height
Gable Roof	Vertical Wall 1					
	Vertical Wall 2					
	Horizontal Wall 1	X				
	Horizontal Wall 2	X				
Shed Roof	Vertical Wall 1	X				
	Vertical Wall 2	X				
	Horizontal Wall 1		X			
	Horizontal Wall 2					
Saltbox Roof	Vertical Wall 1	X				
	Vertical Wall 2	X				
	Horizontal Wall 1			12 in 12		
	Horizontal Wall 2			3 in 12		
Gambrel Roof	Vertical Wall 1	X				
	Vertical Wall 2	X				
	Horizontal Wall 1			12 in 12	6 in 12	156
	Horizontal Wall 2			12 in 12	6 in 12	156
Gull Wing Roof	Vertical Wall 1	X				
	Vertical Wall 2	X				
	Horizontal Wall 1			3 in 12	12 in 12	125
	Horizontal Wall 2			3 in 12	12 in 12	125
Half Hip Roof	Vertical Wall 1	X			3 in 12	170
	Vertical Wall 2	X			3 in 12	170
	Horizontal Wall 1			6 in 12		
	Horizontal Wall 2			6 in 12		
Mansard Roof	Vertical Wall 1			12 in 12	1.5 in 12	132
	Vertical Wall 2			12 in 12	1.5 in 12	132
	Horizontal Wall 1			12 in 12	1.5 in 12	132
	Horizontal Wall 2			12 in 12	1.5 in 12	132



Adding Gables over Doors and Windows

You can add a gable roof over a door or window.



To create a gable roof over a door or window

1. Select a door or window, then click the **Gable Over Door/Window**  edit button.
2. Click the **Build Roof**  tool and click **OK** in the **Build Roof** dialog.
3. A gable is created with an overhang of one foot on each side of the door or window.

To remove a gable roof over a door or window

1. Select the door or window and click the **Delete Gable Over Opening**  edit button.
2. Click the **Build Roof**  tool and click **OK** in the **Build Roof** dialog.
3. When you rebuild the roof, the gable will be removed.

To create a gable over several doors and/or windows

1. Select a door, window, or mulled unit.
1. Hold down the Shift key and click on additional doors and/or windows to add them to your selection set.
2. Click the **Gable Over Door/Window**  edit button.
3. Click the **Build Roof**  tool and click **OK** in the **Build Roof** dialog to create a gable over the selected wall openings.





Creating Dormers

To create dormers in an upper floor, create a new floor for your plan and modify this floor with knee walls and windows to form gables. We'll start with a new 40 x 30 foot plan to learn this technique.

As with automatic dormers, roof pitches of 9 in 12 or greater generally work better than shallow pitches when creating dormers because they provide enough vertical space to build the dormer within.

To create a new plan

1. Select **File> Close All** from the menu to close any open plans.
2. Select **File> New Plan**  to open a new plan. In the **Create New Plan** dialog, select the Default Style template.
3. Select **Build> Wall> Straight Exterior Wall**  and draw a rectangular floor plan, 40 feet by 30 feet, in a clockwise direction.
4. Click the **Fill Window Building Only**  button to zoom in on the house.

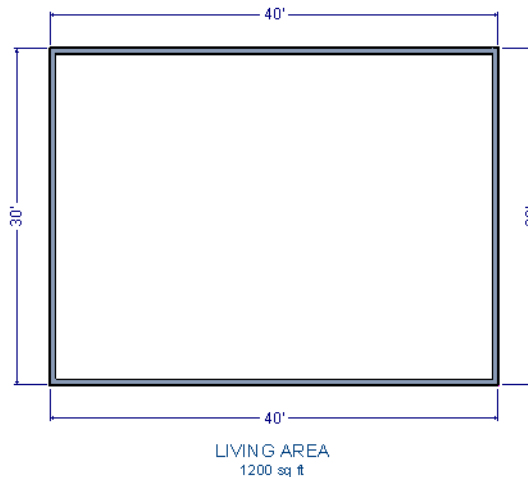

5. Select **File> Save**  from the menu, save the file to an easy to find location, such as Documents, and give the plan a name.
6. Select the right and left vertical walls, open them for specification, and on the Roof tab of the **Wall Specification** dialog, click the **Full Gable Wall** check box and click OK.

7. Select **Build> Floor> Build New Floor** .
8. Check the **Derive new 2nd floor plan from 1st floor plan** option in the **New Floor** dialog and click OK to display the Floor 2 Defaults dialog. Leave these settings at their default for now and click OK.

Select **Build> Roof> Build Roof**

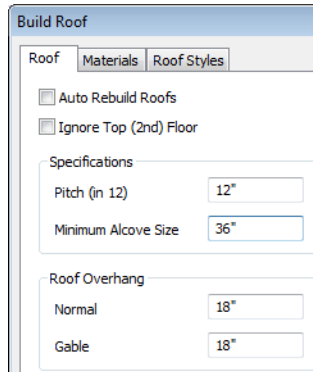

To create two knee walls

A knee wall is a short wall on an upper floor that is cut off by a roof plane.

1. Select **Build> Wall> Straight Exterior Wall**  and draw a horizontal interior wall (from left to right). Position this knee wall so that it is 5 feet from the top exterior wall.
2. Draw another interior wall (from right to left) and position it 5 feet from the bottom exterior wall. You can reposition the knee walls using dimensions. For more information, see “Moving Objects Using Dimensions” on page 343 of the Reference Manual.

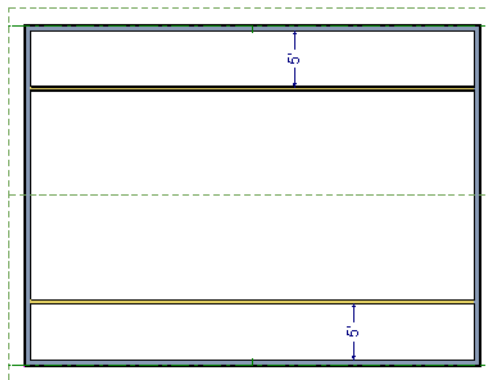

3. Select each of the interior walls one at a time and click the **Open Object**  edit button. Check **Knee Wall** on the Roof tab of the **Wall Specification** dialog and click OK.

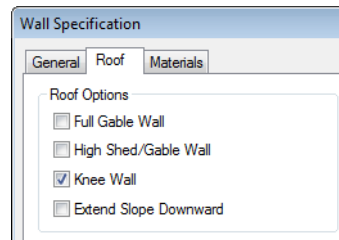

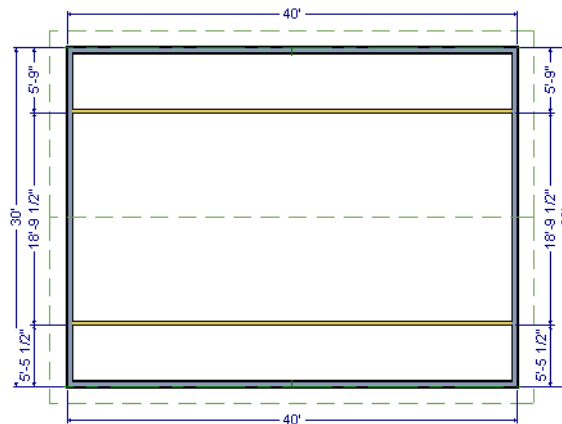

4. Select **CAD> Dimensions> Automatic Exterior Dimensions**  to create exterior dimension lines for your plan, which should now look like this:

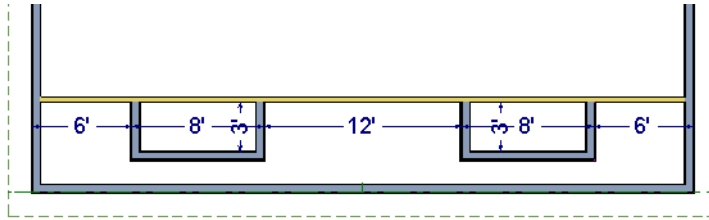

To build the dormer walls

1. Select **Build> Wall> Straight Wall**  and draw two rectangular boxes on the outside of the lower interior wall, as shown in the following image.
2. Position the lower walls of each dormer box 2 feet from the bottom wall. The lower dormer walls are those parallel to the bottom wall.
3. Edit each dormer box so that it is 6 feet from each vertical side wall and 8 feet wide.



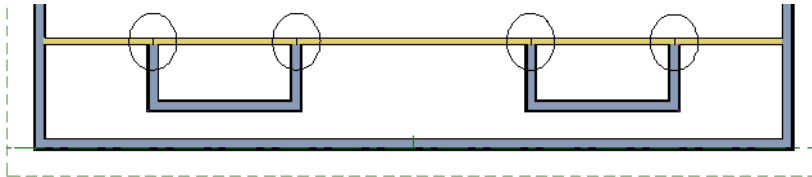

4. Select **Build> Wall> Break Wall**  and click along the lower interior wall to place wall breaks as indicated in center of each overall in the following image.



5. Delete the upper, horizontal portion of each window box.



To add a window to each dormer

1. Select **Build> Window> Window**  and click on each dormer front wall to place a window. The program may warn you that you are adding windows to an interior wall; click **OK** to continue.
2. Select the window; click the **Center Object**  edit button; and click near the wall containing the window to center it on the wall. See “Using Center Object” on page 87 of the Reference Manual.
3. Do the same for the other window.

To build the roof

1. Select the two dormer front walls that contain a window, open them for specification, and on the Roof tab of the **Wall Specification** dialog, check **Full Gable Wall** and click **OK**.

2. Select the dormer side walls, open them for specification, and on the Roof tab of the **Wall Specification** dialog, specify the **Pitch** for the dormer roof plane above the wall, and click **OK**. Earlier we specified a pitch of 12 in 12 in the **Build Roof** dialog, that pitch should have prefilled here. A steep pitch of 12 in 12 will work well for these dormers.
3. Double-click the narrow room above the top knee wall to open the **Room Specification** dialog, designate its **Room Type** as “Attic” and click OK.
4. Do the same for the lower attic room.

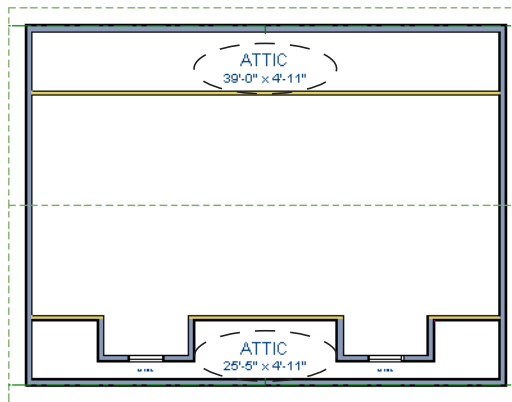

5. Select **Build> Roof> Build Roof**  from the menu.
6. Create a 3D view to see the results.



7. Notice there are small gaps in the dormer side walls. This gap is caused by the difference between the position of the knee walls and the point at which the ceiling intersects the roof plane. This location is marked by the black dotted line in floor plan view.

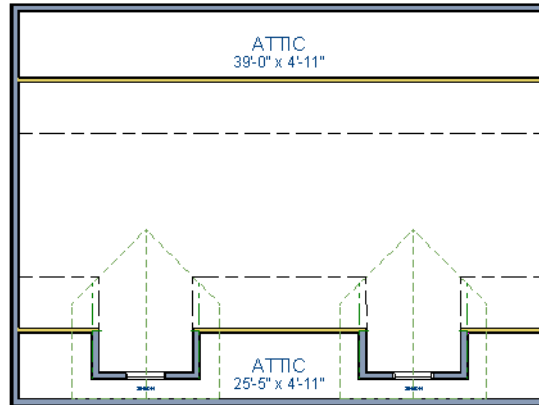

8. Select each of the knee walls and move them back so that they are in alignment with the ceiling plane. The walls will snap into position when they are close to the ceiling lines.

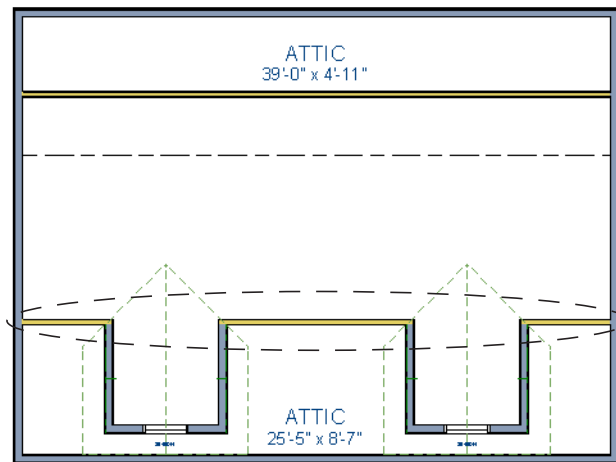



9. Take a look in a 3D view.



You can move the interior walls closer to or further from the outside walls to change the dormers' elevation, or change the pitch for the roof to make the dormers longer. You can create dormers in more complex plans the same way, but you may want to experiment with wall placement and pitch to achieve the desired effect.

Skylights

Skylights can easily be added using the **Skylight**  tool. In floor plan view, select **Build> Roof> Skylight**  then click and drag a rectangular shape within an existing roof plane. When you release the mouse button, a skylight is created and can be repositioned and resized using its edit handles. For more information, see “Skylights” on page 184 of the Reference Manual.

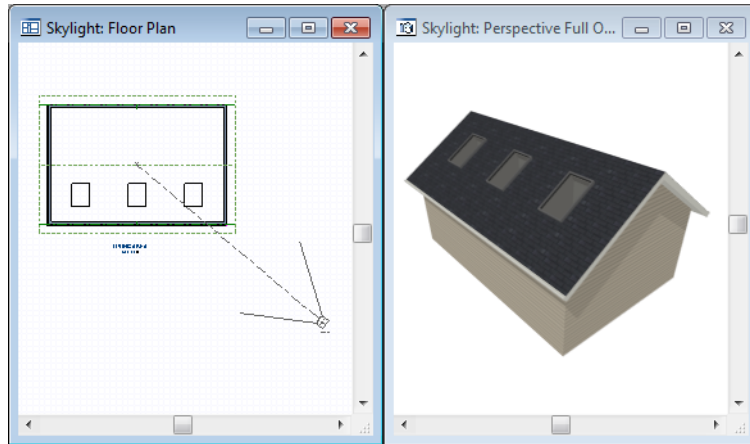

Using the Break Wall Tool to Modify Roofs

Many homes have more than one roof type built above a single exterior wall. One common example is a reverse gable roof, created when a house has gable walls that are perpendicular to one another, as in an L-shaped home.

We can create a reverse gable roof on an L-shaped home using the **Break Wall**  tool.

To create an L-shaped home

1. Select **File> Close All** from the menu.
2. Select **File> New Plan**  to open a new plan. In the **Create New Plan** dialog, select the Default Style template.
3. Draw an L-shaped house with the following dimensions:
 - Left wall - 30 feet long
 - Upper wall - 45 feet long.
 - Right wall 18 feet long.
 - Lower wall extending left from the right wall - 25 feet long.
 - Vertical wall connecting two lower walls - 12 feet long.
 - Lower wall extending right from the left wall - 20 feet long.
4. If desired, turn off **Auto Rebuild Roof** and delete the roof.

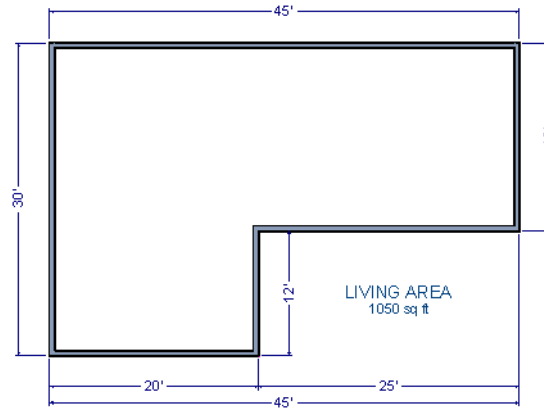

To create a reverse gable in this plan, we need to create three gable walls: two running vertically and one horizontally.

To add a gable roof to the plan

1. Check **Full Gable Wall** on the Roof tab of the **Wall Specification** dialog for these three walls:
 - The far left vertical wall
 - The far right vertical wall
 - The bottom left horizontal wall
2. Click the **Build Roof**  tool to open the **Build Roof** dialog and click OK to build the roof. Your plan should look like this:

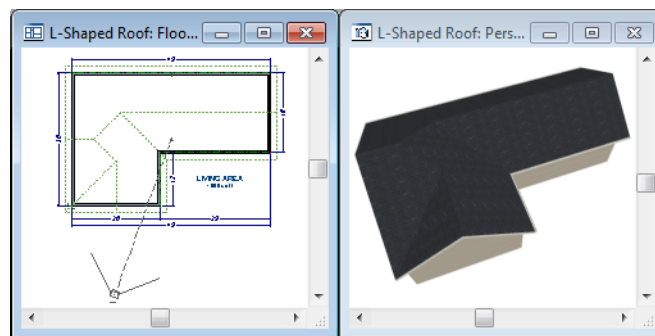



Built this way, the gable wall on the left produces roof planes that extend too high and will interfere with the roof over the lower part of the house. To correct this, use the **Break Wall** 

tool to break the left wall into two different sections. We can then specify the upper section as Full Gable without affecting the lower section.

To use the Break Wall tool

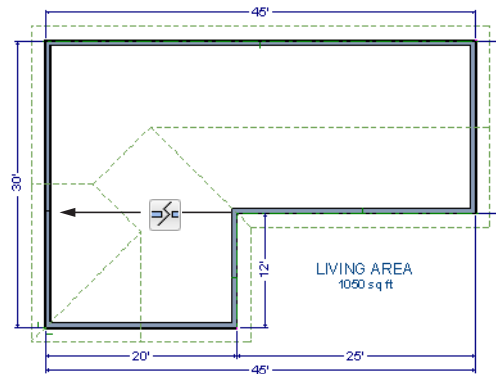
1. Select **Build> Wall> Break Wall**  and click the far left wall at a point even with the lower right wall.
 - An easy way to do this is to temporarily stretch the lower right wall across to the left wall;
 - Place a wall break where the walls meet;
 - Then return the lower right wall to its correct position.



2. Open the lower portion of the wall for specification and on the Roof tab of the **Wall Specification** dialog, clear the **Full Gable Wall** checkbox and click **OK**.
3. Click the **Build Roof**  tool and click **OK** to build a roof based on the new wall specifications.

You now have two full gable roof sections meeting to form your L-shaped roof. Your plan should look like the following image:

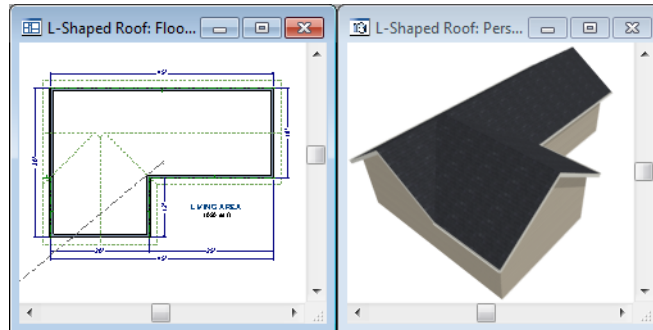

Notice the step in the ridge line. This can be corrected by resizing the lower gable wall. Select the vertical wall to the right of the bottom gable wall and move it to the left 2 feet, reducing the length of the gable wall from 20 to 18 feet. When you are finished, rebuild the roof.

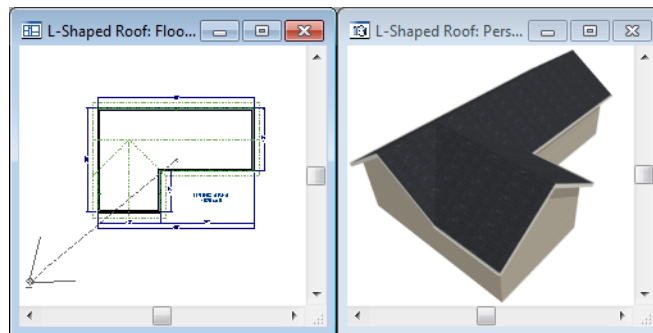

This completes this Roof Tutorial. You can use any combination of the techniques described here to create a wide variety of roof planes. Let's return to our Stucco Beach House plan and apply what we have learned.

Adding a Roof





Now that we have a basic understanding of the automatically roof tools, let's return to our previously saved Stucco Beach House plan, as it looks like our house could use a roof now.

Let's select **File> Save As**  and give this plan a new name, such as "Beach House Roof Tutorial" before continuing.

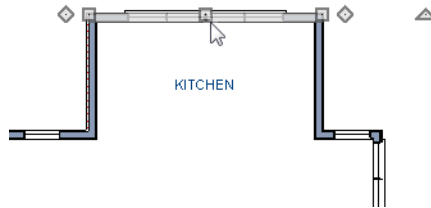
To edit the default roof

1. Close any other views you may still have open. For the following steps, only the floor plan view should be open.
2. Starting on Floor 1, we will start by using the **Select Objects**  tool to select the top horizontal exterior Kitchen wall, as indicated in the image below.



3. Click on the **Open Object**  edit button to display the Wall Specification dialog, go to the Roof tab, place a checkmark in the **Full Gable Wall** option, and click **OK**.
4. Click **Up One Floor**  to go to the second floor.
5. Using the **Select Objects**  tool, select the Balcony room, then click on the **Open Object**  edit button to open the Room Specification dialog, and on the Structure tab, uncheck **Roof Over this Room** if it is selected, then click **OK**.
6. Open the following second floor walls' specification dialogs and assign the settings shown in the following image on the Roof tab of the **Wall Specification** dialog. See "Roof Tab" on page 112 of the Reference Manual.

Individual walls can be selected and edited in both 2D and 3D views. See "Editing Walls"

on page 104 of the Reference Manual.

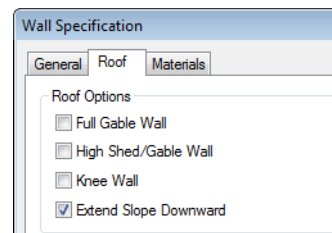
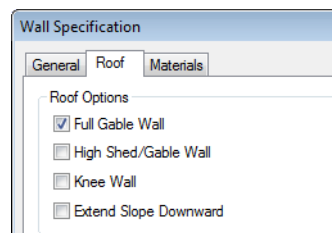
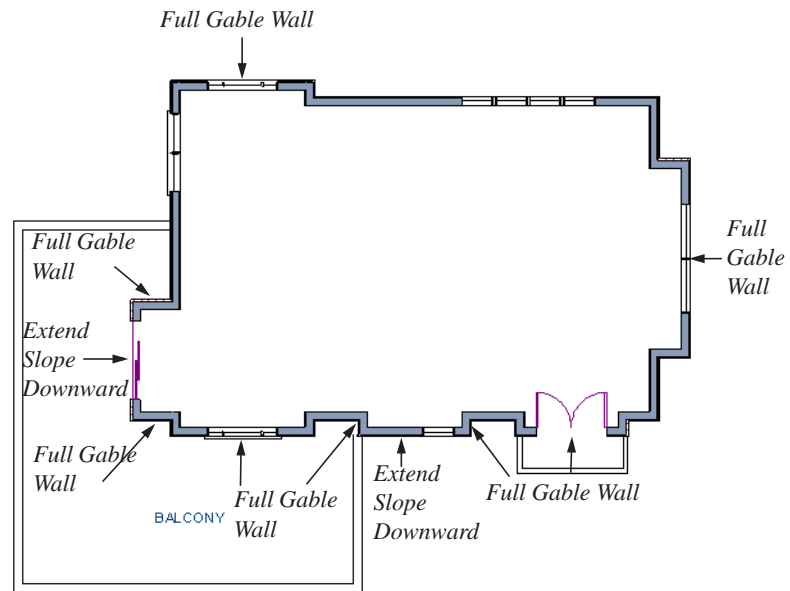

7. Once we have completed defining these walls on Floor 2, we are ready to create our roof.

To turn on automatic roof generation

1. Select **Build > Roof > Build Roof**  from the menu to open the **Build Roof** dialog.
2. On the **Roof** tab, check **Auto Rebuild Roofs**. See “Build Roof Dialog” on page 181 of the Reference Manual for more information.
3. Set the **Pitch (in 12)** to 3”.

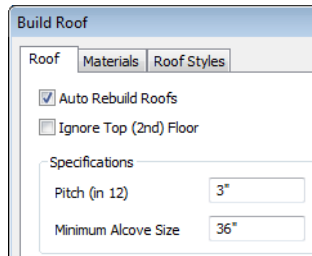

4. You can go to the **Materials** tab to change the material of your roof, where we will choose an Earth Roof Tile material.
5. Click **OK** to close the dialog and generate a roof.
6. Recall that the additional walls you now see displayed are attic walls.
7. Select **3D> Create View> Full Overview**  to create a exterior view of your plan.

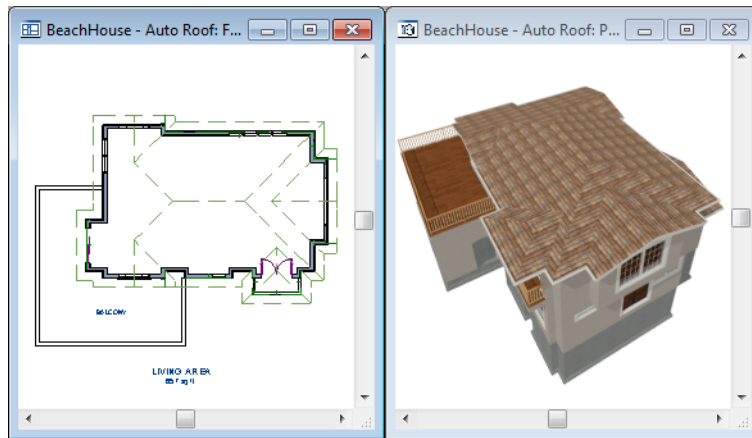

Troubleshooting Roof Issues

Creating a roof can require experimentation and practice. Here are some suggestions for troubleshooting a problematic roof design.

Roof Directives in Walls

As discussed in this chapter and in the Roofs chapter, the program will automatically generate a roof plane bearing over each exterior wall in a plan to produce a hip roof. If you require a

different condition over a particular wall, such as a triangular gable or side wall of a shed roof, you can specify that condition on the Roof tab of the **Wall Specification** dialog. See “Roof Tab” on page 112 of the Reference Manual.

Specifying roof directives that do not reflect what you require directly above a selected wall, however, can often result in drastic and unwanted changes to your roof. For example, when two parallel walls are specified as Full Gable Walls, a single ridge will be created between them.

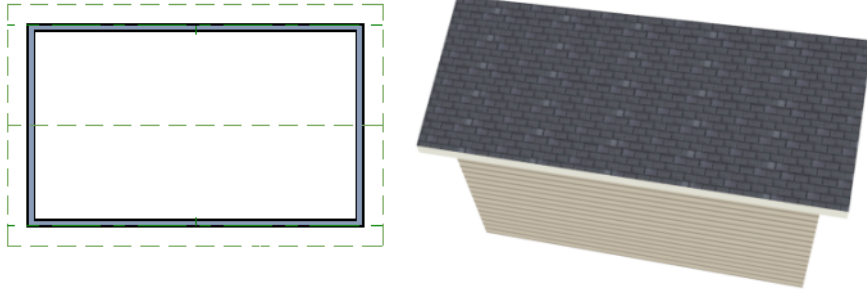

If a wall that is perpendicular to these walls is also specified as a Full Gable Wall, the roof becomes more complex with an additional ridge, two valleys, and two hips.

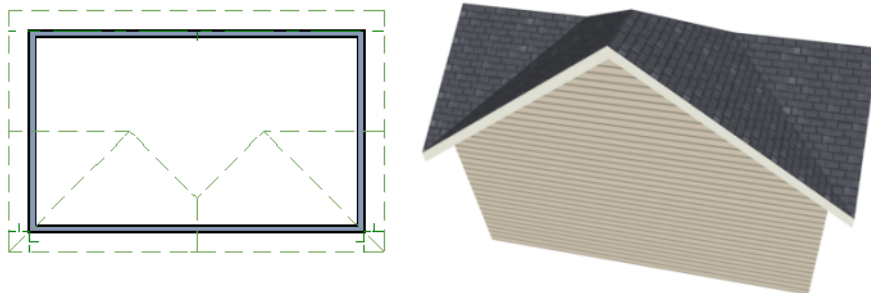

If you are seeing hips or valleys in your roof where you do not expect them, revisit the Roof tab of the walls supporting the affected roof planes.

Roof Heights

The heights of all roof planes are based on the heights of the walls that they bear on. Wall heights, in turn, are determined by the ceiling heights of the rooms that they define. See “Floor & Ceiling Heights” on page 123 of the Reference Manual.

For example, the hip roof over a simple rectangular structure with a consistent ceiling heights (in this case, 109 1/8") has four roof planes.

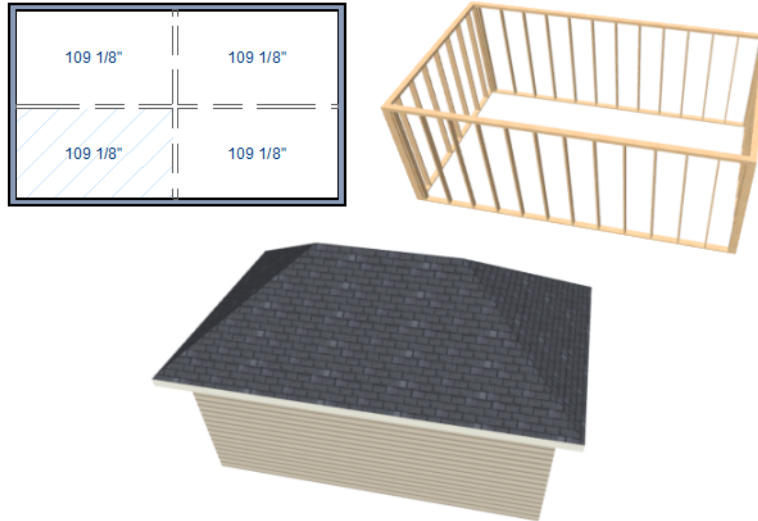

This roof will become considerably more complex if one room inside is given a lowered ceiling height (in this case, 97 1/8").

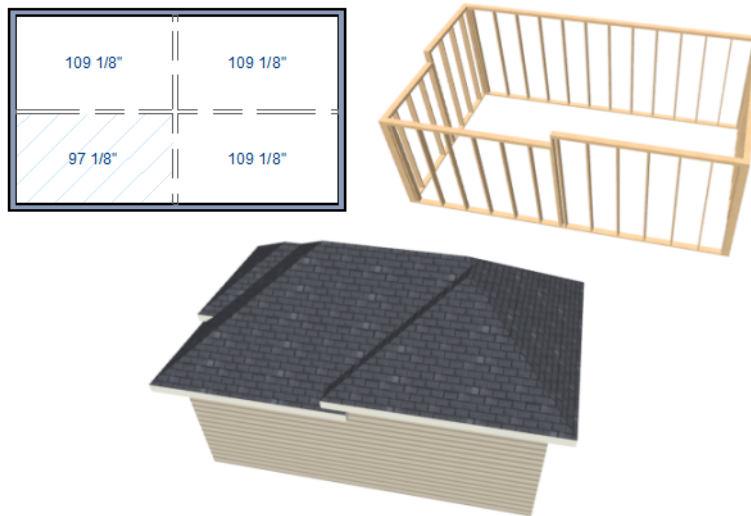

If you generate a roof and it seems to be more complicated and has more roof planes than it should, take a look at the ceiling heights of the rooms in the plan. Often, the correct way to create a lowered ceiling condition will be to set the ceiling at the default height create a lowered Ceiling Finish. See “Lowered Ceilings” on page 125 of the Reference Manual.

Controlling Roof Ridges

A single roof ridge will generate for as long as the bearing walls that support the roofs on either side of the ridge are the same distance apart. When alcoves or bumpouts are introduced along either bearing wall, the ridge is likely to become broken.

For example, a simple rectangular structure with Full Gable Walls at each end generates a roof with a ridge that runs from Full Gable Wall to Full Gable Wall.

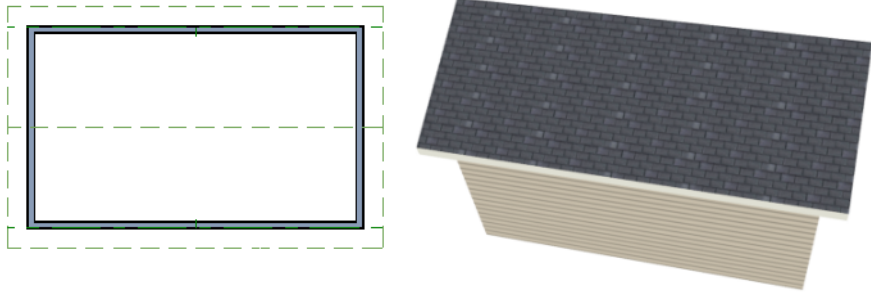

If a bumpout is added that affects the length of either Full Gable Wall, or if an alcove is added anywhere along the length of the structure, the ridge will no longer follow a straight line.

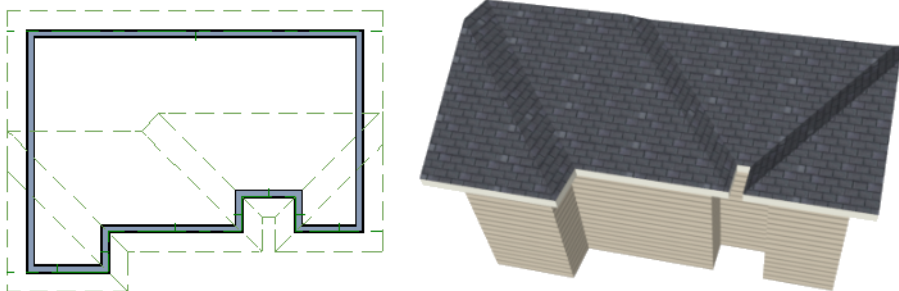

There are a number of ways to maintain a single ridgeline in the presence of alcoves or bumpouts:

- Use the **Break Wall**  tool to control the length of a Full Gable Wall section. See “Using the Break Wall Tool to Modify Roofs” on page 64.

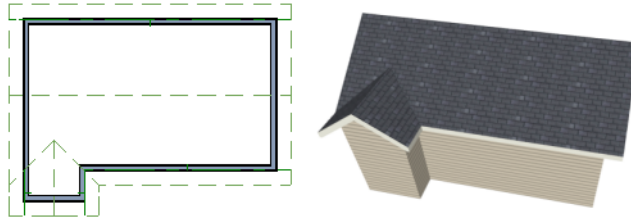

- Increase the **Minimum Alcove Size** to specify what size alcoves are roofed. See “Roof Tab” on page 182 of the Reference Manual.

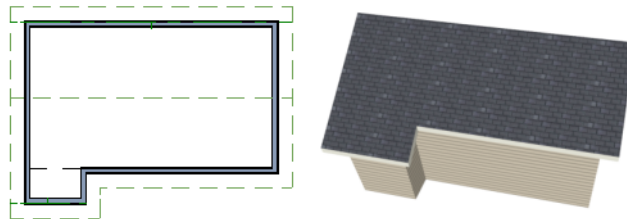

- Use the **Extend Slope Downward** roof directive to allow the roof over a bumpout to extend lower than the ceiling height in that area. See “Roof Directives in Walls” on page 108 of the Reference Manual.

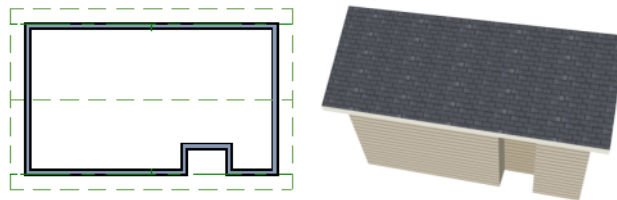

- Specify the area inside of an alcove as an "Open Below" room with a roof but no ceiling, and **Use Soffit Surface for Ceiling** specified. See “Room Types” on page 121 and “Structure Tab” on page 128.

