

**Chief Architect®
Home Designer® Interiors 2018**

Reference Manual

**Chief Architect, Inc.
6500 N. Mineral Dr.
Coeur d'Alene, Idaho 83815
www.HomeDesignerSoftware.com**

© 1990–2017 by Chief Architect, Inc. All rights reserved.

No part of this documentation or the accompanying software may be reproduced or transmitted in any form or by any means, electronic or mechanical, including photocopying, recording, or by any information storage and retrieval system, without permission in writing from Chief Architect, Inc.

Chief Architect® and Home Designer® are registered trademarks of Chief Architect, Inc.

This software uses the FreeImage open source image library. See <http://freeimage.sourceforge.net> for details. FreeImage is used under the FIPL license, version 1.0.

This software uses the Ruby open source library. See <http://www.ruby-lang.org/> for details.

This application incorporates Teigha® software pursuant to a license agreement with Open Design Alliance.

Teigha® Copyright © 2003-2013 by Open Design Alliance. All rights reserved.

3D input device development tools and related technology are provided under license from 3Dconnexion. © 3Dconnexion 1992 - 2013. All rights reserved.

All other trademarks and copyrights are the property of Chief Architect, Inc. or their respective owners.

Created in the United States of America.

Contents

Chapter 1: Program Overview

Startup Options.....	18
The Home Designer Interiors Environment.....	19
Using the Mouse	21
View and Side Windows	23
Toolbars and Hotkeys	24
Menus.....	25
Dialogs	26
The Status Bar.....	29
Message Boxes	29
Preferences and Default Settings.....	30
Drawing a Plan	30
Viewing Your Plan.....	32
Getting Help.....	32
About Home Designer	33
Product Upgrade Options	33
Home Designer Trial Software.....	34

Chapter 2: File Management

Compatibility with Other Programs.....	36
Organizing Your Files.....	36
Home Designer Interiors Data	37
Creating a New Plan	38

Saving, Exporting, and Backing Up Files	39
Thumbnail Images	42
Auto Archive	42
Undo Files	43
Opening and Importing Files	44
Referenced Files	46
Backup Entire Plan	47
Closing Views and Files	48
Exiting Home Designer Interiors	48

Chapter 3: Space Planning

Space Planning	49
Room Box Specification Dialog	51

Chapter 4: Preferences and Default Settings

Default Settings vs Preferences	54
Dynamic Defaults	55
Reset to Defaults	55
General Plan Defaults Dialog	56
Preferences Dialog	57

Chapter 5: Toolbars and Hotkeys

Toolbar Arrangement	67
Hotkeys	69

Chapter 6: Window and View Tools

View Tools	72
Zoom Tools	72

Undo Zoom	73
Fill Window	73
Panning the Display.....	73
Working in Multiple Views.....	74
Closing Views.....	76

Chapter 7: Creating Objects

Architectural vs CAD Objects.....	78
Snap Behaviors.....	78
Object Snaps	78
Angle Snaps	79
Grid Snaps.....	79
Creating Objects	80
Copying and Pasting Objects	81

Chapter 8: Displaying Objects

Drawing Groups	86
Layers	86
Displaying Objects.....	87
Layer Sets.....	88
Display Options Dialog.....	88

Chapter 9: Editing Objects

Selecting Objects.....	92
Editing Line Based Objects	94
Editing Arc Based Objects.....	96
Editing Open Polyline Based Objects.....	99
Editing Closed-Polyline Based Objects.....	101
Editing Box-Based Objects.....	104

Editing Spline Based Objects	105
Editing Circles, Ovals and Ellipses	107
Displaying Objects	109
Moving Objects	110
Aligning Objects	112
Resizing Objects	113
Reshaping Objects	114
Rotating Objects	115
Matching Properties	116
Deleting Objects	117
Undo and Redo	118

Chapter 10: CAD Objects

The CAD Drawing Tools	121
Line Specification Dialog	123
Arc Specification Dialog	125
Circle/Oval/Ellipse Specification Dialog	127
Polylines	127
Polyline Specification Dialog	128
Box Specification Dialog	130
Splines	130
Displaying CAD Objects	131

Chapter 11: Walls and Railings

Wall Defaults	134
Wall Tools	134
Railing Tools	135
Exterior and Interior Walls	136
Foundation Walls	137
Room Dividers and Invisible Walls	137

Hatch Wall.....	138
Break Wall.....	139
Drawing Walls	139
Connecting Walls.....	141
Displaying Walls	142
Measuring Walls.....	144
Editing Walls	146
Editing Straight/Curved Wall Combinations	148
Aligning Walls	149
Roof Directives in Walls	150
Attic Walls.....	151
Wall Type Definitions.....	152
Wall Specification Dialog	153
Railing Specification Dialog.....	157
Wall Hatch Specification Dialog	160

Chapter 12: Rooms

Room Definition	163
Floor and Room Defaults	165
Room Types	165
Selecting Rooms.....	167
Displaying Rooms.....	168
Editing Rooms.....	168
Room Labels	170
Decks	171
Floor and Ceiling Heights	172
Stepped Floor and Ceiling Platforms.....	173
Special Ceilings	174
Room Specification Dialog	176

Chapter 13: Dimensions

Dimension Unit Defaults	183
Dimension Defaults Dialog	183
The Dimension Tools	186
Displaying Dimension Lines.....	188
Editing Dimension Lines.....	189
Editing Extension Lines.....	191
Moving Objects Using Dimensions.....	192
Dimension Line Specification Dialog.....	193

Chapter 14: Text

Text Defaults	195
Fonts and Alphabets	196
The Text Tools	197
Creating Text.....	197
Displaying Text.....	198
Rich Text Specification Dialog	198
Text Specification Dialog	201
Editing Text	201
Copying and Pasting Text.....	203
Text Arrows.....	204
Text Styles.....	205

Chapter 15: Doors

Door Defaults	209
The Door Tools	210
Displaying Doors	212
Editing Doors	213
Changing Door Swings	214

Special Doors	217
Door Specification Dialog	218

Chapter 16: Windows

Window Defaults	226
The Window Tools	226
Special Windows.....	228
Grouped Windows	229
Displaying Windows	230
Editing Windows	231
Window Specification Dialog	232
Bay, Box, and Bow Windows	241
Bay, Box, Bow Windows and Roofs.....	243
Bay/Box and Bow Window Specification Dialogs	244

Chapter 17: Cabinets

Cabinet Defaults.....	248
The Cabinet Tools	248
Cabinet Fillers	250
Placing Cabinets	251
Displaying Cabinets.....	252
Editing Cabinets.....	253
Editing Cabinet Styles	254
Special Cabinets	255
Cabinet Specification Dialog	257
Shelf/Partition Specification Dialog	263

Chapter 18: Electrical

The Electrical Tools	266
----------------------------	-----

Placing Electrical Objects	267
Auto Place Outlets	268
Connect Electrical	268
Electrical Library Content	269
Displaying Electrical Objects	270
Editing Electrical Objects	270
Electrical Service Specification Dialog	271

Chapter 19: Foundations

Foundation Defaults	278
Building a Foundation	278
Displaying Foundations	279
Editing Foundations	280
Deleting Foundations	281
Foundations and Rooms	281
Fireplaces	282
Fireplace Specification Dialog	284
Library Fireplaces	285
Chimneys	286

Chapter 20: Multiple Floors

Floor Defaults Dialog	288
Floor Tools	288
Adding Floors	289
Displaying Floors	290
Exchanging Floors	290
Deleting Floors	291
Split Levels	291
The Current Floor	292
The Attic Floor	293

The Reference Floor	293
---------------------------	-----

Chapter 21: Stairs and Landings

Stair Defaults	295
The Stair Tools	296
Anatomy of a Staircase	297
Drawing Stairs	298
L- and U-Shaped Stairs	299
Displaying Stairs and Landings	300
Editing Stairs	300
Merging Stair Sections	301
Landings	303
Maintaining Tread Depth	305
Starter Treads	306
Wrapped Stairs	307
Other Special Railings and Stairs	308
Creating a Stairwell	308
Rooms Below Staircases	310
Staircase Specification Dialog	311
Stair Landing Specification Dialog	317

Chapter 22: Roofs

Roof Defaults	322
The Roof Tools	322
Automatic Roofs	323
Build Roof Dialog	323
Editing Roofs	325
Skylights	326
Skylight Specification Dialog	326
Roof Pitches in Degrees	328

Chapter 23: The Library

The Library Browser.....	330
Searching the Library.....	333
Library Content.....	334
Downloading Library Content	336
Importing Library Catalogs.....	337
Adding Library Content.....	338
Organizing the Library	339
Exporting Library Catalogs.....	342
Placing Library Objects	342
Select Library Object Dialog.....	344
Replace From Library.....	344
Displaying Library Objects	345
Editing Library Objects	346
Symbol Object Specification Dialogs	347

Chapter 24: Architectural Blocks

Displaying Architectural Blocks.....	352
Editing Architectural Blocks.....	352
Architectural Blocks and Sub-Objects	352

Chapter 25: Other Objects

General Shapes	355
Soffits	355
Special Applications for Soffits.....	356
Soffit Specification Dialog	358

Chapter 26: Materials

About Materials	361
Material Defaults	362
The Material Painter.....	363
Materials Panel.....	366
Select Material Dialog.....	367
Editing Materials	369
Creating Materials.....	369
Define Material Dialog	370
Select Color Dialog	372

Chapter 27: 3D Views

OpenGL and Hardware.....	376
Backdrop Dialog	376
3D View Tools.....	377
Creating Camera Views	377
Creating Overviews	378
Displaying 3D Views	379
Repositioning Cameras.....	380
Editing 3D Views	385
Cross Section Slider.....	387
Working in 3D.....	388
Saving and Printing 3D Views	389
Camera Specification Dialog	390

Chapter 28: 3D Rendering

Rendering Tips.....	394
Lighting.....	395
Displaying Lights.....	396

Light Types	397
Adjust Sunlight Dialog	397
Rendering Techniques	398
Rendering Technique Options	400
Speeding up 3D View Generation	402

Chapter 29: Pictures, Images, and Walkthroughs

Picture Files vs Pictures and Image Objects	406
Images	406
Displaying Images	407
Editing Images	408
Image Specification Dialog	408
Pictures	411
Picture File Box Specification Dialog	412
Metafiles	413
Metafile Box Specification Dialog	414
Displaying Pictures and Metafiles.....	414
Editing Pictures and Metafiles.....	414
Copy Region as Picture	415
3D Backdrops	415
Walkthroughs.....	417

Chapter 30: Importing 3D Symbols

Import Room Planner File	420
3D Data Import Requirements	420
Importing 3D Symbols.....	421
Symbol Specification Dialog	422
3D Symbols and Materials	423
Export 360 Panorama	425

Chapter 31: Materials Lists

The Materials List.....	428
Creating an Accurate Materials List.....	428
Organizing Materials Lists	428
Materials List Display Options Dialog.....	429
Editing Materials Lists.....	430
Printing and Exporting the Materials List.....	431
Conditioned Area Totals	431

Chapter 32: Printing

Introduction to Printing	434
The Printing Tools	435
Drawing Sheet Setup Dialog.....	435
Print Preview	437
Printing to Scale.....	438
Printing Across Multiple Pages	438
Printing to a PDF File.....	439
Print View Dialog.....	439
Print Image Dialog	442

Appendix A: Additional Resources

Reference Manual	445
User's Guide.....	445
Online Help Videos	446
Home Designer Web Site	446
Online Home Designer Samples Gallery	446
HomeTalk Online User Forum	446
Technical Support.....	447

Appendix B: Technical Support Services

Reference and Training Resources	449
Troubleshooting Common Technical Issues	450
Troubleshooting Printing Problems	450
Error Messages.....	452
Contacting Technical Support.....	453
Program Paths Dialog	454

Program Overview

Home Designer Interiors is designed to help home enthusiasts visualize, develop and share their design ideas. Home Designer Interiors uses parametric design technology, which means that as you draw, a 3D model is created and is updated as you make changes. You can tile a floor plan view next to a 3D view and watch one update automatically as you draw in the other.

Chapter Contents

- Startup Options
- The Home Designer Interiors Environment
- Using the Mouse
- View and Side Windows
- Toolbars and Hotkeys
- Menus
- Dialogs
- The Status Bar
- Message Boxes
- Preferences and Default Settings
- Drawing a Plan
- Viewing Your Plan
- Getting Help
- About Home Designer
- Home Designer Trial Software

Startup Options



When Home Designer Interiors opens, the **Startup Options** dialog displays, allowing you to choose how you want to begin working in the program or access useful resources.

The **Startup Options** dialog can be opened at any time by selecting **File> Startup**

Options

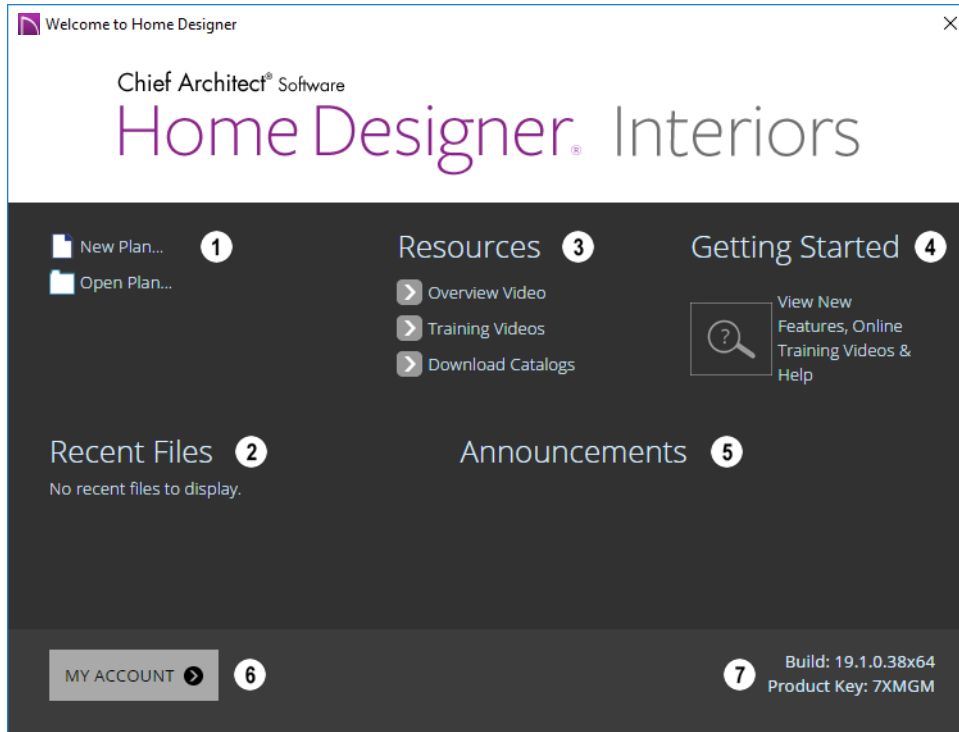

1 Select a **File** command to open a .plan file.

- Click **New Plan** to open a new, blank file. See “Creating a New Plan” on page 38.
- Choose **Open Plan** to work on an existing plan file. See “Opening and Importing Files” on page 44.

2 **Recent Files** lists the full pathnames of the most recently opened files. Click on a name to open the file.

Move your mouse pointer over a name to see the file's full pathname.

3 A selection of useful online **Resources** is available here. Select one to launch

your default internet browser to a page on our web site, www.HomeDesignerSoftware.com.

- Select **Overview Video** to watch a browsable collection of videos outlining the software's features and uses.
 - Select **Training Videos** to access a searchable collection of videos focused on specific topics.
 - Select **Download Catalogs** to visit our 3D Library of downloadable bonus and manufacturer library catalogs. See "Library Content" on page 334.
- 4** Click **Getting Started** to launch your default internet browser to the Getting Started page on our web site. There, you will

find links to a variety of online resources to help you begin using the program.

- 5** When an internet connection is available, the **Announcements** section displays updated messages and news from Chief Architect.
- 6** Click **My Account** to launch your default internet browser to the Log In page on our web site.
- 7** Your software version's **Build** number and the first five characters of your **Product Key** display here for reference.

To prevent the **Startup Options** dialog from displaying when you launch Home Designer Interiors, uncheck **Show Options on Startup** in the **Preferences** dialog. See "General Panel" on page 60.

The Home Designer Interiors Environment

Object-Based Design

Home Designer Interiors's parametric, object-based design technology means you place and edit objects, rather than work with the many individual lines or surfaces used to represent them.

You can quickly select and edit the location, size, shape, style and other properties of objects as well as change the materials applied to their surfaces.

Use Home Designer Interiors's editing capabilities to make the objects you place in a plan match the objects they represent in real life. For example, you can set up your windows and doors to match those available from your supplier.

3D Drafting

In Home Designer Interiors, the entire drawing area is laid out on a Cartesian grid, a three dimensional coordinate system described using the X, Y, and Z axes. The current position of your mouse pointer displays in the Status Bar at the bottom of the program window.

Architectural objects take up space in all three dimensions and their height, width and depth can be specified in Imperial or metric units. In addition, the location of objects can be precisely defined using coordinates, again specified in Imperial or metric units.

CAD objects such as lines and arcs take up space in two dimensions in the current view. Their dimensions can also be specified in

Imperial or metric units and their locations precisely defined using coordinates.

Easy Access to Tools

You can access Home Designer Interiors’s features in various ways using the mouse and keyboard.

- Menus provide access to most tools.

- Convenient toolbar buttons allow fast access to tools and let you customize the interface.
- Keyboard shortcuts are available for most tools.
- Contextual menus display with a right-click of the mouse.
- The Status Bar at the bottom of the screen provides tool descriptions and other information about the current task.

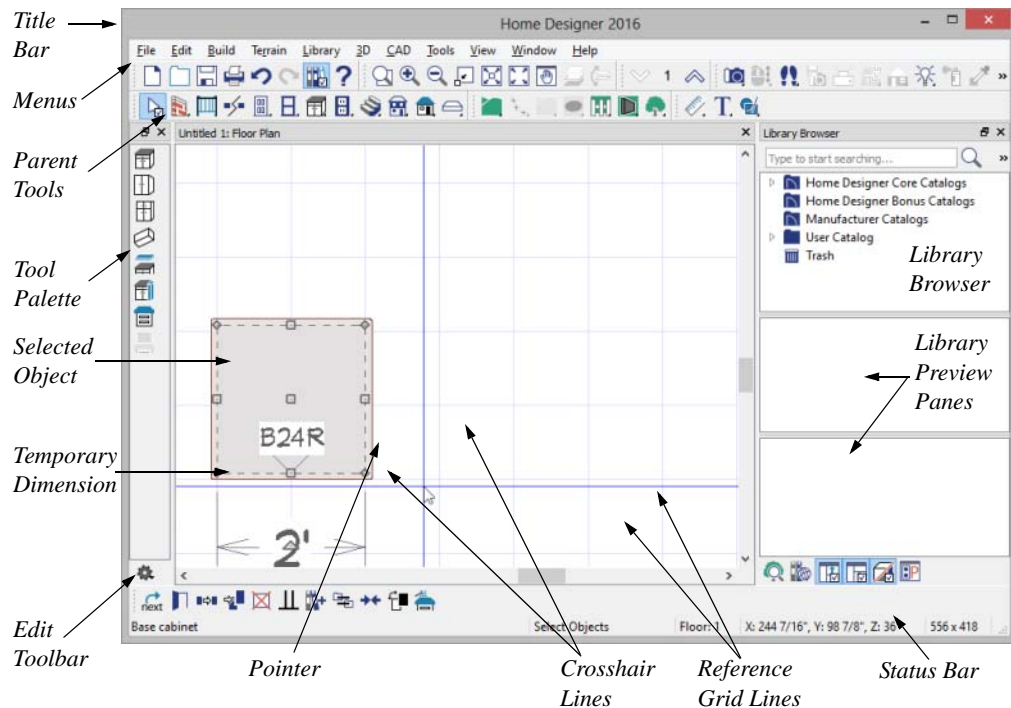

Interface Toggles

A number of useful drawing and editing behaviors, as well as the display of important elements in the interface, can be easily enabled and disabled using the menus. For example:

- Object Snaps, Angle Snaps, and Grid Snaps can be toggled on or off as needed. I See “Snap Behaviors” on page 78.
- Display Elements like Print Preview, Show Line Weights, and the Reference

Display can be turned on when needed and then toggled off.

When a setting is turned on, its icon in the menu will display a small checkmark at its lower right corner and have a border around it in.

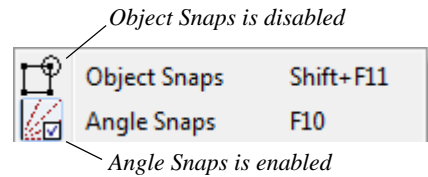

Many of these interface elements are global Preferences while others are file-specific default settings. See “Default Settings vs Preferences” on page 54.

Using the Mouse

Many objects, such as doors and cabinets, are created by clicking the left mouse button. Others, such as walls, stairs and dimension lines, are created by dragging the pointer from one end of the object to the other.



The **left button** is the primary button used in Home Designer Interiors. Unless specified otherwise, Home Designer Interiors documentation refers to the left mouse button.

Note: If you are left-handed and have re-programmed your mouse, reverse the instructions for left and right buttons in this manual.



The **Right button** has several uses.

Right-click to select any object. If, for example, the **Straight Exterior Wall**  tool is active, the left mouse button allows you to select only walls. You can select other object types such as cabinets with the right mouse button.

You can also use the right mouse button to open a context sensitive menu with additional editing commands. See “Contextual Menus” on page 25.



The **Middle button** can be used to pan in most view types. To close a tabbed view window, click on its tab using the middle mouse button. You can also program it to work as a double-click.

If your mouse does not have a middle mouse button, in the Mac version of Home Designer Interiors you can use the left button and the Command key to achieve the same results.



The **Mouse Wheel** can be used to zoom in and out in most view types. See “Zoom Tools” on page 72.

3D Mice

3Dconnexion®'s 3D mice can be used to navigate in Home Designer Interiors. For information about navigating in camera views and overviews, see “3Dconnexion® 3D Mice” on page 382.

Using a Trackpad

In addition to the standard trackpad gestures on your system, in Home Designer Interiors you can pinch to zoom.

In macOS™, you can Command + click to pan. Panning is not supported in the Windows version of the software, however.

Touch Screens

Standard one-finger touch screen gestures are supported in both the Windows and Mac versions of the software. In the Windows version, touching with a second finger to cancel an action is also supported, as are two-finger pan and two-finger pinch to zoom.

Edit Handles

When you select an object, its edit handles display.

When you pass the mouse over an edit handle, information about what the handle does displays in the Status Bar and the pointer changes to show how you can use that handle.

- A two-headed arrow indicates that the object, corner or edge can be moved in the direction of the arrows.
- A four-headed arrow indicates that the selected object or edge may be moved in multiple directions.
- A circular arrow indicates that the selected object can be rotated.

Resize handles display along the edges of the object are used to change the size. See “Resizing Objects” on page 113.



The Move handle at the object’s center lets you move the object. Depending on the type of object(s) selected and how far you are zoomed in or out, the position of the Move handle may shift so that it remains on-screen. See “Moving Objects” on page 110.

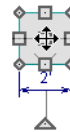

The triangular Rotate handle lets you rotate the object. See “Rotating Objects” on page 115.



You can cancel any edit handle operation before it is completed by pressing the Esc key on your keyboard or by pressing any two mouse buttons at the same time.

The edit handles that display depend on the type of object selected, the current view, and how far you are zoomed out.

Edit handles do not resize as you zoom in or out. If you are zoomed out far enough, some edit handles may be hidden so that they do not stack over one another. As you zoom in, these handles become visible again.

Mouse Pointer Icons

The appearance of the mouse pointer in Home Designer Interiors will vary, depending on which tool is active. For

example, when the **Select Objects**  tool is active, it will look like a white arrow, and

when a **Cabinet Tool**  is active, it will look like a base cabinet with a small cross.

View and Side Windows

Home Designer Interiors’s main program window has a number of important features that let you interact with the program, such as toolbars and menus. It also features two different kinds of windows: view windows and side windows.

View Windows

View windows are sometimes referred to as “the drawing area” because most of them are windows in which you can draw or place architectural and/or CAD objects. There are a number of different types of view windows in Home Designer Interiors:

- Floor plan view
- Camera views and overviews
- Materials Lists

View windows can be navigated by panning and zooming; and, they have scroll bars on the right side and on the bottom. You can turn off the display of the scroll bars by selecting **View > Scrollbars** . See “View Tools” on page 72.

Although only one view window can be active at any given time, there is no limit to the number of view windows that can be open. View windows can be tiled or tabbed, and you can navigate between them in a number of different ways. See “Window and View Tools” on page 71.

You can also tear a view window out of the main program window. This creates a

second, separate program window complete with toolbars and menus. Individual view windows can be torn out and transferred between program windows.

Side Windows

Side windows provide access to a variety of tools and content that helps you add detail your drawings.

Side windows are so-named because they are typically docked to either the left or right side of the program window - although, they can also be docked to the top or bottom, or undocked entirely. There are several different types of side window:

- Child Tool Palette
- The Library Browser

Each of these side windows can be opened via the **View** menu or by clicking the toolbar button associated with it. Similarly, each can be closed by clicking the **Close** button in its title bar or tab, via the **View** menu, or by clicking its toolbar button. See “View Tools” on page 72.

To undock a side window, either drag its title bar out into the drawing area or click the Undock button on its title bar. To dock a side window, drag its title bar to any side of the program window. You can also double-click on its title bar to return it to its last docked location.

Two or more side windows can be docked together to form a shared side window, and can be tiled and/or tabbed within that shared window. To create a shared side window, begin by docking a side window to a side of the main program window, then:

- To create tabbed side windows, drag a second side window over the first. When the docked window becomes highlighted, release the mouse button.
- To create tiled side windows, drag a second side window over the first. When the docked window becomes highlighted,

slowly drag the mouse towards one of its sides. When a highlighted space is created along that side, release the mouse button.

You can choose to disable **Side Window Drag Docking** in the **Preferences** dialog, and you can also enable **Top/Bottom Docking**. See “Appearance Panel” on page 58.

Side windows can also be set to their initial states in the **Preferences** dialog. See “Reset Options Panel” on page 64.

Toolbars and Hotkeys

Using the toolbar buttons is the fastest, easiest way to access many program features. If a tool is active, a small checkmark will display at the lower left of its button icon. When you pass the pointer over a toolbar button, a “tool tip” displays the name of the tool and a more detailed description displays in the Status Bar at the bottom of the program window. When you see one of these tool tips, press the F1 key to get more information about that item. See “Getting Help” on page 32.

Home Designer Interiors’s tools are organized into families of related tools which can be accessed using either of two styles of toolbar interface: the Child Tool Palette or Drop Down tools. You can select the interface that you prefer in the **Preferences** dialog. See “Appearance Panel” on page 58.

The Edit Toolbar

When you select an object, the edit toolbar appears. By default, it is located at the

bottom of the program window, just above the Status Bar. The buttons on the edit toolbar can be used to edit the selected object(s). Which buttons display depends on the type of object selected, the current view, and how you selected the object.

The edit toolbar buttons are the same as the options in the contextual menu when you right-click on an object. See “Contextual Menus” on page 25.

Hotkeys

Many commands can be invoked from the keyboard. Press Alt on your keyboard and press the underlined letter in a menu name to access that menu, as well as items in the menus and submenus.

Other keys or key combinations will invoke a variety of program commands. If a Home Designer Interiors menu item has a keyboard shortcut, or hotkey, associated with it, that hotkey will display to the right of its name in the menu.

Menus

Home Designer Interiors uses a standard Windows menu format. The menus are located below the title bar in the program window and can be used to access nearly all tools in the program. Click on a menu name to expand it, then click on a menu item to either activate that tool or access the item’s submenu. Items with a submenu have an arrow to the right of the name.

Menu items with an icon to their left have a toolbar button associated with them.

The menus can be accessed using the keyboard. Press the Alt key once to enable this functionality - one letter in each menu will become underlined. Press the key associated with one of these underlined letters to expand its menu - one letter in each menu item’s name will be underlined. Press the key associated with one of these letters to activate that tool or access the item’s submenu. Press the Esc key to undo your last selection, or click with the mouse to exit out of this functionality.

Many tools in Home Designer Interiors also have hotkeys associated with them. If a menu item has a hotkey, it will display to the right of the item’s name. See “Hotkeys” on page 69.

<u>E</u> dit	<u>B</u> uild	<u>T</u> errain	<u>L</u> ibrary	<u>3</u> D	<u>C</u> AD
↶	Undo				Ctrl+Z
↷	Redo				Ctrl+Y

Edit menu items with button icons to the left and hotkeys to the right

In the Home Designer Interiors documentation, menu paths are written in this format: **Build> Window> Box**

Window .

Contextual Menus

Contextual menus are context-sensitive menus that display tools relevant to a selected object or view. To open a contextual menu, right-click on an object, in an empty space in a view window, or in a text field in a dialog box.

The options in an object’s contextual menu are usually the same as those on an object’s Edit toolbar. See “The Edit Toolbar” on page 24.

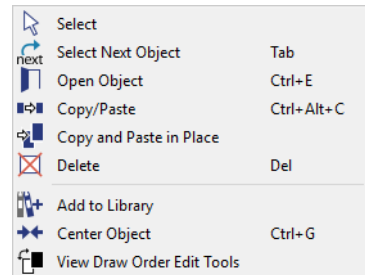

Contextual menus can be enabled or disabled in the **Preferences** dialog. When contextual menus are disabled, right-clicks perform generic object selection, much like when the

Select Objects  tool is active. See “Appearance Panel” on page 58.

Dialogs

Default and preference settings, object specifications, display settings, and many other functions are accessed through dialog boxes.



Many dialogs have multiple panels, which are listed in a tree list on the left side of the dialog. Click on a panel name in the list to make it active. In Windows, panels can also be navigated using the keyboard. Press:

- Ctrl + Tab or Ctrl + F6 to navigate forward;
- Ctrl + Shift + Tab or Ctrl + Shift + F6 to navigate backward.

When a panel name is active, you can also navigate the tree list using the Up and Down arrow keys.

By default, dialogs always open to the first panel in the list; if you prefer, you can choose to **Open Dialogs to the Last Panel Visited**. See “General Panel” on page 60,

Dialog panels and settings can be accessed using the mouse. You can also navigate the settings on a given dialog panel using the keyboard. For example:

- Line items in tree lists can be browsed using the arrow keys. Up and Down navigate the list, while Left and Right expand and contract categories.
- Press the Tab key to shift focus from the tree list to the first setting on the selected panel.
- Press the Tab key to shift focus from one setting to the next, or Shift + Tab to go in the reverse direction.
- A check box can be checked or cleared by pressing the Spacebar or the + or - keys, respectively, while it is in focus.
- Columns of radio buttons can be navigated using the Up and Down arrow keys; rows can be navigated using the Left and Right arrows. Select a radio button by pressing the Spacebar while it is in focus.
- Settings in list boxes can be navigated using the Up and Down arrow keys. When a checkbox is in focus, it can be checked or cleared by pressing the Spacebar.
- Drop-down lists can be browsed using the Up and Down arrow keys. When the mouse pointer is directly over the drop-down, the mouse scroll wheel can also be used; on a Mac, the list must also be expanded. In Windows only, you can press Tab to select the highlighted item in the list and proceed to the next setting.
- Settings with spin control arrows  can be adjusted by typing in the text field or using the Up and Down arrow keys. When the mouse pointer is directly over the setting, the mouse scroll wheel can also be used.
- Slider bars  can be adjusted by typing in the text field or using the Left and Right arrow keys. When the mouse pointer is directly over the slider bar, the mouse scroll wheel can also be used.
- Line items in tables can be group selected using the Ctrl or Shift keys, or by pressing Ctrl+A.

- Press Enter on your keyboard to close most dialogs and apply your changes.

Note: Keyboard navigation in dialogs may vary somewhat depending on your computer platform.

In the Mac version of the software, Dictation is supported in dialogs. Select **Edit> Start Dictation**, then open a dialog. Say the word “Numeral” before a number to enter it as a numeric value or immediately follow a number with a unit such as “foot” to enter it as a measurement.

The units of measurement used in dialogs are determined by your choice of template files. See “Creating a New Plan” on page 38.

The number format used in dialogs are set based on your operating system’s defaults.

Math Operations in Dialogs

Basic addition, subtraction, multiplication, and division can be performed in the text boxes where numeric values are entered.

Note that settings for angle, pitch, or bearing do not support math, nor do those with spin controls or slider bars.

- To add, type the + character followed by the amount that you wish to add. Spaces are ignored and including a unit of measurement is optional.
- To subtract, type the - character followed by the amount you wish to subtract. As with adding, spaces are ignored and a unit of measurement is optional.
- To multiply, type the * character followed by the amount you wish to multiply by. Spaces are ignored, and only one of the

values being multiplied can have a unit of measurement.

- To divide, type the / character followed by the amount you wish to divide by. To divide, there must be a space before the / - if there is not, the input may be treated as a fraction. The denominator, or value typed after the /, cannot have a unit of measurement.

Math expressions support a single operation only: more than one operation character (+, -, *, /) at a time is not allowed.

Basic math operations can also be used to move objects using dimensions. See “Moving Objects Using Dimensions” on page 192.

Dialog Size and Position

Dialog boxes can be both moved and resized to suit your needs. By default, the program will remember both the position and size that you specify for a dialog and use it the next time you open it. You can specify whether the program does this always, per session, or never in the **Preferences** dialog. You can also reset the default sizes and positions. See “Reset Options Panel” on page 64.

- To move a dialog, position your mouse pointer within its title bar and then simply click and drag.
- To resize a dialog, position your mouse pointer on any edge or corner and then click and drag outward or inward. If you drag an edge, only that edge will move; if you drag a corner, the two adjacent edges will move.

When a dialog is resized, some elements within it may resize in response: for example, some list boxes and text fields.

Some elements within a dialog box can also be resized independently. See “Dialog Panel Splitters” on page 28.

Note that all dialogs have a minimum size limitation but no maximum size. If a dialog opens on a monitor with resolution too low to display its full extents, it will have vertical and/or horizontal scroll bars.

Note: Some of the dialog box images in the software documentation have been resized smaller than their actual minimum size.

Specification Dialogs



Each object in Home Designer Interiors has a unique specification dialog where you can enter size, style and other information specific to the selected object. To access it, select the object and click the **Open Object** edit button. You can also double-click on an object with the **Select**

Objects  tool active to open its specification dialog. See “Selecting Objects” on page 92.

Most objects also have a defaults dialog that lets you specify the initial values in the specification dialog.

Dialog Preview Panes

Many specification dialogs have a preview pane that shows how changes affect the selected object. This preview updates when you click in a different field or press the **Tab** key on your keyboard.

When you click in the preview pane, your mouse pointer changes to a four-headed

arrow and you can rotate around the object as well as zoom in and out using the mouse scroll wheel. Some objects, notably walls, doors, and windows, have Interior and Exterior labels to indicate which side is visible in the preview. Click the **Fill**

Window  button above the preview pane to zoom in or out so that the object fills the extents of the pane, maintaining the current rotation.

A selection of Rendering Techniques can be applied to the preview in most dialogs: Standard, and Glass House. See “Rendering Techniques” on page 398. Click the

Color  button to turn color in the preview off or on. Some objects have additional tools that affect object previews. For example, the **Cabinet Specification** dialogs have a **Select**

Cabinet Face Item  button. Object specific tools like this are discussed in the documentation for that object type.

Dialog Panel Splitters

Many dialog panels are divided into up to three sections: a list of panels on the left, an object preview on the right, and a central area where settings are located. The vertical splitters separating these sections each have a pale, dotted handle.

To resize the panel list or preview, as well as the area in the middle, move your mouse pointer over the vertical division line: when the splitter cursor  can be seen, click and drag to the left or right.

The Status Bar

The Status Bar at the bottom of the main program window displays information about the current state of the program.

This information depends on a variety of conditions such as the type of object selected, and the current position of the pointer. The information may include the following:

- The type of object currently selected or the total number of group-selected objects.
- A description of the edit handle that the pointer is over.
- A brief description of the toolbar button or menu item highlighted by the mouse.
- The name of the active tool and its hot-key, if it has one.
- The length and/or angle of an object as it is being drawn.
- The layer that the selected object is on.
- Basic information about a selected library object, folder, or catalog.
- The current floor.
- The size of the active window in pixels.

Message Boxes

As you work in Home Designer Interiors, the program will occasionally prompt you to examine your settings, alert you if you command it to do something that could potentially cause a problem, or notify you if it encounters a problem that needs your attention.

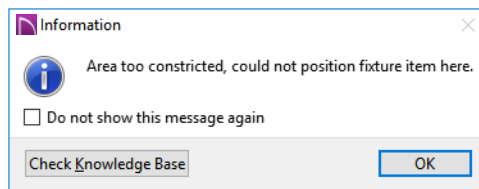

Situations where such message boxes may display include:

- Closing a file without saving;
- Modifying an object that is set to rebuild automatically;
- A file referenced outside the program, such as an image or texture, is missing;
- Creating an object in a space too small to contain it.

As with dialog boxes, you can access the options in a message box using the mouse or navigate them using the keyboard.

A few messages have a **Send Report** button. Click this button to send details regarding the issue that prompted the message to Chief Architect via the internet.

Some message boxes include a “Remember my choice” or a “Do not show this again” checkbox. Check this box to prevent messages of this specific type from displaying in the future. When this box is checked, some options in the message box may become inactive.

To allow all message boxes to display again, click the **Reset Message Boxes** button in the

Preferences dialog. See “Reset Options Panel” on page 64.

Preferences and Default Settings

Preferences and default settings control many aspects of the user interface and tool behavior in Home Designer Interiors. You can use these settings to customize the program to suit your personal work style.

For more information about defaults and preferences, see “Preferences and Default Settings” on page 53.

Preferences

Preference settings let you change program behavior to suit your workflow. For example, you can:

- Turn certain display elements on or off.
- Choose background and editing feedback colors.
- Set rendering specifications to maximize efficiency and quality.

Preference settings are global, affecting all plan files.

Defaults

Most objects in Home Designer Interiors derive their initial properties from their respective default dialogs.

For example, a newly placed **Window**  gets its initial values from the **Window Defaults** dialog and a newly placed **Hinged**

Door  gets its initial values from the **Door Defaults** dialog.

Once an object is placed in a plan, its initial properties can be overridden, but setting up your defaults before you begin drawing can save you considerable time as you build a model in the program.

Default settings, unlike Preferences, are file specific.

Dynamic Defaults

Most default settings are static: if you change one, any objects of that type in the current file will not be affected. A few defaults, however, are dynamic: they are tied to existing objects in the drawing and if you change the default, those objects may be affected. See “Dynamic Defaults” on page 55.

Drawing a Plan

When you draw a plan in Home Designer Interiors, you are placing 3D objects that represent building components. Home Designer Interiors comes with predefined

default settings so you can start drawing plans immediately. You should review these default settings to be sure they match your drawing and building methods. See

“Preferences and Default Settings” on page 53.

Set the Defaults

1. Specify the defaults for walls.
2. Set material defaults for roof, walls, and rooms.
3. Set style defaults for doors, windows, cabinets and other objects.

Draw the Floors

1. While the size of the drawing area in Home Designer Interiors is limited only by the resources on your computer, it is best to begin your drawing near the origin, 0,0,0. See “3D Drafting” on page 19.
2. Draw the exterior walls on Floor 1. See “Drawing Walls” on page 139.
3. Adjust the perimeter shape and size as required. See “Using the Edit Handles” on page 146.
4. Place any first floor bearing walls.
5. Define types for special rooms such as garages and decks in the plan. See “Room Types” on page 165.
6. Place perimeter doors and windows. See “Doors” on page 209 and “Windows” on page 225.
7. Build additional floors. See “Adding Floors” on page 289.
8. Specify the default ceiling height for each floor as soon as it is created. See “Floor Defaults Dialog” on page 288.

9. Adjust the perimeter shape of additional floors as needed. See “Editing Walls” on page 146.
10. Align edited or moved walls with those above or below where appropriate. See “Aligning Walls” on page 149.

Entering Dimensions

When using Imperial units, enter distances as inches or feet and inches, in fractional or decimal form. Millimeters are the default unit for all metric distances. See “Dimensions” on page 183.

- To enter feet, include the (') marker or the program assumes inches.
- In most cases, the program allows precision to 1/16th of an inch. Fractions with denominators 2, 4, 8 and 16 are allowed.
- The program usually converts decimals to fractions.

Build the Foundation

1. Derive the foundation plan from the first floor. See “Building a Foundation” on page 278.
2. Adjust the foundation perimeter shape as needed.
3. Place interior foundation walls as needed for the first floor bearing walls.
4. Place any other foundation walls required.
5. **Align with Above** as needed. See “Aligning Walls” on page 149.

Viewing Your Plan

You can see your model in a variety of different 2D and 3D views. You can display more than one view at a time; and in any view, you can pan or zoom in or out. See “Window and View Tools” on page 71.

Floor plan view is a 2D view of the model most commonly used for drawing and editing. Each floor displays separately; however, you have extensive control over which objects display at any given time, can easily switch between floors, and can also display items on a second floor for reference. See “Multiple Floors” on page 287.

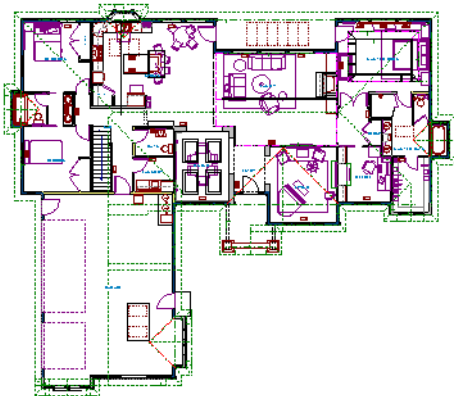

You can create interior and exterior 3D views of your model from any perspective. As in

floor plan view, you can select and edit many objects in 3D views and control which objects are visible. See “3D Views” on page 375.



You can also create **Doll House Views** that show only the current floor plus any floors beneath it. Ceilings on the current floor are omitted so you can see the interior, visualize the relationships between spaces, and plan traffic flow.



All views can be exported as a graphic image. See “To export a picture” on page 412.

Getting Help



There are many forms of help available in Home Designer Interiors including: Tool Tips, the Status Bar, and the online Help menu.

All these forms of help assume you have a basic working knowledge of your operating

system, including how to use a mouse, open, close and save files, copy, paste, and right-click to access contextual menus. Help also assumes you are familiar with basic computer terminology.

More information is available in the product documentation in electronic format and on Home Designer's official web site, www.HomeDesignerSoftware.com.

See "Additional Resources" on page 445.

Tool Tips

When you move the pointer over a toolbar button or menu item, a **Tool Tip** displays, offering a brief description of the tool. More information displays in the Status Bar at the bottom of the window.

Contextual Help



Online **Help** is a searchable menu that provides information about all of the tools in Home Designer Interiors. Select **Help> Launch Help** to open the program's Help and explore the table of contents, browse the Index, or Search for keywords.

The Help can also be used to provide instant information about toolbar buttons, menu items, and objects in your plan.

- When you move the cursor over a toolbar button or menu item, a brief summary of that tool displays in the Status Bar. Press the F1 key to open online Help to a page with more information about the tool.
- When an object is selected, edit handles display. Place the cursor over an edit handle and press **F1** to open online Help to a page with information about that handle.
- Press the **Help** button in any dialog box to open online Help to a page describing the options in that dialog.

Chief Architect strives to make our documentation as helpful as possible for all of our customers. Please send any suggestions to documentation@chiefarchitect.com.

About Home Designer

Select **Help> About Home Designer Interiors** in Windows[®] or **Home Designer> About Home Designer** in macOS[™] to view information about your software license, the

program's version number, and its release date.

Contact information for Chief Architect, Inc. is available on the MORE INFORMATION panel.

Product Upgrade Options

Select **Help> Product Upgrade Options** to launch your default web browser to the Home Designer web page,

www.homedesignersoftware.com, where you can learn about options for upgrading your software license.

Home Designer Trial Software



Free Trial versions of some Home Designer programs are available for download at www.HomeDesignerSoftware.com.

The Trial software offers the same functionality as a purchased license with a few limitations:

- File Saving
- Printing
- File Exporting
- Recording of Walkthroughs
- Printing or Exporting of Materials Lists
- Library Browser restrictions

Converting the Trial Version

An installation of the Home Designer Interiors Trial software can be converted into a full working version of the program at any time by purchasing a software license. There are several ways to begin this process in the Trial:

- Click the **Purchase Full Version Now** button in any Trial Restriction message box.
- Select **Help> Purchase Home Designer Interiors** .
- Select **File> Startup Options**  and then click the **Purchase Full Version Now** button.

Once you have purchased a license, you can activate it while the Trial software is running.

To activate the full version

1. Select **Help> Activate Full Version**.
2. In the **Product Activation** dialog, type or paste the **Product Key** associated with your software license.
3. Click the **Activate Full Version** button.

File Management

Home Designer Interiors saves the complete 3D model of a structure as well as any text and dimensions associated with the model in **.plan** files.

All commands related to opening, saving and closing plans are located in the File menu. You can also open plans from the **Startup Options** dialog. See “Startup Options” on page 18.

Just as with files created in other software applications, you should back up your plan files externally on a regular basis to avoid accidental loss of work.

Chapter Contents

- Compatibility with Other Programs
- Organizing Your Files
- Home Designer Interiors Data
- Creating a New Plan
- Saving, Exporting, and Backing Up Files
- Thumbnail Images
- Auto Archive
- Undo Files
- Opening and Importing Files
- Referenced Files
- Backup Entire Plan
- Closing Views and Files
- Exiting Home Designer Interiors

Compatibility with Other Programs

Plans produced in the following programs can all be read by Home Designer Interiors 2018.

- Chief Architect® X1 through X9 (limited editability if enabled)
- Chief Architect® 10.0 through 11.3 (read only)
- All Better Homes and Gardens Home Designer® products, Interior Designer, and Landscaping and Deck Designer, Versions 7 and 8.
- All Chief Architect Home Designer® products, Interior Designer, and Landscaping and Deck Designer, Versions 9 through 2017.

Files that have been opened and saved in Home Designer Interiors 2018 cannot be read by any of the program versions listed above. To continue to read files in the program in which they were created, be sure to create copies of your files before opening them in Home Designer Interiors 2018.

Plans produced in the Windows® version of Home Designer Interiors 2018 can be read in the Mac® version, and vice versa.

Opening Chief Architect Plans in Home Designer Programs

Plans created in Chief Architect Versions 10 through X9 and Home Designer Pro Versions 7 through 2018 can be opened in the latest Home Designer programs for viewing and annotating, but not for general editing or drawing of architectural objects.

Plans created in build 11.4 or later of Chief Architect X1 or Home Designer Pro 8, or in later program versions, can be set to allow limited editability in other Home Designer programs. When this permission is enabled, a Home Designer user can use all of their program's drawing tools and can edit objects in the plan that those tools can create. If an object cannot be created in the Home Designer program, however, it will not be editable.

Please note, too, that if a plan has more floors than the Home Designer program supports, the entire plan can be viewed and annotated only.

In addition, Chief Architect and Home Designer Pro have the ability to lock layers. Objects cannot be drawn on locked layers; objects on locked layers cannot be selected; and locked layers cannot be unlocked in the other Home Designer programs. See "Layers" on page 86.

Organizing Your Files

You should keep your plan files separate from the support files needed to run Home Designer Interiors. To keep files organized,

you may find it helpful to create a new folder for each project.

Home Designer Interiors files may use imported images, textures and other custom content saved in their own external data files. Consider storing copies of all external files in the same folder as the plan files that use them so that they are easily found.

Here is one way to organize your files:

- Create a folder in your Documents directory called “Home Designer Interiors Plans” or another name you prefer. See your operating system’s Help to learn how to create folders.
- Inside this folder, make a new folder for each project. Save all the files for that

project inside this folder, including plan files and referenced external files. See “Saving, Exporting, and Backing Up Files” on page 39.

Bear in mind, though, that path names exceeding 260 characters cannot be opened by Home Designer Interiors. As a result, it is a good idea to limit the number of embedded folders you use in your file organization method.

Once you understand the file management of Home Designer Interiors, you can decide on a naming convention that suits your needs.

Home Designer Interiors Data

When Home Designer Interiors 2018 is installed, the program automatically creates a folder in the user Documents directory called **Home Designer Interiors 2018 Data**. This folder contains important user-specific information saved in the following folders and files and should not be moved, renamed or deleted:

- **Archives** - A folder of automatically archived plan files. See “Auto Archive” on page 42.
- **Backdrops** - A folder of custom backdrop images. See “3D Backdrops” on page 380.
- **Images** - A folder of custom images. See “Adding Materials and Images” on page 338.
- **Database Libraries** - A folder of user library data. See “Library Content” on page 334.

- **Scripts** - A folder for custom Ruby scripts associated with Chief Architect plans.
- **Templates** - A folder of plan template files. See “Creating a New Plan” on page 38.
- **Textures** - A folder where you can save image files used to create custom material textures. See “Creating Materials” on page 369.
- **Toolbars** - A folder of toolbar files. See “Toolbar Arrangement” on page 67.
- **_MigrateBackup** - If you migrated legacy settings into version 2018, additional folders with names appended with **_MigrateBackup** may also be present. See “Migrating Settings and Content” on page 15.

 If the Home Designer Interiors 2018 Data folder is renamed, moved or deleted, the program will automatically replace it using default information from the Home Designer Interiors installation folder. When this occurs, customized user settings and custom user library content will not be available.

Because the Home Designer Interiors 2018 Data contains custom user data, it is not deleted when the program is uninstalled. See “Uninstalling Home Designer Interiors” on page 18 of the User’s Guide.

Creating a New Plan

 To open the **Create New Plan** dialog, select **File> New Plan**.

You can also choose **New Plan** in the **Startup Options** dialog. See “Startup Options” on page 18.

Template Plans

 When you select **File> New Plan** in Home Designer Interiors, the **Create New Plan** dialog opens, letting you select a template for your new plan. The resulting new plan uses either metric or Imperial units of measurement and predefined default settings for objects like walls, doors, windows, and cabinets.

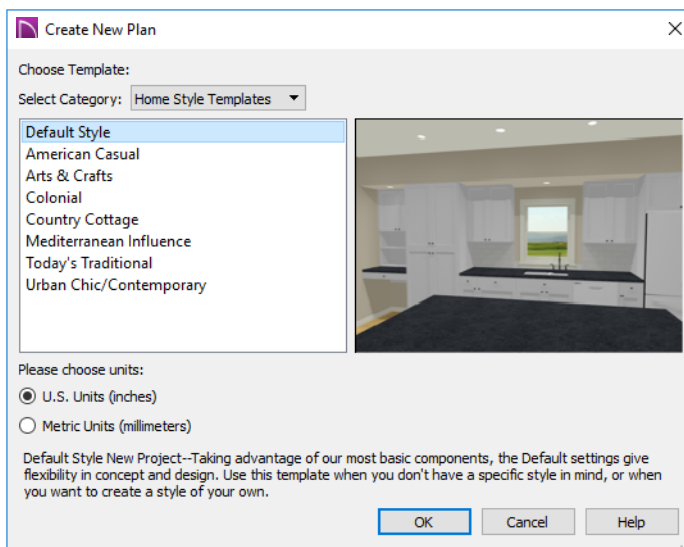

Home Designer Interiors includes a selection of plan templates, each with different default settings that allow you to begin working in a particular plan style quickly. See “Default Settings vs Preferences” on page 54.

Choose a category from the drop-down list, then select a style template from the scrollable list beneath it. If you are uncertain as to the right style for your plan, choose

Default, as you cannot change the plan style template once a plan has been created.

Select either **U.S. Units** or **Metric Units** of measurement, and click **OK**. The floor plan view window opens, ready for you to begin drawing.

New, blank plans are called **Untitled.plan**. Unless these files are named and saved, they will be lost when closed.

Saving, Exporting, and Backing Up Files

Saving, exporting, and backing up your files are three separate tasks that accomplish different things:

- Saving a plan file retains your work so that it can be later opened in Home Designer Interiors.
- Exporting a file allows you to save certain kinds of data in a format that can be used by a program other than Home Designer Interiors.
- Backing up your files involves taking steps to make sure that your valuable data is protected and available when needed.

Whether you are saving, exporting, or backing up your data, it is important that you select a location on your computer for the files you create, and also specify a short, meaningful name that you will be able to identify in the future.

To save an untitled plan file

1. Select **File> Save**  to open the **Save File** dialog.

2. Specify a location on your computer where you would like to save the file. See “Organizing Your Files” on page 36.
3. In the **File name** text field, type a name for the file.
4. Home Designer Interiors automatically assigns the **File of type** and file extension **.plan**.
5. When both the Save in location and File name are correct, click **Save**.







Although the program warns you if you try to exit without saving, you should get in the habit of saving plan files before exiting the program.



Saving Plan Files





When you first save a new, untitled file, you must select a location for it on your computer and give it a name. There are two options for saving plan files: **File> Save** and **File> Save As**.

Both **Save**  and **Save As**  can be used to save your plan files; however, they accomplish this in two different ways.

- **File > Save**  saves the current state of your plan file without changing its name and should normally be used for saving your work.
- **File > Save As**  opens the **Save File** dialog, allowing you to save the plan file using a different name or location on your computer.

Initially, all **Open**  and **Save As**  operations go to the “My Documents” folder of your computer. After that, the location last visited is remembered and subsequent

Open  or **Save As**  commands default to the directory last used for that operation. This path is saved when the program exits. The next time Home Designer Interiors is launched, these defaults are used.

Save File Dialog

The **Save File** dialog uses the operating system’s file save dialog format, and is also used when exporting files. The dialog name

may vary, depending on the type of file being saved or exported.

A similar **Select Folder** dialog allows you to select a folder to which files can be exported.

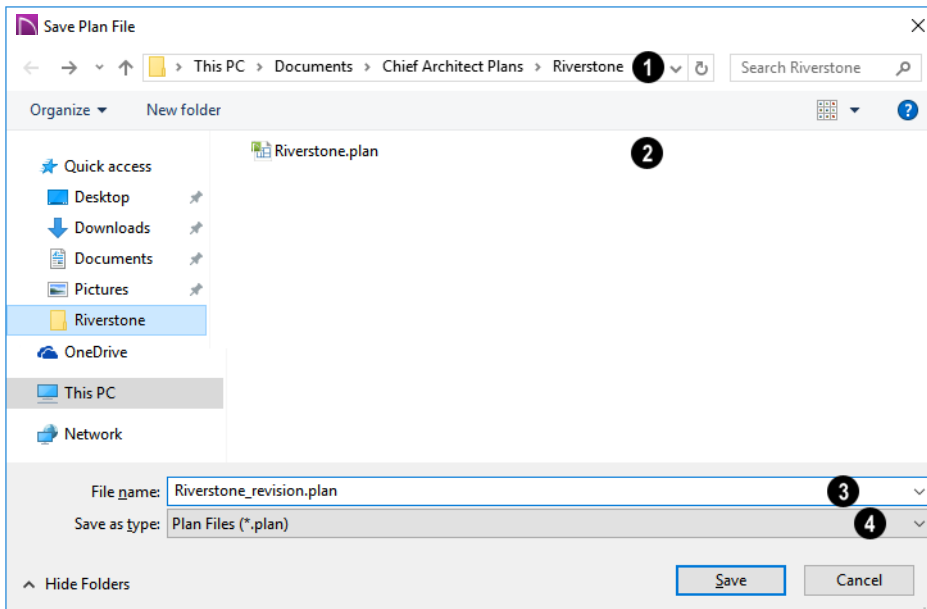

- 1 Choose a location on your local computer for the file you are saving.
- 2 Any existing folders and/or files in the current location display here.

- 3 In the **File Name** field, type a name for the file. If you select an existing file from the space above, its name will display here automatically.

4 When saving a file, the program will choose the appropriate file type from the **Save as type** drop-down list. When exporting, you may need to choose a specific file type.

Saving Revision Files

Revisions are a common aspect of any design project. There are a number of possible strategies for organizing revision files:

- Prepending the file name;
- Appending the file name;
- Saving revisions in separate folders.

To avoid confusion and potential mistakes, it is recommended that you always give files unique names - including revision files. If you choose to organize your revisions by saving them in separate folders, you should also give each file a unique name that makes it impossible to confuse it with another file saved in a different folder.

Exporting Files

Home Designer Interiors has a number of options for exporting and importing information out of and your drawings. See “Pictures, Images, and Walkthroughs” on page 405.

Often, file export dialogs are simply versions of the **Save File** dialog.

Similarly, file import dialogs are often similar to the **Open File** dialog. See “Importing Files” on page 45.

Backup Entire Plan

File> Save As  is a simple way to transfer a plan to a different location on your

computer. Bear in mind, though, that plan files often reference external data files such as imported textures, images, and backdrops. These external files are not affected when

Save As  is used.

If you transfer a plan file from one computer to another, the program will warn you of missing files if the external data files used by the plan cannot be found when you open it.

When transferring plans to another computer that does not have these external files, use

the **Backup Entire Plan**  tool. See “Backup Entire Plan” on page 47.

Backing Up Your Files

It is always a good idea to create backup copies of all your important files on your computer.

It is strongly recommended, however, that you never save directly onto removable media such as a USB thumb drive, CD, or DVD. Instead, copy your files to such locations only after you have saved them on your computer’s hard drive and exited the program.

Archive folders are used by Home Designer Interiors to manage prior versions of your files. You should not view these files as a substitute for your own backup routine, and should never save a file in an archive folder. See “Auto Archive” on page 42.

When backing up your Home Designer Interiors files, consider backing up not only your **.plan** files, but your custom user data, as well - including library content, toolbar configurations, and textures. This custom data is all located in the Home Designer Interiors Data folder, so it can be easily

backed up. See “Home Designer Interiors Data” on page 37.

You can, if you wish, create a folder inside the Data folder for your **.plan** files, as well. See “Organizing Your Files” on page 36.

Thumbnail Images

A thumbnail is a miniature image that helps identify a file in the **Open Plan File** dialog in Windows. Any view of a plan can be saved as the thumbnail.

The program automatically creates a thumbnail image when you first save a new plan. You can choose to generate small or large thumbnails.

To create a custom thumbnail image

1. You must save the file and give it a name before you can save a thumbnail.
2. Create the 2D or 3D view that you want to use as a thumbnail for the current file.
3. With the desired view active, select **File> Save Thumbnail Image** .

Thumbnail images are saved in the plan file that they are associated with.

Auto Archive

The first time a plan is saved, Home Designer Interiors creates an Archive folder in the Home Designer Interiors Data folder. The Archive folder contains Auto Save and Archive files.

The program does not create Auto Save and Archive files for untitled plans. In order for these to be created, a file must have been previously saved and given a name and save location on your computer. Further, Archive files are only updated when you save your work.

Auto Save and Archive files should not be viewed as a substitute for regularly saving your work by selecting **File> Save**  or pressing Ctrl + S on the keyboard, nor should they be considered an alternative to your own file backup routine.

Archive Files

Every time a drawing is saved, Archive files that keep a historical archive of your plan are automatically created or updated.



If you do not save your work regularly, your archive files will not be updated.

Plan files from previous versions of the program are automatically moved to the archive folder when the plan is opened and saved in Home Designer Interiors.



Archive files are meant to be for emergency use only. If you must access an archive file, open it as you would any other file. See “Creating a New Plan” on page 38. As soon

as the file is open, use **Save As**  to save this file to another location.

Legacy Archive Files

Plan files saved in the current program version are not backwards-compatible: that is, they cannot be opened in older versions of the software.

If you open a Home Designer plan file from a previous program version and immediately

Save  it (not **Save As** ) , the Auto Archive utility will create an additional archive file using the original program version format. This archive file is a copy of the original and can still be opened in the original program version.

Auto Save Files

As you work, Home Designer Interiors automatically creates Auto Save files at regular intervals when changes are made to a file but not saved by selecting **File>**

Save .

These Auto Save files are appended **_auto_save.plan** and are saved in the Archive folder.

When you close a file normally, its Auto Save file is retained until the next time the file is opened - at which time the Auto Save file is overwritten.

 JonesResidence_auto_save.plan

Auto Save file after normal shut-down

Auto save files created as a result of an improper program shutdown are appended **_auto_save_bak.plan**.

 JonesResidence_auto_save_bak.plan

Auto Save file after abnormal shut-down



If your computer shuts down accidentally, you can recover some of your work by opening the **_auto_save_bak** file.



A file is auto saved only if you have saved it previously. Auto Save does not work for unnamed files.



When you reopen a file after a computer shut down or system crash, the program will notify you if an Auto Save file newer than the original file is found and give you the option to one that file.

Even with Auto Save, you should save your work manually on a regular basis using any of the following methods:

- Click the **Save**  button.
- Select **File> Save** .
- Press Ctrl + S on the keyboard.

Undo Files

Home Designer Interiors stores a set number of copies of all open plan file changes, known as undo files. Undo files are referenced whenever you select **Edit>**

Undo  or **Edit> Redo** . See “Undo and Redo” on page 118.

Undo files are stored in your operating system's Temp directory. When Home

Designer Interiors is closed normally, any current Undo files are deleted.

Opening and Importing Files

Opening and importing files are often similar tasks, but accomplish two very different things:

- Opening a file refers to opening it in the program in which it was created. Only plan files can be opened in Home Designer Interiors. See “Compatibility with Other Programs” on page 36.
- Importing a file brings data that was created in a different program into Home Designer Interiors. A number of different

file types can be imported into Home Designer Interiors.



Select **File > Open Plan** to open an existing **.plan** file located on your computer. Home Designer Interiors automatically browses to the directory last used.



Before opening a file located on a removable storage device, server, or other computer on a network, copy it to your local machine's hard drive first.

Open File Dialog

The **Open File** dialog uses the operating system's file open dialog format, and is also used when importing files. The dialog name may vary, depending on your operating

system and the type of file being opened or imported.

A similar **Select Folder** dialog allows you to select an entire folder of files to import.

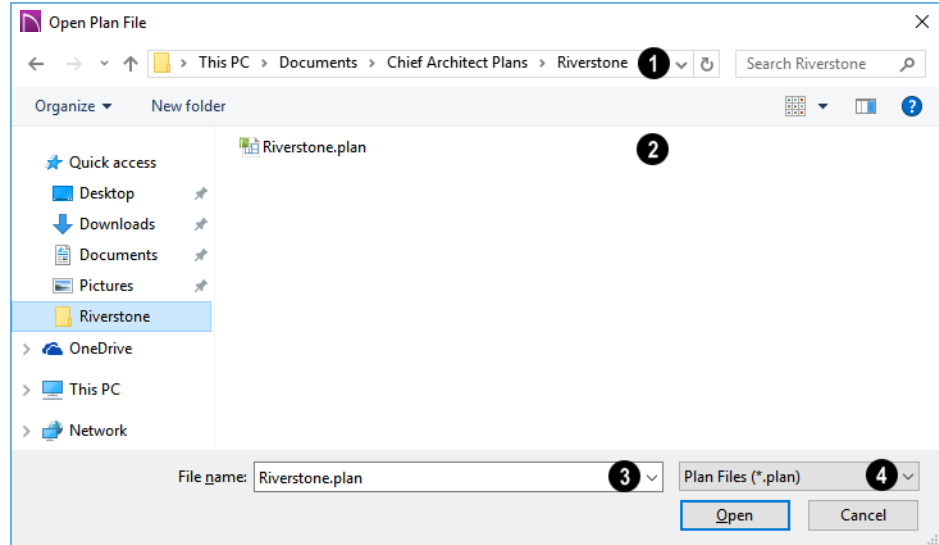

- ❶ Choose the location on your local computer for the file you are opening.
- ❷ Any existing folders and/or files in the current location display here.
- ❸ In the **File Name** field, type the file's name. If you select the file in the space above, its name will automatically display here. When importing some types of files, multiple files may be selected.
- ❹ When opening or importing a file, the program will usually choose the appropriate file type from the **Save as type** drop-down list. When importing, you may need to choose a specific file type.

Plan files open to the floor that was active when the file was last saved and closed.

Importing Files

Home Designer Interiors has a number of options for exporting and importing

information out of and into your drawings. Often, file import dialogs are simply versions of the **Open File** dialog. See “Pictures, Images, and Walkthroughs” on page 405.

Similarly, file export dialogs are often similar to the **Save File** dialog. See “Exporting Files” on page 41.

Import Room Planner File



Select **File > Import > Import Room Planner File**, then select and download a Room Planner file from the cloud. When prompted to log in, use the same credentials you used to save a plan to the cloud in Room Planner.

Files created in Room Planner versions 2 - 4.1 can be imported into Home Designer Interiors 2018.

Visit roomplanner.chiefarchitect.com for more information about the Room Planner mobile app.

Recently Opened Files

A list of recently opened and saved plan files can be accessed by selecting **File> Open Recent Files**. Select one of these files to open it without using the **Open File** dialog.

The names of recent files also display in the **Startup Options** dialog. Click on the name of a file to open it. See “Startup Options” on page 18.

Referenced Files

Home Designer Interiors plan files often reference a variety of external files for added detail, including:

- Material Textures
- Images
- Plant Images
- 3D Backdrops
- Picture Files
- PDF Files

Whenever any view in a plan is opened, the program checks for referenced files used in that view and will notify you if any of those files cannot be found by opening the **Missing Files** dialog.

You can also open this dialog at any time by selecting **Tools> Checks> Missing Files**. When accessed this way, all missing files associated with the current file are listed: not just those used in the current view.

Missing Files Dialog

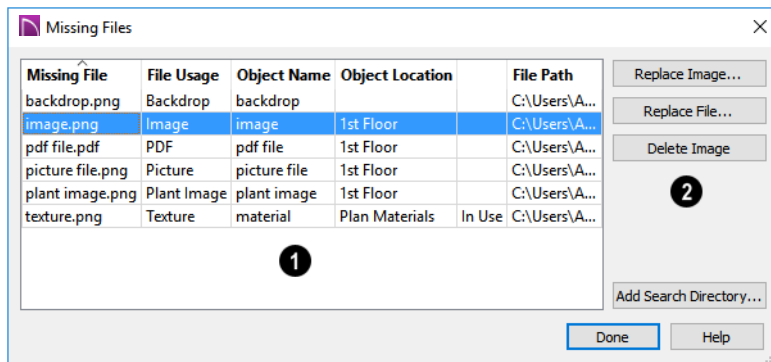

- 1 The table lists any Missing Files as well as useful information about each:
- Object Type indicates how the missing file is used in the program
 - **Object Name** states the name of the object in CA that references the file.

- **Object Location** indicates where in the file the object can be found.
- The next column indicates whether a missing texture is in use in the plan.
- **File Path** states the last known location of the missing file on your computer system.

Click on a line item in the table to select it and resolve it using the options on the right. Multiple line items can be selected; however, the selections on the right may be limited. See “Shift and Ctrl Select” on page 93.

2 The buttons on the right offer options for resolving a selected missing file. The names of these buttons will vary somewhat, depending on the type of file(s) selected in the list on the left

- Click the top **Replace Object** button to replace any instances of an object or material referencing the selected missing file with a different object or material from the library. Not available for PDF files or picture files.
- Click the **Replace File** button to open the **Browse for Missing File** dialog and select a file saved on your system to

replace the missing one. See “Opening and Importing Files” on page 44.

- Click the **Delete Object** button to remove the object or material referencing the missing file from the plan. Not available for material textures that are In Use.
- Click the **Add Search Directory** button to direct the program to a particular folder to search for missing files in. The list of Search folders can be reset in the

Preferences  dialog. See “Reset Options Panel” on page 64.

You can prevent this dialog from opening automatically by checking **Do not display missing files again during this session** at the bottom of the dialog. This option is not available when the dialog is opened manually.

Backup Entire Plan



Because Home Designer Interiors plans often contain many references to other external files, it is necessary to copy all the associated files to a new location when a plan is moved. You can do this easily by selecting **File> Backup Entire Plan**.

Backing up an entire plan is important when:

- Migrating legacy files created in older program versions.
- Transferring files to another computer or sending them to another user.
- Archiving or backing up your work.

To back up a plan

1. To copy all associated plan files to a new directory, select **File> Backup Entire**



Plan . The **Backup Entire Plan** dialog opens.

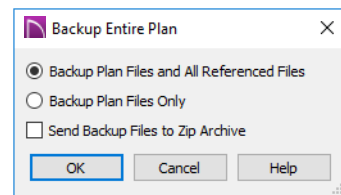

- Choose **Backup Plan Files and All Referenced Files** to copy the plan file and all externally referenced files such as inserted picture files, metafiles, and texture, image, and backdrop graphics files.
- Choose **Backup Plan Files Only** to copy any externally linked files and

inserted picture files, but no graphics or texture files. This is best used only when transferring a file to a computer that already has the graphics files installed.

- Check **Send Backup Files to Zip Archive** to save the files in a zipped folder instead of a regular folder.
 - Click **OK**.
2. The **Select the Plan Backup Folder** or **Choose Zip Archive to Backup** dialog opens next. This is a typical Save File

dialog. See “Saving, Exporting, and Backing Up Files” on page 39.

3. Navigate to a folder on your system and select it. If you did not opt to save the files in a zipped folder, the destination folder must be empty.
4. With the destination folder for the backup selected, click **OK**.
5. If the destination folder already contains files, the program will confirm whether you want to overwrite them.

Closing Views and Files

There are several ways to close a view window:

- Select **File> Close** to close the active window.
- Press **Ctrl + W** or **Ctrl + F4** on the keyboard to close the active window.
- Click the **Close** button in the active view’s title bar or in any view’s tab.
- A tabbed view can be closed by clicking on its tab using the middle mouse button.

- Select **File> Close All Views** to close all currently open view windows instead of just the active window.

If a plan has only one view window open and you try to close it, the program will prompt you to save before closing if there are any unsaved changes.



Although the program warns you if you try to exit without saving, you should get in the habit of saving plan files before exiting.

Exiting Home Designer Interiors

Select **File> Exit** to exit the program. If you have not saved any open plans, you are reminded to do so. It is better to save your work before exiting than to save on exit.

When you exit from the program using **File> Exit**, all Autosave files and Undo files are automatically deleted.

On a Mac, if you click the program window’s red **Close** button, the window will close but the program itself will continue to run. To close it down completely, right-click on its icon on the Dock and select **Quit** from the contextual menu.

Space Planning

The Space Planning Tools are a time-saving way to create a preliminary room-by-room design of a home without getting caught up in the details. Once the shape and layout of the rooms are finalized, the Build House tool

converts them into a working plan that can be edited and detailed to completion.

Chapter Contents

- Space Planning
- Room Box Specification Dialog

Space Planning



Select **Tools > Space Planning > Space Planning**. The **Space**

Planning Assistant leads you through a series of windows that gather information about the rooms you want to include in your house. When you click **Finish**, the selected room boxes display.

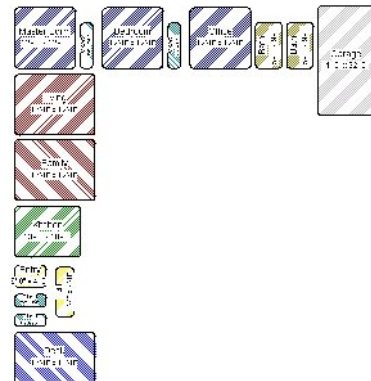

Room boxes can now be arranged into a floor plan.

Placing Room Boxes

In addition or as an alternative to the room boxes created for you by the **Space Planning Assistant**, you can create your own room boxes. To do so, select **Tools> Space Planning** , then choose the desired room type from the submenu. Click in floor plan view to place a room box of the selected type at that location.





Displaying Room Boxes

Room boxes and their labels are located on the “Space Planning Boxes” layer. Space Planning Box labels use the Text Style assigned to that layer, as well. See “Displaying Objects” on page 87.

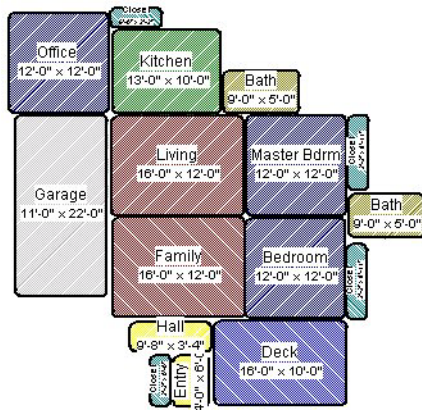
Editing Rooms

Once created, room boxes can be edited in a variety of ways.





- Select room boxes using the **Select Objects**  tool just like other objects in Home Designer Interiors. See “Selecting Objects” on page 92.
- Room boxes can be resized, rotated, and rearranged. See “Editing Box-Based Objects” on page 104.
- Try to line up the rooms so that they are just touching. Excessive overlaps may cause your rooms to form incorrectly. Closets are the exception. You can overlap a room with a closet, or place inside another room box.
- Rooms can be copied and pasted using the **Copy/Paste**  edit button and deleted using the **Delete**  edit button.
- Select **Tools> Space Planning**  to access the room box tools and place additional room boxes in your plan. Select a tool and click in the plan to place a room box of that type.
- Select **Tools> Space Planning> Toggle Room Boxes**  to hide or show the room boxes.

Build House

When the rooms are in place, select **Tools> Space Planning> Build House**  to convert the rooms into a building model. Walls and doors are inserted between the rooms that you arranged.

Multiple Floors

If you specified a two-story house, follow these steps:

1. Edit and arrange the room boxes on Floor 1 as desired.
2. Select **Tools> Space Planning> Build House**  tool to create the walls on the first floor.
3. Go **Up One Floor**  and notice that the positions of the walls on Floor 1 display in red as a reference.
4. Arrange the rooms on Floor 2 as desired, using the reference display as a guide.
5. On the second floor, select **Tools> Space Planning> Build House**  to complete the second floor.

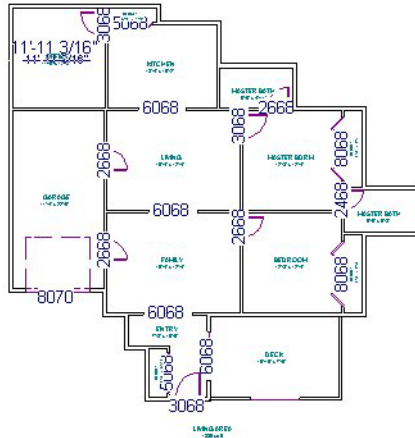

When you Build House, the “Space Planning Boxes” layer is automatically turned off. The room boxes that you created are not deleted, however.

Room Box Specification Dialog



Select a room box and click the **Open Object** edit button to open the **Room Box Specification** dialog.

General Panel

Most of the settings on the GENERAL panel are used when the selected room box is

converted to a room using the **Build House**  tool.

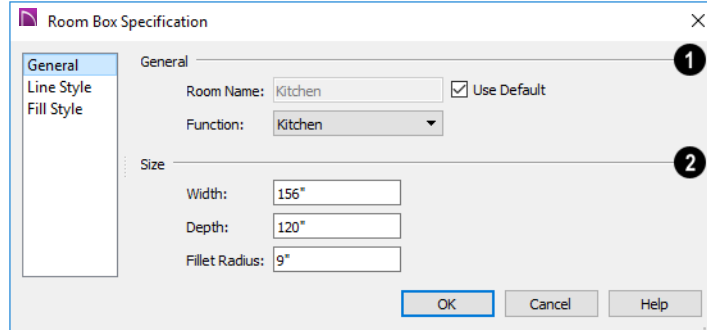

- 1 Specify the selected room box's **Room Type and Name**.
 - Select a **Room Type** from the drop-down list. See “Room Types” on page 165.
 - If you wish, uncheck **Use Room Type**, then specify a custom **Room Name** for the selected room box.
- 2 Specify the **Size** of the selected room box.
 - Specify the room box's **Width** and **Height**.
 - Specify the **Fillet Radius**, which is the radius of the curve on each of the room box's corners. Unlike the other settings on this panel, this value does not affect

the shape of the room created using **Build House** .

Line Style Panel

The settings on the **LINE STYLE** panel are available for a variety of other objects in the program. For information about these settings, see “Line Style Panel” on page 124.

Fill Style Panel

For information about the settings on this panel, see “Fill Style Panel” on page 129.

Preferences and Default Settings

Preferences are global settings that affect the functionality and appearance of the Home Designer Interiors environment, while default settings control what objects look like when they are initially created. You can save time by becoming familiar with these settings and customizing them before you begin a new drawing.

Chapter Contents

- Default Settings vs Preferences
- Dynamic Defaults
- Reset to Defaults
- General Plan Defaults Dialog
- Preferences Dialog

Default Settings vs Preferences

Default and preference settings have important effects on how the tools in Home Designer Interiors function. Default settings are file specific, while Preferences are global, taking effect regardless of what file is open.

Defaults and Preferences can be customized to suit your needs, so it is recommended that you become familiar with them and learn how you can use them to your advantage.

Default Settings



Default settings determine the initial characteristics of objects when they are first drawn. For example, when you place a base cabinet in a plan, its size, materials, front items, hardware are determined by settings in the **Base Cabinet Defaults** dialog.

Defaults are file-specific, which means that any changes that you make to the default settings in one plan file will have no effect on other plans.

You can access a complete list of the various default settings in the current plan file by selecting **Edit> Default Settings**  from the menu.

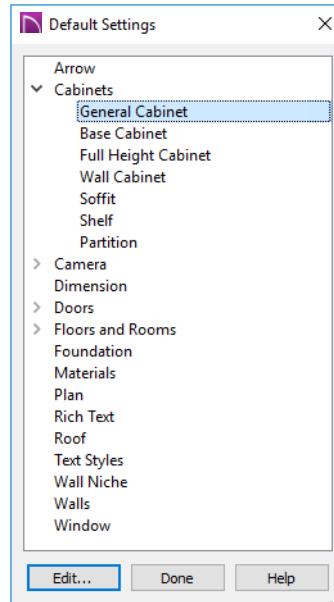

- Click the + beside a category to expand it and access the defaults for items related to that category.
- To open the defaults dialog associated with an item in the list, double-click on the line item, or click on the item and then click the **Edit** button.

Preferences



Preference settings influence the overall environment of the program, such as what the interface looks like and how the tools are accessed. See “Preferences Dialog” on page 57.

Unlike default settings, Preferences are global, which means that any changes that

you make to them will take effect in all plan files.

To access the **Preferences** dialog, select **Edit> Preferences**  from the menu.

Dynamic Defaults

Dynamic defaults are values that can be changed globally throughout a model.

- If you change a dynamic default value in a defaults dialog, all objects of that type that are set to use the default will update automatically to use the new value.
- Any objects of that type that are not using the default value because of editing will not be affected if you change the default.

Dynamic defaults are found in the default dialogs of a variety of objects, including dimension lines, walls, doors, cabinets and rooms.

Materials are another example of an attribute that uses Dynamic Defaults. See “Material Defaults” on page 362.

In object specification dialogs, dynamic defaults are followed by either a (D) in the value field or a Default checkbox.



The screenshot shows two sections of a dialog box. The first section, titled "Absolute Elevations", has four rows: "Floor Above (A):" with a text box containing "121 3/4\"", a checked "Default" checkbox, and an arrow pointing to the checkbox; "Ceiling (B):" with a text box containing "109 1/8\"", a checked "Default" checkbox, and an arrow pointing to the checkbox; "Floor (C):" with a text box containing "0\"", a checked "Default" checkbox, and an arrow pointing to the checkbox; and "Floor Below (D):" with a text box containing "0\"", a checked "Default" checkbox, and an arrow pointing to the checkbox. The second section, titled "Frame", has three rows: "Sides Width:" with a text box containing "3/4\" (D)", an arrow pointing to the "(D)", and a "Default" checkbox; "Top Width:" with a text box containing "3/4\" (D)", an arrow pointing to the "(D)", and a "Default" checkbox; and "Bottom Width:" with a text box containing "3/4\" (D)", an arrow pointing to the "(D)", and a "Default" checkbox.

To edit a dynamic default, delete the (D) or remove the check from **Default** box and type the desired value.

To reset a value back to the dynamic default, type the letter D in the field or click the Default checkbox.

Reset to Defaults

Select **Edit> Reset to Defaults** to open the **Reset to Defaults** dialog.

This dialog allows you to reset critical structural settings in the current plan to the default values.

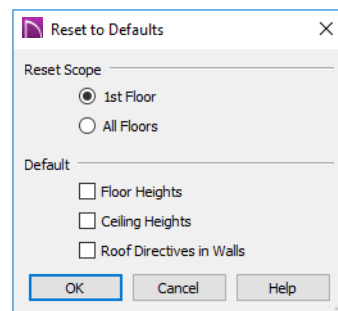

The screenshot shows the "Reset to Defaults" dialog box. It has a title bar with a close button (X). The dialog is divided into two sections. The first section, "Reset Scope", has two radio buttons: "1st Floor" (selected) and "All Floors". The second section, "Default", has three checkboxes: "Floor Heights", "Ceiling Heights", and "Roof Directives in Walls", all of which are unchecked. At the bottom of the dialog are three buttons: "OK", "Cancel", and "Help".

- 1 The settings can be cleared for the **current floor** or for **All Floors**.
- 2 Specify which settings you want to reset to **Default**.
- **Floor and Ceiling Heights** - Floor and ceiling heights for any room can be changed in the **Room Specification** dialog. Check to reset the default values as

specified in the **Floor Defaults** dialog. See “Floor Defaults Dialog” on page 288.

- **Roof Directives** - You can specify how the roof builds above an exterior wall in its **Wall Specification** dialog. When Roof Directives are reset, all items on the ROOF panel are unchecked and any value, such as the roof pitch, is reset to the default. See “Roof Directives in Walls” on page 323.

General Plan Defaults Dialog

The settings in the **General Plan Defaults** dialog control basic features of the Home Designer Interiors environment in plan files. Just as with other default settings, they are file specific, which means that they can be

set differently in individual plan files. To open this dialog, select **Edit> Default**

Settings , select **Plan**, and click the **Edit** button.

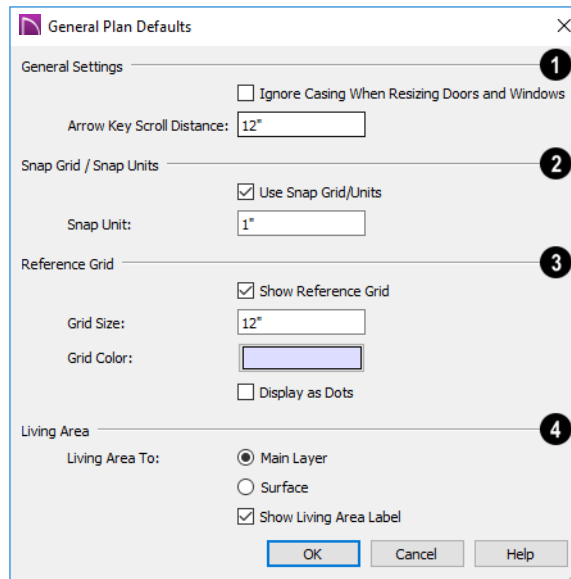

- 1 **General Settings** - Specify the default functionality for a variety of general behaviors in the program.

- Casing is the trim that surrounds a door or window. When you resize a door or window, its sides are kept away from inter-

secting walls by the width of the casing. Check **Ignore Casing for Opening Resize** to allow wall openings to be positioned against an intersecting wall. Clear this box retain sufficient space for the opening's specified trim width.

- The **Arrow Key Scroll Distance** setting determines how far to scroll in floor plan view when you press an arrow key. The initial default is 12 inches (300 mm). See “Using the Arrow Keys” on page 74.
- ② The **Snap Grid** allows you to snap objects to specific points on-screen as they are moved or resized. See “Grid Snaps” on page 79.
 - Check **Use Snap Grid/Units** to enable Grid Snaps.
 - Specify the **Snap Unit** you wish to use. The initial default is 1 inch (10 mm).
- ③ Specify the display of the **Reference Grid**.

- Check **Show Reference Grid** to display the Reference Grid, the virtual graph paper used to create a sense of scale in floor plan view.
- Specify the **Reference Grid Size**.
- Check **Display as Dots** to display the Reference Grid using dots rather than lines.
- ④ Specify how the **Living Area** label is calculated and whether it displays in floor plan view. See “Living Area” on page 171.
 - Select **Main Layer** to have the Living Area calculation measure from the walls' Main Layer.
 - Select **Surface** to have the Living Area calculation measure from the walls' exterior surface.
 - Uncheck **Show “Living Area”** to disable the display of the Living Area label.

Preferences Dialog



The settings in the **Preferences** dialog are global: they apply to all plan files and are preserved between sessions. To access this dialog, select **Edit> Preferences** in Windows® or **Chief Architect> Preferences** in macOS™. Unlike most dialogs in the program, it is not necessary to have a plan file open to access the **Preferences** dialog.

The **Preferences** dialog's list of panels is organized in a tree structure with categories and subcategories. A white arrow next to a

category indicates that it has subcategories. Click the arrow to make the subcategories visible or to hide them.

Preferences dialog panels:

- Appearance Panel
- Colors Panel
- Library Browser Panel
- General Panel
- Folders Panel
- Edit Panel
- Render Panel
- Video Card Status Panel
- Reset Options Panel

Appearance Panel

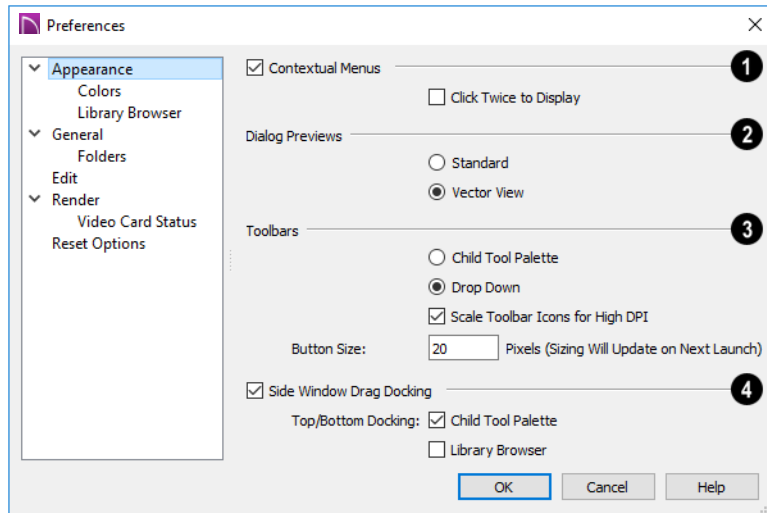

- 1 Check **Contextual Menus** to activate contextual menus that display when you right-click. See “Contextual Menus” on page 25.
- Check **Click Twice to Display** to require two right-clicks on an object before the contextual menu displays. This allows the first right-click to be used for object selection. See “Selecting Objects” on page 92.

In 3D views, the two clicks must be on the same object surface in order for the contextual menu to display: Clicking on two different surfaces of the same object is treated like two single-clicks.

- 2 Specify how **Toolbars** present child tools when a parent button is clicked.
- Choose **Parent-Child** to display child tools as buttons at the end of the toolbar where the parent button resides.

- Choose **Drop Down** to display child tools when the drop-down arrow to the right of the parent button is clicked.
- Uncheck **Scale Toolbar Icons for High DPI** to prevent toolbar icons from becoming larger on systems running Windows 7 or 8 and using high DPI resolution. When checked, toolbar buttons will increase in size when high DPI is used. Not available in the Mac version of the software.
- 3 Uncheck **Side Window Drag Docking** to prevent undocked side windows from docking when moved using the mouse. A side window can still be docked to its last docked location by double-clicking its title bar. See “View and Side Windows” on page 23.
- **Top/Bottom Docking** - Check the box beside a side window’s name to allow it to dock on the top and bottom edges of the program window. Does not affect docking to the left and right sides.

- Specify the desired toolbar **Button Size**, in pixels. Increasing this value will proportionally resize the text in the drop-down toolbars, as well. See “Toolbar Button Size” on page 69.

Colors Panel

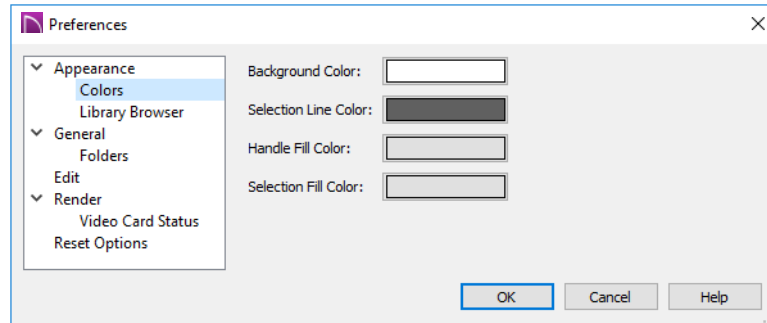

Click a color bar to open the **Select Color** dialog. See “Select Color Dialog” on page 372.

- Specify the **Background Color** for floor plan view.
The background color for 3D views that do not use a backdrop image is set in the **3D Backdrop** dialog. See “Backdrop Dialog” on page 376.
- Specify the **Selection Line Color**, which is the color of the lines that represent object(s) and their edit handles when they are selected.
- Specify the **Handle Fill Color**, which is the fill color of the edit handles for selected objects.
- Specify the **Selection Fill Color**, which is the fill color for selected objects. Note that depending on the fill assigned to a selected object, its Selection Fill color may vary.

Note: If the Selection Line and Handle Fill Colors are similar, it may be difficult to distinguish between active and inactive CAD Points.

Library Browser Panel

The LIBRARY BROWSER panel controls the appearance of the Library Browser window. See “The Library Browser” on page 330.

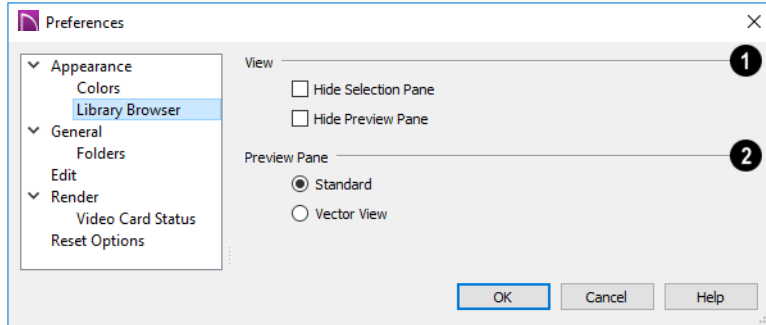

1 View options control the display of the main sections of the Library Browser.

- Check **Hide Selection Pane** to hide the pane that displays objects in a selected library or library folder.
- Check **Hide Preview Pane** to hide the pane that shows a preview of a selected object.

2 Specify whether selected library items in the **Preview Pane** are displayed using the **Standard** Rendering Technique or in a line-based **Vector View**. See “Rendering Techniques” on page 398.

To restore the original size and position of the Library Browser and other side windows, click the **Restore Side Windows** button on the Reset Options Panel.

General Panel

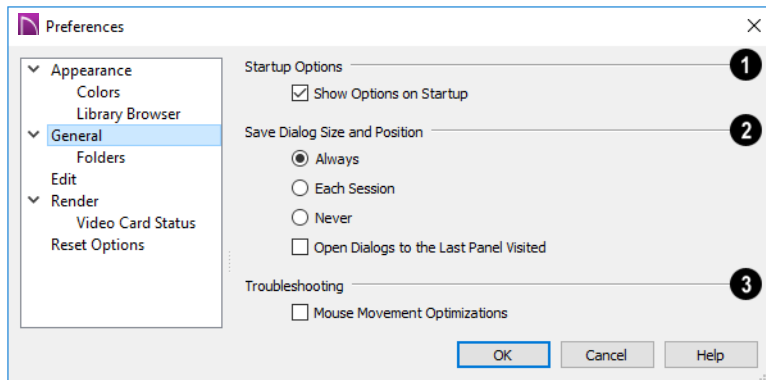

1 Check **Show Options at Startup** to open the **Startup Options** dialog when Home Designer Interiors is launched. See “Startup Options” on page 18.

2 Specify when the program should **Save Dialog Size and Position: Always, Per Session, or Never**. See “Dialog Size and Position” on page 27.

- Check **Open Dialogs to the Last Panel Visited** to open panelled dialogs to the last panel that you accessed during the current program session. When

unchecked, dialogs always open to the first panel. See “Dialogs” on page 26.

3 Troubleshooting -

- When **Mouse Movement Optimizations** is checked, zooming using the mouse scroll wheel is optimized for Mac systems. This box is checked by default and should only be unchecked when troubleshooting issues with the mouse scroll wheel in the Mac version of the software.

Folders Panel

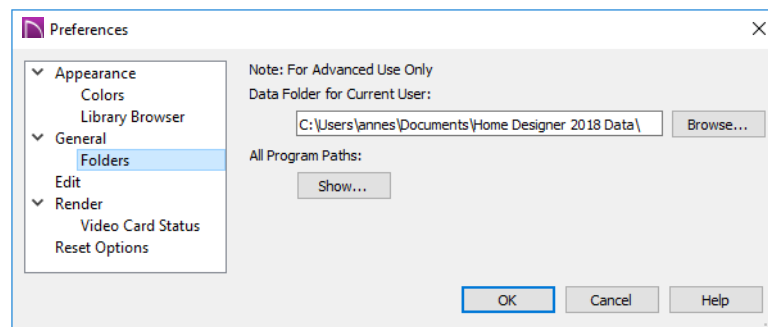

Important user-specific information is stored in the **Home Designer Interiors 2018 Data** folder, which is located in your Documents directory by default. See “Home Designer Interiors Data” on page 37.

While you cannot change the name of this directory, you can change its location. To avoid unexpected results, it is best to use a location on your local hard drive.

If you move this folder on your computer without specifying its location here, the program will automatically replace it using default information from the Home Designer

Interiors installation folder. The same result will occur if you specify a location on a network or removable device and this location becomes inaccessible. When this occurs, customized user settings will not be used and custom library content will not be available.

All Program Paths - Click the **Show** button to open the **Program Paths** dialog, where you can find the location of files that may be needed for troubleshooting purposes. See “Program Paths Dialog” on page 454.

Edit Panel

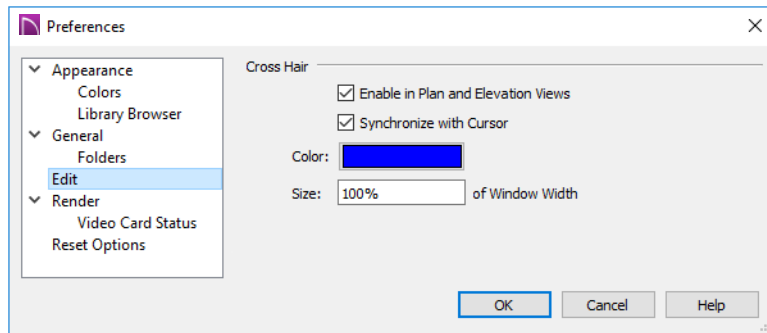

You can use a cursor with **Cross Hairs** and control its appearance.

- Check **Enable in Plan** to use a cross hair cursor in floor plan view. This option is checked by default.
- When **Synchronize with Cursor** is checked, the mouse pointer and cross hairs always move together on screen. If you feel that they do not keep up with your mouse movements, try unchecking this option.
- Click the **Color** bar to open the **Select Color** dialog and specify the color of the cross hairs.
- Cross hair **Size** is specified as a percentage of the view **Window Width**. Specify the **Size** as 100% to extend the cross hairs across the entire screen.

Render Panel

The settings on the **RENDER** panel control how 3D views are generated and navigated.

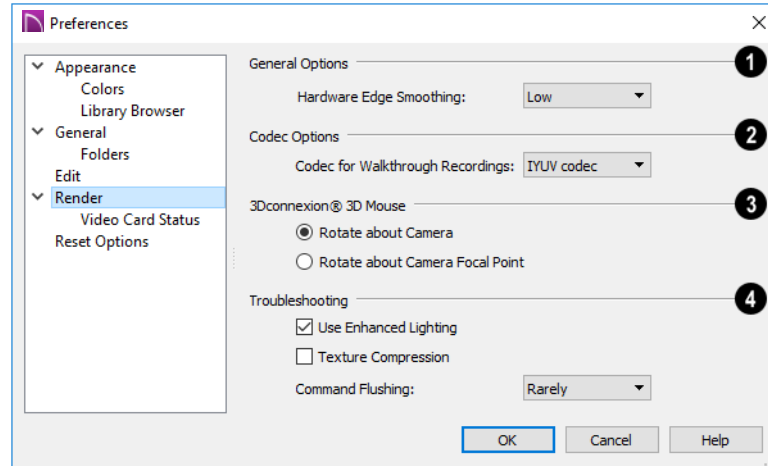

1 **Hardware Edge Smoothing** uses the video card to reduce the jagged appearance of angled surface edges, producing cleaner lines. The higher the smoothing effect, the longer the rendering time. See “Edge Smoothing” on page 395.

2 Select a **Codec for Walkthrough Recordings** from the drop-down list. By default, “IYUV codec” in the Windows version and “H.264” in the Mac version; but any other codecs that you may have installed on your system will also display in the list. See “Walkthroughs” on page 417.

3 The **3Dconnexion®** settings affect how 3D mice function in Perspective 3D views. See “3Dconnexion® 3D Mice” on page 382.

- Select **Navigate about Camera** to center mouse movement about the location of the camera.
- Select **Navigate about Camera Focal Point** to center mouse movement about the location of the camera’s focal point.

See “To create a camera view” on page 377.

4 The **Troubleshooting** settings can be used to troubleshoot performance in 3D views.

- Uncheck **Use Enhanced Lighting** to disable most lighting effects in Rendering Techniques that support lighting. This box is checked by default and should only be unchecked for troubleshooting purposes. It may become unchecked automatically if the program detects a problem with your video card. See “OpenGL and Hardware” on page 376.
- When **Texture Compression** is checked, material textures are compressed so that less video memory is required when a 3D view is generated. Texture Compression takes time, however, so view generation will typically be slower.
- **Command Flushing** - Select an option from the drop-down list to control how often the program flushes cached video memory. “Rarely” is selected by default

and will produce fastest rendering times on most systems, but “Frequently” may be helpful for older video cards.

Video Card Status Panel

The VIDEO CARD STATUS panel displays information about your video card, including the vendor and the OpenGL version it uses. See “OpenGL and Hardware” on page 376.

This information may be important if you are having problems generating 3D views.

Notice the **Max Lights** value. This indicates how many lights can be rendered in a 3D view. This value should be 8 or higher, depending on your video card. See “Lighting” on page 395.

Reset Options Panel

In order for some of the Reset Options to take effect, you will need to restart Home Designer Interiors.

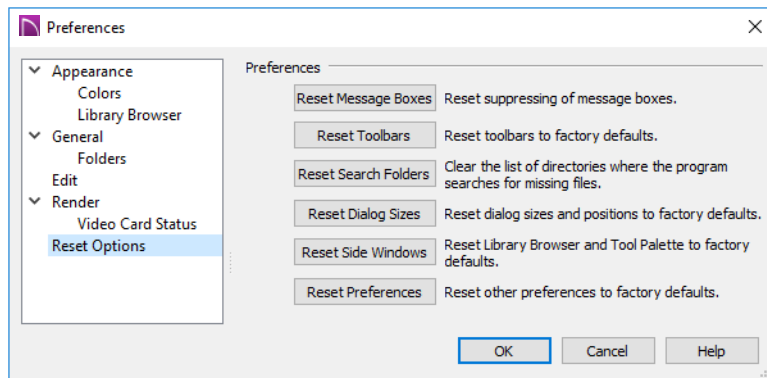

- If message boxes have been suppressed, you can make them display again by clicking **Reset Message Boxes**. See “Message Boxes” on page 29.
- Click the **Reset Toolbars** button to reset all toolbars to their original states. If you are encountering warning messages regarding toolbars, this option may resolve the issue. See “Toolbars and Hot-keys” on page 67.
- Home Designer Interiors retains a list of locations where you have located missing files in the past. If you find that the program takes a long time searching before informing you that files are missing, you can click the **Reset Search Folders** button to clear this list. See “Referenced Files” on page 46.
- Click the **Reset Dialog Sizes** button to restore all dialog boxes to their original

sizes and positions. See “Dialogs” on page 26.

- Click the **Reset Side Windows** button to restore all side windows to their original sizes and positions. Tool Palette Settings



are also reset. See “Side Windows” on page 23.

- Click the **Reset Preferences** button to restore all preferences to those originally installed with the program.

Toolbars and Hotkeys

Two of the most efficient ways to access Home Designer Interiors's tools are the toolbars and keyboard shortcuts, also referred to as hotkeys.

Chapter Contents

- Toolbar Arrangement
- Hotkeys

Toolbar Arrangement

Home Designer Interiors's toolbars provide fast access to the program's most commonly used tools and settings, and are organized so that related tools are grouped together and easy to find.



If a tool or setting is active, a small check mark will display at the lower left corner of its button icon.

The toolbars that display in a given view depend on the view type. For example, the toolbars that are available in floor plan and 3D views are not available in Materials Lists.

Some toolbars are available in more than one type of view. If a tool cannot be used in that view, its icon will appear pale grey in color.

Many of Home Designer Interiors's tools are organized into families of related tools which can be accessed using either of two styles of toolbar interface: the **Child Tool Palette** or **Drop Down** tools. You can select the interface that you prefer in the **Preferences** dialog. See "Appearance Panel" on page 58.

Drop-Down Tools

Click on the arrow to the right of a button to display a drop-down list of related tools. For example, click the arrow to the right of the

Window  button to display a drop-down list of the other Window Tools.

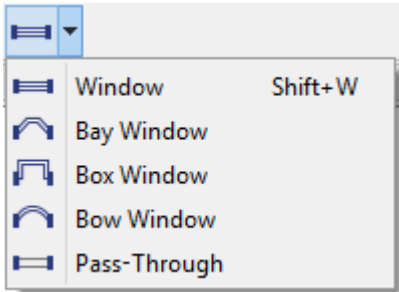

The most recently selected tool displays in the toolbar.

Child Tool Palette

An alternative to Drop-Down toolbars is the Parent button and Child Tool Palette interface. Parent toolbar buttons have a blue triangle in the lower right corner. When you select a Parent button, its Child tools display in the Child Tool Palette. If the Child Tool Palette has been closed, it will open.



By default, the Child Tool Palette is docked on the left side of the program window; but it can be undocked and moved, as well as resized and closed, just like other side windows. See “Side Windows” on page 23.

As long as it is open, the Child Tool Palette will also display the members of a selected tool’s family when the Drop Down interface is active. If you select a tool that does not belong to a family, the previously selected tool’s family will continue to display in the Tool Palette.

When you click the **Window Tools**  Parent button, for example, its Child buttons display in the Child Tool Palette.



Click the **Settings**  button at the bottom of the palette to select how the tools within it are presented:

- Select **Fit Palette**  to resize the palette so that it is one row wide.
- Select **Grid View**  to display only the button icons of the child tools in a grid that may have multiple rows, depending on the width of the palette side window.
- Select **List View**  to display child tools in a vertical list with each tool’s button icon and name in a row.

You can open the Tool Palette at any time, even when Drop Down tools are enabled, by selecting **View > Tool Palette**. See “View Tools” on page 72.

The Edit Toolbar

When you select an object, its edit toolbar opens. By default, it is located at the bottom of the program window, just above the Status Bar. The buttons on the edit toolbar can be used to edit the selected object. Which buttons display depends on the type of object selected, the current view, and how you selected the object.

Toolbar Button Size

By default, toolbar buttons are sized at 20 pixels, which works well on most computer monitors running default system settings. If you wish, you can increase or decrease this size in the **Preferences** dialog. See “Appearance Panel” on page 58.

Moving Toolbars

You can move any toolbar to a different location by clicking and dragging its dotted grab bar. Toolbars can be docked to any side

of the program window, or they can be undocked and left floating.

Undocked toolbars can be moved outside of the program window, and they can be closed completely. They can also be reshaped; however, they cannot be resized in such a manner that any buttons become hidden.

The location of moved toolbars is not saved between program sessions. The next time you use Home Designer Interiors, the toolbars will be back in their original locations.

Hotkeys

Many Home Designer Interiors tools have a keyboard shortcut, or hotkey, associated with them. If such a hotkey exists, it will display to the right of the tool’s name in the menu.



Edit menu items with button icons to the left and hotkeys to the right

To use a hotkey, simply press the appropriate key or combination of keys on your keyboard instead of selecting the menu item or clicking the toolbar button. For example, press the Ctrl and Z keys at the same time to perform an **Undo** .

Note: If a key or key combination is in use as a system hotkey, it cannot be used as a program hotkey.

Create Hotkey List

A list of the hotkeys available to the current program user can be saved in **.html** or **.xhtml** format.

Select **Tools> Create Hotkey List** to open the **Save Hotkey List File** dialog, a standard Save dialog, and create a hotkey list that can then be opened in a web browser window and printed, if you wish.

Window and View Tools

The View and Window Tools let you control how views of your drawing are shown on screen, as well as toggle useful drawing aides on and off.

There is no limit to the number of plan files that can be open. The name of the file and the type of view displays at the top of each view window in its title bar.

Chapter Contents

- View Tools
- Zoom Tools
- Undo Zoom
- Fill Window
- Panning the Display
- Working in Multiple Views
- Closing Views

View Tools

The **View Tools** allow you to open and close the program's side windows, as well as toggle a variety of references and drawing aides. Select the **View** menu to access these tools.



Refresh Display redraws the current window to clean up extra lines, show missing items, and correct random on-screen effects caused by changes to the model. See "Refresh Display" on page 110.



Library Browser opens and closes the Library Browser side window. See "The Library" on page 329.

Tool Palette opens and closes the Tool Palette, which will display related tools. See "Child Tool Palette" on page 68.



Scrollbars displays and suppresses scrollbars on view windows. See "View Windows" on page 23.



Color toggles the display of color in the current view. See "Color On/Off" on page 109.





Reference Grid toggles the display of the Reference Grid in all views in the current plan file. See "Grid Snaps" on page 79.

Zoom Tools



Zoom is used to magnify any given area on the plan or 3D view. Select **Window > Zoom**, then click and drag a marquee around an area on screen. When you release the mouse, the selected area expands to fill the screen.

Note that in 3D views, using **Zoom**  does not reposition the camera. This can lead to inconsistencies between a camera's position and what is actually shown in the view if other methods of zooming are used later. See "Repositioning Cameras" on page 380.

When the zoom is complete, whatever tool was active prior to selecting the **Zoom**  tool automatically becomes active again. If another zoom is needed, click the **Zoom**  tool again.



Zoom In - Click to zoom in towards the screen center by a factor of two.



Zoom Out - Click to zoom out from the screen center by a factor of two.



Undo Zoom - Reverse the last zoom operation.



Fill Window - Fits all visible items on screen.



Fill Window Building Only - Fits all walls and railings on the current floor on screen.

Zooming With the Mouse Wheel



Use the mouse wheel to zoom in and out in all view windows. Scrolling the mouse wheel one click up or down zooms in or out, centering on the

location of your pointer and changing the zoom by about 10%.

By default, zooming in 3D views changes the camera's position. See **“Mouse Scroll Wheel and Trackpad” on page 381**.

Note: Depending on the configuration of your mouse, it may be necessary to hold down the Ctrl key while turning the mouse wheel. If zooming in and out are not working correctly, contact the manufacturer of your mouse and mouse driver for their assistance.



Undo Zoom



Select **Window> Undo Zoom** to reverse the last zoom operation.

Note: Undo and Redo do not affect zoom.





Zoom  and **Undo Zoom**  are also available through the contextual menu. See “Contextual Menus” on page 25.

Fill Window



In floor plan view, select **Window> Fill Window** or press the **F6** key to view nearly everything on screen that is visible, including the Reference Display. CAD Points are the only objects that are not included when Fill Window is used.

If you are zoomed in so that only a portion of the drawing displays on screen, selecting **Fill**

Window  zooms out so that the entire view fits on the screen. If you are zoomed out so that the entire drawing is smaller than the screen, selecting **Fill Window**  zooms in until the drawing fills the screen.



When the drawing sheet is shown, **Fill Window**  zooms to the sheet borders.

Fill Window Building Only



Window> Fill Window Building Only is similar to **Fill Window**, but zooms in or out so that all walls and railings in the view fill the current window. Other objects are ignored.

In 3D Views

In 3D views, **Fill Window**  and **Fill Window Building Only**  adjust the camera's Field of View is adjusted so that all surfaces in the 3D view are included.

Panning the Display

There are four ways to pan the display without changing the zoom factor.

Using the Scroll Bars

One method is to use the scroll bars on the right and bottom edges of the window.

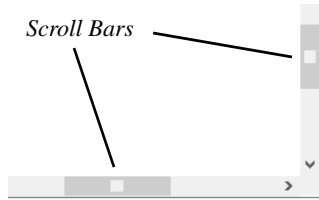

- Drag the square button in the bar itself in order to pan a larger distance.
- Click the end arrow keys on the scroll bars to shift the display in 12" increments.
- The 12" increment is defined in the **Plan Defaults** dialog under **Inches Scrolled by Arrow Key**. See “General Plan Defaults Dialog” on page 56.

Using the Arrow Keys

In floor plan view, the arrow keys on the keyboard work exactly like clicking the arrow buttons on the scroll bar. They shift the display according to the number of inches defined in the **Plan Defaults** dialog.

Using the Mouse

If you have a wheel mouse, you can pan the display by pressing the middle mouse button,

or wheel, and moving the mouse in the direction you would like to pan. When the middle mouse button is held down, the pointer changes to a hand  icon.

In the Mac version of Home Designer Interiors, you can pan using the left mouse button and Command key.

Mouse drivers sometimes have other functions assigned to the wheel and buttons. These override the Home Designer Interiors setting.



Using a Mac Trackpad

In the Mac version of Home Designer Interiors, you can two finger drag to pan the display. See “Using a Trackpad” on page 22.

Using the Pan Window Tool



The **Pan Window** tool works much like the mouse wheel method.

Select **Window > Pan Window** . The pointer changes to a hand  icon. Click and drag to pan the window. The program reverts to the previously active tool when you release the mouse button.

Working in Multiple Views

There is no limit to the number of plan files that can be open, nor is there a limit to the number of plan view windows that can be open. The name of the file and the type of

view is stated at the top of each view window in its title bar as well as in its tab.

By default, Home Designer Interiors uses a tabbed document interface, which means that

when more than one view window is open in the program window, each open window will have a tab that displays in a row above the currently active view.

- Each tab states the name of file the view type. Click on a tab to make it the active view.
- If there is not enough room in the program window to display all tabs, left and right arrow buttons allow you to scroll through the tabs.

- Tabs can be reordered by clicking and dragging.

There is no limit to the number of 3D view windows that you can have open at a given time; bear in mind, though, that each window demands use of your computer's resources and that you may see poor performance if too many views are open. See "3D Views" on page 375.

There are several ways to close a view window. See "Closing Views and Files" on page 48.

Tiling Views





As an alternative to tabbed views, windows can instead be tiled. Tiling allows you to display multiple views in a single Home Designer Interiors window

so you can see the results of changes in floor plan view in 3D or vice versa. It can also be useful for copying objects from one plan to another.



Floor plan view and a camera view Tiled Vertically

There are several ways to create tiled views:

- Click and drag a view window's title bar or tab into the part of the drawing area that you would like it to be. When a highlighted space is created, release the mouse button.
- Select **Window > Tile Horizontally**  to display views in a horizontal orientation, one above the other.
- Select **Window > Tile Vertically**  or press Shift + F6 on the keyboard to dis-

play views in a vertical, side by side, orientation.

Views are tiled left to right or top to bottom in the order in which they were last active: the most recent view is on the left or at the top, while least recent is on the right or on the bottom.



- To activate a view, click on its title bar or anywhere in the view window. Note that any changes you make in the active window are reflected in other views as well.
- To end window tiling, select **Window> Tab Windows**. You can also end tiling by double-clicking on the title bar of the program window.

Multiple Program Windows

To create a second program window, click and drag the title bar or tab of a view window completely out of the current program window: for example, onto a second monitor. A second Home Designer Interiors program window will be created with its own menu and toolbars.

Swapping Views

There are a number of ways to switch between open view windows:

- Click on a view window's tab.
- Select **Window> Select Next Tab**  or **Window> Select Previous Tab**  to cycle through all open views in the order you prefer.
- In Windows, press the Ctrl + Tab (Next Window) or Ctrl + Shift + Tab (Previous Window) keys to cycle through all open views.
- On a Mac, press the Ctrl + } (Next Window) or Ctrl + Shift + { (Previous Window) keys to cycle through all open views.
- A list of all the views currently open is located at the bottom of the Window menu. Each view is identified by its name and what type of view it is. A checkmark is beside the view that is currently active. Select one to go directly to that view.

If more than eight view windows are open, **More Windows** will be the last item in the Window menu. Select this option to open the **Select Window** dialog:

Select the name of a view in the list and click **OK** to make it the active view.

Closing Views

If a view is still needed, swap to a different view without closing the current views. If, however, a view is no longer needed, it can

be closed. See “Closing Views and Files” on page 48.

Creating Objects

There are a wide variety of objects in Home Designer Interiors that you can use to create 3D models and plan drawings. Although these objects are sometimes very different from one another, the methods used to create them are similar.

Once an object is created, it can be selected and edited to meet the requirements of your project. The editing characteristics common to most objects are described elsewhere. See “Editing Objects” on page 91.

Chapter Contents

- Architectural vs CAD Objects
- Snap Behaviors
- Object Snaps
- Angle Snaps
- Grid Snaps
- Creating Objects
- Copying and Pasting Objects

Architectural vs CAD Objects

There are two broad categories of objects in Home Designer Interiors: architectural objects and CAD objects.



Text, text lines with arrows, and dimensions are 2D CAD objects that can be created and edited in floor plan view but do not display in

3D camera views and overviews. See “Dimensions” on page 183 and “Text” on page 195.

In contrast, architectural objects such as walls, cabinets, doors, windows, and stairs display in 2D and 3D views.

Snap Behaviors

There are three categories of snap behavior in Home Designer Interiors that affect how objects are created and how they can be edited:

- **Object Snaps** , which snap objects to other objects.
- **Angle Snaps** , which snap objects at specific angles.

- **Grid Snaps** , which snap objects to points on a grid.

You can select **Edit> Snap Settings** to quickly turn Object, Angle and Grid Snaps on or off.

To temporarily disable Snap Behaviors and other move restrictions, press the Ctrl key while dragging an edit handle. See “Moving Objects” on page 110.

Object Snaps



Object Snaps allow you to position objects precisely relative to each other; for example, to position lines so that their endpoints meet.

Object Snaps can be turned on or off by selecting **Edit> Snap Settings> Object Snaps**.

There are many locations on an object that other objects can snap to.

- Object endpoints and corners
- The midpoints of object edges
- Object center points

- Intersection points where an object drawn at an allowed angle meets another object.

In addition, **On Object** snapping occurs anywhere on an object’s edges and is most noticeable when Angle and Grid Snaps are turned off.

When multiple objects are selected, the selection set’s only snap point is its midpoint.

Extension Snaps

Extension snaps allow you to snap to a point that is not actually on an object. Instead, these snaps locate points that are either

collinear to the end of a wall or orthogonal (at a 90° angle) to it.

Extension snaps function when you are drawing or editing walls and create a “sticky



point” where the wall being drawn reaches a point that is either collinear or orthogonal to another wall’s end point. See “Drawing Walls” on page 139.

Angle Snaps



It is often important that objects be drawn at exact angles. This can be accomplished using **Angle Snaps**. Angle Snaps allow you to draw walls, lines, and other objects at angles in 7.5° increments. Angle Snaps also affect the way objects rotate, the radius of arcs, and a variety of other operations.

Angle Snaps can be turned on or off by selecting **Edit> Snap Settings> Angle**

Snaps . When Angle Snaps are disabled, the Angle Snaps  icon will display near the mouse pointer.

Grid Snaps



Grid Snaps allow you to snap objects to points on an on-screen grid. This grid cannot be seen directly, but as you draw, move or resize an object, you can sometimes see it snapping at regular increments. See “Moving Objects” on page 110 and “Resizing Objects” on page 113.

The size of this Snap Grid can be controlled in the **Plan Defaults** dialog. See “General Plan Defaults Dialog” on page 56.

It is recommended that you draw and position the exterior walls of your plan with

Grid Snaps  enabled. Once these walls are in place, you may choose to turn Grid Snaps off to finish the rest of the drawing.

Grid Snaps are turned on and off by selecting **Edit> Snap Settings>Grid Snaps**  or in the **Plan Defaults** dialog.

In addition to the Snap Grid, the **Reference Grid** is provided to give you a visual sense of scale. The Reference Grid is composed of 12” x 12” squares and is useful for zooming in and out, or for general layout guidelines, but is not used for snapping. The Reference Grid can be toggled on and off by selecting **View> Reference Grid**. See “View Tools” on page 72.

Grid Snaps and Angle Snaps

Of the three snap behaviors, Grid Snaps have the lowest priority and are overridden by Angle Snaps and Object Snaps.

When Grid snaps and Angle Snaps are both enabled, objects are drawn and edited using Polar Coordinates. For example, if the grid **Snap Unit** is set to 12" (1 foot), drawing a new wall at an Allowed Angle snaps the wall length to 0", 12", 24", and so on.



To draw a line or wall at an Allowed Angle but with unrestricted length, disable Grid Snaps and leave Angle Snaps on.

Creating Objects

In Home Designer Interiors, there are three ways to create objects: by clicking to place an object, by clicking and dragging to draw an object, or by importing custom symbols, pictures or metafiles.

If you create an object using any of these methods and the layer it will go on is turned off, the program will ask you if you want to display the layer. See “Object Creation and Layers” on page 81.

While the size of the drawing area in Home Designer Interiors is limited only by the resources on your computer, it is best to begin your drawing near the origin, 0,0,0. The current position of your mouse pointer displays in the Status Bar at the bottom of the program window. See “3D Drafting” on page 19.

Click-to-Create

Many objects, including doors and windows, cabinets, library symbols, text, pictures, and images are created by clicking. Select a library object or one of the drawing tools mentioned above, then click in the drawing area to place the object at that location.

Continue clicking to place the selected object until another tool is selected.

If you click at a location where there is not enough room for the object to be placed, one of two things may happen:

- Some objects, notably cabinets, doors, and windows, will resize smaller to fit into the space.
- Most objects cannot resize in this manner, so the program will present a warning message indicating that there is not sufficient space at the current location.

When most drawing tools are active or library symbols selected for placement, a preview outline follows your mouse pointer, indicating the size and shape of the object to be created. If your pointer is positioned at a location where the object cannot be placed, this preview outline will not display.

As you move the mouse pointer, the center point of the object’s back edge will snap to active snap points when **Grid Snaps**  or **Object Snaps** are enabled. See “Snap Behaviors” on page 78.

Many architectural objects can be created in floor plan view or any 3D view. In order to place a stand-alone, click-to-create object in 3D, it is necessary to click near a wall as walls help orient the new object within the 3D space.

Clicking and Dragging

Other objects, including walls, railings, and straight stairs are created by clicking and dragging to define either a path or an enclosed area. Select a tool, then click and

drag in the drawing area to draw an object between your start and end points.

Continue drawing the selected object until another tool is selected.

You can temporarily slow the movement of the mouse as you drag by holding down the Shift key on your keyboard.

You can cancel any click-and-drag drawing operation before it is completed by pressing the Esc key on your keyboard, or by pressing any two mouse buttons at the same time.

Importing Objects

Custom symbols, pictures and metafiles can be imported into the program and placed in the drawing area with a click. See “Importing

3D Symbols” on page 419 and “Pictures, Images, and Walkthroughs” on page 405.

Object Creation and Layers

When it is created, every object is placed on a layer which controls whether and how it displays. See “Layers” on page 86.

If you try to create an object on a layer that is not set to display in the current view, the program will ask if you want to turn that layer on. See “Message Boxes” on page 29.

- Click **Yes** to create the object and turn on its layer in the current view.
- Click **No** to create the object but leave its layer turned off in the current view.
- Click **Cancel** to not create the object and leave the layer turned off.

Copying and Pasting Objects

New objects can also be created by cutting, copying, and pasting existing objects, either individually or in groups. Objects can be copied from one floor to another, one view window to another, and one file to another. Because copying uses your system’s clipboard, some objects can be pasted into other applications, as well.

 Objects created in an Imperial plan should not be pasted into a metric file, or vice versa. See “Template Plans” on page 38.

Objects cannot be pasted into any views that they cannot be created in normally. For example, text cannot be pasted into a 3D camera view or overview.

A few objects, such as camera symbols, cannot be copied.

Cut



Select **Edit> Cut** or press **Ctrl + X** to remove the selected object(s) from the file and save them in the system clipboard. To paste the selection in Home Designer Interiors or another application, select **Edit> Paste** or press **Ctrl + V** while in that application to enable the Paste function.

Copy



Select **Edit> Copy** or press **Ctrl + C** to copy the selected object(s) to the system clipboard. To paste the selection in Home Designer Interiors or another

application, select **Edit> Paste** or press **Ctrl + V** while in that application to enable the Paste function.

Paste



Select **Edit> Paste** or press **Ctrl + V** to enable Paste mode, then left- or right-click in the current view to paste the selected object(s) previously copied to the system clipboard at that location. If pasting from another application, click in the destination view in Home Designer Interiors first to make sure it is active.

Once pasted, these object(s) are selected. Objects pasted in 3D views are selected on their top surfaces.

If the selection being pasted consists of text, it is placed in a Text object.

Copy/Paste



Click the **Copy/Paste** edit button to copy the selected object(s) to the system clipboard and immediately enable the

Paste function in Home Designer Interiors.

The **Copy/Paste** edit button activates Paste mode in which each available edit tool and handle makes a copy in addition to its primary function and two new edit buttons display on the edit toolbar.

- Click the **Sticky Mode** edit button remain in the current mode and place multiple copies of the selected object(s).
- Click the **Main Edit Mode** edit button or press the Esc key to return to the selected object's main edit toolbar.

If you paste a selection in a file other than its original source file, when you return to the original, Paste mode is still enabled.

The **Copy/Paste** edit button can be used with the edit handles in either of two ways: by clicking or by dragging an edit handle.

To Copy/Paste by clicking

1. Select an object or objects to copy.
2. Click the **Copy/Paste** edit button, select **Edit> Copy** from the menu or press **Ctrl + C** to copy and then **Ctrl + V** to activate the Paste functionality. The cursor displays the Copy/Paste icon.
3. If you wish to paste the copy in a different view or program window, open that window.
4. If your cursor does not display the Copy/Paste icon, select **Edit> Paste** from the menu or press **Ctrl + V**.
5. Left- or right-click once to paste a copy of the object at that location.

To Copy/Paste by dragging



1. Select an object or objects to copy.
2. Click the **Copy/Paste** edit button, select **Edit> Copy** from the menu or press **Ctrl + C**. The cursor displays the Copy/Paste icon.
3. Drag an edit handle:
 - Drag the Move edit handle to position the copy at a new location.
4. You can position the copy accurately with respect to the original by watching

the moved distance in the Status Bar at the bottom of the screen.

Sticky Mode

 Normally, after an action is performed using the edit tools or handles while in an edit mode such as Paste mode, you return to the Main Edit Mode. Click the **Sticky Mode** edit button to remain in Paste mode and continue pasting copies of the selected object(s).

To exit Paste mode and return to the main edit toolbar for the selected object, click the

Main Edit Mode  edit button or press the Esc key on your keyboard. If you have not pasted a copy of the selected object and immediately click **Copy/Paste**  after returning to the Main Edit Mode, **Sticky Mode**  is still enabled.

Copy and Paste in Place

 Click the **Copy and Paste in Place** edit button to create a copy of the selected object(s) at the same location as the original. The copy remains selected so you can perform additional operations.



Because multiple walls, railing and fencing cannot share the same space, the **Copy and**

Paste in Place  edit button is not available for these objects.

Paste Hold Position

 When copying between different floors or view windows, you can paste a copy at the same absolute position as the original selection using **Paste Hold Position**.

To use Paste Hold Position

1. Select the object(s) to be copied.
2. Click the **Copy/Paste**  edit button.
3. Switch to the desired floor or plan file and select **Edit> Paste> Paste Hold Position** .
4. A copy is placed at the same X, Y coordinates on the new floor or in the new plan as the original's position.

Paste Special

 The **Paste Special** tool allows you to choose a representation for the selection to be pasted.

Selections can be pasted as:

- Enhanced Windows Metafiles (EMF). See “Metafiles” on page 413.
- Device Independent Bitmaps (BMP). See “Importing Pictures” on page 412.
- Unformatted non-unicode text (TXT).
- File Name (a path to a file). Depending on the file type, it will be either opened or imported (if supported).
- Unformatted text (HTML). Pastes as text.
- Model Objects - Home Designer Interiors format, not compatible with other programs.

To use Paste Special

1. Select an object, image, text or file on your computer and copy it.
2. Switch to the desired Home Designer Interiors view window and select **Edit> Paste> Paste Special** .

3. In the **Paste Special** dialog, select the desired representation for the selection and click OK.
4. Click in the drawing area to place the copy at that location.

Copy Region as Picture



The **Copy Region as Picture** tool allows you to copy any portion of the screen and save it as a picture. See “Copy Region as Picture” on page 415.

Displaying Objects

The way that objects display is an important in all stages of the design process. There are two primary ways that the display of objects is controlled: Drawing Groups and Layers.

Chapter Contents

- Drawing Groups
- Layers
- Layer Sets
- Display Options Dialog

Drawing Groups

Each object in a plan file belongs to a Drawing Group, which influences whether it displays in front of or behind other objects. Drawing Groups control the display of objects in floor plan view but in camera views and overviews.

Most categories of objects have their own Drawing Group; however, a few objects are instead placed in the Front or Back Group. Imported pictures, which are placed in the Back Group, are a notable example.

Within a given Drawing Group, drawing order is determined by the order in which objects are placed. By default, an object will display in front of any objects that were created before it was. For example, if you place a chair and then a table, the table will display in front of the chair; if you instead place a table and then the chair, the chair will display in front.

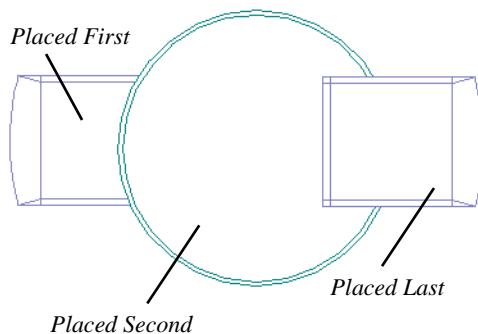

Drawing order also affects how objects are selected. If two objects are positioned so that they overlap one another, and you click at a point that they both share, the frontmost object will become selected first. See “Select Next Object” on page 93.

Drawing Group Edit Tools

 Once an object has been placed, its position in the drawing order can be modified. To do this, select one or more objects and click the **View Drawing Group Edit Tools** edit button.

 Click the **Send Backward** edit button to move the selected object(s) to the back of its current Drawing Group. If it is already at the back of its current group, it will be moved to the next group down in the drawing order.

 Click the **Bring Forward** edit button to move the selected object(s) to the front of its current Drawing Group. If it is already at the front of its current group, it will be moved to the next group up in the drawing order.

Layers

Layers are used to organize and manage the display of all objects in all views. A layer can

be thought of as a transparency sheet with objects placed on it for viewing. Nearly all

views use multiple layers, like a stack of transparencies put together to show different types of objects.

You can find out which layer an object is on by selecting the object and looking at the Status Bar. And, you can customize how

each layer displays in a particular view in the **Display Options** dialog.

Multiple layers are organized into Layer Sets, which allow you to control which objects display in different views.

Displaying Objects

The display of objects in different views is controlled by layer sets and layers in the **Display Options** dialog. See “Display Options Dialog” on page 88.

Primary and Secondary Layers

Every object is placed on a layer which controls whether it displays in a given view. This layer is referred to as the object’s primary layer, and you can see its name in the Status Bar when the object is selected. See “The Status Bar” on page 29.

In addition, some objects have secondary layers which may alter the appearance of objects on the primary layer, but do not control whether the objects display or not.

For example, the primary layer for base cabinets is “Cabinets, Base”. In addition, base cabinets have a number of secondary layers that control the display of the countertop, face indicators, door opening indicators, module lines and labels.

Note: If an object’s primary layer is turned off, information on its secondary layers will not display - even if those layers are turned on.

All layers with a check in the “Disp.” column display when the current layer set is active. Objects that are not displayed cannot be seen or selected. If you try to place or draw an object on a layer that is hidden, the program asks if you want to turn the layer on.

Name	Disp
Architectural Blocks	<input checked="" type="checkbox"/>
Architectural Blocks, Labels	<input type="checkbox"/>
Audio/Video	<input checked="" type="checkbox"/>
Auto Dormers	<input checked="" type="checkbox"/>
Cabinets, Base	<input checked="" type="checkbox"/>

Some objects cannot stand alone in a drawing: they can only be inserted into another object. If the display of an object that contains an inserted object is turned off, the display of the inserted object will be turned off, as well. For example, if the display of a wall is turned off, any doors and windows in that wall will not display either. See “Inserted Objects” on page 343.

The **Color** attribute assigned to a layer determines how the lines representing objects on that layer appear in floor plan view.

A few objects, notably text, allow you to override the line color without changing the layer’s color attribute.

Layer Sets

Layer Sets are used to control the layer settings for different views in a plan file.

A layer set consists of a complete list of the layers in the current plan along with the display settings for each layer as set for a particular type of view. These display settings can be modified, and can be different for each type of view. See “Display Options Dialog” on page 88.

Layer sets are file specific, which means that changes made in one plan file have no effect on the settings in other files.

Home Designer Interiors uses a different layer set for the each type of view of your plan:

- Floor plan view.
- Camera views and Doll House Views. See “3D View Tools” on page 377.
- Reference Floor. See “The Reference Floor” on page 293.

While any view is active, select **Tools>**

Display Options  to make changes to the layer set used for that view type.

Any changes made to settings in the **Display Options** dialog for one particular view will affect all views using that same layer set. For example, if you make changes for a camera view, all camera views and overviews in the current plan will be affected. See “Display Options Dialog” on page 88.

Display Options Dialog



The display of objects in all views is controlled in the **Display Options** dialog. To make changes to the display settings for a particular type of view, open a view of that type and select **Tools> Display Options**.

If the display of a particular layer is turned off and an object assigned to that layer is placed in the plan, the program will automatically ask you if the layer should be turned on so that the new object will be visible. After you make your choice, the object will be created - even if you select “No.”

Only displayed objects are included when EMF files are exported, and only displayed objects print.

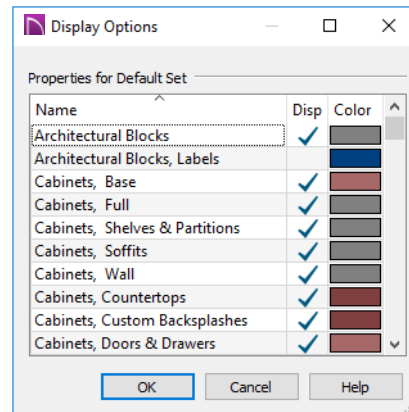

The **Properties** for the layer set that is active in the current view are presented in a table of layers and their attributes. See “Layer Sets” on page 88.

- Click on a column header to sort all layers by that column. Click again to sort in reverse order.
- Remove the check from the “Disp.” column to turn off the display of a category of objects in the current view.
- Click a color bar to open the **Select Color** dialog and set the display color for objects on that layer in floor plan view. See “Select Color Dialog” on page 372.
- Click the size grip at the lower right corner and drag to resize the dialog box.

Note: Not all objects display in all views. For instance, invisible walls do not appear in camera views or materials lists.

Editing Objects

Just as the methods used to create different objects in Home Designer Interiors are similar, the options for moving, rotating, resizing, and otherwise editing them are also alike.

Edit handles allow objects to be resized, relocated, or rotated using the mouse. Edit toolbar buttons and the contextual menus access edit tools relevant to the selected object(s). Most objects have a specification dialog that allows you to edit it in ways that are specific to that type of object.

The editing characteristics common to most objects are described in this chapter. Unique, object-specific editing behaviors and the specification dialogs are covered in their respective chapters.

Chapter Contents

- Selecting Objects
- Editing Line Based Objects
- Editing Arc Based Objects
- Editing Open Polyline Based Objects
- Editing Closed-Polyline Based Objects
- Editing Box-Based Objects
- Editing Spline Based Objects
- Editing Circles, Ovals and Ellipses
- Displaying Objects
- Moving Objects
- Aligning Objects
- Resizing Objects
- Reshaping Objects
- Rotating Objects
- Matching Properties
- Deleting Objects
- Undo and Redo

Selecting Objects

“Select” refers to selecting an object for editing. An object must be selected before it can be edited.

In order for an object to be selected, it must be visible in the current view. See “Layers” on page 86.

When an object is selected, it displays edit handles and a grey selection fill color. In 3D views, a selected object will also display lines representing the selected edge or surface. The size of the edit handles does not change as you zoom in or out. To prevent them from stacking on one another, some edit handles may not display as you zoom away from the selected object.

When an object is selected, its edit toolbar also displays, typically on the upper left side of the Home Designer Interiors program window. See “The Edit Toolbar” on page 24.

Information about the selected object or objects may also display in the Status Bar. See “The Status Bar” on page 29.

A selected object remains selected until another object is selected, a different tool is activated, the Esc key on the keyboard is pressed, or any two mouse buttons are pressed at the same time.



Select Objects



Any object created using Home Designer Interiors can be selected using the **Select Objects** tool. Select **Edit > Select Objects**, click the toolbar button or press the **Space** bar on your keyboard to activate this tool, then click on an object to select it.

You can also select objects or open context sensitive menus using the right mouse button when any tool is active.

Selecting Similar Objects

If a tool other than **Select Objects**  is active, you can only select objects of that type using the left mouse button. For example, if the **Straight Exterior Wall**  tool is active, you can only select walls using the left mouse button.

This can be useful for selecting an object when many objects of a different type occupy the same space in floor plan view.

Objects can be selected using the right mouse button, regardless of which tool is active.

Right-Clicking

Regardless of which tool is active, you can select an eligible object by right-clicking on it once. When you right-click to select an object a contextual menu also appears, displaying the object’s edit tools. See “Contextual Menus” on page 25.

If a drawing tool is active and you right-click to select an object, you can unselect it by left-clicking in an empty space in the drawing area. Although a drawing tool is active, it is not used. If you then left-click a second time, the active tool will be used.

Selected Edge

When you click on a polyline- or box-based object, the edge that you click nearest becomes the selected edge and displays an

edit handle larger than those on other edges. The handle on this edge may also display at the point where you clicked to select it.

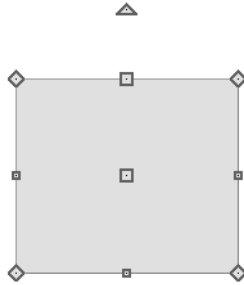

This edge can be edited on the **SELECTED LINE** or **SELECTED ARC** panel of the object's specification dialog. See "Moving Objects Using Dimensions" on page 192, "Selected Line Panel" on page 318 and "Selected Arc Panel" on page 319.

Select Next Object



If there is more than one object in a particular space, it may be difficult to select the desired object. When a nearby object is selected, click the **Select Next Object** edit button or press the Tab key until the desired object becomes selected. This function cannot be applied to groups of selected objects.

Marquee Select

Groups of objects can be selected by holding down either the Shift or Ctrl key when the **Select Objects**  tool is active and then dragging a marquee around the objects to be selected. An object does not need to be completely enclosed by the marquee to be selected: it will be selected if the marquee includes only a small portion of it.

If an object is currently selected and a selection marquee is drawn around it, that object becomes de-selected. If an object is currently selected and a marquee is drawn around other objects, the original object remains selected and the other objects are added to the selection set.

When using the marquee-select method, both text and architectural objects included in the marquee are selected. To remove an object from the selection set, hold down the Shift key and click it.

The Shift key can also be used to marquee-select objects of a similar type. For example, click the **Hinged Door**  child button, hold down the Shift key, drag a marquee, release the mouse button, and only door objects within the marquee are selected. The Ctrl key will always marquee-select objects of all types, regardless of the active tool.



To make marquee selection easier, you can turn off the display of objects you do not want to include in your selection set. See "Displaying Objects" on page 87.

Shift and Ctrl Select

You can select a group of objects by adding them to the selection set one by one. Select an object, hold down either the Shift or Ctrl key, and click additional objects to select them.

More than one type of object can be selected using this method, but the ability to edit the group-selected items is limited to attributes that all selected objects have in common.

To remove an object from a selection set, click it once more - again, with either the Shift or Ctrl key pressed.

The Shift and Ctrl keys can be used to select multiple items in a variety of contexts, such as: the Library and Project Browsers, lists in dialog boxes, and files to be imported.

Edit Area



The **Edit Area** tool allows you to quickly define an area of your plan and select the objects in that area. Once selected, they can then be repositioned, rotated, or deleted. Select **Edit> Edit Area**,

then click and drag a rectangular marquee around the area that you would like to move.

Unlike other selection methods, the **Edit Area** tool cuts walls and railings where the selection marquee intersects them, allowing you to edit only the selected portion of these objects.

Some objects, such as cabinets, are included in the selection only if more than half of the object is contained within the marquee.

Editing Line Based Objects

Objects are considered line-based when they can be resized along one axis using the edit handles.

Straight walls and railings, straight stairs and text lines with arrows are examples of line-based objects.

Most line-based objects can be connected to other like objects to form polyline-based objects. See “Editing Open Polyline Based Objects” on page 99 and “Editing Closed-Polyline Based Objects” on page 101.

Some objects, notably walls, have line-based editing behavior only when selected on certain surfaces. See “Editing Walls” on page 146.

Wall openings such as doors and windows have line-based editing behavior in floor plan view only but cannot be rotated, reversed or converted to an arc. See “Editing Doors” on page 213 and “Editing Windows” on page 231.

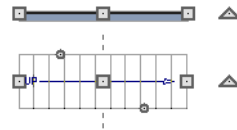

Other objects, such as stairs, have additional edit handles that allow you to concentrically adjust the object’s width.

Using the Edit Handles

When selected, a typical line-based object displays four edit handles: a Move handle, two Extend/Change Angle handles, and a Rotate handle.

Any action performed using the edit handles can be cancelled by pressing the Esc key or any two mouse buttons at the same time.

Move

- Movement may be limited or stopped by other objects or Snap Behaviors. Move restrictions can be overridden by holding down the Ctrl key while dragging. See “Unrestricted Movement” on page 111.

Rotate

- The **Rotate** handle is used to rotate the object about its center. See “Rotating Objects” on page 115.

Extend/Change Angle

- Drag a square end handle parallel to the selected line to change its length.
- Drag a square end handle at an angle to the selected line to change its angle.

Adjust Width

Some line-based objects, such as stairs and roads, have additional handles that allow the width of the object to be adjusted.

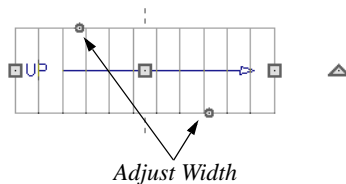

- Click and drag a small, round **Expand** handle to increase or decrease the object’s width. By default, objects are resized in 1" increments. This Snap Unit is defined in the **Plan Defaults** dialog. See “General Plan Defaults Dialog” on page 56.

Using Dimensions



Dimensions can be used to position line-based objects relative to other objects. See “Moving Objects Using Dimensions” on page 192.

Dimensions cannot, however, be used to adjust the length of line-based objects, or the width of line-based objects such as stairs.

Using the Specification Dialog













Line-based objects can be edited using their specification dialogs. See “Specification Dialogs” on page 28.

Using the Edit Toolbar

A selected line-based object can be edited in a variety of ways using the buttons on the edit toolbar.

The following toolbar buttons may display on the edit toolbar for a selected line-based object:

- Click the **Select Next Object**  edit button to select nearby objects instead of the selected object. See “Selecting Objects” on page 92.
- Click the **Open Object**  edit button to open the specification dialog for the selected object. See “Specification Dialogs” on page 28.
- Click the **Copy/Paste**  edit button to copy the selected object(s) to the system clipboard so they can be pasted elsewhere. See “Copying and Pasting Objects” on page 81.
- Click the **Copy and Paste in Place**  edit button to create a copy of the selected object(s) at the same location as the original. See “Copy and Paste in Place” on page 83.
- Click the **Delete**  edit button to delete the selected object(s). See “Deleting Objects” on page 117.

- Click the **Center Object**  edit button to center an object along a wall within a room or relative to a cabinet fixture. See “Using Center Object” on page 112.
- Click the **View Drawing Group Edit Tools**  edit button to modify the selected object’s place in the drawing order. See “Drawing Group Edit Tools” on page 86.
- Click the **Break Line**  edit button to add a new corner or pivot point to the selected object. See “Break Line” on page 114.
- Click the **Complete Break**  edit button to break the selected object into two separate objects. See “Break Line” on page 114.
- Click the **Change Line/Arc**  edit button to change a line-based object to an arc, or vice versa. See “Change Line/Arc” on page 115.

Editing Arc Based Objects

Objects are considered arc-based when they can be resized along a curve using the edit handles.

Curved walls and railings, curved stairs, and curved text lines with arrows are examples of arc-based objects.

Most arc-based objects can be connected to other like objects to form polyline-based objects. See “Editing Open Polyline Based Objects” on page 99 and “Editing Closed-Polyline Based Objects” on page 101.

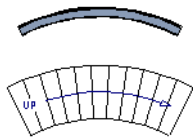

Some objects, notably curved walls, have arc-based editing behavior only when selected on certain surfaces. See “Editing Walls” on page 146.

Other objects, such as curved stairs and roads, have additional edit handles that allow you to concentrically adjust the object’s width.

Using the Edit Handles

When selected, a typical arc-based object displays seven edit handles.

Any action performed using the edit handles can be cancelled by pressing the Esc key or any two mouse buttons at the same time.

Move

- Two Move edit handles allow the arc to be relocated without changing its shape. One is located at the center of the chord and the other, at the arc center.
- Movement may be limited or stopped by other objects or Snap Behaviors. Move restrictions can be overridden by holding down the Ctrl key while dragging. See “Unrestricted Movement” on page 111.

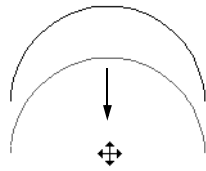

Move edit handle

Rotate

- The **Rotate** handle is used to rotate the arc about its center. See “Rotating Objects” on page 115.

Extend

- The end edit handles expand or contract the arc when moved along the arc radius or chord.
- If you follow the path of the arc, the end edit handles allow you to adjust the arc length.
- The angle formed by the center point of the arc and its two endpoints is referred to as the Included Angle. The Included Angle of the arc can be rotated at Allowed Angles. See “Angle Snaps” on page 79.

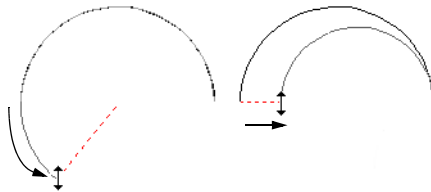

Extend edit handles

Resize

- Drag the small, round **Resize** edit handle to change the radius and included angle of the arc while maintaining its center.

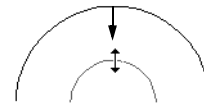

Resize edit handle

Reshape

- Drag the small triangular **Reshape** handle to change the length and location of the center without moving the endpoints.

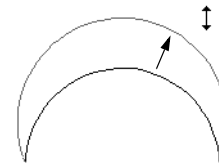

Reshape edit handle

Adjust Width

Some arc-based objects, such as stairs and roads, have additional handles that allow the width of the object to be adjusted.

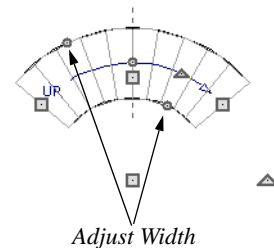

Adjust Width

- Click and drag a small, round edit handle to increase or decrease the object’s width. By default, objects are resized according to the Snap Unit defined in the **Plan Defaults** dialog. See “General Plan Defaults Dialog” on page 56.

Using Dimensions



Dimensions can be used to position arc-based objects. Dimension lines typically locate tangent extension lines and any extension lines that may be parallel to those lines rather than the arc itself. See “Moving Objects Using Dimensions” on page 192.

Using the Specification Dialog





Arc-based objects can be edited using their specification dialogs. See “Specification Dialogs” on page 28.







Using the Edit Toolbar

A selected arc-based object can be edited in a variety of ways using the buttons on the edit toolbar.

The following toolbar buttons may display on the edit toolbar for a selected arc-based object:

- Click the **Select Next Object**  edit button to select nearby objects instead of the selected object. See “Selecting Objects” on page 92.
- Click the **Open Object**  edit button to open the specification dialog for the selected object. See “Specification Dialogs” on page 28.
- Click the **Copy/Paste**  edit button to copy the selected object(s) to the system clipboard so they can be pasted else-

where. See “Copying and Pasting Objects” on page 81.

- Click the **Copy and Paste in Place**  edit button to create a copy of the selected object(s) at the same location as the original. See “Copy and Paste in Place” on page 83.
- Click the **Delete**  edit button to delete the selected object(s). See “Deleting Objects” on page 117.
- Click the **Center Object**  edit button to center an object along a wall within a room or relative to a cabinet fixture. See “Using Center Object” on page 112.
- Click the **View Drawing Group Edit Tools**  edit button to modify the selected object’s place in the drawing order. See “Drawing Group Edit Tools” on page 86.
- Click the **Break Line**  edit button to add a new corner or pivot point to the selected object. See “Break Line” on page 114.
- Click the **Complete Break**  edit button to break the selected object into two separate objects. See “Break Line” on page 114.
- Click the **Change Line/Arc**  edit button to change an arc-based object to a line, or vice versa. See “Change Line/Arc” on page 115.

Editing Open Polyline Based Objects

Open polyline-based objects are composed of individual line- and arc-based objects that are connected at their end points but do not form an enclosed area.

Connected walls, stairs, and text lines with arrows are examples of open polyline-based objects.

For information about editing closed polyline-based objects, see “Editing Closed-Polyline Based Objects” on page 101.

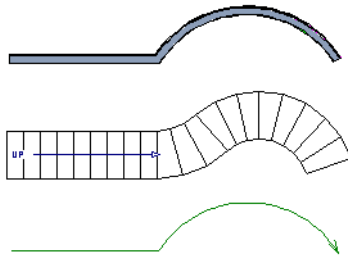

Other objects, such as connected stair segments, have additional edit handles that allow you to concentrically adjust the width of all segments of the object.

Using the Edit Handles

A polyline-based object can be composed of many segments.

When selected, an open polyline-based object displays a Move handle, a Rotate handle, a Reshape handle at the intersection of each segment, and an Extend handle at each end.

Each straight, line-based segment also has a Move edit handle along its length.

Each curved, arc-based segment has its own Move handle at the center of its chord, a Resize handle and, if it has an unlocked center, a Reshape handle. See “Editing Arc Based Objects” on page 96.

When a polyline is selected, the edge that you click nearest is called the selected edge, and certain operations affect only this edge. The Move handle of the selected edge is larger than that of other edges. It displays along the length of a line segment, or at the center of the chord on an arc segment. See “Selected Edge” on page 92.

Any action performed using the edit handles can be cancelled by pressing the Esc key or any two mouse buttons at the same time.

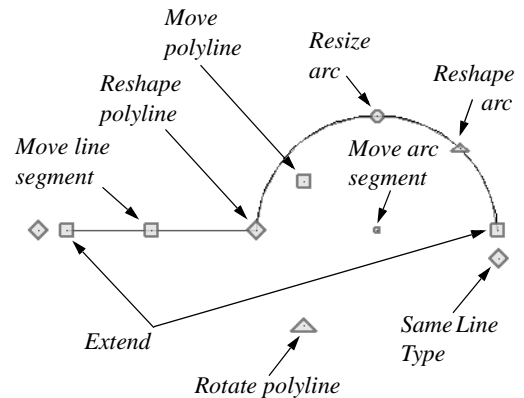

Move

- Click and drag the Move handle to move the object.
- Movement may be limited or stopped by other objects or Snap Behaviors. Move restrictions can be overridden by holding

down the Ctrl key while dragging. See “Unrestricted Movement” on page 111.

Rotate

- The **Rotate** handle is used to rotate the object about its center. Its position varies depending on which edge is currently selected. See “Rotating Objects” on page 115.

Extend

- Click and drag an Extend handle to lengthen or shorten the unconnected end of the selected line or arc segment, or to change the radius of the selected arc. See “Editing Arc Based Objects” on page 96.

Reshape

- Click and drag a Reshape edit handle to change the angle and/or length of the segments on either side of it, or the size of the object.

Move Line Segment

- The **Move Line Segment** edit handle is found on straight segments of open polylines and moves the straight section perpendicular to itself. Adjacent segments may extend or contract in their original directions to maintain their connections.

Move Arc

- Click and drag the Move Arc edit handle to change the radius and/or chord length or position. Adjacent segments may extend, contract, or change angle to maintain their connections.

Resize Arc

- Click and drag the Resize Arc edit handle to change the radius, chord length and chord position of the arc segment. Adjacent segments may extend, contract, or

change angle to maintain their connections.

Reshape Arc

- Click and drag the Reshape Arc edit handle to change the radius of the arc without moving its end points.

Adjust Width

Some open polyline-based objects, such as stairs and roads, have additional handles that allow the width of the object to be adjusted.

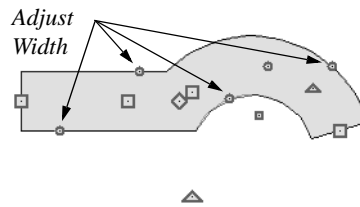

- Click and drag a small, round edit handle to increase or decrease the object’s width. By default, objects are resized in 1" increments. This Snap Unit is defined in the **Plan Defaults** dialog. See “General Plan Defaults Dialog” on page 56.

Using Dimensions



Dimensions can be used to move or reshape polyline-based objects. See “Moving Objects Using Dimensions” on page 192.

Using the Specification Dialog













Open polyline-based objects can be edited using their specification dialogs. See “Specification Dialogs” on page 28.

Using the Edit Toolbar

A selected open polyline-based object can be edited in a variety of ways using the buttons on the edit toolbar.

The following toolbar buttons may display on the edit toolbar for a selected open polyline-based object:

- Click the **Select Next Object**  edit button to select nearby objects instead of the selected object. See “Selecting Objects” on page 92.
- Click the **Open Object**  edit button to open the specification dialog for the selected object. See “Specification Dialogs” on page 28.
- Click the **Copy/Paste**  edit button to copy the selected object(s) to the system clipboard so they can be pasted elsewhere. See “Copying and Pasting Objects” on page 81.
- Click the **Copy and Paste in Place**  edit button to create a copy of the selected object(s) at the same location as the original. See “Copy and Paste in Place” on page 83.
- Click the **Delete**  edit button to delete the selected object(s). See “Deleting Objects” on page 117.
- Click the **Center Object**  edit button to center an object along a wall within a room or relative to a cabinet fixture. See “Using Center Object” on page 112.
- Click the **View Drawing Group Edit Tools**  edit button to modify the selected object’s place in the drawing order. See “Drawing Group Edit Tools” on page 86.
- Click the **Break Line**  edit button to add a new corner or pivot point to the selected object. See “Break Line” on page 114.
- Click the **Complete Break**  edit button to break the selected object into two separate objects. See “Break Line” on page 114.
- Click the **Change Line/Arc**  edit button to change a line-based polyline edge to an arc, or vice versa. See “Change Line/Arc” on page 115.

Editing Closed-Polyline Based Objects

Closed polyline-based objects are composed of individual line- and arc-based objects joined end-to-end and forming an enclosed area.

Stair landings are examples of closed polyline-based objects.

For information about editing open polyline-based objects, see “Editing Open Polyline Based Objects” on page 99.

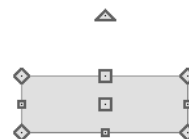

Using the Edit Handles

A polyline can be composed of many segments.

When selected, a closed polyline-based object displays a Move handle, a Rotate handle, and a Reshape handle at the intersection of each segment.

Each straight, line-based segment has a Move edit handle along its length.

Each curved, arc-based segment has its own Move handle at the center of its chord, a Resize handle and a Reshape handle. See “Editing Arc Based Objects” on page 96.

When a polyline is selected, the edge that you click nearest is called the selected edge, and certain operations affect only this edge. The Move handle of the selected edge is larger than that of other edges. It displays along the length of a line segment, or at the center of the chord on an arc segment. See “Selected Edge” on page 92.

Any action performed using the edit handles can be cancelled by pressing the Esc key or any two mouse buttons at the same time.

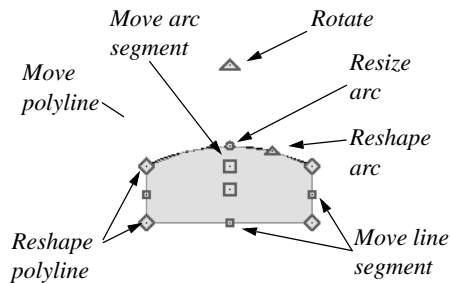

Move

- Click and drag the Move handle to move the object.

- Movement may be limited or stopped by other objects or Snap Behaviors. Move restrictions can be overridden by holding down the Ctrl key while dragging. See “Unrestricted Movement” on page 111.

Rotate

- The **Rotate** handle is used to rotate the object about its center. Its position varies depending on which edge is currently selected. See “Rotating Objects” on page 115.

Reshape

- Click and drag a Reshape edit handle to change the angle and/or length of the segments on either side of it.

Move Line Segment

- The **Move Line Segment** edit handle is found on straight segments of closed polylines and moves the straight section perpendicular to itself. Adjacent segments may extend or contract in their original directions to maintain their connections.

Move Arc

- Click and drag the Move Arc edit handle to change the radius and/or chord length or position. Adjacent segments may extend, contract, or change angle to maintain their connections.

Resize Arc

- Click and drag the Resize Arc edit handle to change the radius, chord length and chord position of the arc segment. Adjacent segments may extend, contract, or change angle to maintain their connections.

Reshape Arc

- Click and drag the Reshape Arc edit handle to change the radius of the arc without moving its end points.

Using Dimensions

 Dimensions can be used to move or reshape closed polyline-based objects. See “Moving Objects Using Dimensions” on page 192.











Using the Specification Dialog

 Closed polyline-based objects can be edited using their specification dialogs. See “Specification Dialogs” on page 28.

Using the Edit Toolbar

A selected closed polyline-based object can be edited in a variety of ways using the buttons on the edit toolbar.

The following toolbar buttons may display on the edit toolbar for a selected closed polyline-based object:

- Click the **Select Next Object**  edit button to select nearby objects instead of the selected object. See “Selecting Objects” on page 92.
 - Click the **Open Object**  edit button to open the specification dialog for the selected object. See “Specification Dialogs” on page 28.
 - Click the **Copy/Paste**  edit button to copy the selected object(s) to the system clipboard so they can be pasted else-
- where. See “Copying and Pasting Objects” on page 81.
- Click the **Copy and Paste in Place**  edit button to create a copy of the selected object(s) at the same location as the original. See “Copy and Paste in Place” on page 83.
 - Click the **Delete**  edit button to delete the selected object(s). See “Deleting Objects” on page 117.
 - Click the **Center Object**  edit button to center an object along a wall within a room or relative to a cabinet fixture. See “Using Center Object” on page 112.
 - Click the **View Drawing Group Edit Tools**  edit button to modify the selected object’s place in the drawing order. See “Drawing Group Edit Tools” on page 86.
 - Click the **Break Line**  edit button to add a new corner or pivot point to the selected object. See “Break Line” on page 114.
 - Click the **Complete Break**  edit button to break an edge of the selected object into two separate objects. See “Break Line” on page 114.
 - Click the **Change Line/Arc**  edit button to change a line-based polyline edge to an arc, or vice versa. See “Change Line/Arc” on page 115.

Editing Box-Based Objects

Box-based objects are similar to closed polyline-based objects, but must always have four sides with right-angled corners.

Text objects, many library symbols, pictures and images are examples of box-based objects.

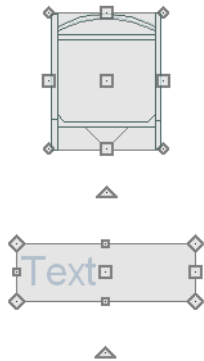

Using the Edit Handles

When selected, a box-based object displays ten edit handles.

Any action performed using the edit handles can be cancelled by pressing the Esc key or any two mouse buttons at the same time.

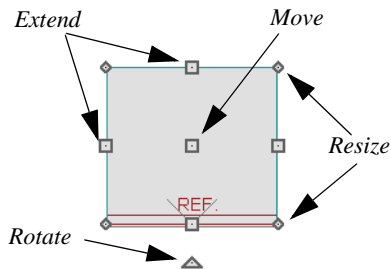

- Click and drag the Move handle to move the object.

- Movement may be limited or stopped by other objects or Snap Behaviors. Move restrictions can be overridden by holding down the Ctrl key while dragging. See “Unrestricted Movement” on page 111.

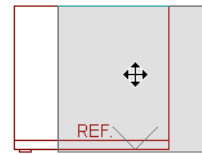

- The four **Resize** handles located at each corner are used to increase or decrease the size of the object.

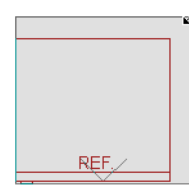

- The four **Extend** handles display along each edge. If you select an object on an edge, the Extend handle displays at the point where you clicked; otherwise, it displays at the center of the edge.

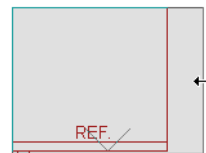

- The triangular **Rotate** handle located near the selected edge of the object is used to rotate it about its center. The pointer changes to a circular arrow .

when moved over this handle. See “Rotating Objects” on page 115.

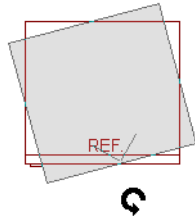

Using Dimensions

 Dimensions can be used to move or reshape box-based objects. See “Moving Objects Using Dimensions” on page 192.

Using the Specification Dialog

 Box-based objects can be edited using their specification dialogs. See “Specification Dialogs” on page 28.







Using the Edit Toolbar

A selected box-based object can be edited in a variety of ways using the buttons on the edit toolbar.

The following toolbar buttons may display on the edit toolbar for a selected box-based object:

- Click the **Select Next Object**  edit button to select nearby objects instead of

the selected object. See “Selecting Objects” on page 92.

- Click the **Open Object**  edit button to open the specification dialog for the selected object. See “Specification Dialogs” on page 28.
- Click the **Copy/Paste**  edit button to copy the selected object(s) to the system clipboard so they can be pasted elsewhere. See “Copying and Pasting Objects” on page 81.
- Click the **Copy and Paste in Place**  edit button to create a copy of the selected object(s) at the same location as the original. See “Copy and Paste in Place” on page 83.
- Click the **Delete**  edit button to delete the selected object(s). See “Deleting Objects” on page 117.
- Click the **Center Object**  edit button to center an object along a wall within a room or relative to a cabinet fixture. See “Using Center Object” on page 112.
- Click the **View Drawing Group Edit Tools**  edit button to modify the selected object’s place in the drawing order. See “Drawing Group Edit Tools” on page 86.

Editing Spline Based Objects

A Spline is a curve that passes smoothly through a set of points, or vertices. Splines

are typically used in situations where an irregular, free-flowing curve is needed.

Objects are considered spline-based when they can be edited similar to CAD splines using their edit handles. See “Draw Spline” on page 123.

Electrical connections drawn with the **Connect Electrical**  tool are examples of spline-based objects. See “Connect Electrical” on page 268.

Electrical connections drawn with the **Connect Electrical**  tool are examples of spline-based objects. See “Connect Electrical” on page 268.

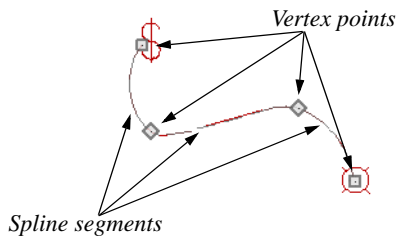

Using the Edit Handles

When a spline is selected, several different types of handles display.

Any action performed using the edit handles can be cancelled by pressing the Esc key or any two mouse buttons at the same time.

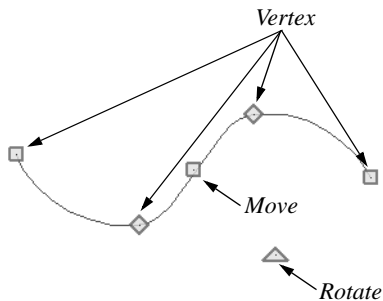

Move

- Click and drag the Move handle to move the object.
- Movement may be limited or stopped by other objects or Snap Behaviors. Move restrictions can be overridden by holding down the Ctrl key while dragging. See “Unrestricted Movement” on page 111.

Rotate

- Click and drag the Rotate edit handle to rotate the entire spline.

Vertex

- The Vertex edit handles display along the spline at each vertex. Click and drag a Vertex edit handle to change the length, angle and curve of adjacent segments without affecting other vertices.











Using the Specification Dialog

-  Spline-based objects can be edited using their specification dialogs. See “Polyline Specification Dialog” on page 128.

Using the Edit Toolbar

A selected spline-based object can be edited in a variety of ways using the buttons on the edit toolbar.

The following toolbar buttons may display on the edit toolbar for a selected spline-based object:



- Click the **Select Next Object**  edit button to select nearby objects instead of the selected object. See “Selecting Objects” on page 92.
- Click the **Open Object** edit button to open the specification dialog for the selected object. See “Polyline Specification Dialog” on page 128.
- Click the **Copy/Paste**  edit button to copy the selected object(s) to the system clipboard so they can be pasted elsewhere. See “Copying and Pasting Objects” on page 81.
- Click the **Copy and Paste in Place**  edit button to create a copy of the selected object(s) at the same location as the original. See “Copy and Paste in Place” on page 83.
- Click the **Delete**  edit button to delete the selected object(s). See “Deleting Objects” on page 117.
- Click the **Center Object**  edit button to center an object along a wall within a room or relative to a cabinet fixture. See “Using Center Object” on page 112.
- Click the **View Drawing Group Edit Tools**  edit button to modify the selected object’s place in the drawing order. See “Drawing Group Edit Tools” on page 86.
- Click the **Break Line**  edit button to add a new corner or pivot point to the selected object. See “Break Line” on page 114.
- Click the **Complete Break**  edit button to break an edge of the selected object into two separate objects. See “Break Line” on page 114.

Editing Circles, Ovals and Ellipses

Objects created using the **Circle, Oval, and Ellipse Tools** are unusual in that no architectural objects share their functionalities.

Using the Edit Handles

When selected, circles, ovals and ellipses display eleven edit handles.

Unlike **Ovals**  and **Ellipses** , a **Circle**  cannot be edited into any other shapes; it can only be a circle.

Any action performed using the edit handles can be cancelled by pressing the Esc key or any two mouse buttons at the same time.

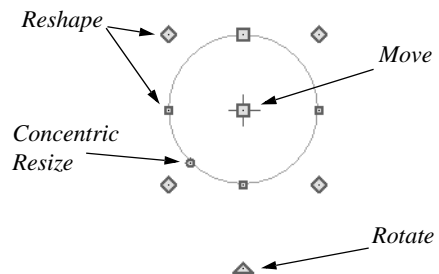

Move

- Click and drag the Move handle to move the object.
- Movement may be limited or stopped by other objects or Snap Behaviors. Move restrictions can be overridden by holding down the Ctrl key while dragging. See “Unrestricted Movement” on page 111.

Rotate

- Click and drag the Rotate handle of an oval or ellipse to change its orientation.

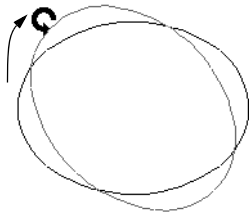

Reshape

- The eight edit handles beyond the perimeter are Reshape edit handles. Move them in or out to resize and reshape an oval or ellipse.

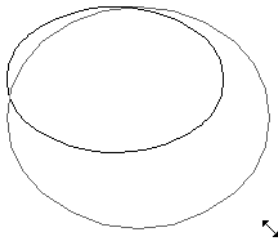

- Unlike ovals and ellipses, circles cannot be reshaped. When a Reshape handle is dragged on a circle, it is only resized.

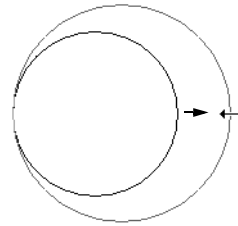

Concentric Resize

- The Concentric Resize edit handle displays on the perimeter of a circle between a corner Reshape handle and the center. Click and drag this handle to resize the circle without moving its center point.

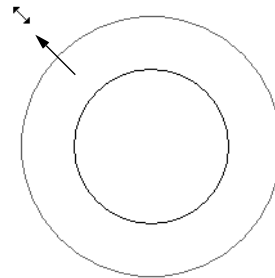

Using Dimensions

 Dimensions can be used to move or resize circle-based objects. See “Moving Objects Using Dimensions” on page 192.







Using the Specification Dialog

 Circles, ovals and ellipses can be edited using their specification dialogs. See “Circle/Oval/Ellipse Specification Dialog” on page 127.

Using the Edit Toolbar

A selected circle, oval or ellipse can be edited in a variety of ways using the buttons on the edit toolbar.

The following toolbar buttons may display on the edit toolbar for a selected circle, oval or ellipse:

- Click the **Select Next Object**  edit button to select nearby objects instead of the selected object. See “Selecting Objects” on page 92.
- Click the **Open Object**  edit button to open the specification dialog for the selected object. See “Specification Dialogs” on page 28.
- Click the **Copy/Paste**  edit button to copy the selected object(s) to the system clipboard so they can be pasted else-
- Click the **Copy and Paste in Place**  edit button to create a copy of the selected object(s) at the same location as the original. See “Copy and Paste in Place” on page 83.
- Click the **Delete**  edit button to delete the selected object(s). See “Deleting Objects” on page 117.
- Click the **Center Object**  edit button to center an object along a wall within a room or relative to a cabinet fixture. See “Using Center Object” on page 112.
- Click the **View Drawing Group Edit Tools**  edit button to modify the selected object’s place in the drawing order. See “Drawing Group Edit Tools” on page 86.

Displaying Objects

The display of objects in 2D and 3D views can be controlled using Drawing Groups and layer. See “Displaying Objects” on page 85.



Line and Fill Styles

Line style and color can be controlled by layer or overridden in the specification dialogs for many objects. See “Line Style Panel” on page 124.

In addition, some objects have a fill style that can be specified in the objects’ specification dialogs. See “Fill Style Panel” on page 129.

Color On/Off

 The display of color on-screen can be toggled on and off in any view by selecting **View> Color**.

- If **Color**  is toggled off in any 3D view, the view will be displayed in gray-scale.
- If **Color**  is toggled off in floor plan view, the view will be displayed in black and white.

Textures

The appearance of architectural objects in 3D views is affected by the materials applied to the objects' surfaces. See "Materials" on page 361.

In views, you can turn on or off the display of textures by selecting **3D > Camera View Options > Toggle Textures** .

Delete Surface



In any 3D view, select **3D > Delete Surface**, then click a surface in the

view to temporarily remove the surface from the current view. See "Delete 3D Surface" on page 380.

Refresh Display

Refresh Display redraws the current window to clean up extra lines, show missing items, and correct random on-screen effects caused by changes to a model. Select **View > Refresh Display** or press the F5 key to refresh the on-screen display.

Moving Objects

Objects can be moved using the edit handles as well as a variety of edit tools. Multiple selected objects can also be moved as a group. See "Selecting Objects" on page 92.

Using the Edit Handles

Select an object, then click the **Move** edit handle and drag it to a new location. When your pointer is over the Move handle, it displays a four-headed arrow.

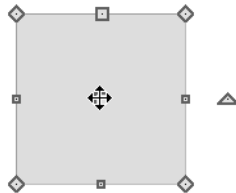

When moved, the selected object moves orthogonal, or at a right angle to, any of its edges.

As an object is moved, it jumps at set increments when **Grid Snaps** are enabled. See "Grid Snaps" on page 79.

If an selected object passes over its original location as it is being moved, it will snap to that location.

You can temporarily slow the movement of your mouse as you drag an edit handle by holding down the Shift key on your keyboard.

Bumping/Pushing

When an object bumps into another object while it is being moved, it stops. If you do not release the mouse button and continue to drag, however, the selected object resumes movement and continues past the obstructing object.

Instead of dragging through and past one or more obstructing objects, you can instead push them. To do this, bump an object into an

obstructing object and release the mouse button. Then, click and drag the Move edit handle a second time in the same direction.

Walls, wall openings, cabinets, furnishings and fixtures are examples of objects that can bump into as well as push other objects.

Bumping/Pushing does not affect objects moved using dimensions. See “Moving Objects Using Dimensions” on page 192.

Unrestricted Movement

Many objects have restrictions placed on their movement by their own properties or specification settings. Architectural objects, for example, bump into other 3D objects as they are being moved.

Other move restrictions are activated by the **Snap Settings**. See “Snap Behaviors” on page 78.

These restrictions can be overridden when necessary by holding down the Ctrl key while dragging to move an object.

To move an object freely

1. Select the object.
2. Hold down the Ctrl key.
3. Click the Move edit handle and drag it to the new location.

You can also press the Ctrl key while dragging an object’s Move handle to override move restrictions.

Nudging

You can use the arrow keys on your keyboard to move a selected object or objects by single **Snap Grid** increments in 2D and 3D views.

This is referred to as nudging. See “Grid Snaps” on page 79.

In Floor Plan View

To nudge an object in floor plan view, select it and press any of the four arrow keys: Up, Down, Left, or Right.

In 3D Views

In 3D views, nudging is relative to the selected surface. If, for example, you select the front of a cabinet in 3D and nudge it to the left, it will move to the left in floor plan view. If you instead select the back of a cabinet in 3D and nudge it to the left, it will move to the right in floor plan view.

When multiple objects are selected, the surface that was clicked on last is considered the selected surface. When nudged, all selected objects will move relative to that surface. See “Shift and Ctrl Select” on page 93.

If an object is rotated, the directions that it can be nudged in 2D are not affected; however, in 3D, they are. If, for example, a cabinet is rotated 45°, it will nudge to the left in floor plan view. When nudged in 3D, however, it will move at a 45° angle: or parallel to the selected surface.

Center Object



The **Center Object** edit button allows you to move walls, cabinets and other objects so that they are centered along a wall within a room or relative to a window or cabinet.

Using Dimensions



Objects or the selected edges of some objects can be moved using

dimensions. See “Moving Objects Using Dimensions” on page 192.

Aligning Objects

It is often important to align objects such as text boxes or walls, or to align objects on different floors. There are several methods to choose from.

Using the Mouse Cross Hairs

Objects can be aligned by eye using the mouse cross hairs as a reference. This method can help you draw, place and edit objects quickly and with reasonable accuracy, but is not necessarily as accurate as some of the other approaches described here.

The mouse cross hairs can be turned on and off in the **Preferences** dialog. See “Edit Panel” on page 62.

Using Snap Settings

With **Object Snaps**, you can snap the edge of a selected object to that of another. Select an edge of an object. Drag it to the edge of another object, then release the mouse.

Objects drawn at angles other than vertical and horizontal snap at increments equal to the **Snap unit** specified in the **Plan Defaults** dialog rather than onto the grid itself. This does not align objects to the grid unless they were already snapped to the grid. See “Snap Behaviors” on page 78.

Using Dimensions



Create a temporary or manual dimension relative to an object such as

a wall or line, and relocate the objects to the same dimension. See “Moving Objects Using Dimensions” on page 192.



Text objects can be aligned using settings in the Text Specification dialog. See “Aligning Text” on page 203.

Using Center Object



The **Center Object** edit button can be used to center a variety of objects relative to another object. Center Object can be used in floor plan and 3D views.

To center an object

1. Select an object.
2. Click the **Center Object**  edit button.
3. Move the mouse pointer over the object you would like to center the selected object relative to.
 - As the pointer passes over an eligible object, it becomes highlighted and a dashed centering axis line displays.
4. When the desired centering axis displays, click once to center the selected object along that axis line.

To center an object in a room

1. Select an object such as a cabinet.
2. Click the **Center Object**  edit button.

3. Move the mouse pointer in the room that you would like to center the selected object relative to.
 - As you move the pointer, a centering axis will display along the wall it is closest to.
 - The selected object does not have to be inside a room in order to be centered relative to that room.
4. When a centering axis displays along the correct wall, click once.
5. The object is moved perpendicular to the centering axis.

If you click outside an exterior wall instead of clicking inside, the selected object is centered along the edge of the Exterior Room. See “The Exterior Room” on page 167.

Aligning Objects on Different Floors

Objects on different floors can be aligned with one another using the **Reference**

Display . See “The Reference Floor” on page 293.

Resizing Objects

Objects can be resized using the edit handles and specification dialogs.

Using the Edit Handles

The end, corner and/or side edit handles can be used to resize a selected object.

To override any movement restrictions caused by snap settings or the presence of other objects, press the Ctrl key while dragging an edit handle.

As an object is resized, any dimensions indicating its size will update to reflect your changes. You can use dimensions as references to help you achieve the correct size for most objects.

You can temporarily slow the movement of your mouse as you drag an edit handle by holding down the Shift key on your keyboard.

Using the Specification Dialog



Most objects can be accurately resized in their specification dialogs. See “Specification Dialogs” on page 28.

Using Dimensions



Many objects can be resized by selecting an edge and then moving that edge using dimensions. See “Moving Objects Using Dimensions” on page 192.

Walls can also be resized using dimensions; however, it is important to understand that the selected edges of other objects cannot be resized using dimensions - they can only be moved. To resize an edge, select an adjacent edge and move that edge instead.

Reshaping Objects

There is a variety of ways to reshape objects using the edit handles, specification dialogs and edit toolbar buttons.

Some objects, notably box-based objects, cannot be reshaped - only resized. See “Resizing Objects” on page 113.

Using the Edit Handles

Depending on the type of object selected, the end, corner and/or side edit handles can be used to reshape a selected object.

To override any movement restrictions caused by snap settings or the presence of other objects, press the Ctrl key while dragging an edit handle.

You can temporarily slow the movement of your mouse as you drag an edit handle by holding down the Shift key on your keyboard.

Using the Specification Dialog



A variety of objects can be reshaped by editing values on either the SELECTED LINE or SELECTED ARC panel of their specification dialogs. See “Selected Line Panel” on page 318 and “Selected Arc Panel” on page 319.

Using Dimensions



Both temporary and manually drawn dimensions can be used to increase or decrease the distance between the edge a line- or polyline-based object and another, parallel edge or line.

Break Line



The **Break Line** edit tool can be used to break an individual line- or arc-based object into two segments. The edges of a polyline-based object can also be broken.

Note: The Break Line edit button is not available for box-based objects or some architectural objects such as stairs.

There are two types of breaks: partial and complete. Partial breaks create a new corner, or pivot point, while complete breaks actually sever an edge into two segments.



To create a partial break

1. Click the object, object edge, or object centerline that you want to break into two segments.
2. Click the **Break Line**  edit button once or press the 3 key.
3. Click the edge to create a new corner edit handle at that location and two separate edges on either side of that handle.

If you click and drag one of the edit handles on either side of the partial break, the edge moves at a right angle to itself and another edge forms, connecting the moved edge with the one on the other side that does not move.

You can remove an edge from a polyline-based object by clicking and dragging a corner handle until it snaps to an adjacent corner handle.

To create a complete break

1. Click the object, object edge, or object centerline that you want to break into two segments.
2. Click the **Break Line**  edit button.
3. Click the **Complete Break**  edit button.
4. Click on an edge to create a complete break at that location.

The edge that you clicked on will be divided into two separate sections, one of which will be selected. You can now move or edit the selected edge completely independent of the object or edge on the other side of the break. Click on the other edge to select it instead.

To remove a break from an edge

1. Make sure that **Object Snaps** are enabled. See “Object Snaps” on page 78.
2. Select the object that has a break that you want to remove.

3. Click on the corner edit handle associated with the break that you want to remove and drag it to an adjacent corner handle.
4. Release the mouse button and the handle that you selected will be removed.

Change Line/Arc

 Select an individual line-based or arc-based object or a segment of a polyline-based object and click the **Change Line/Arc** edit button to convert the selected segment from a line to an arc or vice versa.

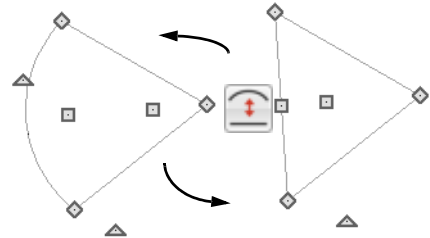

Rotating Objects

Objects can be rotated using the edit handles as well as a variety of edit tools. Multiple selected objects can also be rotated as a group. See “Selecting Objects” on page 92.

By default, an object or group of objects rotate about the center point of the selection set.

Using the Edit Handles

Select an object, then click the triangular **Rotate** edit handle and drag it in any

direction. When your pointer is over the Rotate handle, it displays a curved arrow.

The angles of line-based objects can also be changed by dragging an end handle in a direction other than parallel to the object. The object rotates about the opposite end point. See “Editing Line Based Objects” on page 94.

Objects snap to Allowed Angles as they are rotated. See “Angle Snaps” on page 79.

To override any movement restrictions caused by snap settings or the presence of other objects, press the Ctrl key while dragging an edit handle.

You can temporarily slow the movement of your mouse as you drag an edit handle by holding down the Shift key on your keyboard.

Using the Specification Dialog







The exact angle of some objects such as lines, arcs, walls and the selected edges of polylines can be specified on either the GENERAL panel, SELECTED LINE panel, or SELECTED ARC panel of that object's specification dialog. See “Selected Line Panel” on page 318 and “Selected Arc Panel” on page 319.

Matching Properties





The **Object Eyedropper** tool allows you to select attributes from one object and apply them to other, similar objects.

To use the Object Eyedropper

- Begin by selecting the **Object Painter Mode** that you want to use. Select **Tools > Object Painter**, then:
 - Select **Object Painter Object Mode**  to apply attributes to individual objects, one at a time.
 - Select **Object Painter Room Mode**  to apply attributes to an individual object as well as all objects in the same room that are identical to it with a single click.
 - Select **Object Painter Floor Mode**  to apply attributes to an individual object as well as all objects on the same floor that are identical to it with a single click.
 - Select **Object Painter Plan Mode**  to apply attributes to an individual

object as well as all objects in the entire plan that are identical to it with a single click.



- Select **Tools > Object Painter > Object Eyedropper** , and notice that your mouse pointer displays an eyedropper  icon.
- Move your mouse pointer over an object in the current view. If it becomes highlighted and “Object to pick” information is stated on the left side of the Status Bar, click once to load the object's attributes so they can be applied to other, similar objects.
- Notice that your mouse pointer now displays a spray can  icon.
- Move your mouse pointer over an object that is similar to the one selected in step 1: if it becomes highlighted and “Load Properties to” information is stated in the Status Bar, the object is eligible to receive the loaded attributes.
- Click on an eligible object to apply attributes to it as well as any other

identical objects, depending on which Object Painter Mode is active.

- Continue clicking to apply attributes until the Esc key is pressed or another tool is activated.

Deleting Objects

Objects can be deleted in a variety of ways:

- Select an object or group of objects, then click the **Delete**  edit button, select **Edit> Delete**  from the menu, or press the either the Delete or Backspace key on your keyboard.
- Entire categories of objects can be deleted using the **Delete Objects** dialog.

- Objects are deleted if the floor they are placed on is deleted. See “Deleting Floors” on page 291.

If an object has a line with arrow attached to it, the arrow is deleted if the object is deleted. To prevent the arrow from being deleted, drag the attached end away from the object before deleting it.

Delete Objects Dialog



In floor plan view, use the **Delete Objects** dialog to delete all objects of

one or more specified types in one room, on the current floor, or on all floors in the plan.

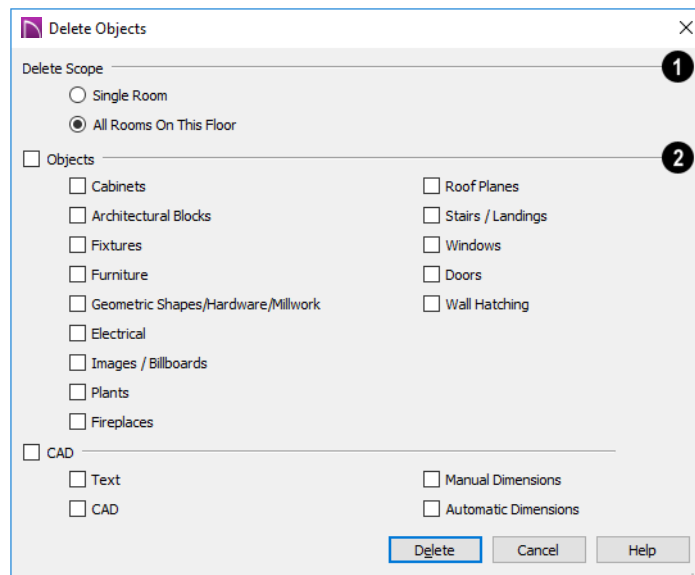

- Select a **Delete Scope**:

- Choose **Single Room** to delete objects only in rooms on the current floor that you specify.
 - Choose **All Rooms on This Floor** to delete objects in all rooms on the current floor.
- 2** Specify categories of **Objects to Delete** by checking the box beside each category that you wish to delete.
- Check the box beside any heading to select all of the categories within it; clear the box beside a heading to deselect all of its categories.

To use the Delete Objects dialog

1. Select **Edit> Delete Objects**  to open the **Delete Objects** dialog.
2. Specify the **Delete Scope** as **Single Room** or **All Rooms On This Floor**.
3. Check the box for each category of objects you want to delete. Click **Select All** to check all the boxes or **Clear All** to uncheck all boxes.
4. When the scope is set to **Single Room**:
 - Move your cursor into the drawing area and click in a room of the plan to delete objects of the selected type within that room without closing the dialog.
 - Only objects with their center point located in the room are deleted.

- Continue clicking on rooms or choose a different Delete Scope.
 - Click **Done** when all selections have been deleted.
5. If you select **All Rooms On This Floor**, you do not need to click in floor plan view. The **Delete** button becomes available, and clicking it closes the dialog and deletes the specified objects.

Objects such as roofs or Auto Exterior Dimensions that are set to automatically rebuild or refresh cannot be deleted while that behavior is enabled. If objects of this sort are selected for deletion, the program will ask whether you want to turn off the automatic redraw behavior.

Deleting Polyline Edges

To remove an edge from a polyline, drag a corner handle until it overlaps an adjacent corner handle to remove the edge between them and merge them into a single handle. See “Reshaping Objects” on page 113.

Delete Surface





In any 3D view, select **3D> Delete Surface**, then click a surface in the view to temporarily remove the surface from the current view without permanently affecting the object. See “Delete 3D Surface” on page 380.



Undo and Redo





The **Undo** and **Redo** commands allow you to both undo the last action performed, as well as redo actions that were recently Undone.

The ten most recent actions can be Undone or Redone. Actions that can be Undone and Redone include creating, editing, and deleting objects.

To Undo an action, select **Edit> Undo** , click the **Undo**  button, or press Ctrl + Z on your keyboard.

The Redo command is only available after Undo has been used. To Redo an Undone action, select **Edit> Redo** , click the **Redo**  button or press Ctrl + Y on your keyboard.

It is important to note that **Undo**  and **Redo**  do not affect all actions in the program, including:

- Changes made in the Library Browser. See “The Library Browser” on page 330.
 - Changes made in a Materials List. See “Materials Lists” on page 427.
 - Changes made in a dialog while the dialog box is open. See “Dialogs” on page 26.
 - Changes made to the display by panning the display or zooming in or out. See “Undo Zoom” on page 73.
 - Changes made to the position of a camera, or its Rendering Technique. See “Editing 3D Views” on page 385.
- Save and Save As. See “Saving, Exporting, and Backing Up Files” on page 39.

CAD Objects

The CAD Tools are used to add information to 2D views of your model. CAD objects do not affect 3D objects or display in camera views or overviews, but they can be used to add details to floor plan view.

CAD objects are edited much like other objects in Home Designer Interiors. See “Editing Objects” on page 91.

Chapter Contents

- The CAD Drawing Tools
- Line Specification Dialog
- Arc Specification Dialog
- Circle/Oval/Ellipse Specification Dialog
- Polylines
- Polyline Specification Dialog
- Box Specification Dialog
- Displaying CAD Objects

The CAD Drawing Tools





The CAD drawing tools can be accessed by selecting the **CAD** menu or by clicking the **CAD Tools** button.

Draw Lines



Select **CAD> Draw Line** or **CAD> Draw Line With Arrow** to draw lines with or without arrows.

To draw a line or line with arrow

1. Select **CAD> Draw Line**  or **Draw Line With Arrow** .
2. Click and drag in the drawing area to draw a line.
3. Continue drawing lines as needed, then select another tool when you are finished.

Once a line is created, it can be edited. You can snap the ends of lines together to form polylines. See “Editing Line Based Objects”

on page 94 and “Line Specification Dialog” on page 123.

Draw Arc



Select **CAD > Draw Arc** to draw an arc.

To draw an arc

1. Select **CAD> Arcs> Draw Arc** , then click at the arc’s start point.
2. Move the pointer along the desired curve while dragging to curve the arc.
3. Release the mouse button at the end point to complete the arc.

Once an arc is created, it can be edited. See “Editing Arc Based Objects” on page 96 and “Arc Specification Dialog” on page 125.

You can snap the ends of arcs together with other arcs or with lines to form polylines. See “Polylines” on page 127.

Draw Polyline



Select **CAD > Draw Polyline** to draw a rectangular polyline in either of two ways:

- Click in the drawing area to place a 24” x 24” square polyline at that location.
- Click and drag from corner to corner to draw a rectangle of any size.

Once drawn, a rectangular polyline can be edited into any shape. See “Editing Closed-Polyline Based Objects” on page 101 and “Polyline Specification Dialog” on page 128.

Draw Box



Select **CAD > Draw Box** to draw a box.

CAD boxes are drawn from corner to corner, forming a rectangle that can then be edited. Unlike a polyline, a box always has four 90° corners. See “Editing Box-Based Objects” on page 104 and “Box Specification Dialog” on page 130.

Draw Circle



Select **CAD > Draw Circle** to draw a circle.

Draw a **Circle**  by dragging across the diameter, in any direction.

If a small circle is needed, draw a larger circle and then resize it. See “Editing Circles, Ovals and Ellipses” on page 107 and “Circle/Oval/Ellipse Specification Dialog” on page 127.

Draw Oval



Select **CAD > Draw Oval** to draw an oval, which is a four-arc approximation of an ellipse.

Draw an oval, by clicking and dragging at an angle to define its maximum height and width.

Once an oval is created, it can be edited. See “Editing Circles, Ovals and Ellipses” on page 107 and “Circle/Oval/Ellipse Specification Dialog” on page 127.

Draw Ellipse



An **Ellipse** is a set of points with a constant combined distance from two

points called foci. An ellipse looks like a stretched circle, or a circular surface viewed at an angle.

To draw an ellipse, select **CAD> Draw**

Ellipse  and drag at an angle to define its maximum height and width.

Once an ellipse is created, it can be edited. See “Editing Circles, Ovals and Ellipses” on page 107 and “Circle/Oval/Ellipse Specification Dialog” on page 127.

Draw Spline



A Spline is a curve that passes smoothly through a set of points.

Select **CAD> Draw Spline** to draw connected line segments that form a spline. See “Splines” on page 130.

Once created, a spline can be selected and edited. See “Polyline Specification Dialog” on page 128.

Dimension Tools



Select **CAD> Dimensions** to access the Dimension Tools. The **Dimension**

Tools can be used with CAD and architectural objects and are discussed in their own chapter. See “Dimensions” on page 183.

Text Tools



Select **CAD> Text** to access the Text Tools. The Text Tools are discussed in

their own chapter. See “Text” on page 195.

Line Specification Dialog



Select a CAD Line, Line With Arrow, or Text Line With Arrow and click the **Open Object** edit button to open the **Line Specification** dialog.

The settings on the panels in this dialog are found in the specification and defaults dialogs for a variety of different objects in the program.

Line Panel

The information on the LINE panel of the **Line Specification** dialog is similar to that

found on the SELECTED LINE panels of various specification dialogs in the program.

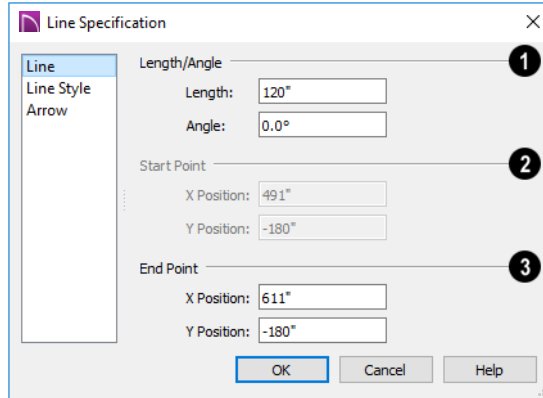

- 1 Specify the **Length** and **Angle** of the selected line.
- 2 The **X** and **Y Position** coordinates of the selected line's **Start Point** display for reference but cannot be changed here.

The Start Point can be changed using the line's edit handles, however. See "Editing Line Based Objects" on page 94.

- 3 Specify the **X** and **Y Position** of the selected line's **End Point**.

Line Style Panel

The **LINE STYLE** panel is found in the specification dialogs for many different objects. The settings here control the

appearance of the lines and/or arcs that make up an object. Depending on the type of object selected, some settings may not be available.

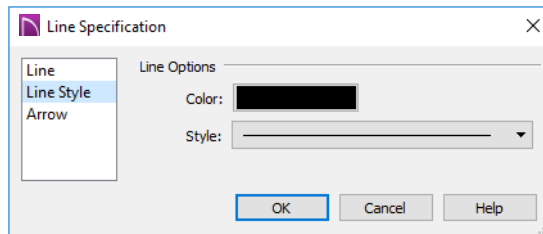

- Click the **Line Color** box to specify a new line color. See "Select Color Dialog" on page 372.
- Click the **Line Style** drop-down list to select from a variety of available line styles.

An additional **Display Options** setting is available in the **Picture File**, **Metafile**, and **PDF File Box Specification** dialogs. See "Pictures, Images, and Walkthroughs" on page 405.

- Check **Show Outline** to display the selected object's border polyline.

Arrow Panel

The ARROW panel is available for any line, arc, open polyline, or spline that can have an arrow: including dimension lines. The defaults for arrows are set in the **Arrow Defaults** dialog. See “Dimension Defaults Dialog” on page 183.

Lines with arrows can be attached to other objects. They attach to a closed polyline-

based object along its edges, but can attach to an architectural object anywhere within its 2D symbol in floor plan view. If an arrow is attached to another object, deleting that object will also delete the arrow.

Closed polylines are examples of objects that cannot have arrows.

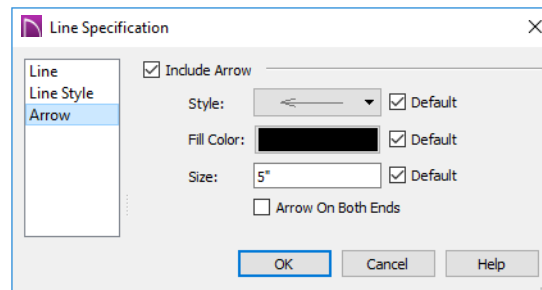

- Check **Include Arrow** to create an arrowhead at the end of the selected line, arc, or open polyline.
- Select an arrowhead **Style** from the drop-down list.
- Click the **Fill Color** box to select a color for the arrowhead to be used if a solid Style is selected. See “Select Color Dialog” on page 372.
- Specify the arrowhead’s **Size**.
- Check the box beside **Arrow On Both Ends** to create a two-headed arrow.
- Place a check in any of the **Default** boxes to restore that setting to the default.

Arc Specification Dialog



Select an arc and click the **Open Object** edit button to open the **Arc Specification** dialog.

The settings on the ARC panel are also found on the SELECTED ARC panels for many objects.

Arc Panel

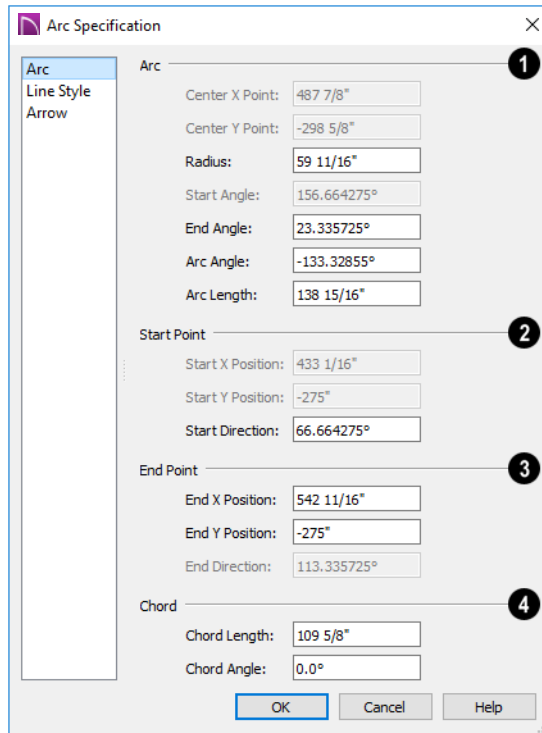

1 These settings define the **Arc**. Some values are listed for reference only and cannot be directly changed here. They can, however, be changed using the edit handles and edit tools. See “Editing Arc Based Objects” on page 96.

- The **Center X and Center Y Points** are the X and Y coordinates of the center of the arc and display for reference. They may update as changes are made to other settings in this dialog.
- **Radius** - Specify the distance between the center of the arc and the arc surface.
- **Start Angle** - The angle of a line drawn from the arc center to the arc start points.

This displays for reference only but may update as changes are made to other settings in this dialog.

- **End Angle** - Specify the angle of a line drawn from the arc center to the arc end.
 - **Arc Angle** - Specify the angle between the center of the arc and each end.
 - **Arc Length** - Specify the length of the arc along its curve.
- 2** **Start Point** - Specify information about the starting point of the selected arc.
- The **Start X and Start Y Position** coordinates display for reference. They may

update as changes are made to other settings in this dialog.

- **Start Direction** - Specify the angle of a tangent line at the start of the arc.
- **3 End Point** - Specify information about the end point of the selected arc.
- **End X** - Specify the X coordinate for the end of the arc.
- **End Y** - Specify the Y coordinate for the end of the arc.
- **End Direction** - The the angle of a tangent line at the end of the arc displays for reference. This displays for reference only but may update as changes are made to other settings in this dialog.

• **4** Define the selected arc's **Chord**, which is the straight line between its start and end points.

- **Chord Length** - The straight line distance between the two ends of the arc.
- **Chord Angle** - Specify the angle of the chord.

Line Style Panel

For information about the LINE STYLE panel, see "Line Style Panel" on page 124.

Arrow Panel

For information about the ARROW panel, see "Arrow Panel" on page 125.

Circle/Oval/Ellipse Specification Dialog



Select a circle, oval or ellipse and click the **Open Object** edit button to open the **CAD Circle, Oval or Ellipse Specification** dialog.

Line Style Panel

For information about the LINE STYLE panel, see "Line Style Panel" on page 124.

Fill Style Panel

For information about the FILL STYLE panel, see "Fill Style Panel" on page 129.

Polylines

A polyline consists of two or more line and/or arc segments that are attached at their endpoints. Select **CAD>> Rectangular Polyline**, then click and drag from corner to corner to create a rectangular-shaped, closed polyline. A closed polyline measuring 2' x 2' (600 mm x 600 mm) can also be created by clicking once while the **Rectangular Polyline** tool is active.

You can also create a polyline by drawing lines and/or arcs end-to-end, allowing the end of each new object to snap to the end of the previous one.

Line- and arc-based objects will only snap together to form a polyline if they are on the same layer and share identical attributes such as color, line style, and arrow specifications.

If one end of the polyline is connected to the other, it becomes a closed polyline.

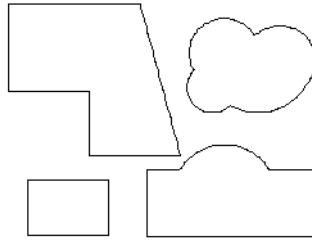

Closed Polylines

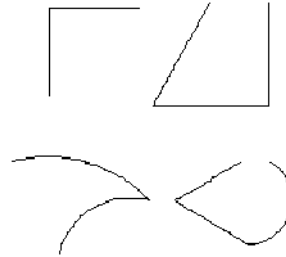

Open Polylines

Polylines can be copied, moved, reshaped, or resized as a single unit.

Once created, polylines can be edited in a variety of ways. See “Editing Open Polyline

Based Objects” on page 99 and “Editing Closed-Polyline Based Objects” on page 101.

Polyline Specification Dialog



Select an open polyline, closed polyline, spline or Electrical connection and click the **Open Object** edit button to open the **Polyline Specification** dialog.

Polyline Panel

The POLYLINE panel is found in the specification dialogs for a variety of objects throughout the program. It states:

- The **Length** of an open polyline-based object;
- The **Perimeter** of a closed polyline-based object;
- The **Area** of a closed polyline-based object;
- The **Volume** of a closed polyline-based object.

If the polyline is not closed, the Area and Volume are described as “Not closed”. The Volume of a 2D polyline will always be 0, even if it is closed.

Selected Line Panel

The SELECTED LINE panel is available when the selected edge of the polyline is a line as opposed to an arc and is not available if the selected object is a spline. See “Editing Line Based Objects” on page 94.

Moving the End of a line segment moves the start of the next connected line, if there is one.

This panel is similar to the LINE panel of the **Line Specification** dialog. See “Line Panel” on page 123.

Selected Arc Panel

The SELECTED ARC panel is available when the selected segment of the polyline is an arc as opposed to a line. It is not available if the selected object is a spline.

This panel is similar to the ARC panel of the **Arc Specification** dialog. See “Arc Panel” on page 126.

Line Style Panel

This panel is similar to the LINE STYLE panel in the **Line Specification** dialog. See “Line Style Panel” on page 124.

Fill Style Panel

The information on the FILL STYLE panel for closed polylines is similar to that for many other objects in the program, including closed CAD shapes and a variety of architectural objects.

The FILL STYLE panel is not available for Electrical Connections as this tool cannot be used to form closed shapes.

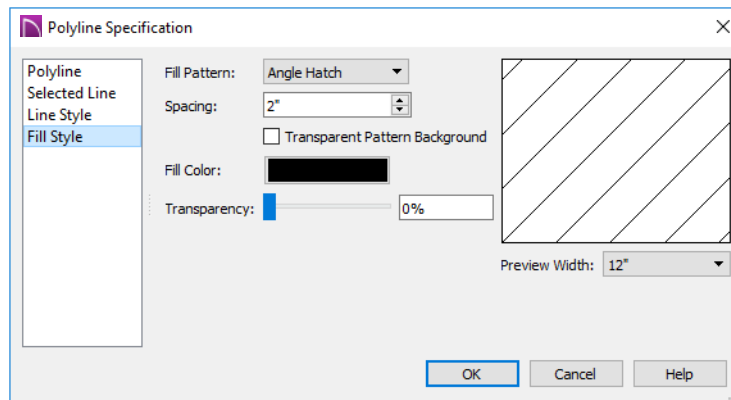

Specify the characteristics of the selected object’s fill **Pattern**. When “None” is the selected pattern Type, the rest of these settings are disabled.

- Choose a pattern **Type** from the drop-down list.
- Specify the **Spacing** of the selected fill pattern. Not available for “Solid” fill.
- Check **Transparent Pattern Background** to make the spaces between fill pattern lines transparent, allowing any objects behind the fill pattern to be visible through it. Not available for “Solid” fill.
- **Specify** the **Color** of the lines that make up the fill pattern, or the fill color of “Solid” fill, by clicking the color bar. The layer color is used by default. See “Select Color Dialog” on page 372.
- Use the **Transparency** slider bar or text field to control how transparent the fill

pattern lines are. This setting also affects the transparency of Solid fill colors.

A preview of the selected pattern displays to the right. As changes are made to the settings on this panel, the preview will update.

- Choose a **Preview Width** from the drop-down list. This value controls how large an area the preview represents. The selected value indicates the length of

each side of the preview in actual plan inches (mm).

Arrow Panel

The ARROW panel is available for most open polylines and splines and is similar to the ARROW panel of the **Line Specification** dialog. See “Arrow Panel” on page 125.

The ARROW panel is not available for closed polylines.

Box Specification Dialog



Select a CAD box and click the **Open Object** edit button to open the **Box Specification** dialog. See “Draw Box” on page 122.

Line Style Panel

For information about the LINE STYLE panel, see “Line Panel” on page 123.

Fill Style Panel

For information about the FILL STYLE panel, see “Fill Style Panel” on page 129.

Splines



A Spline is a curve that passes smoothly through a set of points. Splines are typically used in situations where there is an irregular curve. A contour line is a typical example. Splines are useful wherever a free-flowing curve is needed.

Once created, splines can be selected and edited. See “Polyline Specification Dialog” on page 128.

To use the Spline tool

1. Select CAD> **Spline** .

2. Click and drag to draw the first spline segment just as you would a line. A single spline segment looks identical to a line, in fact. You may need to turn off **Angle Snaps**  to draw freely.

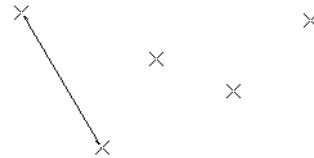

3. Draw the second segment from the end of the first at a different angle. **Object Snaps**  should be on to assure that new segments attach correctly to the ends of previous segments.

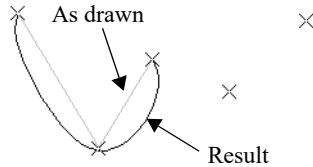

4. As soon as two straight spline segments connect end-to-end, the straight segments become a curve that passes through the endpoints defined by the original segments. Each point is called a vertex.
5. Draw a few more segments, connecting each to the free end of a previously drawn segment.

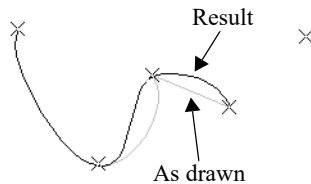

6. Notice as additional segments are drawn that the spline changes the curvature of

the previous segment to create a continuous curve between the last three points.

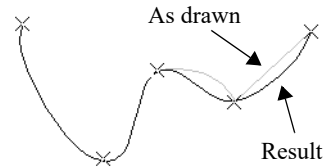

7. Form a closed spline by drawing a segment between its two free ends.

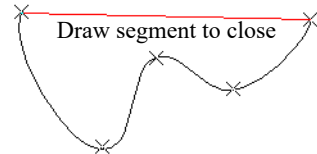

8. The result is an irregular curve that flows smoothly through each vertex.

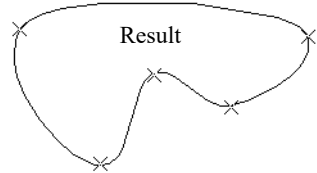

Spline-based objects will only snap together to form a single spline if they share identical attributes such as color, line style, and arrow specifications.

Displaying CAD Objects

As with architectural objects, the display of CAD objects is controlled in the **Display Options** dialog. See “Display Options Dialog” on page 88.

CAD objects can be drawn in floor plan view. They are 2D objects only, though, so they cannot be seen in any view other than the one they are drawn in and are never visible in camera views or overviews. See “Architectural vs CAD Objects” on page 78.

Drawing Groups

Each object in a plan file is included in a Drawing Group, which influences whether it displays in front of or behind other objects. By default, all CAD objects are placed in the same Drawing Group. Their drawing order relative to one another is based on the order in which they were placed: an object will

display in front of any objects that were created before it was.

Once created, however, the drawing order of CAD objects can be customized. See “Drawing Groups” on page 86.

Walls and Railings

Walls are the single most important building component in Home Designer Interiors. By creating walls and defining the rooms created by the walls, you are telling the program how you want the 3D model built.

There are several ways that walls can be created in Home Designer Interiors. The most common is to simply draw them with the Wall Tools.

In addition, exterior walls can be generated automatically when a new floor is built by using another floor as a model. For more, see “Adding Floors” on page 289.

Another feature that can be used to generate walls automatically is the **Space Planning Assistant**. See “Space Planning” on page 49.

Chapter Contents

- Wall Defaults
- Wall Tools
- Railing Tools
- Exterior and Interior Walls
- Foundation Walls
- Railing Tools
- Room Dividers and Invisible Walls
- Hatch Wall
- Break Wall
- Drawing Walls
- Connecting Walls
- Displaying Walls
- Measuring Walls
- Editing Walls
- Aligning Walls
- Roof Directives in Walls
- Attic Walls
- Wall Type Definitions
- Wall Specification Dialog
- Railing Specification Dialog
- Wall Hatch Specification Dialog



Wall Defaults





Default Settings can be accessed by selecting **Edit> Default Settings**. Click on “Walls” and click the **Edit** button to open the **Wall Defaults** dialog.

The settings in the wall defaults dialogs determine what wall types are drawn when the different wall tools are used. It is a good idea to be familiar with these settings and how they relate to your style of building.

Exterior and Interior Wall Defaults Dialogs

Specify the initial attributes of walls drawn using the **Exterior Wall**  and **Interior Wall**  tools in the **Exterior** and **Interior Wall Defaults** dialogs. See “Wall Tools” on page 134.

- 1 Select the wall type drawn using the **Exterior Wall**  tool.
- 2 Select the wall type drawn using the **Interior Wall**  tool.
- 3 Uncheck **Auto Rebuild Attic Walls** to prevent Attic walls from automatically generating when the model changes. When checked, Attic Walls are automatically generated. See “Attic Walls” on page 151.

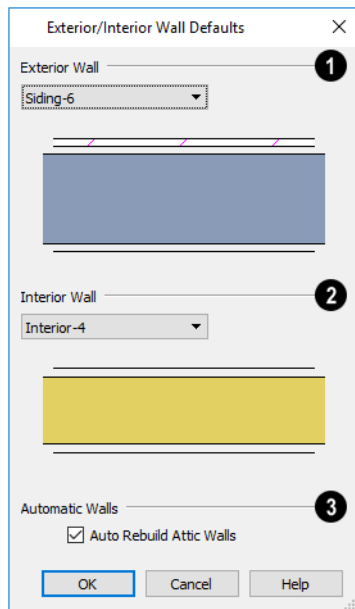

Wall Tools

Select **Build> Wall** to access the Wall Tools. The type of wall drawn by each wall tool is

specified in its corresponding defaults dialog.

The **Curved Wall** tools are similar to their corresponding **Straight Wall Tools**. Select **Build> Wall** to access these tools as well.

Exterior Walls



The **Exterior Wall** and **Curved Exterior Wall** tools draw walls using the default wall type specified for exterior walls in the **Exterior/Interior Wall Defaults** dialog. See “Exterior and Interior Walls” on page 136.

Interior Walls



The **Interior Wall** and **Curved Interior Wall** tools draw walls using the wall type specified for interior walls. The interior wall type is defined in the **Exterior/Interior Wall Defaults Defaults** dialog.

Note: Whether a wall is recognized as an exterior or interior wall by the program is determined by its position in the model, not by the tool used to draw it. See “Exterior and Interior Walls” on page 136.

Half-Walls



The **Half-Wall** and **Curved Half-Wall** tools create solid

railings: walls that are 36” (900 mm) high topped with a handrail.

Room Dividers



Room Dividers are Invisible walls with a thickness of 0” (mm) that are used to define separate room areas in a plan. They can display in floor plan view but not in 3D views. See “Room Dividers and Invisible Walls” on page 137.

Hatch Wall



The **Hatch Wall** tool applies a hatch pattern to a wall that displays in floor plan views. You must click the wall that you want to apply the hatch pattern to. You can then select the hatch and resize it if you want to only hatch a portion of a wall. See “Hatch Wall” on page 138.

Break Wall



The **Break Wall** tool applies a break in a wall. Once a wall is broken, the two wall segments are separate walls that can be modified independent of each other. See “Break Wall” on page 139.

Railing Tools

Select **Build> Railing** to access the Railing Tools.

Each of the tools in this family have both Straight and Curved versions, and are created and edited just like walls. See “Drawing Walls” on page 139.

To create a break in a railing for a stairway or other access, use a **Doorway** . This keeps the railing continuous and maintains room definition. See “Room Definition” on page 163.

When first drawn, railings are specified as **No Locate**, which prevents **Auto Exterior**

Dimensions  from locating them. This attribute may also be helpful if you do not want a railing to divide an area into two separate rooms. See “General Panel” on page 153.

 The **Railing** and **Curved Railing** tools create railings that are primarily used to define interior spaces.

Railings are ideal for a number of tasks:

- Creating changes in floor and/or ceiling height. See “Floor and Ceiling Heights” on page 172.
- Creating stairwells. See “Creating a Stairwell” on page 308.



- Drawing decks. See “Decks” on page 171.

Railing Types

A variety of railing types can be specified in the **Railing Specification** dialogs. See “Rail Style Panel” on page 157. Available types include:

- **Baluster** creates railings composed of newel posts, balusters, a railing, and an optional bottom rail.
- **Solid** produces a framed railing wall, or Half Wall. See “Half-Walls” on page 135.
- If **Panels** is selected, you can choose a panel style such as glass or ironwork from the library. See “Newels/Balusters Panel” on page 159.

Newels and balusters do not display in floor plan view.

Exterior and Interior Walls

 Most walls are drawn using either the **Straight Exterior Wall** and **Straight Interior Wall** tools.

 Exterior and interior walls can also be drawn using the **Curved Exterior Wall** and **Curved Interior Wall** tools.

The only difference between the Exterior and Interior Wall Tools is the wall type used: Exterior Walls use a wall type set up to model a wall with siding, while Interior Walls model interior walls with sheetrock. You can specify the default wall type for each tool in the **Exterior/Interior Wall Defaults** dialog. See “Exterior and Interior Wall Defaults Dialogs” on page 134.

To draw a wall using a different wall type, you can change the default wall type for either tool in the **Exterior** and **Interior Wall Defaults** dialogs. You can also draw a wall using the default type and then change the wall type in the **Wall Specification** dialog.

Whether a wall is recognized by the program as an actual exterior or interior wall is based on its position in the model, not by which tool you use to draw the wall.

- Any wall or wall segment that is entirely surrounded by interior room areas is considered to be an interior wall.
- Any wall or wall segment that defines an exterior room or is exposed to the outside of the building is considered to be an exterior wall. See “Room Types” on page 165.

Foundation Walls

Foundation walls are similar to the interior and exterior walls but also have a footing. Foundation walls are created automatically when a foundation floor is created. See “Building a Foundation” on page 278.



Room Dividers and Invisible Walls

 The **Room Divider** tool is used to define separate room areas in a plan; typically, by dividing a large room area into two or more smaller areas. See “Room Definition” on page 163.

Common uses for Room Dividers  include dividing areas of an open floor plan into areas with different purposes.

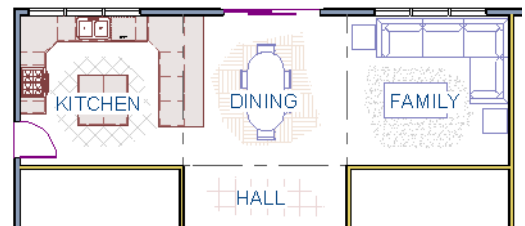

Room Dividers separate this dining area from adjacent rooms

Room Dividers can also be used to define areas with different floor or ceiling materials or heights.

Room Dividers  are simply walls that are specified as Invisible and have a single layer of an “Air Gap” material with a thickness of 0” (mm).

If a zero-thickness **Room Divider**  separates two rooms with different floor and/or ceiling heights, its wall type will be changed to the current plan’s default Interior Wall so that the platform step created by the height difference can be enclosed.

Any wall, regardless of its wall type or thickness, can also be specified as Invisible - or vice versa - in the **Wall Specification** dialog. See “General Panel” on page 153.

Room Dividers are placed on the “Walls, Invisible” layer by default, as are walls that are specified as Invisible.

Walls specified as Invisible can display in floor plan view but not in 3D views or the

Materials List. See “Displaying Walls” on page 142.

It is not possible to place doors, windows, or fireplaces into an Invisible wall; however, if a wall with openings in it is specified as Invisible, any openings in it will remain.

Important Notes on Invisible Walls

- Floor, wall and ceiling areas are calculated separately for rooms divided by Invisible walls.
- Cabinets, fixtures and furniture can be moved freely through Invisible walls.
- Invisible walls can be drawn through a cabinet to attach to the wall behind.
- Room Dividers are automatically generated to connect “island” rooms to the larger structure around them. See “Room Definition” on page 163.

Hatch Wall



The **Hatch Wall** tool can be used to fill wall segments with a single hatch pattern in floor plan view.

To apply wall hatching, select **Build> Wall>**

Hatch Wall , then click on a wall. The hatch pattern covers the entire length and width of the wall segment.

Note: The Hatch Wall tool cannot be used to apply a hatch pattern to Invisible Walls. See “Room Dividers and Invisible Walls” on page 137.

Hatch Wall  places a hatch pattern across all layers of the selected wall layers, covering any fill styles specified for that wall type.

Once created, wall hatching can be selected, edited and deleted much like other line-based objects. See “Editing Line Based Objects” on page 94.

If you use the **Hatch Wall**  tool to apply a hatch pattern to a wall that has been divided into multiple segments using the **Break**

Wall  tool, the pattern is only applied to

the segment that you clicked on. See “Break Wall” on page 139.

Like doors and windows, wall hatching cannot extend across multiple wall segments. Unlike these objects, hatching cannot be located by dimension lines.

The wall hatch pattern can be specified in the **Wall Hatch Specification** dialog. See “Wall Hatch Specification Dialog” on page 160.

When editing or deleting wall hatching, make sure that it is selected rather than the wall by noting that “Wall Hatching” displays in the Status Bar. See “The Status Bar” on page 29.

Break Wall

To divide a wall or railing, select **Build> Wall> Break Wall** and click on the wall. The wall is divided into two wall sections at the point where you click.



The **Break Wall**  tool remains active, so you can continue to place breaks in walls. When you are finished, select a different tool.

If a wall break is placed near the intersection of two walls, the break is positioned at the center of the intersection. Note, too, that a break cannot be placed within 12” of an existing break or in the same location as a wall opening.

Once a break is placed, click the **Select Objects**  tool and select the original wall. If edit handles display near the break, the wall was correctly broken.

Walls separated by a break can be rejoined. Select one of the segments, then click on the end edit handle located at the break and drag it a few plan inches (mm) away from the break. See “Connecting Walls” on page 141.

The **Break Wall**  tool can be used to create aligned walls on either side of a gap. See “Creating a Nook” on page 149.

Drawing Walls

Walls, railings, and fencing are drawn by clicking and dragging from end to end. Walls can be drawn in floor plan view, camera views, and overviews.

Drawing walls to create a floor plan is simple if you keep a few things in mind:

- Draw exterior walls first to define the building’s footprint, then draw the interior walls after the perimeter is in place.
- It is easiest to draw walls at the approximate location and length needed and then move or resize them precisely using dimensions later. See “Moving Objects Using Dimensions” on page 192.
- When drawing and positioning exterior walls, make sure **Grid Snaps**  are enabled. Once these walls are in place, you may prefer to turn Grid Snaps off to



draw and position interior walls and other objects. See “Grid Snaps” on page 79.

- As walls are drawn, “sticky” points identify points that are either collinear or orthogonal to the end points of other walls, making alignment easier. See “Extension Snaps” on page 78.
- When walls enclose an area to form a room, the program will orient all exterior walls so that the siding material faces outward.
- To flip the layers of a wall after it is drawn, select it and click the **Reverse Layers**  edit button. See “Editing Walls” on page 146.
- Initial wall heights are determined by the default floor and ceiling heights of the current floor.

Wall Angles

With very few exceptions, walls should be drawn and edited with **Angle Snaps**  enabled. Walls that are drawn at irregular angles can result in wall connection, alignment, and room definition problems.

If a wall is drawn at an off-angle, the



Irregular Wall Angle  icon will follow the mouse pointer and a Caution  symbol will display over the problem wall in floor plan view.

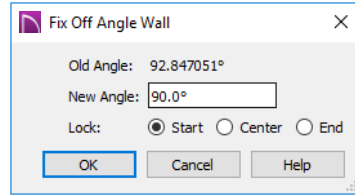

To correct the wall’s angle, click on the Caution  symbol that displays over the wall and select **Fix Off-Angle Wall** from the contextual menu. In the **Fix Off Angle Wall** dialog:



- The **Old Angle** is stated for reference.
- Enter a **New Angle** in the text field.
- Specify whether to **Lock** the **Start**, **Center**, or **End** point of the wall when its angle is changed.

There are several other ways to fix a selected wall if it has been drawn at an off-angle:

- Click the **Open Object**  edit button and specify the correct angle. See “General Panel” on page 153.
- Click and drag an end edit handle until the wall snaps to an Allowed Angle. See “Angle Snaps” on page 79.
- If the wall in question should be aligned with a wall directly above or below it, click the **Align with Wall Above**  or **Align with Wall Below**  edit button. See “Aligning Walls” on page 149.

To prevent the **Irregular Wall Angle**  icon from displaying when you need a wall to be at an irregular angle, click on the Caution  symbol that displays over the wall and select **Ignore Off Angle Wall**. You can also suppress the Caution s symbol specifying the needed angle in the wall’s specification dialog.

Wall Positioning

The recommended method of drawing walls is to draw them at their approximate location and length, then move them into position with accuracy using dimensions. To make this task quick and efficient:

- Notice the temporary wall that displays as you draw. Its length and angle display in the Status Bar at the bottom of the window and adjust as you move the mouse. Release the mouse button to draw the wall at the displayed length and angle. See “The Status Bar” on page 29.
- Use Snaps to help ensure proper wall alignment and orientation. See “Snap Behaviors” on page 78.

Once walls are drawn, they can be accurately dimensioned and moved as needed. See “Measuring Walls” on page 144.

Wall Openings

To create a door or doorway, do not draw wall sections with a gap between them. Walls should be drawn to completely enclose rooms, and then door and window objects should be placed in the walls to create openings later. See “Doors” on page 209 and “Windows” on page 225.

Masonry fireplaces placed in walls are also considered to be wall openings. See “Fireplaces” on page 282.

Temporary Dimensions

Temporary dimensions will display along the length of a wall as it is drawn, helping you draw walls to the desired length. Although dimensions display as you are drawing, you do not need to position walls precisely when you first draw them: they can be easily moved into place at any time. See “Editing Walls” on page 146.

Drawing Curved Walls

To draw a curved wall or railing, select a curved wall tool, click at the point where you would like the wall to begin, then drag along the desired curve. Release the mouse button to create the wall.

A straight wall can also be converted into a curved wall and vice versa using the **Change**

Line/Arc  edit button. See “Change Line/Arc” on page 115.



To create a room in the shape of a circle, you must draw two curved walls.

Space Planning Assistant



The **Space Planning Assistant Tools** allow you to place and arrange room boxes that can then be converted into a fully editable house plan, including walls. See “Space Planning” on page 49.

Connecting Walls

When walls are drawn sufficiently close to one another, they will snap together to form an intersection. This snapping occurs when the walls’ center lines are within a distance

defined by the larger of the two walls’ widths and will occur even when **Object Snaps** are turned off. See “Object Snaps” on page 78.



If the two walls in question have identical specifications and are collinear, they will merge to become a single wall. See “Aligning Collinear Walls” on page 149.

When three or more walls connect to form a completely enclosed area, that area defines a room. See “Rooms” on page 163.

When walls snap together to form an intersection and **Object Snaps** are enabled, the program joins them at their Main Layers. See “Aligning Walls” on page 149.

- The wall that is being drawn or edited will move, lengthen, or shorten slightly to meet the other wall.
- The other wall will not move; however, its length may be affected.

Fix Wall Connections

Occasionally, intersecting walls may not properly connect. When this is the case and the connection in question is on the current floor, a Caution  symbol will display at the problem location in floor plan view and the Connect Walls  icon will follow your mouse pointer.

Click on the Caution  symbol that displays over the wall to open a contextual menu:

- Select **Delete** to delete the wall.
- Select **Ignore Unconnected Wall** to leave the wall unchanged and suppress the Caution symbol.

Removing Wall Breaks

The **Break Wall**  tool allows you to break a wall into two or more separate wall segments. See “Break Wall” on page 139.

To merge two collinear walls separated by a break, select one of the segments, then click on the end edit handle located at the break and drag it a few plan inches (mm) away from the break.

If the two walls do not merge, either one or both walls have been moved and they are no longer collinear, or one or both has been edited in some way and they are no longer identical. Open the **Wall Specification** dialog for each wall and determine how they differ. See “Wall Hatch Specification Dialog” on page 160.

Displaying Walls



The display of walls in all views is controlled in the **Display Options** dialog. See “Displaying Objects” on page 87.

If a “Walls” layer is turned off, any doors and windows placed in walls on that layer will not display, either. See “Displaying Doors” on page 212 and “Displaying Windows” on page 230.

In Floor Plan View





There are several options for controlling how walls are displayed in floor plan view. In the **Display Options** dialog, you can specify whether or not various types of walls display. Walls are placed on layers with “Walls” at the beginning of the layer name, such as “Walls, Normal”.

Note: In floor plan view, railings not specified as Solid display their Main Layer regardless of whether “Walls, Layers” or “Walls, Main Layer Only” is turned on.

It is sometimes helpful to display the walls from a floor other than the current floor. To do this, select and display a reference floor. See “The Reference Floor” on page 293.

Notification Icons

Occasionally, the program may detect a problem with one or more walls in a plan. When this is the case, notification icons will display on the floor where the problem has occurred:

- If a wall is drawn at an off-angle, the **Irregular Wall Angle**  icon will follow the mouse pointer and a Caution  symbol will display over the problem wall in floor plan view.
- If there is a problem with a wall connection, the **Connect Walls**  icon will follow the mouse pointer and a Caution  symbol will display at the problem location.

The recommended response to either situation is to fix the problem, although you can choose to ignore it if you prefer. See “Wall Angles” on page 140 and “Fix Wall Connections” on page 142.

If an issue has been ignored, notification icons for it will not display. Select **Tools> Checks> Reset Notification Icons** to display any suppressed notifications so that any wall angle or connection problems can be corrected.

In 3D Views

As in floor plan view, the display of walls can be controlled by layer in the **Display Options** dialog.

While most architectural objects in the program can display in both floor plan and 3D views, a few cannot. Invisible walls and Wall Hatching are examples of objects that do not display in 3D.

Wall Materials

There are several ways that materials can be assigned to walls. See “Rooms” on page 163.

When you draw a wall, it uses the materials specified in its wall type definition. See “Wall Type Definitions” on page 152.

You can change the surface material of an individual wall in the **Wall Specification** dialog. If you select “Use Default” as the material and the wall is used to define a room, the program refers to the material specified in the **Room Specification** dialog. See “Wall Specification Dialog” on page 153.

You can also change a room’s wall material in the **Room Specification** dialog. See “Materials Panel” on page 366. To restore the default Wall Type material, select **Use Default** in the **Select Material** dialog. See “Select Material Dialog” on page 367.

Wall materials can also be changed using the **Material Painter**  tool, but bear in mind that depending on which Material Painter Mode is in use, only a portion of the wall may be painted and that the entire room may be affected rather than the individual wall.

See “Material Painter and Walls” on page 365.

Note: Wall materials that are specified on the Materials panel of either the Wall or Room Specification dialog are not calculated in the Materials List.

In the Materials List

The materials that make up wall assemblies are listed under different Categories in the Materials List:

- **Siding** - Lists all materials located outside of each wall’s Main Layer, such as siding, sheathing, and housewrap.
- **Framing** - Lists the Main Layer material for all walls as well as railings specified as Solid. Non-framed walls’ Main Layer materials are also listed here when those walls are not specified as Foundation.
- **Insulation** - Insulation is calculated for all exterior walls that are not specified as Railing, regardless of the wall type definition.
- **Wallboard** - Lists all materials located inside of each wall’s Main Layer, such as

drywall. Includes all materials aside from framing, concrete, and rebar in walls that do not define rooms.

Does not include Wall Coverings or materials specified in either the **Room** or **Wall Specification** dialog. See “Materials Panel” on page 157.

- **Interior Trim** - Lists base, crown and chair rail moldings, and Wall Covering materials specified in the **Wall** and **Room Specification** dialogs. See “Wall Covering Panel” on page 156.
- **Foundation** - Lists the concrete for all walls specified as Foundation as well as their footings. See “Foundation Walls” on page 137.

With the exception of wallboard, windows and doors are taken into account in the calculation of these totals.

Additional wall-related information is listed in the **General** category, including the total linear feet of each wall type per floor and the thermal envelope wall area per floor. See “Conditioned Area” on page 432.

Measuring Walls

Accurate wall measurements are an essential aspect of any drawing, and can be achieved by following two basic rules:

- Be aware of what part of a wall assembly dimensions are locating;
- Position walls using dimensions rather than edit handles or edit tools.

These rules can easily be met when you keep the following recommendations in mind.

Use Dimension Defaults

Dimensions can be set to locate walls at their Dimension Layers or at their surfaces. Before drawing dimensions - and particularly, before using them to move your walls into position - make sure that your

Dimension Defaults are set up to meet your needs. See “Dimension Defaults Dialog” on page 183.

If a wall is specified as Invisible, dimensions will locate it at its centerline regardless of your Dimension Defaults settings. If the Invisible wall divides rooms with different floor heights, dimensions will locate the edge of the wall facing the room where the floor is lower.

Edit Dimension Lines

Once a dimension line has been drawn, its extension lines can be edited to locate a number of locations on a wall assembly:

- The exterior surface
- The Main Layer’s exterior
- The center line of the wall assembly
- The Main Layer’s center line
- The Main Layer’s interior
- The interior surface

See “Editing Extension Lines” on page 191.

Moving Walls Using Dimensions

By far, the most precise method of positioning walls is using dimension lines. To produce accurate measurements, remember to:

- Be aware of what part of your walls is being located by dimensions.
- Avoid specifying dimension values with greater accuracy than your dimensions are set to display. See “Format Panel” on page 185.

See “Using Dimensions” on page 147.

Use Object, Angle and Grid Snaps

Object Snaps, Angle Snaps, and Grid Snaps make it easier to align walls when they are being drawn as well as when they are edited. See “Snap Behaviors” on page 78.

Object Snaps help to ensure consistent wall connections and are particularly helpful when aligning collinear walls.

When **Grid Snaps** are enabled, walls are drawn on a regularly spaced grid, which helps avoid inaccurate wall placement. This can become particularly important if you forego positioning walls using dimensions in favor of using edit handles to move them.



Using Grid Snaps is recommended when you are laying out exterior shell walls, but may be inconvenient when positioning interior walls or other objects.

Angle Snaps make it easy to accurately draw walls at regular angles, ensuring walls that are truly parallel or perpendicular to one another and separated by consistent distances.

No Locate

If a wall is specified as **No Locate** in the **Wall Specification** dialog, it will be ignored by **Auto Exterior Dimensions**  in floor plan view, as will any doors or windows placed in it. See “Dimensions” on page 183.

By default, **Railings**, **Deck Railings**, and **Room Dividers** are specified as No Locate. See “General Panel” on page 153.

Once a dimension line has been created, it can be edited so that it locates a No Locate

wall or railing that is perpendicular to it. See [Editing Dimension Lines](#).

Editing Walls

Walls can be selected individually and as a group in all views. When a wall is selected, it displays edit handles and an edit toolbar that can be used to edit it in various ways. When a wall is selected, temporary dimensions will also display.

The ways in which a wall can be edited depends on the current view and which edge is selected. See [“Selecting Objects”](#) on page 92.

Selecting Walls

- When you try to select a wall in a 3D view, the interior or exterior room that it defines may be selected first. Click the

Select Next Object  edit button or press the Tab key on your keyboard to select the wall itself.

- In floor plan view, if wall hatching has been applied to a wall using the **Hatch**

Wall  tool, the hatching may be selected first. Click **Select Next**

Object  to select the wall itself. See [“Hatch Wall”](#) on page 138.

Using the Edit Handles

A selected wall can be modified in a variety of ways using its edit handles in any view. The handles that are available will depend on the current view type.

- In floor plan view, straight and curved walls can be edited like other line- and

arc-based objects. See [“Editing Line Based Objects”](#) on page 94 and [“Editing Arc Based Objects”](#) on page 96.

- In a camera view or overview, click on the top surface of a wall to display the same edit handles as in floor plan view, allowing you to rotate, move, and extend or shorten the length of the wall.
- Moving a wall in any view will move any cabinets attached to that wall, as well.
- In a camera view or overview, click on an interior or exterior surface to display an edit handle at the center of each side edge, allowing you to shorten or lengthen the wall. Curved walls can be shortened in this manner, but not lengthened.
- When a wall is connected to other walls, it can only be moved perpendicular to itself or, in the case of curved walls, perpendicular to its chord using the Move edit handle.

In the Specification Dialog



The appearance and structure of walls can be customized in the **Wall**

Specification dialog. See [“Wall Specification Dialog”](#) on page 153.

The characteristics of the roof directly above a selected wall can also be specified in the **Wall Specification** dialog. See [“Roof Panel”](#) on page 154.

Using the Edit Tools







A selected wall or walls can be edited in a variety of ways using the buttons on the edit toolbar. See “The Edit Toolbar” on page 24.

Using Dimensions



Automatic, manually-drawn, and temporary dimension lines can be used to both resize and move walls with accuracy. Select a wall, then click on a dimension line that locates it and type in the value that you need. See “Moving Objects Using Dimensions” on page 192.

When a wall is resized using dimensions, the inline text field used to edit the dimension will have three unique buttons:

- Horizontal walls have **Move Left End** , **Move Both Ends** , and **Move Right End** .
- Vertical walls have **Move Top End** , **Move Both Ends** , and **Move Bottom End** .

Choose the option that you want to use before pressing the Enter key.

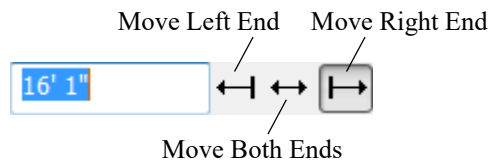

If both ends of the selected wall intersect walls that are not parallel to one another, a fourth option will be available: **Move Along**

Rails . When this option is used, the selected wall both resizes and changes

position so that it remains connected to the other walls when you press the Enter key.

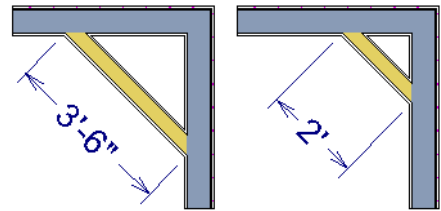

Move Along Rails resizes and moves a selected wall.

Depending on your **Dimension Defaults** settings, dimension lines may locate wall surfaces or Main Layers. See “Dimension Defaults Dialog” on page 183.

Wall Thickness

The initial thickness of a wall is determined by its wall type.

You can specify a selected wall’s thickness in its **Wall Specification** dialog. See “General Panel” on page 153.

If a selected wall’s thickness is changed:

- A copy of the wall’s wall type is created with the same name but appended with a number equal to the thickness of the structural layer, and that new type is assigned to the wall.
- The change in thickness will be applied to new wall type’s structural layer.
- The structural layer must be at least 1/16” thick, and the wall’s thickness cannot be less than the original wall type’s total thickness minus the thickness of its structural layer.

If a wall type’s thickness is modified, the wall will resize about the outside edge of its

structural Layer. In some instances, the wall may appear to move as a result of changes made to the thicknesses of its layers.

Wall Heights

The height of a wall is controlled by the ceiling height of the room(s) it defines. If the ceiling or floor height of a room is changed, the height of the walls that define it also change.

- The initial ceiling height for all rooms on a floor is set in the **Floor Defaults** dialog for that floor. See “Current Floor Defaults” on page 165. Whenever possible, it is best to set all ceiling heights using the default.
- The ceiling height of a single room can be set in its **Room Specification** dialog. See “General Panel” on page 176.

Wall Length

Wall length can be modified in several different ways:

- Using dimensions. See “Measuring Walls” on page 144.
- In the **Wall Specification** dialog. See “General Panel” on page 153.
- By dragging the end edit handles. See “Editing Line Based Objects” on page 94 and “Editing Arc Based Objects” on page 96.

Bear in mind that if you try to resize a wall by a small amount using one of its edit handles and that wall is connected to another wall at that end, its length will not change because its end will snap back to the existing intersection. See “Connecting Walls” on page 141.

The most accurate way to specify wall length is using dimensions. By default, wall length is measured at the outside edge of the Main Layer. You can instead specify that dimension lines locate surfaces in the **Dimension Defaults** dialog. See “Dimension Defaults Dialog” on page 183.

Editing Straight/Curved Wall Combinations

If you move a straight wall connected to a curved wall with a locked center, the curved wall extends along its curve and the straight wall will either lengthen or shorten as needed to stay connected to the curved wall.

If the connection between the straight and curved wall cannot be maintained because of the curved wall’s radius, it will be broken.

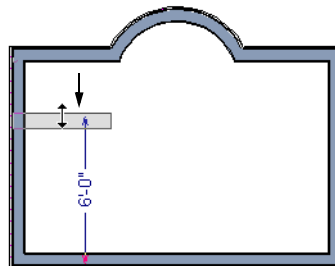

Aligning Walls

Wall alignment refers to the way wall segments line up with one another, either on the same floor or on the floor above or below. Walls may need to be aligned in a variety of situations.

To make alignment easier when drawing or resizing walls, “sticky” points identify points that are either collinear or orthogonal to the end points of other walls. See “Extension Snaps” on page 78.

Aligning Collinear Walls

Collinear walls are parallel walls connected end to end and drawn on the same floor. When collinear walls join end-to-end, the walls snap together. If these walls have the same wall type and identical specifications, and if **Object Snaps** are enabled, they will merge to become a single wall segment.

Creating a Nook

Walls can be aligned across an opening such as a nook, so that they are collinear, using the **Break Wall**  tool.

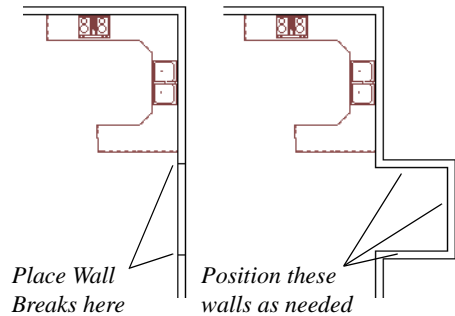

To align walls across a gap

1. Select a wall to build a nook into and click the **Break Wall**  edit button.
2. Click at a point on the wall close to one side of the nook area. Do not worry about exact placement right now.
3. Click again near the other side of the nook. Two short lines at each location where you clicked indicate Wall Breaks.



4. Right-click the middle section of the wall to select the wall section.
5. Click the middle Move handle and drag the wall outward.
6. Draw side walls to connect the wall back to the rest of the house.
7. Move these short walls using dimensions to accurately size the nook.

Aligning Walls Between Floors



Walls can be aligned between floors by clicking the **Align With Wall Above**  and **Align With Wall Below**  edit buttons.





In order for these edit tools to be available, the areas of the walls in question must be partially aligned, or overlapping.

To align walls between floors

1. Select a wall that you want to align with another wall either above or below it.

2. If the wall is above or below the other wall along only part of its length, you must click on it along that part. Select **Tools> Reference Floors> Reference Display On**  to help make sure you click on the correct part of the wall.
3. When you have selected the wall at the desired location, click either the **Align With Wall Above**  or **Align With Wall Below**  edit button.

Aligning Curved Walls Between Floors



Curved walls are aligned between floors using the same technique to align straight walls. If the centers and radii of the walls are within a few inches of each other, the **Align With Wall Above**  and **Align With Wall Below**  edit buttons are enabled for the selected wall. The selected curved wall will take on the radius and center of the referenced wall when the walls are aligned.

Roof Directives in Walls

To automatically generate a roof plane using values other than the defaults or to not generate a roof plane bearing on a particular wall (as for a gable or the sides of a shed roof), you can change the settings in the **Wall Specification** dialog. See “Roof Panel” on page 154.

Hip, Gable, and Shed Roofs

By default, the program will produce a roof plane over each exterior wall to create a hip roof. You can instead specify a gable or shed roof above the selected wall.

- Check **Full Gable Wall** to create a gable with a ridge centered above the selected wall(s).
- Check **High Shed/Gable Wall** for the side walls or the wall under the high side of a shed roof.
- You can also select a wall and click the **Change to Gable Wall(s)**  edit button, or change it back by clicking the **Change to Hip Wall(s)**  edit button.

Pitch

The default pitch for roof planes is set in the **Build Roof** dialog. However, any exterior wall can define the pitch of the roof plane built above it.

You can also specify a second, upper pitch above a given wall. Mansard, gambrel, gull wing and half-hip are examples of roof styles that use two pitches. See “Roof Tutorial” on page 57 of the User’s Guide.

Extend Slope Downward

Check **Extend Slope Downward** to extend the roof plane downward over a bump out, instead of creating additional roof planes. The two connecting walls that create the bump out must be Full Gable walls.

In the following image, the bearing wall of the bump out has **Extend Slope Downward** checked. The two short side walls are **Full Gable Walls**.

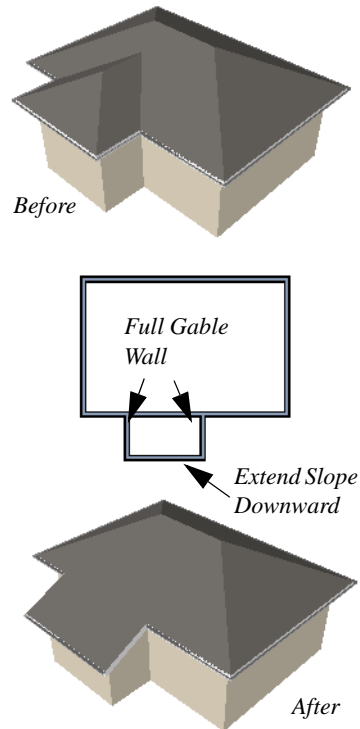

Attic Walls

In Home Designer Interiors, walls are built between the floor and ceiling platforms of the current floor. See “Floor and Ceiling Heights” on page 172. When the program detects an open space between a wall and the roof plane above it, it automatically creates an Attic Wall on the floor above that wall to fill in the gap.

Attic Walls are typically found above Full Gable Walls, forming a gable or closing the top portion of a side wall of a shed roof. Attic Walls are often found on the Attic floor, but

can be generated on other floors, as well. See “The Attic Floor” on page 293.



If you do not want to keep a particular Attic Wall in your plan, specify it as Invisible. See “Room Dividers and Invisible Walls” on page 137.

Removing Attic Walls

Occasionally, the program will generate an Attic Wall where one is not wanted. There are several ways to address this:

- Turn off the display of the “Walls, Attic” layer.
- Specify the Attic Wall as **Invisible**. See “Room Dividers and Invisible Walls” on page 137.
- Some interior Attic Walls can be suppressed by specifying space they enclose as a **Shelf Ceiling**. See “Shelf Ceilings” on page 173.
- Select the Attic Wall and **Delete**  it. The program will specify the wall as Invisible automatically. If you delete this Invisible wall, a new Attic Wall will be created.

Knee Walls

Knee Walls are a bit like Attic Walls in that they are not meant to generate to full ceiling

height. Instead, they build upward until they encounter a roof plane. Unlike Attic Walls, however, Knee Walls are used in the interior of a structure, typically to separate unused areas from rooms on the upper floor of a story-and-a-half structure. See “Room Types” on page 165.

Home Designer Interiors does not specify walls as Knee Walls automatically. If an interior wall is drawn in a location where the roof is lower than the ceiling height, you should specify it as a Knee Wall in the **Wall Specification** dialog. See “Roof Panel” on page 154.

For best results, Knee Walls should be drawn perpendicular to the pitch of the roof and should intersect with Full Gable Walls on each end.

Wall Type Definitions

Every wall drawn in a plan is assigned a wall type, and its Wall Type Definition determines its structure, its appearance in floor plan view, and its default materials.

You can specify the default wall type that is drawn by the Exterior and Interior Wall tools and can specify the wall type of any wall after it is drawn in the **Wall Specification** dialog. See “Wall Defaults” on page 134 and “General Panel” on page 153.

The structural layer of a wall type is its Main Layer, which controls a number of things:

- At intersections, walls join at the interior surfaces of their Main Layers. See “Connecting Walls” on page 141.
- Windows are placed relative to the outer surface of the Main Layer.
- Exterior walls on different floors are aligned by the exterior edges of their Main Layer.
- Roof baselines are placed at the outer edge of the Main Layer.
- Walls resize about the exterior surface of their Main Layer when their thickness or wall type is changed.
- Object Snaps locate the interior and exterior edges of a wall’s Main Layer. See “Object Snaps” on page 78.
- By default, dimension lines locate walls at their Main Layer. See “Dimension Defaults Dialog” on page 183.

Interior and Exterior Surfaces

Every wall has an interior and exterior surface - including walls in a plan that are recognized by the program as being interior walls. See “Exterior and Interior Walls” on page 136.

Having separate designations for a wall’s two surfaces allows you to specify different materials for each in the **Wall Specification** dialog. See “Materials Panel” on page 157.

In floor plan view, you can identify a selected wall’s exterior surface by the location of its edit handles, which display on the exterior of the Main Layer.

Wall Specification Dialog

 To open the **Wall Specification** dialog, select a wall and click the **Open Object** edit button.

The panels of the **Wall Specification** dialog are also found in the **Railing Specification** dialog. See “Railing Specification Dialog” on page 157.

General Panel

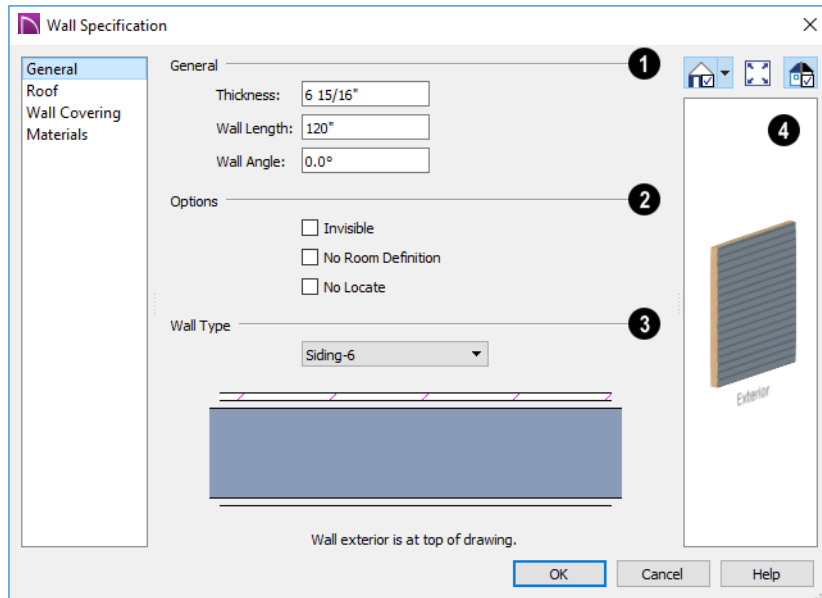

1 Specify **General** properties of the selected wall or railing.

- The **Thickness** of the selected wall displays and can be changed here. If the wall is a Post to Overhead Beam railing, this

setting also affects the width of the beam. See “Wall Thickness” on page 147.

- **Wall Angle** - The current absolute angle of the wall in a floor plan view is shown. If you type in a new angle, any walls attached to it will not move. If the selected wall is curved, this value describes the angle of the chord and cannot be modified.
 - **Wall Length** - The current length is shown. If you type a new length, any walls attached to the selected wall will not move. If the selected wall is curved, this value cannot be modified.
- 2 Check any of the **Options** to modify the selected wall accordingly. In most cases, multiple options can be selected.
- Check **Invisible** to specify the wall as invisible. Invisible walls can display in floor plan view but not in 3D views or the Materials List. **Room Dividers**  are

invisible by default. See “Room Dividers and Invisible Walls” on page 137.

- Check **No Room Def.** to display the wall in floor plan and/or 3D views but not create room definition. See “Room Definition” on page 163.
- Check **No Locate** to prevent **Auto Exterior Dimensions**  from locating the wall in floor plan view. See “No Locate” on page 145.

3 Select the **Wall Type** assigned to the selected wall from the drop-down list. A preview diagram of the selected wall type’s layers, as seen in floor plan view, displays below.

4 A preview of the selected wall, including any doors, windows, and/or fireplaces inserted into it, displays on the right. If the selected wall is specified as Invisible, its plan view will display here by default. See “Dialog Preview Panes” on page 28.

Roof Panel

Any automatically generated roof style other than a hip requires roof information to be defined in the exterior walls. On the ROOF panel, you can specify how the selected wall

interacts with the roof plan, defining the portion of the roof plan that bears on it.

The ROOF panel is not available for Foundation Walls. See “Foundation Walls” on page 137.

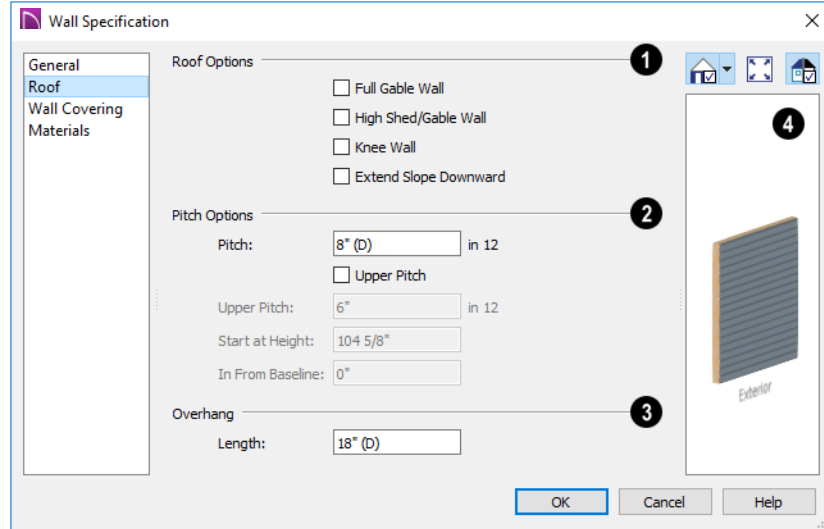

- 1 Roof Options** - Specify the shape of the wall relative to the roof.

 - Check **Full Gable Wall** to create a gable end over the selected wall.
 - Check **High Shed/Gable Wall** to specify the selected wall as the high end of a shed roof.
 - Check **Knee Wall** to define the selected interior wall as a knee wall. Only an interior wall can be defined as a knee wall. A knee wall's height is defined by the roof above, not the ceiling height. See "Knee Walls" on page 152.
 - Check **Extend Slope Downward** to continue a roof down over a bump out in an exterior wall. See "Extend Slope Downward" on page 150.
- 2 Pitch Options** - Specify the pitch or pitches of the roof plane(s) above the selected wall.

 - Enter a value to define the **Pitch** of the roof plane bearing on the selected wall.
 - Check **Upper Pitch** to create a roof with two pitches or, if the selected wall is a Full Gable Wall, a half hip condition.
 - Enter the **Pitch** of the second, upper roof.
 - Specify the **Height** that the Upper Pitch **Starts at**, or define the distance **in from Baseline** that the second pitch begins. The two values are dynamic. Press the Tab key to update the relative numbers.
- 3** Specify the **Overhang Length**, which is the horizontal distance from the outside of the wall's Main Layer to the eave. See "Wall Type Definitions" on page 152.
- 4** A preview of the selected wall, including any doors, windows, and/or fireplaces inserted into it, displays on the right. See "Dialog Preview Panes" on page 28.



Additional information about using the settings on this panel can be found in the “Roof Tutorial” on page 57 of the Reference Manual.

Wall Covering Panel

The WALL COVERING panel is also available in the **Room Specification** dialog. See Room Specification Dialog.

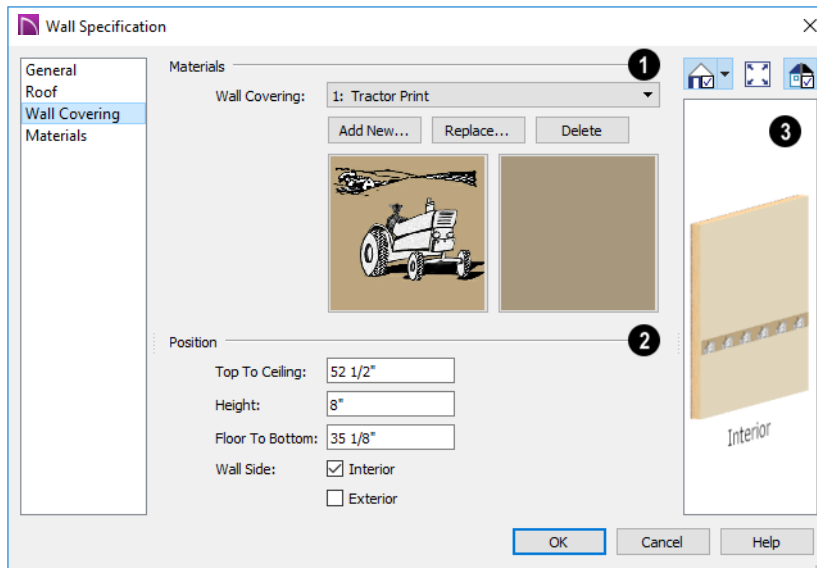

1 All wall covering materials applied to the selected wall are listed here. Select one from the drop-down list to edit its position or remove it from the wall.

- Click **Add New** to apply a new wall covering to the selected wall. See “Select Library Object Dialog” on page 344.
- Click **Replace** to replace the current wall covering with a new one from the library.
- Click **Delete** to remove the current wall covering from the selected wall.

Preview panes showing the current wall covering display the row of buttons.

2 Specify the **Position** of the selected wall covering.

- Enter the heights of the current wall covering’s **Top To Ceiling** and **Floor To Bottom**. The wall covering’s **Height** from its top edge to its bottom edge can also be specified.
- Check **Interior** and/or **Exterior** to apply the wall covering to the inside and/or out-

side of the selected wall. Interior is checked by default. Not available for rooms.

- 3** Most wall coverings are best previewed using the Standard Rendering Technique. See “Dialog Preview Panes” on page 28.

Rail Style Panel

The RAIL STYLE panel is only available for Railings and Half Walls. See “Rail Style Panel” on page 157.

Newels/Balusters Panel

The NEWELS/BALUSTERS panel is only available for Railings and Half Walls. See “Newels/Balusters Panel” on page 159.

Materials Panel

All walls - including interior walls, railings - have an “Exterior Wall Surface” and an “Interior Wall Surface”. See “Interior and Exterior Surfaces” on page 153.

The materials specified on the MATERIALS panel affect the appearance of walls and Solid Railings in 3D views but are not calculated in the Materials List. See “Materials Lists” on page 427.

For most railing types, the “Exterior Wall Surface” component only affects the appearance of the floor platform under the railing, and “Interior Wall Surface” component is not used.

Railing Specification Dialog



To open the **Railing Specification** dialog, select a railing and click the **Open Object** edit button.

The **Railing Specification** dialog is the same as the **Wall Specification** dialog, but has two panels that apply only to Railings and Half Walls. See “Wall Specification Dialog” on page 153.

Rail Style Panel

The RAIL STYLE panel is only available for Railings. See “Railing Tools” on page 135.

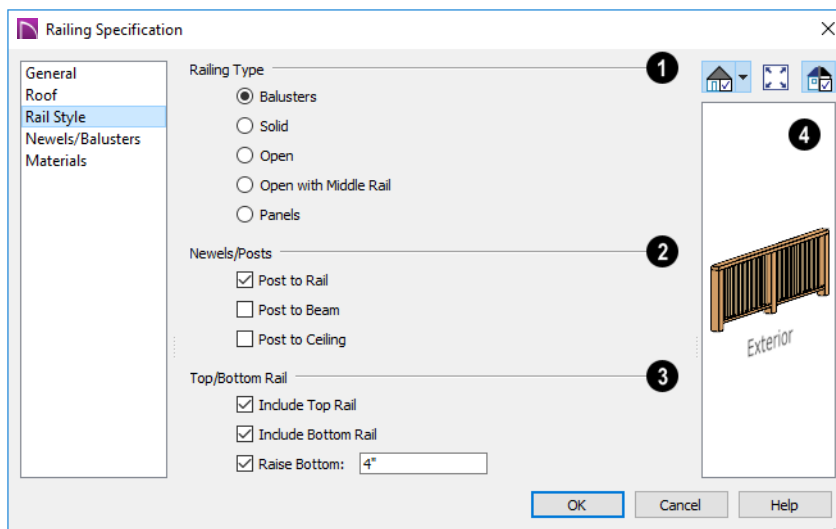

- 1 Railing Type** - Select the radio button for the desired railing type. A preview of the selected type displays to the left.

 - Select **Balusters** to create regularly spaced balusters between larger newel posts.
 - Select **Solid** to create a solid railing or Half Wall.
 - Select **Open** to create a railing with only newel posts and top and bottom rails.
 - Select **Open with Middle Rail** to create a railing with newel posts and top, bottom, and middle rails.
 - Select **No Rail** to eliminate rails, leaving only newels or posts and an overhead beam, if selected.
 - Select **Panels** to create a railing composed of panels.
- 2** Specify the properties of the selected railing's **Newels/Posts**.

 - Check **Post to Rail** to create newel posts from the floor to the top rail. This option is selected by default.
 - Check **Post to Overhead Beam** to create newel posts from floor to an overhead beam placed just under the ceiling height. The beam's width is based on the Thickness of the selected railing wall.
 - Check **Post to Ceiling** to extend the newel posts to the ceiling.
 - When none of the above Post options is selected, newel posts will build to the top of the railing.
- 3** The **Top/Bottom Rail** options control the placement of the top and bottom rail, or shoe. If neither box is checked, the bottom rail is placed at floor platform level.

 - Uncheck **Include Top Rail** to eliminate the top rail.
 - Uncheck **Include Bottom Rail** to eliminate the bottom rail and extend the balus-
- 4**

ters to the floor. Not available for Panel railings.

- Check **Raise Bottom Rail/Panel**, then specify the **Floor to Bottom** distance, measured up from the floor platform to the bottom rail or panel.

- 4 A preview of the selected railing or fence, including any doorways or gates inserted into it, displays on the right. See “Dialog Preview Panes” on page 28.

Newels/Balusters Panel

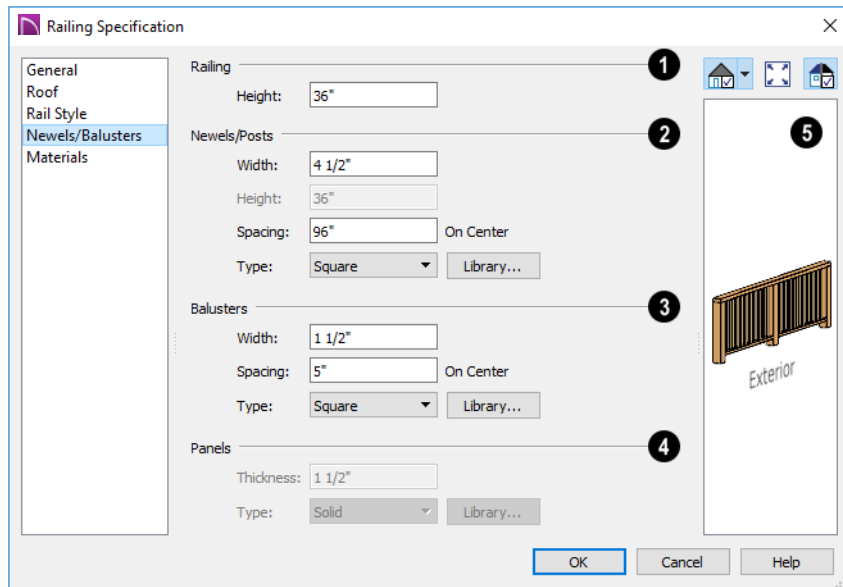

- 1 Specify the height of the **Railing**.
 - Specify the **Railing Height**. For interior railings, this is measured from the height of the floor finish.
- 2 Specify the characteristics of the selected railing’s **Newels/Posts**.
 - Specify the **Width** of each newel at its widest point.
 - Specify the **Height**, which is the height from the floor or ground to the top of the newel. Not available if Post to Rail, Post

to Overhead Beam or Post to Ceiling is selected on the RAIL STYLE panel.

- Specify the on-center **Spacing** of the newel posts.
- **Type** - Select Square, Round, or Library newels.

Note: Selecting Library from the drop-down list is the same as clicking the Library button to the immediate right and allows you to select a symbol from the library. See “Select Library Object Dialog” on page 344.

3 Specify the characteristics of the selected railing’s **Balusters**. These settings are only available when the railing type is “Balusters”.

- Specify the **Width** or diameter of each baluster at its widest point.
- Specify the on-center **Spacing** of the balusters.
- **Type** - Select Square, Round, or Library balusters.

4 Specify the characteristics of the selected railing’s **Panels**. These settings are only available when the railing type is specified as Panels on the RAIL STYLE panel.

- Specify the panel’s **Thickness**.
- Select “Solid” or “Library” from the **Panel Type** drop-down list.
- 5** A preview of the selected railing or fence, including any doorways or gates inserted into it, displays on the right. See “Dialog Preview Panes” on page 28.

Wall Hatch Specification Dialog



To open the **Wall Hatch Specification** dialog, select a Wall Hatch and click

the **Open Object** edit button. See “Hatch Wall” on page 138.

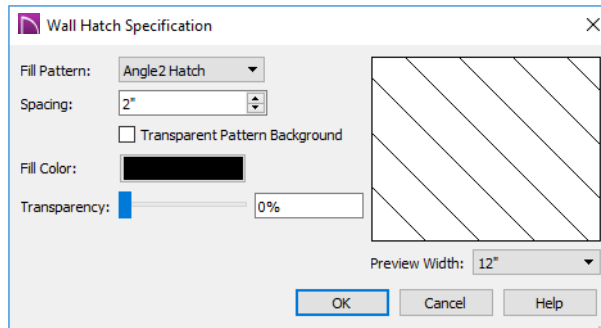

- Choose a **Fill Pattern** from the drop-down list. A preview of the selected pattern displays to the right.

The options that follow are disabled until you select a pattern other than **None** from the **Fill Pattern** drop-down list.

- Define the **Spacing** for the selected fill pattern. Hatch spacing set at 12" matches grid/reference spacing set at 12".

- Check **Transparent Pattern Fill** to make the fill pattern transparent. When you check this option, any objects behind the fill pattern are visible through it.

- **Fill Color** - Click the color bar to select a color for the fill pattern lines or fill color if a solid fill is specified. This overrides the layer color. See “Select Color Dialog” on page 372.

- Choose a **Preview Width** from the drop-down list. This value controls how large

an area the preview represents. The selected value indicates the length of each side of the preview in plan inches (mm).

Rooms

When walls or railings create an enclosed area, a “room” is created. You can select rooms defined in this manner like other objects in Home Designer Interiors.

Rooms are assigned a Room Type. Each Room Type has predefined characteristics. For example, a room defined as Porch is assigned certain attributes that are different than a Kitchen.

Floor and ceiling heights, baseboard, chair-rail, and crown moldings and materials can be defined room-by-room or for the entire floor.

Chapter Contents

- Room Definition
- Floor and Room Defaults
- Room Types
- Selecting Rooms
- Displaying Rooms
- Editing Rooms
- Room Types
- Room Labels
- Decks
- Floor and Ceiling Heights
- Stepped Floor and Ceiling Platforms
- Special Ceilings
- Room Specification Dialog

Room Definition

A room is a totally enclosed area defined by any combination of joined walls or railings, visible or invisible. To be recognized as a room by Home Designer Interiors, a room must have an unbroken perimeter.

Unless otherwise specified, rooms generate floor and ceiling platforms automatically. Most rooms are also automatically covered

by the roof when one is built. There are exceptions to this, such as rooms defined as Decks. See “Room Types” on page 165.

If a room is drawn within a larger structure and none of its walls connect to the exterior walls, either directly or indirectly by connecting to walls that do, it is referred to as an “island” room. The program will connect

such a room to the larger structure with an Invisible Wall. See “Room Dividers and Invisible Walls” on page 137.

Room definition disappears if part or all of a surrounding wall is deleted. It is a good idea to finalize the position of walls before specifying Room Types or defining room attributes such as floor or ceiling height.

Subdividing Rooms

When a room area is first defined, it inherits its characteristics from the **Floor Defaults** dialog for that floor. If the room is then specified as a particular type, it may inherit properties from the **Room Defaults** dialog associated with its type.

If a new room is created by subdividing a larger room, it inherits its characteristics from that larger room - including any non-default settings.

If two rooms are separated by an Invisible wall, their interior areas will be measured from the wall’s centerline and characteristics

like the floor finish materials and moldings will break along that line.

- If the two rooms have different floor heights, the break will occur at the wall edge that faces the room where the floor is lower.
- If the two rooms have different ceiling heights, the break will occur at the wall edge that faces the room where the ceiling is higher.

Copying and Pasting Rooms

A room can be copied into the same or a different plan by copying and pasting the walls that define it. Rooms copied in this manner retain their size and shape, as well as any finish materials assigned to the walls. See “Copying and Pasting Objects” on page 81.

If you want to retain the room’s Type and other specifications, copy and paste it and the walls that define it using the **Edit Area**  tools. See “Edit Area” on page 94.

Floor and Room Defaults



Select **Edit> Default Settings** to open the **Default Settings** dialog, then click the arrow to the left of “Floors and Rooms” to expand the category. Here, you can access several defaults dialogs which directly affect rooms. Select a line item and click the **Edit** button to open the defaults dialog associated with it.

Current Floor Defaults

Many important default values that affect rooms are specified in the **Floor Defaults** dialog for each floor in a plan. This dialog controls important information that the program uses to create a 3D model - particularly floor and ceiling heights and materials. Moldings can also be specified in the **Floor Defaults** dialog.

Only the defaults for the first floor of a building can be set ahead of time. The program uses the setting from the first floor to create subsequent floors. Once a new floor is created, its floor defaults can be changed. See “Floor Defaults Dialog” on page 288.

Floor 1 Default Height

Home Designer Interiors always defines the default height of Floor 1 at 0’-0”. This height

value is measured from the top of the subfloor and is the constant by which the heights of structural elements in the program like walls, floors, and ceilings are measured. The heights of architectural objects can be measured relative to this absolute height, as well. As such, this default cannot be changed.

Room Type Defaults

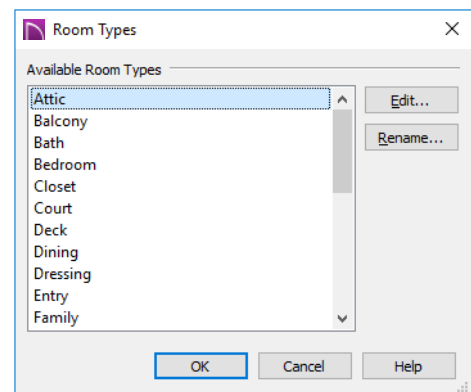

The settings in the **Room Type Defaults** dialogs allow you to specify the floor and ceiling finish materials for each Room Type.

Room Types

Room Types are used to quickly apply useful structural, functional, and appearance properties to different kinds of rooms. For example, a room assigned the “Garage” Room Type will receive concrete curbs under

its walls when the Foundation is built, while a “Kitchen” will get GFCI Outlets when the Auto Place Outlet tool is used.

When a room is first created by enclosing an area with walls, it is assigned a generic room

type of “Unspecified.” Once a room is created, though, it can be assigned a **Room Type** in the **Room Specification** dialog. See “General Panel” on page 176.

Available Room Types

There are three broad categories of room Types: Interior, Exterior and Hybrid.

Interior - Living, Dining, Family, Kitchen, Nook, Bath, Master Bath, Master Bedrm, Bedroom, Study, Office, Entry, Hall, Closet, Dressing, Storage, Laundry, Utility and Unspecified.

Exterior - Court, Deck, Balcony.

Hybrid - Open Below, Garage, Slab, Porch, Attic.

Effects of Room Types

Home Designer Interiors applies specific properties to rooms depending on the assigned Room Type.

Living and Conditioned Areas

- All interior type rooms are included in Living Area calculations by default; exterior and hybrid type rooms are not.
- With the exception of Unspecified rooms, all interior type rooms are included in Conditioned Area calculations. Open Below rooms are also included; however, exterior and other hybrid type rooms are not. See “Conditioned Area Totals” on page 431.

Ceilings and Roofs

- Interior rooms have a ceiling and roof above them.

- Exterior rooms are assumed to be open to the outside and do not generate a roof above them.
- Attic rooms do not receive a ceiling and are ignored by the program’s automatic roof generator.
- Garage, Slabs, and Porches are treated like exterior rooms in all cases except that they generate a ceiling and a roof above them by default.

Floors and Foundations

- Open Below is a unique type of interior room. It has no floor platform and can be used for defining stairwell openings.
- Garages have a foundation under them with a concrete slab at the top of stem wall or grade beam.
- The floor in Garage and Slab rooms display in 3D on Floor 0, not the first floor. See “Garages” on page 282.
- A room’s default floor structure and finish definitions are determined by its Room Type. See “Room Type Defaults” on page 165.
- Courts, Decks and Balconies do not generate foundations.

Doors and Windows

- A window placed in a wall between an exterior room and an interior room always faces out toward the exterior.
- Doors placed between interior and exterior type rooms inherit their settings from the Exterior Defaults for the door tool, if available; they display threshold lines and are considered Exterior. See “Interior vs Exterior Doors” on page 209.

- Doors placed between interior type rooms do not display thresholds and are considered Interior.
- Open Below rooms are treated as interior rooms for window and door placement.

Electrical

- Any outlet manually placed in an exterior room automatically becomes a waterproof outlet designed for exterior use.

Trim and Molding

- Moldings are not automatically added to exterior or hybrid rooms.
- Baseboards and chair rails are not automatically added to Open Below rooms, but crown molding, if specified in the Floor Defaults dialog, is.

Selecting Rooms

Room definition is established when a room is completely enclosed by walls. You can confirm that a room has room definition by using the **Select Objects**  tool to select it. When a fully-enclosed room is selected, the room highlights.



The room at left is selected

The Exterior Room

You can also select the exterior of a model. This allows you to control the building's exterior wall coverings and materials using the **Exterior Room Specification** dialog. See "Room Specification Dialog" on page 176.

Click just outside an exterior wall using the **Select Objects**  tool to select the Exterior

Room. When it is selected, a highlighted band around the plan's exterior displays. This band represents the selection area for the Exterior Room.

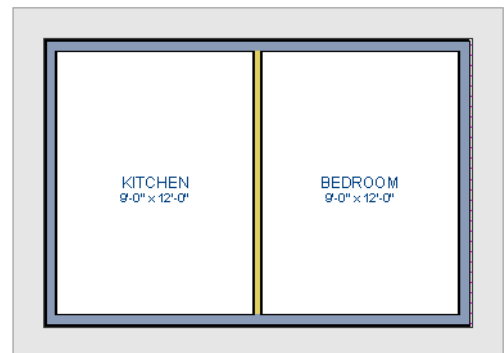

The Exterior Room is selected

In camera views and overviews, the Exterior Room can be selected by clicking on the exterior surface of an exterior wall using the **Select Objects**  tool.

In 3D Views

Click on the floor of a room or on a wall surface inside the room in a 3D view using

the **Select Objects**  tool. If you select another object instead of the room, click

Select Next Object  edit button or press the Tab key until the room is selected. The Status Bar indicates which object is currently selected.

The Exterior Room can also be in 3D views selected by clicking once on the exterior

surface of an exterior wall using the **Select Objects**  tool.

Note: If the wall height of the Exterior Room is adjusted in a 3D view, the default Floor or Ceiling Height of the entire floor is changed. See “Floor and Room Defaults” on page 165.

Displaying Rooms

Unlike most things in Home Designer Interiors, a room is not an individual object. Rather, a room is defined by the walls that enclose it.

In Floor Plan View

Rooms typically display a transparent fill in floor plan view. You can, however, specify a solid color or fill pattern for individual rooms in the **Room Specification** dialog. See “Fill Style Panel” on page 181.

In order for room fill styles to display, the “Rooms” layer must be turned on. See “Displaying Objects” on page 87.

Room labels that include the room’s name as well as its size and other information can be

set to display in floor plan view. See “Room Labels” on page 170.

In 3D Views

Rooms can be viewed in 3D views created by any of the 3D view tools. The **Dollhouse View** tool can be used to see all rooms on the current floor without their ceilings. See “Creating Overviews” on page 378.

In the Materials List

The contents of a room, including furnishings and floor and ceiling materials can be calculated using the **Calculate From Room** tool. See “To create the Materials List for a room, select the room and then select Tools> Calculate Materials for Room.” on page 428.

Editing Rooms

Once a room is defined by walls or railings, its structure and appearance can be edited using the edit buttons or the **Room Specification** dialog.

In 3D Views

The floor and ceiling heights for floors and rooms can be edited using edit handles in 3D views. Lowered ceilings cannot be edited in 3D. See “3D Views” on page 375.

The default floor and ceiling heights for an entire model can be edited by selecting the Exterior Room. See “The Exterior Room” on page 167.

To change default ceiling heights in 3D

1. Create a 3D view of the exterior of your plan.
2. Click on the exterior surface of a wall to select the Exterior Room. The Status Bar indicates when the exterior room is selected. See “The Exterior Room” on page 167.
3. Click and drag the edit handle on the top wall edge to adjust the default ceiling height, or the edit handle on the bottom edge to adjust the default floor height. Temporary dimensions display.

Note: Any rooms that do not update when the default floor or ceiling height is changed are not using the default values. To use the default values for a specific room, check Default for any of the room height values in its specification dialog. See “General Panel” on page 176.

To adjust room heights in 3D

1. Create a 3D view of your plan.
2. Click on the surface of a wall that faces the room to select it. When the room is selected in 3D:
 - The room highlights.
 - The Status Bar says “Room”. See “The Status Bar” on page 29.
 - A temporary dimension will display in elevation views, and measure from the room’s rough floor to rough ceiling.

See “Temporary Dimensions” on page 188.

- Two edit handles display on the top and bottom edges of the highlighted wall.
3. Click and drag the edit handle on the top wall edge to adjust the room ceiling height, or the handle on the bottom edge to adjust its floor height. Temporary dimensions display.
 4. As you drag a handle, notice that all walls defining that room are affected.

Room materials such as floor, ceiling, and wall materials can be changed in 3D views

using the **Material Painter** . See “The Material Painter” on page 363.

Room moldings can be replaced directly from the library in 3D views, as well. See “Replace From Library” on page 344.

In the Specification Dialog

 Floor and ceiling heights, floor platform structure, moldings, wall coverings, and materials can all be specified in the **Room Specification** dialog. See “Room Specification Dialog” on page 176.

Using the Edit Tools

A selected room can be edited using the edit toolbar. See “The Edit Toolbar” on page 24.

- Click the **Calculate Materials for Room**  edit button to create a materials list of the contents of the selected room, not including walls. See “To create the Materials List for a room, select the room and then select Tools> Calculate Materials for Room.” on page 428.

Room Labels

A label can display in floor plan view for any area defined as a room. There are two parts to each room label:

- The Room Name, which is similar to a **Text**  object and can be selected and edited. See “The Text Tools” on page 197.
- The room area, which is not a standard text entry and cannot be directly edited.

You can assign a custom Room Name, move a room label or even delete it without affecting the Room Type. See “Room Types” on page 165.



Room labels can move or even disappear when room entries are revalidated.

Displaying Room Labels

The display of room labels is controlled in the **Display Options** dialog. Room labels are placed on the “Rooms, Labels” layer and use the Text Style assigned to that layer. See “Display Options Dialog” on page 88.

You can specify how the area of rooms is reported by the program by turning on the display of one or more of these layers:

- **Rooms, Standard Area** is measured from the center of interior walls that define the room and from either the outside surface or outside of the Main Layer of exterior walls, depending on the **Living Area to** setting in the **General Plan Defaults** dialog. It is rounded to the nearest square foot or mm and does not include the area within bay, box and bow windows. See “Exterior and Interior Walls” on page 136

and “General Plan Defaults Dialog” on page 56.

- **Rooms, Interior Area** is measured from the inner surfaces of all the room's walls.
- **Rooms, Interior Dimensions** is also measured from the inner surfaces of the room walls.

The display of room labels can also be controlled on a room by room basis in the Room Specification dialog. See “General Panel” on page 176.

Editing Room Labels

Room labels are similar to simple **Text**  objects and can be moved and resized much like any other text object. You can also modify a room label's Text Style and other attributes in the **Room Label Specification** dialog.

The text of a room label cannot be modified in its specification dialog, however: it must be specified in the **Room Specification** dialog. See “General Panel” on page 176.

If you delete a room label, the Room Type and Room Name remain unchanged in the **Room Specification** dialog. To restore the label, check the **Show Room Label** checkbox on the GENERAL panel of that dialog.

Room Area

Unlike the rest of a room label, the room area and dimensions are not standard text entries and cannot be edited or changed. The room area moves, resizes and rotates with the rest

of the room label, but you can turn the area and dimensions on or off separately in the **Display Options** dialog. See “Displaying Rooms” on page 168.

The **Interior Area** room area calculation includes the areas within bay, box or bow windows, while the Standard Area and Interior Dimensions calculations do not.

Living Area

The Living Area label is an automatically generated label that reports the area of the current floor specified as living space. By default, Interior Rooms are defined as part of the Living Area, while Exterior and Hybrid Rooms are not. See “Available Room Types” on page 166.

Regardless of its Room Type, you can specify whether any room is included in the Living Area Calculation in the **Room Specification** dialog. See “General Panel” on page 176.

A Living Area label is created as soon as a room area is defined by walls and/or railings and is recalculated every time you add, remove, resize, or redefine a room. If multiple buildings are created, each will have

its own Living Area label. If none of a structure’s rooms are included in the Living Area Calculation, however, no Living Area label will display for it.

To turn off the display of all Living Area labels in a plan, uncheck **Show Living Area Label** in the **General Plan Defaults** dialog or turn off the “Room Labels” layer in the **Display Options** dialog. See “General Plan Defaults Dialog” on page 56.

Living Area vs. Footprint

The Living Area should not be mistaken for the footprint of a house. Only true livable areas are included in the Living Area calculation. By default, exterior and hybrid room types such as Garage, Deck, and Porch are not included. Neither is any room labeled Open Below or Attic. See “Available Room Types” on page 166.

Regardless of its room type, you can specify whether a room is included in the Living Area calculation in the **Room Specification** dialog. See “General Panel” on page 176.

Living Area is measured from either the outside surface or the outer surface of the structural layer of exterior walls.

Decks

A Deck room is an exterior-type room that uses deck planking and framing to create a floor platform rather than using a single floor surface that spans the entire room area.

To draw a deck, select **Build> Wall> Railing**



then click and drag to draw a railing.

Once room definition is established, the area

defined by the railing can be assigned the “Deck” room type.

You can define a room as a “Deck” in the **Room Specification** dialog. See “General Panel” on page 176.

By default, decks do not have roofs. If you want a roof over a deck, check **Roof Over**

This Room in the **Room Specification** dialog. See “Structure Panel” on page 177.

To give the roof a visible means of support, you can select the **Post to Beam** option in the **Wall Specification** dialog. See “Rail Style Panel” on page 157.

Openings in deck railings can be created using **Doorways** . See “Openings in Railings” on page 217.

Deck Framing and Planking

When a Deck room is created, the floor platform is modeled using joists, beams, posts, and planking.

Deck framing, planking, posts, and beams are placed on their own layers with names that begin with “Framing, Deck”: for example, “Framing, Deck Posts”. These layers cannot be turned on in floor plan view but are shown in 3D views.

Floor and Ceiling Heights

Default floor and ceiling heights are defined in the **Floor Defaults** dialog for each floor, including the foundation. Use the **Floor Defaults** dialog to change these values on a floor-by-floor basis. See “Floor and Room Defaults” on page 165.

Use the **Room Specification** dialog to set floor heights on a room-by-room basis. See “Room Specification Dialog” on page 176.

Different rooms on the same floor can have unique floor and ceiling heights, allowing you to create:

- Split levels and bi-levels
- Sunken living rooms and garages
- Cathedral and coffered ceilings.



In 3D views, you can adjust the default floor and ceiling height for the entire floor or the floor and ceiling height for an individual room. See “In 3D Views” on page 168.

In order to raise or lower an area’s floor or ceiling height, you must give it a room definition. To create room definition without enclosing an area with solid walls, use

Railings .

Ceiling and floor heights are interrelated. Changing the floor height in one room can affect ceiling heights of the rooms below.

- If a room’s floor is lowered, its ceiling height is increased while the ceiling below that room drops.
- If the floor is raised, the ceiling height decreases while the ceiling below that room is raised.

If the rooms above a particular room have more than one floor height, the room’s ceiling is stepped.

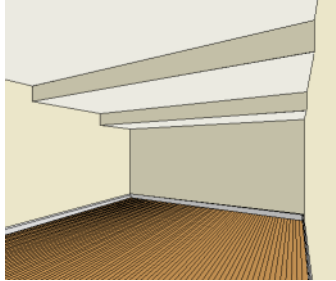

In a situation like this, a Lowered Ceiling can be used to cover “steps” made by different floor heights on the floor above. See “General Panel” on page 176.

To ensure that steps in floor and ceiling platforms have solid sides, define their room areas using Invisible Railings.

Shelf Ceilings

In rooms with high or vaulted ceilings, it is possible to have a smaller room such as a closet that has a flat, lower ceiling. By default, the area above the flat ceiling will be enclosed by automatically-generated Attic walls. See “Attic Walls” on page 151.

If you prefer, you can specify that these Attic walls be suppressed and an open space be

created instead. This condition is referred to as a **Shelf Ceiling**, or plant shelf, and can be specified in the **Room Specification** dialog of the room with the lower flat ceiling. See “Structure Panel” on page 177.

Split Levels

A split level can be created by raising or lowering the floor and ceiling heights of various areas of the plan.

In the following example, the lowest floor height is 0, the next is 24, and the next is 48 inches. The ceiling height in each room is set at 109 inches. See “Split Levels” on page 291.

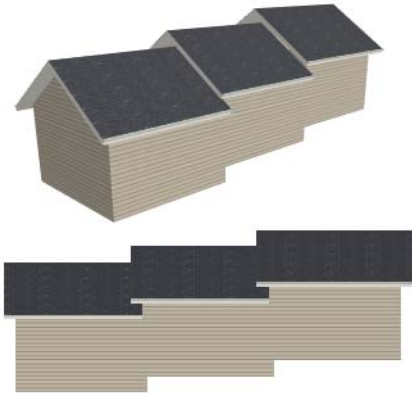

Stepped Floor and Ceiling Platforms

Each floor has default floor and ceiling heights. You can, however, use the **Room Specification** dialog to specify floor and ceiling heights on a room by room basis to create stepped floors and ceilings. See “Structure Panel” on page 177.

If you require a single floor platform with a uniform height and thickness but different ceiling heights for the rooms below, specify a lowered ceiling using the **Ceiling Finish Specification** dialog. See “Lowered Ceilings” on page 174.

Special Ceilings

By default, the program builds a flat ceiling platform on top the wall plates of a room. More varied and complex ceilings are made

using settings in the **Room Specification** dialog.

Lowered Ceilings

You can define a lowered or dropped ceiling in a room without affecting the top height of the walls by increasing the thickness of the Ceiling Finish.

In the following illustration, the default ceiling height for the entire first floor is 120", and the room on the right has a ceiling finish lowered to 96".

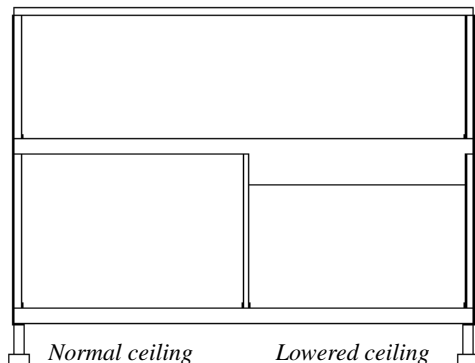

To create a lowered ceiling

1. Select the room in which you would like to specify a lowered ceiling.
2. Click the **Open Object**  edit button to open the **Room Specification** dialog.
3. On the STRUCTURE panel, increase the **Ceiling Finish** value by the amount that you would like to lower the ceiling.
4. Notice that the preview diagram represents the Finished Ceiling height (F).

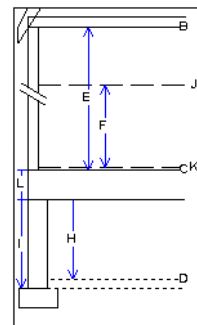

Cathedral Ceilings

A cathedral ceiling has the same pitch as the roof and is created using the underside of the roof above the room.

To create a cathedral ceiling

1. Build a roof for your plan. See “Roofs” on page 321.

2. Select the room and open the **Room Specification** dialog. See “Room Specification Dialog” on page 176.
3. On the STRUCTURE panel, clear the checkbox for **Ceiling Over This Room**.

Trey Ceilings

A trey ceiling is an area within a ceiling that is raised and has either vertical or sloping sides. A standard trey ceiling can be easily created by placing Soffits around the perimeter of the room. An angled trey ceiling can be created using the underside of roof planes above.

To create a angled trey ceiling

1. In the **Room Specification** dialog, make sure that **Ceiling Over this Room** is checked, then specify the desired height of the walls as the **Ceiling Height**. See “Structure Panel” on page 177.
2. Make sure that **Auto Rebuild Roofs** is unchecked, then build the roof. See “Build Roof Dialog” on page 323.

3. Change the **Ceiling Height** of the room to the desired height of the flat ceiling surface in its center.

In floor plan view, dashed lines indicate where the ceiling changes from sloped to flat. These lines are located on the “Ceiling Break Lines” layer in the **Display Options** dialog. See “Display Options Dialog” on page 88.

If the roof is rebuilt after the ceiling height is adjusted upward, the new roof will be raised to match the new ceiling height and a trey ceiling will not be created.

In the following example, a hip roof is built on 8' (2400 mm) ceilings. After the roof is built, the Ceiling Height is raised to 10' (3000 mm). The resulting ceiling follows the roof pitch for 2' (600 mm), then becomes a flat ceiling.

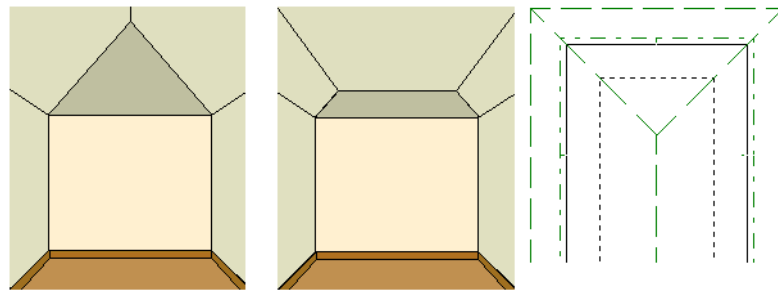

Hip roof with cathedral ceiling over.

Hip roof, ceiling over, ceiling height raised.

Ceiling Break lines in floor plan view.

Cantilever Undersides

Occasionally, a room will cantilever out past an exterior wall. You can specify the surface material of the underside of a cantilever on

the **MATERIALS** panel of the **Room Specification** dialog. See “Room Specification Dialog” on page 176.

Room Specification Dialog

 The **Room Specification** dialog controls the structural characteristics and appearance of a selected room. To open the **Room Specification** dialog, select a room and click the **Open Object** edit button. See “Selecting Rooms” on page 167.

Some of the panels in this dialog are also found in the **Exterior Room Specification** dialog as well as in the **Floor** and **Room Type Defaults** dialogs. See “Floor and Room Defaults” on page 165.

Some values in this dialog are dynamic. A value with **Default** checked references the **Floor Defaults** dialog. To return a value to the default, replace the check mark. See “Dynamic Defaults” on page 55.

The settings in this dialog are similar to those in the **Floor Defaults** dialog, but affect only the selected room. See “Floor Defaults Dialog” on page 288.

General Panel

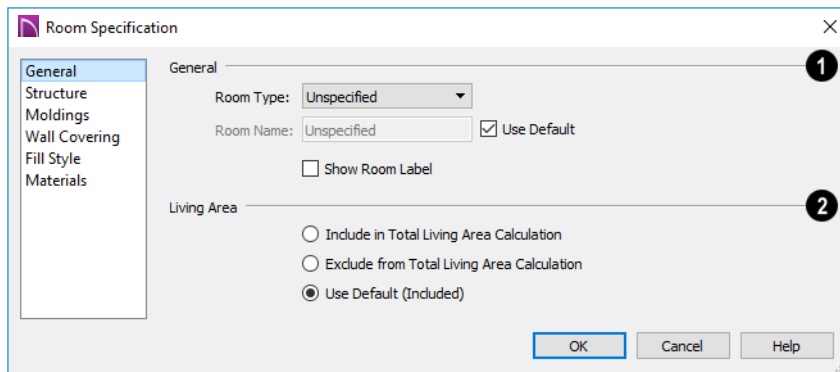

1 The settings here control the Room Type and the appearance of the Room Label

- Select the **Room Type**. Changing the Room Type can affect settings throughout the dialog. See “Room Types” on page 165.
- Click the **Define** button to open the **Room Types** dialog where you can customize the settings of the selected Room Type.

- If you wish to use a custom name in the room label, uncheck **Use Default**, then specify the desired **Room Name** in the text field.
- Check **Show Room Label** to display the room label in floor plan view. See “Room Labels” on page 170. This option is unchecked automatically if you select “Unspecified” as the Room Type, and checked automatically if you select any other Room Type

- 2 Specify whether the selected room is included in the **Living Area** calculation. See “Living Area” on page 171.
 - Select **Include in Total Living Area Calculation** to include the room in the Living Area regardless of its Room Type.
 - Select **Exclude from Total Living Area Calculation** to exclude the room from the Living Area regardless of its Room Type.
 - Select **Use Default for Room Type (Included/Excluded)** to base the selected room’s inclusion in the Living Area on its Room Type. The default for the selected Room Type is stated in parentheses.

Structure Panel

Some settings on the STRUCTURE panel are also found in the **Floor** and **Room Type Defaults** dialogs.

This panel features a cross section diagram showing the relationships between its various heights and platform thicknesses. It is meant to represent the relationships between heights and thicknesses rather than provide a scaled drawing of the model.

Two floors can be included in the diagram: the floor that the selected room is located on, and the floor below it, if one exists.

What appears in both the diagram and in the settings to its left may be affected by the location where you clicked to select the room. For example:

- If the selected room is located above two rooms with different structural settings, the position of the pointer relative to these two lower rooms determines which of them displays as the floor below.
- If the selected room is located below two rooms with different floor heights, its absolute and relative ceiling height settings will be disabled.

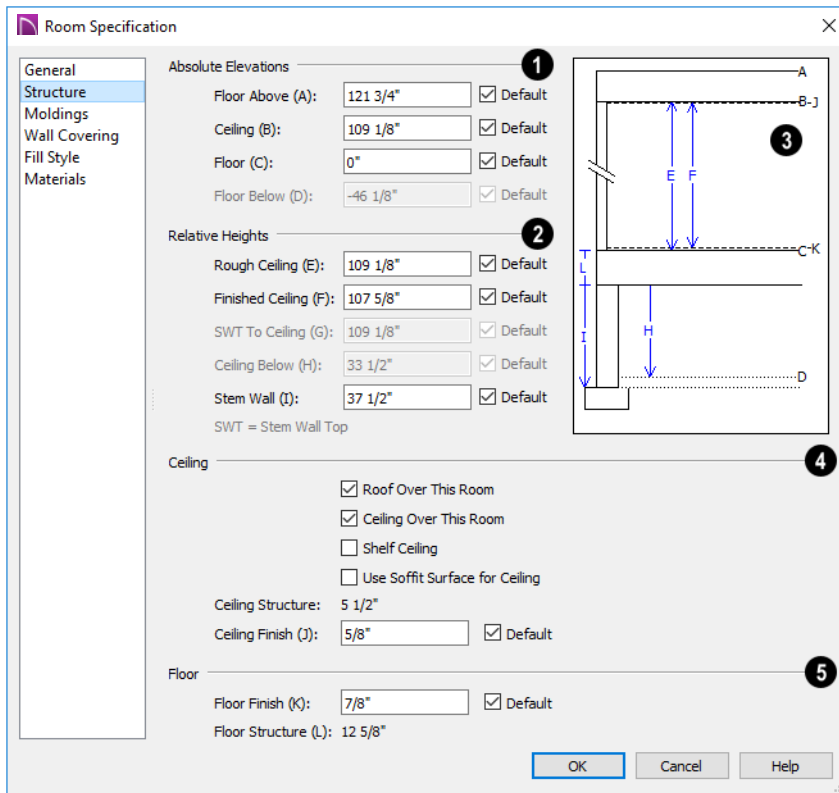

Check the **Default** box beside any height value to restore the default setting.

Note: Many of the settings on this panel are interdependent. For example, if the Ceiling Finish thickness is modified, the Finished Ceiling height will change in response.

1 Absolute Elevations - These height values are measured from zero, which is the default top height of the subflooring on Floor 1. See “Floor and Ceiling Heights” on page 172.

- Specify the **Floor Above** height, which is the subfloor height of the room on the floor above the selected room. If multiple rooms with differing floor heights are present directly above, this setting will be inactive and “No Change” will display.
- Specify the **Ceiling** height of the selected room, as measured from zero to the bottom of the ceiling framing. Not available in the **Floor Defaults** dialog on Floor 0, or if multiple floor heights are specified above the selected room.
- Specify the **Floor** height, as measured from zero to the top of the subflooring.

Note: The default floor height for Floor 1 is 0. It can be modified in the Room Specification dialog, but not in the Floor 1 Defaults dialog. See “Floor and Room Defaults” on page 165.

If a room is defined directly beneath the selected room on the floor below, additional settings may be available.

- Specify the **Floor Below** height, which is the subfloor height of the room directly below where you clicked to select the currently selected room. If there are multiple rooms with differing floor heights located below, this value may change depending on where you click.
- If the selected room is directly above a Garage and there is a foundation present, you can specify the **SWT Below** height, which is the top height of the concrete stem walls around the perimeter of the garage.

2 Relative Heights - These height values are measured from surfaces within the selected room or the room below.

- Specify the **Rough Ceiling** height, as measured from the subfloor surface to the bottom of the ceiling framing. Not available if multiple floor heights are specified directly above the selected room.
- Specify the **Finished Ceiling** height, as measured from the finished floor surface to the finished ceiling surface. Not available if multiple floor heights are specified directly above the selected room.
- Specify the distance from the **Stem Wall Top to Ceiling**. Only available when **Floor for this Room is Supplied by the Foundation ‘Room’ from the Floor Below** has been checked.

- Specify the **Ceiling Below** height, which is the height of the ceiling of the room below, as measured from that room’s subfloor to rough ceiling surfaces. Not available when Auto Rebuild Foundation is enabled or if there is no room below the selected room. See “Rebuilding Foundations” on page 280.

- Specify the **Stem Wall** height, which is measured from the top of the foundation wall footing to the top of the treated sill plate, if one is specified. Only available if the selected room or the room below it is defined by foundation walls.

3 A cross section diagram showing the relationship between the various height settings displays here for reference.

4 Specify the characteristics of the room’s **Ceiling**.

- If **Roof Over This Room** is checked, a roof automatically generates over the room. If unchecked, no roof generates.
- If **Ceiling Over This Room** is checked, the room has a flat ceiling. If unchecked, the ceiling follows the underside of the roof.
- Check **Shelf Ceiling** to prevent Attic Walls from generating over the interior walls that define the selected room. When unchecked, interior Attic Walls will generate if surrounding rooms have higher ceilings than the selected room. See “Shelf Ceilings” on page 173.
- Check **Use Soffit Surface for Ceiling** to improve the 3D appearance of the transition between ceiling and eaves of exterior rooms with Ceiling Over This Room unchecked.

- The thickness of the **Ceiling Structure** displays here for reference but cannot be changed.
- Specify the thickness of the **Ceiling Finish** layer.
- Specify the thickness of the **Floor Finish** layer.
- The thickness of the **Floor Structure** displays here for reference but cannot be changed.

Moldings Panel

Chair rail, crown and base moldings can be assigned to a selected room on the MOLDINGS panel. Moldings are placed around the wall surfaces of a room and continue around the surface of any soffit that is attached to the wall at the molding height.

The settings on the MOLDINGS panel are similar to those found in other specification dialogs.

The settings on this panel are also similar to those found in the **Floor Defaults** dialog, but affect only the selected room instead of all rooms on the current floor.

The MOLDINGS panel is also found in the **Cabinet** and **Soffit Specification** dialogs. See “The Cabinet Tools” on page 248.

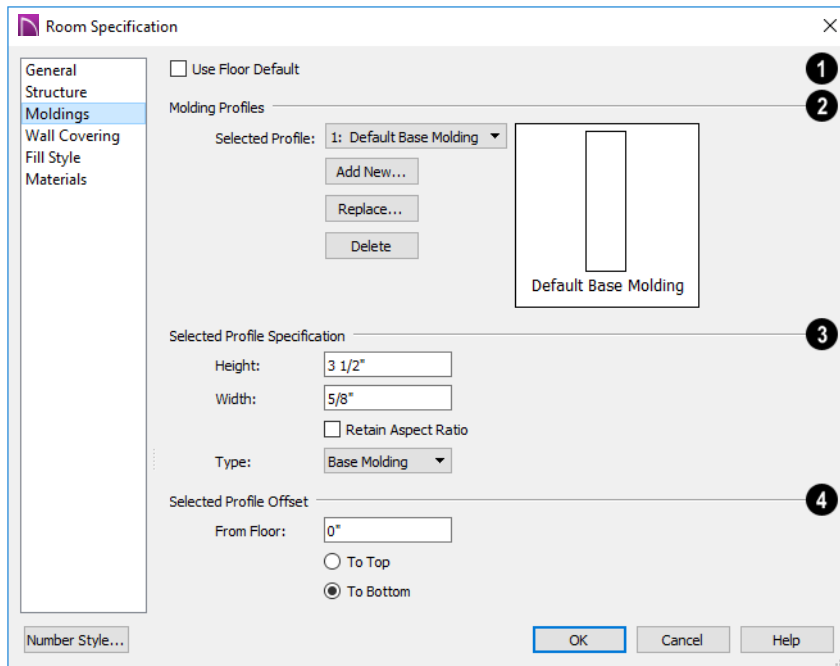

- 1 Uncheck **Use Room Default** to enable the settings that follow. When checked,

the room uses the default moldings set in the **Floor Defaults** dialog. See “Floor Defaults Dialog” on page 288.

2 Specify the **Molding Profiles** assigned to the selected room. The Default Base Molding is a basic rectangular stock profile rather than a profile from the library.

- The **Selected Molding** displays at the top of the drop-down list. Click the arrow to see all moldings currently applied to the selected room.
- Click the **Add New** button to open the **Select Library Object** dialog and select a new molding profile to apply to the room. See “Select Library Object Dialog” on page 344.
- Click the **Replace** button to replace the currently selected molding with a different molding profile.
- Click the **Delete** button to remove the currently selected molding from the room.

3 **Selected Molding Specification** - Make changes to the currently selected molding.

- Specify the **Height** and **Width** of the currently selected molding.
- When **Retain Aspect Ratio** is checked, if you change either the Height or Width, the other value changes to maintain their original ratio. When this is unchecked, the two values can be edited independently.
- Select the currently selected molding’s **Type** from the drop-down list: Base, Chair Rail, or Base Molding.

4 **Selected Profile Offset** - Specify the distance of the selected molding **From Floor** and select whether this distance is

measured **To Top** or **To Bottom** of the molding profile.

Wall Covering Panel

The settings on the WALL COVERING panel of the **Room Specification** dialog are the same as those on the same panel of the **Wall Specification** dialog. When a wall covering is assigned in the **Room Specification** dialog, it is applied to all walls in the selected room only. See “Wall Covering Panel” on page 156.



Wall coverings can be applied to exterior rooms as well by selecting the exterior room and opening it for specification. See “Selecting Rooms” on page 167 for information about selecting exterior rooms.

Fill Style Panel

The settings on the FILL STYLE panel affect the appearance of the room in floor plan view. This panel is also found in the **Floor Defaults** dialog. For more information, see “Fill Style Panel” on page 129.

Materials Panel

The settings on this panel affect the appearance of a selected room’s walls, floor, ceiling, and moldings in 3D views. See “Materials Panel” on page 366.

Default molding and ceiling and floor covering materials can be set on this panel in the **Floor Defaults** and **Room Defaults** dialogs.

Dimensions

Home Designer Interiors provides a variety of dimensioning tools for measuring walls, doors, windows, and many other objects.

Dimensions can be used to accurately position objects relative to other objects. In addition, dimension lines and extensions can be selected and customized.

Chapter Contents

- Dimension Unit Defaults
- Dimension Defaults Dialog
- The Dimension Tools
- Displaying Dimension Lines
- Editing Dimension Lines
- Editing Extension Lines
- Moving Objects Using Dimensions
- Dimension Line Specification Dialog

Dimension Unit Defaults

All plan files save measurements in either Imperial or metric units. The type of unit used is determined when the file is first

created and cannot be changed later. See “Creating a New Plan” on page 38.

Dimension Defaults Dialog



Select **Edit > Default Settings**, select “Dimension”, and click the **Edit** button to open the **Dimension Defaults** dialog.

The settings in this dialog are dynamic defaults, which means that any changes

made here may affect existing dimension lines in the drawing that are using default values. See “Dynamic Defaults” on page 55.

Setup Panel

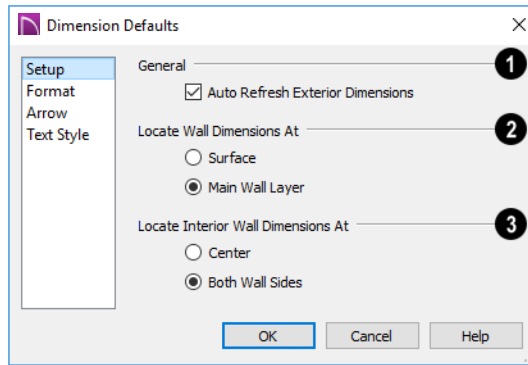

1 Uncheck **Auto Refresh Exterior Dimensions** to prevent Auto Exterior Dimensions from being regenerated as changes are made to the plan. When checked, Auto Exterior Dimensions will be created when walls enclose a room area and will refresh whenever walls, doors, or windows are added or moved. See “Auto Exterior Dimensions” on page 187.

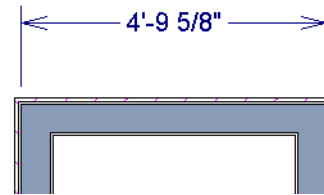

Dimensions locating walls' Main Wall Layers

2 Specify how Manual and Auto Exterior Dimension lines locate both interior and exterior walls.

- Select **Surfaces** to have dimensions locate the outer surfaces of walls.

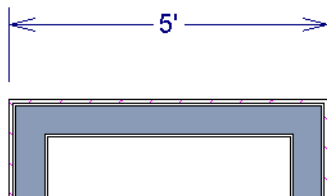

Dimensions locating wall Surfaces

3 Specify how Manual and Auto Exterior Dimension lines locate interior walls.

- Select **Centers** to have exterior dimensions locate the centers of interior walls.

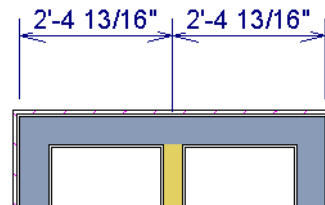

Dimensions locating an intersecting wall's center

- Select **Main Wall Layer** to have dimensions locate the structural layer of exterior walls.

- Select **Both Wall Sides** to have dimensions locate both sides of interior walls. Either the wall Surfaces or both sides of

the Main Wall Layers will be located, depending on your selection above.

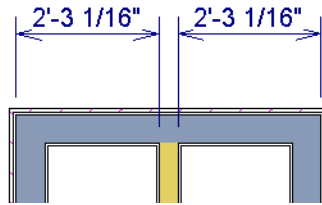

*Dimensions locating an interior wall's
Main Wall Layer*

You can always change the object or surface that a dimension locates after it has been created. See “Editing Extension Lines” on page 191.

Format Panel

The settings on the FORMAT panel allow you to specify the units, position, and degree of accuracy of dimension numbers. The settings

on this panel also control the format of object length numbers in the Status Bar. See “The Status Bar” on page 29.

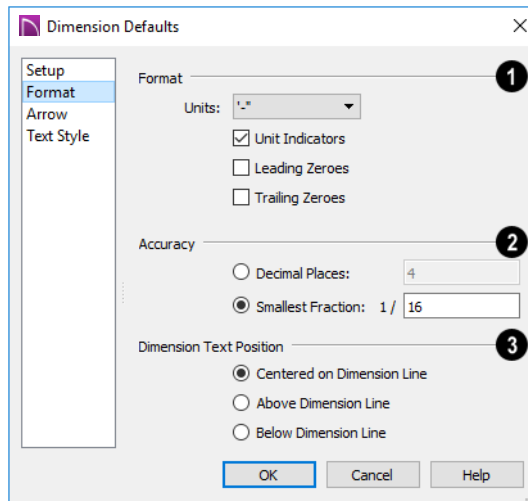

- 1 Specify the numbering **Format** for dimension numbers.
 - Check **Unit Indicators** to display the unit of measurement along with the dimension number.
 - Check **Leading Zeros** to include the zero before a decimal less than 1 or to display

- 0' or 0'' when the ft-in or '-'' unit formats is used.
- Check **Trailing Zeros** to display trailing zeros at the end of decimal values. When the ft-in or '-'' unit format is used and fractional inches are specified, 0'' will be included.
- 2** Specify the degree of **Accuracy** used by dimension numbers.
- Select the **Decimal Places** radio button for dimension numbers in decimal format. In the text field, specify the number of decimal places to use, from 0 to 20. If 0 is used, no decimal places are used.
 - Select the **Smallest Fraction** radio button for dimension numbers using whole numbers and fractions. In the text field, specify the largest denominator to use, from 1 to 128. If 1 is entered, whole numbers are used.
- 3** Specify the **Dimension Text Position**, which is the location of dimension numbers relative to the dimension line.

- **Center** primary dimension numbers on the dimension line. If two formats are used, the primary format is placed above the line and the secondary format, beneath it.
- Position dimension numbers **Above Line**.
- Position dimension numbers **Below Line**.

Arrow Panel

For information about the ARROW panel, see “Arrow Panel” on page 125.

Text Style Panel

The settings on the TEXT STYLE panel control the size, font and other attributes of automatic, manually drawn, and temporary dimension line labels. See “Dimension Labels” on page 189.

For information about the settings on this panel, see “Text Style Panel” on page 206.

Temporary dimension labels always use the color assigned to their layer - not the color specified in the **Dimension Defaults** dialog.

The Dimension Tools



Select **CAD > Dimensions** to access the Dimension Tools. Manually drawn dimensions are created by clicking and dragging like other line-based objects and can be drawn in floor plan view.

The zoom factor of the current view affects whether objects drawn close together are dimensioned or not. If you try to dimension an array of objects but the dimension line locates only the first and last objects along its

path, **Zoom**  in on the objects and try again. Similarly, if you want to dimension between two objects but the dimension locates unwanted objects between them,

Zoom  out. See “Zoom Tools” on page 72.

Once created, both manually drawn and automatically generated dimension lines can be selected and edited. See “Editing Dimension Lines” on page 189.

Manual Dimensions



To display the distance between two objects, select **CAD> Dimensions> Manual Dimension** and drag a dimension line near or through the objects.

Manual Dimensions locate walls as specified in the **Dimension Defaults** dialog. See “Dimension Defaults Dialog” on page 183.

End-to-End Dimensions



Use the **End-to-End Dimension** tool to dimension between any two defined objects in floor plan view.

Select **CAD> Dimensions> End-to-End**

Dimension , then click and drag the dimension from the first object to the second object. The dimension line snaps to each object, ignoring any other objects located between either end.

Interior Dimensions



Draw **Interior Dimension** lines parallel to walls in floor plan view to create interior dimensions.

The **Interior Dimension**  tool locates interior wall surfaces only. It does not dimension between layer surfaces in the same wall, and it does not locate walls unless it actually intersects them.

Auto Exterior Dimensions



The **Auto Exterior Dimension** tool generates dimensions around a plan's exterior in floor plan view. These dimension lines locate walls as specified in the **Dimension Defaults** dialog. See “Dimension Defaults Dialog” on page 183.



Auto Exterior Dimensions do not generate properly if there is a gap in the exterior walls or if they do not connect properly.



If you edit an **Auto Exterior Dimension**  line, it will be converted to a manual dimension, so if Auto Exterior Dimensions are later regenerated, your changes will not be lost.

There are a maximum of three rows of automatically generated dimensions per exterior wall direction. The innermost dimension line locates exterior walls, interior walls, and all openings in exterior walls. The second dimension line locates exterior and interior walls. The outermost dimension line is the overall exterior dimension.

Auto Interior Dimensions



The **Auto Interior Dimensions** tool creates a set of interior dimensions in each room that measures each wall on the current floor. It can be used in floor plan view in either of two ways:

- Select one or more rooms and click the **Auto Interior Dimensions**  edit tool to generate interior dimensions that measure each wall defining the selected room(s).
- Select **CAD> Dimensions> Auto Interior Dimensions**  to generate a set of interior dimensions in every room on the current floor.

Auto Interior Dimensions  lines are generated inside of the rooms they measure and do not recognize the **No Locate** setting for walls. If a wall is specified as No Locate,

Auto Interior Dimensions will locate it anyway. See “No Locate” on page 145.

Temporary Dimensions

 Temporary Dimensions display when an object is selected and show the distance between the object's selected edge and other objects. Select **View > Temporary Dimensions** to turn on or off the display of temporary dimensions. This toggle affects all views and is saved between launches of Home Designer Interiors.

As with other dimension lines, Temporary Dimensions only locate objects that are parallel or nearly parallel to one another. They will also locate the endpoints of the corners of objects located past the end of the

selected edge, within 4 feet (1200 mm) of the point where you click to select the object.

A temporary dimension will not display when an object is selected if a dimension line is already present that shows the same information.

Tape Measure

 Use the **Tape Measure** tool to draw a temporary dimension line between any two points in the drawing area. The tool will place temporary markers at the start and end points of the dimension line. These points and the line both disappear when you release the mouse button. If an object is located by the temporary line, you can snap to it.

Displaying Dimension Lines

The display of dimension lines is controlled in the **Display Options** dialog. See “Displaying Objects” on page 85.

Dimension lines created by any of the dimension tools share the same components.

- **Dimension Lines** run parallel with the distance being measured.
- **Extension Lines** are perpendicular to dimension lines, indicating what they locate. If a dimension line locates more than two objects, extension lines divide the dimension line into segments.
- **Arrowheads** display at the intersections of dimension and extension lines.
- **Dimension Labels** display at the midpoint of dimension line segments and indicate the distance that each segment measures.

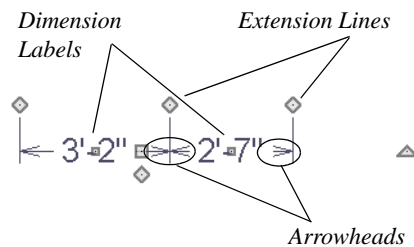

If a manual dimension line is on a layer that is turned off and you select an object located by that dimension line, it will display for reference using the Selection Line color specified in the **Preferences** dialog. See “Colors Panel” on page 59. This will happen only if **Temporary Dimensions**  are turned on. See “Temporary Dimensions” on page 188.

Dimension Labels

Manually drawn, automatic, and temporary dimension labels use the Text Style specified in the **Dimension Defaults** dialog. Unlike many objects that use Text Styles, by default dimensions use a Text Style specified in the defaults dialog rather than the Text Style assigned to their layer. See “Text Style Panel” on page 186.

Dimension Arrowheads

You can specify the style, color and size of dimension arrows in the **Dimension Defaults** and **Dimension Line Specification** dialogs. See .

The arrow at the end of a dimension line will not display if it is close enough to another dimension arrow that the two will overlap. A typical example of this is where two sections of an Interior Dimension locate two sides of an interior wall.

Editing Dimension Lines

With the exception of Temporary Dimensions, dimension lines can be selected and edited using the mouse and the edit toolbar buttons.

If an Auto Exterior Dimension line is edited, it will no longer be considered an automatic dimension line and will not be deleted and replaced the next time the **Auto Exterior**



Dimensions  tool is used.

Using the Mouse

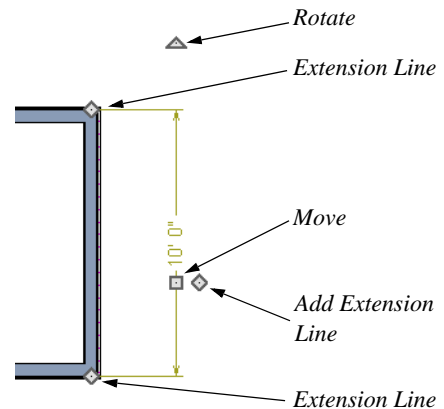
When a dimension line is selected, its edit handles can be seen. There are four types of dimension line edit handles. More than one of some types display, depending on how many extension lines are present.



- The **Extension Line** handles mark the location being dimensioned and are used to move or delete extension lines. See “Moving Extension Lines” on page 191.
- The **Add Extension Line** handle displays to the side of the Move handle and is used to add extension lines to the dimension line. Dimension lines do not extend unless an object can be located. See “Adding Extension Lines” on page 191.

- The small, square **Move Dimension Label** handle is located at the center of the selected label. Use this handle to move the dimension number for each dimension line section. The pointer changes to a four-headed arrow  when moved over this handle.
- The **Move** handle is located where you clicked to select the dimension line and is used to move the entire dimension line, including any subsections, perpendicular to itself. Extension lines are resized as appropriate. The pointer changes to a two-headed arrow  when moved over this handle.
- The **Rotate** handle is located one plan foot past the end of the dimension line and is used to rotate the dimension line.

Using the Edit Tools

Dimension lines can be repositioned, copied, and deleted using the edit toolbar buttons just like other objects in the program can. See “The Edit Toolbar” on page 24.

Dimension Number Size

The initial size of dimension numbers is specified in the **Dimension Defaults** dialog. See “Dimension Defaults Dialog” on page 183.

You can specify number height for individual dimension lines in the **Dimension Line Specification** dialog. See “Dimension Panel” on page 194.

As with text and other objects, dimension number size is subject to scaling when or printed.

Copying and Pasting Dimension Lines

Dimension lines can be copied and pasted into any view type that supports dimensions. If a dimension line is copied independent of the objects it originally locates, the pasted dimension line will locate point markers.

Deleting Dimension Lines

There are several ways to delete dimension lines.

You can select any manual or automatic dimension line or group of dimension lines, then press the Delete key or click the

Delete  edit button. See “Deleting Objects” on page 117.

The **Delete Objects** dialog allows you to delete all manually drawn and/or automatic dimension lines at once. See “Delete Objects Dialog” on page 117.

Individual dimension line segments located between extension lines can also be deleted. If a segment is located between two other segments along the same dimension line, that dimension will be broken in two.

To delete a portion of a dimension line

1. Select any **Dimension Tool** aside from Auto Exterior Dimensions.
2. Manually draw a dimension line over the segment that you wish to remove, dragging from extension line to extension line.

Editing Extension Lines

Extension lines can be added, edited, and deleted using the mouse.

Adding Extension Lines

To add an extension line

1. Select the dimension line.
2. Click the diamond-shaped Add Extension Line edit handle which displays near the Move edit handle. The pointer changes to a two-headed arrow \leftrightarrow .
3. Drag the handle to the object that you want to locate with a new extension handle. This example adds an extension line to the window edge.

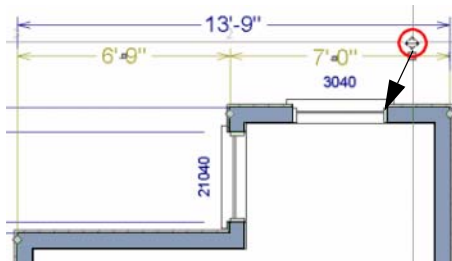

4. Release the mouse button to add an extension line.

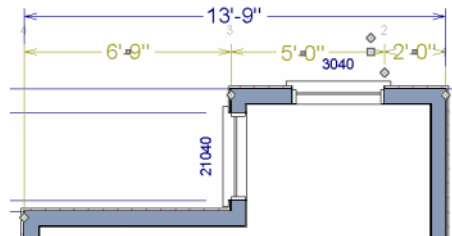

Moving Extension Lines

Extension lines can be moved to locate the centers, sides, or surfaces of most objects. In this example an extension line is moved from the window edge to the center.

To move an extension line

1. Select the dimension line it is connected to, not the extension line itself.
2. Click the Extension Line edit handle. The pointer changes to a two-headed arrow \leftrightarrow .

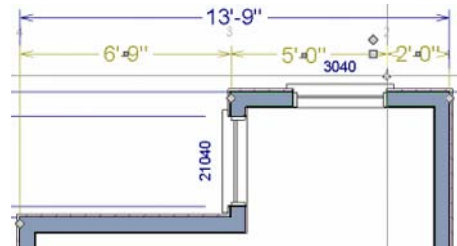

3. Drag the handle to a new location. The extension line snaps to possible marks as the handle is moved.
4. Release the mouse button at the new location.

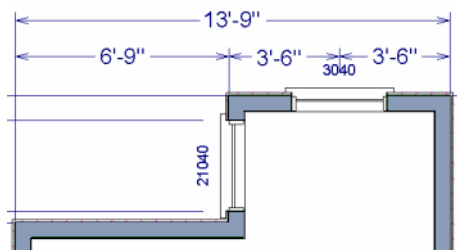

 Not all library symbols can be located by a dimension line as it is drawn. Once a dimension is drawn, however, you can move or add an extension line to locate the library object.

Deleting Extension Lines

When an extension line is deleted, the remaining dimensions update. If a dimension line has only two extension lines, they cannot be deleted.

To remove an extension line

1. Select the dimension line it is connected to, not the extension line itself.

2. Click the Extension Line edit handle.

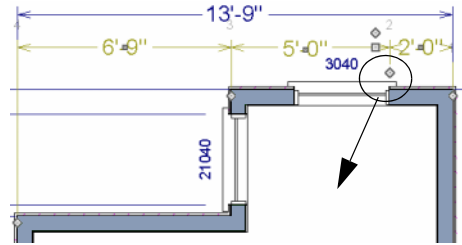

3. Drag it perpendicular to the direction of the arrows, away from any dimensionable object, and release the button when the extension line disappears.

Moving Objects Using Dimensions

Most objects can be moved by changing an automatic, manual, or temporary dimension value that locates it. This technique can be applied in nearly any situation where dimensions are present. See “Moving Objects” on page 110.

In addition, some objects can be resized using dimensions. See “Resizing Objects” on page 113.

Your pointer indicates which dimensions can be used to relocate the selected object by changing to a pointing hand icon.

Another way to tell is to select an object and drag it in the desired direction. As you drag, note which dimensions update. These dimensions are the dimensions that can be used to move that object.

To move an object using dimensions

1. Select the object and click on a dimension line that locates it. An inline text field opens at the location where you clicked.
 - The actual distance displays in the text field.
 - If the dimension is locating two different objects and the selected object is polyline-based, the **Move Edge** and **Move Entire Object** buttons display to the right of the text field.

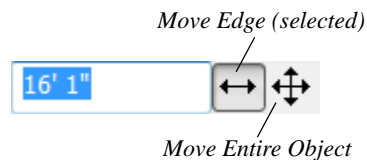

- If the dimension describes a selected wall's length, additional buttons display to the right. See "Using Dimensions" on page 147.

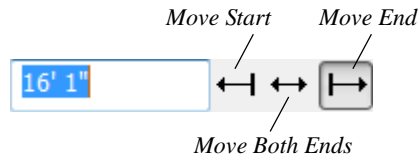

2. Click the **Move** button of your choice.
 - To use a different unit, include its indicator after the value. To move the selected object past a second object, to its opposite side, enter a negative value.
 - Basic math operations can also be performed in the inline text box, just as they can in dialogs. See "Math Operations in Dialogs" on page 27.
3. Enter a new value in text field.
 - To use a different unit, include its indicator after the value. To move the selected object past a second object, to its opposite side, enter a negative value.
 - Basic math operations can also be performed in the inline text box, just as they can in dialogs. See "Math Operations in Dialogs" on page 27.
4. The selected object moves or resizes when you press the Enter key or click outside of the text field.

A variety of polyline- and box-based objects can also be resized using dimensions.

To resize an object using dimensions

1. Select the object along the edge that you would like to move. See "Selected Edge" on page 92.
2. Click on a dimension line that indicates its distance from the object's opposite side.
3. In the inline text field, enter a value.
4. Click **Move edge** to move the selected edge only.
5. The selected edge moves, resizing the object, when you press the Enter key.



You can cancel a move or resize operation using dimensions at any time by pressing the Esc key.



Resizing a House Using Exterior Dimensions

When resizing a house using dimensions, it is important to work your way around the house in one direction. Relocate one wall at a time in succession so that you do not redefine the same dimension more than once.

For more information, see "Measuring Walls" on page 144.

Dimension Line Specification Dialog



To open the **Dimension Line Specification** dialog, double-click a dimension line using the **Select Objects**  or **Manual Dimension**  tool, or select a

dimension line and click the **Open Object** edit button.

The settings in this dialog are dynamic defaults. See "Dimension Defaults Dialog" on page 183.

Dimension Panel

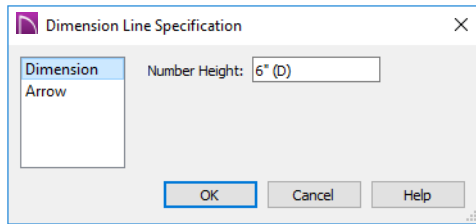

Specify the **Number Height** for the selected dimension. Type "d" in the box to reset the number size to the default.

Arrow Panel

For information about the settings on this panel, see "Arrow Panel" on page 125.

Text

Text is an ideal way to draw attention to special details of your drawings in floor plan view.

Text lines with arrow can be attached to text objects, allowing you to direct attention to specific plan details.

Chapter Contents

- Text Defaults
- Fonts and Alphabets
- The Text Tools
- Creating Text
- Displaying Text
- Rich Text Specification Dialog
- Text Specification Dialog
- Editing Text
- Copying and Pasting Text
- Text Arrows
- Text Styles

Text Defaults



Text Defaults can be accessed by selecting **Edit> Default Settings** in any view in which text can be created. See “Default Settings vs Preferences” on page 54.

The default settings for Rich Text determine what these objects look like when they are first created. Text Style Defaults determine the appearance of text associated with things like dimensions and object labels.

Text Style Defaults

Select “Text Style” from the list in the **Default Settings** dialog and click the **Edit** button to open the **Saved Text Style Defaults** dialog.

The **Text Style Defaults** dialog allows you to specify the attributes of the various Text Styles in use in the current file. See “Text Styles” on page 205.

Rich Text Defaults

The **Rich Text Defaults** dialog is similar to the **Rich Text Specification** dialog. See “Rich Text Specification Dialog” on page 198.

Text Lines with Arrows  use the same default layer as Rich Text, so by default they have the same color, line weight and line style. See “Layers” on page 86.

Arrow Defaults

The settings in the **Arrow Defaults** dialog determine the initial settings for arrows

drawn using the **Text Line with Arrow**  and **Line With Arrow**  tools.

The **Arrow Defaults** dialog looks almost the same as the ARROW panel of the **Line/Polyline Specification** dialog. See “Arrow Panel” on page 125



Avoid typing any text in the Rich Text Defaults dialog unless you want it to be present in all text objects you create.

Fonts and Alphabets

Home Designer Interiors allows you to use any font found in your computer’s Fonts directory.

Blueprint Fonts

Three architectural fonts: Chief Blueprint, City Blueprint, and Country Blueprint are installed in the Windows Fonts directory when Home Designer Interiors is installed.

Chief Blueprint

City Blueprint

Country Blueprint

On Mac systems, these fonts are embedded with the Home Designer Interiors installation but not installed on the system. As such, they are available for use in Home Designer Interiors but not in other programs.

International Alphabets

The **Rich Text**  tool supports unicode alphabets and characters. In order to use a unicode alphabet or characters, the appropriate language support must be installed on your computer.

Special characters can be added to any **Rich Text**  object by:

- Copying and pasting the character from another application;
- Copying and pasting the character from the Windows Character Map;
- Using the Mac Character Viewer;
- Typing the keystroke associated with the character.

See “Copying and Pasting Text” on page 203.

Missing Fonts

If you open a plan file that uses a font that is not installed on the current computer, the program will give you an opportunity to replace it in the **Replace Fonts** dialog.

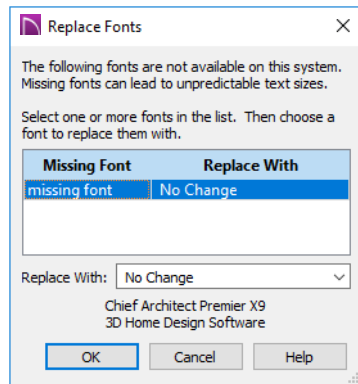



The table lists all missing fonts and how they will be replaced.

- Click on a font name in the list to select it. Use the Shift or Ctrl key to select multiple fonts. See “Shift and Ctrl Select” on page 93.
- Select a replacement font from the **Replace With** drop-down list, or leave “No Change” as the selection to maintain the file’s association with the missing fonts.
- A preview of the selected font displays below the **Replace Width** list.

If you do not plan to return the file to the computer where it was created, you may want to replace missing fonts with the fonts you normally use. On the other hand, if you do intend to return the file, you may prefer to not replace any missing fonts.

The Text Tools

 Select **CAD> Text** to access the **Text Tools**. These tools are available in floor plan view only.

 The **Rich Text** tool is used to create text objects.

 The **Text Line with Arrow** tool is used to connect text and another object with an arrow. See “Text Arrows” on page 204.

 The **Text with Arrow** tool places a Rich Text object with an arrow attached.

Creating Text

Text can be created in floor plan view only.

Once created, text can be selected and edited in a variety of ways. See “Editing Text” on page 201.

To create Text

1. Select **CAD> Text> Rich Text** .
2. Type or paste the desired text into the Text Field.
3. Use the options to change the font, style and size of any portion of the text.

Note: If you do not type anything in the Text Field, a text object will not be created when you click outside of it.

You can also create lines with arrows connecting the text that you create to items in the drawing. See “Text Arrows” on page 204.

Displaying Text

As with other types of objects, the display of Text objects is controlled in the **Display Options** dialog. All Text objects, including Text Lines with Arrows, are located on the “Text” layer. See “Display Options Dialog” on page 88.

Text objects can only be displayed in floor plan view.

The display attributes of each individual text object can be controlled independent of the layer it is placed on. See “Rich Text Specification Dialog” on page 198.

Rich Text Specification Dialog



The **Rich Text Specification** dialog opens if you select the **Text**  tool and then click once in the drawing area.

You can also open this dialog by selecting a

Text  object, then clicking the **Open Object** edit button.

The **Rich Text Specification** dialog is similar to the **Rich Text Defaults** dialog but affects the selected text rather than all subsequently created text objects. See “Text Defaults” on page 195.

Text Panel

The settings on the **TEXT** panel allow you to type the selected Text object’s content and control many aspects of its appearance, including its font, size, color and style.

You can specify the appearance of the text before typing, and can also select and change the attributes of all or portions of the text content after it is typed. To change text that already exists, simply highlight it using the



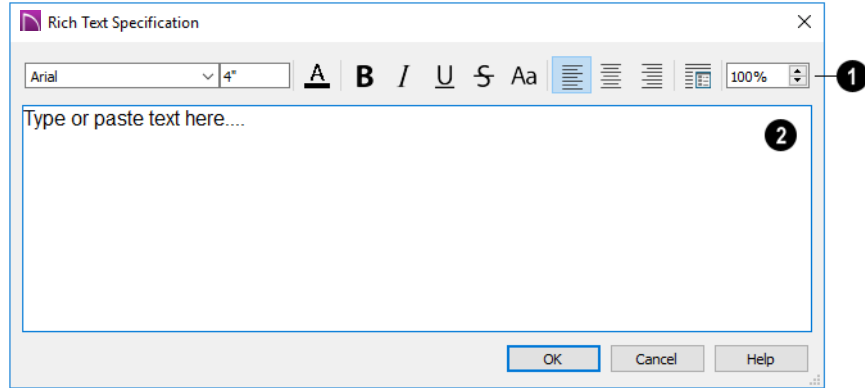

mouse and/or the Shift + arrow keys and then make any needed changes to its attributes.





Note: If you do not type anything in the text field on this panel when creating a new object, no object will be created when you click OK. On the other hand, if you remove the text from an existing object and click OK, an empty text box will result.



1 Use the options on the Edit Bar, which displays above the Text Entry field, to change the font, size, and style of the text.

Select the desired options before typing to affect the text as it is typed, or select some or all of the text and then specify which options to apply to it.

- Select a **Font** from the drop-down list.
- Specify the **Text Size** in drawing units.
- Click the **Color**  button to specify the color of the selected or subsequently typed text. See “Select Color Dialog” on page 372.
- Click the **Bold**  button to specify the selected text as bold.
- Click the **Italic**  button to specify the selected text as italic.
- Click the **Underline**  button to specify the selected text as underlined.
- Click the **Strikethrough**  button to specify the selected text as stricken-through.

- Click the **Uppercase**  button to display the selected text in all capital letters.
- Click the **Align Left** , **Align Center** , or **Align Right**  button to specify the how text is aligned.
- Click the **Paragraph Options**  button to specify the selected paragraph’s alignment, spacing and bullets or numbering in the **Paragraph Options** dialog.
- Specify the **Zoom** factor of the selected text by typing a percentage value in the text field or clicking the up/down arrows. This setting only affects the text as it appears in this dialog.

Note: Some fonts cannot be drawn at certain zoom factors. When this is the case, the appearance of the text will not change.

2 Type or paste text in the Text Entry field. See “Copy, Cut and Paste” on page 203.

- Right-click in the Text Entry field to access a contextual menu from which you can select Undo, Redo, Cut, Copy, Paste

and Select All. See “Contextual Menus” on page 25.

- To edit text in the entry field, click and drag to highlight any portion of it and then use the tools on the Edit Bar as needed.

Paragraph Options Dialog

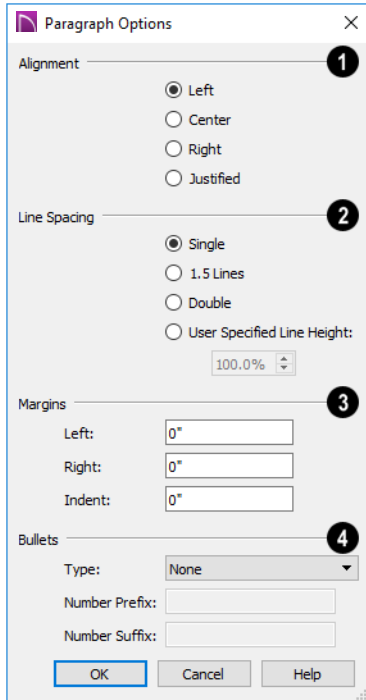

1 Specify the **Alignment** of the selected paragraph(s). See “Aligning Text” on page 203.

2 Specify the **Line Spacing** of the selected paragraph(s).

- Click the radio button beside **Single**, **1.5 Lines**, **Double** or **User Specified**.

- If you select **User Specified Line Height**, type the desired height for each line of text in the selected paragraph(s). For best results, this value should be at least as much as the largest character size used in the selected paragraph(s).

3 Specify the appearance of the side **Margins** of the selected paragraph(s), as measured in from edges of the text box. Only positive Margin values can be used.

- Specify the **Indent**, which is measured from the left side margin. A negative value can be used if a left Margin has been specified.

4 Specify the appearance of **Bullets** and numbering in the selected paragraph(s).

- Select the desired bullet, numbered, or lettered **Type** from the drop-down list.
- Specify the **Number Prefix**, which are any characters that you would like to display before the selected paragraph’s number or letter. Does not affect paragraphs using circle or square bullets.
- Specify the **Number Suffix**, which are any characters that you would like to display after the selected paragraph’s number or letter and before its actual text. Does not affect paragraphs using circle or square bullets.

Text Specification Dialog

 The **Text Specification** dialog opens if you select a Room Label or a simple **Text** object in a legacy plan file created in Version 8 or prior and click the **Open Object** edit button. See “Compatibility with Other Programs” on page 36.

Settings in the **Text Specification** dialog can also be found in other dialogs in the program, including the **Room Label Specification** and the **Dimension Defaults** dialogs.

Text Panel

The settings on the **TEXT** panel allow you to type the selected **Text** object’s content. **Text**

cannot be added to a selected Room Label, however.

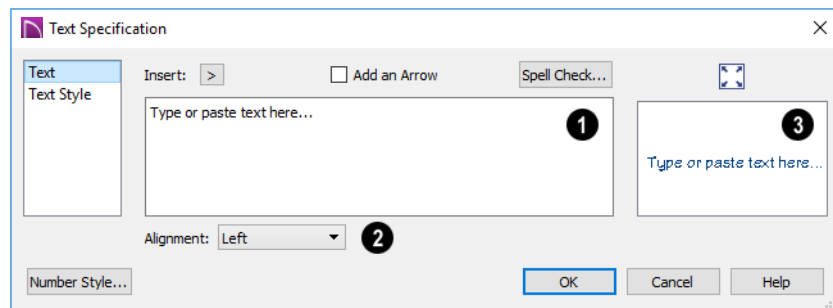

- 1** Enter text in the **Text Entry** field. This field is not available if the selected object is a Room Label. See “Room Labels” on page 170.
- 2** Select an **Alignment** option from the drop-down list to apply to the text.
- 3** A preview of the selected text object displays on the right. Not available for

Room Labels. See “Dialog Preview Panes” on page 28.

Text Style Panel

The **TEXT STYLE** panel is available for a variety of objects in the program and control the appearance of the selected object’s text. See “Text Style Panel” on page 206.

Editing Text

Once created, **Text**  objects can be selected individually or as a group and edited using the edit handles and the edit toolbar buttons Individual text objects can also be



edited in the **Rich Text Specification** dialog. See “Rich Text Specification Dialog” on page 198.

Editing Text Attributes

Most text attributes, including the font, size, style, and the content itself, are edited in the **Rich Text Specification** dialog.

In order to edit the attributes of an existing **Text**  object, you must select some or all of the text before making changes. See “Text Panel” on page 198.

To edit text attributes

1. Select a **Text**  object and click the **Open Object**  edit button.
2. On the **TEXT** panel of the **Rich Text Specification** dialog, click and drag to select some or all of the text typed into the Text field.

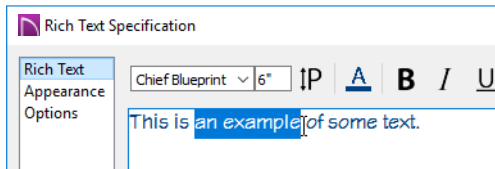

3. With some or all of the text selected, change any of the attributes available along the top of the panel, including the font, size, color, and style.

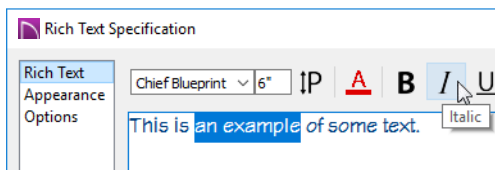

4. As changes are made, the selected text updates. Only the selected text is modified.

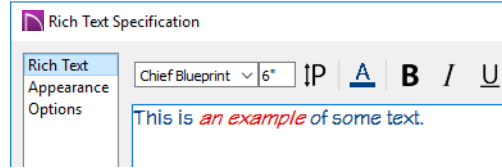

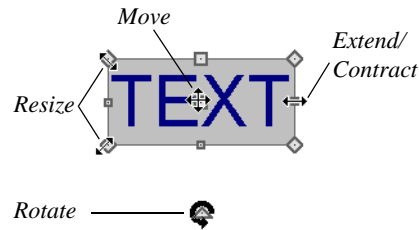

Using the Mouse

A selected **Rich Text**  object has the same edit handles as other box-based objects. See “Editing Box-Based Objects” on page 104.



As a text box’s width is made narrower or wider using an edit handle, its height may increase or decrease so that none of the text becomes hidden. The opposite is not true, however: a text box’s height cannot be resized smaller than the height of the rows of text it currently contains.

Using the Edit Tools

A selected **Rich Text**  or **Text**  object can be edited in a variety of ways using the buttons on the edit toolbar. See “The Edit Toolbar” on page 24.

Resizing Text

The default character height of **Rich Text**  objects can be specified as can the character height for individual objects, in





their specification dialogs. See “Text Defaults” on page 195.

Scaling Text

As with the size of other objects, text size is subject to the current drawing scale specified in the **Page Setup** dialog. See “Drawing Sheet Setup Dialog” on page 435.

Aligning Text

Text can be aligned in a couple of ways.

- The text content of a text object can be aligned to the left, right, center or justified in the **Rich Text Specification** dialog. See “Text Panel” on page 198.
- The text content of a text object can be also be aligned by clicking the **Align** **Left** , **Align Right** , **Center** , or **Justify**  edit button.

Copy, Cut and Paste

Copy, Cut and Paste of text into and out of the **Rich Text Specification** dialog can be accomplished using keyboard hotkeys:

- Press **Ctrl + X** to Cut the selected text and save it to the system clipboard.
- Press **Ctrl + C** to Copy the selected text and copy it to the system clipboard.
- Press **Ctrl + V** to paste your last cut or copied selection in a new text object.

For more, see “Copying and Pasting Objects” on page 81.

Copy, Cut and Paste use the system clipboard, making it possible to transfer text between text objects, between Home Designer Interiors files, from a plan into another application, or vice versa.

Copying and Pasting Text

The Copy, Cut and Paste commands use the system clipboard, making it possible to transfer text between text objects, between Home Designer Interiors files, from a plan into another application such as a text editor or spreadsheet program, or vice versa. See “Copying and Pasting Objects” on page 81.

All or selected portions of the Materials List can also be copied and pasted into a text object, as well as into a word processing or spreadsheet program. See “Materials Lists” on page 427.

Cut, Copy, and Paste can also be accessed from the Edit menu of many applications, including Home Designer Interiors. These

menu commands are not available when the text specification dialogs are open, but you can use the associated hotkeys.

To Copy, Cut and Paste text

1. On the **TEXT** panel of either text specification dialog or in another program altogether, highlight the text you wish to cut, copy or paste.
2. Press **Ctrl + X** to **Cut** the selected text out of its original location and save it to the system clipboard.
3. Press **Ctrl + C** to **Copy** the selected text to the system clipboard without removing it from its original location.

4. Open the text object or a file in another application and click to place your cursor in the Text field, writing area, or spreadsheet cell.
5. Press Ctrl + V to **Paste** the copied text at the location of your cursor.

Bear in mind that when text is copied and pasted, its formatting is not always retained. The results depend on the program or type of text object in which the content was created as well as the type of text object into which it is pasted.

Pasting into Rich Text



Text pasted into a **Rich Text** object from another source will retain most - but not necessarily all - of its custom formatting. If a line of text is sufficiently long, however, it may be wrapped automatically when pasted into Rich Text.

Text pasted into a **RichText**  object from a spreadsheet program retains basic column and row information. Column width cannot be adjusted; however, as you add or remove text from a cell, row height will increase or decrease to accommodate your changes.

Text Arrows

Text arrows can be used to connect text objects to details of interest in your drawing.

Text arrows can be snapped together to form open or closed polylines. If two lines with arrows meet within the bounding box of a text object, however, they will not join. This allows you to attach multiple, separate text arrows to a single text object. See “Editing Line Based Objects” on page 94.

Lines with arrows can be independent or attached to other objects. If an attached object is moved, the end of the Line with Arrow will move, as well. Arrows attach to closed polyline-based objects along their edges, but can attach to Text or an architectural object anywhere within its bounding box in floor plan view.

If an arrow is attached to text or another object, deleting either the text or the object will also delete the arrow.

Text with Arrow



The **Text with Arrow** tool places a text object with an arrow already attached. This arrow can be selected and edited like any other arrow.

Text Line with Arrow



Text Lines with Arrow can be attached to text and architectural objects by selecting **CAD> Text> Text Line with Arrow** and then clicking and dragging to draw a line. There is no limit to the number of text lines with arrows that can be attached to an object.

The endpoints of **Text Lines with**

Arrows  can be joined to form polylines with corners that can be adjusted using the edit handles.

Auto Position Arrows

Auto Positioning helps prevent a **Text Line with Arrow**  from crossing over the text object it is attached to by snapping the end of the line to the midpoint of the text box's nearest edge. If the text object or the line's arrowhead is moved, the location of the tail end will update as needed so that it snaps to the nearest edge's midpoint. This behavior only occurs when the end of a line with arrow is snapped an Auto Position location: if it is snapped to a different point on the text, the tail end will not move.

The following image illustrates the behavior of Auto Positioning. When the head of the arrow is moved, the tail of the arrow snaps to different Auto Position locations on the text object, maintaining its connection.

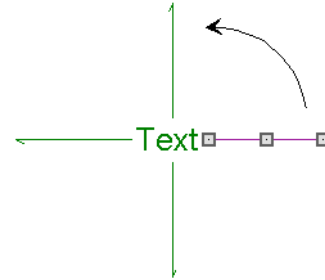

Text Styles

In Home Designer Interiors, a Text Style is a set of attributes assigned to any object that displays text, such as Dimensions and object labels.

Note: Because of its ability to use multiple attributes in the same object, Rich Text does not use Text Styles. See “Rich Text Specification Dialog” on page 198.

There are three Text Styles in Home Designer Interiors. You can edit these Text Styles to suit your needs in the **Text Style Defaults** dialog

- The Default Label Style affects the appearance of labels for objects such as doors and windows;

- The Default Text Style controls the appearance of legacy Text objects, and dimension line labels, unless specified otherwise.
- The Default Room Style controls the appearance of room labels.

Text Style Defaults



Select **Edit > Default Settings**, click on “Text Styles” and click **Edit** to open the **Text Style Defaults** dialog. The **Saved Text Style Defaults** dialog will open, allowing you to select which Saved Text Style Defaults you would like to edit.

Saved Text Style Dialog

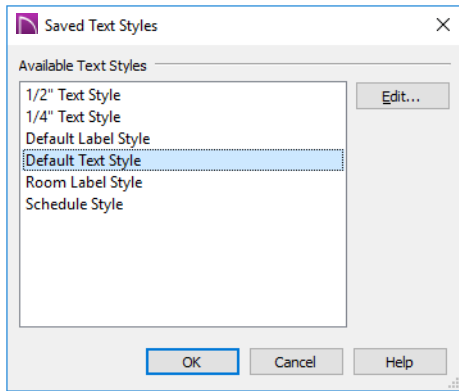

- Select the **Name** of one of them from the drop-down list. This is the currently selected Text Style.

- Click the **Edit** button to open the defaults dialog for the selected Text Style so that you can edit it.
- Click **OK** to close the **Saved Text Style Defaults** dialog and save any changes you made in the defaults dialog.
- Click **Cancel** to close the **Saved Text Style Defaults** dialog without saving any changes that you may have made in the defaults dialog.

The settings in the **Text Style Defaults** dialog are similar to those on the **TEXT STYLE** panel of object specification and defaults dialogs in the program but affect all objects using that style rather than an individual selected object.

Text Style Panel

The **TEXT STYLE** panel is found in various specification and defaults dialogs in the program.

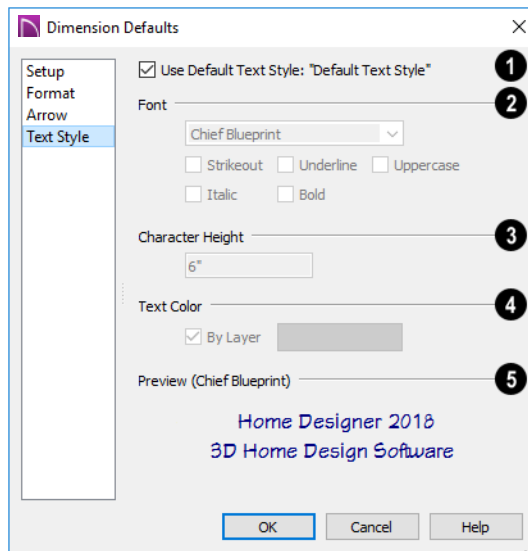

- 1 Check **Use Default Text Style** to use the default style for the selected object type, or uncheck this box to enable the settings below and define a custom style.

The settings that follow are only editable when **Use Default Text Style** is unchecked. When it is checked, information about the Text Style that is assigned to the selected object displays for reference.

- 2 Specify the attributes of the selected Text Style's **Font**.
 - Select a font from the drop-down list.
 - The text styles **Bold**, **Underline**, **Italic**, **Strikeout**, and **Uppercase** are available. Check any of the boxes to apply that style.
- 3 Specify the **Character Height** of text using the selected Text Style.

- Enter the **Character Height** in drawing units. This height is subject to the current drawing scale.
- 4 Specify the selected Text Style's **Text Color**. When Use Custom Text Style is not selected above, a Text Color does not display here for reference.
 - When **By Layer** is checked, text uses the line color assigned to the layer that the object it is assigned to is located on. See "Displaying Objects" on page 87.
 - Uncheck **By Layer**, then click the **Color** bar to select a different color. See "Select Color Dialog" on page 372.
 - 5 A preview of the Text Style currently assigned to the selected object displays here.

Doors

Home Designer Interiors comes with tools for creating a wide variety of interior and exterior doors. In addition, the library offers a large selection of specialty doors and doorways including hinged, sliding, pocket, bifold, and garage doors. Additional name-brand door catalogs are also available for download from our web site, www.HomeDesignerSoftware.com.

Chapter Contents

- Door Defaults
- The Door Tools
- Displaying Doors
- Editing Doors
- Changing Door Swings
- Special Doors
- Door Specification Dialog

Door Defaults



Default Settings are accessed by selecting **Edit> Default Settings**.

Click the “+” next to **Doors** to show the door sub-headings. Select a subheading and click the **Edit** button to open the defaults dialog associated with your selection:

The **Door Defaults** dialogs look nearly the same as the **Door Specification** dialog. See “Door Specification Dialog” on page 218.

There are only a couple of differences:

- Since default settings are specified here, “Use Default” is not an option for some

settings as it is in the **Door Specification** dialog.

- The **Door Type** cannot be changed in the Defaults dialogs.

Because Hinged and Sliding Doors are often used in both interior and exterior applications, they have both Interior and Exterior Door Defaults.

Interior vs Exterior Doors

Regardless of its **Door Type** or the tool used to create it, a door will be:

- An Interior Door if it is placed into a wall that separates two interior rooms;
- An Exterior Door if it is placed into a wall that separates an interior room from either

an exterior room or the building's exterior. See "Room Types" on page 165.

This rule applies to doors copied and pasted from one location to another just as it does to those created using the Door Tools.

The Door Tools



To place a door, select the type you want from the **Build> Door** submenu.

Move your mouse pointer over a wall section. When a preview outline can be seen, click to place a door at that location.

The minimum initial size for doors varies by Door Type. For example, If there is room enough along the wall to fit a 12" (300 mm) wide Hinged Door, a preview outline will display and a door can be placed. Garage doors, in contrast, must initially be at least 6' (1800 mm) wide.

Doors can be placed in both straight and curved walls, as well as span across straight, collinear wall segments.

A newly created door inherits the settings in the **Door Defaults** dialog for its door type. Once created, doors can be edited in a variety of ways. See "Door Defaults" on page 209.

Doors cannot be placed in a wall specified as Invisible. See "Room Dividers and Invisible Walls" on page 137.

Once placed, any door may be changed into any other type of door in the **Door Specification** dialog. See "General Panel" on page 219.

Hinged Doors



Select **Build> Door> Hinged Door** and click a wall where you want to place a hinged door. Hinged doors can be placed on interior or exterior walls, and can be set up so that different door styles are placed in each. A hinged door becomes a double door when its width is four feet or greater.

The initial swing direction of a hinged door depends on the location of the mouse pointer relative to the wall when you click. The door will swing towards the side of the wall that you click nearest.

The initial hinge side of a hinged door can be set by clicking to place the door and then holding the mouse button down rather than releasing it. Move the mouse toward the end of the door that you would like the hinges to be on: as the mouse pointer nears either end, the door preview's hinge side will move to that end. You can also adjust the door's swing direction in this manner. When the swing direction and hinge side are correct, release the mouse button.

Doorways



Choose **Build> Door> Doorway** and click a wall to place a doorway.

Doorways are simply openings without a

door and can be placed on interior or exterior walls, or in railings and fences to provide an opening. You can assign a door from the library to a doorway if you wish.

Sliding Doors



Select **Build> Door> Sliding Door** and click on a wall where you want to place a sliding door. Sliding doors can be placed on interior or exterior walls and can be set up so that different door styles are placed in each. If placed in an exterior wall, the door is glass; if placed in an interior wall, it is a solid slab.

The initial opening side of a sliding door can be specified by moving the mouse pointer along the wall while the mouse button is still pressed.

The default sliding door dimensions are 5'-0" x 6'-8" with a 12" bottom frame and a 6" frame on the sides and top.

Pocket Doors



Select **Build> Door> Pocket Door** and click a wall where you want to place a pocket door.

As with sliding doors, the initial opening side of a pocket door can be specified by moving the mouse pointer along the wall while the mouse button is still pressed.

The default pocket door dimensions are 2'-6" x 6'-8" high. A pocket door becomes a double pocket door if its width is four feet or greater.

Bifold Doors



Choose **Build> Door> Bifold Door** and click a wall where you want to place a bifold door.

Like a hinged door, the initial opening side of a bifold door depends on the location of the mouse pointer relative to the wall when you click. The door will open towards the side of the wall that you click nearest.

Similarly, the initial hinge side of a sliding door can be specified by moving the mouse pointer along the wall while the mouse button is still pressed.

The default interior single bifold door is 2'-6" x 6'-8". A bifold door becomes a double bifold if its width is greater than three feet.

Bifold doors always display closed in all 3D views.

Garage Doors



Choose **Build> Door> Garage Door** and click a wall to place a garage door.

The default garage door is 8'-0" x 7'-0" high. A garage door must be at least two feet wide.

In floor plan view, dashed lines show the size and location of the garage door when open.

Garage doors will build into a garage stem wall provided the room is designated as a garage before the door is inserted. See "Room Types" on page 165.

The Doors & Doorways Library Catalog



The Doors & Doorways library catalog can be accessed by selecting

View > Library Browser and browsing to Home Designer Core Catalogs > Architectural > Doors and Doorways. This catalog contains a variety of interior and exterior doors, as well as special entryways and wrapped openings.

Entryways and wrapped openings are examples of Doorways, which are wall openings that do not have doors within them.



To add a door to the Doorway, select a **Door Type** other than “Doorway” from the drop-

down list in the **Door Specification** dialog. See “General Panel” on page 219.

You can also select a custom door from the library and place it into a doorway in floor plan view or any 3D view.

To place a library door in a doorway

1. Go to floor plan view or any 3D view.
2. Open the Library Browser.
3. Browse or search to find a custom door style that suits your needs.
4. Select the door in the Library Browser, then click on the doorway to place the selected door within it. If a door already exists, it is replaced.
5. Continue clicking other doorways as needed.

Displaying Doors



The display of doors and door labels is controlled in the **Display Options** dialog. See “Display Options Dialog” on page 88.

Doors can only be placed in walls, so if a wall’s layer is turned off, any doors placed in that wall will not display, either. See “Displaying Walls” on page 142.

If the “Doors” layer is turned off, doors and their casing do not display but openings in the walls where they are located are visible.

In Floor Plan View

A door’s jamb, and swing are all represented in floor plan view. Doors in exterior walls and doors that open to exterior type rooms such as a Garage, Porch, or Deck have a

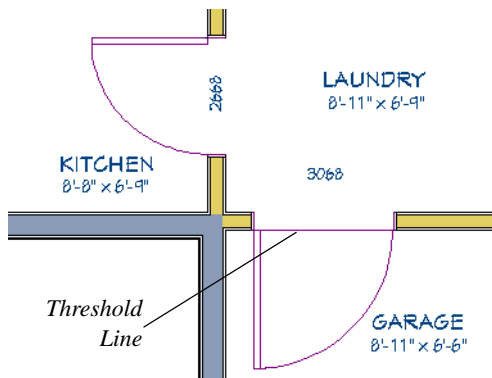

threshold line across the opening in floor plan view. See “Room Types” on page 165.

You can specify whether an exterior door has a threshold in the **Door Specification** dialog. See “Casing Panel” on page 221.



If an exterior door to a Garage room on Floor 1 extends into a Garage stem wall or curb on Floor 0, its location will be indicated on Floor 0. See “Garages” on page 282.

In 3D Views

You can specify whether a selected door is shown open or closed in 3D views by clicking the **Show Door Open in 3D**  and **Show Door Closed in 3D**  edit buttons as well as in the **Door Specification** dialog. See “General Panel” on page 219.

If a door is set to display open in 3D, the angle of the open door can be changed using



the edit handles in floor plan view. See “Using the Mouse” on page 213.

Door Labels

Door labels display in floor plan view, centered on the doors they represent, when the “Doors, Labels” layer is turned on and use the “Default Label Style” Text Style. Door labels indicate Width and Height. For example:

- In Imperial plans, the label for a 3’-0” wide, 6’-8” high double hung window will read 3068.
- In metric plans, the label for a 900 mm wide, 2100 mm high double hung window will read 900x2100.

Editing Doors

Before a door can be edited, it must be selected. To select a door, click it when the **Select Objects**  tool or any of the **Door Tools**  are active. Doors and/or windows can also be group selected and edited. See “Selecting Objects” on page 92.

Blocked units are made up of individual doors and windows that have been grouped together to act as one object. You can create what is essentially a blocked door unit by assigning a library door to a doorway from the library.

Select a blocked unit by clicking on it in any view. To select a door that is a component of a blocked unit, click at the location of the component in question, then click the **Select Next Object**  edit button. See “Selecting Objects” on page 92.

In the Specification Dialog

 The most precise method of editing a door is to use the **Door Specification** dialog. Door type, size, casing, materials, and more can all be specified in this dialog. See “Door Specification Dialog” on page 218.

Using the Mouse

In floor plan view, click either of the two end handles and drag along the wall to change the width. The label showing the size updates as the handles are dragged. Click and drag the Move handle at the center to move the door along the wall it is placed in. Use the triangular Rotate handle to adjust the door’s swing.





In 3D views, a selected door has five edit handles: the Move handle at the center and a

Resize handle on each edge. Click and drag an edge handle to resize the door.

A door or window moved against an intersecting wall temporarily stops when the casing meets the intersecting wall. You can continue to drag and it resumes movement past the intersecting wall.

Using the Edit Tools

A selected door or doors can be edited in a variety of ways using the buttons on the edit toolbar. See “The Edit Toolbar” on page 24.

- Click the **Change Opening/Hinge Side**  edit button to change the side of the door that its hinges are on. See “Changing Door Swings” on page 214.
-  Click the **Show Door Open in 3D**  or **Show Door Closed in 3D**  edit button to control the selected door’s appearance in 3D views. See “In 3D Views” on page 213.

Centering Doors



The **Center Object** edit button allows you to center a selected door along a wall within a room or relative to a cabinet or window. See “Using Center Object” on page 112.

To center a door along a wall

1. Select a door or combination of windows and doors in floor plan view.
2. Click the **Center Object**  edit button then choose from one of the following options:
 - Click near a wall inside a room to center the door along that wall in that room.
 - Click outside the house (on the exterior room) near an exterior wall to center the door along an exterior wall.

Door Hardware

Handles, locks, and hinges can be assigned to a door in the **Door Specification** dialog. See “Hardware Panel” on page 222.

Changing Door Swings



Door swing direction and hinge side can be changed using the **Change Opening/Hinge Side** and **Change Swing Side** edit buttons.

The **Change Opening/Hinge Side**  edit button is available for all doors except double doors and garage doors.

The **Change Swing Side**  edit button is available for all doors except pocket doors.

Hinged Doors

In addition to using the edit buttons, hinged doors’ hinge side and swing direction can be changed using the triangular Rotate edit handle.

To adjust the angle of swing:

1. In floor plan view, select the door and grab the triangular handle.

2. Drag to change the amount of swing.

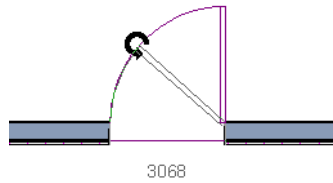

3. Release the mouse.

If you drag near the closed position, the door snaps to a closed position.

To change the swing using edit handles:

1. In floor plan view, select the door and grab the triangular edit handle.

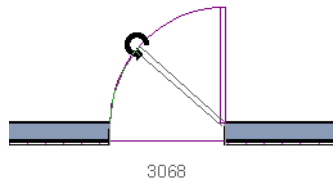

2. Drag the pointer along the path of the new arc to change the hinge side and/or swing direction.

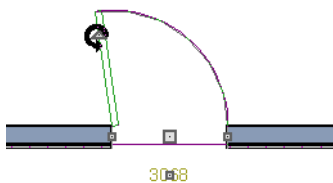



3. Release the mouse.

To change the swing using edit buttons:

1. In floor plan view, select the door.

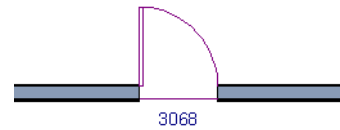
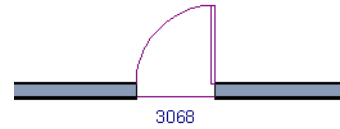
2. To change the hinge side, click the **Change Opening/Hinge Side**  edit button.



3. To change the swing direction, click the **Change Swing Side**  edit button.

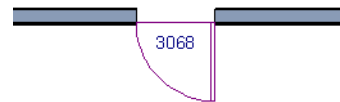
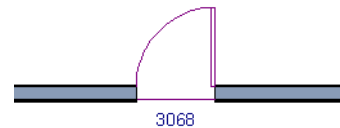

Sliding Doors

To change the side of a sliding door that is fixed, select the sliding door then click the

Change Opening/Hinge Side  edit button.



To flip the fixed and moving sides of the door, click the **Change Swing Side**  edit button.



As with hinged doors, you can also change the Opening/Hinge and Swing sides of a sliding door by clicking and dragging the triangular edit handle.

Pocket Doors

To change the direction of a pocket door, select it and click the **Change Opening/Hinge Side**  edit button.



Note: There must be enough room for the entire door to fit in the opposite wall or the door does not change.

As with hinged doors, you can also change the Opening/Hinge side of a pocket door by

clicking and dragging the triangular edit handle.

Bifold Doors

To change the side of a bifold door that is fixed, select it then click the **Change Opening/Hinge Side**  edit button.



To change the hinged side of the door, click the **Change Swing Side**  edit button.



As with hinged doors, you can also change the Opening/Hinge and Swing sides of a bifold door by clicking and dragging the triangular edit handle.

Garage Doors

To change the side of a garage door that it faces, select it and click the **Change Swing Side**  edit button.

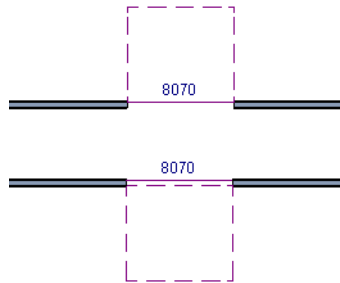

As with other door types, you can also change the Swing side of a bifold door by clicking and dragging the triangular edit handle.

Special Doors

A variety of special doors and doorways can be created in Home Designer Interiors.

Transoms Above Doors

Transom windows above doors are created the same as other stacked windows. See “Grouped Windows” on page 229.

Wrapped Openings

Wrapped openings of various shapes are available in the **Doors & Doorways Library**.

You can also create a wrapped opening by unchecking **Use Interior Casing** and/or **Use Exterior Casing** in a Doorway’s **Door Specification** dialog. See “Casing Panel” on page 221. If base molding is present, it will wrap around the opening.



Openings in Railings

Use the **Doorway**  tool to open a railing for a stairway or other access.

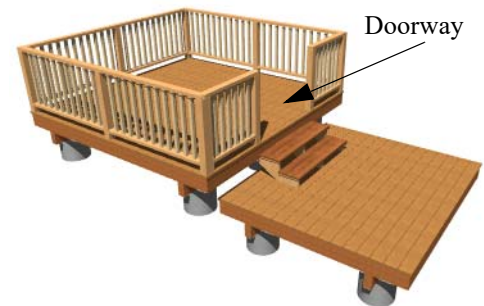



To open a railing across an entire section, resize the doorway’s **Width** so that it is greater than the length of the railing in the **Door Specification** dialog. The opening resizes to the maximum width possible for that space. See “General Panel” on page 219.

Creating a Doorway with a Railing

When a railing is specified as **No Room Def**, it can be positioned within a **Doorway** .



To create a doorway with railing

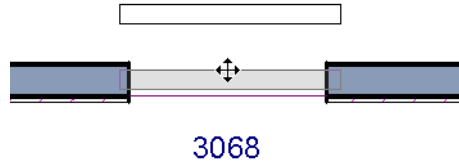

1. Place a **Doorway**  at the desired location in your plan.
2. Select **Build> Railing and Deck> Straight Railing** , then click and drag to draw a railing parallel to the wall with the doorway.
3. Select the railing, then use the Resize edit handles to adjust the length of the

- railing as needed. See “Using the Edit Handles” on page 94.
4. With the railing selected, click the **Open Object**  edit button.
5. On the **GENERAL** panel of the **Railing Specification** dialog, check **No Room Def** and click OK. See “General Panel” on page 153.
6. With the railing still selected, Ctrl + drag it into position within the doorway. See “To move an object freely” on page 111.



Positioning a railing in a doorway

Door Specification Dialog

 To open the **Interior** or **Exterior Door Specification** dialog, select a door and click the **Open Object** edit button or double-click on a door using the **Select Objects**  or any **Door**  tool.

Whether a selected door is Interior or Exterior depends on where it is placed. See “Interior vs Exterior Doors” on page 209.

General Panel

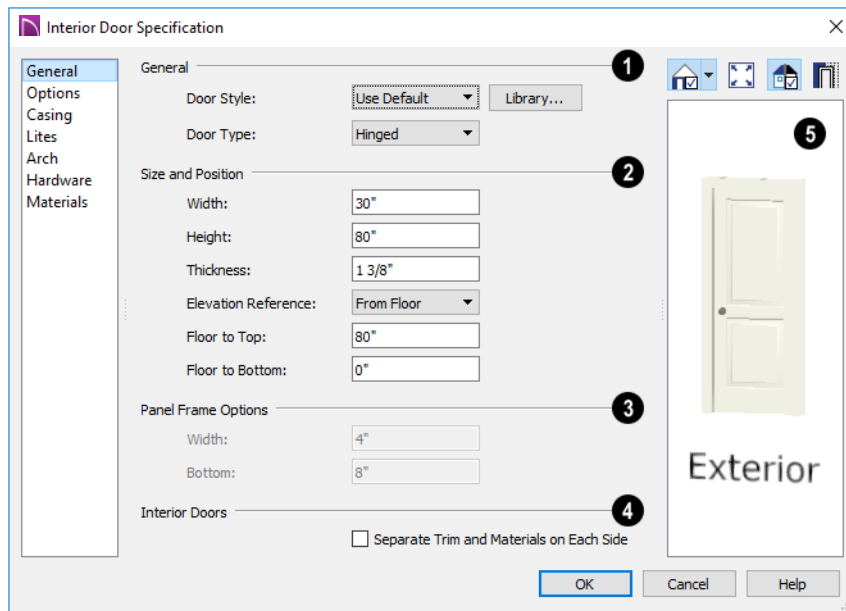

1 General -

- **Door Style** - Select Slab, Glass, Panel, or Louvered from the drop-down list; select a style from the Library; or choose Use Default to use the default door style set in the **Door Defaults** dialog. See “Door Defaults” on page 209.
- Select “Library” from the drop-down list or click the **Library** button to choose a door symbol from the library. Once a library door is selected, its name is added to the Door Style list. See “Select Library Object Dialog” on page 344.
- Specify the **Door Type** as Doorway, Hinged, Slider, Pocket, Bifold, or Garage. In the Door Defaults dialogs, the Door Type cannot be changed.

2 Specify the **Size and Position** of the selected door.

- Specify the **Width**, **Height**, and **Thickness** of the door.
- Select the **Elevation Reference** from the drop-down list. This determines where the next two settings are measured from and also affects their labels.
- Specify the height **to Top**, measured from the selected Elevation Reference to the top of the door frame.
- Specify the height **to Bottom**, measured from the selected Elevation Reference to the bottom of the door frame.

3 **Panel Frame Options** - Specify the dimensions of the selected door’s rails and stiles. Only available for Glass, Panel, and Louvered doors.

- Specify the **Width** of the stiles and top rail.
- Specify the height of the **Bottom** rail.
- ④ The **Interior Doors** settings are only available when the selected door is placed in an interior wall. See “Exterior and Interior Walls” on page 136.
- Check **Separate Trim and Materials for Each Side** to specify the casing, lintels,

and all materials for each side of the selected door independently. When unchecked, the two sides of the door use the same trim and materials.

- ⑤ A preview of the door displays on the right side of the dialog box. A label indicates which side of the door is its Interior and which is its Exterior. See “Dialog Preview Panes” on page 28.

Options Panel

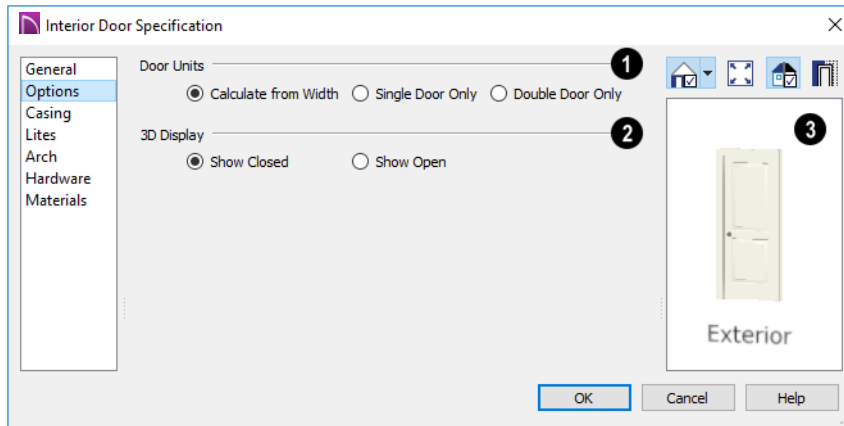

- ① Specify the number of **Door Units** or panels that the selected door has. Not available for garage doors.
- Select **Calculate From Width** to use the program defaults. Hinged, Pocket and Bifold doors default to **Single Door** when less than four feet (1200 mm) wide. If the width is greater than four feet, **Double Door** is the default.
- Select **Single Door** to force the selected hinged, pocket or bifold door to be a single door, regardless of its width.

- Select **Double Door** to force the selected hinged, pocket or bifold door to be a double door, regardless of its width.
- If a Slider door is selected, instead choose **Two, Three, or Four Panel**.

Note: The defaults for Calculate From Width are not editable.

- ② **3D Display** - Specify whether the selected door is shown open or closed in 3D views.

If **Show Open** is selected, the Swing Angle set on the GENERAL panel is used in 3D views. See “General Panel” on page 219.

3 A preview of the door displays on the right side of the dialog box. See “Dialog Preview Panes” on page 28.

Casing Panel

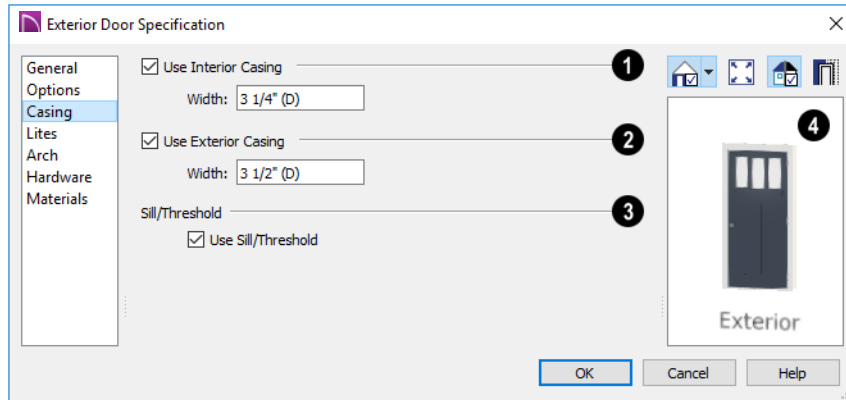

1 Check **Use Interior Casing**, then specify the **Width** of the casing.

2 Check **Use Exterior Casing**, then specify the **Width** of the casing. Not available for doors in interior walls unless **Use Exterior Trim and Materials** is checked on the GENERAL panel. See “General Panel” on page 219.

3 Uncheck **Use Sill/Threshold** to prevent a sill from being generated under the door. See “Displaying Doors” on page 212.

4 A preview of the door displays on the right side of the dialog box. If casing is not specified for a Doorway, the **Show Wall** option will be toggled on automatically. See “Dialog Preview Panes” on page 28.

Lites Panel

The settings on the LITES panel of the **Door Specification** dialogs are only available when the selected door is specified as a Glass door on the General Panel. These settings are

also found on the LITES panel of the **Window Specification** dialog. See “Lites Panel” on page 235.

Arch Panel

The settings on the ARCH panel are not available if the selected door is a Sliding, Bifold or Garage door.

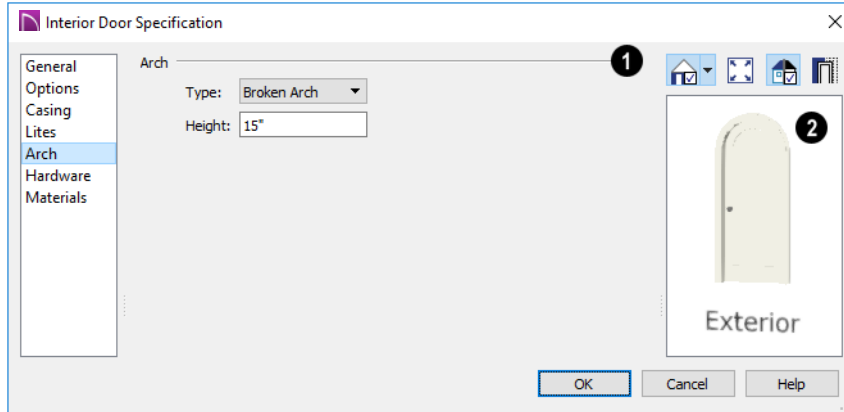

1 Define the style and size of the **Arch**.

- Select a **Type** of arch from the drop-down list.
- Specify the **Height** of the arch, as measured from the base of the arch to the top

of the door. Not available for Round Top Arches.

- 2** A preview of the door displays on the right side of the dialog box. See “Dialog Preview Panes” on page 28.

Hardware Panel

Many of the settings on the **HARDWARE** panel are Dynamic Defaults: if “Use Default” is selected, the setting in the **Door**

Defaults dialog is used. See “Dynamic Defaults” on page 55.

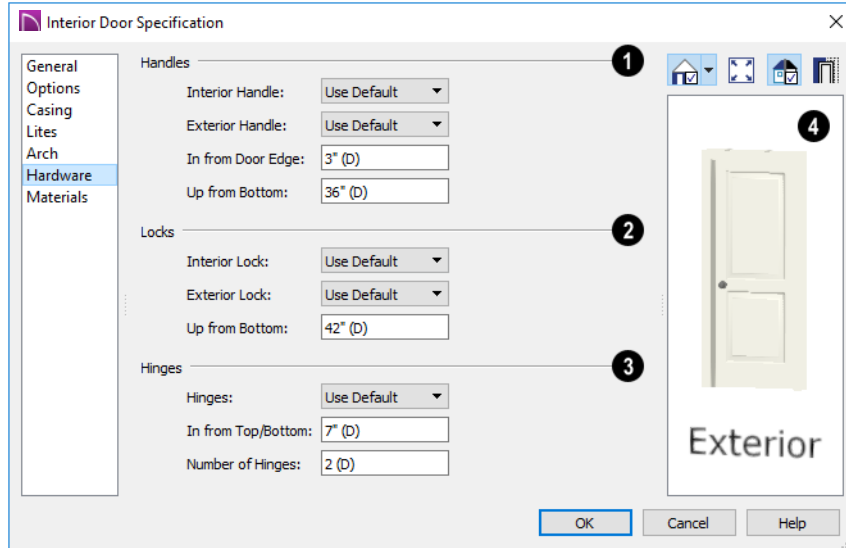

- 1 Specify the **Handles** to be used on the selected door.
 - Select an **Interior Handle** and/or **Exterior Handle** from the drop-down lists.
 - Specify the location of the door handles **In From Door Edge**.
 - Specify the location of the door handles **Up From Bottom**.
- 2 Specify the door's interior and exterior **Locks**.
 - Select an **Interior Lock** and/or **Exterior Lock** from the drop-down lists.
 - Specify the location of the door locks **Up From Bottom**. The locks use the same In From Door Edge value as the handles.
- 3 Specify the **Hinges** to be used on the selected door.
 - Select a style of **Hinges** from the drop-down list.

- Specify the distance **In From Top/Bottom** of the door to the center of the top and bottom hinges.

Note: For hinges to look right, it is best to have at least a 1/4" (6 mm) reveal for the interior, or hinge side, door casing.

- Specify the **Number of Hinges** on the selected door. Interior hinged doors and bifold doors typically have two hinges while exterior hinged doors have three.
- 4 A preview of the door displays on the right side of the dialog box. See "Dialog Preview Panes" on page 28.

Materials Panel

The MATERIALS panel is available for a variety of objects throughout the program. For more information, see "Materials Panel" on page 366.

Manufacturer Panel

The MANUFACTURER panel provides contact information for the selected door's manufacturer. Only available for doors from

Manufacturer library catalogs. See "Manufacturer Catalogs" on page 335.

Windows

Home Designer Interiors can model a wide variety of windows. Fixed glass, hung, casement, sliding, awning, hopper, and louver window styles can all be created with the standard Window tool. Home Designer Interiors can create bay, box, and bow windows with a single click. In addition, the library contains many mullied window combinations.

Chapter Contents

- Window Defaults
- The Window Tools
- Special Windows
- Grouped Windows
- Displaying Windows
- Editing Windows
- Window Specification Dialog
- Bay, Box, and Bow Windows
- Bay, Box, Bow Windows and Roofs
- Bay/Box and Bow Window Specification Dialogs

Window Defaults



Default Settings can be accessed by selecting **Edit> Default Settings**. Select Window from the **Default Settings** dialog.

The settings in the **Window Defaults** dialog control the attributes of a window when it is initially placed in a plan, so you should define the type of window that will be placed most often in your model. See “Default Settings vs Preferences” on page 54.

The panels in the **Window Defaults** dialog are similar to those found in the **Window**

Specification dialog. For more information, see “Window Specification Dialog” on page 232.

Dynamic Window Defaults

A variety of window default values are dynamic, including the **Window Type**, **Casing Specifications**, **Sash** sizes. All **Materials** are also dynamic. When a dynamic default is changed, existing windows using the default value are affected. See “Dynamic Defaults” on page 55.

The Window Tools



To place a window, select **Build> Window** and choose the desired Window Tool. Move your mouse pointer over a wall section, then click to place a window in the wall at that location.

- If there is room enough along the wall to fit a 6” (150 mm) wide Standard Window, a preview of the window will display and a window can be placed.
- The Bay, Box, and Bow Window tools do not have preview outlines. If a minimum width of 30” (725 mm) cannot be accommodated at the location where you click, a warning message will display and a window unit will not be created.

Standard Windows can be placed in both straight and curved walls, as well as span across straight, collinear wall segments. In contrast, a Bay, Box, or Bow Window can only be placed in a single, straight wall.

Windows cannot be placed in a wall specified as Invisible. See “Room Dividers and Invisible Walls” on page 137.

Standard Windows



Select **Build> Window> Window**, then click on a straight or curved wall to place a Standard Window at that location.

A Standard Window is a single window that is not a bay, box, or bow window. These special types are made up of multiple Standard Windows.

A Standard Window that is part of a special window is called a Component Window.

Standard Windows can be specified as any of a variety of window types, such as double hung, casement and awning. See “Window Specification Dialog” on page 232.

Bay Windows

 The roof is affected by Bay, Box and Bow Windows. These windows should therefore be placed before the roof is built.

 A **Bay Window** is composed of three wall sections, each with a single component window. The two side walls are at an angle to the main wall. Select **Build> Window> Bay Window** and click on a straight wall to produce a bay window.

When initially placed, bay windows measure 2'-2" across at the front, 4'-2" across at the back, and are 1'-0" deep. The component windows are specified in the **Window Defaults** dialog and their sizes adjust to fit the available space.

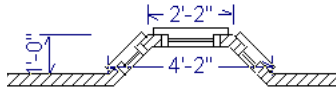

Box Windows

 A **Box Window** is a bay window with side angles set at 90°. Select **Build> Window> Box Window** and click on a straight wall to produce a box window.

Box windows initially measure 4'-2" wide with a depth of 1'-6". The component windows are specified in the **Window Defaults** dialog and their sizes adjust to fit the available space.

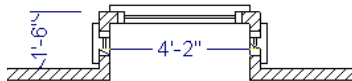

Bow Windows

 A **Bow Window** is a group of identical wall segments that form a segmented curve. Select **Build> Window> Bow Window** and click on a straight wall to produce a 5-section bow window.

The component windows are specified in the **Window Defaults** dialog. Their sizes adjust to fit the available space.

The 5-section bow below has a 4'-10" radius centered 3'-9" inside the wall, giving an opening 5'-10" across and a depth of 11½".

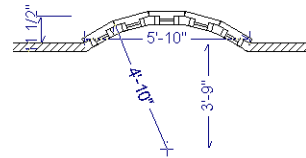

Note: Bay, box, and bow window areas are not included in the living area or in room standard area calculations. They are included in room interior area calculations.

Pass-Throughs

 Select **Build> Window> Pass-Through**, then click on a straight or curved wall to place a Pass Through at that location.

A Pass-Through is simply a wall opening without a window unit placed inside. Like a window, it can have casing and a sill. It does not, however, have a sash, frame, or glass. It is one of the window **Types** available in the **Window Specification** dialog. See "General Panel" on page 232.

Wall Niches



Select **Build> Window> Wall Niche**, then click on a straight or curved wall to place a Wall Niche at that location.

A Wall Niche is a wall opening that does not extend through the entire depth of the wall. You can specify the niche's depth in the **Window Specification** dialog. See "General Panel" on page 232.

Windows Library



Select **View> Library Browser**, then browse to Home Designer Core Catalogs> Architectural> Windows to access a selection of special window units. Select the desired window, then click on a wall to place the window at that location.

Special Windows

A variety of special windows can be created using multiple standard windows, the edit tools or custom symbols.

Creating Manual Bay, Box and Bow Windows

Sometimes it is easier to draw bay, box and bow windows manually than to use the automatic tools. Bays created using walls can have more than one window per section, which is not possible using a bay window unit.

Bear in mind that moving a manually created bay, box or bow window is generally more difficult than moving a unit created with one of the **Window Tools**  since it is composed of individual walls.

Corner Windows

To create a corner window, first create the desired window on each side of the corner. For best results, the heights, casing, and sills of both windows should be the same.

There are a number of ways to control the size of the corner post.



- Use dimensions to position the windows relative to the corner. By default, windows will stop when their interior casing bumps into the adjacent wall. See "Editing Windows" on page 231.
- To move a window all the way into a corner, check **Ignore Casing for Opening Resize**. See "General Plan Defaults Dialog" on page 56.
- To produce a minimal corner post and no siding or casing between the windows, use their Move edit handles. Click and drag each window past the exterior corner until its preview outline moves into the middle of the wall corner.

Special Window Shapes

A selection of special shaped windows is available in the Windows Library, including arched windows and mullied units.

In addition, you can create a variety of window shapes in the **Window Specification** dialog, including:

- Arched windows. See “Arch Panel” on page 238.
- Trapezoidal windows. See “Shape Panel” on page 237.

Stained Glass

A selection of solid stained glass materials is available in the Home Designer Core Catalogs> Materials> Glass library. See “Materials” on page 361.

Vents

A selection of attic, foundation and gable vents are available in the Library Browser. See “The Library” on page 329.

Vents are placed in the same manner as regular windows and can be edited in much the same way, as well.

Grouped Windows

Windows can be grouped together to create a wide variety of custom configurations. Stacked windows are easy to create in 3D views using their edit handles. See “Editing Windows” on page 231.



Notice how the windows and door in this example are separate, with spaces between them. Doors and/or windows can also be positioned so that there are no spaces between the windows and door units, and the casing between them appears to be shared.

Automatically Mullied Openings

To form a mullied group of windows and/or doors, move them close enough together so that their casings touch. Once the casings touch, the windows are mullied together with one casing between the two of them.

The sill of each window in the group must be at the same level for them to share the middle casing. The casing tops do not have to be at the same level. The casings are modeled as if they are one unit but the windows remain separate objects for dimensioning and the Materials List.

Windows can be automatically mullied to doors if the bottom of the window is at the elevation of the floor, equal to the bottom of the door.

Mullied Units in the Library

A selection of mullied window units is available in the Windows library. To place

one in your plan, select it and click on a wall in any view. See “Placing Library Objects” on page 342.

Selecting Components of Mullered Units

To select a component of a mulled unit from the library, click at the location of the component in question, then click the **Select**

Next Object  edit button or press the Tab key until that individual component is selected. Only the component clicked on is selectable using this method. If you need to select a different component, click on it and repeat the process.

If there are multiple levels, it is easiest to select the components in a 3D view. When you have selected an individual component, you can change its parameters in the **Window Specification** dialog. See “Window Specification Dialog” on page 232.

If the selected component is not itself a mulled unit and has no components above it, its **Height** and **Arch** parameters can be changed. Changing the Height causes the component top to move. The bottom remains stationary.

Displaying Mullered Units



As with other windows, the display of mulled window units is controlled in the **Display Options** dialog. See “Displaying Objects” on page 87.

Mulled units are placed on the “Windows” layer by default and have a single label, which is on the “Windows, Labels” layer. Mullered units from the library are also included in the windows category of the Materials List. If the component objects of a mulled unit have unique moldings or materials, they will not be noted in the Materials List.

Displaying Windows



The display of windows in floor plan and 3D views can be controlled in the **Display Options** dialog. See “Display Options Dialog” on page 88.

Windows can only be placed in walls, so if a wall’s layer is turned off, any windows placed in that wall will not display, either. See “Displaying Walls” on page 142.

If the “Windows” layer is not set to display, window casing and other components are not

visible, but the openings in the walls where they are located can still be seen.

In Floor Plan View

A window’s frame, glass, and sill are all represented in floor plan view. This makes some window types, notably Sliding and Double and Triple Casement windows, distinguishable.

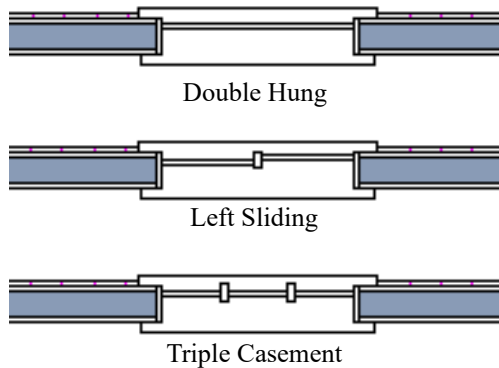

Window types in floor plan view

Bay, box, and bow windows have dimension lines associated with them.

- You can suppress their display by turning off the “Manual Dimensions” layer or on a unit by unit basis in the unit’s specifica-

tion dialog. See “Bay/Box and Bow Window Specification Dialogs” on page 244.

- The arrow style and fill are set in the **Dimension Defaults** dialog. See “Dimension Defaults Dialog” on page 183.

Window Labels

Window labels display in floor plan view, centered on the windows they represent, when the “Windows, Labels” layer is turned on and use the “Default Label Style” Text Style. Window labels indicate Width and Height, followed by Type. For example:

- In Imperial plans, the label for a 3’-0” wide, 4’-0” high double hung window will read 3040 DH.
- In metric plans, the label for a 900 mm wide, 1200 mm high double hung window will read 900x1200 DH.

Editing Windows

Before a window can be edited, it must be selected. Click on a window when the **Select**

Objects  tool or any of the **Window**

Tools  are active. Doors and/or windows can also be group-selected and edited. See “Selecting Objects” on page 92.

To select a window that is part of a blocked unit, click the component window, then click the **Select Next Object**  edit button. See “Selecting Components of Muller Units” on page 230.

Windows can be edited using their edit handles, the edit toolbar buttons, and the

Window Specification dialog. See “Window Specification Dialog” on page 232.

When you select a window in floor plan view, the window size label displays the width followed by the height. For example, a 3036 window is 3’-0” wide by 3’-6” high.

In the Specification Dialog

 The most precise method of editing a window is to use the **Window Specification** dialog. The window type, size, casing, materials, and more can all be specified in this dialog. See “Window Specification Dialog” on page 232.

Using the Mouse

In floor plan view, click either of the two end handles and drag along the wall to change the width. The label showing the size updates as the window is resized.

In 3D views, a selected window has five edit handles: the Move handle at the center and a Resize handle on each edge. Click and drag an edge handle to resize the window.

A single window or a group of windows can be moved with the center edit handle.

A door or window moved against an intersecting wall temporarily stops when it is the casing distance from the intersecting wall. Enable **Ignore Casing for Opening Resize** in the **Plan Defaults** dialog to turn off this behavior. See “General Plan Defaults Dialog” on page 56.

You can continue to drag the selected window and it will resume movement past or onto the intersecting wall.

To create a corner window, drag the Move handle straight out past the wall corner, parallel to the selected window’s wall. See “Corner Windows” on page 228.



Using the Edit Tools

A selected window or windows can be edited in a variety of ways using the buttons on the edit toolbar. See “The Edit Toolbar” on page 24.

- Click the **Change Wall Side**  edit button to move the selected Wall Niche to the opposite side of the wall. See “Wall Niches” on page 228.

Window Specification Dialog



To open the **Window Specification** dialog, select a window and click the **Open Object** edit button; or double-click the window using the **Select Objects**  or a **Window**  tool.

The settings in this dialog are similar to those in the **Window Defaults** dialog. See “Window Defaults” on page 226.

The settings in this dialog are also similar to those in the **Wall Niche**, **Mulled Unit** and **Window Symbol Specification** dialogs. Although similar, a number of the options cannot be edited when either a window symbol or a mulled unit from the library is selected, and some panels are not available. See “Grouped Windows” on page 229.

General Panel

In the **Wall Niche Specification** dialog, only the **Size and Position** settings on this panel

are available. See “Wall Niches” on page 228.

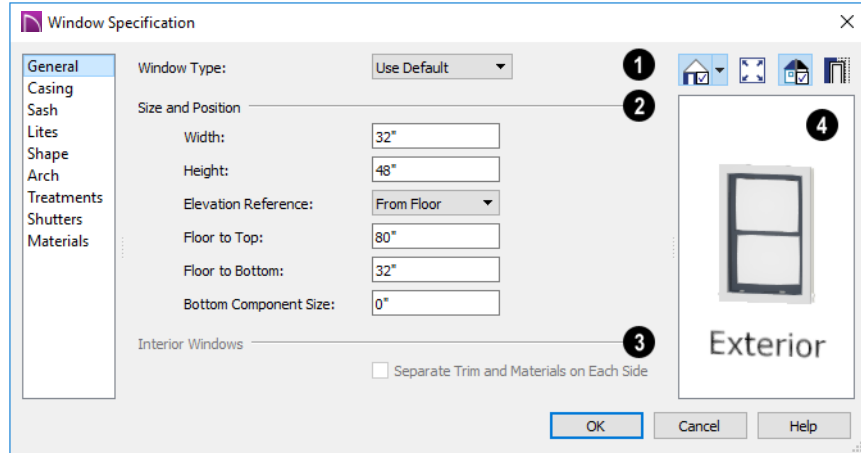

1 **Window Type** - Select the type of window from the list. The first entry in the list is the Default type set in the **Window Defaults** dialog.

2 Specify the **Size and Position** of the selected window.

- Specify the window's **Width** and **Height**.
- Select the **Elevation Reference** from the drop-down list. This determines where the next two settings are measured from and also affects their setting labels.
- Specify the height **to Top**, measured from the selected Elevation Reference to the top of the window frame.
- Specify the height **to Bottom**, measured from the selected Elevation Reference to the bottom of the window frame.
- Specify the **Depth** of the selected Wall Niche, measured from the wall surface to the back of the niche. Only available for Wall Niches.

Note: When either the Floor to Top or Floor to Bottom setting is modified, the other will adjust in response to prevent the window's Height from changing.

- Specify the **Bottom Component Size** for Single Hung, Double Hung, Double Awning, Double Hopper, and Triple Hopper windows; specify the **Top/Bottom Component Size** for Triple Awning windows; or,
- Specify the **Side Component Size** for Triple Casement and Triple Sliding windows, the **Right Component Size** for Left Sliding windows, or the **Left Component Size** for Right Sliding and Double Casement windows.

A **Component Size** value of 0 creates a window with identically sized components.

3 The **Interior Windows** settings are only present when the selected window is a Pass-Through placed in an interior wall. See "Exterior and Interior Walls" on page 136.

- Check **Separate Trim and Materials for Each Side** to specify the casing and all materials for each side of the selected Pass-Through independently. When unchecked, the two sides use the same trim and materials.
- 4 A preview of the selected window displays here. A label indicates which side of the window is its Interior and which is its Exterior. See “Dialog Preview Panes” on page 28.

Casing Panel

The CASING panel is not available in the **Window Symbol Specification** dialog.

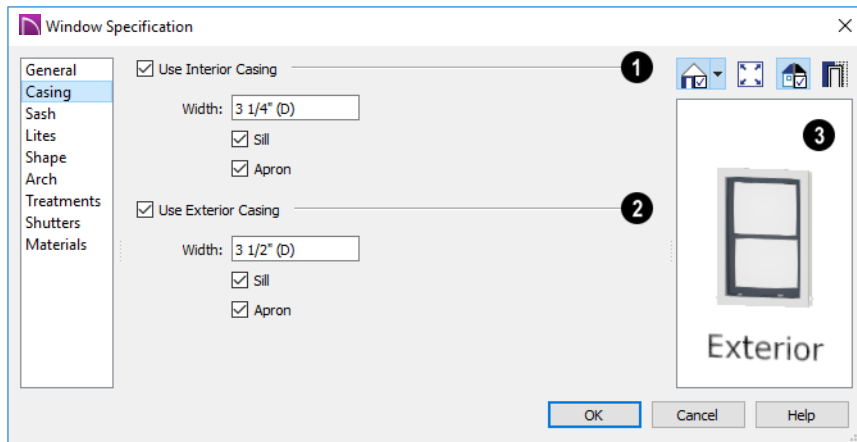

- 1 Check **Use Interior Casing**, then specify the **Width** of the casing.
 - 2 Check **Use Exterior Casing**, then specify the **Width** of the casing. If the selected window is a Pass-Through placed in an interior wall, these settings will be unavailable unless **Separate Trim and Materials on Each Side** is checked on the
- GENERAL panel. See “General Panel” on page 232.
- 3 A preview of the selected window displays here. You may need to rotate the preview to see the casing you are editing. If casing is not specified for a Pass-Through, the Show Wall option will be toggled on automatically. See “Dialog Preview Panes” on page 28.

Sash Panel

The settings on the SASH panel control the size and position of the selected window’s sash. Note that increasing the Side, Middle,

Top or Bottom Width decreases the area of the glass and vice versa.

The SASH panel is not available in the **Wall Niche Specification** dialog, and the settings

on this panel are not available for Pass-Throughs.

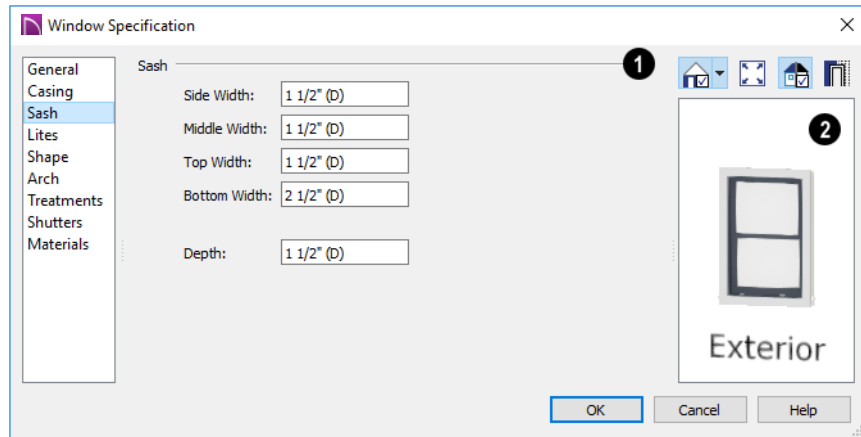

1 Specify the width and depth of the selected window's **Sash**, which are the pieces of the window that hold the glass.

- Specify the **Side Width** of all vertical sash members: those at the window sides as well as the central members of Casement and Sliding windows. This is also the width of the top portion of the window when an arch is specified.
- Specify the **Middle** width of horizontal components between the top and bottom sash in Double Hung, Double and Triple Awning, and Double and Triple Hopper

windows. It does not affect Casement and Sliding windows.

- Specify the **Top** and **Bottom Widths**. The **Top** value is not used if the window has an arch.
- Specify the **Depth**, or thickness, of the sash stock measured from the exterior to the interior.

2 A preview of the selected window displays here. See “Dialog Preview Panes” on page 28.

Lites Panel

The LITES panel allows you to add muntins to windows, and is also available for Glass doors. See “Doors” on page 209.

There are four possible styles of muntin bars.

The LITES panel is not available in the **Wall Niche Specification** dialog, and the settings on this panel are not available for Pass-Throughs.

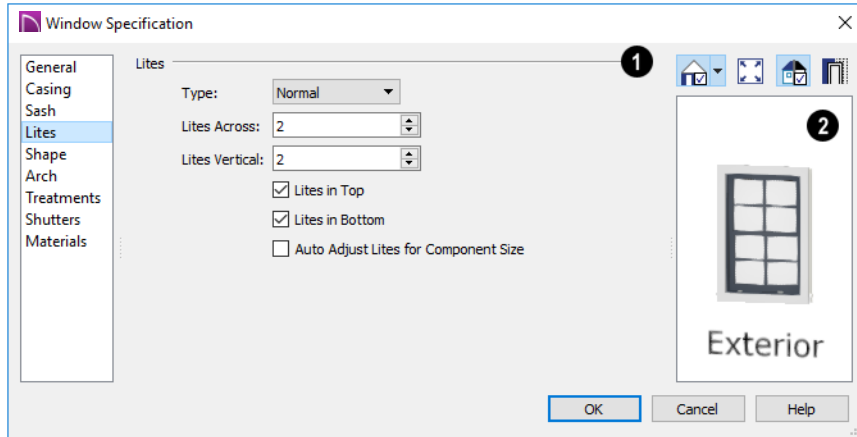

1 Specify the number, position and style of **Lites** for the selected window.

- Select a **Type**, or style, of window lite from the drop-down list.

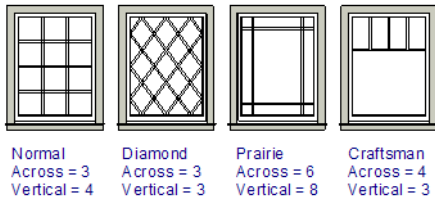

- **Normal** style is the most common, with muntins going horizontally and vertically. Colonial windows are an example of the normal style.
- **Diamond** style uses angled muntin bars to divide up the lites. French windows are an example of the diamond style.
- **Prairie** style is based on the normal style, but with all the central muntin bars removed, leaving only the two outside muntin bars both horizontally and vertically. Typically, both Lites Across and Lites Vertical should be set between 6

and 8. Federal or Federation windows are an example of the Prairie style.

- **Craftsman** style is based on the normal style, but only the topmost horizontal muntin bar is kept with all the portions of the vertical muntin bars above it. Typically, both Lites Across and Lites Vertical should be set between 4 and 8.
- Enter the number of horizontal **Lites Across** in each sash.
- Enter the number of vertical **Lites Vertical** in each sash.
- Check or uncheck **Lites in Top** and/or **Lites in Bottom** - or **Lites in Left** and/or **Lites in Right** - to specify either one or both of the sashes to have divided lites.
- Check **Auto Adjust Lites for Component Size** to have the program produce lites that are consistent in size across all components. When this is checked, the window's lites and its specification settings may not agree; when unchecked, lites in the components may not be consistent in size.

Note: Because the fixed window in a Triple Sliding window is twice the size of the movable windows, the fixed section has a vertical muntin bar. To eliminate this, uncheck Auto Adjust Lites for Component Size..

2 A preview of the selected window displays here. See “Dialog Preview Panes” on page 28.

Shape Panel

The settings on the SHAPE panel control the position of the selected window’s corners, allowing you to create angled edges and mitered top corners.

If any of these settings are used to create a custom shape, the selected window will be automatically specified as “Fixed Glass” on the GENERAL panel. If the selected window

has an arch specified on the ARCH panel, it will be removed.

The SHAPE panel is not available for mullied units or window symbols from the library.

Note: The Left and Right settings on this panel refer to the window’s exterior.

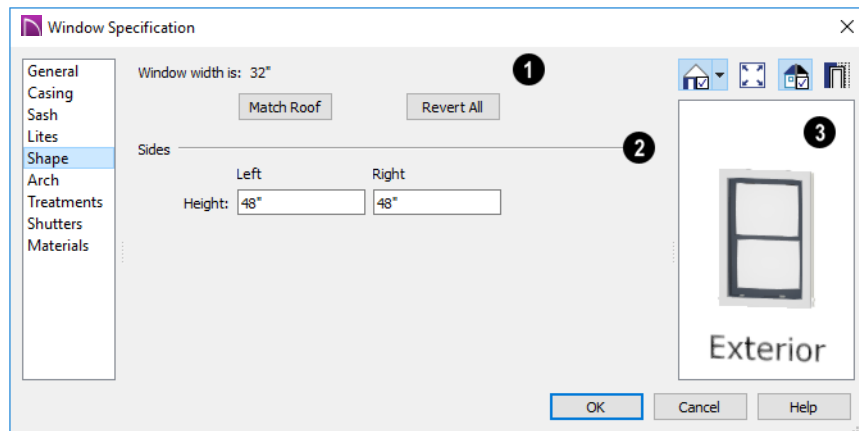

1 **Window Width** displays for reference. It can be changed on the General Panel.

- Click **Match Roof** to match the angle of the top of the window to the pitch of the roof above by changing its Sides heights, below. If either Top Inside Corner box is checked, it will become unchecked.

- Click **Revert All** to restore the window to its original shape, type and arch settings.

- 2 Specify the height of the window's **Left and Right Sides**, as measured from the bottom of the window. By default, these settings match the window's Height.
- 3 A preview of the selected window displays here. You may want to rotate

the view so the window's exterior can be seen. See "Dialog Preview Panes" on page 28.

Note: The Left and Right settings on this panel refer to the window's exterior.

Arch Panel

The ARCH panel is not available for window symbols from the library, and its settings are

not available if the selected window has been modified using the Shape Panel.

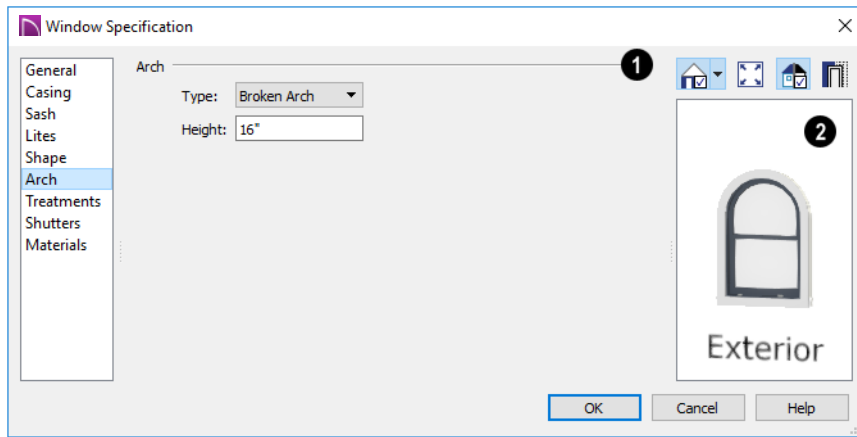

- 1 Define the style and size of the **Arch**.
 - Select the **Type** of arch desired from the drop-down list.

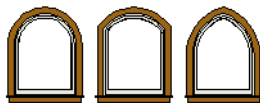

*Round Broken Gothic
Top*

- Specify the **Height** of the arch, as measured from the top of the window to the

base of the arch. The Height can be defined for all arch types except Round Top and Octagonal Arches.

- 2 A preview of the selected window displays here. You may want to rotate the view so the window's exterior can be seen. See "Dialog Preview Panes" on page 28.

Note: The Left and Right settings on this panel refer to the window's exterior.

Treatments Panel

The settings on the TREATMENTS panel allow you to add embellishments to the interior and exterior of the selected window or mullied unit.

The TREATMENTS panel is not available in the **Wall Niche** and **Window Symbol Specification** dialogs.

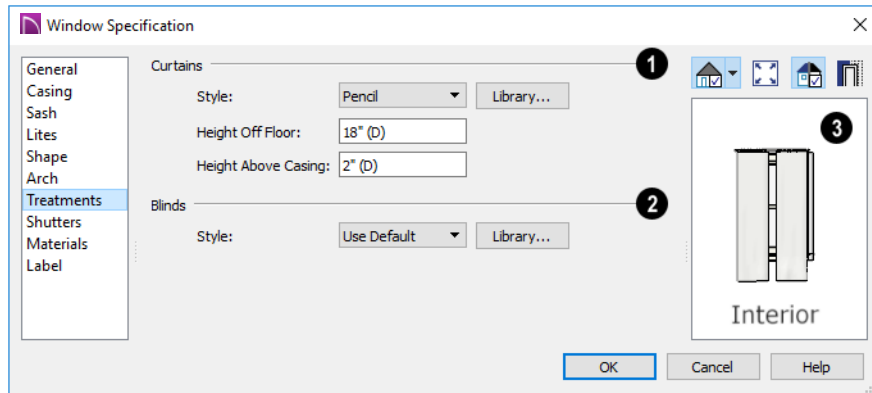

- 1 Specify **Curtains** for the selected window or mullied unit's interior side.
 - Specify a style of **Curtains** by selecting "Use Default", "None" or "Library" from the drop-down list. If a non-default library item has been selected, its name will display in the list, as well.
 - Click the **Library** button or select "Library" from the drop-down list to choose a style of curtain from the library. See "Select Library Object Dialog" on page 344.
- Specify the **Height Off Floor** of the bottom edge of the curtains.
- Specify the **Height Above Casing** of the top of curtains.
- 2 Specify a style of **Blinds** in the same manner that Curtains are chosen, above.
- 3 A preview of the selected window displays on the right. You may want to rotate the view so the window's interior or exterior can be seen, as needed. See "Dialog Preview Panes" on page 28.

Shutters Panel

The settings on the SHUTTERS panel allow you to specify exterior shutters for the selected window or mullied unit from the library.

The SHUTTERS panel is not available in the **Wall Niche** and **Window Symbol Specification** dialogs.

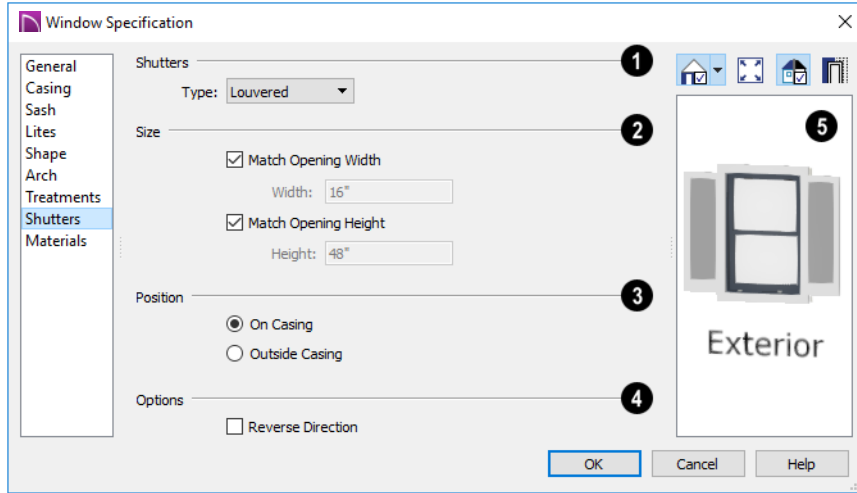

- 1 Select a **Type** of **Shutters** from the drop-down list.
- 2 Specify the **Size** of the selected shutters.
 - When **Match Opening Width** is checked, each shutter’s width is exactly half that of the window, excluding casing.
 - Uncheck **Match Opening Width** to specify a **Width** in the text field. If the window is later resized, the shutters will not adjust in response.
 - When **Match Opening Height** is checked, each shutter’s height equals that of the window, excluding casing.
 - Uncheck **Match Opening Height** to specify a **Height** in the text field. If the window is later resized, the shutters will not adjust in response.
- 3 Specify the **Position** of the shutters relative to the window.
 - Select **On Casing** to position the shutters just outside the window frame, like functional shutters.
 - Select **Outside Casing** to position shutters outside the window casing, as decorative shutters often are.
- 4 Additional shutter **Options** can be specified here.
 - Check **Reverse Direction** to orient the shutters so their exterior sides face outward and their interior sides face the wall. For functional shutters, this should remain unchecked.
- 5 A preview of the selected window displays on the right. In order to see the shutters, you may need to rotate the preview to show the Exterior. See “Dialog Preview Panes” on page 28.

Materials Panel

The settings on the MATERIALS panel are the same as those found on the same panel in

dialogs throughout the program. See “Materials Panel” on page 366.

Manufacturer Panel

The MANUFACTURER panel provides contact information for the selected window’s

manufacturer. Only available for windows from Manufacturer library catalogs. See “Manufacturer Catalogs” on page 335.

Bay, Box, and Bow Windows



Bay, Box and Bow Windows are created much the way regular windows are: select a tool, then click a wall to place that window type.

Home Designer Interiors automatically builds a foundation under bay/box/bow windows placed on floor 1 unless they are raised from their original position. That section of the foundation wall is also a bay/box/bow, but without windows. If the foundation was generated before the window is placed, the foundation must be rebuilt or edited manually.

Editing Bay, Box and Bow Windows

Bay, box and bow windows are edited similar to regular windows, with one exception: in floor plan view, a diamond-shaped Depth edit handle displays on the section. Drag this Depth handle outward to increase the depth, or inward to decrease the depth of the unit. See “Editing Windows” on page 231.

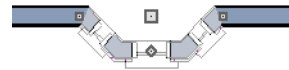

Depth edit handle on a bay window

Bay, box and bow windows can also be edited in their respective specification dialogs. See “Bay/Box and Bow Window Specification Dialogs” on page 244.

Displaying Bay, Box and Bow Windows

The display of bay, box and bow windows is controlled in the **Display Options** dialog. See “Display Options Dialog” on page 88.

Like other windows, bay, box and bow windows can display labels: either a single label for the unit, or one for each component. See “Window Labels” on page 231.

Bay, box and bow window width and radius dimensions, which display in floor plan view when specified to do so in the window’s specification dialog, are placed on the “Dimensions, Manual” layer. See “Options Panel” on page 246.

Component Windows

A component window within a bay, box or bow window can be resized like any other standard window. To select a component window, click at the location of the component in question, then click the **Select Next Object**  edit button or press the Tab key.

- Only the bay or box window component that was clicked on is selected using this method. If you need to select a different component, click on it and repeat the process.
- In a bow window, all components are identical, so only one component can be selected. Changing this component changes them all.

Resizing Components

An individual component window can be resized using the edit handles, by changing settings in the component's **Window Specification** dialog.

When a bay/box/bow window is first created, there is room for one standard trimmer on each side of each component window. When the bay as a whole is moved and resized, its components automatically resize so that a standard trimmer is still accommodated.

If a component window is resized, it retains its size if at all possible when the containing bay/box/bow window is moved or resized. If the bay is resized in such a way that the component is too large to fit even with a thinner trimmer, the component resumes its default behavior, resizing as the containing bay window is resized.

Floors and Ceilings

When originally created, the floor and ceiling within a bay, box, or bow window are the same heights as the floor and ceiling of the room in which it is placed.



Both the top and bottom heights of these window units can be adjusted in its specification dialog or a 3D view using its edit handles to create a lowered ceiling and/or a bench seat or garden window.



When the ceiling is lowered, the top heights of the walls that define the window unit are also lowered. When a roof is built over the unit, its height will be affected, as well.

When the bottom of the window is raised to create a bench seat, the unit's walls will not

reach the ground. As a result, window units with bench seats will have no foundation beneath them when the foundation is built.

Bay, Box, Bow Windows and Roofs

Several different roof styles can be specified for bay, box and bow window units in the **Bay/Box/Bow Specification** dialog. See “Bay/Box and Bow Window Specification Dialogs” on page 244.

If you change a bay, box, or bow window’s roof specification, you will need to rebuild the roofs to see the changes. See “Rebuilding Roofs” on page 323.

Hip Roofs

By default, a hip roof is built above the unit when roofs are automatically generated. No roof directives need to be selected in the specification dialog to produce this roof.



Use the Existing Roof

To generate a standard roof that ignores a bay, box, or bow window, check **Use Existing Roof**.

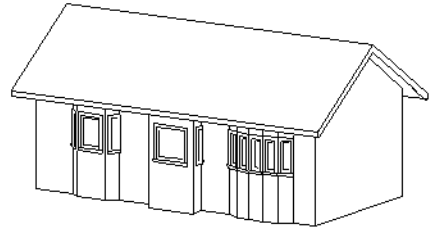

With this option the bay, box, or bow windows is tucked under the roof eave. You may find it helpful to increase the width of the eaves. See “Roof Panel” on page 324.

Extend the Existing Roof

To have the main roof extend down over the window unit and follow the shape of the unit, select **Extend Existing Roof**.

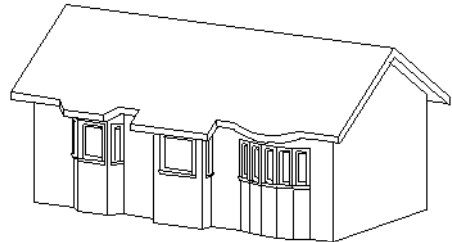

For this roof style, the ceiling heights of the window unit and the adjacent room must be the same. If you lower the ceiling of the window unit and then build the roof, a lower hip roof over the window is created. See “Floors and Ceilings” on page 242.

If a header is desired over the window unit, first build the roof, then lower the ceiling of the window unit. Do not rebuild roof planes.

Rectangular Hip Roofs

To create a rectangular-shaped hip roof above a bay, box, or bow window, select **Rectangular Roof Over**.

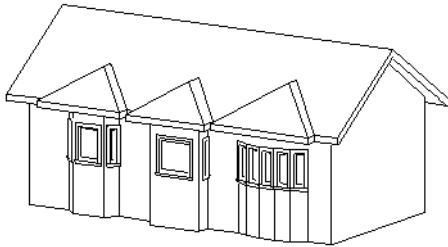

Extend Existing Roof - Rectangular

To extend the main roof down over a window unit to create a rectangular roof over it rather than one that follows its shape, select both **Extend Existing Roof over** and **Rectangular Roof Over**.

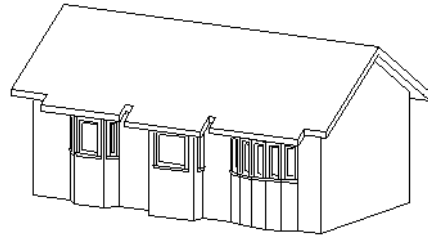

Gable Roof

A gable roof is not one of the automatic options for the roof above a bay, box or bow window.

Bay/Box and Bow Window Specification Dialogs



To open the **Bay/Box Window Specification** or the **Bow Window Specification** dialog, select a Bay, Box or Bow Window and click the **Open Object** edit button.

The options in this dialog can only be set for objects placed in a plan: Bay, Box, and Bow Windows do not have defaults dialogs.

General Panel

- 1 **Size** - Specify the **Width** and **Depth** of the selected Bay, Box, or Bow Window.
- 2 Specify the height and structure of the **Ceiling** within the selected window.
 - Check **Has Lowered Ceiling** to enable the settings that follow. When this is unchecked, the ceiling height and finish material within the window is the same as that for the adjacent room.
 - Specify the **Height Lowered**, which is measured from the ceiling height of the adjacent room.

Note: If the Height Lowered is 0", Has Lowered Ceiling will become unchecked when you click OK.

- 3 Specify the height and structure of the **Floor** within the selected window.
 - Check **Has Raised Floor** to enable the settings that follow. When this is unchecked, the floor height and material within the window is the same as that for the adjacent room.
 - Specify the **Height Raised**, which is the measured from the floor height of the adjacent room.

Note: If the Height Raised is 0", Has Raised Floor will become unchecked when you click OK.

Options Panel

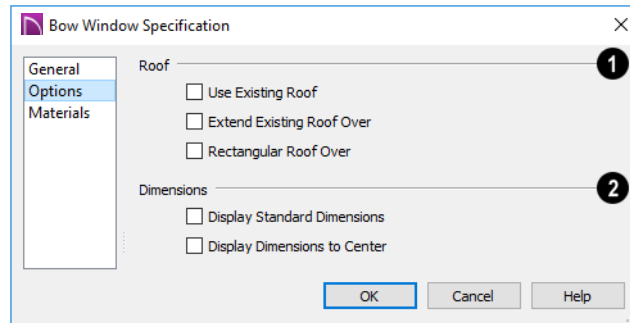

- 1** Specify the structure of the **Roof** over the selected window unit. See “Bay, Box, Bow Windows and Roofs” on page 243.
 - Check **Use Existing Roof** if the existing roof needs no changes to accommodate the bay window.
 - Check **Extend Existing Roof Over** to extend the existing roof plane to cover the bay window below.
 - Check **Rectangular Roof Over** to create a roof over the bay window that is square across the end instead of following the profile of the roof.
- 2** Specify the appearance of the selected window unit’s **Dimensions** in floor plan view.

- Check **Display Standard Dimension** to display the automatically-produced dimensions that show the window’s width and depth.
- Check **Display Dimensions to Center** to display a Bow Window’s radial dimension.

Materials Panel

The settings on the MATERIALS panel are the same as those found on the same panel in dialogs throughout the program. See “Materials Panel” on page 366.

Cabinets

With Home Designer Interiors's cabinet tools you can create base, wall, and full height cabinets as well as soffits, shelves and partitions. These objects are very versatile, allowing for a wide range of customization.

A selection of cabinet door and drawer styles are available in the Library Browser.

Home Designer Interiors also has many customized cabinet symbols and cabinet groups available in the library.

Chapter Contents

- Cabinet Defaults
- The Cabinet Tools
- Cabinet Fillers
- Placing Cabinets
- Displaying Cabinets
- Editing Cabinets
- Editing Cabinet Styles
- Special Cabinets
- Cabinet Specification Dialog
- Shelf/Partition Specification Dialog

Cabinet Defaults



Access default settings for each cabinet tool by selecting **Edit> Default Settings**, then clicking the white arrow beside **Cabinets**. Select a subheading and click the **Edit** button to open the defaults dialog associated with your selection.

Each type of cabinet object has default definitions for size, style, materials and

more. In fact, the default dialog for each cabinet type is similar to its corresponding specification dialog. For descriptions of these settings, see “Cabinet Specification Dialog” on page 257, “Shelf/Partition Specification Dialog” on page 263 and “Soffit Specification Dialog” on page 358.

General Cabinet Defaults

The **General Cabinet Defaults** dialog can be accessed only from the **Default Settings** dialog.

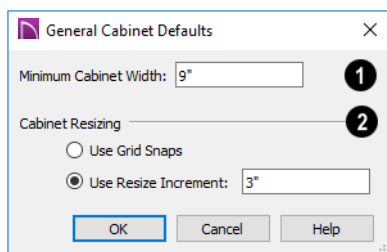

- 1 Specify the **Minimum Cabinet Width**. The minimum allowable width is 1/16 of an inch (10 mm).

- 2 Specify how **Cabinet Resizing** takes place when the edit handles are used.
 - Select **Use Grid Snaps** to resize cabinets using Snap Grid increments. See “Grid Snaps” on page 79.
 - Select **Use Resize Increment** to resize cabinets using the increment specified here.
 - Set the **Resize Increment** at which cabinets resize. The minimum allowable increment is 1/16 of an inch (10 mm).

The Cabinet Tools



Select **Build> Cabinet** to access the Cabinet Tools.

Cabinets are easily created with a single click in floor plan view or any camera view. See “Click-to-Create” on page 80.

Typically, groups of cabinet objects are positioned closely together and arranged to

form work spaces, and there are some special behaviors and techniques to be aware of. See “Placing Cabinets” on page 251.

Once created, cabinets, soffits, shelves, partitions and fillers can be selected and edited much like other box-based objects. See “Editing Cabinets” on page 253.

Base Cabinets



Select **Build> Cabinet> Base Cabinet** and click in any view. Base cabinets can be placed directly under wall cabinets and generate a countertop and toe kick by default.

Wall Cabinets



To place a wall cabinet, select **Build> Cabinet> Wall Cabinet** and click in any view. Wall cabinets can be placed directly over base cabinets.

Full Height Cabinets



To place a full height cabinet, select **Build> Cabinet> Full Height** and click in any view. Full height cabinets generate a toe kick by default and cannot be placed on top of other cabinets.

Soffits



Soffits typically fill the space between cabinet tops and the ceiling, but can also be used to create any object that can be modeled as a 3D box. To place a soffit, select **Build> Cabinet> Soffit** and click in any view.

By default, soffits use the material assigned to interior walls in the **Material Defaults** dialog. Like cabinets, soffits can have molding profiles applied to them.

For more information about using soffits for a variety of purposes, see “Other Objects” on page 355.

Shelves



Select **Build> Cabinet> Shelf** and click in any view to create a shelf.

Create corner shelves by placing one shelf on each wall, then moving or stretching them until they touch.

Once created, shelves can be selected and edited. See “Shelf/Partition Specification Dialog” on page 263.

Partitions



Select **Build> Cabinet> Partition** button and click in any view to create a vertical partition.

Like shelves, partitions can be selected and edited after they are placed.

Partitions can be used with shelves to create complex storage systems.

Cabinet Library Catalog



In the Library Browser, browse to **Home Designer Core Catalogs> Architectural> Cabinets** to access a selection of specialty cabinets. Select the library object you want, then click in any view to place it in the plan. Once placed, library cabinets can be edited. See “The Library” on page 329.

Cabinet Doors, Drawers, and Panels Catalog



A selection of cabinet door, drawer, and panel styles is available in **Home Designer Core Catalogs> Architectural**. Select an item, then click on a cabinet in your plan to place the door or drawer onto that cabinet. Doors, drawers, and panels can be assigned to a cabinet in its specification

dialog, as well. Cabinet doors, drawers, and panels can also be placed as stand-alone fixtures.

Built-In Sinks and Appliances

A variety of fixtures and appliances such as sinks, cooktops, and dishwashers can be placed into cabinets. See “Inserted Objects” on page 343.



Place fixtures and appliances into cabinets early, so that any resizing can be done while there is adequate free space.

To insert a fixture into a cabinet, select the fixture in the Library Browser, then click on a cabinet. There must be enough space in the cabinet or adjoining cabinets to contain the selected fixture.

If a sink or cooktop is inserted into a cabinet with a top Drawer or Double Drawer, its Item Type will automatically change to a False Drawer or False Double Drawer.

Once placed, an inserted fixture can be selected and edited:

- To select a fixture in a cabinet top, click on it and then click the **Select Next Object**  edit button. See “Select Next Object” on page 93.
- Front fixtures can only be modified or deleted in the **Cabinet Specification** dialog. See “Front Panel” on page 259.



Fixtures can be added to both the top and front of the same cabinet. It is up to you to determine which can be effectively and safely combined in the real world.

Electrical Switches and Outlets

Electrical switches and outlets placed within the backsplash area of a base cabinet will display in front of the backsplash in 3D views when the “Electrical” layer is turned. See “The Electrical Tools” on page 266.

Cabinet Fillers

Home Designer Interiors models a continuous countertop and generates fillers automatically when cabinets of the same height are either touching or placed with 3” (75 mm) of one another.

If two cabinets meeting at a corner are separated from each other by 3” (75 mm) or less, the program will automatically generate a filler in the angle between them. A filler is used to separate the front of one of these

cabinets from the one it meets so that drawers and doors have room to operate.

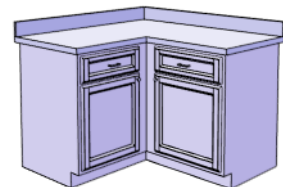
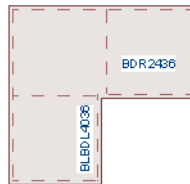

Two base cabinets and the filler between them

Placing Cabinets

Cabinets are easily created with a single click in any view. See “Click-to-Create” on page 80.

When used near a wall corner, the Cabinet Tools will produce corner cabinets and soffits. See “Corner Cabinets” on page 255.

When created, cabinets are positioned relative to the floor of the room in which they are placed. Base and full height cabinets typically rest on the floor while wall cabinets are placed a set distance above the floor. See “Cabinet Defaults” on page 248.

If the ceiling height of the room does not accommodate the height of a cabinet, its **Floor to Bottom** value will be retained and its **Height** will be reduced so that it fits under the ceiling. When this happens, some front items may be removed from the cabinet if there is not enough room for them. See “Front Panel” on page 259.

Because cabinets are typically organized into groups with shared attributes, they have some special behaviors.

Cabinet Snapping and Aligning

Cabinets have several special snapping and aligning behaviors which help you create precisely aligned cabinets quickly and easily.

- When Base and/or Full Height cabinets are within 3” of one another’s sides, they will snap together. Wall cabinets snap in a similar manner, but only with other Wall cabinets.
- When Base and/or Full Height cabinets are within 3” of one another’s sides and their front or back surfaces are within 3”

of aligning, they will become aligned. Wall cabinets snap in a similar manner with other Wall cabinets as well as Full Height cabinets.

- When a Base and/or Full Height cabinet is placed against the back of another Base or Full Height cabinet, its back surface will automatically face the other cabinet’s back. Wall cabinets snap in a similar manner with other Wall as well as Full Height cabinets.
- When a cabinet is placed against a wall, its back and/or side will snap to the wall and, if the wall is moved, the cabinet will move with it.

When cabinets are snapped to a wall or to other cabinets, only exposed end cabinets have side counter overhangs.

Cabinet snapping and aligning occurs even when **Object Snaps** are turned off; however, you can override this behavior by moving a cabinet into the desired position using dimensions. See “Moving Objects Using Dimensions” on page 192.

Cabinet Merging

When cabinets of the same height and type are placed side-by-side within 3” (30 mm) of one another they will automatically merge, making any shared components such as the toe kick, countertop, backsplash, and moldings continuous. Any gap between merged cabinets will be automatically filled.

The exposed ends of merged cabinets have side counter overhangs.

Cabinets placed at different angles will also merge if they face toward one another and meet at a front corner. Cabinets that meet at a back corner will also merge provided that they face away from one another at an angle no greater than 87°. In either case, a filler is created in the angle between the two.

If the side of a cabinet is placed within 3" (30 mm) of a wall, the countertop will extend to the wall and a filler will be created.

Base and Wall Cabinets

Base and wall cabinets have different default heights, so they can be placed directly above or below one another without interference. You can use **Object Snaps** to center a wall cabinet's back center point above that of a base cabinet, or vice versa. See "Click-to-Create" on page 80.

Minimum Cabinet Size

If you try to place a cabinet into a space that is too narrow for its default size, the program will place a smaller cabinet with a width that is a multiple of the default **Resize**

Increment. For example, if you try to place a 24" wide cabinet in a 20" wide space and your **Resize Increment** is 3", the program places an 18" cabinet. See "General Cabinet Defaults" on page 248.

If you try to place a cabinet into a space narrower than the default **Minimum Cabinet Width**, a cabinet will not be placed. If, for example, you have a space that is 8" and your **Minimum Cabinet Width** is 9", no cabinet is placed.

Displaying Cabinets



The display of the various cabinet object types, labels, module lines, door opening indicators and more is controlled in the **Display Options** dialog. See "Displaying Objects" on page 87.

Like other objects, cabinets are placed in Drawing Groups that affect whether they display in front of or behind other objects in floor plan view. By default, wall cabinets, soffits and shelves are drawn in front of base and full height cabinets and partitions. You can modify a selected cabinet's place in the drawing order by clicking the **View Drawing**

Group Edit Tools  edit button. See "Drawing Group Edit Tools" on page 86.

Objects assigned to cabinets, including hardware and moldings, are located on the same layer as their parent object. They display in 3D views, but are not shown in floor plan view. There are two notable exceptions: countertops and doors/drawers.

- Countertops are drawn on the "Cabinets, Countertops" layer in all views.
- Cabinet doors and drawers are drawn on the "Cabinets, Doors & Drawers" layer in all views, but only display in 3D views .

By default, cabinet module lines display in floor plan view when cabinet objects of the same type are placed side by side. If you prefer that these lines not display, turn off the "Cabinets, Module Lines" layer. You can

also specify whether module lines are full or partial.

You can also display cabinet front indicator arrows in floor plan view by turning on the “Cabinets, Front Indicators” layer.

Cabinet labels display in floor plan view when the “Cabinets, Labels” layer is turned on and use the “Default Label Style”.

In 3D views, cabinet doors and drawers are drawn on the “Cabinets, Doors & Drawers” layer, and their display can be turned on and off.

Editing Cabinets

Cabinets can be selected in 2D and 3D views and edited using the edit handles, the edit toolbar and their specification dialog.

Using the Mouse

Cabinets can be edited like other box-based objects. See “Editing Box-Based Objects” on page 104. The edit handles that a cabinet displays when selected will vary depending on the view.

When a cabinet is selected in floor plan view or on its top surface in a 3D view, ten edit handles display: the Move handle at the center, the Rotate handle, and a Resize handle on each edge and at each corner.

In 3D views, cabinets can be selected on any surface: front, side, back or top. When the side of a cabinet is selected, five edit handles are available: the Move handle and a Resize handle on each edge.



In the Specification Dialog



A selected cabinet can be customized in a variety of ways in its specification dialog. See “Cabinet Specification Dialog” on page 257.

Using the Edit Tools

A cabinet or cabinets can be edited in a variety of ways using the buttons on the edit toolbar. See “The Edit Toolbar” on page 24.

Add to Library

Cabinets can be saved in the Library Browser. Select a base, wall or full height cabinet or cabinet filler and click the **Add to Library** edit button. See “Add to Library” on page 338.

Using Dimensions



Like various other objects, cabinets can be moved and resized using dimensions. See “Moving Objects Using Dimensions” on page 192.

Dimensions locate the sides and/or corners of cabinet boxes. If you wish, you can move a dimension’s extension lines to locate the centers or countertop edges in floor plan view after the dimension line is drawn. See “Editing Extension Lines” on page 191.

Moving Walls with Cabinets Attached

When a cabinet is placed or moved against a wall, it will snap to the wall and become attached to it. When a wall is moved, all attached cabinets move with it.

Moving a wall to an unattached cabinet will not attach the cabinet to it: the cabinet must be moved to the wall.

Editing Cabinet Styles

A variety of settings allow you customize the appearance of your cabinets to create styles ranging from traditional to contemporary.

If the desired style is known before cabinets are placed, you can save time by specifying that style in the **Cabinet Defaults** dialogs before you start drawing. See “Cabinet Defaults” on page 248.

Cabinet Face Items

A variety of different face items can be added to the front of any cabinet, including doors, drawers, cutting boards, and horizontal separations. Face items can be moved, resized, as well as removed and can also be split vertically or horizontally to produce a variety of custom configurations. See “Front Panel” on page 259.

When adding, removing, or resizing face items, it is helpful to keep a few rules in mind:

- When the overall height of a cabinet or the height of a face item is changed, the height of the lowest face item that is not a

Separation is adjusted to accommodate the change.

- If you increase the height of the lowest face item, the non-Separation item directly above is adjusted; if you decrease its height, a Blank Area and Separation are created below it.

Note: To ensure that Face Item heights always equal the total cabinet front height, the program automatically adjusts the bottom Face Item as changes are made elsewhere. This means you should start editing Face Items at the top and work down.

Doors, Drawers and Panels

Cabinet doors, drawers, and panels can be applied in either of two ways:

- In the **Cabinet Specification** dialog. See “Door/Drawer Panel” on page 262.
- Directly from the Library Browser.

Select a style in the Library, then click on a cabinet to apply the selected style to that

cabinet. See “Replace From Library” on page 344.

Cabinet Hardware and Moldings

Cabinet handles, pulls, and hinges can be assigned in the **Cabinet Specification** dialog. See “Door/Drawer Panel” on page 262.

Multiple molding profiles can also be applied around the perimeter of a cabinet at any height. For example, you may want a wood edge around base cabinet countertops and a crown molding that ties together the tops of the wall cabinets and full height cabinets. See “Moldings Panel” on page 180.



Wall cabinet with crown molding and light rail

Countertops and Backsplashes

The countertop thickness, overhang, and material for a selected base cabinet can be specified in the **Cabinet Specification** dialog. See “General Panel” on page 258.

Backsplashes can be applied to base cabinets as well as down from wall cabinets on the GENERAL panel of their specification dialogs.

Special Cabinets

There are a number of special cabinet shapes that can be specified. Certain requirements must be met before some special cabinet shapes can be specified. If the requirements are not met, a warning message will explain what is needed. See “Cabinet Specification Dialog” on page 257.



Standard Cabinets

Select **Build> Cabinet> Base Cabinet**  and click in floor plan view to place a standard, rectangular base cabinet.



Standard (default) cabinet

Corner Cabinets

To create a corner cabinet, click as close to an inside wall corner as possible in using either the **Base Cabinet** , **Wall Cabinet** , or **Full Height**  cabinet tool. A corner cabinet remains a corner cabinet when it is moved, edited or copied.

You can turn an existing cabinet into a corner cabinet by selecting “Corner” from the **Special** drop-down list in its specification dialog. See “General Panel” on page 258.

- Before a corner cabinet can be specified in the **Cabinet Specification** dialog, the cabinet’s Width must be greater than its Depth.
- The **Left** and the **Right Side Widths** can be set independently for corner cabinets.



Corner cabinet with sides of equal width

- You can specify a Diagonal Door on corner cabinets to create an angled corner cabinet. See “Front Panel” on page 259.



Corner cabinet with diagonal door

End Cabinets

Open a cabinet for specification and select Left or Right End Cabinet from the **Special** drop-down list to create an end cabinet.



Left End Cabinet

- End Cabinets have an angled front and side.
- The cabinet width must be no greater than its depth for an end cabinet to be specified.

Radius End Cabinets

Open a cabinet for specification and select Right or Left Radius End from the **Special** drop-down list to create a radius end cabinet.



Radius End cabinets have a 90° arch

As you face the cabinet, a right radius end curves to the right, and a left radius end curves to the left.

Peninsula Radius Cabinets

Open a cabinet for specification and select Peninsula Radius from the **Special** drop-down list to create peninsula radius cabinet.



Peninsula Radius Cabinet

Kitchen Islands

To create a kitchen island, simply place several cabinets back-to-back and/or side-to-side. Match the widths so that each cabinet back or side meets the back or side of only one other cabinet. If this is not done, the lines separating the cabinets cannot be suppressed.

A given side of a single cabinet cannot merge with the edges of two different cabinets. The example below shows two instances of cabinets placed back-to-back. Cabinet fronts and joining surfaces are shown.

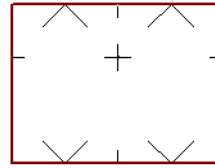

*Correct -
Widths of front and
back cabinets match*

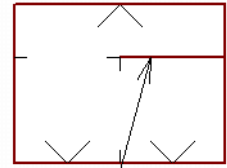

*Incorrect -
Solid line here is not
suppressed.*

Blind Cabinets

Often, when two cabinets meet in a corner, one is partially hidden by the other. This partially hidden cabinet is called a “blind” cabinet. Home Designer Interiors will resize and offset the front items of the partially hidden cabinet so that they are not located in the hidden portion of the cabinet face.

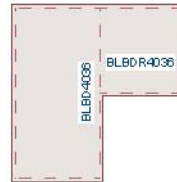

Cabinet Specification Dialog



Select a cabinet and click the **Open Object** edit button to open the **Cabinet Specification** dialog.

The options in the **Cabinet Specification** dialogs are similar to the corresponding **Cabinet Defaults** dialog. See “Cabinet Defaults” on page 248.

General Panel

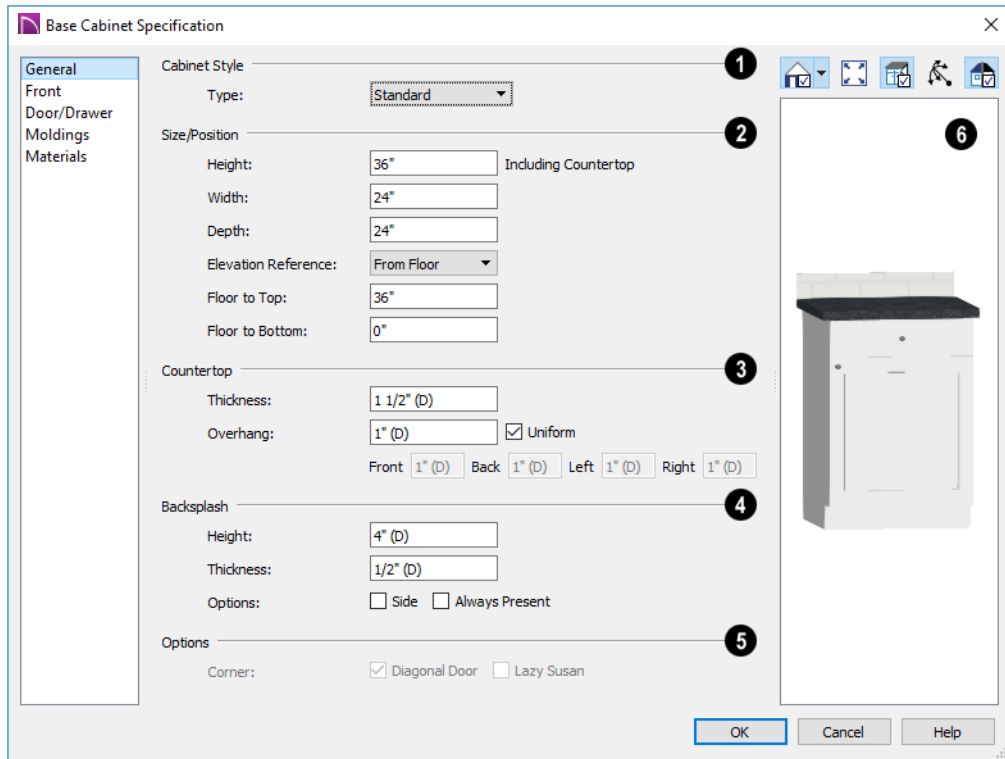

1 A number of **Cabinet Types** are available in the drop-down list. Certain requirements must be met before some types can be specified. See “Special Cabinets” on page 255.

2 **Size/Position** - The selected cabinet’s dimensions and position relative to the floor can be specified here. Fractional values are supported to 1/16th of an inch (1 mm).

- Specify the **Height (Including Counter)** of the cabinet box, as measured from bottom to top. For base cabinets, this value includes the countertop thickness, but not the height of the backsplash.

Note: Height refers to the height of the entire cabinet, including countertop and toe kick. If you change the Countertop Thickness or Toe Kick Height, the cabinet’s total height is not altered. Instead, the cabinet face height and the heights of face items change in response.

- Specify the **Width** of the cabinet box, as measured across the front of the cabinet box from left to right. This does not include the countertop overhang.
- Specify the **Depth** of the cabinet box, as measured from front to back. It does not include the thickness of overlay doors or the countertop overhang.

- For Corner cabinets, the **Width** and **Depth** fields are instead named **Right Side Width** and **Left Side Width**.
 - Select the **Elevation Reference** from the drop-down list. This determines where the next two settings are measured from and also affects their setting labels.
 - Specify the **to Top** distance, measured from the Elevation Reference to the top of the cabinet's countertop.
 - Specify the **to Bottom** distance, measured from the Elevation Reference to the bottom of the cabinet, including the toe kick.
- 3** Specify the dimensions and style of the **Countertop** here. Only available for base cabinets.
- Specify the countertop **Thickness**. Changing this value does not alter the cabinet height, but it does affect the height of face items. See “Front Panel” on page 259.
 - Specify the countertop **Overhang**. Uncheck **Uniform** to specify separate values for each side in the fields below, or leave it checked to use the same value for all sides. Overhangs do not generate on sides that are against a wall or another cabinet. See “Cabinet Snapping and Aligning” on page 251.
- 4** The dimensions and style of the **Backsplash** are specified here. Only available for base cabinets.
- Specify the backsplash **Height** and **Thickness**.
 - Check **Side** to add the backsplash to the side of the cabinet if it is against a wall or a taller cabinet. Not available for Corner cabinets.
 - Check **Always Present** to display the backsplash at all times. If unchecked, a backsplash is present only when the cabinet is against a wall.
 - Check **Backsplash to Base Below** to extend a backsplash from the selected wall cabinet down to the backsplash or countertop of the base cabinet below. Only available for wall cabinets.
- Note that while a base cabinet's backsplash is measured from the countertop up, a wall cabinet's backsplash extends downward.
- 5** **Options -**
- Uncheck **Diagonal Door** to create double doors at right angles instead of a single diagonal door. This option is checked by default in the **Cabinet Defaults** dialog and is only available for Corner Cabinets. See “Corner Cabinets” on page 255.
 - Check **Lazy Susan** to indicate a lazy Susan in the cabinet's label and its appearance in floor plan view. This option does not display in 3D views.
- 6** A preview of the selected cabinet displays on the right side of the panel. See “Dialog Preview Panes” on page 28.

FRONT Panel

If you click on a cabinet face item in the preview on the right side of the dialog, the

Front panel will become active and that face item will be selected.

If the selected cabinet was originally created in Chief Architect, some settings on this panel may display for reference only.

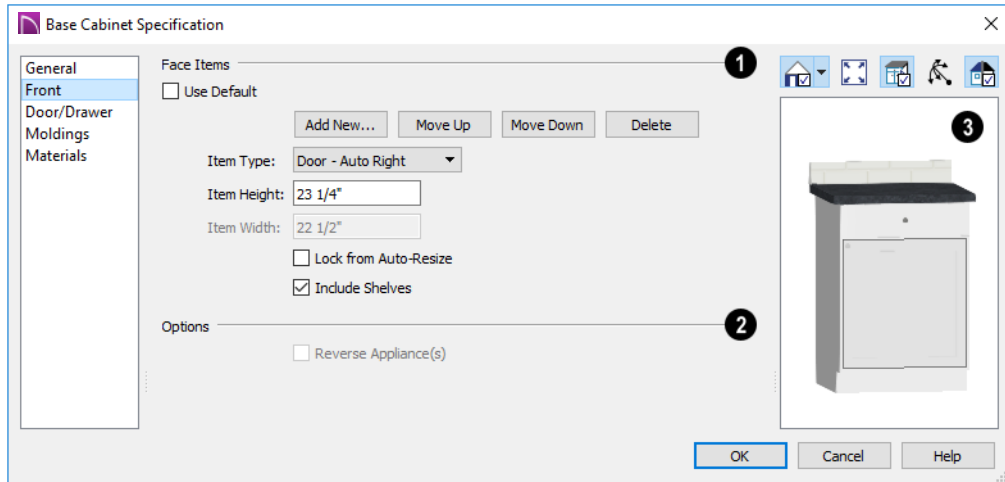

- 1 Most of the **Face Items** settings are only active when a door, drawer, or other face item is selected.
- Check **Include Shelves** to include shelves in the selected “Door” or “Opening” face item.

To select a face item, click on it in the preview on the right. When a face item is selected, **Use Default** will be unchecked; it is highlighted in the list as well as in the preview; its attributes can be edited; and the list can be navigated using the arrow and number keys. The vertical frame pieces on the sides of the cabinet front are referred to as stiles and cannot be selected in the preview. See “Cabinet Face Items” on page 254.

- A numbered tree list of face items displays here. Item numbers start at the top

of the cabinet and go down the face to the bottom of the cabinet. Item 1 is usually the top face frame Separation, or rail. The selected face item is highlighted; if no item is selected, the “Vertical Layout Parent” heading will be highlighted.

- Click **Add New** to add a new face item directly below the currently selected item. When a face item is added, the height of the lowest item on the cabinet front is reduced to make room for the new item. If you click **Add New** with no face item selected, the new item is added to the bottom of the cabinet face.
- In the **New Cabinet Face Item** dialog, define the **Item Type**, **Item Height**, and click OK. If the Item Type is “Separation”, you can check **Default** to use the default Separation Height.

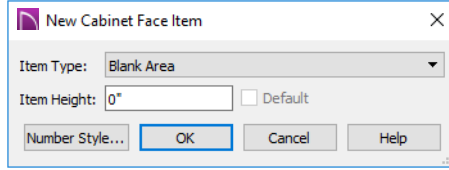

- Click **Delete** to remove the selected face item. When an Auto Left, Auto Right, Left, Right, or Double Door is deleted, it is replaced by an Opening; when other face item types are deleted, the height of the lowest item is increased to make up the difference. You can also press the Delete key on the keyboard.

 The program tries to maintain a single separation between all face items. When you add or delete a face item, separations are usually added or deleted with them.

- Click **Move Up** to move the currently selected item up one position, switching places with the item directly above.
- Click **Move Down** to move the currently selected item down one position, switching places with the item directly below.
- Choose the selected face item's **Item Type** from the drop-down list:
- Specify the selected face item's **Item Height**. Fractional values are supported to 1/16th of an inch (1 mm). For doors and drawers, this is the height of the opening rather than the item front height. For best results, edit face item heights starting at the top of the cabinet and work

down. See "Cabinet Face Items" on page 254.

Note: If the Height of an Appliance has been changed, entering a "d" restores its default height. See "Built-In Sinks and Appliances" on page 250.

- Check **Lock from Auto Resize** to prevent the selected face item from resizing when the cabinet is resized.
 - The selected item's **Item Width** displays here for reference only. For doors and drawers, this is the width of the opening rather than the item front width.
 - Check **Include Shelves** to include shelves in the selected "Door" or "Opening" face item.
- 2** Select **Reverse Appliance** to reverse any appliances inserted into the selected cabinet from left to right: for example, to change a left hand door on a built-in refrigerator to a right hand door. This option is only available for cabinets with an inserted appliance.
 - 3** A preview of the selected cabinet displays on the right side of the panel. See "Dialog Preview Panes" on page 28.
- Click the **Select Cabinet Face Item**  button, then click on an item on the front of the cabinet in the preview to select that item. The selected face item is highlighted in grey.
 - The cabinet **Label** displays below the preview pane.

DOOR/DRAWER Panel

The settings on the DOOR/DRAWER panel allow you to control the appearance of the

selected cabinet’s doors, drawers and hardware.

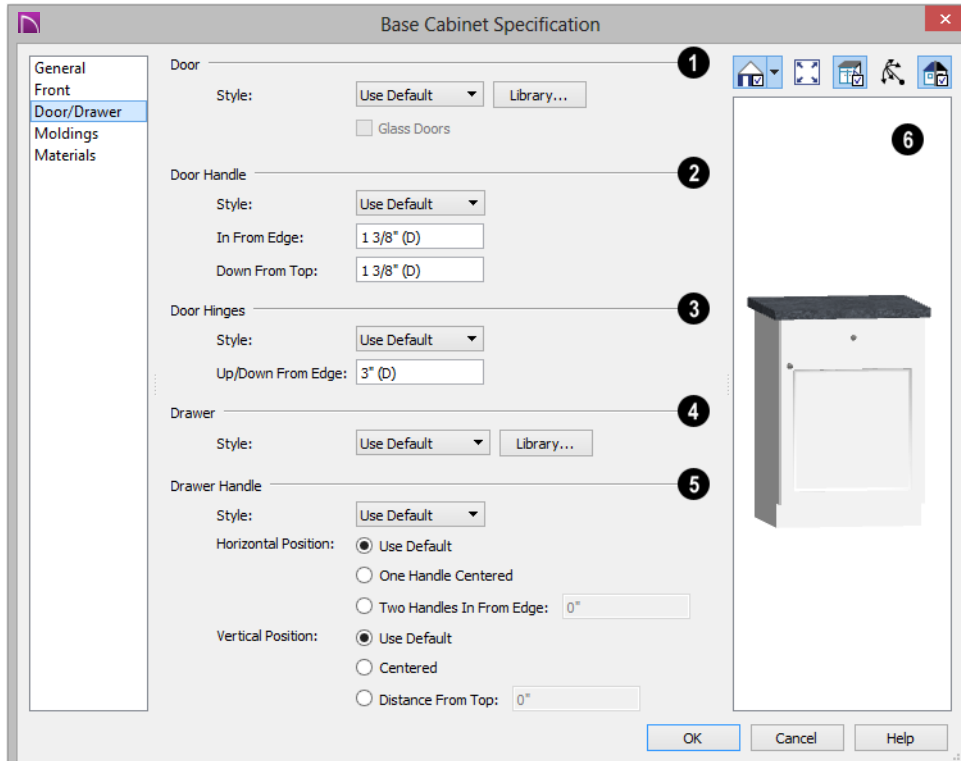

1 Specify the appearance of the **Doors** applied to selected cabinet.

Select a door **Style** from the drop-down list. See “Doors, Drawers and Panels” on page 254.

- Select “Use Default” to apply the door style specified in the defaults dialog for the selected cabinet’s type. See “Cabinet Defaults” on page 248.

- Select “Slab Doors” to apply a flat door front or “Framed Doors” to apply a door with a frame and flat panel front.
- Select “Library” or click the **Library** button to select a cabinet door from the library. If a library door has been previously selected, its name will display in the list. See “Select Library Object Dialog” on page 344.
- Check **Glass Doors** to use a glass material for the panel of Framed doors or for the entire door for Slab doors. Not avail-

able when “Library” is the selected door Style.

- 2 Specify the characteristics of the selected cabinet’s **Door Handles**.
 - Select a door handle **Style** from the drop-down list.
 - Specify the position of the handle **In From Edge**, as measured from the edge of the door opposite the hinges.
 - Specify the height of the handle **Down From Top**, as measured from the top edge of the door. For wall cabinets, this value is measured **Up From Bottom**.
- 3 Specify the characteristics of the cabinet **Door Hinges**.
 - Select a door hinge **Style** from the drop-down list.
 - Specify the location of the hinges **Up/Down From Edge**, as measured from the door edge. If the cabinet door is more than 35 1/4” (880 mm) high, three hinges will be created instead of two.
- 4 Select a **Drawer Style** from the drop-down list or choose one from the **Library**. For best results, “Framed” drawers should be at least 6” (150 mm) high.
- 5 Specify the characteristics of the selected cabinet’s **Drawer Handles**.
 - Select a drawer **Handle Style** from the drop-down list.

- Specify the **Horizontal Position** of the drawer handle(s): Choose **Use Default** to use the default position; **One Handle Centered** for a single handle centered on the drawer face; or **Two Handles In From Edge** for two handles set in from the drawer sides by the value specified in the text field.
 - Specify the **Vertical Position** of the drawer handle(s): Choose **Use Default** to use the default position, **Centered** for handle(s) centered on the drawer face, or specify the handle’s **Distance From Top**.
- 6 A preview of the selected cabinet displays on the right side of the panel. See “Dialog Preview Panes” on page 28.
 - The cabinet **Label** displays below the preview pane.

Moldings Panel

The settings on the MOLDINGS panel allow you to assign one or more horizontal moldings around the selected cabinet. See “Editing Cabinet Styles” on page 254.

For information about the settings on this panel, see “Moldings Panel” on page 180.

Materials Panel

The settings on the MATERIALS panel affect the appearance of the selected cabinet in 3D views. For information about these settings, see “Materials Panel” on page 366.

Shelf/Partition Specification Dialog



Select a shelf or partition and click the **Open Object** edit button to open the

Shelf Specification or **Partition Specification** dialog.

The options in these specification dialogs are similar to the corresponding defaults dialogs. See “Cabinet Defaults” on page 248.

General Panel

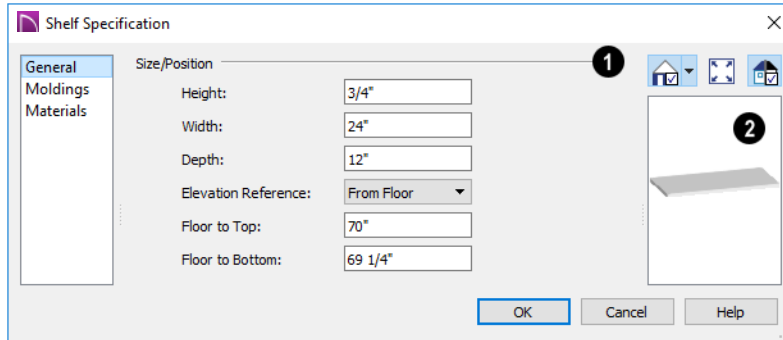

1 **Size/Position** - Specify the **Height**, **Width**, and **Depth** of the shelf or partition.

- Select the **Elevation Reference** from the drop-down list. This determines where the next two settings are measured from and also affects their setting labels.
- Specify the **to Top** distance, measured from the Elevation Reference to the top of the shelf or partition.
- Specify the **to Bottom** distance, measured from the Elevation Reference to the bottom of the shelf or partition.

2 A preview of the selected object displays on the right side of the panel. See “Dialog Preview Panes” on page 28.

Moldings Panel

The settings on the **MOLDINGS** panel allow you to apply molding to the selected object. For information about these settings, see “Moldings Panel” on page 263.

Materials Panel

The settings on the **MATERIALS** panel affect the appearance of the selected object in 3D views. For information about these settings, see “Materials Panel” on page 366.

Electrical

The electrical plan shows the location of all electrical objects such as lights, switches, outlets, smoke detectors and vent fans.

Electrical objects can be displayed in 2D and 3D views. Some electrical light fixtures also add light sources to 3D views. See “Lighting” on page 395.

Usually, the electrical plan is one of the last additions to a plan since the position of most electrical objects is determined by the location of walls, cabinets and other objects.



Building requirements vary throughout the country and around the world. It is your responsibility to comply with local codes.

Chapter Contents

- The Electrical Tools
- Placing Electrical Objects
- Auto Place Outlets
- Connect Electrical
- Electrical Library Content
- Displaying Electrical Objects
- Editing Electrical Objects
- Electrical Service Specification Dialog

The Electrical Tools



Select **Build> Electrical** to access the Electrical Tools.

Most electrical objects are easily created with a single click in floor plan and camera views. See “Click-to-Create” on page 80.

Some electrical objects are designed to be inserted into walls, floors, ceilings or cabinets, although some can also be free-standing. See “Placing Electrical Objects” on page 267.

Once created, outlets, switches, and lights can be selected and edited. See “Editing Electrical Objects” on page 270.

Outlets



Select **Build> Electrical> 110V Outlet** to place 110 volt duplex outlets on walls, the on floor, and on the sides of cabinets and soffits. Select **Build> Electrical> 220V Outlet** to place 220 volt outlets.

The type and height of an outlet will vary depending on where it is placed. For example:

- In rooms defined as Bath or Master Bath, Ground Fault Circuit Interrupt (GFCI) outlets are placed.



If standard outlets are placed in a room prior to defining it as a Bath, you should replace them with GFCI outlets.

- An outlet placed at the back of a base cabinet in floor plan view is positioned above the counter.

- An outlet placed at the back of a base cabinet containing a kitchen sink is placed at the standard 11 1/2" (300 mm) above the floor.
- An outlet placed on the side of a cabinet or soffit will be positioned 32" (800 mm) up from that object's bottom.
- An outlet placed outside the building or in an exterior area such as a deck or porch will be weatherproof.

To take advantage of the program's capabilities, define room types properly before placing electrical objects. See “Room Types” on page 165.

Light Fixtures



Select **Build> Electrical> Light** to place light fixtures on walls, the ceiling, or on soffits. All light fixtures placed in a plan can also serve as light sources in 3D views. To place a light fixture using the Light tool:

- Click near a wall or the side of a soffit to place a wall-mounted fixture at that location.
- Click away from a wall to place a ceiling mounted light.
- Click on the center of a soffit to place a ceiling mounted light on the soffit's bottom surface.
- Click outside of a room and away from a wall to place a path light.
- Some light symbols from the library can be mounted under wall cabinets, as well.

Switches



Select **Build> Electrical> Switch** to place electrical switches on walls or on the sides of cabinets or soffits. Like outlets, the height of switches is measured from the floor to the center of the object.

- A switch placed on the side of a cabinet or soffit will be positioned 32” (800 mm) up from that object’s bottom.
- Switches placed outside the building or in an exterior area such as a deck or porch will be weatherproof.

Auto Place Outlets



Select **Build> Electrical> Auto Place Outlets** and click in a room tool to place outlets at regular intervals around the entire room. See “Auto Place Outlets” on page 268.

Connect Electrical



Select **Build> Electrical> Connect Electrical**, then click and drag to draw splines that snap to electrical switches, outlets, and lights to illustrate wiring circuits. See “Connect Electrical” on page 268.

Lighting and Electrical Library Catalogs



A selection of free-standing and ceiling-, wall- and cabinet-mounted light fixtures is available in the Library Browser at Home Designer Core Catalogs> Architectural> Lighting.

Special use outlets, switches, jacks and numerous other electrical items can be found at Home Designer Core Catalogs>Architectural> Electrical. See “The Library” on page 329.

Placing Electrical Objects

Electrical switches, outlets, lights, and other symbols from the Library are easily created with a single click in any view. See “Click-to-Create” on page 80.

When the Outlet, Switch, and Light tools are used, the type and height of the object that is created will vary depending on where it is placed. As you move your mouse pointer around the view, an object preview will display near the pointer whenever it is over a location where an object can be placed. Specific details for each tool are noted in “The Electrical Tools” on page 266.

The electrical objects in the Library are typically designed for a specific use and can only be placed on a wall, on the floor, or on

the ceiling. Some are instead free-standing and are designed to be placed on a table or the floor. See “Placing Library Objects” on page 342.

Wall mounted outlets, switches, and Library symbols can also be placed on the sides of cabinets and soffits. They will snap to the outside of the cabinet box or to the outside of Side or Back Panels, but ignore doors or drawers.

In 3D Views

When a wall-mounted electrical object is placed in floor plan view, its initial height is based on commonly used standards.

An electrical object placed on a wall in a 3D view will snap to the standard height for its type provided that the mouse pointer is near that height when you click. If you move the

mouse pointer away from the standard height, the object will be positioned wherever you click on the wall, regardless of the height at that point.

Auto Place Outlets



Select **Build> Electrical> Auto Place Outlets** and click in a room to place 110 volt outlets on the walls around the entire room, spaced so that no wall position is farther than six feet (1800mm) from the nearest outlet. 110 or 220 volt outlets are also placed behind large appliances. In addition, a light is placed above each sink.

It is important that a room's Type be defined before **Auto Place Outlets**  is used so that outlets are placed appropriately. For example, GFCI (Ground Fault Circuit Interrupter) outlets are placed over cabinets in Kitchen, Bath and Master Bath rooms. See "Room Types" on page 165.

Auto Place Outlets  does not work in rooms assigned an exterior room type such as

Deck. To place outlets in an exterior room, place them from the Electrical Library or use the **110V Outlets**  tool.

Railings and invisible walls are ignored by **Auto Place Outlets** . If it is used in a room defined by railings or invisible walls, outlets are automatically placed in any adjacent rooms on the other side of these wall types. See "Room Definition" on page 163.

Note: Auto Place Outlets requires that a room have a door before outlets can be placed.

Once placed, any outlet can be moved, edited, or deleted. See "Editing Electrical Objects" on page 270.

Connect Electrical



Select **Build> Electrical> Connect Electrical**, then click and drag to draw splines that snap to electrical switches, outlets, and lights to illustrate wiring circuits.

To create a new circuit or add to an existing circuit, click on a switch, outlet, or light while the **Connect Electrical**  tool is active, drag to the next object and

release. When a Connect Electrical  spline is first drawn, it looks like an arc but actually consists of two segments that are defined by vertex points. When selected, its edit handles display at each of these vertices. If you click and drag one of these edit handles, the length, angle, and curvature of the spline will change but the other vertices will not move.

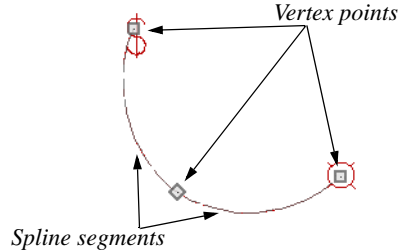

Connect Electrical  splines cannot be snapped to one another: they can only snap to electrical objects. Once drawn, though, additional vertices can be added and used to form complex curves. See “Editing Spline Based Objects” on page 105.

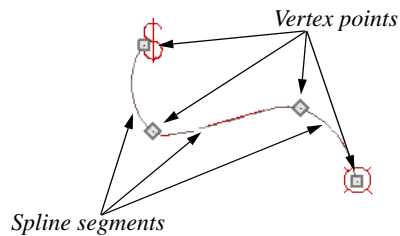

To remove a connection from a circuit, simply select and **Delete**  it. If you remove an electrical object from a circuit, any Connect Electrical splines snapped to it will also be deleted. See “Deleting Objects” on page 117.

Three- and Four-Way Switches

Multiple switches can control an object or group of objects.

- Two switches controlling the same objects are referred to as three-way switches.
- Three switches controlling the same objects are called four-way switches.

In floor plan view, a three- or four-way switch’s “way” number will automatically display in its 2D symbol.

Electrical Library Content

 Select **View > Library Browser** to access a variety of electrical symbols. See “The Library” on page 329.

Browse for electrical objects such as bath vent fans, an electrical panel, fluorescent lights, chandeliers, a smoke detector, thermostat, and more. Select a symbol, then click in your plan to place it on a wall, floor, or ceiling.

Adding Electrical Content

Any electrical symbol placed into a plan can be customized and added to the User Catalog in the Library Browser. Customized settings are retained. See “Add to Library” on page 338.

Displaying Electrical Objects



The display of electrical objects is controlled in the **Display Options** dialog. See “Displaying Objects” on page 87.

When displayed in 3D views, light fixtures act as sources of light that help illuminate the 3D model. See “Lighting” on page 395.

In floor plan view, electrical objects are represented by commonly used CAD symbols that represent the type of object rather than its appearance in 3D.

Like other objects, electrical objects are placed in Drawing Groups that affect whether they display in front of or behind other objects in floor plan view. You can modify a selected object’s place in the drawing order by clicking the **View Drawing**

Group Edit Tools  edit button. See “Drawing Group Edit Tools” on page 86.

Electrical symbols are placed on the “Electrical” layer, while Connect Electrical

splines are drawn on the “Electrical, Connections” layer

Electrical labels display in floor plan view when the “Electrical, Labels” layer is turned on and use the “Default Label Style” Text Style.

Note: Some electrical objects are represented in floor plan view by a symbol that includes text. This text is not part of the object’s label and does not use the Default Label Text Style.

In the Materials List

Electrical objects, including outlets, switches, lights, and symbols from the library, are listed under the Electrical Category in the Materials List. Connect Electrical splines are 2D objects only, however, and are not calculated. See “Materials Lists” on page 427.

Editing Electrical Objects

Electrical objects can be selected as a group and individually in 2D and 3D and edited using the edit handles and the edit toolbar.

Moving Electrical Objects Using Dimensions

Electrical objects can be moved precisely using dimensions. See “Moving Objects Using Dimensions” on page 192.

electrical objects are not located by dimension lines as the lines are drawn. Once created, though, you can edit a dimension

line’s extensions to locate the center of any electrical object. See “Editing Extension Lines” on page 191.

Using the Edit Handles

The edit handles for electrical objects vary depending on the location of the object.

- Wall mounted electrical objects cannot be rotated, so only the Move edit handle displays.

- Electrical objects placed on floors and ceilings can be rotated.
- In 3D views, some ceiling mounted and free-standing light fixtures can be resized.

Using the Edit Tools

A selected electrical symbol can be edited in a variety of ways using the buttons on the edit toolbar. See “The Edit Toolbar” on page 24.

In the Specification Dialog

Electrical objects can be edited in the **Electrical Service Specification** dialog. See “Electrical Service Specification Dialog” on page 271.

Adjusting Electrical Object Heights

When a wall- or cabinet-mounted electrical object is placed, its initial height is based on

commonly used standards. See “Placing Electrical Objects” on page 267.

Once placed, a wall-mounted electrical object’s height can be edited in either of two ways:

- Specify the height in the **Electrical Service Specification** dialog. See “General Panel” on page 271.
- In 3D views, the position of an electrical object can be adjusted using its edit handles.

Deleting Electrical Objects

An electrical object can be deleted by selecting it and clicking the **Delete**  edit button or by pressing the Delete key.

All electrical objects in a room, on a floor, or in the entire plan can also be deleted as a group using the **Delete Objects** dialog. See “Deleting Objects” on page 117.

Electrical Service Specification Dialog



Select an electrical object and click the **Open Object** edit button to open the **Electrical Service Specification** dialog.

The settings in this dialog vary, depending on the type of object you select.

General Panel

The items on this panel vary, depending on the type of electrical object selected.

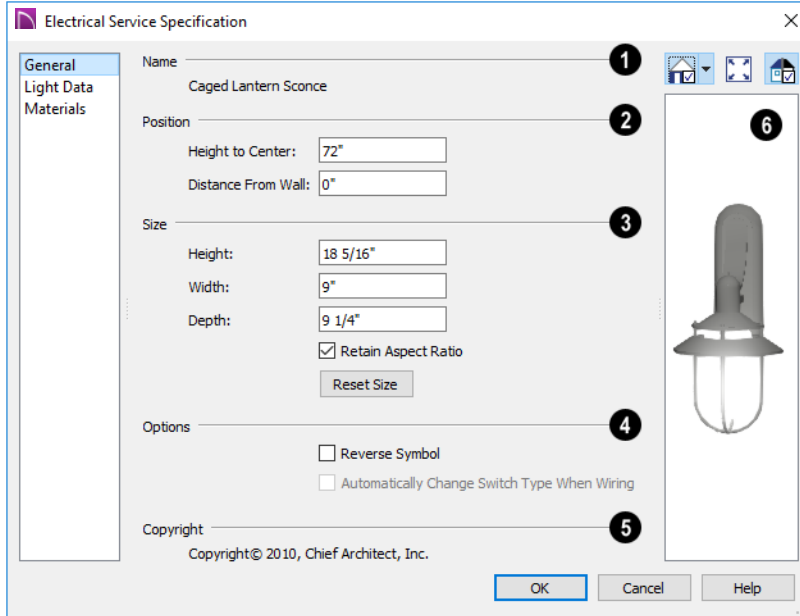

1 The **Name** of the selected object as used in the Library Browser and Materials List displays here.

2 Specify the **Position** of the selected electrical object. The options available depend on the type of object selected.

- Specify the **Offset From Ceiling** of a ceiling outlet or ceiling mounted light. If the light is mounted to a cabinet, this value is the offset from the cabinet.
- Specify the **Height to Center** of a switch, wall outlet or wall light.
- Specify the **Offset From Floor** of a floor outlet or floor lamp.
- Specify the **Distance From Wall** of a wall mounted symbol. A negative value will recess the symbol into the wall and may prevent it from being seen in 3D.

3 Specify the **Size** of the selected electrical symbol.

- Specify the **Height, Width and Depth** of the selected symbol.
- Uncheck **Retain Aspect Ratio** if you would like to modify one of the above values without affecting the others. Doing so may cause the symbol's shape to become distorted. This check box does not affect editing performed outside of this dialog and is an action rather than a state: the next time you open this dialog, it will be checked.
- Click the **Reset** button to restore the electrical symbol's original size.

4 **Options** -

- Check **Reverse Symbol** to reverse the object's appearance so that features on its

left are located on its right and vice versa. Does not affect symmetrical symbols.

- Check **Automatically Change Switch Type When Wiring** for a selected switch to become a three- or four-way switch if your wiring plan uses it as such. See “Connect Electrical” on page 268.

Switches placed from the toolbar use this

option by default; switches placed from the library do not.

- 5 Any **Copyright** information associated with the selected symbol will be stated here.
- 6 A preview of the selected object displays here. See “Dialog Preview Panes” on page 28.

Light Data Panel

The LIGHT DATA panel is available when the selected electrical object is a light fixture.

The available options vary depending on the type of light selected.

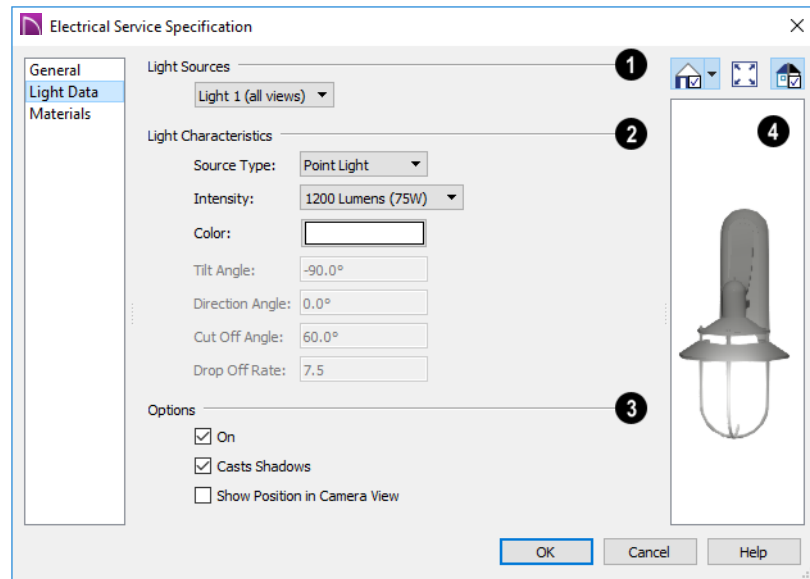

- 1 Each fixture can have multiple **Light Sources**, listed here. Not available for Added Lights. See “Lighting” on page 395.
- Select a **Light Source** assigned to the selected light fixture from the drop-down list. The selected light source can be edited using the settings on this panel.

- 2 Specify the **Light Characteristics** of the currently selected Light Source.
- Select a light **Source Type** from the drop-down list. The type selected determines what options are enabled on this panel. See “Light Types” on page 397.

- Select an **Intensity** from the drop-down list. The available options are described using lumens and correspond to commonly used light bulb wattages.
- Select “Custom” from the **Intensity** list to open the **Custom Light Intensity** dialog and create a custom Intensity setting. See “Custom Light Intensity Dialog” on page 275.
- Click the **Color** bar to define the color of the selected light source. Colored lights alter the appearance of textures and can be used to achieve special effects. See “Select Color Dialog” on page 372.

 The default color of light is pure white, which has the least affect on the appearance of material colors and textures.

The Angle and Drop Off Rate settings below are not available when the Source Type is Point Light.

- The **Tilt Angle** controls the angle of the illumination with respect to the horizon. A value of -90° points the light straight down and a value of 90° points it straight up. 0° is parallel to the horizon.
- The **Direction Angle** defines the direction of the illumination relative to the ground. 0° is measured horizontally pointing to the right. Positive values rotate in a counter-clockwise direction from there. Enter a value up to 360° . If you enter a negative value, the program adds 360° to it when you click OK or press the Tab key.
- The **Cut Off Angle** controls the angle of the cone of illumination for Spot Lights only. A cone angle of 180° creates a spot light that shines in a half sphere on one

side of the light source. A small cone angle, for example 10° , creates a very narrow cone of light. The cut off angle should always be between 0° and 180° .

- The **Drop Off Rate** affects how fast a Spot Light’s intensity drops off from the center of the cone to the outside edge. Only available for Spot Lights.

A value of 0 produces a cone of light with the same intensity from the center to the outside edge. The default drop off value is 7.5, causes the light intensity to drop off fairly quickly.

Limitations in the OpenGL lighting model can create a jagged circle of light on a large flat surface if the Drop Off Rate value is too low. You can address this by decreasing the Maximum Triangle Size and increasing the Drop off Rate.

Additional **Options** that affect how the selected light source behaves are available.

- Check **On** to use the light source in camera views, or uncheck it if you prefer that the light source not be used. See “Lighting” on page 395.
- **Casts Shadows** controls whether or not the light source casts shadows in camera views. See “Shadows” on page 394. Check **Show Position in Camera View** to indicate the position of a selected Point or Spot Light source in the preview pane and in 3D views that support lighting when it is turned On. This tool can be used to determine if your light source is positioned correctly. Not available for Parallel lights. See “Displaying Lights” on page 396.

4 A preview of the selected object displays here. The selected light source's Position in Camera View will display in the Standard Rendering Technique if the light source is On. See "Dialog Preview Panes" on page 28.

Custom Light Intensity Dialog

Select "Custom" from the **Intensity** drop-down list on the LIGHT DATA panel to open the **Custom Light Intensity** dialog.

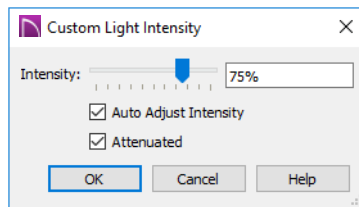

- **Intensity** - Use the slider bar or text field to control how bright the light appears in camera views.

- Check **Auto Adjust Intensity** to have the program to scale the Intensity depending on the number of lights in the room. When unchecked, the Intensity set here is used.
- Check **Attenuated** to control how quickly a light source's intensity drops as its distance from the light source grows. When unchecked, the light does not drop off. Only Spot and Point Lights have attenuation.

Materials Panel

The MATERIALS panel is found in the specification dialogs for a variety of objects. For more information, see "Materials Panel" on page 366.

Foundations

There are two foundation types in Home Designer Interiors: stem walls with footings and monolithic slab. The foundation type can be specified in the **Foundation Defaults** dialog when the foundation is built on Floor 0.



Always consult registered geotechnical and civil engineers for information regarding the proper foundation for your site.

Chapter Contents

- Foundation Defaults
- Building a Foundation
- Displaying Foundations
- Editing Foundations
- Deleting Foundations
- Foundations and Rooms
- Fireplaces
- Fireplace Specification Dialog
- Library Fireplaces
- Chimneys

Foundation Defaults



Foundation Defaults can be accessed by selecting **Edit> Default Settings**.

Select “Foundation” and click the **Edit** button to open the **Foundation Defaults** dialog.

The settings in the **Foundation Defaults** dialog are similar to those in the **Build Foundation** dialog, which opens when

Build> Floor> Build Foundation  is selected. The primary difference is that when you click **OK** in the **Foundation Defaults** dialog, no changes are made to the model. See “Building a Foundation” on page 278.

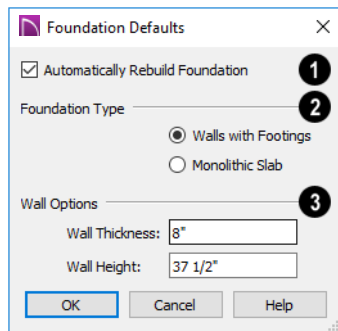

1 Check **Auto Rebuild Foundation** to automatically rebuild the foundation whenever changes are made to Floor 1 that affect the structure of the foundation. See “Rebuilding Foundations” on page 280.

2 Click the radio button beside either **Monolithic Slab** or **Walls with Footings** to specify which foundation type the program should build.

3 **Wall Options** - Specify characteristics of the foundation walls.

- **Wall Thickness** - Specify the desired thickness of the foundation walls. See “Wall Thickness” on page 147.
- **Wall Height** - Specify the desired height of the foundation walls.

If the wall height is at least 6 feet (1800 mm), a slab floor is generated above the footings and inside the foundation walls. The Wall Height includes the thickness of this slab.

If you do not want this slab, specify the “rooms” on Floor 0 as **Open Below** in the **Room Specification** dialog. See “Available Room Types” on page 166.

Building a Foundation



Two foundation types are available: stem walls with footings and monolithic slabs. The first option is created using walls; the second creates concrete slabs with footings.

Automatically built foundations are placed on Floor 0 and are based on wall positions

and floor heights on Floor 1. Foundation walls or slab footings are generated under:

- All exterior walls on Floor 1 that define a room other than a Court, Deck or Balcony room type. See “Room Definition” on page 163.

- Any interior walls on Floor 1 defining rooms with different floor heights. See “Floor and Ceiling Heights” on page 172.

At least one room must be defined on Floor 1 for a foundation to be automatically generated. If no rooms are defined on Floor 1, a blank Floor 0 is created.

To build an automatic foundation

1. Select **Build> Floor> Build Foundation** .
2. Specify the desired foundation type and other information in the **Build Foundation** dialog. The settings in this dialog are similar to those in the Foundation Defaults dialog. See “Foundation Defaults” on page 278.
3. In the **New Floor** dialog, select **Derive new foundation plan from the 1st floor plan** and click **OK** to build a foundation based on Floor 1.

If you prefer, you can instead select **Make new (blank) plan for the Foundation** to create an empty foundation level where you can manually draw foundation walls or slabs.

In most cases, it is preferable to base Floor 0 off the first floor plan and then manually edit the foundation as needed. See “Editing Foundations” on page 280.

Mixing Foundation Types

You can also create a foundation that combines stem walls and/or monolithic slabs.

To create a foundation of multiple types

1. Begin by specifying any rooms on Floor 1 that require a slab floor as either a Garage or Slab **Room Type**. See “Foundations and Rooms” on page 281.
2. **Build Foundation** , as described above.

Displaying Foundations



The display of foundation walls, slabs, curbs and footings is controlled in the **Display Options** dialog. See “Display Options Dialog” on page 88.

- Foundation Walls, including slab footings and Garage curbs, are placed on the “Walls, Foundation” layer.
- Footings under slab footings and Foundation Walls are placed on the “Footings” layer.
- Deck post footings are placed on the “Footings, Deck Post” layer.

- The “Foundations” layer controls the display of all objects on Floor 0 in 3D views but does not affect floor plan view.

In floor plan view, foundation walls are drawn with solid lines and footings, with dashed lines.

If a door on Floor 1 extends into a stem wall or curb defining a Garage room, its location will be indicated on Floor 0.

In 3D views, all objects on Floor 0 will only display when the “Foundation” layer is turned on.

While the display of foundation walls and their footings can be controlled independent of one another in floor plan view, in 3D views this is not the case. If a foundation wall is set to display, its footing will as well - even if the “Footings” layer is turned off. The reverse is also true - if a foundation wall’s display is turned off, so will its footing’s.

The display of monolithic slab foundations in 3D views is controlled by the “Foundation” layer. Slab footings are located on the “Walls, Foundation” layer; but if this layer is turned off, any slab footings that define a foundation room will continue to display as long as the “Foundation” layer is on.

Editing Foundations

Stem wall with footings and monolithic slab foundations are both created using walls which enclose room areas.

- Foundation walls can be selected and edited much like other walls. See “Editing Walls” on page 146.
- Foundation rooms can also be selected and edited like other rooms. See Foundations and Rooms.

Rebuilding Foundations

By default, foundations update automatically when changes are made to the structure on Floor 1. For example, if exterior walls are moved or floor platforms are raised or lowered, the foundation will be rebuilt.

If you prefer that the foundation not rebuild automatically, you can uncheck **Auto Rebuild Foundation** in the **Foundation Defaults** dialog. See “Foundation Defaults” on page 278.

You can also rebuild an automatically generated foundation by selecting **Build**>

Floor> **Build Foundation**  from the menu.

When **Auto Rebuild Foundation** is enabled, walls cannot be edited, manually drawn or

deleted on Floor 0. When the foundation is rebuilt, any manually drawn or edited walls are deleted. Similarly, rooms on Floor 0 cannot be edited while this option is enabled. If you try to draw a wall or edit a room or a wall while **Auto Rebuild Foundation** is turned on, a warning message will display.

Changing Foundation Types

When a foundation is generated, the program creates **Floor Defaults** settings for Floor 0 based on the information in the **Build Foundation** dialog. If you specify a Monolithic Slab foundation, the default Floor Structure on Floor 1 will also be changed to a slab rather than a framed platform. See “Floor Defaults Dialog” on page 288.

If you rebuild the foundation using a different Foundation Type, it is advisable to check the floor heights of all rooms on Floor 1 - particularly Garage and Slab rooms, as well as any rooms that do not use the default floor height of 0”.



To avoid unexpected results, it is recommended that you not change the Foundation Type once the foundation is built.

Stem Wall Height

When a foundation is created, all of Floor 0 uses the stem wall height specified in the **Foundation Defaults** dialog,

This height is measured from the bottom of floor platform of Floor 1 to top of the stem walls' footings. If Floor 1 has multiple floor platform heights, the foundation stem walls will be stepped.

Once a foundation is created, stem wall heights can be adjusted either on a room-by-room basis or for individual walls.

To change a room's stem wall height

1. Select a room on Floor 0 and click the **Open Object**  edit button.
2. Specify the desired **Stem Wall Height** in the **Room Specification** dialog. See "General Panel" on page 176.
3. If you wish to reduce the **Stem Wall Height**, you will first need to reduce the **Ceiling Height** value by the same amount.

If adjacent rooms have stem wall heights that differ by at least 1/16 of an inch, the stem wall separating them uses the larger of these two values.

Deleting Foundations



Select **Build> Floor> Delete Foundation** to delete the entire foundation floor.

You can also select and delete individual foundation walls and slabs by clicking the

Delete  edit button or pressing the Delete key. See "Deleting Objects" on page 117.

Deleting and rebuilding the foundation is often the quickest way to update the model when substantial changes are made to Floor 1 after the foundation is built.

Foundations and Rooms

When a foundation plan is created, rooms included in the Living Area calculation generate a stem wall or slab foundation below them. Garage rooms generate slab foundations, but exterior rooms such as Decks, Courts and Balconies do not generate any foundation. See "Room Types" on page 165.

Interior foundation walls are not generated unless:

- They separate the area under a Slab or Garage room from the rest of the plan;
- They define areas under rooms with different floor heights.

Note: To remove all or part of the concrete slab in the basement area, select a basement room and define it as Open Below in the Room Specification dialog.

Garages

When a foundation is generated based on the floor plan of Floor 1, a room on the first floor specified as either a Garage or Slab type will receive a foundation with a slab floor and stem walls. If a monolithic slab foundation is generated, the room will receive a slab floor with curbs.

By default, a room on Floor 1 specified as a Garage or a Slab will be assigned a lower floor height when the foundation is built. The amount that it is lowered depends on the foundation type:

- The floor height will drop the default thickness of the floor platform for Floor 1 plus 12” (300 mm) - a total of 24 5/8” (618 mm) - in a Walls with Footings foundation.
- The floor height will drop 3 1/2” (88 mm) in a Monolithic Slab foundation.

To build a Garage slab with stem walls

1. Before the foundation is generated, specify the room as a Garage or Slab.
2. Build a Wall with Footings foundation.

To build a Garage slab with curbs

1. Before the foundation is generated, specify the room as a Garage or Slab.

2. Build a Monolithic Slab foundation, specifying the required Lower Garage Floor value.

Basement Rooms

When a foundation’s type is Walls with Footings and it is assigned a Minimum Wall Height of 76” (1900 mm) or greater, the resulting basement is automatically created with a 4” (100 mm) concrete slab floor. and a default Floor Finish like that on Floor 1.

Similarly, if a foundation is set up to have a Basement Ceiling Height of 72” (1800 mm) or greater when built, it is automatically given a painted drywall Ceiling Finish.

Regardless of its ceiling height, however, you can specify a ceiling finish for any room in the **Room Specification** dialog. See “Structure Panel” on page 177.

The resulting basement can be divided into separate rooms using **Interior Walls**  or any wall type you wish.

Stepped Foundations

A stepped foundation will be produced automatically if more than one floor height is present on Floor 1 when the foundation is built.

You can also create a stepped foundation by editing foundation rooms. See “Stem Wall Height” on page 281.

Fireplaces



A masonry fireplace can be placed in or away from a wall by selecting

Build> Fireplace and then clicking in the drawing area.

- If created in a wall, it is considered a wall opening and can be moved or resized like a window or door.
- If created away from a wall, it moves and resizes similar to a cabinet.

A selection of prefabricated metal fireplaces is also available from the Architectural Core Catalog. These can be framed in with standard walls. See “The Library” on page 329.

The display of fireplaces is controlled in the **Display Options** dialog. See “Display Options Dialog” on page 88.

Fireplaces are edited, moved, resized, and deleted similar other objects. See “Editing Objects” on page 91.

Built into a Wall

To place a masonry fireplace in a wall, select **Build> Fireplace**  and click on a wall. A fireplace is created with the outside of the fireplace flush with the outside of the wall.

Fireplaces cannot be placed in a wall specified as Invisible. See “Room Dividers and Invisible Walls” on page 137.

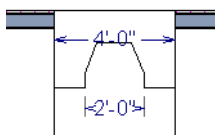

Select the fireplace to display four edit handles located along the wall.

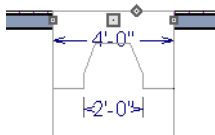

Click the diamond-shaped Depth handle and drag toward the outside of the wall. The fireplace will stop when the firebox front is flush with the inside edge of the wall.

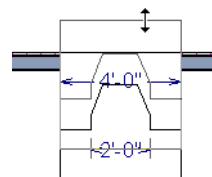

In 3D views, fireplaces placed in walls display five edit handles: a Resize handle along each edge and a Move handle at the center.

Fireplaces always face the interior when placed on an exterior wall. When placing a fireplace in an interior wall, click on the edge of the wall that you want the fireplace to face. The fireplace is created with the firebox on the same side as the wall edge you clicked on to create it.

Freestanding

To place a free-standing masonry fireplace, select **Build> Fireplace**  and click in an open area away from a wall.

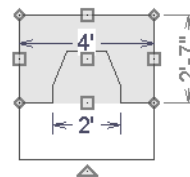

Unlike fireplaces placed in walls, free-standing fireplace have ten edit handles when selected and may be rotated, resized, or moved in any direction, similar to the way CAD boxes can. See “Editing Box-Based Objects” on page 104.

Free-standing fireplaces can be selected and replaced with a symbol from the library by clicking the **Replace From Library**  edit button. See “Replace From Library” on page 344.

Fireplace Foundations

When a Walls with Footings foundation is built, a fireplace foundation will be

generated under any **Fireplaces**  present on Floor 1. See “Building a Foundation” on page 278.

Fireplace foundations are the same material type as the original fireplace, but do not have a firebox or a hearth. Fireplace foundations can be edited or deleted as needed. A firebox and hearth can be added in the **Fireplace Specification** dialog.

Fireplace Specification Dialog



Select a masonry fireplace and click the **Open Object** edit button to display the **Fireplace Specification** dialog.

Dimensions in this dialog here must be entered in whole inches. Fractions and decimals are not accepted.

General Panel

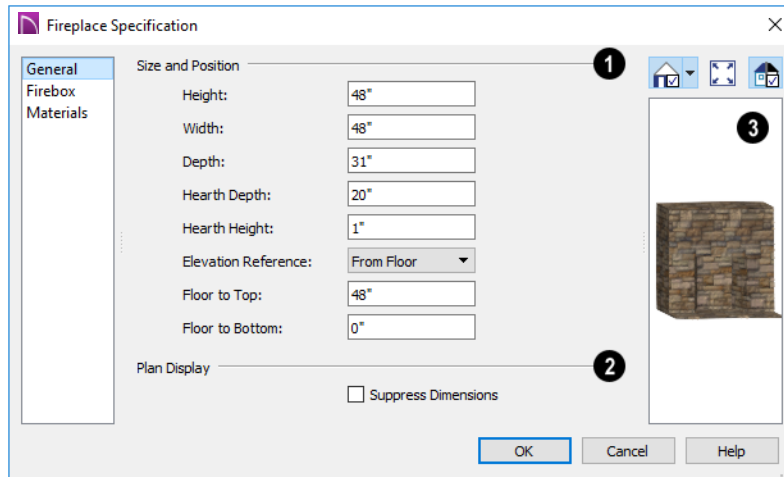

- 1 Specify the **Size and Position** of the selected fireplace and its hearth.
- Specify the **Height, Width, and Depth** of the fireplace.
- Specify the **Hearth Depth**. This is measured from the front of the fireplace out

- into the room. To eliminate the hearth altogether, enter a zero for this value.
- Specify the **Hearth Height**, relative to the floor in the room that the fireplace faces.

- Select the **Elevation Reference** from the drop-down list. This determines where the next two settings are measured from and also affects their setting labels.
- Specify the height **to Top**, measured from the selected Elevation Reference.
- Specify the height **to Bottom**, measured from the selected Elevation Reference.

- ② **Plan Display** - Check **Suppress Dimensions** to turn off the display of the selected fireplace's width and firebox width dimensions in floor plan view.

The preview of the fireplace updates as changes are made. See “Dialog Preview Panes” on page 28.

Firebox Panel

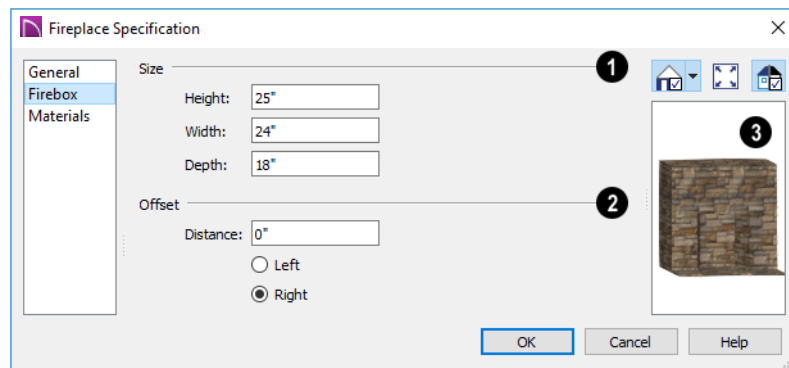

- ① Define the **Size** of the selected fireplace's firebox.
- Specify the firebox's **Height** and **Width**.
- Specify the **Depth** of the firebox.
- ② Define the firebox **Offset**, measured from the center of the fireplace.
- Enter the offset **Distance**, which is how far the firebox is offset from the fireplace center. A value of 0 centers the firebox in the fireplace.

- **Offset to Left/Right** - Choose to offset the firebox to the left or to the right.

The preview of the fireplace updates as changes are made. See “Dialog Preview Panes” on page 28.

Materials Panel

For information about the settings on this panel, see “Materials Panel” on page 366.

Library Fireplaces

A variety of fireplace symbols are available in the library. Flush fireplaces are designed to snap to wall surfaces. Some fireplace

symbols can be enclosed by walls or positioned to project through a wall. See “Placing Library Objects” on page 342.

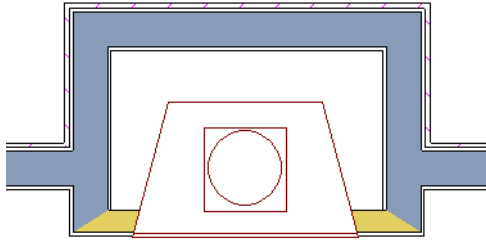

Open Front fireplace projecting through a wall

 Always check the manufacturer's product information for the framing and clearance requirements of the fireplace unit you plan to use, and design your plan accordingly

Chimneys

Chimneys can be created using a variety of methods.

Masonry Fireplace Chimneys

To create a chimney on a masonry fireplace

1. Select the fireplace in a 3D view.
2. Ctrl + drag the top edge of the chimney upward through all the floors and the roof until it is to the desired height. See “Unrestricted Movement” on page 111.
3. When the chimney is approximately the correct height, select the fireplace, click the **Open Object**  edit button, and type in the exact height.

Chimney Chases and Caps

There are two ways to draw a chimney chase:

- Place a closed box Geometric Shape or Soffit over the chimney chase, resize it to match, then increase its height either in its specification dialog or in a 3D view using the same method as extending a masonry fireplace.
- Use walls to define the chimney chase as a room area, making sure these walls are aligned between floors. The chimney chase “room” on the uppermost floor should have a much higher ceiling than the other rooms on that floor and should also have no ceiling or roof. See “Room Specification Dialog” on page 176.

A selection of chimney tops is available in the library. In addition, custom chimney caps can be made using Geometric Shapes and/or Soffits. See “Other Objects” on page 355.

Multiple Floors

When a new plan file is opened in Home Designer Interiors, two floor levels are present: Floor 1 and the Attic Floor. You can add more floors whenever you like: up to 3 total. Once created, floors can also be copied and deleted.

Home Designer Interiors also supports special floors for foundations and attics. Only one foundation level and one attic can exist in a plan. Foundations are discussed in their own chapter. See “Foundations” on page 277.

Chapter Contents

- Floor Defaults Dialog
- Floor Tools
- Adding Floors
- Displaying Floors
- Exchanging Floors
- Deleting Floors
- Split Levels
- The Current Floor
- The Attic Floor
- The Reference Floor

Floor Defaults Dialog



There is a **Floor Defaults** dialog for each floor in a plan file. The defaults for the current floor can be accessed by selecting **Edit> Default Settings**. Click the arrow to the left of “Floors and Rooms” to expand the category, then select “Current Floor” and click the **Edit** button to open the **Floor Defaults** dialog for the currently active floor. See “Default Settings vs Preferences” on page 54.

The **Floor Defaults** dialog also opens whenever you add a new floor to the plan. See “Adding Floors” on page 289.

The **Floor Defaults** dialog does not open when you build a foundation; however, the **Floor 0 Default** settings are created based on the current Foundation Defaults. See “Building a Foundation” on page 278.

The **Floor Defaults** dialog is similar to the **Room Specification** dialog, but controls the default settings for all rooms on the current floor. The settings here also control the height of individual walls as they are drawn on the floor in question. See “Room Specification Dialog” on page 176.

Note: The default floor height for Floor 1 is 0. It can be modified in the Room Specification dialog, but not in the Floor 1 Defaults dialog. See “Floor and Room Defaults” on page 165.

Structure Panel

The settings on the STRUCTURE panel are similar to those in the **Room Specification** dialog. See “Structure Panel” on page 177.

Moldings Panel

The settings on the MOLDINGS panel are similar to those in the **Room Specification** dialog. See “Moldings Panel” on page 180.

Fill Style Panel

The settings on the FILL STYLE panel are similar to those in the specification dialogs for many objects throughout the program. See “Fill Style Panel” on page 129.

Materials Panel

The settings on the MATERIALS panel are similar to those in the specification dialogs for many objects throughout the program. See “Materials Panel” on page 366.

Floor Tools



Select **Build> Floor** to access the floor tools.



Select **Build> Floor> Build New Floor** to build a new floor. A new floor can be generated based upon the

perimeter of the floor below or a blank floor can be created and drawn from scratch. See “Adding Floors” on page 289.



Choose **Build> Floor> Delete Current Floor** to remove the current

floor from the plan. For more information, see “Deleting Floors” on page 291.



Choose **Build> Floor> Build Foundation** to open the **Foundation**

Defaults dialog and build a foundation floor. See “Building a Foundation” on page 278.



Select **Build> Floor> Delete Foundation** to remove the foundation from the plan. See “Deleting Foundations” on page 281.

Adding Floors

When a new plan file is opened in Home Designer Interiors, two floor levels are present: Floor 1 and the Attic Floor. You can add up to 3 total living floors, as well as create a foundation below Floor 1.

Floors can be added whenever you like; and once created, they can also be copied and deleted.

Note: Home Designer Interiors allows only one floor, the foundation/basement, below the first floor. Keep this in mind when you begin an as-built or plan for a multi-story building. See “Foundations” on page 277.

Build New Floor



New floors can be created in floor plan view as well as in 3D views, and are always added above the top living floor. To create a new floor, select **Build> Floor> Build New Floor**.

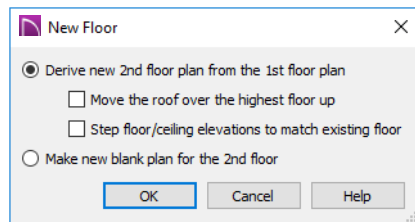

- **Derive new 2nd floor plan from the 1st floor plan** creates a new top floor with exterior walls generated directly over the exterior walls of the floor below. Wall types and roof directives associated with the walls on the floor below are duplicated; however, interior walls are not. See “Roof Panel” on page 154.
- Check **Move Highest Floor’s Roof Up** to move any roof planes displaying on the highest floor in the plan up one floor when the new floor is created. Roof planes displaying on floors other than the top floor are unaffected. This option is only available if there are roof planes built on the top floor and is not available when **Auto Rebuild Roofs** is enabled. See “Build Roof Dialog” on page 323.
- Check **Step floor/ceiling elevations to match existing floor** to maintain all ceiling heights on the existing floor by stepping floor heights on the new floor to match. Ceiling heights on the new floor also become stepped accordingly. See “Stepped Floor and Ceiling Platforms” on page 173.
- **Make new (blank) plan for the 2nd floor** creates a new top floor that is blank. This option is typically selected only if none of the exterior walls on the new

floor will be directly above the exterior walls on the floor below. If you choose this method, it may be helpful to turn on the Reference Floor when drawing walls on the new floor. See “The Reference Floor” on page 293.

When you click OK, the **Room Defaults** dialog for the newly created floor opens. Make any necessary changes to the floor structure, moldings, or materials and click OK. See “Floor Defaults Dialog” on page 288.

The new floor becomes the current floor in floor plan view. If, however, the new floor is created in a 3D view, the camera remains on its original floor and does not move.

Adding a Foundation

To add a foundation, select **Build> Floor>**

Build Foundation . See “Building a Foundation” on page 278.

Displaying Floors

Home Designer Interiors allows you to view the floors in your plan in a variety of ways.



In Floor Plan View

In floor plan view, only one floor can be active for editing at a time. This is referred to as the Current Floor. See “The Current Floor” on page 292.

In addition to the Current Floor, one other floor can be displayed for reference purposes: the Reference Floor. Objects on the Current Floor can snap to those on the Reference Floor, helping you align objects. See “The Reference Floor” on page 293.

In 3D Views

In most 3D views, all floors in a plan are visible, from the foundation up to the attic. There are two exceptions:

- **Floor Camera**  views, which show the Current Floor only.
- **Doll House Views** , which show the Current Floor, not including its ceiling, plus any floors beneath it.

See “3D View Tools” on page 377.

Exchanging Floors



Select **Build> Floor> Exchange With Floor Above** or **Exchange With Floor Below** to swap the current floor with the floor above or below.

The floor that was moved becomes the current floor at its new location. You can easily move a floor up or down several floors by using either one of these buttons repeatedly.

Deleting Floors



Select **Build> Floor> Delete Current Floor** to remove the current floor from the plan. If there is a floor above, it becomes the current floor; if there is no floor below, the floor beneath becomes the current floor.



To delete Floor 0, select **Build> Floor> Delete Foundation**. You can

delete the foundation without actually being on Floor 0. Floor 0 cannot be deleted while **Auto Rebuild Foundation** is turned on. See “Deleting Foundations” on page 281.



When a floor is deleted, all objects on that floor are deleted with it.

Split Levels

Both split level floor plans and split level entries can be created by controlling the floor and ceiling heights of individual rooms in a multiple story structure.

Split Level Floor Plans

A split level, or tri-level, structure is a building where the floor level in one part of the plan is located approximately half way between the floor and ceiling levels of another part of the plan.



Split Level Home

To create a simple split level plan

1. Draw a simple rectangular structure divided into two separate halves by an interior wall.
2. Select one of the rooms and click the **Open Object**  edit button. See “Room Specification Dialog” on page 176.
3. Raise the **Floor Height** then press the Tab key.
4. Restore the **Relative Rough Ceiling** to the default value, then click OK.
5. Build a stem wall foundation. See “Foundations” on page 277.
 - The foundation under the room with the lower floor height will have the specified Min Stem Wall Height.
 - The foundation under the room with the raised floor will have taller stem walls.
 - Both can be edited in the **Room Specification** dialog.
6. If you add a Floor 2, note that the **Ceiling Height** in the room on Floor 1 will be reset to the default value.
 - To maintain a stepped condition on multiple floors, return to this room and

set the **Relative Rough Ceiling** back to using the default.



Split Level Entries

A split level entry, or divided entry, is characterized by an entry door that opens onto a landing positioned half way between the basement floor and first floor levels.



Split Level Entry

To create a simple split level entry

1. Create a plan file with a full basement at the location of the entry door. See “Basement Rooms” on page 282.
2. Go to Floor 0 and draw a stair
Landing  at the location of the entry. See “Landings” on page 303.
3. Draw stairs upward from the basement floor to the landing.
 - The number of treads and risers in the stair section will determine the landing height.
4. Draw a second stair section from the landing upward.
5. Select the stairs and click the **Auto Stairwell**  edit button. See “Creating a Stairwell” on page 308.

For more detailed instructions, visit www.HomeDesignerSoftware.com.

The Current Floor

Only one floor can be active at any given time. The active floor is referred to as the **Current Floor**, and it is the only floor on which objects can be edited.

If you want to edit two different floors at the same time, you can open the plan again. This opens a second window on the current open plan that has the same editing abilities as the first. Only one of these windows can be active at any given time.

Floor Up / Floor Down



If you are working with more than one floor, you

can select **Tools> Reference Floors> Up One Floor** or **Down One Floor** to switch from one floor to another.

You can change the current floor in floor plan and 3D views. The current floor displays on the **Change Floor/Reference**  button, which can be found between the **Down One Floor** and the **Up One Floor** buttons.

Floors become available once they have been built. The Attic and foundation levels are also accessible using these tools.

Change Floor / Reference



If there are multiple floors, select **Tools> Reference Floors> Change Floor/Reference** to open the **Change Floor/**

Reference dialog, where you can select both the current floor and which floor is used in the Reference Floor, as well as control the appearance of the Reference Floor.

The Attic Floor



Home Designer Interiors automatically creates a floor above the top numbered floor level of each plan. This floor is called the Attic floor and has only one purpose: to provide a space for automatically generated Attic walls. See “Attic Walls” on page 151.

Because the Attic floor is not meant to be a living area, a warning message will display if

you try to draw walls or other objects on this floor.

In some situations, you may find it necessary to draw one or more walls on this floor; however, even if you enclose an area with walls, rooms cannot be created on the Attic floor.

If you wish to create an attic loft, bonus room, or storage area in your plan, you will need do so on a numbered floor level.

The Reference Floor

When there is more than one floor in a model, it is often helpful to see how they relate to each other. Any floor can be shown as the **Reference Floor** along with the current floor.

When the Reference Floor Display is turned on, the floor that you were last on prior to the current floor is used as the Reference Floor and is shown in red. Objects on the Reference Floor cannot be selected or edited.

Reference Floor Display



To turn on the Reference Floor, select **Tools> Reference Floors> Reference Floor Display** or press F9 on your keyboard.

If the Reference Floor is turned on when a view is printed, it will be included in the

printed output. See “Displaying Objects” on page 435.

Note: If objects on the current floor and the Reference Floor have edges that line up, the Reference Floor may be difficult to see on screen. When lines of two different colors are superimposed upon each other, discoloration may result.

Reference Floor Display Options



The display of objects in the Reference Floor is controlled by selecting **Tools> Reference Floors> Reference Floor Display Options**. See “Display Options Dialog” on page 88.

Change Floor / Reference Dialog



By default, the floor below the current floor is the Reference Floor, but any floor can be referenced using the **Change**

Floor/Reference dialog. To open the dialog, select **Tools> Reference Floors> Change Floor/Reference** button.

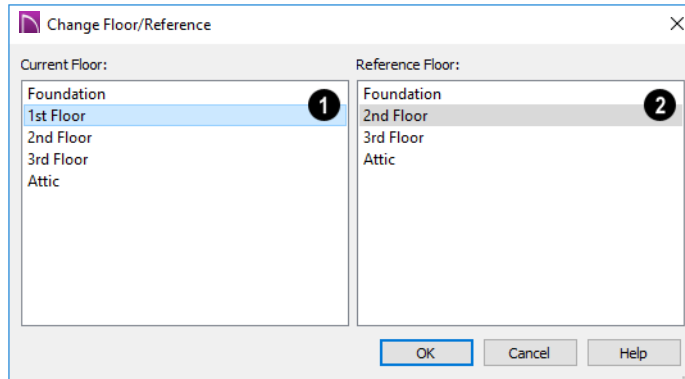

1 The **Current Floor** is highlighted here. You can select another floor to make it the current floor.

2 The **Reference Floor** currently used for reference is highlighted here. You can select another floor to display it instead.

Swap Floor/Reference



If one floor is defined as the current floor and another floor is defined as the reference floor, select **Tools> Reference Floors> Swap Floor/Reference** to switch the status of the two floors.

Stairs and Landings

Staircases can be composed of one or more straight or curved stair sections and landings. Stairs can be drawn, selected and edited in 2D and 3D views.

Stairwells can be created automatically or manually and can be seen in 3D views.

 Local building and fire authorities must be consulted for specific stair construction codes and access requirements.

Chapter Contents

- Stair Defaults
- The Stair Tools
- Anatomy of a Staircase
- Drawing Stairs
- L- and U-Shaped Stairs
- Displaying Stairs and Landings
- Editing Stairs
- Merging Stair Sections
- Landings
- Maintaining Tread Depth
- Starter Treads
- Wrapped Stairs
- Other Special Railings and Stairs
- Creating a Stairwell
- Rooms Below Staircases
- Staircase Specification Dialog
- Stair Landing Specification Dialog

Stair Defaults

The purpose of interior stairs is to provide passage from one floor platform to another, so the attributes that influence floor heights - including ceiling heights - also influence the structure of stairs. When considering a staircase's structure, bear in mind that riser height is directly dependent on the distance from one floor platform to another.

The Stair Tools



Select **Build> Stairs** to access the Stair Tools.

Draw Stairs



To draw a straight staircase select **Build> Stairs> Draw Stairs**, then click and drag in floor plan or a 3D view. You can also click once to place a staircase that extends from the current floor up to the next floor. See “Drawing Stairs” on page 298.

Straight Stairs



Select **Build> Stairs> Straight Stairs**, then click to create stairs between the current floor and the floor above. To create stairs between two floor platforms on the current floor, click on the low side, within a few feet of where the floor changes height.

- If you click on the low side of a floor platform defined by a railing, a doorway will be created in the railing, adjacent to the stairs.
- If you click on the low side of a floor platform defined by a wall, stairs will be created but a doorway will not.
- If you click at a location that is not near the edge of a floor platform, a full height staircase will be created.

Curved Stairs



Select **Build> Stairs> Curve to Left** or **Curve to Right** and click once in floor plan view to place a curved staircase. See “Curved Stairs” on page 298.

L-Shaped Stairs



Select **Build> Stairs> L-Shaped Stairs**, then click to create two equal stair sections that form a 90° corner and are connected by a landing. See “L- and U-Shaped Stairs” on page 299.

U-Shaped Stairs



Select **Build> Stairs> U-Shaped Stairs**, then click to create two stair sections that form a 180° turn and are connected by a landing.

Landing



Select **Build> Stairs> Landing** to draw a landing, which is a platform connecting two or more stair sections. See “Landings” on page 303.

There are two ways to create a landing using this tool:

- Click once to place a landing measuring 39” (975 mm) on each side.
- Click and drag to draw a rectangular landing sized as needed.

Anatomy of a Staircase

Stairs are often described in terms of **rise** and **run**. Rise is typically between 6" and 8", and the run between 10" and 12". In metric plans, rise is 177 to 190 mm, and the run is about 250 mm.

Staircase Terminology

Balusters - The vertical members that run between the handrail and the treads or bottom rail.

Bracket - Decorative L-shaped supports on the exposed side of stairs below each tread.

Landing - A platform connecting two or more stair sections.

Newels - The end post of a stair railing located at landings and the beginnings and endings of new stair sections.

Rise - The height of a riser, measured from tread surface to tread surface, Also referred to as Unit Rise.

Rise Angle - The angle of the staircase or stair section, defined by a line drawn through the back surfaces of its treads.

Riser - The vertical stair member located between the treads. Risers may be solid or open. When open, the front surfaces of the stringers are considered the risers.

Run - The depth of a tread, measured from riser surface to riser surface. Run does not include the Tread Overhang. Also referred to as Unit Run.

Runner - The carpet that runs down the center of the staircase.

Shoe - The bottom railing, placed on the landing floor, that anchors the balusters at landings.

Stringer - The inclined support member of a staircase that supports the treads and risers.

Tread - The horizontal member of a stair that the foot is placed on.

Tread Overhang - The portion of a tread extending past the front surface of the riser and over the tread below. Also referred to as Nosing or Nosing Extension, it is not included in the Run or Tread Depth measurements.

Tread Thickness - The vertical depth of the tread material.

Stair Structure and the Model

Stairs locate the height of the floor platform that they are drawn on and seek the next level, which may be the floor platform of the floor above or a landing. The stringers locate the subfloor of the floor platforms and maintain consistent riser height. If the stairs are long enough to reach the next level at a reasonable rise angle, their tread depth and number of treads are automatically calculated to create a staircase with consistent tread and riser dimensions along its entire length.

Stair Sections and Subsections

In Home Designer Interiors, staircases can be composed of multiple sections and subsections. See "Merging Stair Sections" on page 301.

- Stair sections are separated by landings.
- Subsections are considered part of the same section because they are connected

to one another directly rather than separated by a landing.

Drawing Stairs

Stairs can be drawn in floor plan and 3D views. In 3D views, these objects can only be drawn in the presence of a floor platform. See “Working in 3D” on page 388.

There are a few things to keep in mind when drawing stairs:

- Before stairs are created, make sure that the heights for both the lower and upper floors are correctly defined.
- Stairs are drawn going **UP**, so they should be drawn from the lower of the two floors they connect.
- By default, stairs adjust their riser and tread dimensions to connect two floor heights if possible. The rise and run are calculated so that the steps are consistent in size.
- Stairs drawn within 1” (25 mm) of a wall will snap to the outer surface of the wall.
- Stairs will snap to the **Reference Display** , if you have it turned on.
- Hold down the Ctrl key to suppress these snapping behaviors.
- If a stairwell room has been defined on the floor above, the top of the stairs can be dragged until it stops at the railing or wall defining the stairwell.

Straight Stairs

The **Draw Stairs**  tool can be used in two different ways:

- Click and drag in a straight line to draw stairs that are the length that you drag.
- Click once to place stairs that go from the current floor up to the height of the next floor level.

You can also click once using the **Straight Stairs**  tool to create stairs between rooms on the same floor with different floor heights. When the Straight Stairs tool is active, a preview outline of the stairs will follow the mouse pointer. Hold down the Alt key to reverse the direction of the Up arrow in the preview.

An individual stair section must be between 6” (150 mm) and 100’ (30 m) in length. If a greater length is needed, connect two sections using a landing.

Curved Stairs

- You can make a straight stair section curved, or vice versa by selecting the stairs and clicking the **Change Line/Arc**  edit button. See “Change Line/Arc” on page 115.

You can also curve straight stairs by drawing them against a curved wall.

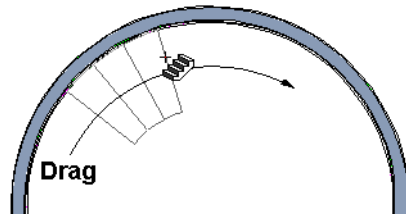

Straight stairs drawn along a curved wall



Curved Stairs can also be created in floor plan view by selecting **Build > Stairs > Curve to Left** or

Curve to Right. Click to place a 90° curved stair section that can then be edited. You can continue clicking to place additional curved staircases until another tool is selected.

L- and U-Shaped Stairs



The **L-Shaped Stairs** and **U-Shaped Stairs** tools allow you to place staircases composed of two stair sections connected by a landing with a single click.

The staircases created with these tools build from the current floor to the floor above. If you need a staircase that builds between platforms on the same floor level, or in a downward direction, you will need to draw it manually. See “Landings” on page 303.

When you select either tool, the **New Shaped Staircase** dialog opens.

New Shaped Staircase Dialog

The settings in this dialog retained between sessions in the software and are global, affecting all plans.

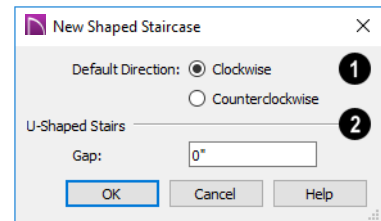

- 1 Specify the **Default Direction** of the stairs as they build upward: **Clockwise**, or **Counterclockwise**.
- 2 **U Shaped Stairs** - Specify the width of the **Gap** between the two stair sections.

When you click OK, a preview outline will follow the mouse pointer.

You can control the staircase’s orientation and direction by moving the mouse pointer towards a wall.

- In the case of a **U-Shaped**  staircase, the landing will snap to the wall first.
- As you move the mouse pointer closer to the wall, the preview will rotate so that the upper stair section snaps to the wall.

- If you continue to move the mouse closer, the lower stair section will snap to the wall instead.
- If you move the mouse pointer into a wall corner, the preview will rotate so that the bottom stair section snaps to the wall that is nearest to the mouse pointer.
- When a **U-Shaped**  staircase preview is in a wall corner, move the mouse pointer within the landing area to control which wall the back of the landing snaps to. With the landing in place, move the mouse pointer over the two stair sections to control which is the bottom section.
- Press the Alt key to reverse these snapping behaviors and the stairs' direction.
- Hold down the Ctrl key to prevent the stairs from rotating or snapping to walls.

Displaying Stairs and Landings



The display of stairs and landings in all views is controlled in the **Display Options** dialog. Stairs and landings are placed on the “Stairs & Ramps” layer. See “Displaying Objects” on page 87.

In Floor Plan View

In floor plan view, stairs and landings display on the floor they were drawn on and are only visible from the floor above if there is a stairwell. See “Creating a Stairwell” on page 308.

Stairs have an arrow indicating the direction they run. Interior stairs have an **UP** arrow on the floor they were created on and a **DN** arrow when viewed from the floor above. See “Drawing Stairs” on page 298.

When a staircase is selected in floor plan view, the numbers associated with each of its sections and subsections display. Stair

sections are assigned a single number, while subsection numbers have two parts: a section number and subsection number separated by a hyphen.

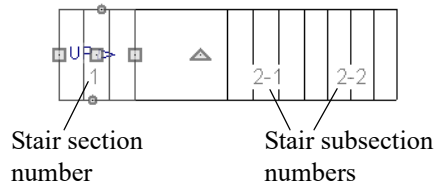

In 3D Views

Although stairs span between two floors, they can only belong to one floor. As a result, only multi-floor views show the upper floor with the platform opening and the lower floor with the staircase simultaneously. In **Floor Cameras** and Doll House Views, stairwells may appear as an empty spaces. See “3D View Tools” on page 377.

Editing Stairs

Staircases can be selected and edited in floor plan view and 3D views. See “Selecting

Objects” on page 92.

Using the Mouse

When a staircase is selected, its edit handles display. These edit handles can be used to customize the object in many ways. See “Editing Objects” on page 91.

- Straight stair sections are edited like lines. They have additional edit handles for resizing the width of the section. See “Editing Line Based Objects” on page 94.
- Curved stair sections are edited like arcs and also include edit handles for resizing the stair’s width. See “Editing Arc Based Objects” on page 96.
- When stair sections are merged, the edit handles display differently depending on what subsection is currently selected. See “Merging Stair Sections” on page 301.

- When moving merged stair sections, all merged sections move as one.
- Additional edit handles display on the first two treads of a staircase if the **Starter Tread**  edit button is clicked. See “Starter Treads” on page 306.

In the Specification Dialog

 Stairs can be customized in the **Staircase Specification** dialog. See “Staircase Specification Dialog” on page 311.

Using the Edit Tools

A selected staircase can be edited in a variety of ways using the buttons on the edit toolbar. See “The Edit Toolbar” on page 24.

Merging Stair Sections

Any combination of straight and curved stair sections using **Automatic Heights** can be merged. The resulting staircase section is made up of subsections and, if there are no landings, functions as a single unit.

Stair subsections must be drawn in the same direction if they are to be merged:

- The top edge of a stair section cannot merge with the bottom edge of another section.
- Combinations of stairs drawn in the **UP** and **DOWN** directions cannot be merged.

Stair subsections merge at the center points of their upper and lower edges.

4. Click the Extend handle on the end to be merged and drag it to the point where the

To merge stair sections

1. Confirm that the stairs that you wish to merge are using **Automatic Heights**. See “General Panel” on page 311.
2. Position the sections so they are in the desired relationship to each other.
 - In order to merge stair sections correctly, they must be parallel to one another.
 - To create merged subsections that change direction, make one of the merged sections curved.
3. Select either stair section so that its edit handles display.

two stairs are to meet.

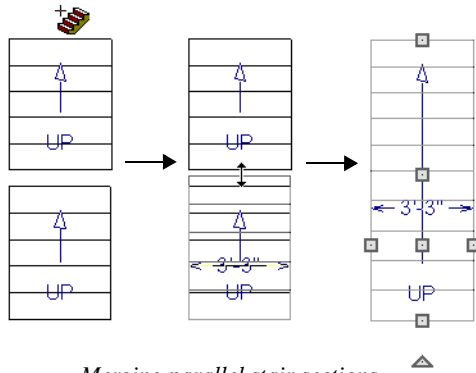

Merging parallel stair sections

A staircase consisting of merged subsections resembles a single stair section in floor plan view. The UP (or DN) arrows join, becoming a single direction arrow.

When a subsection is selected, the entire staircase is selected. Additional edit handles, indicating the presence of multiple subsections and allowing you to reposition the line along which they join. See “Using the Mouse” on page 301.

Curved Subsections

Stair subsections attached at both ends by other sections do not have a free end that can be dragged into a curve. In this situation, change the middle sub-section to a curve using the **Change Line/Arc**  edit button. See “Change Line/Arc” on page 115.

To curve an enclosed stair subsection

1. Draw three straight stair sections and connect them end to end.

2. Select the middle subsection.

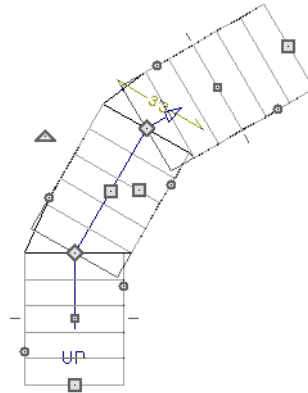

The middle stair subsection is selected

3. Click the **Change Line/Arc**  edit button. The center section turns into a curved stair section.

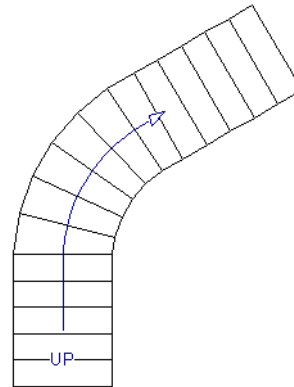





After using Change Line/Arc

4. Use the triangular Change Curve edit handle to adjust the curvature of the middle section as needed.

Landings

Stair landings are platforms between stair sections and can be created in either of three ways:

- Using the **Landing**  tool.
- By clicking between two stair sections using the **Draw Stairs**  tool.
- A landing is also created when the **L-Shaped Stairs**  or **U-Shaped Stairs**  tool is used.

To create a landing between stair sections:

1. Draw two stair sections going UP. They can be at any angle.
2. Click between the two sections using the **Draw Stairs**  tool to create a landing. Notice that only one direction arrow displays after the sections are joined by a landing.

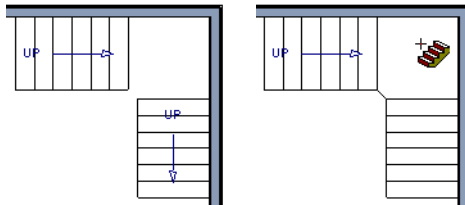

Creating a stair landing

Multiple stair sections can be connected to one landing. For example, two or three stair sections might meet at a landing with a single stair section continuing to the next level.

To be linked by a landing, all sections must be drawn in the same **UP** direction and the

top of one section should be near the bottom of the next.

Stair sections connected with a landing will move together as a single unit.

A landing formed between two stair sections having less than a 90° angle between them are created with a short edge not less than 6” (150 mm). This is because most building codes require the shortest tread to be at least 6” wide. This edge can be manually edited to less than 6” if needed.

Editing Landings

Landings can be selected in 2D and 3D views, both individually and in groups, and edited using the edit handles, the edit toolbar, and the **Landing Specification** dialog. See “Stair Landing Specification Dialog” on page 317.

Landings derive their initial materials and railing characteristics from the stairs attached to them. You can assign a unique railing or material to a landing in its specification dialog.

By default, landings have railings on all edges. You can suppress the railing on a selected edge by clicking the **Remove**

Railing from Selected Edge  edit button. To restore a selected railing, click the **Add**

Railing to Selected Edge  edit button. See “Selected Edge” on page 92.

Custom Shaped Landings

Landings can be edited like other closed polyline-based objects. You can add or

remove edges, convert an edge from straight to curved, or vice versa. A curved landing creates curved railings. See “Editing Closed-Polyline Based Objects” on page 101.

You can edit the shape of a landing into a wide variety of shapes. So that the railings of stair sections connect properly to the landing railings, make sure that each stair section end is snapped to a landing edge with the same length as the stair’s width. If necessary, use the **Break Line**  tool to create a break in a landing edge if it is longer than the connecting stairs are wide. See “Break Line” on page 114.

Landing Height

A landing’s height is controlled by the program and will adjust automatically as the stairs attached to it are modified so that the stairs maintain a consistent rise angle.

Unlocked Landings

By default, new landings are unlocked, which means that their height is determined by the stair or ramp sections attached to it. An unlocked landing will automatically adjust its height as necessary to maintain the same riser height and rise angle for all attached sections.

In this example, two stair sections with eight treads each are connected by a landing.

Because the sections have the same number of treads, the landing height is one half of the distance between the two connected floors.

Unlocked landings maintain consistent riser height

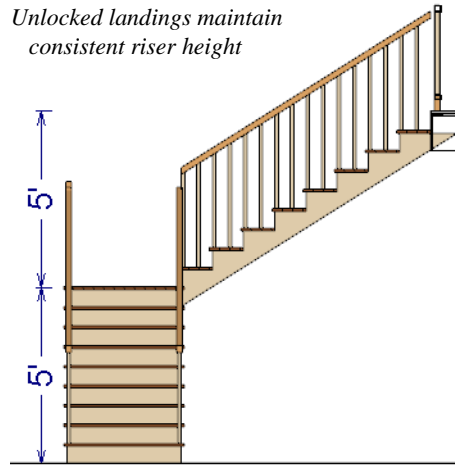

If a change is made to either stair section, the program will maintain the stairs’ connection to the floors above and below, and will instead modify the height of the landing and the other stair section so that a consistent riser height is maintained.

As long as a stair or ramp system consists of a landing connecting only two stair sections, the program can easily set landing heights and produce consistent a rise angle. If more than two stair sections meet at a landing, the relationship between them becomes more complex. In this situation, you may want to define the exact height of the landing instead of letting the program define it for you.

Locked Landings

A locked landing has a specifically defined height that does not adjust automatically when there are changes in the attached stairs. Instead, the stairs adjust to the landing.

For example, start with the same staircase used to illustrate unlocked landings, with one

change: the landing height is now defined at 78 inches (1980 mm).

Locked landings produce independent stair sections

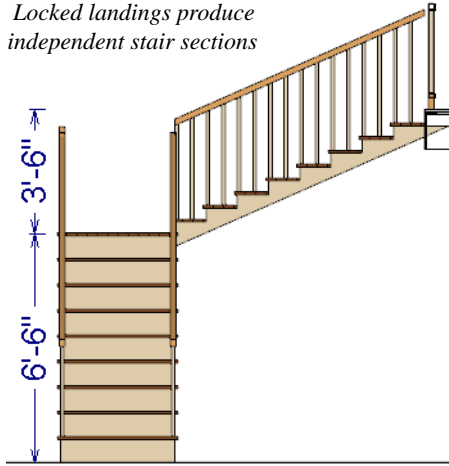

Since the landing height is now closer to the upper floor than to the lower floor, the upper stair section has a very shallow riser height and the lower section has a tall riser height.

Stair and ramp sections attached to a locked landing no longer relate to one another:

- Changes to one section do not affect the other.
- The **Staircase Specification** dialogs show only the selected section and those connected to it by unlocked landings, rather than the entire system.

- Locked landings do not move when attached stair or ramp sections are moved. Only unlocked landings and the sections attached to them will move.

Locked landing can be used to break up a complex network of stairs and landings into smaller pieces with known bottom and top heights.

To lock a landing

1. Select the landing and click the **Open Object**  edit button to open the **Stair Landing Specification** dialog. See “General Panel” on page 318.
2. On the GENERAL panel, uncheck **Auto Adjust Height When Connected to Stairs**.
3. Specify the desired **Top Height** and click OK.
4. The landing moves to the specified height and all stairs that connect to that landing are redefined.

To unlock a landing, open its specification dialog, check **Auto Adjust Height When Connected to Stairs**, and click OK. The Top Height will automatically adjust to any stair or ramp sections attached to it and will try to produce a staircase with a single riser height.

Maintaining Tread Depth

Most building codes require staircases to maintain a consistent tread depth.

Home Designer Interiors measures a stair section’s length and tread depth along a Walk Line located 12” (30 cm) from the right edge

of the stair section. On curved stairs, it is located 12” (30 cm) from the inside edge of the curve.

When a curved stair section has **Automatic Treads** specified in the **Staircase**

Specification dialog and the Walk Line is used, the number and/or width of treads in a section or subsection changes when the inner

edge is moved. For this reason, it is best to finalize stair section width as early as possible.

Starter Treads



The first and second treads of a staircase can be turned into starter treads by clicking the **Starter Tread** edit button. Starter treads extend to the side of the staircase, have rounded edges and are common on traditional staircases.

A starter tread can be added only to open sides of a stair section. If one side of a stair section is against a wall or wrapped (see “Wrapped Stairs” on page 307), only the exposed tread end can become a starter tread.



To create starter treads

1. Click on a staircase to select it.
2. Click the **Starter Tread**  edit button. An edit handle displays on each end of both the first and second treads.

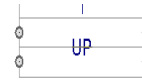

3. Drag either of the handles on the first tread outward from the stair section. If the stair section is against a wall, only one handle displays on the side opposite the wall.
4. As you drag, the ends of the tread become rounded.

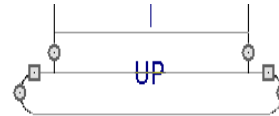

5. Two additional edit handles display on each side of the tread, along the back edge.
6. Drag either of the two square handles upward to increase the width of the rounded ends of the tread.

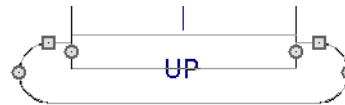

7. Drag the edit handle on the second tread outward from the stair section to create a second starter tread.

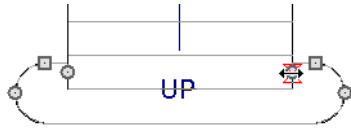

8. To make changes to existing starter treads, select the stairs, click the **Starter**

Tread  edit button and repeat the above steps as needed.

9. When you are finished editing the starter treads, click the **Main Edit Mode**  to restore the stairs' regular edit handles and toolbar buttons.

Wrapped Stairs

Stairs can be wrapped around the corner of a deck or landing. Curved stairs and stairs with multiple subsections cannot be wrapped. See “Style Panel” on page 313.

To wrap stairs around a deck

1. Begin by drawing a deck. See “Decks” on page 171.
2. Use the **Straight Stairs**  tool to place a stair section on each side of the corner around which you want them to wrap.
3. Move the stair sections toward the corner of the deck. When the two sections are sufficiently close to the corner, they will merge to form wrapped steps.



 You can draw stairs down from a deck by right-clicking to draw them or by pressing the Alt key while you drag.

To wrap stairs around a landing

1. Use the **Draw Stairs**  tool to create two perpendicular stair sections with top ends that share a corner.
2. Click between them to create a landing.
3. Rotate one stair section 180°.

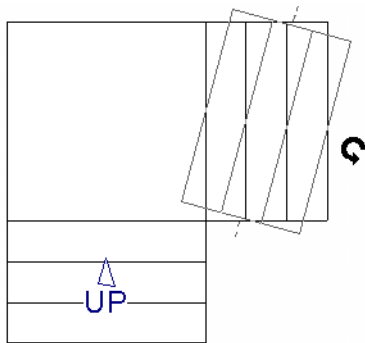

4. The stairs wrap around the corner. Notice that the Up arrow displays on the most recently edited stair section.

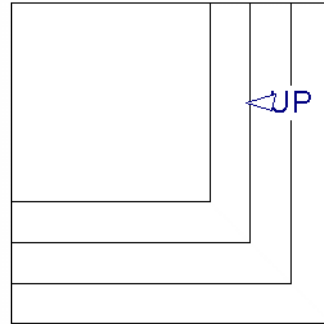

Other Special Railings and Stairs

Stairs can be customized to meet a variety of needs.

Solid Railings

To create a solid rail along a staircase, position a solid Railing or Half Wall  against, but not underneath, the stairs.

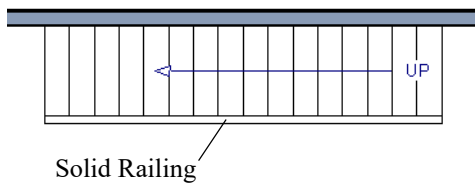

The solid railing recognizes the adjacent stairs and climbs alongside them.



If any balusters extend beyond the railing, eliminate them by unchecking **Left Railing** or **Right Railing** in the **Staircase Specification** dialog. See “Style Panel” on page 313.

Creating a Stairwell

An interior staircase must be located in a stairwell, an opening to the floor above. A

stairwell is an Open Below room type on the floor above. See “Room Types” on page 165.

If you create a stairwell away from other walls so the Open Below is created in the center of another room, connect a wall of the Open Below room to another wall using an invisible wall.

Creating a Stairwell Automatically





To create a stairwell that matches the perimeter of a selected staircase, click the **Auto Stairwell** edit button. This button is only available when a living space exists above the staircase. It will not be available if the space above is Open Below or on the Attic Floor.

Auto Stairwell  automatically creates a room on the floor above enclosed by railings, defined as **Open Below** in the **Room Specification** dialog, and given a **Stairwell** room label. This room can be selected and edited like any other room.





Creating a Stairwell Manually

Stairwells can also be created manually.

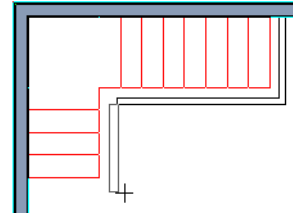
To create a manual stairwell

1. Draw a two-story building. Create the staircase on the first floor.
2. Make the second floor the **Current Floor** and the first floor the **Reference Floor**. See “The Reference Floor” on page 293.
3. Select **Tools> Reference Floors> Reference Display**  to show the Reference Floor, including the stairs.
4. On the upper floor, use the **Railing**  tool to create a room around the stairs. Use the edit handles to position the railings as needed.



5. Select the railings one at a time and move them into position.
 - When a railing is selected, its bounding box shows the location of the outer surface of the railing’s drywall layer. For best results, this outer surface (which does not display when the railing is not selected) should meet the top edge of the stairs.
 - If you prefer, you can also go **Down One Floor**  and adjust the top edge of the staircase to snap it to the surface of the railing on the floor above.
6. When the railings are positioned properly, select **Tools> Reference Floors> Reference Display**  to turn off the display of the Reference Floor.
7. Click inside the room using the **Select Objects**  tool to select it, then click the **Open Object**  edit button.
8. On the GENERAL panel of the **Room Specification** dialog, select “Open Below” from the **Room Type** list. Click **OK** to close the dialog.

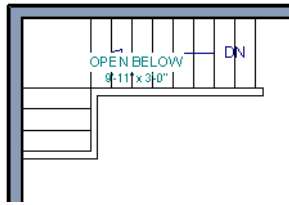

9. Place a **Doorway**  in the railing at the top step for an opening.
10. Select the doorway and define a large width in the **Door Specification** dialog.

If the doorway is specified wider than the railing, its width maximizes to fit the space available.



Rooms Below Staircases

Rooms such as closets or storage areas are commonly located beneath staircases.



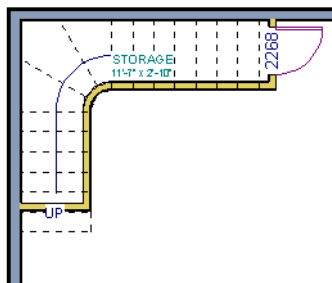

To create a room below a staircase

1. Draw a staircase, select it, and click the **Open Object**  edit button to open the **Staircase Specification** dialog.
 - On the **FILL STYLE** panel, select None (Transparent) so the walls and other objects under the stairs can be seen.

2. On the same floor as the staircase, draw the **Interior Walls**  under them, following their shape.
3. Reposition the walls as needed, making sure that each is entirely under the stairs.
4. The wall at the foot of the stairs should be placed no closer to the bottom than the second step.
5. Add a door and specify the Room Type.



Staircase Specification Dialog

 Staircases can be defined with the greatest accuracy in the **Staircase Specification** dialog. To open this dialog, select a stair section and click the **Open Object** edit button or double-click a stair section using the **Draw Stairs** , **Straight Stairs** , or **Select Objects**  tool.

If a staircase is composed of multiple stair sections, the section that you clicked on to

select the staircase is the Selected Section; however, information about all the sections is available and can be edited in the dialog.

 It is recommended that all floor heights, ceiling heights and platform thicknesses be established before using the Staircase Specification dialog.

General Panel

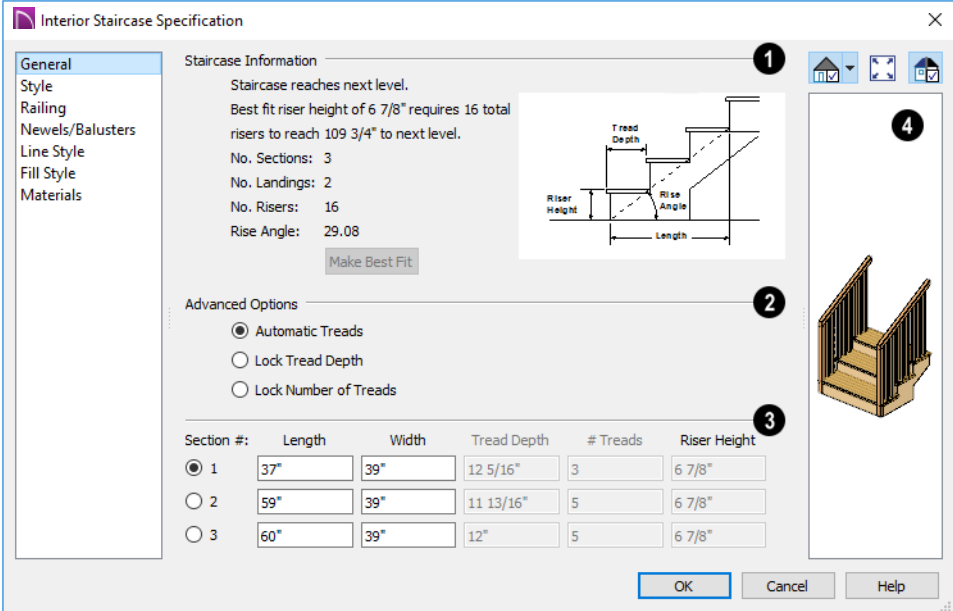

Staircase Information

Staircase reaches next level.

Best fit riser height of 6 7/8" requires 16 total risers to reach 109 3/4" to next level.

No. Sections: 3
No. Landings: 2
No. Risers: 16
Rise Angle: 29.08

Make Best Fit

Advanced Options

Automatic Treads
 Lock Tread Depth
 Lock Number of Treads

Section #:	Length	Width	Tread Depth	# Treads	Riser Height
<input checked="" type="radio"/> 1	37"	39"	12 5/16"	3	6 7/8"
<input type="radio"/> 2	59"	39"	11 13/16"	5	6 7/8"
<input type="radio"/> 3	60"	39"	12"	5	6 7/8"

1 Staircase Information - Structural information about the selected staircase displays here for reference and updates as changes are made on the GENERAL panel.

- The first comment tells whether or not the staircase reaches the next level. It also indicates whether its rise angle is either steeper or more shallow than the Best Fit, described below. If **Automatic Heights**

is unchecked, this comment instead says “Start and end heights are set manually”.

- The second comment, **Best fit riser height of ___ requires ___ total risers to reach ___ to next level**, describes the ideal rise and run for the selected staircase. The program defines the Best Fit Riser Height as the riser height closest to 6 3/4” (168.75 mm) that allows the selected staircase to meet the next level precisely. This comment is only active if **Automatic Heights** is checked, below.
- The total number of stair **Sections**, **Landings**, and **Risers** associated with the selected staircase also display here.
- The **Rise Angle** of the currently active stair section also displays here.
- Click the **Make Best Fit** button to add or remove risers to the Selected Section. Only available when **Automatic Heights** is checked and the staircase does not currently use the Best Fit Riser Height.

A diagram of a sample staircase’s structure displays here for reference, as well.

2 The **Advanced Options** apply to all sections and subsections.

- Select **Automatic Treads** to have the program define the depth and number of stair treads. If the staircase has multiple sections, each may have different tread depths.
- Select **Lock Tread Depth** to specify the Tread Depth for each stair section, below, and prevent them from changing. When Lock Tread Depth is selected and the length of the stairs is changed, the number of treads will change.
- Specify the **Tread Depth**, or run, of each

- Select **Lock Number of Treads** to specify the number of treads in each stair section and prevent it from changing. When Lock Number of Treads is selected and the length of the stairs is changed, the tread depths will change.
- If a staircase with multiple sections is selected, **No Change** may be an option as well. Select this to maintain the multiple sections’ individual settings.

3 The specifications for each stair section and subsection are listed and can be edited here. Up to ten items total can display.

A change in one value usually affects other values. You may need to reposition the staircase after making changes.

- The **Section Number** column identifies the Selected Section and the number of each section of the selected staircase. The radio button to the left indicates which section or subsection is selected. See “Displaying Stairs and Landings” on page 300.
- Define the **Length**, or run, of each section.

When the length of a section changes, other sections and landings in the staircase unit move in response. You can specify whether the bottom or top edge of the Selected Section moves when you resize it by selecting either the Lock Bottom or Lock Top radio button, above.

- Define the **Width** of each section. If a section is connected to a landing, its width should equal the length of the landing edge that it connects to. See “Landings” on page 303.
- stair tread in the selected section.

- Define the number of **Treads** in a stair section or subsection.
 - Define the **Riser Height**, the height of the risers in each stair section.
- 4** A preview of the selected staircase displays on the right side of the panel. If the staircase includes any landings, only the section that was selected when the dialog was opened will display. See “Dialog Preview Panes” on page 28.

Style Panel

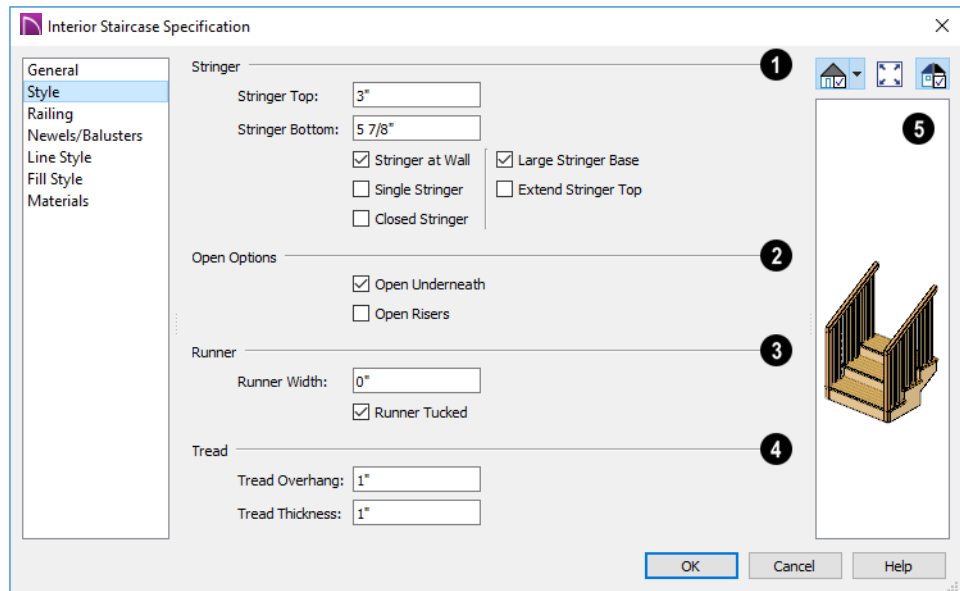

- 1** Specify the attributes of the selected staircase’s **Stringers**, which are the angled support members that support the treads. See “Anatomy of a Staircase” on page 297.
- Specify the height of the **Stringer Top** when **Stringer at Wall** or **Closed Stringer** is selected. This is measured from the top front corner of a tread.
 - Specify the height of the **Stringer Bottom**, as measured from the bottom back corner of a tread.
 - Check **Stringer at Wall** to produce a raised stringer top baseboard at the sides of the stair sections against walls. This baseboard follows the slope of the stair.
 - Check **Single Stringer** to form a single 5-inch (125 mm) thick stringer in the center of the staircase. Checking **Single Stringer** automatically checks **Open Risers** and unchecks **Stringer at Wall** and **Closed Stringer**.
 - Check **Closed Stringer** to raise the tops of the exposed stringers to cover the sides of the treads. If this is checked, no central

stringer is applied to open riser stairs. This setting only affects those stringers that are not against a wall.

- Check **Large Stringer Base** to widen the stringers at the foot of the staircase. This is helpful when walls are created below the stairs.

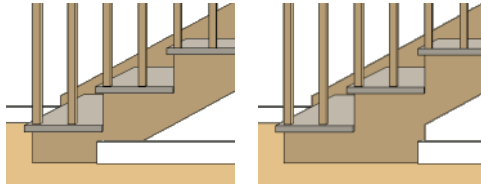

Large Stringer Base shown at right

- **Extend Stringer Top** is checked by default and extends a triangular portion of the stringer under the landing or platform at the top of the stairs.
- 2** The **Open Options** control whether the selected stairs have open risers or an open underside. They are not available when **Single Stringer** is checked, above.
- Uncheck **Open Underneath** to add a skirt below the staircase along the two sides. It looks like a wall in 3D, but only has a single face. Base molding does not generate along the bottom of the skirt, and doors cannot be placed in it. In most cases, the recommended way to enclose

the area beneath stairs is to use walls. See “Rooms Below Staircases” on page 310.

- Check **Open Risers** to eliminate the riser face under each tread and expose the stringers. If **Closed Sides** is also selected, no central stringer is supplied.

3 Specify the attributes of the staircase’s carpet **Runner**. Only available when **Open Risers** is unchecked, above.

- Specify the **Runner Width**. The default value of 0 does not create a runner.
- Uncheck **Runner Tucked** to have the runner drop straight down from the tread front to the riser below. This is checked by default.

4 Specify the characteristics of the staircase **Treads**. See “Anatomy of a Staircase” on page 297.

- Specify the **Tread Overhang**, which is the distance that each tread overhangs the riser.
- Specify the **Tread Thickness**.

5 A preview of the selected staircase displays on the right side of the panel. If the staircase includes any landings, only the section that was selected when the dialog was opened will display. See “Dialog Preview Panes” on page 28.

Railing Panel

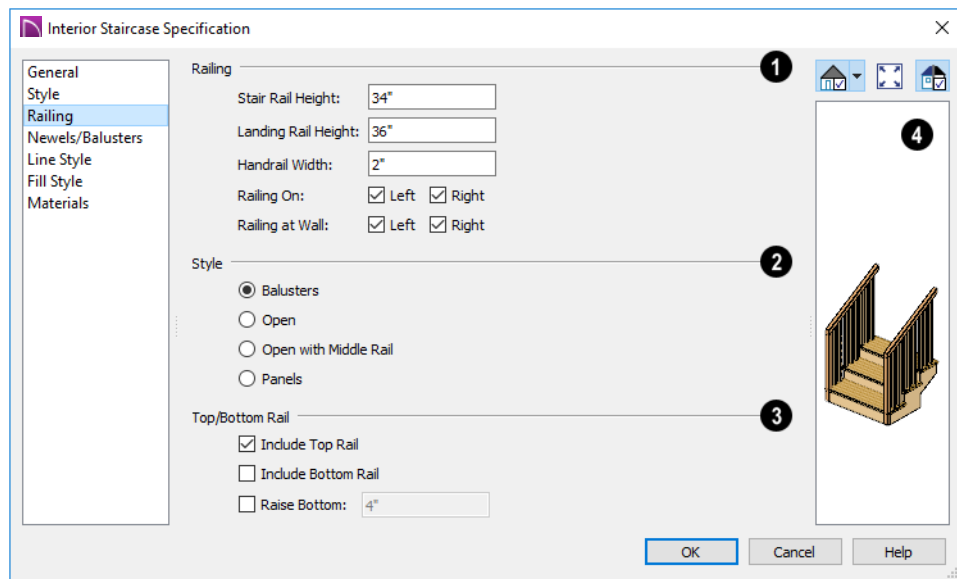

- 1 Specify how the **Railing** is applied to the selected staircase.
 - **Stair Rail Height** defines the height from tread surface directly over the riser to railing top.
 - **Landing Rail Height** defines the height of the landing rail top from the landing surface.
 - **Railing On** - Select **Left** and/or **Right** to specify placement of railings on stair sections.
 - **Railing at Wall** - Select **Left** and/or **Right** to specify the placement of wall railings. Not available for ramps.
- 2 **Style** -
 - Select **Balusters** to create regularly spaced balusters between larger newel posts.
 - Select **Open** to create with only newel posts.
 - Select **Open with Middle Rail** to create railings with newel posts and a middle rail.
 - Select **Panels** to create railings composed of panels. The panel style is specified on the NEWELS/BALUSTERS panel. See “Newels/Balusters Panel” on page 316.
- 3 **Top/Bottom Rail** -
 - Check **Include Top Rail** to produce a top rail on the stair railings that receives the top baluster ends and typically acts as a handrail.
 - Check **Include Bottom Rail** to place a low rail on the landing surface that receives the balusters ends.

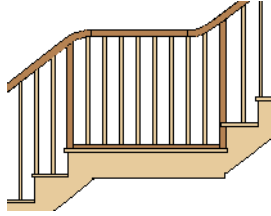

- Check **Raise Bottom**, then specify the distance to raise the bottom rail or panel from the stair tread.

- 4 A preview of the selected staircase displays on the right side of the panel. If the staircase includes any landings, only the section that was selected when the dialog was opened will display. See “Dialog Preview Panes” on page 28.

Newels/Balusters Panel

The settings on the NEWELS/BALUSTERS panel will also affect the appearance of railings on any landings attached to the

selected staircase. See “Landings” on page 303.

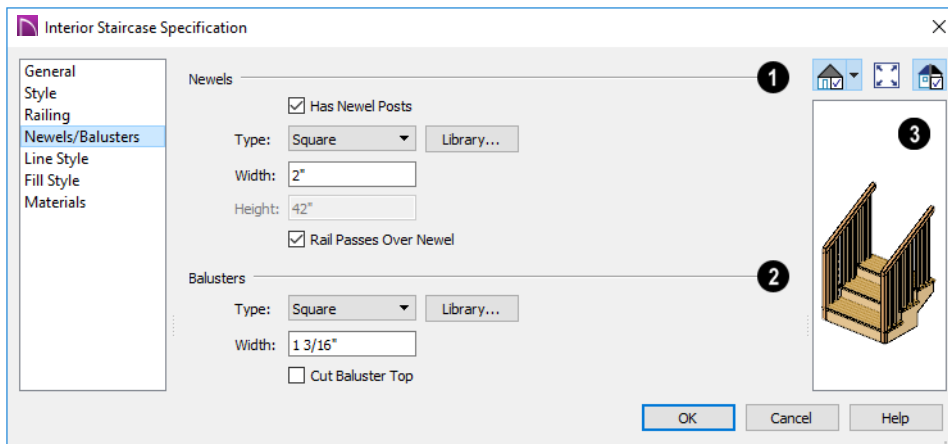

1 Newels -

- Uncheck **Has Newel Posts**, to prevent newels from generating in the selected staircase’s railings. When this box is checked, newels are generated and can be edited using the settings that follow.
- **Type** - Select **Square**, **Round**, or newels from the **Library**. Selecting **Library** from the drop-down list is the same as

clicking the **Library** button to the right and allows selection of a newel from the library.

- Specify the **Width**, which is the width or diameter of each newel. For Library newels, this is the width at its widest point.
- Specify the **Height**, which is the height from the landing surface to the top of the newel. Only available when **Rail Passes Over Newel** is unchecked below.

- Specify the on-center **Spacing** of the newel posts.
- 2 The first three **Balusters** settings are similar to the Newels options of the same names, above.
 - **Cut Baluster Top** - Each tread normally has two to three balusters, growing longer toward its back. The default is to use the same baluster and cut it off at the bottom to shorten it toward the tread front. Check this box to cut the balusters at the top instead.
 - 3 A preview of the selected staircase displays on the right side of the panel. If the staircase includes any landings, only the section that was selected when the dialog was opened will display. See “Dialog Preview Panes” on page 28.

Line Style Panel

The settings on the LINE STYLE panel are available for a variety of other objects in the

program. For information about these settings, see “Line Style Panel” on page 124.

Fill Style Panel

The settings on the FILL STYLE panel affect the appearance of the selected staircase in floor plan view. For information about these settings, see “Fill Style Panel” on page 129.

Materials Panel

The settings on the MATERIALS panel affect the appearance of the selected staircase in 3D views and are available for a variety of objects throughout the program. For information about these settings, see “Materials Panel” on page 366.

The settings on this panel will also affect the materials applied to any landings attached to the selected staircase. See “Landings” on page 303.

Stair Landing Specification Dialog



Select a landing and click the **Open Object** edit button to open the **Stair Landing Specification** dialog. See “Landings” on page 303.

Many of the panels in this dialog are found in the specification dialogs for a variety of different objects in the program.

General Panel

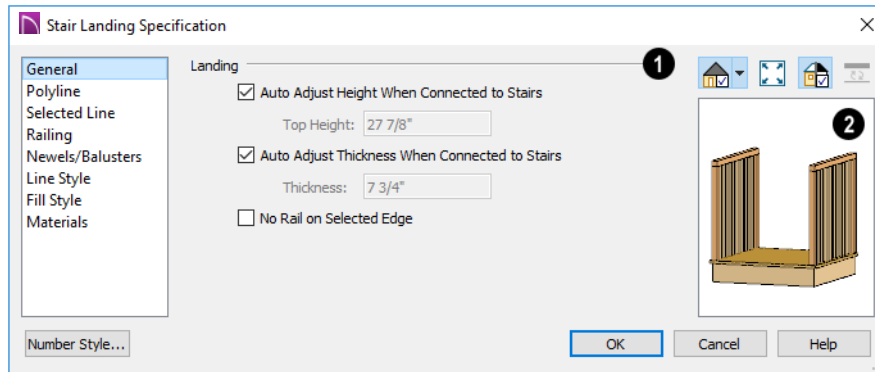

1 Landing -

Uncheck **Auto Adjust Height When Connected to Stairs** to specify the selected landing's Top Height.

- A free-standing interior landing will have a default Top Height of 6 3/4" (169 mm) plus the thickness of the default floor finish. A free-standing exterior landing will have a default top height equal to its thickness. When this box is checked, the landing height may adjust as needed to maintain consistent riser height in all connected stair sections.
- The **Top Height** field is only active when Auto Adjust Height When Connected to Stairs is unchecked. See "Locked Landings" on page 304.

Uncheck **Auto Adjust Thickness When Connected to Stairs** to specify the selected landing's Thickness.

- A free-standing landing will have a default thickness of 6 3/4" (169 mm). When checked, the thickness is based on the riser height of the stair sections it is

attached to, or the thickness of the ramps it is attached to.

- The **Thickness** field is only active when Auto Adjust Thickness When Connected to Stairs is unchecked.

Check **No Rail on Selected Edge** to suppress the railing on the selected edge of this landing. See "Selected Edge" on page 92.

- 2 A preview of the selected landing displays on the right side of the panel. See "Dialog Preview Panes" on page 28.

Polyline Panel

The POLYLINE panel states the length of the landing's **Perimeter**, its enclosed **Area**, and its **Volume**.

The settings on the this panel are available for a variety of other objects in the program. See "Polyline Panel" on page 128.

Selected Line Panel

The SELECTED LINE panel is available when the selected edge is a line as opposed to an arc. See "Selected Edge" on page 92.

The settings on this panel are available for a variety of other objects in the program. See “Line Panel” on page 123

Moving the End of a line segment moves the start of the next connected line.

Selected Arc Panel

The SELECTED ARC panel is available only when the selected edge has been converted to an arc. See “Change Line/Arc” on page 115.

The settings on this panel are available for a variety of other objects in the program. See “Arc Panel” on page 126

Line Style Panel

The settings on the LINE STYLE panel are available for a variety of objects throughout

the program. See “Line Style Panel” on page 124

Fill Style Panel

The settings on the FILL STYLE panel affect the appearance of the selected landing in floor plan view. See “Fill Style Panel” on page 129

Materials Panel

When a landing is attached to stairs, its initial materials are derived from the stairs.

The settings on this are available for a variety of objects throughout the program. For information about these settings, see “Materials Panel” on page 366.

Roofs

Home Designer Interiors’s automatic Roof Tools allow you to draw almost any roof style.

Proficiency with the Roof Tools can only be attained through practice, but mastering these tools saves you time and effort in plan development. For information about creating specific roof styles, see “Roof Tutorial” on page 57 of the User’s Guide.

Chapter Contents

- Roof Defaults
- The Roof Tools
- Automatic Roofs
- Build Roof Dialog
- Editing Roofs
- Skylights
- Skylight Specification Dialog
- Roof Pitches in Degrees

Roof Defaults



Select **Edit> Default Settings**, to open the **Default Settings** dialog for a variety of drawing tools, several of which directly affect roof generation.

Roof Defaults Dialog

The **Build Roof** and **Roof Defaults** dialogs are nearly identical in appearance and function. The only difference is that the **Build Roof** dialog has a checkbox that allows you to automatically generate roof planes. See “Build Roof Dialog” on page 323.

Floor and Ceiling Heights

The initial heights of floors and ceilings, which influence roof heights, are specified in the **Floor Defaults** dialog for each floor. See “Floor Defaults Dialog” on page 288.

The floor and ceiling heights in individual rooms also influence roof heights and are specified in the **Room Specification** dialog. See “Structure Panel” on page 177.



If Auto Rebuild Roofs is checked in the Build Roof dialog and you change floor or ceiling heights, wall positions or roof directives in walls, the roof rebuilds to reflect your changes. See “Rebuilding Roofs” on page 323.

Wall Specification Dialog

By default, when a roof is built, a roof plane is generated over each exterior wall, creating a hip roof.

Any deviations from this default hip roof, such as a gable or a different pitch, can be specified in the **Wall Specification** dialog for any exterior wall. See “Roof Panel” on page 154.

The Roof Tools



Select **Build> Roof** to access the Roof Tools.

Build Roof



Select **Build> Roof> Build Roof** to open the **Build Roof** dialog, specify the settings for automatically generated roof planes, and build or rebuild a roof. See “Build Roof Dialog” on page 323.

When roofs are automatically generated, a roof plane is created over each exterior wall by default, resulting in a hip roof.

To automatically generate a roof plane using values other than the defaults or to not generate a roof plane bearing on a particular wall (as with a gable or the sides of a shed roof), you can change the settings in the **Wall Specification** dialog. See “Roof Panel” on page 154.

For more information about creating different roof styles, see “Roof Tutorial” on page 57 of the User’s Guide.

Skylight



Select **Build> Roof> Skylight**, then draw a rectangle over an existing roof plane to create a skylight. The skylight, skylight shaft, and ceiling hole (if a ceiling exists) are drawn at the same time. See “Skylights” on page 326.

Delete Roof



Select **Build> Roof> Delete Roof** to delete all roof planes in the plan. See “Deleting Roof Planes” on page 325.

Automatic Roofs

When roofs are automatically generated, a roof plane is created over each exterior wall by default, resulting in a hip roof.

Roof Directives in Walls

To automatically generate a roof plane using values other than the defaults or to not generate a roof plane bearing on a particular wall (as with a gable or the sides of a shed roof), you can change the settings in the **Wall Specification** dialog for that wall. See “Roof Panel” on page 154.

For more information about creating different roof styles, see “Roof Tutorial” on page 57 of the User’s Guide.

Rebuilding Roofs

By default, whenever changes are made to wall placement, floor/ceiling heights, or roof directives in walls, the roof will update in response. If you do not want the roof to rebuild automatically, uncheck **Auto Rebuild Roofs** in the **Build Roof** dialog. See “Roof Panel” on page 324.

You can also rebuild the roof at any time to reflect the current state of the model by opening the **Build Roof** dialog and clicking OK.

Build Roof Dialog



The **Build Roof** dialog is used to automatically build or rebuild roof planes. To open the **Build Roof** dialog, select **Build> Roof> Build Roof** .

Roof planes are generated based on the positions and roof directive settings for each exterior wall in the plan. If you make changes to any of these walls, you will need

to build the roof again for them to take effect. See “Roof Panel” on page 154.

Aside from a checkbox on the ROOF panel that allows you to automatically generate roof planes, the settings in this dialog are also found in the **Roof Defaults** dialog. See “Roof Defaults” on page 322.

There are three panels in the **Build Roof** dialog:

- Roof Panel
- Materials Panel
- Roof Styles Panel

Roof Panel

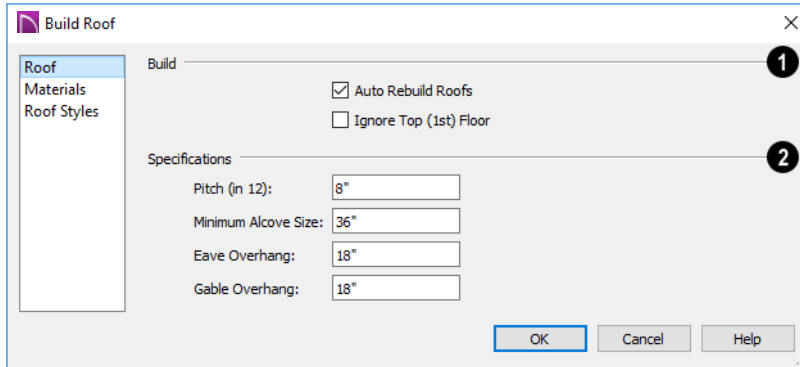

1 The **Build** options are commands related to building and rebuilding roofs.

- If you check **Auto Rebuild Roofs**, the program automatically rebuilds the roof if you make a change that affects the roof, such as to exterior wall positions or ceiling heights.
- Check **Ignore Top Floor** to build the roof so that it bears on the walls of the floor below the top living floor in the plan. When unchecked, the roof builds so that it bears on the walls on the top floor of the plan.

2 The **Specifications** settings affect basic roof structure.

- Enter a value to describe the **Pitch**. In plans using U.S. units of measurement, pitch is described as a ratio over 12; in metric plans, it is measured in degrees. For a conversion to degrees, see “Roof Pitches in Degrees” on page 328.

- **Minimum Alcove Size** - Specify the minimum width of an alcove (depression into an otherwise straight exterior wall). Any alcove less than the specified width is treated as though the exterior wall continues straight across. Alcoves that measure wider than this value are not roofed over; they cause a change in roof planes.

Following is an example showing this difference. If **Min Alcove** is 36", a 36" wide alcove requires a change in the roof line. Each wall of the alcove has an eave. On the right, the alcove is less than the 36" minimum, so the roof passes right over it.

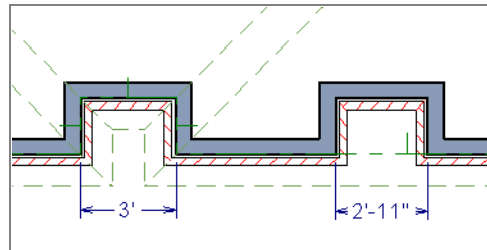

The **Roof Overhang** is measured horizontally from the exterior surface of the wall's framing layer to the end of the top of the rafter. It does not include gutters, sheathing or siding.

- **Normal** is the overhang at the eaves and is always the overhang for a roof plane having the default Pitch specified above. If the pitch for a particular roof plane is set differently, its overhang may try to maintain its fascia at the same height. Overhang can be greater for a shallower pitch, lesser for a greater pitch.
- **Gable** is the overhang dimension at gable ends or rake walls.

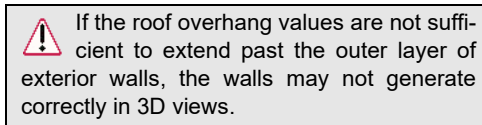

Materials Panel



The settings on this panel allow you to specify materials for the roof's various components. See "Materials Panel" on page 366.

Roof Styles Panel

The ROOF STYLES panel provides links to tutorial information about creating different roof styles automatically. Click on a roof style to launch the online Help to a page with information about the roof style you selected. See "Roof Tutorial" on page 57 of the User's Guide.

Editing Roofs

Unlike most other objects in Home Designer Interiors, roof planes cannot be selected and edited. To make changes to the roof, you must edit the edit roof directives in walls and/or settings in the **Build Roof** dialog, and then rebuild. See "Rebuilding Roofs" on page 323.

An exception to this rule is the **Material Painter**  tool, which you can use to change the materials used by individual roof planes without rebuilding the roof. Bear in mind, though, that any changes made using the **Material Painter**  will not be retained if the roof is later rebuilt. See "The Material Painter" on page 363.

Deleting Roof Planes

There are several ways to delete roof planes.





Delete the entire roof quickly by selecting **Build > Roof > Delete Roof**.



You can also delete all roof planes at once in the **Delete Objects** dialog. See "Delete Objects Dialog" on page 117.

Skylights

 A skylight can be created by selecting **Build> Roof> Skylight** and drawing a rectangular polyline within a single roof plane. You can also simply click once within a roof plane to place a 2' x 2' skylight.

The **Skylight**  tool places a flat panel skylight into a roof hole, produces a hole in the ceiling platform below, and automatically generates the skylight shaft between these two holes.

To place a skylight in a vaulted ceiling, uncheck **Ceiling Over This Room** in the **Room Specification** dialog, draw the ceiling planes to produce the vault and edit them as needed, and then draw the skylight. See “Structure Panel” on page 177.

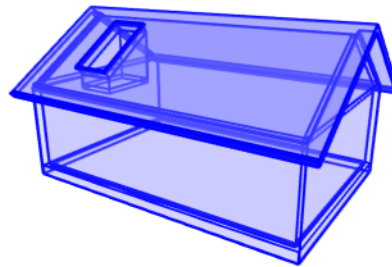
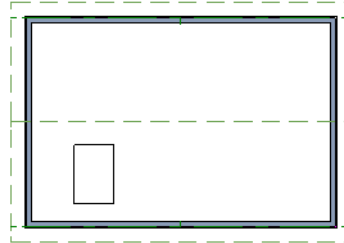

Editing Skylights

Skylights can be edited using the edit handles, edit toolbar buttons, or the **Skylight Specification** dialog. See “Skylight Specification Dialog” on page 326.

Skylights must always be contained by a single roof plane. If the roof plane is deleted, any skylights it contains are also deleted. Aside from this restriction, skylights can be edited much like standard closed polylines. See “Editing Closed-Polyline Based Objects” on page 101.

Skylight Specification Dialog

 Select a skylight and click the **Open Object** edit button to open the

Skylight Specification dialog. See “Skylights” on page 326.

General Panel

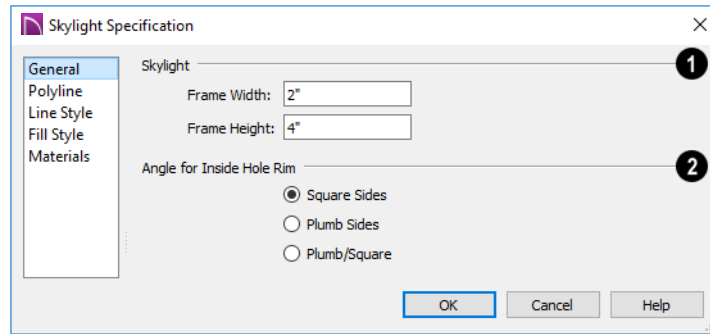

1 Specify the **Frame Width** and **Height** of the selected skylight.

2 **Angle for Inside Hole Rim** - Defines the shape of the skylight well where it passes through the roof plane.

- **Square Sides** - The framing for the skylight is cut square to the pitch of the roof.
- **Plumb Sides** - The framing for the skylight is plumb-cut.
- **Plumb/Square** - The bottom edge is plumb-cut, the top edge square-cut.

Polyline Panel

The **POLYLINE** panel states the skylight's **Perimeter**, its **Framing Area**, and its **Projected Area**.

- The **Perimeter** is the length of the skylight's perimeter with the pitch taken into account. It does not equal the perimeter as measured in floor plan view.
- The **Framing Area** is the area of the skylight with the pitch taken into account.
- The **Projected Area** is the area of the skylight as seen in floor plan view.

Line Style Panel

For information about the settings on this panel, see "Line Style Panel" on page 124.

Fill Style Panel

The settings on the **FILL STYLE** panel control the appearance of the selected skylight in floor plan view. For information about these settings, see "Fill Style Panel" on page 129.

Materials Panel

For information about the **MATERIALS** panel, see "Materials Panel" on page 366.

Roof Pitches in Degrees

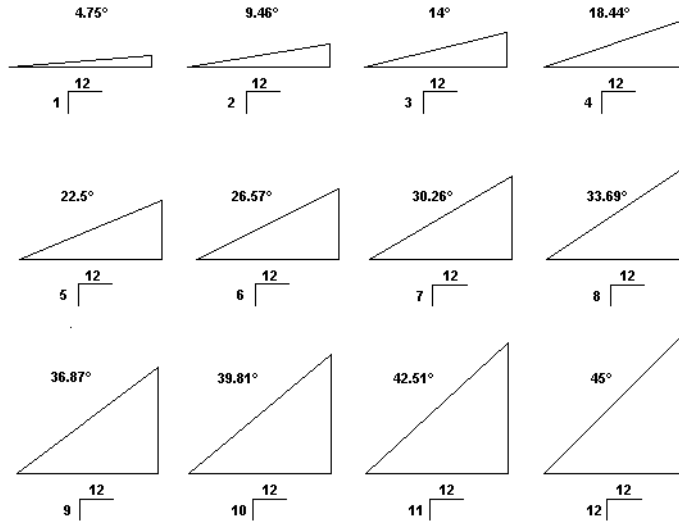

The Library

Home Designer Interiors's library offers thousands of symbols, materials, and images that can enhance any plan.

New library catalogs and enhancements are made available by Chief Architect on a continuing basis and are available for download for the current program version.

You can also customize items from the library or import new items from outside the program and then save them in the library for future use.



Chapter Contents

- The Library Browser
- Searching the Library
- Library Content
- Downloading Library Content
- Importing Library Catalogs
- Adding Library Content
- Organizing the Library
- Exporting Library Catalogs
- Placing Library Objects
- Select Library Object Dialog
- Replace From Library
- Displaying Library Objects
- Editing Library Objects
- Symbol Object Specification Dialogs

The Library Browser

 The Home Designer Interiors Library Browser allows you to manage the contents of the library as well as add library content to your drawings.

To open the Library Browser:

- Select **View > Library Browser** .
- Click the **Library Browser** button .
- Press **Ctrl + L** on your keyboard.

By default, the Library Browser is docked to the right side of the program window, but can be undocked or docked to another side. See “Docking the Library Browser” on page 333.

The Library Browser has four sections:

- The search options at the top.
- The Directory and Search Results Pane.
- The Selection Pane.
- The Preview Pane.

To adjust the height or width of a section, place the pointer over the split bar you want to move. When the double-headed arrow \leftrightarrow displays, click and drag.



You can control the configuration of the Library Browser panes in the Preferences dialog. See “Library Browser Panel” on page 60.

You can work on your drawing with the Library Browser open. To close the Browser, click the Close  button or double-click on an object in the Selection Pane.

The library directory is presented in a tree list with five categories: Home Designer Core

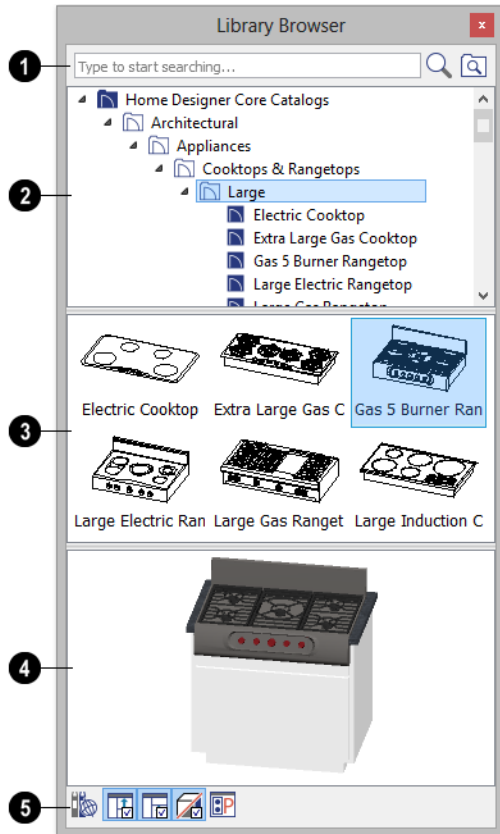

Catalogs, Home Designer Bonus Catalogs, Manufacturer Catalogs, User Catalog and Trash. See “Library Content” on page 334.



1 Search the library using keywords and optional search filters. See “Searching the Library” on page 333.

- Begin typing in the text field to search for library items. As you type, search results will display in the Directory Pane.
- Right-click on an item in the Search Results list and select **Show in Browser**

to view the item's location in the Directory list.

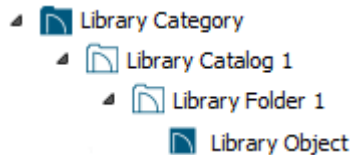

- Click the **Browse**  button to stop searching and restore the Directory list.
- Click the **Search**  button to display the search results for your search entry.
- Click the **Search Filtering Options**  button to customize your search parameters. If the Library Browser is resized so that it is narrow, this button will be replaced by two arrows.

- 2** The library **Directory** and **Search Results** display here. The basic structure of the directory tree is:



Library items are always placed in alphabetical order within their hierarchy.

The Library Browser includes a Trash bin, where deleted items are moved until you choose to Empty Trash. See “Deleting Library Items” on page 341.

Navigate the Directory Pane using the mouse. Click the gray Expand arrow  beside a catalog or folder to display its contents. Once expanded, you can click the black Collapse arrow  to close it again. You can also browse the list using the arrow keys on your keyboard.

Click on an item to select it. Preview images display in the Selection and Preview Panes and basic information about it also displays

in the program's Status Bar. See “The Status Bar” on page 29.

- 3** The **Selection Pane** shows a thumbnail image of the item selected in the Directory Pane.

When an item is selected in the Directory Pane, a basic line-based representation of the item displays in the Selection Pane.

- If the selected item is a single object, a preview of that object displays in the Preview Pane. You can move your cursor into the drawing area to place the item. See “Placing Library Objects” on page 342.
- If the selected item is a folder, a thumbnail image displays, representing each item inside. Move your pointer over an item in this pane to see a Tool Tip with the item's name. Click on a folder in the Selection Pane to display its contents here and make it the item selected in the Directory Pane.
- Some folders may have too many items to display useful thumbnails for each; when this is the case, they do not display.

Click the **Show/Hide Selection Pane**  button to toggle the Selection Pane on and off.

- 4** When an individual item is selected in either the Directory or Selection Pane, an image of it displays in the **Preview Pane**. If the item is designed to be inserted into another object such as a cabinet, that parent object will also display in the preview.

You can click the **Toggle Preview Display**  button at the bottom of the browser

window to switch between preview images in high and low detail.

If the selected object is a 3D symbol, you can rotate and zoom in or out on the Preview using the mouse.

If you have rotated a view in the Preview Pane, you can restore the default angle either by clicking in the Selection Pane or by right-clicking on the Preview Pane and selecting **Reset Preview**.

Click the **Show/Hide Preview Pane**  button to toggle the Preview Pane on and off.

5 The toolbar at the bottom of the browser aids in searching, displaying panes, and managing library content.

 Click the **Get Additional Online Content** button to launch your default web browser to the Home Designer Interiors web site, where additional library content is available for download.

 Click the **Show/Hide Selection Pane** button to toggle the Selection Pane on and off.

 Click the **Show/Hide Preview Pane** button to toggle the Preview Pane on and off.

 Click the **Toggle Preview Display** button to switch between high and low detail images of a selected library object in the Preview Pane.

 Click the **Preferences** button at the bottom of the Library Browser to open the **Preferences** dialog, where display properties for the Library Browser can be controlled. See “Library Browser Panel” on page 60.

Using the Contextual Menus

A number of important library functions can be accessed using the contextual menus. Right-click on an item in the Library Browser to open a contextual menu displaying options related to that item. See Contextual Menus.

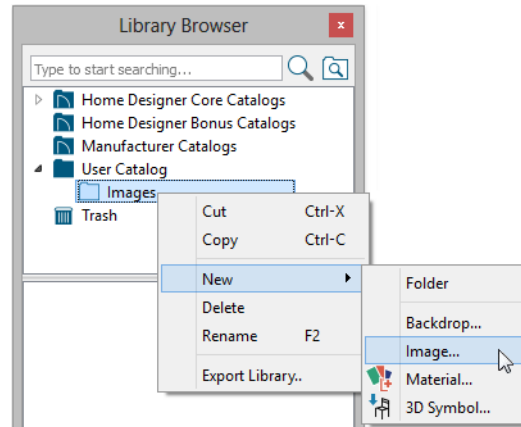

The options in the contextual menu vary depending on the item selected, but may include:

- Cut/Copy/Paste
- Paste Shortcut
- New
- Rename
- Delete
- Export Library
- Open Object
- Reset Preview
- Expand All/Collapse All
- Show in Browser

Keyboard Commands

The Library Browser can be navigated using the arrow keys on your keyboard.

- The right and left arrow keys expand and collapse folders.
- The up and down keys change which library object is currently selected.
- Select an item and press F2 to rename it.
- Select an item and press the Delete key to delete it.

Expand/Collapse All

When a library category or folder is selected in the Directory Pane, **Expand All** and **Collapse All** are available in the contextual menu, allowing you to expand or contract its contents in the tree view.

Docking the Library Browser

Initially, the Library Browser side window is docked to the right side of the main Home Designer Interiors program window. To



undock it, click and drag its title bar towards the center of the program window. Once undocked, it can be moved and redocked in the same manner. See “Side Windows” on page 23.

When moved to the top, bottom, or side of the program window, it automatically docks in a vertical or horizontal orientation, depending on its location. You can prevent the Library Browser from docking by holding down the **Ctrl** key while dragging it.

To return the Library Browser to its original position and size, click the **Restore Position/Size** button in the **Preferences** dialog. See “Reset Options Panel” on page 64.

Closing the Library Browser



The Library Browser can be closed in either of two ways:

- Click the **Close**  button at the top right corner of the browser window.
- Select **View > Library Browser** .

Searching the Library

The Library Browser filtering options let you focus your searches to meet parameters that you define.

To search the Library Browser

1. Select **View > Library Browser**  and click in the Search field at the top of the Library Browser.
2. Begin typing a keyword to search for. As you type, the search results will populate in the Directory Pane below.
3. You can use quotation marks “” to search for an exact word or phrase, but other operations are not supported.
4. You can click the **Clear**  button on the right side of the Search field to remove anything typed in this field.
5. If you move your mouse pointer over the Search field, a Tool Tip will state the number of results of your search.
6. Right-click on an item in the Search Results list and select **Show in Browser**

to view the item's location in the Directory list.

Substrings are not included. For example, searching for "windows" will not produce "window" as a search result. On the other hand, searching for "window" will produce "windows" as a search result.

To search using custom filters

1. Click the **Turn on search filtering options**  button.
 - Check **Keyword** to match the entered search keyword with an object's search attributes.
 - Check **Entire Word** to match the entire keyword or words with the complete name of the object.
 - Check **Folders** to include library folders in your search.
2. Click the arrow beside **Type**, **Style**, or **Manufacturer** to expand that category.

- Check the box beside one or more **Type** of library item that you want to include in your search.
- Check the box beside one or more architectural or design **Style** to include items of that style in your search.
- Check the box beside one or more **Manufacturer** to include in your search. Manufacturer catalogs that were imported during the current program session will not be listed here until you exit out of and restart Home Designer Interiors.



To save time, check the box beside Type, Style, or Manufacturer to select all of the options in that category at once; uncheck the box to deselect all of the options.

3. Type a keyword in the **Search** field. The results will be filtered to match your selected filtering options.

Library Content

The Home Designer Interiors library has five categories: Home Designer Core Catalogs, Home Designer Bonus Catalogs, Manufacturer Catalogs, User Catalog and Trash.

Home Designer Core Catalogs

The Home Designer Core Catalogs category contains a wide selection of 3D symbols, images, and materials. When you install the program from DVD, this library content will also be installed; if you download the software, you will be able to download the

Core Catalogs separately, after the program is installed.

When you launch the program for the first time, it will ask if you want to download the Core Catalogs. Click Yes to begin the download. If you click No, you can download at any time by selecting **Library> Install Core Content** from the menu.

Home Designer Bonus Catalogs

Chief Architect regularly posts new library catalogs available for download. Select

Library> Get Additional Content

Online  from the menu to access the bonus catalogs and content.

Most Bonus Catalogs can be purchased for a nominal fee, while others are available free of charge. In addition, some Bonus Catalogs are only available to Chief Architect Support and Software Assurance program members.

Manufacturer Catalogs

A variety of name brand library catalogs is available for download on the Home Designer web site with content ranging from materials to fixtures.

Select **Library> Get Additional Content**

Online  to access these Manufacturer Catalogs.

As with the Bonus Catalogs, some Manufacturer Catalogs are available free of charge while others can be purchased, and some are available for Support and Software Assurance members only.

Note: Support and Software Assurance is an optional program for holders of Chief Architect Premier and Chief Architect Interiors software licenses and is not available for Home Designer licenses.

The User Catalog

The User Catalog is the location for items that you add to the library either from a drawing or by importing. See “Adding Library Content” on page 338.

You can create and organize custom library folders and imported images, backdrops, and materials. See “Organizing the Library” on page 339.

Updating Library Catalogs

The Home Designer Core Catalogs, Bonus Catalogs, and Manufacturer Catalogs are updated periodically to include new and improved content. You can update your installed catalogs to include the latest content by selecting **Library> Update Library Catalogs** at any time.

The program will gather information about the content in each of these three categories, and then download and replace any content that is not up to date, and you may see a progress indicator at the bottom of the Library Browser while it is doing so. See “Download Progress” on page 336.

Backing up Library Content

The Home Designer Interiors User Catalog File, User_Library.calib, is located in the Home Designer Interiors 2018 Data folder. See “Home Designer Interiors Data” on page 37.

The best way to back up your custom library content is to export the items in your User Catalog, as this will ensure that the textures used by custom materials are not lost. See “Backing Up Your Files” on page 41.

Exported libraries use the **.calibz** file format: a zipped file type that can include textures and images along with other library data.

To back up your custom library content

1. Launch Home Designer Interiors and select **View> Library Browser**  from the menu.
2. Right-click on a folder or item in the User Catalog.

3. Select **Export Library** from the contextual menu.
4. The **Export Library Data** dialog is a typical Save dialog. See “Exporting Files” on page 41.

- Notice that the file type in the Save as type field is “Library File with Textures/Images (*.calibz)”.

Downloading Library Content

The Home Designer Core Catalogs, Home Designer Bonus Catalogs, Manufacturer Catalogs are all available for internet download.

Core Catalogs

When you launch Home Designer Interiors for the first time, you will be asked if you want to download the Core Catalogs. Click Yes to begin the download.

If you click No, you can download at any time by selecting **Library > Install Core Content** from the menu.

Bonus and Manufacturer Catalogs

Bonus and Manufacturer Catalogs can be downloaded from our web site, www.HomeDesignerSoftware.com. Select **Library > Get Additional Content**

Online  to launch your default internet browser to our Content Resources page.

Download Progress

When library content is downloading, a green progress bar will display at the bottom of the Library Browser. If you choose to download the Core Catalogs while the library

is not open, the Browser will open so the progress indicator can display.

Click on the progress bar to display the name of the current file being downloaded, the total amount of data to be downloaded in KB, and the amount downloaded so far.

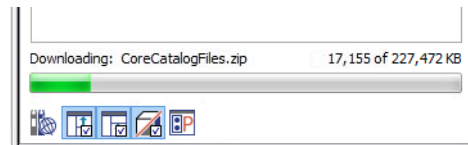

Pausing and Resuming

Library downloads can only take place while Home Designer Interiors is running. If you close the program while a download is in progress, a dialog will confirm whether you wish to stop the download.

- Click **Stop Download and Close Program** to stop the download and close the program.
- Click **Cancel** to leave the program open and continue downloading.

Most catalogs are composed of a single file. If you stop the download midway, none of the downloaded data will be retained.

The Core Catalogs, on the other hand, contain a large volume of data saved in multiple files. If you close the program and stop the Core Catalogs download midway,

only data associated with the file currently being downloaded will be lost. You can resume the download beginning with that file at a later time by selecting **Library> Install Core Content**.

Download Errors

If any problems occur during the library download process, a dialog box will notify you at the end of the download. Click **Retry Download** to repeat the download and correct any errors or click **Cancel** to discard the downloaded catalog.

Importing Library Catalogs

Home Designer Interiors library files have two different file extensions: **.calib** and **.calibz**. Both files can include any combination of Home Designer Interiors library items; in addition, **.calibz** files are able to save data associated with textures and images. Both file types can be imported into the Home Designer Interiors library.

There are several ways to import a **.calib** or **.calibz** file into the program library:

- Double-click on the file in an operating system window while a plan file is open.
- Drag the file from an operating system window and drop it into the Home Designer Interiors program window.
- Select **Library> Import Library** from the program menu.

Note: Library files cannot be imported if no plan file is open, or when a Materials List window is active.

To import library files into the library

1. Select **Library> Import Library** to display the **Import Library Data** dialog.
2. Browse to the **.calib** or **.calibz** file that you want to import and select the files so

that its name displays in the **File Name** field.

3. Click the **Open** button.
4. A progress bar will display, telling you the progress of each library data file as it is imported. Once imported, each file will be located in the User Catalog.

When a **.calib** or **.calibz** file is imported into the program, its contents are automatically placed in the User Catalog. Any images or textures saved in a **.calibz** file will be copied into the Home Designer Interiors 2018 Data\Images and Textures folders for backup purposes. The program will only reference these copies if it cannot locate the files in their original locations. See “Home Designer Interiors Data” on page 37.

Library Catalog Migration

If you have library catalogs from Home Designer Interiors 2014 through 2017 installed on your computer, the initial startup of Home Designer Interiors 2018 will give you the opportunity to migrate that content into the Home Designer Interiors 2018 Library. See “Migrating Settings and Content” on page 15.

Legacy Library Conversion

You can import **.calib** and **.calibz** files created in Home Designer versions 2012, 10, or 9 for use in version 2018 at any time. See “Exporting Library Catalogs” on page 342.

Note: Library content exported from Home Designer Interiors 10 will not include catalog names. Any subscribed content from version 10 that has not been downloaded will not be included, either.

In addition, legacy **.alb** files created in Home Designer versions 8.0 and prior can be converted for use in version 2018.

To convert legacy library files

1. Select **Library> Convert Legacy (.alb) Library Files**.
2. In the **Select a Legacy Library File Folder** dialog, select an **.alb** file that you want to bring in to Home Designer Interiors 2018.
3. The selected file’s name will display in the **File name:** field.
4. Click the **Open** button to import the prior version third party **.alb** file into the User Catalog.
5. Organize the imported content to suit your needs. See “Organizing the Library” on page 339.

Adding Library Content

In addition to downloading Home Designer Interiors Content and importing entire catalogs into the library, you can also add a variety of individual objects to the library.

Add to Library

Nearly any object placed from the Library Browser can be added to the User Catalog in the library. Select an object in your plan and click the **Add to Library**  edit button.

A few objects cannot be added to the library: notably imported pictures, metafiles, and PDF files.

Any object created using a drawing tool in Home Designer Interiors will automatically be added to the User Catalog using the name of that tool, whereas a symbol will automatically use the Symbol Name. See “Native Objects vs Symbols” on page 346.

Once added to the library, objects in the User Catalog can be renamed. See “Renaming Library Items” on page 340.

Adding Materials and Images

New materials, images, and plant images can be created in the User Catalog. Right-click on the User Catalog or a folder within it, select **New>** from the contextual menu, then select the type of item you wish to create from the submenu.

Home Designer Interiors can use materials and images in a variety of file formats and provides several means of adding new material and image files to the library. For more information, see “Creating Materials” on page 369 and “To create an image in the Library Browser” on page 407.

Adding New Backdrops

A backdrop is an image, typically of an exterior view, that displays in the background of 3D views to help place the model into a realistic setting and add a sense of perspective. See “3D Backdrops” on page 415.



A new backdrop image can be created using a variety of graphic file formats and can be imported into Home Designer Interiors in several ways:

- Select **File> Import> Backdrop**  to open the **Import Backdrop File** dialog, which is similar to the **Import Picture File** dialog. See “Importing Pictures” on page 412.
- Right-click on the User Catalog and select **New> Backdrop** from the contextual menu.
- Copy and paste an image into Home Designer Interiors. See “Copying and Pasting Objects” on page 81.

Creating a Customized Library Item

You can customize an existing library object and save your changes for future use by first copying the item into an unlocked library.

To customize a library object

1. Right-click on a library item and select **Copy**  from the contextual menu.
2. Browse to the User Catalog or a folder within it and right-click on it.
3. Select **Paste** from the contextual menu to make a copy of the library item in this new location.
4. Right-click on the copied item and select **Open**  from the menu.
5. The item’s specification dialog opens, and you can make any changes that you wish to the item.
6. Make any needed changes to the item, then click OK. Your changes will be saved with this item for use in any plan.

Organizing the Library

Library folders and objects can be copied, pasted, moved, and deleted: allowing you to organize your User Catalog to best suit your work style and needs.

Adding New Folders

New folders can be added to the User Catalog or to any folder located within it. To add a new folder, right-click on User Catalog or one of its sub-folders and select **New> Folder** from the contextual menu.

The new folder is created inside the library item you right-clicked on and is initially named “Untitled”. Type a short, descriptive name and press Enter.

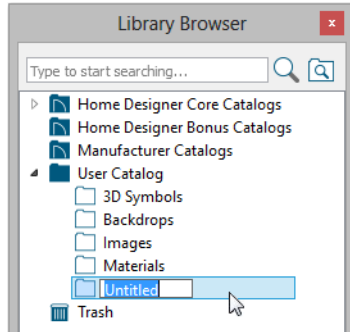

Selecting Library Items

To select a library object, folder, or category, simply click on it.

When an item is selected, preview images display in the Selection and Preview Panes and basic information about it also displays in the program's Status Bar. See "The Status Bar" on page 29.

A selected library item can be modified in a number of ways to help meet your organizational needs.

Renaming Library Items

Only folders and objects in the User Catalog can be renamed. There are several ways to do this from the tree list:

- Right-click on the item, select **Rename** from the contextual menu, and type a new name.
- Click once on the item, press F2 on your keyboard and type a new name.
- Click once on the item, pause for a moment, then click a second time and type a new name.

Library names are case-sensitive and can contain up to 63 characters. While you can

have more than one library item that uses the same name, it is best to use short, descriptive and unique names.

Moving Library Items

Folders and objects in the User Catalog can be moved to new locations within the User Catalog. Folders and library objects are always organized alphabetically within each hierarchy.

To move an item to a different location, select it in the tree list, then click and drag it to the new location in the list. Directories and folders able to accept new content highlight as your mouse pointer moves over them. Release the mouse button to relocate the selected library item in the highlighted location.

You can also cut a library item from one location and paste it in another. When an item is cut, it is removed from its current location and saved to the system clipboard. To cut an item:

- Right-click on it and select **Cut** from the contextual menu.
- Click on the library item and press **Ctrl + X** on your keyboard.

To **Paste** the item, click on a library catalog or folder in the Library Browser tree view and either:

- Right-click on the new location and select **Paste** from the contextual menu.
- Press **Ctrl + V** on your keyboard.

Copying Library Items

All library folders and library objects can be copied and pasted to new locations in the User Catalog.

There are two ways to copy a library item to the system clipboard:

- Right-click on it and select **Copy** from the contextual menu.
- Click on the library item and press Ctrl + C on your keyboard.

To **Paste** the item, click on a library catalog or folder in the Library Browser tree view and either:

- Right-click on the new location and select **Paste** from the contextual menu.
- Press Ctrl + V on your keyboard.

When a library item is copied and pasted, the new item that results is independent of the original item. If you make changes to it, the original item is unaffected. Similarly, changes to the original item do not affect the copy.

Library Shortcuts

In addition to copying and pasting to create new, independent library items, you can copy and paste to create Library Shortcuts. Library Shortcuts are not independent items - they are linked to the original item and are affected if changes are made to the original.

Library Shortcuts are advantageous because you can place a given library item in multiple locations to suit your organizational style without increasing the size of the library database and without having to maintain multiple copies of the same item.

To create a Library Shortcut, copy a library item to the system clipboard. Then, right-click on the location where you would like to create a copy and select **Paste Shortcut** from the contextual menu. Library Shortcuts use

the same name as their source item but use the Library Shortcut  icon.

To locate a Library Shortcut's source item, right-click on it in the tree list and select **Locate Shortcut Source**

If you move or delete an item from the library, any shortcuts to it will not be updated or removed. If you try to use a “hanging” shortcut, a message about its status will display in the library preview panes.

Deleting Library Items

The five installed library categories: Home Designer Core Catalogs, Home Designer Bonus Catalogs, Manufacturer Catalogs, User Catalog, and Trash cannot be deleted.

Catalog level folders in all categories can be deleted; however, individual subfolders and objects can only be deleted out of the User Catalog.

Items in the library that are eligible for deletion can be deleted in either of two ways:

- Right-click on it and choose **Delete** from the contextual menu.
- Select it and press the **Delete** key on your keyboard.

When items from the User Catalog are deleted, they are moved to the Library

Browser Trash . Items in the Trash can be retrieved by clicking and dragging them into any location in the User Catalog.

To empty the Trash , right-click on it and select **Empty Trash** from the contextual menu.

Depending on how much content is in the Trash, emptying it can be time consuming.

You can click the **Cancel** button to end the process if you wish.



The Empty Trash command is both immediate and permanent. It cannot be undone, so use care when using it. You should back up all your library files regularly. See “Backing up Library Content” on page 335.

Exporting Library Catalogs

Exporting library files allows you to:

- Back up your custom library content.
- Transfer library content between computers.

Exporting is often preferable to simply copying library files because it allows you to include images and textures in the exported library.

To export content from the library

1. Locate an object, folder, or catalog that you want to export, right click on it, and select **Export Library**.
2. In the **Export Library Data** dialog.

- Choose the appropriate **Save in:** location for your exported library file.
- Type a short, descriptive name for your library file in the **File Name** field.
- Click the **Save as type:** drop down list and select whether or not you want the library to include Textures/Images.



If any of the items being exported are images or use textures, be sure to select the .calibz file type.

- Click **Save**.
3. Your exported library file can now be copied to a network location or storage device in an operating system window.

Placing Library Objects

Library objects are subject to placement restrictions based upon typical real-life placement. Most library objects require sufficient free space at the location where they are placed, for example, and some library objects have additional requirements.

Library windows and doors, for example, must be placed in a wall just like standard windows and doors, and some fixtures are designed to be placed in cabinets.

If a warning message displays when placing a library object, it will indicate where the object can be placed.

There are three main categories of items available in the Library Browser:

- Stand-alone objects that can be placed directly into a plan. Examples include cabinet modules, furnishings and images.

- 3D objects designed to be inserted into another 3D object. Examples include cabinet fixtures, windows and doors. Some items, such as cabinet doors and fixtures, can be inserted into another object or placed as stand-alone objects.
- Materials, which cannot stand alone and must be assigned or applied to another object.

Stand-Alone Objects

Most library categories contain objects that can be selected in the Library Browser and placed directly in a 2D or 3D view.

- Most stand-alone objects are designed to rest on the floor.
- Some objects will rest on top of a cabinet, shelf, furniture or roof plane object if one is located at the point where they are first placed.
- A few objects, notably some light fixtures, will mount on the bottom of a wall cabinet or on the ceiling.
- In addition, some objects will attach to a wall if one is nearby.

To place a stand alone library object

1. Click on an object in the tree view or Selection Pane of the Library Browser to select it for placement. See “The Library Browser” on page 330.
2. Move your mouse pointer into the view area and notice that it displays an icon indicating the type of object selected instead of an arrow.
3. Click to place the selected object at that location.

4. Continue clicking to place as many instances of the selected object as needed. When you are finished, click the **Select Objects**  button.

Once a stand-alone object has been placed, it can be edited in a variety of ways. See “Editing Library Objects” on page 346.

Inserted Objects

Some objects cannot stand alone and must be placed into other objects in a plan. For example, doors and windows must be inserted into a wall, while some appliances and plumbing fixtures are designed to be placed inside a base cabinet. See “Doors” on page 209, “Windows” on page 225 and “Cabinets” on page 247.

An inserted object can only display in a 2D or 3D view if the object that contains it is set to display. This is the case even if the inserted object’s layer is turned on. See “Displaying Library Objects” on page 345.

To insert a library object

1. Click on an object in the tree view or Selection Pane of the Library Browser to select it for placement. See “The Library Browser” on page 330.
2. Move your pointer into the drawing area.
3. Click on the object into which you wish to insert the selected library item. The library item is inserted into the object.
4. Continue clicking to place as many instances of the selected item as needed. When you are finished, click the **Select Objects**  button.

When an object has been inserted into another object, it can be replaced directly from the library. See “Replace From Library” on page 344.

Assigned Items

Some library items, such as materials, are not objects in themselves but can be applied to objects in a variety of ways.

- Using the specification dialog of the containing object. See “Select Library Object Dialog” on page 344.
- By selecting the item in the library and then clicking on the containing object.
- Materials can be assigned to objects directly from the library in 3D views or by selecting the material and then clicking on an object’s surface. See “The Material Painter” on page 363.

Select Library Object Dialog

The **Select Library Object** dialog is a modal version of the Library Browser that is accessible from object specification dialogs. See “Specification Dialogs” on page 28.

The **Select Library Object** dialog only displays categories of items that are related to the selected object. For example, if the

dialog is accessed from the GENERAL panel of the **Door Specification** dialog, only door symbols will be listed:

The **Select Library Object** dialog is similar to the LIBRARY MATERIALS panel of the **Select Material** dialog. See “Select Material Dialog” on page 367.

Replace From Library

There are two different ways to replace an object in a plan with another object from the library.

In 3D views, an inserted object can be replaced by a different item from the library with a single click. See “Inserted Objects” on page 343.

To replace an inserted object

1. Open the Library Browser, and browse to an object of a type similar to the one you wish to replace.
2. Select the object and move the mouse pointer into the 3D view window.

3. The Replace from Library  icon will display near the mouse pointer when it passes over an object that can be replaced by the selection from the library.
4. Click once to replace the object in the plan with the selected object from the library.

Some types of inserted objects - notably, doors and cabinet doors and drawers - can also be replaced in this manner in floor plan view. The Replace from Library  icon does not display in floor plan view, however.

 The **Replace From Library** edit button is available for nearly any stand-alone object that can be added to the library and can be used in 2D and 3D views. Click this button to open the **Replace From Library** dialog and replace the selected object, and others like it if you choose, with an object of the same type from the library.

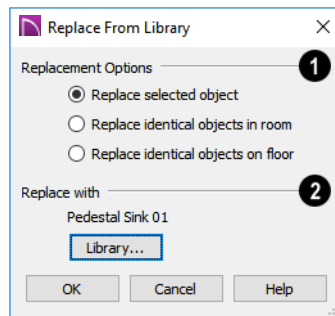

- 1** Select one of the **Replacement Options**.
 - Select **Replace Selected Object** to replace only the currently selected object.
 - Select **Replace Identical Objects in Room** to replace all objects that are in the

- same room as, and are identical to, the currently selected object. Not available for doors or windows.
 - Select **Replace Identical Objects on Floor** to replace all objects that are on the same floor as, and are identical to, the currently selected object.
- 2** Click the **Library** button to open the **Select Library Object** dialog and select an object to use as a replacement. The name of the object that is currently selected as a replacement displays above.

Replace From Library  cannot be used to replace a selected cabinet with a cabinet of a larger size. In addition, it is not available for backdrops and items assigned to other objects, such as materials.

 If the Replace from Library edit tool is used to replace an electrical object, any Connect Electrical splines attached to it will be deleted. See “Connect Electrical” on page 268.

Displaying Library Objects

The display options available for library objects depend on the type of object in question, as well as the view.

If the display of an object is turned off in a 2D or 3D view, any objects inserted into it will not display in that view, either - even if the inserted object’s layer is turned on. See “Inserted Objects” on page 343.

In Floor Plan View

All library objects except materials, doors and drawers applied to cabinets, and backdrops can display in floor plan view. Library objects are represented in floor plan view by 2D symbols that resemble the size and shape of the object when viewed from above.

As with other architectural objects, the display of library objects is controlled by layer in the **Display Options** dialog. Each

library category has its own layer. See “Display Options Dialog” on page 88.

Like other objects, each library symbol is placed in a Drawing Group that affects whether it displays in front of or behind other objects. You can modify a selected symbol’s place in the drawing order by clicking the

View Drawing Group Edit Tools  edit button. See “Drawing Group Edit Tools” on page 86.

Object Labels

Fixtures, Furnishings, Geometric Shapes, Hardware, Millwork and Plants can display

labels in floor plan view when the appropriate layer is set to display in the **Display Options** dialog. For example, fixture labels are placed on the “Fixtures, Labels” layer.

In 3D Views

All library objects can display in 3D views.

By default, images rotate to face the camera in 3D views. For information about turning off image rotation, see “Image Specification Dialog” on page 408.

Editing Library Objects

Like native Home Designer Interiors objects, library objects can be customized to suit your design needs. There are three approaches to editing library objects:



- Select an object in the User Catalog, edit it using any of the options in its contextual menu, and your changes will be reflected when you next place this library object in a drawing.
- Place an object in a drawing and then edit it using the various edit tools available for it. This will not affect the original object still saved in the library.
- Place an object in a drawing, edit it using the available edit tools, and then add it back to the library for future use. This will not replace the original object still saved in the library. See “Add to Library” on page 338.

Library objects placed in a drawing can be selected individually or as a group, like other

objects in Home Designer Interiors. See “Selecting Objects” on page 92.

Once selected, library objects can be edited in a variety of ways using dimensions, the edit handles, the edit toolbar buttons and the specification dialog. See “Symbol Object Specification Dialogs” on page 347.

Native Objects vs Symbols

In Home Designer Interiors, objects created using the program’s standard tools, such as the **Door Tools**  and **Cabinet Tools** , are referred to as native objects.

On the other hand, objects placed from the library, such as fixtures and furnishings, are symbols. Symbols are typically more limited than native objects in how they can be edited.

Any changes made to objects like fixtures and furniture will not be reflected in their Materials List Description, although they

may be seen in other columns, such as Size. See “Materials Lists” on page 427.

Using Edit Handles

Most library symbols are box-based objects and can be edited as such once placed in a drawing. See “Editing Box-Based Objects” on page 104. Depending on the type of view and the surface selected, the edit handles a symbol displays will vary.

When a furnishing or fixture symbol is selected in floor plan view or on the top

surface in a 3D view, up to ten edit handles display. They are the Move handle at the center, the Rotate handle just outside the front indicator (a V) and a Resize handle on each edge and at each corner.

When a symbol is selected on a side in a 3D view, it displays five edit handles: the Move handle and a Resize handle on each edge.

Fixtures and furniture placed in a plan are subject to bumping/pushing behavior when moved. See “Bumping/Pushing” on page 110.

Symbol Object Specification Dialogs



The **Fixture, Furniture, Geometric Shape** and **Millwork Specification** dialogs all feature the same options. The actual name of the dialog is determined by the type of object that is currently selected.

For example, selecting a library object placed from the Interiors Core Catalog and clicking the **Open Object**  edit button opens the **Furniture Specification** dialog.

General Panel

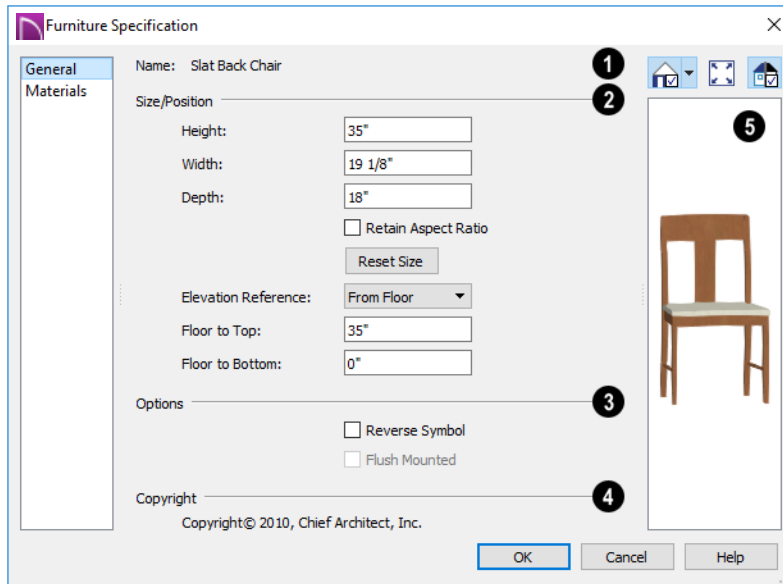

1 The **Name** of the selected symbol object displays here.

2 **Size/Position -**

- Specify the **Height, Width, and Depth** of the object.
- Check **Retain Aspect Ratio** to maintain the ratio between the object's Height, Width, and Depth when it is resized in the specification dialog. Does not affect the behavior of the object's edit handles.
- Click **Reset Size** to reset the symbol's original, unmodified size. The symbol's elevation is not affected by this option.
- Select the **Elevation Reference** from the drop-down list. This determines where the next two settings are measured from and also affects their setting labels.

- Specify the height **to Top**, measured from the selected Elevation Reference to the top of the object.

- Specify the height **to Bottom**, measured from the selected Elevation Reference to the bottom of the object.

3 **Options -**

Check **Reverse Symbol** to reverse the object's appearance, so that features on its left are positioned on its right, and vice versa. This turns a right-hand refrigerator, for example, into a left-hand refrigerator. This option has no effect on objects that are symmetrical.

- Check **Flush Mounted** to specify that the selected object follow the pitch of either the ceiling or roof. Only available when "From Ceiling" or "From Roof" is

selected as the Elevation Reference, above.

- 4 If the selected object has a **Copyright**, information about it displays here.
- 5 A preview of the selected library object displays here and updates with changes. If the selected symbol is inserted into another object, such as an appliance in a cabinet, the parent object will also display. See “Dialog Preview Panes” on page 28.

Materials Panel

For information about the settings on this tab, see “Materials Panel” on page 366.

Manufacturer Panel

The MANUFACTURER panel provides contact information for the selected object’s manufacturer. Only available for symbols from Manufacturer library catalogs. See “Manufacturer Catalogs” on page 335.

Architectural Blocks

A selection of pre-arranged rooms library catalogs is available for download. These pre-arranged rooms are a collection of fixtures, furnishings and accessories that are grouped together so that they can be placed and moved as a single object. See “Downloading Library Content” on page 336.

3D objects that are grouped together like this are referred to as Architectural Blocks. Although blocked together, these objects retain many of their own attributes, such as materials.

Architectural blocks can also be exploded so that the individual sub-objects become independent of one another.

Chapter Contents

- Displaying Architectural Blocks
- Editing Architectural Blocks
- Architectural Blocks and Sub-Objects

Displaying Architectural Blocks



As with individual objects, the display of architectural blocks is controlled in the **Display Options** dialog. See “Displaying Objects” on page 87.

- If an architectural block is composed of objects that are on the same layer, the block will be placed on that layer, as well.

- If an architectural block is composed of objects on different layers, the block will be placed on the “Architectural Blocks” layer.

Editing Architectural Blocks

Architectural blocks can be selected and edited in 2D and 3D views. See “Selecting Objects” on page 92.

Once selected, an architectural block can be edited using its edit handles and edit toolbar buttons.

Using the Edit Handles

A selected architectural block displays a Move handle and a Rotate handle.

Architectural blocks cannot be resized, but the individual objects in the block can be.

Using the Edit Tools

A selected architectural block or blocks can be edited in a variety of ways using the buttons on the edit toolbar. See “The Edit Toolbar” on page 24.

Editing Sub-Objects

The individual objects included in an architectural block can also be selected and edited. See “To select a sub-object” on page 353.

Explode Architectural Block



You can break an architectural block to make its objects independent.

Select the architectural block and click the **Explode Architectural Block** edit button.

Note: If you open a plan created in another version of Home Designer and an architectural block includes an object that you cannot create in your version of the software, you cannot unblock it or edit its components.

Once exploded, an architectural block cannot be made into a single object again.

Architectural Blocks and Sub-Objects



An architectural block is composed of a group of sub-objects that have been blocked together. For example, a kitchen island

architectural block may consist of cabinets, appliances, and other accessories.



Each of the sub-objects in an architectural block may contain additional parts called components. The cabinets in a kitchen island, for example, may contain handles, hinges, and drawer glide.

Sub-Objects

Certain attributes of an architectural block can be edited at the sub-object level. A sub-object can be edited by accessing its specification dialog in either of two ways:

- Explode the architectural block, select the sub-object, and click the **Open Object**  edit button.
- Select the sub-object while it is part of the architectural block and click the **Open Object**  edit button. Some attributes may not be editable while the object is part of a block. See “Editing Architectural Blocks” on page 352.

To select a sub-object

1. Click the **Select Objects**  button, then click on the sub-object that you would like to edit.
2. With the architectural block selected, click the **Select Next Object**  edit button or press the Tab key.

The selection switches to the individual object and it can be edited using its edit handles, edit toolbar and specification dialog.

The options for editing a sub-object may be more restricted than if the object were independent. If more extensive editing is required, the architectural block must be exploded.

Other Objects

Home Designer Interiors has additional objects that can be used to customize your design.

Chapter Contents

- General Shapes
- Soffits
- Special Applications for Soffits
- Soffit Specification Dialog

General Shapes



Items in the Home Designer Core Catalogs> Shapes library catalog allow you to create a variety of custom objects using basic geometric shapes. These shapes can be used individually or

combined to create a wide variety of custom objects.

General Shape objects are placed and edited much like other library objects. See “Editing Box-Based Objects” on page 104.

Soffits



Soffits typically fill the space between the tops of wall cabinets and the ceiling, but they are very versatile and can be used to create almost any other object that can be modeled as a 3D box. Select **Build> Cabinet> Soffit** to activate this tool.

Soffit Defaults

The default settings for soffits are set in the **Soffit Defaults** dialog. The settings in this dialog are similar to those in the **Soffit Specification** dialog. See “Soffit Specification Dialog” on page 358.

For best results when placing soffits above wall cabinets:

- The default soffit should be the same width as and 1" (20mm) deeper than the default wall cabinet. See "Cabinet Defaults" on page 248.
- The default soffit **Floor to Bottom** value should equal the sum of the default wall cabinet's Floor to Bottom value plus its Height. See "General Panel" on page 358.
- The default soffit **Height** should be equal to or greater than the space between the ceiling and the top of the wall cabinets.

If the sum of the default soffit's Floor to Bottom value and Height is larger than the ceiling height of the room in which a soffit is placed, the Floor to Bottom value will be retained and its Height will be adjusted so that it fits under the ceiling.

The maximum soffit width is 250 feet (48m), and the minimum width is 1/16" (1 mm).

Once a soffit is placed in a plan, you can change its size and position to meet a variety of needs.

Placing Soffits

Soffits can be created in both 2D and 3D views by simply clicking with the **Soffit**  tool active. See "Click-to-Crete" on page 80.

They can be assigned materials that are calculated in the Materials List, but by default they use the material assigned to the default wall. See "Wall Defaults" on page 134.

When positioned against a wall in a room, soffits will display any moldings present in that room that are at the same height as the soffit. See "Moldings Panel" on page 180.

To create a corner soffit, click as close to an inside wall corner as possible. A corner soffit retains its shape when it is moved, edited, or copied.

When a soffit is created, it is placed on the "Cabinets, Soffits" layer. See "Displaying Objects" on page 87.

Special Applications for Soffits

Nearly any object with straight, flat sides can be represented by one or more Soffits. They can be resized to as small as 1/16" (1mm) per side, or as large as 250 feet (48m).

Soffits can have materials applied to them to represent simple mirrors, posts, chimneys and so on. Following are some additional examples.

Coffered Ceilings

Soffits can be used to create coffered ceilings. They will display any moldings assigned to the room it is in that are at its height. In addition, you can assign moldings directly to a soffit in its specification dialog. See "Moldings Panel" on page 359.



Accent Tiles

A material such as ceramic tile can be assigned to one or more soffits applied to the walls above tubs or in showers.



Calculating Materials on Soffits

By default, soffit materials are not calculated in the Materials List. In order for a soffit's material to be counted, it must be edited so

that it is not using the default material. See "Material Defaults" on page 362.

The number of bricks, tiles, shingles, shakes or other materials applied to a soffit is calculated using the following rules:

- If the soffit depth is less than the larger of 4 inches (10 mm) or $1 \frac{1}{2}$ times the material thickness, then only the front area of the soffit is used. Thus if a soffit is 48"x48"x4" thick, and the Dark Red brick material is used (3"x 8" with $\frac{3}{8}$ " mortar joint) the front of the soffit is 48"x48"=2304 square inches. Including the mortar joint, each brick requires $3 \frac{3}{8}$ " x $8 \frac{3}{8}$ " = 28.26 square inches. 2304 sq. in. divided by 28.26 sq. in. per brick gives 81.5 bricks.
- If the soffit depth is greater than both 4 inches (10 mm) and $1 \frac{1}{2}$ times the material thickness, then the surface areas of the soffit back, sides and top are used in addition to the front, if these surfaces are not attached to a wall or other soffit. However, only those portions of the sides, top and bottom remaining after subtracting twice the material thickness are used. So, for Dark Red brick, which has a depth of 4", the sides, top and bottom surface areas cannot contribute to the brick count unless the soffit depth is greater than 8 inches.
- If surface materials such as brick are applied to a large soffit, the soffit center is assumed to be hollow, with only a single layer of the material applied to each applicable face.
- For shingles and shakes, the overlap amount should be subtracted from the height, as opposed to brick or tile, where the joint width is added to the size.

- For materials in the area category, the soffit area calculation above is used, with the material thickness treated as zero.
- For materials in the volume, concrete or earth categories, the true volume of the soffit is used.

Soffit Specification Dialog



To open the **Soffit Specification** dialog, select the soffit and click the **Open Object** edit button or double-click on a soffit using the **Soffit**  tool.

The settings in this dialog are similar to those in the **Soffit Defaults** dialog, but affect only the selected object(s).

General Panel

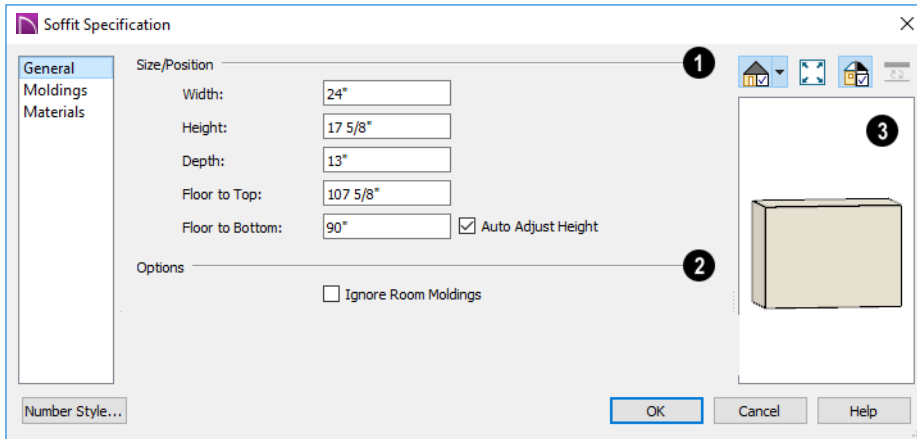

- 1 Define the **Size** and **Position** of the selected soffit relative to the floor.
 - Specify the **Width** of the soffit.
 - Define the vertical **Height** of the soffit.
 - Define the **Depth**, which is the distance between the front and the back of the soffit. When selected in floor plan view, the front of a soffit has a “V,” and the back of the soffit has a triangular rotation handle.
 - If the selected soffit is a corner soffit, the **Width** controls its left side width, and **Depth** controls its right side width.
- **Floor to Bottom** - Specify the distance from the bottom of the soffit to the floor. This is sometimes more easily done by positioning the soffit in a 3D view.
- When the selected soffit is outside a room, its Floor to Bottom height is measured relative to the terrain. Check **Auto Adjust Height** to maintain the same distance above the terrain if the soffit is moved to a location with different terrain height. Uncheck this to maintain the same absolute height regardless of the terrain below. When **Auto Adjust Height**

is checked, the Floor to Bottom value may automatically adjust if the soffit is moved.

- 2 **Options** - Check **Ignore Room Moldings** to prevent the selected soffit from displaying moldings assigned to the room that it is placed in. See “Special Applications for Soffits” on page 356.
- 3 A preview of the soffit displays on the right side of the dialog box. See “Dialog Preview Panes” on page 28.

Moldings Panel

For information about the settings on this panel, see “Moldings Panel” on page 263.

Materials Panel

Soffits are not calculated in the Materials List unless a non-default material is specified. See “Calculating Materials on Soffits” on page 357.

For information about the settings on this panel, see “Materials Panel” on page 366.

Materials

The objects used in Home Designer Interiors have a variety of 3D properties. These objects - walls, windows, doors, cabinets, etc. - can have materials assigned to them so that they look realistic in 3D views. These materials can also be used to generate materials lists that can help with cost estimations.

Designing with objects that look correct in 3D and calculate properly in the Materials List requires that you use realistic material definitions and apply them appropriately to objects in your plan.

Home Designer Interiors comes with many materials that are ready for use. From paint, tile, countertops and wood finishes to carpeting, wall coverings and fabric, Home Designer Interiors has materials for every application. If you cannot find a material that

suits your needs, you can customize the materials provided or create your own.



Redefining only the visual properties of a material may create unexpected results. For example, changing the image of a brick material to represent siding does not cause the material to be considered as siding during material calculations.

Chapter Contents

- About Materials
- Material Defaults
- The Material Painter
- Materials Panel
- Select Material Dialog
- Editing Materials
- Creating Materials
- Define Material Dialog
- Select Color Dialog

About Materials

The materials that are assigned to objects in Home Designer Interiors perform two

important roles:

- They determine what the surfaces of objects look like in 3D views.
- They influence how objects are calculated in the Materials List. See “Materials Lists” on page 427.

Materials are stored in the Materials catalog in the Library Browser and can be applied to objects in either of two ways:

- Using the **Material Painter** .
- In an object’s specification dialog. See “Materials Panel” on page 366.

Textures

In Home Designer Interiors, materials have textures associated with them that determine how they look in 3D views.

Textures are created using special image files that tile seamlessly when applied to surfaces.

In 3D views, you can turn the display of textures on and off by selecting **3D> Render**

View Options> Toggle Textures . When textures are turned off, as well as in Technical Illustration renderings, materials are represented using solid colors. See “Rendering Techniques” on page 398.

Material Defaults



Most objects in the program have defaults dialogs which allow you to set up a variety of attributes, including materials, before the objects are created. These defaults dialogs are accessed by selecting **Edit> Default Settings**. See “Preferences and Default Settings” on page 53.

The **Material Defaults** dialog serves two purposes. It allows you to:

- Set the default materials for objects that do not have a defaults dialog. Fireplaces and furnishings from the library are examples of objects that do not have a defaults dialog.
- Set the initial materials that can then populate a variety of defaults dialogs for objects that do have them. **Door**, **Window**, and **Cabinet Defaults** are examples of defaults dialogs that can draw their material assignments from the **Material Defaults** dialog.

Material defaults are dynamic, which means that if you change a particular material in a defaults dialog, all objects of that type that are set to use that default will automatically update to use the new material. See “Dynamic Defaults” on page 55.

Because material defaults are Dynamic Defaults, you can use the **Material Defaults** dialog to apply a material to multiple objects that share similar components. For example:

- The “Room Moldings” Material Default applies to the base, crown, and chair rail moldings that can be assigned to rooms, as well as to interior door and window casing. If you change this Material Default, all of these objects in the plan can be affected.
- The “Cabinet”, “Cabinet Door/Drawer”, “Countertop”, and “Hardware” Material Defaults can be used in your **Cabinet Defaults** dialogs to ensure that all cabinets use the same materials.

Material Defaults Dialog

Select **Edit > Default Settings**  from the menu, select “Materials”, and click the **Edit** button to open the **Material Defaults** dialog.

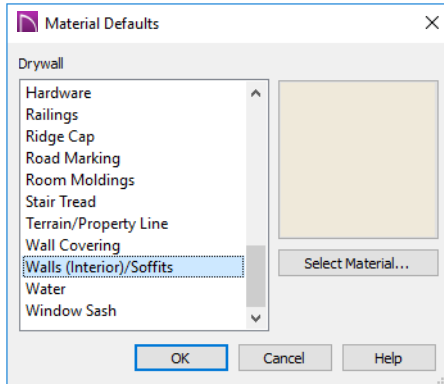

- Select a category from the scrollable list.
- Click the **Select Material** button or material preview box to open the **Select Material** dialog. See “Select Material Dialog” on page 367.

The Material Painter





Select **3D > Material Painter** to access the **Material Painter Tools**, which are used to apply materials to object surfaces in 3D views. The **Material Painter** tool can also be activated by selecting a material in the library while a 3D view is active. The Material Painter tools are not available in Glass House views. See “Glass House” on page 399.



Material Painter Modes

There are five Material Painter Modes. Each mode specifies how broadly or narrowly the selected material will be applied to surfaces in your plan.

- The **Material Painter Component Mode**  is the default mode and applies the selected material to an object component.

For most types of objects, using this tool is the same as opening an object’s specification dialog and changing the material of one of its components on the MATERIALS panel. See “Materials Panel” on page 366.

- The **Material Painter Object Mode**  applies a material to all components of an object that share the same material assignment.
- The **Material Painter Room Mode**  applies a material to all the objects in the room that currently have the same material. For example, if you apply a material to a dining room chair, this mode applies the material to all other objects in the room with the same original material, such as other chairs and the dining table.

- The **Material Painter Floor Mode**  applies the selected material to all surfaces on the floor that currently have the same material. For example, if you apply a material to the kitchen countertops using this mode, the bathroom countertops on the same floor also have the material applied.
- The **Material Painter Plan Mode**  applies the selected material to all surfaces in the entire plan that currently have the same material. For example, if you have the same carpet on all floors in a plan, applying a selected material while this mode is active will change all carpet on all floors.

When the **Material Painter**  tool is active, the Material Painter Mode toolbar buttons display in the edit toolbar, allowing you to quickly change modes.



You can also specify the active mode by selecting **3D> Material Painter**. A check displays next to the active mode in the submenu.

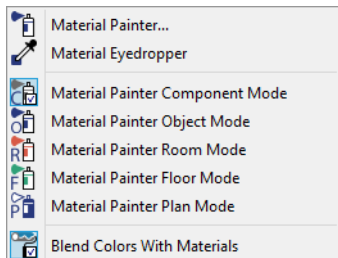









Blend Colors With Materials

 In addition to the Material Painter Modes, the **Blend Colors With Materials** option allows you to apply a solid color to a surface displaying a pattern and blend the two.

Blend Colors With Materials  works in all five Material Painter Modes. See “Blending Materials” on page 370.



To use the Material Painter tool

1. Create a 3D view in which the patterned material is visible.
2. Select **3D> Material Painter> Material Painter** .
3. Select a solid color material from the **Select Library Object** dialog. See “Select Library Object Dialog” on page 344.
 - Check **Use Default Material** at the bottom left of the dialog to apply the default material to any object that has a defaults dialog. See “Material Defaults” on page 362.
4. Select a Material Painter Mode from the edit toolbar, which displays on the left side of the program window when the Material Painter is enabled.
5. Click the **Blend Colors With Textures**  edit button to turn this feature on or off depending on your needs.
6. Note that the name of the material being painted displays on the left side of the Status Bar at the bottom of the program window. See “The Status Bar” on page 29.



- Move your pointer over a surface in the 3D view. The Status Bar now states both the material being painted and the current material on the target surface.
7. Click on the surface to apply the selected material to that surface. The material is applied to surfaces in the model based on the active Material Painter Mode.
 - When both the **Material Painter**  and **Blend Colors With Textures** are active, the cursor displays a paint roller icon .
 - When the **Material Painter**  is active and **Blend Colors With Textures**  is not, the cursor displays a spray can icon .
 8. If either the **Component**  or **Object Mode**  is active, you can continue to click on surfaces to apply the selected material. When you are finished, select a different tool.

Material Painter and Walls

Painting walls is an obvious use for the **Material Painter** ; however, it is important to note that the Material Painter Modes affect walls and rooms somewhat differently than they do other objects: particularly if a wall defines multiple rooms on the side that is being painted.

- **Component**  and **Object Modes**  only paint the section of the wall that defines the room located where you click to apply a new material. Sections of the

same wall that define other rooms are unaffected.



- **Room Mode**  applies the material to all walls and solid railings that define the room where you click provided that they have the same original surface material as the one being painted. Any other objects in the room with that original material are also affected, but railings are not unless they are specified as Solid.
- **Floor**  and **Plan Modes**  apply the material to all walls, all railings, and any other objects with the same original surface material as the one being painted: either on the current floor, or throughout the plan.

Note: Wall materials applied using the Material Painter tool are not calculated in the Materials List.

Material Eyedropper



The **Material Eyedropper** tool allows you to load the material assigned to an existing object and apply that material to other objects.

In a 3D view, select **3D > Material Painter > Material Eyedropper**  and then move your mouse pointer over a surface in the view. The name of the material on that surface is stated on the left side of the Status Bar. Click on the surface to load its material assignment. The pointer then changes to indicate that the material is ready to be applied to another object using the **Material Painter**  tool. Depending on the currently active **Material Painter Mode**, you can

continue to apply the material to the surfaces of other objects.

Materials Panel

The specification dialogs for most objects include a MATERIALS panel. Select an object and click the **Open Object**  edit button to open the specification dialog for that selection.

On the MATERIALS panel, you can specify material assignments for the components that make up that object. When a new material is

assigned, the appearance of the preview image on the right side of the dialog updates.

If the selected object is using a material that is missing its texture, a Caution  symbol will display next to the Materials panel name in the list on the left side of the object's specification dialog. See "Referenced Files" on page 46.

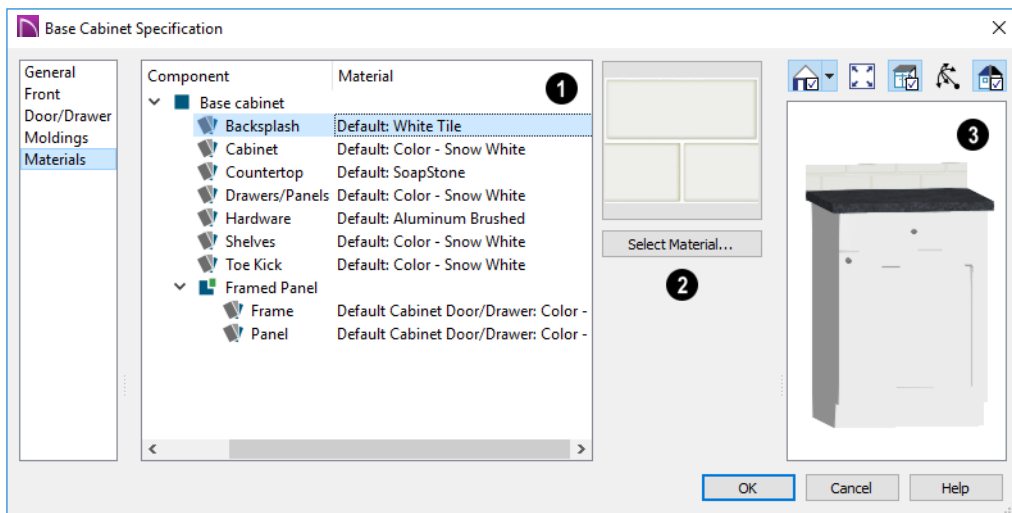

1 The table on the left side of the panel lists the components of the selected object that can be assigned unique materials, along with the names of those materials and whether or not the default materials are used. Some objects may have only one component while more complex objects may have many. As changes are made to the selected object,

components may be added to or removed from this table.

- Click on a Component in the table to select it. Multiple line items can be added to the selection set by holding down the Shift or Ctrl key. See "Shift and Ctrl Select" on page 93.
- The selected component's Material is stated in the list, to the right of the com-

ponent name. If the component is using the default material, the name will be preceded by the word “Default:”. If it is using a Material Default, it will be preceded by the word “Default” followed by the name of an object type. See “Material Defaults” on page 362.

Note: If the selected object is a wall or a room modified using the Material Painter, a component’s Material may be described as “No Change”. See “Material Painter and Walls” on page 365.

- 2 The box to the right of the table displays a preview of the material assigned to the selected component. If “No

Texture” displays in the preview window, the material has no texture assigned to it; if a

Caution  symbol and the words, “Texture Missing” display, the texture file could not be found on the system.

- Click **Select Material** to open the **Select Material** dialog. Choose a material and click **OK** to assign that material to the selected component. See “Select Material Dialog” on page 367.

- 3 A preview of the selected object displays on the right side of the panel. To view material textures, select **Standard** as the View Type. See “Dialog Preview Panes” on page 28.

Select Material Dialog

The **Select Material** dialog allows you to select a material to apply to one or more objects and is opened by clicking the **Select Material** button on the MATERIALS panel of most specification dialogs or by using the **Material Painter** . See “Materials Panel”

on page 366 and “The Material Painter” on page 363.

Most of the time, the **Select Material** dialog has a single panel; however, if a component of a library symbol is selected in an object specification dialog, two panels will be present.

Library Materials Panel

The LIBRARY MATERIALS panel is a modal version of the Library Browser that lists only materials. See “The Library Browser” on page 330.

The settings on this panel are also found in the **Select Library Object** dialog. See “Select Library Object Dialog” on page 344.

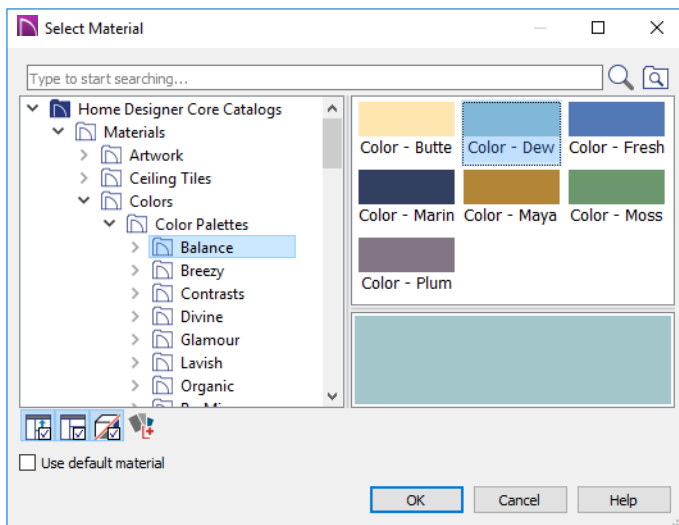

The **LIBRARY MATERIALS** panel has most of the functionality that the Library Browser has: including the search, the toggleable, resizable Preview and Selection Panes, and the **Toggle Preview Display** button.

- To locate a material, either search using keywords or browse the tree list. See “Searching the Library” on page 333.
- To apply a material to an object, either click on the material and click **OK** or double-click on the item in the Selection Pane.
- Click the **Add New Material** button to open the **Define Material** dialog and create a new material saved in the user

Catalog. See “Define Material Dialog” on page 370.

- Check **Use default material** to apply the default material to the selected object, if one exists. See “Material Defaults” on page 362.

Material Defaults Panel

The **MATERIAL DEFAULTS** panel will only be present if the **Select Material** dialog was accessed via an object specification dialog where a component of a library symbol was selected.

Rather than apply a specific material to the selected component, you can dynamically associate it with a Material Default category. See “Material Defaults” on page 362.

Editing Materials

Much like objects, materials in Home Designer Interiors can be edited so that they better suit your design needs. There are two approaches to material editing:

- Select a material in an unlocked library in the Library Browser, edit it, and your changes will be used when you next use the material in any plan. Changes made in this manner do not affect materials already in use in a plan.
- Apply a material to an object in a plan and then edit that applied material using the

Adjust Material Definition  tool. Changes made in this way will affect any instances of that material in the current plan only.

Editing the material applied to an object is not the same as applying a different material to that object. See “The Material Painter” on page 363.

Library Browser

Right-click on a material in an unlocked library and select **Open** from the contextual menu to open the **Define Material** dialog for that material. See “Define Material Dialog” on page 370.

Adjust Material Definition



The **Adjust Material Definition** tool is useful for changing plan materials directly from a 3D view.

Select **3D> Materials> Adjust Material**

Definition  and then click any surface in a 3D view to modify the material currently assigned to that surface in the **Define Material** dialog. See “Define Material Dialog” on page 370.

Changing a material definition with this tool affects all objects in the current plan that are using that material but does not affect any materials saved in the library or materials used in other plans. See “Adding Library Content” on page 338.

Creating Materials

Home Designer Interiors provides a wide variety of materials - including numerous name brand material catalogs - that are ready to download and use. If you cannot find a suitable material, you can edit an existing material or create a new one. See “Editing Materials” on page 369.

Note: Adding a material to a plan is not the same as adding it to the library. If you want a new material to be available for use in other plans, create it in the Library Browser.

In the Library Browser

Materials can be created in the Library Browser, making them available for use in

any plan. See “Adding Library Content” on page 338.

In the directory pane of the Library Browser, right-click on an unlocked folder and select

New> Material  from the contextual menu. See “Using the Contextual Menus” on page 332.

The **Define Material** dialog opens, allowing you to specify the new material’s attributes. See “Define Material Dialog” on page 370.

Blending Materials



In 3D views, you can create a new material by blending a solid color such as a paint color with a textured material. Select **3D> Material Painter> Blend Colors With Materials** to toggle this feature on or off. See “Blend Colors With Materials” on page 364.

The result is a new material that is saved in the current plan.

Materials created using the **Blend Colors With Materials**  tool are given the name of the patterned/textured material with the

extension “--PAINTED:” followed by the name of the solid color material.

Component	Material
Base cabinet	
Backsplash	Default: White Tile
Cabinet	Rustic Hickory--PAINTED: Color - Chocolate

Stretch to Fit

Some special textures, often used for artwork, stretch across any surfaces that they are applied to. Materials that behave this way are specified as **Stretch to Fit** in the **Define Material** dialog.

To display an artwork texture, first place a wall or desk frame in your plan. A selection of both are available in the library. See “Placing Library Objects” on page 342.

Next, simply apply a material specified as **Stretch to Fit** to the center portion of the frame. See “The Material Painter” on page 363.

For more information about creating and using custom materials, see “Materials Tutorial” on page 115 of the User’s Guide.

Define Material Dialog

The **Define Material** dialog allows you to adjust how materials look in 3D views and can be accessed in a number of ways:

- Use the **Adjust Material Definition**  tool. See “Adjust Material Definition” on page 369.
- Right-click on a material in an unlocked library in the Library Browser and select **Open** from the contextual menu. See

“Using the Contextual Menus” on page 332.

- You can also right-click on an unlocked library and select **New> Material**.

Manufacturer Panel

If the selected material was copied from the Manufacturer library category, the MANU-

FACTURER panel lists contact information.
See “Manufacturer Catalogs” on page 335.

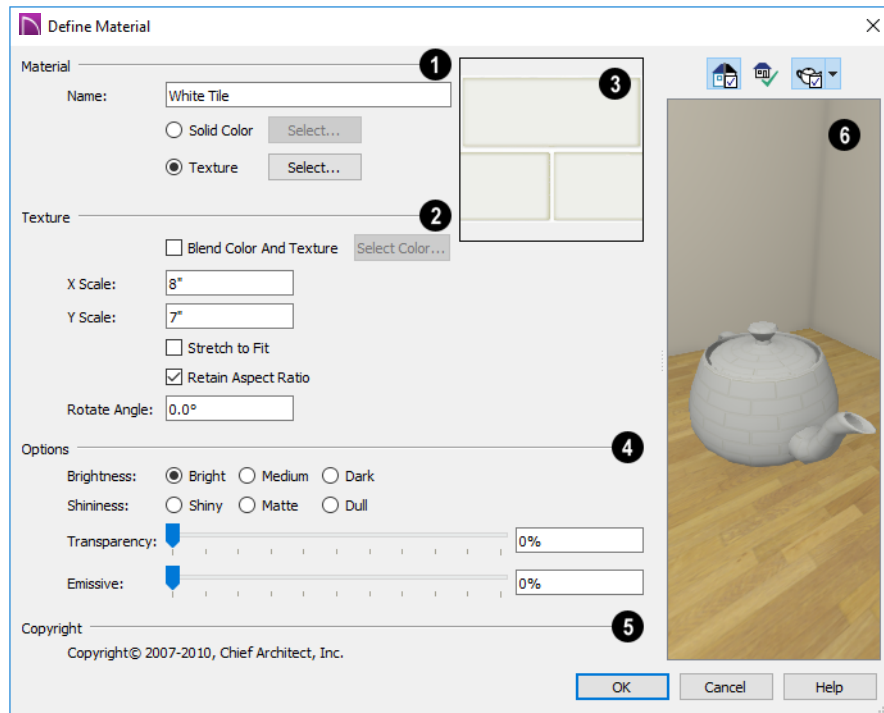

- 1 The **Material Name** displays here. In this field, you can type a new name if you wish. Renaming the material does not create a new material: it redefines the existing material in the current plan.
 - Click the **Solid Color** radio button to specify the material as a solid color, then click the **Select** button to open the **Select Color** dialog and select a new color. See “Select Color Dialog” on page 372.
 - Click the **Texture** radio button to specify a texture for the material instead of a solid color, then click the **Select** button to open the **Select Texture File** dialog, a standard Open File dialog, and specify an image

saved on your computer to serve as the texture.

- 2 The **Texture Options** are only enabled when Texture is selected, above.
 - Check **Blend Color and Texture** to blend the selected texture with a solid color, then click the **Select Color** button to specify the color you would like to blend it with. When a new material is created using the **Blends Color With Materials**  tool, the resulting material has this box checked. See “Blend Colors With Materials” on page 364.

- Specify the **X** and **Y Scale** for the chosen texture in inches (mm). If you specify **x** and **y** values of 30", the pattern repeats every 30 inches in both directions along a surface.
- Check **Stretch to Fit** to stretch the texture image over the entirety of each surface it is applied to. This is useful when you wish to create a painting or photo material to display in a frame. See "Stretch to Fit" on page 370.

Note: Changing the scale or selecting Stretch to Fit can cause textures to appear distorted if they are mapped to a surface using a different aspect ratio than they were originally created with.

- Check Retain Aspect Ratio to maintain the ratio between the texture image's height and width and prevent distortion when either its X or Y Scale value is adjusted.
- **Rotate Angle** - Specify how the texture is rotated on the surface it is applied to.

3 General Options -

- **Brightness** controls how bright the material appears relative to other materials.
 - **Shininess** controls the sheen of the material when it is rendered with a point or spot light source on it. Shiny materials such as metal will reflect light when viewed at the right angle.
 - **Transparency** controls the opacity of the material. A transparency value of 0 results in a completely opaque material, while a value of 100 creates a material that is completely invisible.
 - Use the **Emissive** slider bar or text field to control how bright a material appears independent of the lighting in the scene. It can be used to simulate surfaces that are glowing with their own light, such as the glass on a light fixture.
- 4 Any **Copyright** information about the material displays here.
 - 5 A preview of the selected texture or color displays in the square pane.
 - 6 A preview of the material applied to an object displays here and updates as changes are made to the material definition. Various options allow you to view different aspects of the material's attributes:
 - Zoom and orbit the object in the view.
 - Toggle **Color** on or off.
 - Select an object shape: Cube, Sphere, or Teapot.

Select Color Dialog

The **Select Color** dialog can be opened by clicking on the color bar that can be found in many dialogs throughout the Windows

version of the program. In the Mac version, the standard **Colors** dialog, or Color Picker, is used.

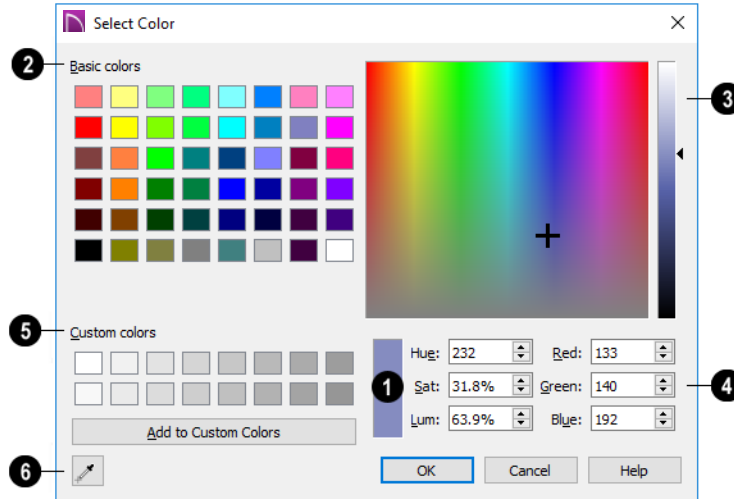

1 The currently selected color displays in the rectangle at the lower center of the dialog. There are a number of ways to select a color in this dialog:

2 Click in any one of the **Basic colors** boxes to select it.

3 Click anywhere in the color spectrum area to select a color.

- The location of the selected color is identified by a crosshairs.
- Click anywhere in the vertical bar or drag the arrow to adjust the selected color's Luminosity and RGB values.

4 Define the color by specifying its **Hue**, **Saturation**, and **Luminosity** (HSL) or its **Red**, **Green**, and **Blue** (RGB) values.

5 Click in one of the **Custom colors** boxes to either select it or to specify it as the box for a new custom color to be defined.

- Click the **Add to Custom Colors** button to add the selected color to the Custom Colors group.

6 Click the **Color Chooser Eyedropper**, then click anywhere on your monitor to select the color displaying at that location.



You can select a color from any program window. Before opening the Color Chooser dialog, make sure the desired color can be seen on screen.

Click OK to apply the currently selected color to the object's line or fill style, or to the material's pattern color.

3D Views

Little preparation is needed to create a 3D view of a model: simply click a button to create an overview or click and drag to create a camera view.

To improve the quality of the rendering and create a custom look, you can adjust lighting and edit the materials used in the plan. You can create Final views that are even more realistic. See “3D Rendering” on page 393.

Many objects can be placed and edited in 3D views, and any camera view or overview can be saved or even used to record a walkthrough. See “Pictures, Images, and Walkthroughs” on page 405.

Chapter Contents

- OpenGL and Hardware
- Backdrop Dialog
- 3D View Tools
- Creating Camera Views
- Creating Overviews
- Displaying 3D Views
- Repositioning Cameras
- Editing 3D Views
- Cross Section Slider
- Working in 3D
- Saving and Printing 3D Views
- Camera Specification Dialog

OpenGL and Hardware

Home Designer Interiors features an easy to use rendering engine that makes use of OpenGL rendering technology, which has good hardware support on most video cards.

To take full advantage of the rendering capabilities of Home Designer Interiors, a graphics card or chipset that supports OpenGL 3.3 on Windows or 4.1 on Mac is required.

Backdrop Dialog



Select **3D > 3D Backdrop** from the menu to open the **3D Backdrop** dialog. This dialog allows you to specify a

solid color or picture file of your choice to use as a background for 3D views. See “3D Backdrops” on page 415.

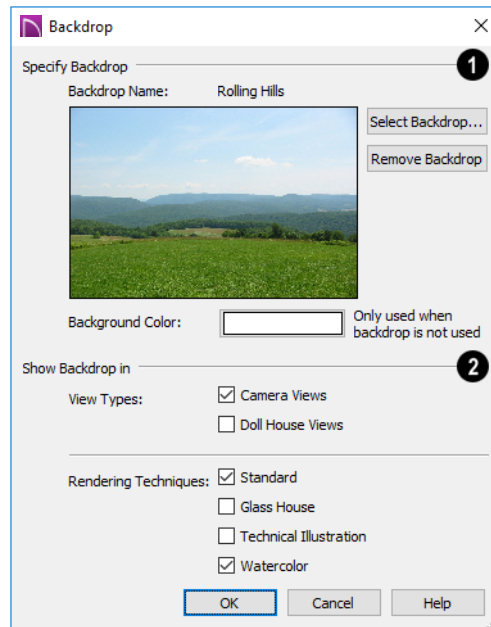

- 1 **Specify Backdrop** -A preview of the selected backdrop image is shown here.
- **Backdrop Name** - The name of the selected backdrop image displays for reference.

- Click **Select Backdrop** to choose a backdrop image from the library. See “Select Library Object Dialog” on page 344.
- Click **Remove Backdrop** to use a solid color instead of a backdrop image in all 3D views, then specify the color below.

- Click the Color bar to select the **Background Color** that displays when a backdrop image is not being used. See “Select Color Dialog” on page 372.
 - Specify in which **View Types** a backdrop image is used. By default, only Camera Views are set to use a backdrop. See “3D View Tools” on page 377.
 - Specify in which **Rendering Techniques** a backdrop image is used. See “Rendering Techniques” on page 398.
- 2** The **Show Backdrop in** options let you specify the conditions under which the selected backdrop image displays.

3D View Tools

Select **3D> Create Camera View** to display the Camera View Tools.

Camera Views



The **Full Camera** tool creates multi-floor views of the 3D model. It can be used to create interior and exterior perspectives, and is good for displaying cathedral ceilings, roofs, lofts, stairwell openings, and other variation in floor and ceiling levels.



The **Floor Camera** tool creates perspective views of the current floor

only. Nothing above the ceiling surface is generated, and neither is anything below the floor.



The **Glass House Camera** tool creates full camera view of the 3D model using the Glass House Rendering Technique. See “Glass House” on page 399.

Overviews



The **Doll House View** tool creates views of the current floor with the ceiling removed and all floors beneath it visible.

Creating Camera Views

All Camera views are created using the same method.

To create a camera view

1. In floor plan view, select the desired camera tool. The mouse pointer displays the camera  icon.
2. Click and drag a line to define the view direction.
 - Where your line begins is the camera’s position.
 - The line that you drag defines the direction the camera is pointed.
 - The end of the line is the focal point of the view, the point the camera rotates around.
 - By default, the field of view is 45°, which is similar to what the human eye sees or a 50mm camera lens.

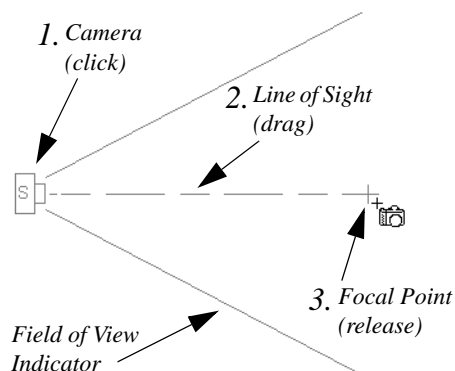

3. When you release the mouse button, a view generates in a new window.
4. Return to the floor plan view. A camera symbol now displays in floor plan view. See “Working in Multiple Views” on page 74.

Camera Height

By default, Cameras are created at a height of 60” (1500 mm). Where this height is measured from depends on the location of the camera:

- If the camera is inside of a room, it is measured from that room’s subfloor.
- If the camera is located outside of a room, it is measured from the default height of the subfloor for the current floor.

Once created, a camera’s height can be modified in its **Camera Specification** dialog. See “Camera Specification Dialog” on page 390.

Creating Overviews



Select **3D> Create Doll House View** to create a drawing of the current floor with the ceiling removed.

Doll House Views generate as soon as you select the tool and are always created at the same angle. The focal point is always located at the center of the model; however, the position of the camera will vary depending on the size of the 3D model. The larger or more spread out the model, the further away the camera will be from the focal point so that the entire model can be seen in the view.



Once generated, an overview window’s title bar indicates its view type and a camera symbol representing the Doll House View displays in floor plan view. The overview ‘camera’ can be edited much like regular

camera views can. See “Editing 3D Views” on page 385.



Doll House Views are an effective tool for illustrating traffic flow and the relationships between spaces.



To see a different floor, select **Tools> Reference Floors> Up One Floor**  or **Down One Floor** . You can also return to

floor plan view and make another floor current before generating the Doll House View.

Displaying 3D Views

A variety of tools and settings allow you to control the appearance of your 3D views. There are also numerous ways to adjust the position, focal point and field of view of a 3D view. See “Editing 3D Views” on page 385.

The name of the current plan file and the type of view displays at the top of each view window in its title bar.

There is no limit to the number of 3D view windows that you can have open at a given time; bear in mind, though, that each window demands use of your computer’s resources and that you may see poor performance if too many views are open. See “Working in Multiple Views” on page 74.

Display Options



Which objects display in a 3D view is controlled in the **Display Options** dialog. See “Display Options Dialog” on page 88.



Different view types use different layer sets when they are created. See “Layer Sets” on page 88.

In Floor Plan View

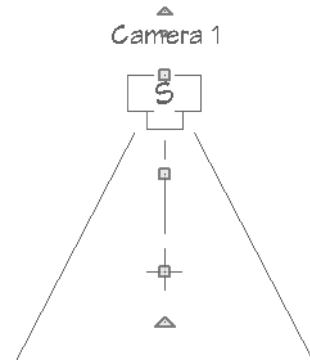
Cameras are represented in floor plan view by symbols that indicate the camera’s position, field of view and focal point.



The symbols for Full and Floor Cameras and Doll House Views display only on the floor where the view was created. See “Creating Camera Views” on page 377.

You can move a camera to a different floor by clicking the **Up One Floor**  or **Down One Floor**  button while the camera view is active. Note that this may affect what is seen in the view as well as its display in floor plan view. See “Floor Up / Floor Down” on page 292.

Active cameras can have labels indicating the camera number. Camera labels are located on the “Cameras, Labels” layer. They are numbered sequentially in each plan in the order they were created.

Camera symbols are an on-screen reference: they do not print unless **Print Image** is used.

In Rendered Views

There are a number of factors that contribute to the appearance of rendered 3D views:

- Select **3D> Toggle Textures**  in a 3D view to turn off the display of material textures. See “About Materials” on page 361. Not available in Glass House Views.

Several other factors can contribute to the overall quality of a rendered 3D view. See “Rendering Tips” on page 394.

3D Backdrops

A backdrop is an image, usually of an exterior view, that displays in the background of 3D views to help place the model into a realistic setting and add a sense of perspective. If a backdrop is not specified, Home Designer Interiors applies a background color. See “3D Backdrops” on page 415.

Delete 3D Surface



The individual surfaces that make up objects can be temporarily removed from any 3D view by selecting **3D> Delete Surface** and then clicking on a surface.

When the pointer is over a surface, that surface will become highlighted.

Surfaces removed in one view are removed in all 3D views, but are not permanently removed from the model. Continue clicking surfaces to remove them, then select another tool when you are finished.

Surfaces in 3D views are composed of multiple triangles. Hold the Alt key while clicking to delete one triangular face at a time rather than all triangles forming a surface.

To restore the most recently deleted surface, select **3D> Delete Surface** or click the toolbar button.

There are several ways to restore all deleted surfaces:

- Select **Build> Floor> Rebuild Walls/Floors/Ceilings**,
- Exit the 3D view and reopen it.
- Generate a new 3D view.

Rebuild 3D



Select **3D> Rebuild 3D** to regenerate all 3D data associated with the current plan. All open views will remain open.

Repositioning Cameras

Once a 3D view is created, there are many ways to manipulate the camera location and the direction of its line of site using the mouse, the keyboard, and the menus.

When the keyboard, toolbar buttons, or menu commands are used to move or rotate a camera, the adjustments occur in regular increments. The size of these increments is

specified in the **Camera Specification** dialog:

- The **Incremental Move Distance** controls Panning movement and forward and backward Dolly movement.
- The **Incremental Rotate Angle** controls Orbit movement, Tilt movement, and side to side Dolly movement.

See “Camera Specification Dialog” on page 390.

Each time you move the camera, the view is updated. If you are using either the toolbar or keyboard to move the camera, you can hold down the Shift key, suppressing the redraw of the view until the Shift key is released and allowing you to move multiple increments more quickly.

Mouse Scroll Wheel and Trackpad

3D views can be panned and zoomed when any tool is active using the mouse scroll wheel or trackpad gestures. See “Using a Trackpad” on page 22.

The program adjusts the speed of these actions depending on characteristics of the camera:

- Zoom speed depends on how close the camera is to the object located behind the mouse pointer. When the target object is far from the camera, zooming is faster; as the camera gets closer to the target, zooming slows.
- Panning speed depends on the length of the camera’s Line of Sight. In general, it is likely to be faster in an exterior view of a large model, slower in an interior view of a small room. See “Creating Camera Views” on page 377.

By default, panning and zooming adjusts the position and direction of the camera. It does not, however, adjust the distances at which surfaces are clipped. This means that if you zoom in closely on an object, some of its surfaces may be removed from the view. One way to avoid this is to lower the camera’s **Clip Surfaces Within** value in the **Camera**

You can also move a camera to a different floor by clicking the **Up One Floor**  or

Down One Floor  button while the camera view is active. Note that this may affect what is seen in the view as well as its display in floor plan view. See “Floor Up / Floor Down” on page 292.

Specification dialog. See “Camera Specification Dialog” on page 390.

Another way to avoid this is using **Perspective Crop Mode** .

When **Perspective Crop Mode**  is active, panning and zooming do not adjust the position of the camera. As such, using it can result in inconsistencies between a camera’s position and what is actually shown in the view. For this reason, it should only be used to zoom in closely on small objects or details.

To use Perspective Crop Mode

1. Zoom in on an object that you would like to examine closely.
2. If any of its surfaces disappear, zoom out until they are restored.
3. Select **3D> Camera View Options> Perspective Crop Mode** .
4. Zoom in on the object, but try to limit any panning or other changes to the camera’s perspective.

 Once Perspective Crop Mode has been enabled in a camera view, it should remain toggled on and navigation in that view should be limited.

3Dconnexion® 3D Mice

3Dconnexion®'s 3D mice can be used to navigate in all views - including camera views and overviews.

In the Windows version of Chief Architect, pre-programmed view direction hotkeys are supported on devices with buttons for that purpose. MacOS™ does not provide mapping support to the view direction commands; however, you can create custom hotkeys for the commands in Chief Architect and then

program your 3D mouse to use those hotkeys. See Hotkeys.

You can specify whether navigation is centered about the camera or its focal point in the **Preferences** dialog. See “Render Panel” on page 62.

Note that rolling is not supported in Chief Architect and that 3D mice cannot be used to move the mouse pointer. For details about using your 3D Connexion® mouse, refer to its documentation.





Move Camera with Mouse



An active camera's position can be edited using the mouse. Select **3D>**

Move Camera With Mouse to access the Move Camera with Mouse modes.

	Hotkey	Description
	Alt + O	Mouse-Orbit Camera lets you move the mouse to rotate the camera around its focal point. The camera's position and direction both change. To continuously rotate the camera around its focal point, click in the 3D view, drag the mouse, and release the mouse button to “throw” the view. Click again in the view to stop it from rotating.
	Alt + middle mouse button	To temporarily activate Mouse-Orbit Camera , hold down the Alt key and then click and drag using the middle mouse button. When the Alt key and middle mouse button are released, whatever tool was previously in use will still be active.

	Hotkey	Description
	Alt + P	Mouse-Pan Camera lets you move the camera up, down, left and right using the mouse. The camera's position changes, but its direction does not.
	Alt + D	Mouse-Dolly Camera lets you move the camera forward and backward by moving mouse up and down. Move the mouse left or right to rotate the camera side to side.
	Alt + T	Mouse-Tilt Camera lets you move the mouse to tilt the camera in any direction while staying in the same location.
		3D Center Camera on Point lets you focus the camera at a particular point in the scene. This changes the camera's direction and focal point, but not its position. To use the 3D Center tool, activate the tool and then click on any object in the scene.
	Z	3D Focus on Object lets you focus the camera on a specific object. This changes the camera's position, direction, focal point, and the length of its line of sight. To use the 3D Center tool, activate the tool and then click on any object in the scene.

Move Camera with Keyboard

An active camera's position can be changed using the Arrow keys on your keyboard.

Select **3D > Move Camera with Keyboard** to access the Move Camera with Keyboard modes.

These modes use the **Incremental Move Distance** and **Incremental Rotate Angle** set in the active 3D view's **Camera Specification** dialog.

- **Keyboard-Orbit Camera** lets you use the keyboard to rotate the camera around the focal point. The camera's position and direction both change.
- **Keyboard-Pan Camera** lets you move the camera up, down, right, and left using

the keyboard. The camera's position changes, but its direction does not.







- **Keyboard-Dolly Camera** lets you move the camera forward and back using the Up and Down Arrow keys, and rotate side to side using the Left and Right keys.
- **Keyboard-Tilt Camera** lets you use the Arrow keys to tilt the camera up, down, or side to side to change the focal point. The camera's direction changes, but its position does not.

Move Camera Tools



Select **3D> Move Camera** in a 3D view to access these tools. These tools change the active camera's position, but not its direction.

These tools use the **Incremental Move Distance** set in the active 3D view's **Camera Specification** dialog.



	Hotkey	Description
	F	Move Camera Forward moves the camera and its focal point forward.
	B	Move Camera Back moves the camera and the focal point back.
	L	Move Camera Left moves the camera and the focal point to the left in a line perpendicular to the line of sight.
	R	Move Camera Right moves the camera and the focal point to the right in a line perpendicular to the line of sight.
	U	Move Camera Up moves the camera and the focal point up.
	D	Move Camera Down moves the camera and the focal point down.





Orbit Camera Tools



Select **3D> Orbit Camera** in a 3D view to access these tools. Orbiting the camera rotates it about the focal point

using the **Incremental Rotate Angle** set in the active view's **Camera Specification** dialog.





	Hotkey	Description
	I	Move Camera In moves the camera closer to the focal point along the line of sight. The camera cannot move past the focal point using this tool.
	O	Move Camera Out moves the camera away from the focal point along the line of sight.

	Hotkey	Description
		Orbit Camera Upward rotates the camera up about the focal point. The camera cannot rotate past a vertical line looking straight down on the focal point.
		Orbit Camera Downward rotates the camera down about the focal point. The camera cannot rotate past a vertical line looking straight up at the focal point.
		Orbit Camera Left rotates the camera to the left about the focal point.
		Orbit Camera Right rotates the camera to the right about the focal point.

Tilt Camera Tools

 Select **3D> Tilt Camera** to access these tools. Tilting keeps the camera in one place and pivots the camera about its vertical or horizontal axis. This movement

uses the **Incremental Rotate Angle** set in the active view's **Camera Specification** dialog and is similar to tilting your head up and down or turning it side-to-side.

	Hotkey	Description
		Tilt Camera Upward tilts the camera up while keeping it in the same location. The camera cannot tilt beyond the vertical position.
		Tilt Camera Downward tilts the camera down while keeping it in the same location. The camera cannot tilt beyond the vertical position.
		Turn Camera Left turns the camera to the left while staying in the same location.
		Turn Camera Right turns the camera to the right while staying in the same location.

Editing 3D Views

In addition to its position and direction, there are other ways to modify a 3D view.

In the Specification Dialog



You can make adjustments to a camera in the **Camera Specification** dialog. This dialog is particularly helpful for making fine adjustments to the camera's position, appearance, and other attributes. See "Camera Specification Dialog" on page 390.



Tile a 3D view and the floor plan view and use the camera movement tools to see how they affect the camera. See "Tiling Views" on page 75.

Using the Edit Tools

A camera symbol or symbols selected in floor plan view can be edited in a variety of ways using the buttons on the edit toolbar. See "The Edit Toolbar" on page 24.

Using the Edit Handles

Return to floor plan view without closing the 3D view. See "Working in Multiple Views" on page 74.

Using the **Select Objects**  tool, select the camera object. When a camera symbol is selected it displays four edit handles.

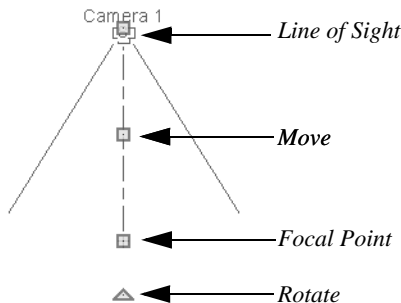

- Drag the **Line of Sight** handle to change the camera angle without moving the focal point.
- Drag the **Move** handle to relocate the camera while maintaining its relative angle.
- Drag the **Focal Point** handle to reposition the focal point and change the line of sight without moving the camera.
- Drag the **Rotate** handle to rotate the camera's line of sight about its center.

The 3D view corresponding to the camera symbol reflects changes made to the symbol in floor plan view.

Multiple camera symbols can be selected; however, their editing options are limited to being moved, rotated, and deleted.

Using the Contextual Menu

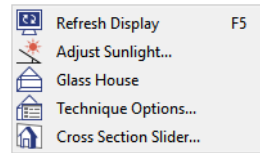

In a 3D view, right-click in an empty space in which the backdrop or background color displays to access the contextual menu. See "Contextual Menus" on page 25.



These options are a selection of tools and toggles specific to the current view.

Up One Floor/Down One Floor

You can move a camera to a different floor. While the camera view is active, select **Tools > Reference Floors > Up One**

Floor  or **Down One Floor** . Note that this may affect what is seen in the view as

well as its display in floor plan view. See “In Floor Plan View” on page 379.

The position and movement of a camera is affected by its location within the model. When inside a building, the camera height is relative to the floor of the room it is drawn in.



If the camera is on an upper floor and you move the camera outside of the building, the camera remains at the same height relative to the floor it was created on.

Zooming



The **Zoom Tools** are available in all 3D views. See “Zoom Tools” on page 72.

Selecting **Window > Zoom In** , **Zoom**

Out  or **Fill Window**  does not change the camera’s location or field of view.

Instead, the extents of the view are expanded or cropped.

Field of View

The **Field of View** refers to a camera’s field of vision. A wider field of view makes the focal point appear further away, as more of the image is included in the same view window.

In floor plan view, the angled lines of a camera symbol indicate its field of view.

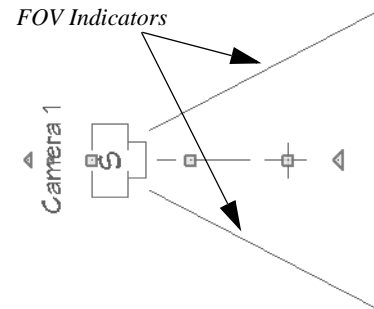

A camera’s field of view can be adjusted in the **Camera Specification** dialog. See “Camera Specification Dialog” on page 390.

Cross Section Slider



Select **3D > Cross Section Slider** when a camera view or overview is

active to open the **Cross Section Slider** dialog.

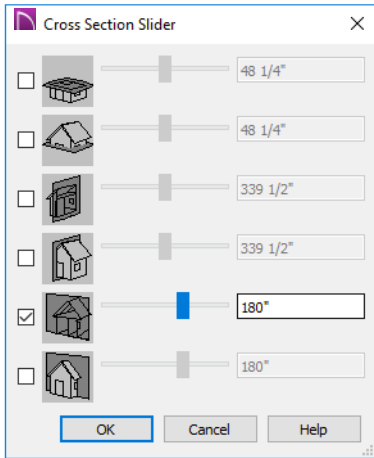

To use the Cross Section Slider

1. Check the box beside a cross section cutting plane to select it and make its Position slider and text box active.
2. Move the Position slider to adjust the position of the cutting plane.
 - The cutting plane Position is measured from the edge of the model that is cut first by the selected cutting plane.

- Position the Cutting Plane with accuracy using the text field to the right of the slider.
3. Repeat steps 1-3 to use additional cutting planes if you wish.
 4. Click **OK** to close the dialog. If the active camera is saved, its Cross Section Slider settings will also be retained. See “Saving 3D Views” on page 390.

Working in 3D

A variety of tools are available in 3D views that allow you to edit your 3D model.

Creating Objects in 3D Views

You can place windows, doors, and most library objects directly into 3D views. To do this, select the appropriate tool and click in the 3D view. You can then edit the object’s size and placement.

When created in 3D, most objects must be placed against a wall or on a floor platform.

Selecting and Editing Objects in 3D Views

Most objects can be selected and edited in 3D views. Select **Edit> Select Objects**  and click on the surface of an object to select it. Once selected, objects can be edited using their edit handles, buttons on the edit toolbar,

and the object's specification dialog. See "Editing Objects" on page 91.

When you select an object, edit handles and a handle surface display. The handle surface is a rectangle around the perimeter of the object that indicates the overall height and width of the selected surface. The edit handles that display depend on the type of object selected. Walls, for example, display two resize edit handles when selected while the top of a cabinet displays ten handles, allowing you to move, resize and reshape it.

Note: If the wall height of the Exterior Room is adjusted in a 3D view, the default Floor or Ceiling Height of the entire floor is changed. See "Floor and Room Defaults" on page 165.

All moving or resizing is in the plane of the handle surface. You cannot move an object directly towards or away from the camera, for example, because that surface plane cannot be seen in the view.

By default, object movement is restricted to one inch or 10 mm increments. See "Grid Snaps" on page 79.

Unrestricted positioning can also be enabled by holding down the Ctrl key while moving or resizing an object. See "Unrestricted Movement" on page 111.

Temporary dimension lines display when many objects are selected to help you resize the object and determine its height.

When several 3D views are open, changes made in the plan automatically rebuild the model in all views. Because of this, it is typically faster to make changes to your plan with as few windows open as possible.

Editing Materials in 3D Views



Select **3D> Materials> Adjust Material Definition**, then click on a surface in the 3D view to open the **Define Material** dialog for that material. See "Adjust Material Definition" on page 369.



Select **3D> Material Painter** to apply materials to surfaces in the view using the Material Painter Tools. See "The Material Painter" on page 363.



Select **3D> Material Painter> Material Eyedropper** to apply the material on a surface in the view to other surfaces in the view. See "Material Eyedropper" on page 365.

Rebuild 3D



As changes are made to your plan, a 3D view automatically updates to reflect any changes visible in the view. If you find that a view is not updating as expected, select **3D> Rebuild 3D** to rebuild the entire 3D model.

Saving and Printing 3D Views

3D camera views and overviews can be saved with the plan in which they are

created, exported and saved as image files, as well as printed.

Saving 3D Views





Select **3D> Save Active Camera** to save the current camera in the plan. You can also save a camera view by checking the **Saved** box in the **Camera Specification** dialog. See “Camera Specification Dialog” on page 390.

Saved cameras can be closed and re-opened for later use, and retain their Cross Section Slider Shadows, and Rendering Technique settings. See “Cross Section Slider” on page 387, “Shadows” on page 394, and “Rendering Techniques” on page 398.

Activating Saved Views

There are three ways to open a saved 3D view:

- Select the camera symbol in floor plan view and click the **Open View**  edit button.
- Double-click the camera symbol using the **Select Objects**  tool.
- Right-click on it and select **Open View** from the contextual menu.

Unsaved cameras that are open in another view window can also be activated using the **Open View**  edit button.

If you open a saved camera view and then modify its location or direction using any of the tools available in that view, the program will confirm whether you want to re-save the camera using these new settings when you close it. See “Repositioning Cameras” on page 380.

Exporting 3D Views



All 3D views can be exported and saved as .bmp, .jpg, .png, or .tif files. Select **File> Export> Picture** to save the current screen image as an image file. See “To export a picture” on page 412.

Once saved, a picture can be opened and converted into many other formats using a graphics program.

Printing 3D Views



Since 3D views are created using pixels instead of lines, **File> Print> Print Image** must be used when printing. **Print Image** is a special Home Designer Interiors function that prints the screen in picture format. The entire view prints, including images such as plants and textures.

The quality of your print image is affected by your current window size and screen resolution. To maximize the quality of your printed image, generate it in full screen size and use the maximum screen resolution.

Camera Specification Dialog



The **Camera Specification** dialog can be accessed in floor plan view by selecting a camera symbol and clicking the **Open Object** edit button. See “In Floor Plan View” on page 379.

This dialog can also be accessed while a camera view or overview is active by selecting **3D> Edit Active Camera** .

The selected view's specific type is indicated in the dialog's title bar: the specification

dialog for a **Full Camera** , for example, is named **Full Camera Specification**.

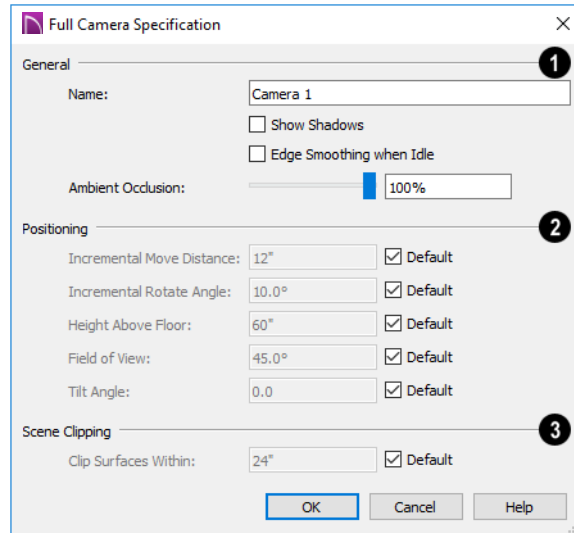

To change a setting, first uncheck **Default**, then type a new value in the text field.

1 General -

- Specify the **Name** that displays in the camera label in floor plan view.
- Check **Show Shadows** to turn on shadows in the selected camera view. When unchecked, shadows are not generated. See “Shadows” on page 394.
- Check **Reflections** to turn on reflections in the selected camera view. When unchecked, reflections are not generated. See “Reflections” on page 394.
- **Bloom**, or light bloom, occurs around areas of intense illumination and looks as though the light is ‘bleeding’ beyond the edges of the light source. It adds realism to the view but takes longer to render.

Only affects Standard and Watercolor renderings. See “Rendering Techniques” on page 398.

- Check **Edge Smoothing When Idle** to apply high quality edge smoothing to edge lines when the selected camera is not in motion. See “Edge Smoothing” on page 395.
- Check **Edge Smoothing When Idle** to apply high quality edge smoothing to edge lines when the selected camera is not in motion. See “Edge Smoothing” on page 395.
- Select the amount of **Ambient Occlusion** to use using the slider bar or text field. Ambient Occlusion allows variation in the strength of the ambient light and is more realistic than uniform ambient light, but takes longer to render. Only affects Standard and Watercolor renderings. See

“Ambient Lighting and Occlusion” on page 396.

2 The **Positioning** settings determine the position and orientation of the camera. See “Repositioning Cameras” on page 380.

- The **Incremental Move Distance** controls how far the camera moves each time you Pan in any direction or Dolly forwards or backward using the keyboard, toolbar buttons, or menu. For interior views a small number is good, but for exterior you may want a larger increment.
- The **Incremental Rotate Angle** defines how many degrees the camera rotates each time you Tilt, Orbit, or Dolly side to side using the keyboard, toolbar buttons, or menu. A setting of 90° would make one full rotation in four moves.
- The **Height Above Floor** defines the height that the camera is above the floor level for the current floor. See “Camera Height” on page 378.
- The **Field of View** defines the camera’s field of vision in angular degrees. See “Field of View” on page 387.



You can increase a camera’s Field of View when the view is active by pressing the W key, or decrease the Field of View by pressing the N key.

- The **Tilt Angle** determines the vertical angle that the camera is tilted. The camera maintains its focal point and position in floor plan view, but if the camera is tilted, the focal point is above or below the current camera height.
- 3** The **Scene Clipping** settings control the extents of the camera view.
- **Clip Surfaces Within** - Objects located within this distance from the camera do not display in the view. Decrease this value to display objects located very close to the camera; increase it to improve the appearance of some surfaces in Overview cameras with very large extents.

3D Rendering

There are a variety of tools available to create 3D views of a model: simply click a button to create an overview, or click and drag to create a camera view. See “3D Views” on page 375.

To improve the quality of the rendering and create a custom look, you can adjust lighting, edit the materials used in the plan, choose from several rendering techniques and fine-tune 3D view quality settings.

Chapter Contents

- Rendering Tips
- Lighting
- Displaying Lights
- Light Types
- Adjust Sunlight Dialog
- Rendering Techniques
- Rendering Technique Options
- Speeding up 3D View Generation

Rendering Tips

There are a variety of factors which affect the appearance and quality of rendered 3D views. You can use these tools and settings to achieve renderings that meet your needs.

- Lighting
- Shadows
- Reflections
- Material Definitions
- Images
- Backdrops
- Edge Smoothing

Lighting

Lighting is extremely important in most 3D renderings. Lighting controls the visibility of objects in a view, affects the appearance of surfaces, and influences the appearances of colors and textures on those surfaces. Even small changes to light intensity, direction and color can have a large impact on image quality. See “Lighting” on page 395.

Shadows

Like lighting, shadows have an important effect on image quality. Shadows can be generated in any type of camera view using any Rendering Technique aside from Glass House. See “Rendering Techniques” on page 398.

Shadows are enabled in Perspective camera views by default. You can, however, turn **Show Shadows** off or on in the **Camera Specification** dialog or select **3D> Camera View Options> Toggle Shadows**  in a

camera view. See “Editing 3D Views” on page 385.

Shadows are affected by the number of light sources in a plan, as well as what Rendering Technique is in use. In order for a light source to cast shadows, it must be On in the current view and have **Cast Shadows** checked in its specification dialog. See “Light Data Panel” on page 273.

When standard shadows are enabled, sunlight can shine through windows into interior rooms.

Reflections

Reflections are another aspect of lighting that can increase a 3D view’s realism. When a flat surface is assigned a Mirror material, it can display the reflections of other objects in the scene.

Note that a Mirror surface cannot display the reflection of another mirror. When one mirror can be seen in another, its material is shown rather than a reflection.

Reflections only generate in Perspective 3D views using the Standard Rendering Technique. They can slow down 3D view generation and responsiveness considerably.

Reflections can be toggled on or off in a camera view by selecting **3D> Camera View Options> Toggle Reflections**  as well as in the **Camera Specification** dialog.

See “Camera Specification Dialog” on page 390.

Material Definitions

Textures are graphic files that represent contoured surfaces of objects such as carpet, bricks, tile, and wood in 3D views. Textures are assigned to materials which in turn are assigned to objects. See “Textures” on page 362.

The display of materials in 3D views is controlled by settings in the **Define Material** dialog. See “Define Material Dialog” on page 370.

Brightness, shininess and transparency control how light sources affect the display of surfaces in 3D views. See “Lighting” on page 395.

If no texture is selected for a material or if the display of textures is turned off, affected surfaces are a solid color instead.

Images

Images are very important for the appearance of 3D views. Images are picture files that represent individual objects such as trees, flowers, and vehicles. See “Placing Images” on page 406.

Backdrops

A backdrop is an image, usually of an exterior view, that displays in the background

of 3D views to help place the model into a realistic setting and add a sense of perspective. If a backdrop is not specified, Home Designer Interiors applies a background color. See “3D Backdrops” on page 415.

Edge Smoothing

Angled surface edges will sometimes display on screen as jagged or stair-stepped. Edge Smoothing softens this effect, producing cleaner lines.

You can specify how much **Hardware Edge Smoothing** occurs in 3D views in the **Preferences** dialog. **Hardware Edge Smoothing** is set to “High” by default; however, if 3D views render slowly on your system, you can try using a lower setting. See “Render Panel” on page 62.

Even higher quality Edge Smoothing can be produced by checking **Edge Smoothing When Idle** in the **Camera Specification** dialog. This setting does not affect a camera while its position or orientation are being changed, but applies additional smoothing to edge lines when the camera is not in motion. See “Camera Specification Dialog” on page 390.

This high quality Edge Smoothing option is view-specific and can also be toggled on or off by selecting **3D> Camera View Options> Toggle Edge Smoothing When Idle** .

Lighting

In 3D views, lighting is calculated on a room-by-room basis; only the light sources

in the room containing the camera are used.

When the camera is outside a building, the program normally uses sunlight for lighting calculations and turns off all other light sources.

The maximum number of light sources that can be turned on in a view at the same time is determined by your video card. If your video card's maximum number of lights is eight, the program only uses the eight light sources closest to the camera's position.

Default Lights

If you create an interior 3D view of a room and no lights have been placed there, the program creates a Default Light source within that room. The Default interior light acts like a central point light source.

The Default Light cannot be adjusted in any way. If you want to control the light in an interior 3D view, you must add a light to the room that you are rendering by placing a lighting fixture.

If you create an exterior 3D view, the program creates a **Generic Sun**. Like the Default Light, the Generic Sun cannot be adjusted in any way.

Light Fixtures

An electric symbol that represents a Light Fixture has a light source associated with it. When a light is placed in a room, it will be used as a light source in 3D views instead of the Default Light. In large rooms, more than one light fixture may be needed for sufficient light.

Generic Sunlight

When you create a 3D view, the program creates a **Generic Sun** light source. The Generic Sun's intensity, color, and angle can be modified in the **Adjust Sunlight** dialog. See "Adjust Sunlight Dialog" on page 397.

Ambient Lighting and Occlusion

Ambient lighting simulates the way light bounces around a scene, producing a basic level of uniform illumination on all surfaces.

Ambient occlusion adds shading to surfaces near corners which, because of their location, reflect less light compared to other surfaces. Too little ambient occlusion can result in a view having a flat appearance. You can specify the amount of **Ambient Occlusion** to use in the **Camera Specification** dialogs. See "Camera Specification Dialog" on page 390.

Displaying Lights



The display of light fixtures in floor plan and 3D views is controlled in the **Display Options** dialog. See "Display Options Dialog" on page 88.



In addition, they can serve as sources of light in rendered 3D views. They can be turned on and off, as well as set to cast shadows.

Light fixtures are placed on the "Electrical" layer. See "Displaying Objects" on page 87.

In floor plan view, light fixtures can display labels when the “Electrical, Labels” layer is turned on.

To turn a light on or off

There are several ways to turn a light fixture on or off:

- Select one or more fixtures and click the **Turn Light(s) Off in 3D**  or **Turn Light(s) On in 3D**  edit button.
- Uncheck **On** in the object’s specification dialog. See “Light Data Panel” on page 273.

You can specify that any light source’s location be represented in rendered 3D views using a cross hairs. See “Light Data Panel” on page 273.

Light source position indicators will only display when the light is in use in the current 3D view. That is, it must be:

- Turned on.
- One of the light sources in use per your video card’s limitations.
- Either located in a room or in a view with Sunlight toggled off.

Sunlight will shine through windows into interior rooms when shadows are enabled. See “Shadows” on page 394.

Light Types

There are three types of light source, each of which generates light in a different way and allows you to create a variety of lighting effects:

- Parallel Light sources
- Point Light sources

- Spot Light sources

Parallel, Point, and Spot lights can be specified for electrical light fixtures in the **Electrical Service Specification** dialog. See “Light Data Panel” on page 273.

Adjust Sunlight Dialog



The **Adjust Sunlight** dialog allows you to control the intensity, direction and color of the Generic Sun light source in

the currently active 3D view. See “Generic Sunlight” on page 396.

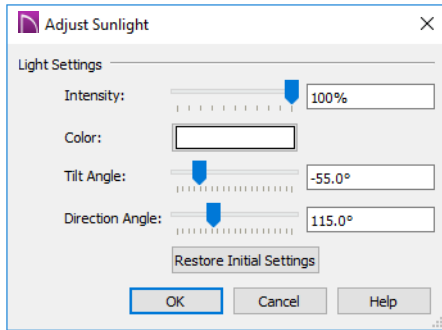

- Use the **Intensity** slider bar or text field to control how bright the Generic Sun light appears.
- Click the **Color** bar to define the color of the light being modeled. Colored sunlight may be used to achieve special lighting effects, but may alter the appearance of your material colors and textures.

- Specify the **Tilt Angle**, which is the angle of the sunlight with respect to the horizon. A value of 90° means that the light points straight up, while a value of -90° means that the light points straight down. 0° is parallel to the horizon.
- Specify the **Direction Angle**, which is the direction that the sunlight points toward. 0° is measured horizontally on screen, pointing to the right. Positive values rotate in a counter-clockwise direction from there, while negative values rotate clockwise.
- Click the **Restore Initial Settings** button to restore the original Generic Sun settings.

By default, the Generic Sun light color is pure white, which has the least effect on the appearance of material colors and textures. See “Materials” on page 361.

Rendering Techniques



Any camera view or overview can be generated using one of several Rendering Techniques to produce views for a range of different purposes. When a 3D view is active, select **3D> Rendering Techniques** to access these tools.

Once a view is created, the effects of the selected rendering technique can be adjusted in the **Rendering Technique Options** dialog. See “Rendering Technique Options” on page 400.

Standard Rendering



Standard rendering is a photo-realistic technique that represents materials using textures, models lighting, and

can also display shadows. Surface edge lines are not drawn and no special colors or effects are applied. Lighting is limited to the room containing the camera and the capabilities of your video card.

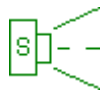

In floor plan view, the camera symbol for a view using the **Standard** technique displays an S

Views” on page 379.

Glass House

Glass House rendering uses different shades of a single color to display the model with surface edge lines and semi-transparent surfaces. Lighting and shadows are not modeled, and materials are not represented, so textures are not used.

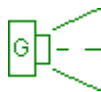

In floor plan view, the camera symbol for a view using the **Glass House** technique displays a G in its center.

Technical Illustration



Technical Illustration rendering draws surface edge and pattern lines, and uses shades of two colors, Warm and Cool. The warm shade is applied to surfaces that face the light source in the view, and the cool shade, to surfaces that face away from it.

Only one light source is used: the light with the highest Intensity found in the room containing the camera. In exterior views, this light is always the Generic Sun. If no lights are on, a fallback light is used. Lighting is

modeled as non-photorealistic, stylized highlights and shadows are supported. See “Lighting” on page 395.

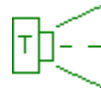
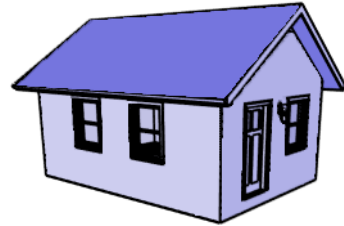

In floor plan view, the camera symbol for a view using the **Technical Illustration** technique displays a T in its center.

Watercolor



Watercolor rendering approximates the effects of watercolor painting such as pigment pooling and flow. It uses textures to represent materials and models lighting and shadows.

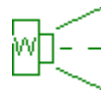

In floor plan view, the camera symbol for a view using the **Watercolor** technique displays a W in its center.

Rendering Technique Options



The settings in the **Rendering Technique Options** dialog allow you to control the specific effects of each rendering technique on an active 3D view. To access this dialog, create a camera view, or overview and select **3D> Rendering Techniques> Technique Options**.

In the **Rendering Technique Options** dialog, select a technique from the list on the left to make its options active on the right. When this dialog is first opened, the

technique currently used by the view is selected.

As changes are made in the **Rendering Technique Options** dialog, the 3D view automatically updates to reflect those changes for all techniques except Watercolor. To update views using these techniques, which take more time to draw than the others, click the **Update** button in the dialog.

When a 3D view is saved, its Rendering Technique Options settings are saved, as well. See “Saving 3D Views” on page 390.

Standard Panel



There are no Rendering Technique Options for Vector View rendering.

There are, however, a variety of other tools that affect the appearance of Standard rendered views. See “Displaying 3D Views” on page 379.

Glass House Panel



The active 3D view immediately updates to reflect any changes made to

the Rendering Technique Options settings for Glass House renderings.

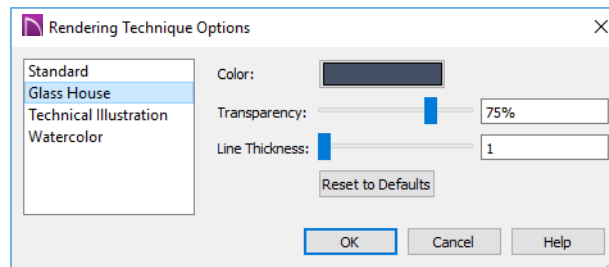

- Click the **Color** bar to select a color for the semi-transparent surfaces and lines in a Glass House view. See “Select Color Dialog” on page 372.
- Specify the **Transparency** of the surfaces in Glass House view. For example, to create a wireframe line drawing of your structure, turn transparency to full and minimize line thickness.

- Specify the **Line Thickness** of surface lines in Glass House view.
- Click **Reset to Defaults** to restore the default settings used when the Glass House technique was first enabled.

Technical Illustration Panel



The active 3D view immediately updates to reflect any changes made to

the Rendering Technique Options settings for Technical Illustration renderings.

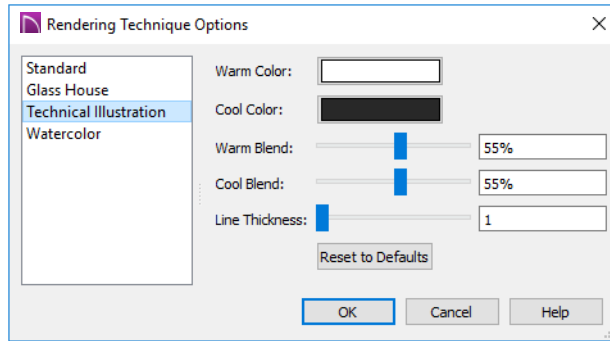

- Click the **Color** bar to select a **Warm Color** for surfaces that face the light source and a **Cool Color** for surfaces that face away from the light. See “Select Color Dialog” on page 372.
- Specify the **Warm Blend**, which is the degree to which the selected Warm Color is blended with original colors on well-lit surfaces in the view.
- Specify the **Cool Blend**, which is the degree to which the selected Cool Color is blended with original colors on shaded surfaces in the view.
- Specify the **Line Thickness** of all surface edge and pattern lines in the view.
- Click **Reset to Defaults** to restore the default settings used when the Technical Illustration technique was first enabled.

Watercolor Panel



In order for the active 3D view to reflect changes made to the Rendering

Technique Options settings for Watercolor renderings,

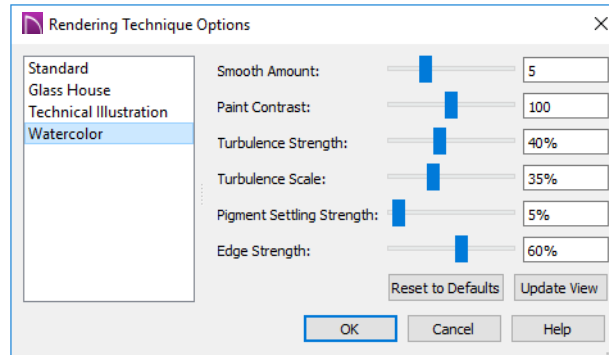

- Specify the **Smooth Amount**, which is the degree to which details are removed from the original view.
- Specify the **Paint Contrast**, which determines the extent to which variations in pigment color are used.
- Specify the **Turbulence Strength**, which produces “pooling”, or variations in the strength of pigment colors.
- Specify the **Turbulence Scale**, which controls the size of the areas of pooling.
- Specify the **Pigment Settling Strength**, which creates the appearance of pigment settling into low areas in paper.
- Specify the **Edge Strength**, which is how well-defined surface edge lines are.
- Click **Reset to Defaults** to restore the default settings used when the Watercolor technique was first enabled in this view.
- Click **Update View** to apply these settings to the active 3D view.

Speeding up 3D View Generation

When you have a large, complex model with a lot of detail, it may take some time to generate a 3D view of everything in the model. During this process, progress information may display in the Status Bar and in a message window.

There are several ways to speed up the generation time of views.

Halt Generation with Esc Key

In a large, complex model, repositioning the camera can be time-consuming. You can

speed up this process using the Esc key. When you press the Esc key, the modeling process is interrupted and the view is displayed “as is”. Then, press the F5 key to refresh the display.

Turn Off Layers



The display of objects in 3D views can be turned on or off in the **Display Options** dialog. Turning off unneeded layers in 3D views can speed up 3D view generation time. See “Display Options Dialog” on page 88.

Rendering Preferences



In the **Preferences** dialog, there are a number of settings that you can use to

balance rendering quality and generation time. See “Render Panel” on page 62.

Pictures, Images, and Walkthroughs

Home Designer Interiors uses picture files in a variety of ways to enhance your drawings.

The Library Browser contains images of real world objects like plants and vehicles that can display in 3D views.

Picture files can also be imported into Home Designer Interiors and shown in most views.

You can save any view using a variety of picture file formats. In addition, Home Designer Interiors allows you to create virtual tours that can be saved as **.avi** files, shared with others, and played back later.

Chapter Contents

- Picture Files vs Pictures and Image Objects
- Images
- Displaying Images
- Editing Images
- Image Specification Dialog
- Pictures
- Picture File Box Specification Dialog
- Metafiles
- Metafile Box Specification Dialog
- Displaying Pictures and Metafiles
- Editing Pictures and Metafiles
- Copy Region as Picture
- 3D Backdrops
- Walkthroughs

Picture Files vs Pictures and Image Objects

In common computer language, picture files, pictures and images are more or less synonymous. In the Home Designer Interiors environment, however, there are some notable differences between these terms.

In Home Designer Interiors, a two dimensional image file such as a .bmp, .jpg, .gif, or .png is referred to as a picture file or an image file. Examples of these files are saved on most computers and can be opened in a variety of applications.

A Picture, on the other hand, is a file that has been imported into the program. Pictures can be imported into floor plan view. They are

two-dimensional only and do not display in camera views or overviews.

An Image object is also based on a picture file, but it does display in both 2D and 3D views. Images have 3D width and height data associated with them, as well as a 2D symbol which displays in floor plan view.



Picture files have additional uses in Home Designer Interiors, as well:

- Backdrops are picture files that display behind 3D views. See “3D Backdrops” on page 380.
- Textures are picture files that realistically represent materials in 3D views. See “About Materials” on page 361.

Images

Images add realistic detail to 3D views without adding many surfaces to the model. For example, a tree image with a single surface can be used instead of a tree symbol with thousands, dramatically improving realism without compromising drawing time.

There are two types of Images in Home Designer Interiors:

- **Images**  rotate so that they always face the camera in 3D views.
- **Billboard Images**  do not rotate to face the camera. An example of when this may be useful is an image of a trellis, which might look awkward when facing a camera from a side view.

Placing Images



A selection of Images are available in the Library Browser. Select one and click in a floor plan view, camera view or overview to place it. See “Placing Library Objects” on page 342.



Creating Images



Custom Images can be added to the Library Browser, as well as created in plan files. Home Designer Interiors can use any image with a *.bmp, *.jpg, *.png, *.gif, *.tif, *.pcx, or *.tga extension.

Generally, .png files work best as Images because this format has good compression and allows for the Image to contain transparency information.

To create an Image in floor plan view

1. In floor plan view, select **Build> Image> Create Image**  or **Billboard Image**  to open the **Image Specification** dialog. See “Image Specification Dialog” on page 408.
2. On the IMAGE panel:
 - Click the **Browse** button to select a picture file on your computer or enter the path to a valid picture file in the **Image File** field.
 - Select a **2D Plan Symbol** from the drop-down list or click the **Library** button and select a symbol from the library. The selected symbol represents the image in floor plan view. See “Image Panel” on page 409.
 - Specify the **Size** and **Position** of the image.
3. Specify transparency information on the **TRANSPARENCY** panel.
4. Click OK to close the **Image Specification** dialog.

5. Click to place the new Image in floor plan view.

To create an image in the Library Browser

1. In the Library Browser, right-click on an unlocked folder.
2. Select **New> Image** from the contextual menu to open the **Image Specification** dialog.
3. Browse to the image file you want to add and select your other options. See “Image Specification Dialog” on page 408.
4. Once created, the image is listed in the library folder that you right-clicked on. Size and other data is saved.

Using Paste Image



You can also import an image by first copying it to the system clipboard, then navigating to a Home Designer Interiors window and selecting **Edit> Paste> Paste** from the menu. See “Paste Special” on page 83.

Displaying Images



The display of images in floor plan and 3D views is controlled in the **Display Options** dialog. See “Displaying Objects” on page 87.

Images are placed on the “Images” layer.

In Floor Plan View

In floor plan view, most images are represented by an Image  symbol. You can specify a different symbol to represent an

image if you wish. See “Image Specification Dialog” on page 408.

In 3D Views

The actual picture associated with an image object can be seen in 3D views, as can any transparency data associated it. See “Image Specification Dialog” on page 408.

Images can be set to either rotate so that they always face the camera or remain stationary, like billboards. See “Images” on page 406.

Editing Images

Images can be selected in 2D and 3D views and edited using the edit handles, edit tools and the **Image Specification** dialog.

Using the Mouse

In floor plan view, a selected image can be rotated, moved, and resized. In 3D views, a selected image only has two edit handles: the circular Resize handle and square Move handle.

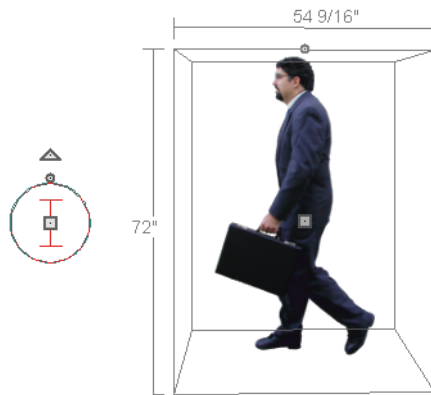

When an image is resized using the edit handle, its aspect ratio is retained and 2D symbol resizes proportionally.

Using the Edit Toolbar

A selected image or images can be edited in a variety of ways using the buttons on the edit toolbar. As with most objects, images can be copied, replicated, moved, deleted, etc. See “The Edit Toolbar” on page 24.

Image Specification Dialog



Select an image and click the **Open Object** edit button to open the **Image Specification** dialog.

Image Panel

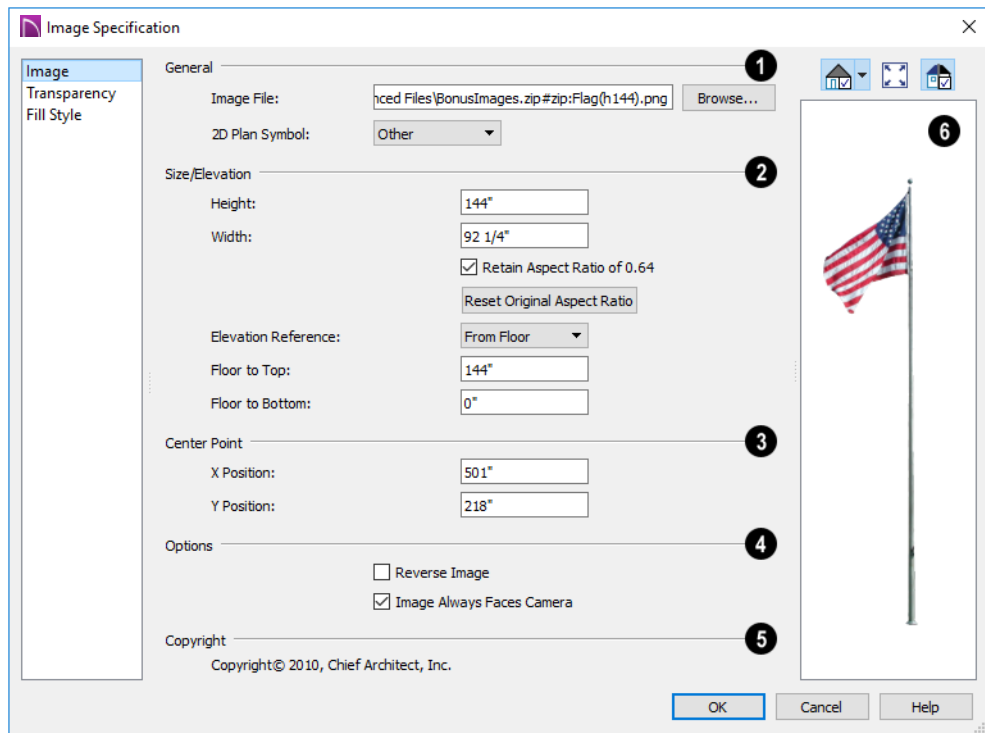

- 1 **General** information about the selected Image can be specified here.
 - The **Image File** associated with the Image can be specified. Click **Browse** to choose a file saved on your computer or type the file's full pathname in the text field.
 - Select a **2D Plan Symbol** from the drop-down list to represent the Image in floor plan view. See "Displaying Images" on page 407.
- 2 Specify the **Size/Elevation** of the image as it displays in 3D views.
 - Enter a **Height** for the selected image.
 - Enter a **Width** for the selected image.
 - Uncheck **Retain Aspect Ratio of X** if you would like to modify the Height or Width without affecting the other value. If you do this, the image may appear distorted. This check box does not affect editing performed outside of this dialog and is an action rather than a state: the next time you open this dialog, it will be checked.
 - Click **Reset Original Aspect Ratio of** to reset the image's original aspect ratio and remove any distortion caused by resizing.
 - Select the **Elevation Reference** from the drop-down list. This determines where

- the next two settings are measured from and also affects their setting labels.
- Specify the height to **Top**, measured from the selected Elevation Reference to the top edge of the image.
 - Specify the height to **Bottom**, measured from the selected Elevation Reference to the bottom edge of the image.
- 3** Specify the location of the **X and Y Coordinates** of the selected image's **Center Point**.
 - 4 Options -**
 - Check **Reverse Image** to reflect the appearance of the image about an imaginary vertical line through its center.
 - Check **Image Always Faces Camera** to prevent the image from rotating to face the camera in 3D views. This box is unchecked for Billboard Images. See “Images” on page 406.
 - 5** Any **Copyright** information associated with the selected Image will be stated here.
 - 6** A preview of the selected Image displays here. The Glass House Rendering Techniques is not available for images. See “Dialog Preview Panes” on page 28.

Transparency Panel

The settings on the TRANSPARENCY panel let you specify portions of the selected image as transparent.

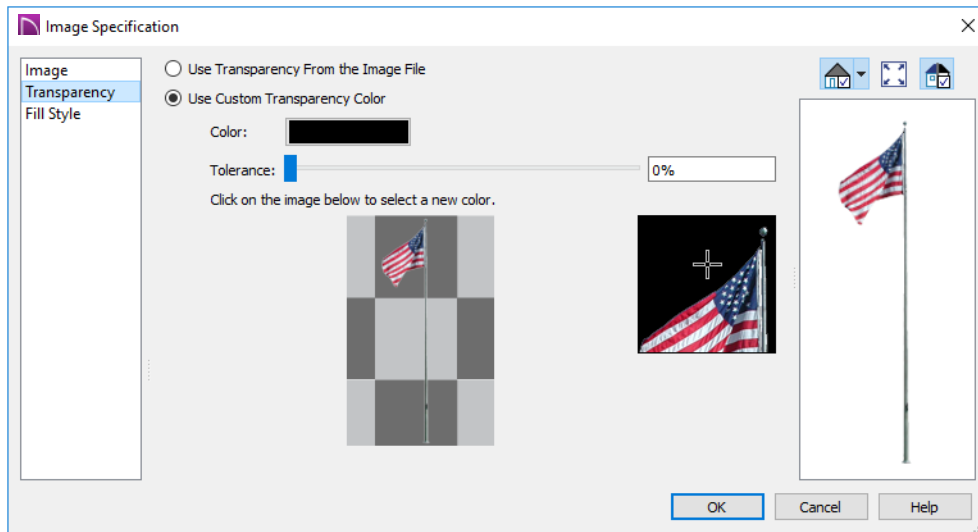

- Click the **Use Transparency From The Image File** radio button to use any transparency data included in the image file.
- Click the **Use Custom Transparency Color** radio button to specify a color in the image to represent the transparency and enable the settings below.
- Click the Color box to select a color in the **Select Color** dialog. See “Select Color Dialog” on page 372.
- Use the slide bar or enter a value to specify a level of **Tolerance** to be applied to colors that are almost the same as the specified transparency color.
- Move your pointer over the small preview image below. The pointer changes to an eyedropper and a magnified preview displays to its right. Click to select the color of the pixel your pointer is over as the Transparency color. The selected color displays in the Color box, below.
- A magnified preview of the area in the preview image above displays here, allowing for accurate pixel selection.

Note: The image preview will display its original orientation, even if Reverse Image is checked on the Image panel.

The Transparency Color

If the portion of the image file that you wish to use contains the transparency color, that part of the image also becomes transparent. If this happens, the image may appear partially disintegrated.

You may need to experiment to find the best transparency color and tolerance for the image.

Fill Style Panel

The settings on the FILL STYLE panel affect the appearance of the selected image’s **2D Plan Symbol** in floor plan view, provided that the selected symbol is a closed shape. For information about these settings, see “Fill Style Panel” on page 129.

Pictures

A variety of picture file types can be imported into and exported out of Home Designer Interiors.

Metafiles are also types of picture files that can be imported and exported. See “Metafiles” on page 413.

Exporting Pictures

There are several ways to save a picture of a view in Home Designer Interiors:



Using the **Export Picture** tool is similar to creating a screen capture of everything in the current view window. Pictures can be saved in various file formats and used in other applications.

Export Picture  is best suited for 3D views. When exporting a line-based view, best results can be achieved by saving it as a Metafile. See “To export a metafile” on page 413.



The **Copy Region as Picture** tool also lets you create a picture file based on the current view, but allows you to specify what portion of the view is exported. See “Copy Region as Picture” on page 415.



Use the **Print Image** tool to either print or save the current view as a PDF file. See “Print Image Dialog” on page 442.

To export a picture

1. Open the view that you would like to export as a picture file.
2. Zoom, pan or otherwise adjust the view so that what you see on screen suits your needs. See “Displaying 3D Views” on page 379.
3. Select **File> Export> Export Picture (BMP, JPG, PNG)** to open the **Export Picture File** dialog and give the file to be exported a name, file type, and location. See “Exporting Files” on page 41.

Importing Pictures



Pictures can be imported into and displayed only in floor plan view. Pictures do not display in camera views or

overviews. See “Displaying Pictures and Metafiles” on page 414.

There are several ways to import a Picture into Home Designer Interiors:

- Select **File> Import> Import Picture (BMP, JPG, PNG)** to open the **Import Picture File** dialog, which is a typical open file dialog. See “Importing Files” on page 45.
- Click and drag an image file from an operating system window into the Home Designer Interiors window.
- In any application, copy an image to the system clipboard, then select **Edit> Paste> Paste** from the Home Designer Interiors menu in an eligible view window. See “Paste Special” on page 83.

Note: Importing large, or multiple, Pictures into a plan file can result in program slowness.

An imported picture is placed in the center of the current view. Once imported, pictures can be selected and edited. See “Editing Pictures and Metafiles” on page 414.

Picture File Box Specification Dialog



Select an imported picture file and click the **Open Object** edit button to open the **Picture File Box Specification** dialog.

The settings in this dialog are similar to those on the **LINE STYLE** panel in numerous other

dialogs, with one exception: check **Show Outline** to turn on the display of the picture’s border polyline.

See “Line Style Panel” on page 124.

Metafiles

A metafile (**.emf**, **.wmf**) is a special picture file format made up of vectors (lines) that allow the image to be rescaled without loss of quality. High resolution pictures of line-based views can be exported as a metafile.

Note: Metafiles are not supported in Mac operating systems and cannot be imported or exported in Mac versions of the software.



Exporting Metafiles



An enhanced metafile (**.emf**) can be exported from floor plan view.

Only objects that display on screen are included in an exported metafile.

To export a metafile

1. Accurately position the view on screen.
2. Select **File> Export> Export Metafile (EMF)** .
3. Drag a marquee  from corner to corner, defining the area that will be included in the metafile.
4. Release the mouse button to open the **Export Metafile** dialog, which is a typical Save As dialog. See “Saving, Exporting, and Backing Up Files” on page 39.
5. When you click the Save button, the **Metafile Size** dialog opens.

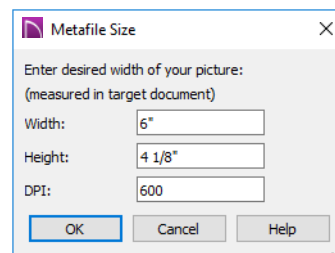

6. Specify the desired **Width** or **Height** of the metafile. When one value is edited, the other changes to maintain its aspect ratio.

Specify, too, the desired **Dots Per Inch (DPI)** for the metafile. A larger value results in a higher quality metafile, but also a larger file size.

Importing Metafiles



Metafiles can be imported into and displayed only in floor plan view.

Metafiles do not display in camera views or overviews. See “Displaying Pictures and Metafiles” on page 414.

There are two ways to import a metafile into Home Designer Interiors:

- Select **File> Import> Import Metafile (EMF,WMF)**  to open the **Import Metafile** dialog, which is a typical open file dialog. See “Importing Files” on page 45.
- You can also click and drag a metafile file from an operating system window into the Home Designer Interiors window to import it.

An imported metafile is placed in the center of the current view. Once imported, metafiles

can be selected and edited. See “Editing Pictures and Metafiles” on page 414.

Metafile Box Specification Dialog



Select an imported metafile and click the **Open Object** edit button to open the **Metafile Box Specification** dialog.

The settings in this dialog are similar to those on the **LINE STYLE** panel in numerous other

dialogs, with one exception. Check **Show Outline** to turn on the display of the picture’s border polyline.

See “Line Style Panel” on page 124.

Displaying Pictures and Metafiles



The display of Pictures and Metafiles is controlled in the **Display Options** dialog. See “Displaying Objects” on page 87.

Pictures and Metafiles are placed on the “CAD, Default” layer.

Pictures and Metafiles can be imported into and displayed only in floor plan view. A Picture or Metafile can only be seen in the view where it was imported and cannot be imported into a camera view or overview.

Drawing Groups

Each object in a plan file is included in a Drawing Group, which influences whether it displays in front of or behind other objects. By default, imported pictures are placed in the Back Group, and imported metafiles are placed in the same Drawing Group as CAD objects.

Once imported, the drawing order of pictures and metafiles can be customized. See “Drawing Groups” on page 86.

Editing Pictures and Metafiles

Pictures and Metafiles can be selected and edited using the edit handles, the edit toolbar, and their specification dialogs.

In the Specification Dialog

Pictures and Metafiles can be customized in their specification dialog. See:

- “Picture File Box Specification Dialog” on page 412

- “Metafile Box Specification Dialog” on page 414

Using the Mouse

Pictures and Metafiles have edit handles similar to other box-based objects. See “Editing Box-Based Objects” on page 104.

- The corner Resize handles behave do not behave the same for Pictures and Metafiles as they do for CAD boxes,

however. If you drag a corner handle of one of these objects while the Default Edit Behavior is active, its contents will resize and height to width ratio will be retained.

- If you drag an Extend handle along a Picture or Metafile edge, the contents of the box will not be resized. If you resize it larger, an empty space will be created between that edge and the contents; if you resize it smaller, the contents will be cropped.

Using Dimensions

Pictures and Metafiles can be relocated relative to other objects with precision using dimensions.

To avoid changing the selected object's aspect ratio, make sure you choose to move the entire object rather than the selected edge. See "Moving Objects Using Dimensions" on page 192.

Using the Edit Tools



A selected Picture or Metafile can be edited in a variety of ways using the buttons on the edit toolbar. See "The Edit Toolbar" on page 24.

Copy Region as Picture



You can copy any portion of the screen and save it as a picture file using the **Copy Region as Picture** tool. See "Exporting Pictures" on page 411.

To use Copy Region as Picture

1. Open the view that you would like to copy all or part of as a picture.
2. Select **Edit> Copy Region as Picture** . Your pointer displays a marquee  icon.

3. Click and drag a rectangular selection marquee around the desired region.
4. The selection is copied to the system clipboard.
 - If the current view is vector-based, the **Metafile Size** dialog displays because metafiles are better suited for line-based pictures. See "Metafiles" on page 413.
 - If the current view is a 3D view, the region is sent directly to the system clipboard.
5. From there, the picture can be pasted into another view or another program.

3D Backdrops

A backdrop is an image, typically of an exterior view, that displays in the background of 3D views to help place the model into a

realistic setting and add a sense of perspective.



The backdrop in this view includes hills and clouds

A selection of backdrop images is available in the Library Browser. You can also create your own backdrop images and import them into the library. See “Adding New Backdrops” on page 339.

Backdrops automatically adjust to fit each view window, so they look best when they are created with a height to width ratio that is similar to the window you are working in.



You can create digital photos of a building site for use as a backdrop.



Backdrop Specification Dialog



To open the **Backdrop Specification** dialog, select **File> Import> Import Backdrop** or right-click on the User Catalog in the Library Browser and select **New> Backdrop** from the contextual menu. See “Adding New Backdrops” on page 339.

Specifying a Backdrop

You can select a backdrop image for a plan from the library in either of two ways:

- In any view, select **3D> 3D Backdrop**  to open the **Backdrop** dialog. See “Backdrop Dialog” on page 376.
- In a 3D view, open the Library Browser. Select a Backdrop image, then move your mouse pointer  into the view window. Click anywhere in the view to apply the selected backdrop.

Regardless of how it is selected, only one backdrop can be used in a plan at any given time. If a backdrop is not applied, Home Designer Interiors applies a background color.

You can specify which view types and Rendering Techniques use the selected backdrop in the **Backdrop** dialog.

You can also open this dialog by right-clicking on a backdrop image in the User Catalog in the Library Browser and selecting **Open**  from the contextual menu.

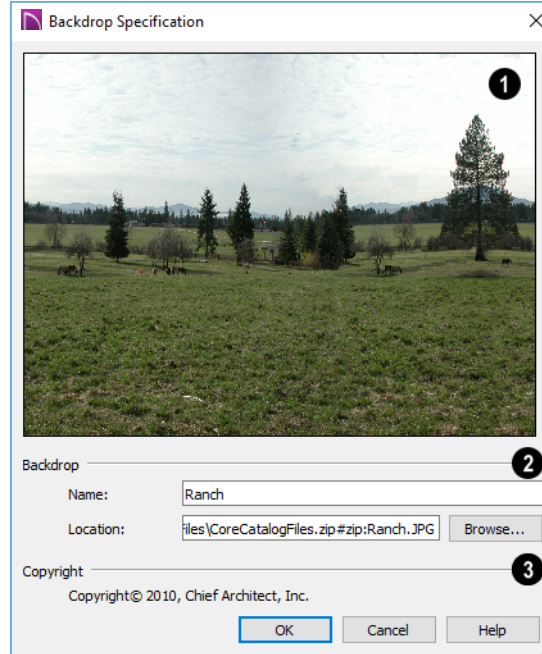

- 1 A preview of the selected image displays here.
- 2 **Backdrop** - Specify backdrop's Name and the image file associated with it.
 - Type a **Name** for the selected backdrop, to be used in the Library Browser and **3D View Defaults** dialog.
 - In the **Location** field, type the full path-name of the image file or click the **Browse** button and browse to the file on your computer.
 - 3 If the selected image has a **Copyright**, information about it will display here.

Walkthroughs





A 3D Walkthrough is a series of pictures saved as an **.avi** file that can be played like a video by other applications such as Windows Media Player.

To record a walkthrough

1. Begin by selecting the codec for recording walkthroughs. See "Selecting a Codec" on page 418.
2. Create a camera view. This view is the first frame of the walkthrough.

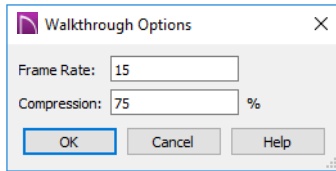
3. From the view, select **3D> Walkthroughs> Record Walkthrough** .
4. Specify a location and name for the walkthrough in the **Save Video As** dialog and click **Save**.
5. In the **Walkthrough Options** dialog:



- Select a **Frame Rate** between 1 and 100. The value entered is the number of frames per second.
 - Select a **Compression Percent** between 0 and 100. A value of 0 gives the highest quality images and the largest file size.
 - Click **OK**.
6. Use the camera movement tools to create additional views. Each time the screen redraws, that view is recorded as the next frame in sequence. See “Editing 3D Views” on page 385.
 7. When the walkthrough sequence is complete, select **3D> Walkthroughs> Stop Recording**  or close the view.

Note: Zooming in and out and using the scroll bars does not change the viewpoint and does not produce a frame for the walkthrough.

If you resize the current view window while recording a walkthrough, the program will stop recording.

To play a walkthrough

1. Select **3D> Walkthroughs> Play Walkthrough**  to open the **Select Video File** dialog.
2. Browse to an **.avi** file on saved on your computer. Your default video application plays the walkthrough video.

Selecting a Codec

A codec is a utility that compresses and decompresses media files, and is used when both recording and viewing **.avi** files such as walkthrough videos.

You can specify which codec to use when recording walkthroughs in the **Preferences** dialog. See “Render Panel” on page 62.

To choose the codec that best suits your needs, it is a good idea to create a test walkthrough using each of the codecs installed on your system to see how well their walkthrough quality and file compression meet your requirements.

For more information about codecs, visit www.HomeDesignerSoftware.com.

Importing 3D Symbols

Importing is the process of opening a file that was produced in a different program in Home Designer Interiors. Exporting, on the other hand, is the process of saving information in a Home Designer Interiors file to a format that can be read by another program.

Home Designer Interiors allows you to import and export a variety of information from and to other applications. This chapter focuses on importing a variety of 3D file formats. Other importing and exporting options are described in the chapters in which those objects or settings are discussed.

Chapter Contents

- Import Room Planner File
- 3D Data Import Requirements
- Importing 3D Symbols
- Symbol Specification Dialog
- 3D Symbols and Materials
- Export 360 Panorama

Import Room Planner File



Select **File> Import> Import Room Planner File**, then select and download a Room Planner file from the cloud. When prompted to log in, use the same credentials you used to save a plan to the cloud in Room Planner.

Files created in Room Planner versions 2 - 4.1 can be imported into Home Designer Interiors 2018.

Note that the exterior walls in an imported Room Planner drawing will inherit their thickness and other properties from the **Exterior Wall Defaults** dialog in the current

plan, while interior walls will retain the thickness that was set in Room Planner. See “Exterior and Interior Wall Defaults Dialogs” on page 134.

Unless a custom ceiling height has been specified in Room Planner, rooms in an imported file use the Default ceiling height set in the **Floor Defaults** dialog. See “Current Floor Defaults” on page 165.

Visit roomplanner.chiefarchitect.com for more information about the Room Planner mobile app.

3D Data Import Requirements

Importing a symbol that can be used by Home Designer Interiors is a relatively simple process that begins with previously created 3D data. This 3D data often comes from a program other than Home Designer Interiors. If you use another 3D modeling program to create the 3D data, be aware of the following requirements before attempting to create symbols.



Home Designer Interiors is not able to provide support for any third party software.

There are a number of requirements that must be met before any 3D data can be used to create a symbol in Home Designer Interiors:

- The 3D data must be stored in an, object (.obj), 3D Studio® Mesh (.3ds),

COLLADA (.dae), or SketchUp version 2017 and prior (.skp) file format. If you have 3D data in another format, you must convert it into one these formats first. Geometry and material information stored in .3ds files are imported; cameras and lights are not.

- The 3D model must be composed of 3DSOLID solid entities, or face data. Faces are typically referred to as 3D faces, polygonal faces, or poly meshes. Other types of entities such as lines, curves, circles, polylines, and free form surfaces can exist in the file but are not imported when the symbol is created. This is true for all (.obj/.3ds/.skp) file types.
- The face data should be assigned to different layers so that you can map them to the correct materials when viewing them

in 3D. It is helpful to name your layers using a convention that identifies that materials should be assigned to each sub-component.

- Pay attention to the origin and orientation of the 3D data when designing symbols. Home Designer Interiors allows some adjustment when creating the symbol, but it is easier to build the 3D data correctly before importing it into Home Designer Interiors. For more information about defining the origin, see “Symbol Origin” on page 1201.
- If a symbol with faces that have more than four vertices is imported, the faces are truncated, resulting in an object that appears to have holes. The best remedy is to re-export the model from the original application using only triangular or quadrilateral faces.
- Home Designer Interiors does not support grouped objects in symbols imported from **.3ds** files.

Surface Normals

If you use third party software to create an **.obj/.3ds/.skp** file that will be imported as a

symbol, you should be familiar with the concept of surface normals.



A surface normal is a vector that is perpendicular to the plane of a surface. This vector points in one direction, determined by the way the face is drawn.

If a face is drawn clockwise, the surface normals are directed outward; if a face is drawn counter-clockwise, the surface normals point inward. Home Designer Interiors assumes that the face on the positive side of the normal vector is the outside face.

Many objects can be drawn using only one side of each face. A cube is a good example: the inside of a cube is not visible, so it is not necessary to create its inside faces. When inside faces are not calculated, 3D views in Home Designer Interiors can generate more quickly.

Importing 3D Symbols



Home Designer Interiors supports the import of 3D surface and 3D solid objects saved in **.3ds**, **.obj**, **.dae**, and **.skp** formats.

There are three ways to import a 3D symbol into Home Designer Interiors:

- By selecting **File> Import> Import 3D Symbol**  tool.

- By selecting **New> 3D Symbol**  from the contextual menu in the Library Browser. See “Using the Contextual Menus” on page 332.
- By dragging and dropping the file from an operating system window into floor plan view.

Symbols imported by clicking and dragging are imported for use in the current plan, while those imported using the **Import 3D Symbol** dialog are also saved in the library. See “The Library” on page 329.

To drag and drop a 3D symbol file

1. Open the plan in which you would like to import a 3D symbol and remain in floor plan view.
2. Open an operating system window in front of the Home Designer Interiors program window.
3. Resize and position the window so that the Home Designer Interiors program window can be seen behind it.

4. Click on the desired **.3ds**, **.obj**, **.dae**, or **.skp** file and drag it into the Home Designer Interiors program window.
5. When your cursor changes to a +, click in the drawing area to place as many copies of the symbol as desired. When you are finished, select a different tool.

Symbols imported by clicking and dragging cannot be edited in the **Symbol Specification** dialog. If a symbol needs to be rotated, or its unit of measurement specified, use the **Import 3D Symbol**  tool to import it.

Symbol Specification Dialog



To import a symbol object, select **File> Import> Import 3D Symbol**.

Home Designer Interiors supports the import of 3D surface and 3D solid objects saved to **.3ds**, **.obj**, and **.skp** formats and treats imported symbols as stand alone fixtures.

The **Import 3D Symbol File** dialog, which opens first, is a typical **Open File** dialog in which multiple files can be group-selected for import. See “Importing Files” on page 45.

The **Symbol Specification** dialog opens next.

3D Panel

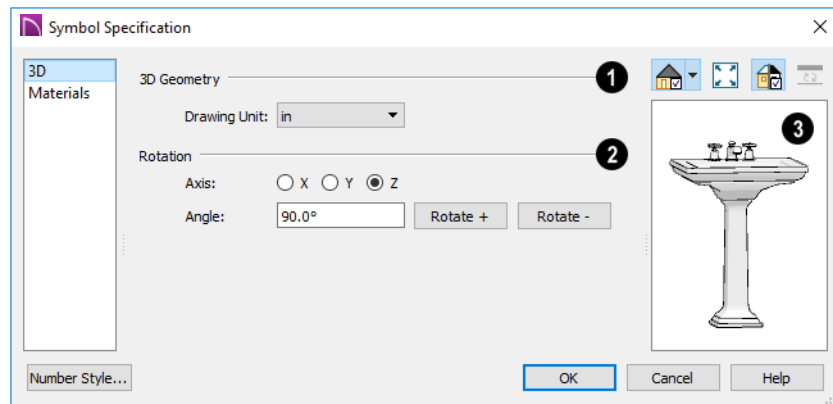

- 1 **3D Geometry** - Select the **Drawing Unit** that was used to create the symbol. If any units other than inches or mm are selected, the program will convert the data into units appropriate for Home Designer Interiors.

Note: SKP files are always imported using inches, regardless of the default units used in the plan file. See “Creating a New Plan” on page 38.

- 2 The **Rotation** settings allow you to rotate the selected symbol about the X, Y, and Z axes.
 - Select the **X**, **Y**, or **Z Axis**.
 - Specify the **Angle** to rotate the symbol in the text field. 90° is set by default.

- Click the **Rotate +** or **Rotate -** button to rotate the object around the selected axis in a clockwise or counterclockwise direction, respectively.

- 3 A preview of the symbol’s appearance displays here and updates as changes are made to the settings in this dialog. When multiple symbols are selected, the most recently selected symbol displays. See “Dialog Preview Panes” on page 28.

Materials Panel

The MATERIALS panel allows you to assign materials to the symbol’s components and is similar to the same panel in many specification dialogs. See “Materials Panel” on page 366.

3D Symbols and Materials

When a symbol is imported into Home Designer Interiors, material definitions may be included with it. How material

information is included depends on the symbol’s file format. See “About Materials” on page 361.

OBJ Files

Material definitions for most **.obj** files are saved in a separate file with the **.mtl** file extension. If such a file exists, the materials associated with the **.obj** file display in the list on the left side of the MATERIALS panel of its specification dialog.

If Home Designer Interiors does not receive material definition information in an accompanying **.mtl** file, default material properties are assigned.

Material definitions for **.obj** files can also include texture information in the form of image files (**.jpg**, **.png**, etc).

In order to properly import an **.obj** file, Home Designer Interiors needs the **.obj** file, the **.mtl** file, and any referenced texture files. If a texture file is not available, the material it is associated with is created without a texture.

The material definitions associated with an imported **.obj** symbol are not available for use by other objects in Home Designer Interiors until that symbol has been placed into a plan. The associated texture files are

then copied to the user's Textures folder. See "Home Designer Interiors Data" on page 37.

3DS and DAE Files

Material definitions for **.3ds** and **.dae** files refer to texture information in separate image files.

In order to properly import a **.3ds** and **.dae** file, Home Designer Interiors needs these referenced image files. If a texture file is not available, the material it is associated with will be created without it. The associated texture files are copied to the user's Textures folder.

SKP Files

The textures associated with a **.skp** file are saved in the file. After you import a symbol and either place it in a plan or add it to the Library, these textures are saved in the Home Designer Interiors Textures folder.

Home Designer Interiors does not support deformed textures. If a texture associated with a **.skp** file is deformed, it will be imported without the deformations.

Texture Filename Conflict

If a texture of the same name already exists in the plan when an **.obj**, **.3ds**, or **.skp** file is

imported, the **Texture Filename Conflict** dialog displays.

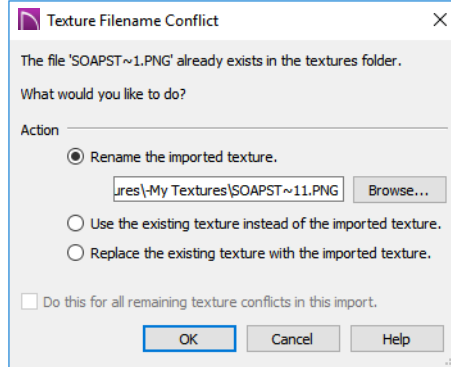

- Select **Rename the imported texture**, then click the **Browse** button to create a

copy of the texture's image file with a new name that you specify.

- Select **Use the existing texture instead of the imported texture** to keep the existing texture.
- Select **Replace the existing texture with the imported texture** to replace the texture already present in the plan with the new, imported one.
- Check **Do this for all remaining textures in this object** to use the same selection for all textures with filename conflicts associated with this symbol.

Export 360 Panorama



The **Export 360 Panorama** tool creates a spherical panoramic image that can be opened in various panorama viewers. Select **File> Export> Export 360 Panorama** while a 3D view is active to access this tool.

For best results, position the camera as near as you can to the center of the scene before exporting.

Export 360 Panorama File

All of the settings in this dialog are retained during the current program session.

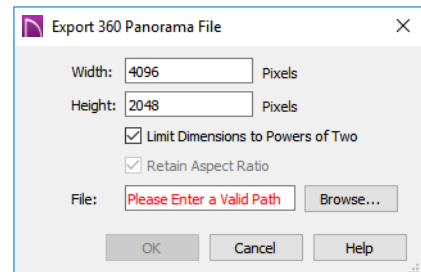

- Specify the **Height** and **Width** of the exported image file, in pixels.
- Check **Limit Dimensions to Powers of Two** to restrict the Width and Height to values that are powers of two. When this is checked and an ineligible value is entered, it will adjust up or down to the nearest power of two. Although not required, this option is recommended for best results in some panoramic image viewers.

- The **Retain Aspect Ratio** check box displays for reference and cannot be changed. The ratio between Width and Height is 2 to 1 when Limit Dimensions to Powers of Two is unchecked, above.
- Specify the full pathname of the **File** you wish to export, or click the **Browse** button to open the **Write Image File** dialog, which is a typical File Save dialog. See “Exporting Files” on page 41.

When you click OK, a panoramic image is created and a progress dialog may display.

Because spherical panoramas are composed of multiple images stitched together, they may take longer to create than a standard exported image.

Export 360 Panorama is not available in plan files that were originally created in Chief Architect and are not set to allow editing in Home Designer. See “Opening Chief Architect Plans in Home Designer Programs” on page 36.

Materials Lists

Materials Lists can be created for individual rooms in your plan, edited, and printed directly from the program. They can also be exported as text files for use in other programs.



The Materials List is based on certain assumptions that may not match your building style. Home Designer Interiors makes no representation as to the accuracy or reliability of the Materials List generated by Home Designer Interiors. Always compare the Materials List with a manual take-off before providing a quote or ordering materials for a job.

Chapter Contents

- The Materials List
- Creating an Accurate Materials List
- Organizing Materials Lists
- Materials List Display Options Dialog
- Editing Materials Lists
- Printing and Exporting the Materials List
- Conditioned Area Totals

The Materials List

A Materials List is like a snapshot of the current plan at the time that the list is made. Any changes made to the model after a Materials List is generated are not included in that list. Create a new Materials List if you would like it to include these changes.

It is not necessary to wait until the plan is complete to generate a Materials List. In fact, you can create a series of Materials Lists reflecting costs at various stages of a project.



For comparison, generate Materials Lists with and without a proposed plan modification.



To create the Materials List for a room, select the room and then select **Tools> Calculate Materials for Room**.

Calculate Materials for Room  is also available on a selected room's edit toolbar. See "Editing Rooms" on page 168.

A Materials List calculated from a room is created for only the contents of that room: wall materials are not included.

Creating an Accurate Materials List

In order to take full advantage of Home Designer Interiors's Materials List capabilities, bear in mind that using generic objects like geometric shapes from the

library to represent objects that aren't available in Home Designer Interiors can result in items being calculated in the Materials List in a manner that you might not expect.

Organizing Materials Lists

You can control what items are calculated in the Materials List by specifying which categories are used.

There are some parts of a model that cannot be excluded from the Materials List. Floor and ceiling platforms are prime examples. If

you need to generate a Materials List for only part of a plan, such as an addition, consider making a copy of the plan file. In the copy, delete the as-built portion of the plan and then generate a Materials List.

ID	Floor	Size	Description	Count	Extra	Unit	Price	Total Cost	Comment	Label
General										
GN1	0	36 high Wall	8" Concrete Stem ...	64	0	ft		\$0.00		
GN2	1		thermal envelope - ...	232.92	0.00	sq ft		\$0.00		
GN3	1		thermal envelope - fl...	224.94	0.00	sq ft		\$0.00		
GN4	1	109 1/8 high...	Siding-6	65	0	ft		\$0.00		
GN5	1	109 1/8 high...	Interior-4	15	0	ft		\$0.00		
GN6	1		thermal envelope - ...	128.00	0.00	sq ft		\$0.00		
GN7	1		thermal envelope - ...	150.00	0.00	sq ft		\$0.00		
GN8	1		thermal envelope - ...	128.00	0.00	sq ft		\$0.00		
GN9	1		thermal envelope - ...	156.00	0.00	sq ft		\$0.00		
								Subtotal:	\$0.00	
Foundation										
FO1	0	8" thick	Concrete	4.72	0.00	cu yd		\$0.00		
FO2	0	16" thick	concrete footing - c...	2.10	0.00	cu yd		\$0.00		
FO3	0		foundation bolts	18	0			\$0.00		
FO4	1	4" thick	concrete slab - con...	0.64	0.00	cu yd		\$0.00		
								Subtotal:	\$0.00	

Categories

The line items in the Materials List are organized into a set of predefined categories, such as Electrical and Framing, which display in the **ID** column.

Unlike other categories that calculate materials or objects, the General category lists information about the building's thermal envelope. See "Conditioned Area Totals" on page 431.

To specify a line item's category

1. Create a Materials List.
2. Click in the cell in the ID column for a line item.
3. Select the desired category from the drop-down list that becomes available.

The categories that are available cannot be altered; however, you can specify which categories are included for individual lists in the **Materials List Display Options** dialog.

Materials List Display Options Dialog



When a Materials List is open, select **Tools > Display Options** to open the

Materials List Display Options dialog for the current list.

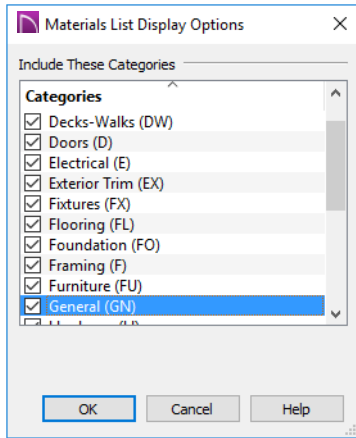

The Categories listed here appear in the ID column of the Materials List in the order they are presented here.

- Check the box beside the name of each category that you want to display in the currently active Materials List.
- Multiple rows can be selected together using Shift and Ctrl keys. See “Shift and Ctrl Select” on page 93.

Note: The information in a suppressed category is still part of the Materials List. If the Materials List is exported, suppressed categories are exported, as well.

Editing Materials Lists

Materials lists can be edited in a variety of ways. You can adjust the width of a column by clicking and dragging the bar on the right side of the column name.

Adding Information

You can enter information in the Price and Comment columns for each item.

Adding price or other information for any item is straightforward. Simply click in the cell and type the desired information.

Changing Information

You can change the information in any column in an individual Materials List. As with added information, click in a cell to select the existing text, then type in the desired text.

To move an item in a Materials List to a new category, select the cell in the **ID** column and

choose a new category from the drop-down list that becomes available. See “Categories” on page 429.

Total Cost

Total Cost is calculated using the Count, Unit, Price, %Markup, Labor and Equipment columns to calculate the cost. The formula used is:

$$(\text{Count} + \text{Extra}) * \text{Price} * (1 + (\% \text{Markup}/100)) + ((\text{Count} + \text{Extra}) * \text{Labor}) + ((\text{Count} + \text{Extra}) * \text{Equipment})$$

If a column does not appear, 0 is used for the value of that column with the exception of Count and Price, which are always used in the calculation even if they are not shown.

Copying Information

Portions of a Materials List can be copied and then pasted into a **Text**  object or into

a word processing program or spreadsheet program using the standard Windows Copy (Ctrl + C), Cut (Ctrl + X), and Paste

(Ctrl + V) commands. See “Copying and Pasting Text” on page 203.

Printing and Exporting the Materials List



To print a Materials List, select **File> Print** while the Materials List window is active. See “Print View Dialog” on page 439.



A Materials List can also be exported into a tab delimited text (.txt) file that can be opened directly by most spreadsheet programs. In a Materials List window, select **File> Export Materials List**.

The **Write Materials Export File** dialog will open. This is a typical File Save dialog. See “Exporting Files” on page 41.

Estimating Software

You can export a Materials List to a word processor or spreadsheet program to arrange

it in your estimating format. You can also export the Materials List to a number of commercial estimating programs in whose databases you can keep your current pricing and generate reports based on this data.

Before purchasing an estimating software program, be sure that the program supports the direct import of Chief Architect Materials Lists.

Any questions regarding estimating software packages and how they interact with Home Designer Interiors should be directed toward the company providing the estimating software. Home Designer Interiors is unable to provide any technical support for third party programs.

Conditioned Area Totals

Conditioned Area is the space within a building that is heated and/or air conditioned, and a Thermal Envelope is a three dimensional boundary built around the Conditioned Space that separates it from the unconditioned space around it. Thermal Envelopes are composed of floor platforms, ceiling platforms, walls, doors, and windows.

When a Materials List is created, Home Designer Interiors calculates the total areas of the components that make up a structure’s Thermal Envelope and lists them in the

General category of the Materials List. See “Categories” on page 429.

Doors are always categorized as doors rather than as windows. This is the case even when a door is specified as a Glass Door or when it is part of a mullied unit.

Conditioned area totals can be entered into third party programs such as **REScheck™** to determine whether the plan meets the energy code in use in your area.

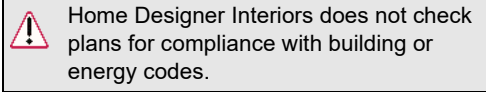

Conditioned Area

With the exception of Unspecified rooms, rooms that are assigned an interior Room Type are included in the Conditioned Area. “Open Below” rooms are also included; however, other hybrid Room Types as well as exterior Room Types are not. See “Room Types” on page 165.

Building Orientation

Walls, doors, and windows are categorized as north-, south-, east-, or west-facing for the purposes of conditioned area totals. The definition of North in a plan is straight up on screen in floor plan view.

- If a wall is oriented at 45° or less to north in a plan, it will be categorized as a

“North” wall. Any doors and windows in this wall will also be categorized as “North”.

- Similarly, walls, doors, and windows oriented within 45° of south, east, or west will be classified as “South”, “East” or “West”, respectively.

The orientation of a curved wall is based on the direction of its chord.

The General Category

The General category of the Materials List lists information about the Thermal Envelope of the current plan. The total linear length of each wall type used in the plan is also calculated in the General category. Walls with different heights are each listed separately. See “Wall Type Definitions” on page 152.

Printing

Home Designer Interiors provides a variety of printing options.

Home Designer Interiors also allows you to save your drawings in **.pdf** file format that can then be sent to a printing service.

Note: Screen captures are provided for illustrative purposes only and are not an endorsement of any products.

Chapter Contents

- Introduction to Printing
- The Printing Tools
- Drawing Sheet Setup Dialog
- Print Preview
- Printing to Scale
- Printing Across Multiple Pages
- Printing to a PDF File
- Print View Dialog
- Print Image Dialog

Introduction to Printing

Home Designer Interiors offers printing options to suit a variety of needs. It is helpful to be familiar with these options and choose the one that makes the most sense for the project at hand.

Output Options

Printing a View - Floor plan view can be printed to scale. See “The Printing Tools” on page 435.

Printing an Image - Any view of your plan can be printed as an unscaled image. See “Print Image Dialog” on page 442.

Printing to PDF - Plans can be printed to a .pdf file and printed remotely. See “Printing to a PDF File” on page 439.

Terminology

Paper Size - The dimensions of the paper to be printed on. Specifying a paper size that is smaller than the scaled drawing allows large drawings to be printed across multiple pages.

Drawing Scale - Drawings are often printed to scale for accuracy. $\frac{1}{4}'' = 1'$ and $1\text{ m} = 50\text{ m}$ are examples of common scales. You can specify this scale in the **Drawing Sheet Setup** dialog. See “Drawing Sheet Setup Dialog” on page 435.

When a particular scale is not important, drawings can also be sized to fill a particular area. See “Printing to Scale” on page 438.

Printing Problems

If you encounter difficulties when trying to print, see “Troubleshooting Common Technical Issues” on page 450.

Printer Drivers

A printer driver is a program that allows a printer to communicate with the rest of the computer system. Drivers are usually created by the printer manufacturer, are typically updated regularly, and can usually be downloaded free of charge from the manufacturer’s web site.

In addition to interpreting between the printer and the rest of the system, printer drivers save default page size, orientation, margin size, and other information that Home Designer Interiors refers to unless you specify otherwise. See “Print View Dialog” on page 439.

If you experience printing problems, consider installing updated drivers for your printer. Visit your printer manufacturer’s web site for more information.



Options available with one driver may not be available with another. Printers supported in one operating system may not be supported by the manufacturer in another.

Clearing Printer Information

Some information specific to individual printers, such as available paper sizes, is saved with each plan file. You can select **File> Print> Clear Printer Info** to clear the

printer-specific information stored with the plan file.

Displaying Objects



You can control the display of objects when printing directly from a view in

the **Display Options** dialog. See “Display Options Dialog” on page 88.

Objects must be visible in order for them to print; however, not all items that are visible will print. See “Print Preview” on page 437.

The Printing Tools



Select **File> Print** to view the Print Tools submenu. These tools fall into two categories.

based on the current scale and other settings. See “Print Preview” on page 437.

Print Setup Tools



Drawing Sheet Setup - Opens the **Drawing Sheet Setup** dialog. See “Drawing Sheet Setup Dialog” on page 435.



Scale to Fit - Automatically selects a scale that fits your plan to the printer page. See “Printing to Scale” on page 438.



Center Sheet - Automatically centers the drawing sheet on your drawing. See “Center Sheet” on page 437.



Print Preview - Shows on screen how the current view will appear printed,

Print Tools



Print - Prints the current floor plan to a specified scale. See “Print View Dialog” on page 439.



Print Image - Prints the current view including images, textures, and backdrop. Views printed with Print Image are not scaled. See “Print Image Dialog” on page 442.

Clear Printer Info - Clears the printer information associated with the current page setup.

Drawing Sheet Setup Dialog



Select **File> Print> Drawing Sheet Setup** to open the **Drawing Sheet Setup** dialog.

The **Drawing Sheet Setup** dialog is only available when floor plan view is active.

When a perspective view is active, **Drawing Sheet Setup**  is not available.

The settings in this dialog are specific to the current view and are saved with the .plan file..

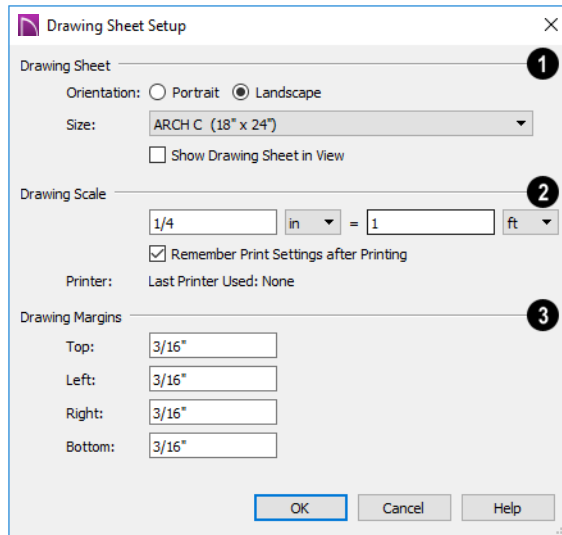

1 Specify the **Orientation** and **Size** of the **Drawing Sheet**, which is the final printed output.

Check **Show Drawing Sheet in View** to turn on the display of the Drawing Sheet in orthographic views. See “Drawing Sheet” on page 437.

2 Specify the **Drawing Scale** for the active view. This scale is applied only when the view is printed.

The scale is specified in two parts, which by default are ¼ inch = 1 ft or 1 m = 50 m. Both imperial and metric units of measurement are available and can be selected independently.

- Uncheck **Remember Print Settings** **after Printing** to use the default settings every time a **Print** dialog is opened. When checked, the program remembers your settings for each type of view. This setting is global, affecting all plan files.

3 Specify the **Drawing Margins**, which define the extents of the printable area of the active view’s Drawing Sheet.

- Specify the width of the desired **Top**, **Left**, **Right**, and **Bottom** margins.

Clearing Printer Information

Select **File> Print> Clear Printer Info** to clear the printer-specific information stored in the **Drawing Sheet Setup** dialog.

Print Preview



Print Preview and its related display toggles allow you to get a sense of what the current view will look like when it is printed.

Print Preview



Select **File> Print> Print Preview** for an on-screen representation of how the current view will appear when printed. Print Preview is only available in floor plan view. See “Printing to Scale” on page 438.

The printer page displays as a solid white rectangle, and blue lines along the edges of the printer page indicate the edges of the printable area, as defined by the currently selected printer. See “Drawing Sheet Setup Dialog” on page 435.

Objects such as camera symbols, and the Reference Grid that do not print do not display in **Print Preview** . Text and dimension objects appear on-screen as they will on the printed page.

When **Print Preview**  is enabled, color will display depending on whether **Print in Color** is selected in the **Print View** dialog. See “Print View Dialog” on page 439.

The Reference Display does print if it is visible. See “Reference Floor Display” on page 293.

Color

The **Color** toggle turns the on-screen display of color on or off in all views.

Reference Grid

The **Reference Grid** is an on-screen grid composed of regular squares that can be used to convey a sense of scale while drawing. It does not print, and its size can be specified in the **General Plan Defaults** dialog. See “General Plan Defaults Dialog” on page 56.

Drawing Sheet

The Drawing Sheet is a representation of the size and orientation of the final printed output. It is different from the printed page size, which means that you can print a large Sheet to multiple smaller pages.

The Drawing Sheet size and orientation are specified in the **Drawing Sheet Setup** dialog. See “Drawing Sheet Setup Dialog” on page 435.

When the Drawing Sheet is set to display, a blue border representing the margins of the printable area will also display for reference.

Center Sheet



Select **File> Print> Center Sheet** to center the printer page on the drawing. This moves the printer page relative to the drawing but does not affect the coordinates of objects in the drawing. The location of the printer page is independent for each floor of the model.

Printing to Scale

Several different print scaling options are available. The type of view that you are printing determines which options you may choose from.

Floor plan views can be printed to scale.

The scale set in the **Page Setup** dialog is inherited by the **Print** dialog. This scale can be overridden on an individual basis in the **Print** dialog. See “Print View Dialog” on page 439.

Select **File> Print> Scale to Fit**  to select a suitable scale and re-center the printer page so that everything fits on the page.

Imperial drawing scales are typically noted in inches per foot. Larger scales, such as 1

inch = 50 feet or 1:200m, are often used for property layouts.

Perspective Views

Camera views and overviews display the model much the way the eye would see it and cannot be scaled.

- Objects in the view may be at any angle relative to your line of sight.
- Objects seem to decrease in size as their distances from the viewer increase.

Perspective views can only be printed using the **Print Image**  tool. See “Print Image Dialog” on page 442.

Printing Across Multiple Pages

When printing directly from a floor plan view it is possible to print at a scale that does not fit the drawing on one page.

To see on-screen what the drawing will look like when printed, select **File> Print> Print**

Preview  and then **Window> Fill**

Window . Grey lines across the drawing sheet indicate where the page breaks will occur. See “Print Preview” on page 437.

To print across multiple pages

1. Select **File> Print> Print Preview**  to display the white rectangle representing the printer paper. See “Print Preview” on page 437.

2. Click the **Select Objects**  button, then click near an edge of the printer paper rectangle to select it.

When selected, the printer paper is highlighted in pale grey and a square Move edit handle displays at its center.

3. Click and drag the Move edit handle to position the printer paper so that the portion of your drawing that you would like to print on your first page is located within the printable area of the page.
4. Select **File> Print> Print** . In the **Print** dialog, make sure **To Scale** is selected, then click OK. See “Print View Dialog” on page 439.

5. Select the printer paper rectangle and move it so that the desired contents of your second printed page are within the printable area and print **To Scale**.
6. Continue moving the printer paper and printing as needed.

When printing multiple pages, it is generally a good idea to leave some overlap on the edges of each page to make sure that information near those edges is not left off the printed pages by mistake.

Printing to a PDF File

Portable Document Format, or **.pdf** files, are one of the most universally compatible and efficient file formats and can be viewed and printed on most computer platforms.

You can save any view as a **.pdf** file by selecting “Chief Architect Save as PDF” as the Destination printer **Name** in either the **Print View** or **Print Image** dialog. See “Print View Dialog” on page 439 and “Print Image Dialog” on page 442.

If you have a **.pdf** writer installed on your system, you can use it to create a **.pdf** file instead. To print to **.pdf**, simply select it as the Destination printer **Name** in the **Print View** or **Print Image** dialog.

When you print to **.pdf**, you will be asked to create a file name and choose a destination to save it in the **Save as PDF File** dialog. For more information, see “Saving, Exporting, and Backing Up Files” on page 39.

Print View Dialog



To print from floor plan view and the Materials List, select **File> Print> Print**. The **Print View** or **Print Materials**

List dialog opens. The settings that are available will vary depending on which version of the dialog is open.

Note: 3D views can be printed using Print Image.

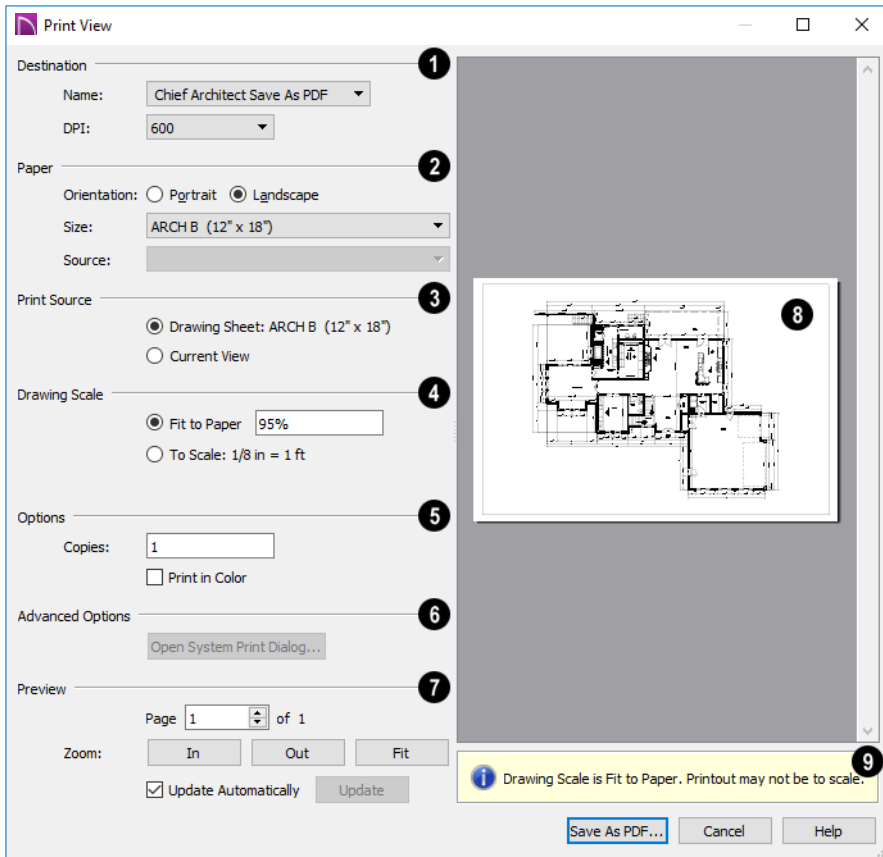

- 1 Select the **Name** of the **Printer** that you would like to use from the drop-down list. To print to **.pdf**, select “Chief Architect Save as PDF” from the list, or choose a **.pdf** writer installed on your system. See “Printing to a PDF File” on page 439.
 - Select the **DPI**, or Dots Per Inch to use when printing, from the drop-down list.

The available options may vary depending on the selected printer.

- 2 Select the **Paper Orientation**, **Size**, and **Source**. The available Size and Source options are controlled by the selected printer’s driver.

- When possible, the program will automatically set the Size and Orientation to match those of the Drawing Sheet.
 - The Paper Size may be automatically adjusted if the Drawing Scale option is changed, below.
- 3 Specify the **Print Source**. Not available in the **Print Materials List** dialog.
 - Select **Drawing Sheet** to print the entire sheet even though you may be zoomed in on a portion of the view.
 - Select **Current View** to print only that portion of the active view that is currently visible on screen. If you are zoomed out, any blank space outside of the printable objects in the view is ignored.
 - 4 Specify the **Drawing Scale** of the printed output. Changes to these options may cause the Paper Size to change, above. Not available in the **Print Materials List** dialog or in camera views or overviews.
 - **Fit to Paper** prints the view on one page. The program uses whatever scale is necessary to fit the plan on one page.
 - When **Fit to Paper** is selected, specify the percentage of the paper to be used. The default value is 95%.

Note: The Fit to Paper percentage value is global - affecting all views in all files, and is retained between sessions.

- Select **To Scale** to print at the scale specified in the **Drawing Sheet Setup** dialog. See “Drawing Sheet Setup Dialog” on page 435.

- 5 **Options** - Specify the number of **Copies** you would like to print.
- 6 **Advanced Options** - Click the **Open System Print Dialog** button to close the **Print View** dialog and print using your operating system’s Print dialog instead. Not available when No Printer is selected.
- 7 Control the appearance of the print job **Preview** on the right side of the dialog.
 - Specify the **Page** that displays in the Preview area.
 - Click the buttons to **Zoom In**, **Zoom Out**, or **Fit** the selected Page to the extents of the Preview area.
 - Uncheck **Update Automatically** to turn off the print job Preview and prevent it from updating as changes are made to the settings in this dialog.
 - Click the **Update** button to update the print job Preview to reflect the current settings in this dialog. If Update Automatically is unchecked, clicking Update may force the Preview to be blank.
- 8 When **Update Automatically** is checked, a preview of the current print job displays here. The drawing sheet displays as a white rectangle, and if multiple sheets are required, you can scroll through them. If the print job is large, a progress dialog may display briefly as the preview draws or updates.
- 9 To help prevent unwanted printed output, information messages regarding page size, resolution, and scale may display here, depending on the settings in this dialog.

Print Image Dialog

 Any view can be printed by selecting **File > Print Image**. This is the only way to print 3D views. See “3D Rendering” on page 393.

The **Print Image** dialog is similar to the **Print View** dialog; however, the printing process is different. **Print Image** prints individual pixels as opposed to vectors (lines).

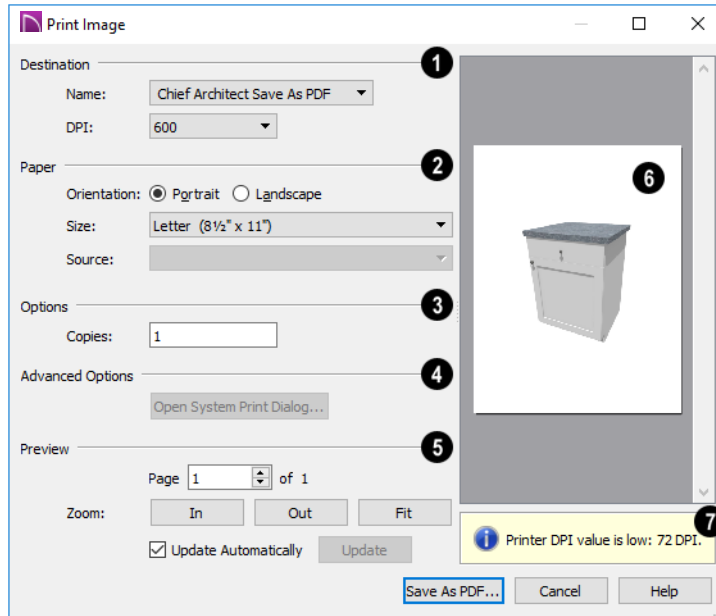

1 Select the Name of the **Printer** you wish to use from the drop-down list. To print to **.pdf**, select “Chief Architect Save as PDF” from the list, or choose a **.pdf** writer installed on your system. See “Printing to a PDF File” on page 439.

2 Select the **Paper Orientation, Size, and Source**. The available Size and Source options are controlled by the selected printer’s driver. See “Printer Drivers” on page 434.

3 Specify the number of **Copies** you would like to print.

4 **Advanced Options** - Click the **Open System Print Dialog** button to close the **Print View** dialog and print using your operating system’s Print dialog instead. Not available when No Printer is selected.

5 Control the appearance of the print job **Preview** on the right side of the dialog.

- Specify the **Page** that displays in the Preview area.
- Click the buttons to **Zoom In**, **Zoom Out**, or **Fit** the selected Page to the extents of the Preview area.

- Uncheck **Update Automatically** to turn off the print job Preview and prevent it from updating as changes are made to the settings in this dialog.
 - Click the **Update** button to update the print job Preview to reflect the current settings in this dialog. If Update Automatically is unchecked, clicking Update may force the Preview to be blank.
- 6 When Update Automatically is checked, a preview of the current print job displays here. If the print job is large, a progress dialog may display briefly as the preview draws or updates.
 - 7 To help prevent unwanted printed output, information messages regarding page size and resolution may display here, depending on the settings in this dialog.

Additional Resources

Home Designer Interiors offers a variety of resources to help you become familiar with the many features it offers.

- Reference Manual
- User's Guide
- Online Help Videos
- Home Designer Web Site
- Online Home Designer Samples Gallery
- HomeTalk Online User Forum
- Technical Support

Reference Manual

The Home Designer Interiors Reference Manual is a comprehensive source of information for Home Designer Interiors 2018. Chapters are organized by subject, beginning with the fundamental concepts and progressing to the more advanced features.

The Reference Manual is presented in .pdf file format and includes a Table of Contents and Index. This manual is available online by selecting **Help > View Reference**

Manual  from the program menu.

User's Guide

Written for new Home Designer Interiors users, but a helpful reference for users of all experience levels as well, the User's Guide features a series of tutorials designed to introduce the basics of using the program.

The Home Designer Interiors User's Guide is organized by topic and walks you through the process of creating a complete model, from the first wall to the interior design and landscaping.

This guide is available online by selecting **Help> View User's Guide** from the program menu.

Online Help Videos

Another resource designed to illustrate Home Designer Interiors's tools is the set of tutorial videos available on our web site.

To view the online videos, select **Help> View Online Help Videos** from the program menu or visit www.homedesigner.chiefarchitect.com/videos.

Home Designer Web Site

If you have questions that the online Help feature has not answered, feel free to turn to our web site.

A database of common technical support questions and answers related to Home

Designer Interiors is available through a searchable interface.

Select **Help> Visit Home Designer Web Site**  from the menu to launch your default internet browser to www.HomeDesignerSoftware.com.

Online Home Designer Samples Gallery



A collection of plan sets and renderings is available for viewing and download on our web site.

Select **File> Download Sample Plans**  to launch your internet browser to www.HomeDesignerSoftware.com

HomeTalk Online User Forum

The HomeTalk Bulletin Board offers several ongoing discussions about a variety of topics related to the use of Home Designer Interiors. It's rich with useful tips and available free of charge to all registered Home Designer Interiors users.

- Discussions are initiated and carried out by users.
- Experienced users share knowledge with each other and beginners.
- Home Designer Interiors Staff members post announcements, advice and technical information.

To visit the HomeTalk forum, select **Help>**
HomeTalk or go to
hometalk.chiefarchitect.com.

Technical Support

Chief Architect takes pride in offering world class technical support services that can be accessed by telephone or on our web site. Select **Help> Technical Support** from the program menu to visit www.HomeDesignerSoftware.com.

Before contacting Technical Support, take a moment to see if the answer to your question is found in the Help resources, tutorial videos, or in our online Knowledge Base at: www.HomeDesignerSoftware.com.

When you contact us, Technical Support will refer you to these resources if the answer can be found there.

So that our Technical Support specialists can assist you as efficiently as possible, please refer to “Technical Support Services” on page 449 for additional trouble-shooting suggestions and information that will be needed before placing your call.

Technical Support Services

Chief Architect is committed to providing world-class technical support to complement our products.

The primary function of technical support is to make sure our software is functioning

correctly and to help you quickly resolve problems that prevent its normal use. Our technical support professionals are eager to work with you to make certain our software is functioning as designed.

Reference and Training Resources

Chief Architect offers a variety of reference options in addition to the resources that come standard with the program.

Online Knowledge Base

The Home Designer online **Knowledge Base** contains a variety of articles describing how to resolve common technical problems and achieve specific design goals.

The Knowledge Base is found in the Technical Support section of the Web site and can be referred to again and again at your

convenience at www.HomeDesignerSoftware.com.

Online Help Videos

Chief Architect has developed a collection of training videos that contain in-depth training on a wide range of topics. These videos are available on our Web site, www.HomeDesignerSoftware.com.

User Forum

Our HomeTalk User Forum is a great place to discuss and exchange ideas with other

Home Designer Interiors users. Here you can post questions, read discussions from other users, and post suggestions to improve our product. In addition to our regular users, from time to time our support and

engineering teams monitor the forum and provide input and discussion on current topics. This resource is available free of charge at hometalk.chiefarchitect.com.

Troubleshooting Common Technical Issues

Chief Architect strives to make certain our software works correctly; however, from time to time issues arise that prevent its normal operation.

Installation Issues

The following are common reasons for installation failure of Home Designer Interiors and other software:

- Anti-virus software is enabled and interfering with installation. Anti-virus software is the most common cause of installation failures for any type of software. Refer to your anti-virus software's documentation for details on how to disable the software and re-enable it once installation is complete.
- The recommended minimum system requirements are not met. See "System Requirements" on page 7.
- The computer has a CD drive but not a DVD drive. A standard CD drive will not read DVD discs.

- The DVD has fingerprints, scratches, or other defects. Sometimes a small fingerprint can prevent the program from installing. Clean the disk with soft cotton cloth. Be sure to use soft cotton rather than paper products on disks to avoid scratching.



If you see visible cracking on a CD or DVD, do not insert it in your CD/DVD drive. Cracked disks can fly apart and cause damage to your drive.

- You do not have sufficient rights to install the software. Verify that you have administrative rights and the administrative password during the installation process. If you are on a corporate network, consult your network administrator for assistance.

Refer to the online **Knowledge Base** for solutions to common installation problems. If the answer to your question is not found there, contact our Technical Support department for assistance.

Troubleshooting Printing Problems

Printing problems fall into two main categories: those that prevent the printer from working in any program and problems

printing from Home Designer Interiors. To determine if the problem is specific to Home Designer Interiors, try the following:

1. Begin by clicking on the Windows **Start** button, and select **Printers**.
2. Right-click the printer that is not functioning properly in the **Printers** folder.
3. Click **Properties** from the menu that appears.
4. On the **General** tab, click the **Print Test Page** button.

If the printer does not produce a test page, the problem is not one that Chief Architect Technical Support can solve. Follow these suggestions:

- Check the connection between the computer and the printer.
- Check your printer documentation for troubleshooting printer problems.
- Contact your printer's manufacturer or check their Web site for support information.

Your printer manufacturer is the best resource for solving problems of this type. Chief Architect Technical Support is not able to help diagnose and solve problems that prevent printing from any program.

 It is a good idea to keep the Owner's Manual for your printer close at hand. Write inside the Owner's Manual the various phone numbers for technical support for that printer – for the original manufacturer and for your local dealer.

Printers vary widely in how they function. Sometimes a faulty cable can be a problem. Often, solving a printing problem is as simple as downloading and installing an updated printer driver. See “Printer Drivers” on page 434.

If you can print from Home Designer Interiors but are not satisfied with the output, refer to “Printing” on page 433 for information on how to set up and use the printing functions in the program. Legacy users should bear in mind that each release has new features and enhancements, so techniques that were used in prior versions may not work in the current version.

Make sure that you use **Print Preview**  before printing. Print Preview displays the printed paper, or drawing sheet, as a white rectangle on screen, and shows how the sheet is scaled and positioned relative to your drawing. If the drawing is not on the drawing sheet on-screen, it will not be on the sheet when you print. See “Print Preview” on page 437.

Make sure that your scaling is correct for the paper size. If the plan is much smaller or much larger than the drawing sheet, you may need to change your Scale. See “Printing to Scale” on page 438.

64 Bit Versions of Windows

Some printers may not function correctly on 64 bit Windows operating systems. If you are experiencing a printing problem while using a 64 bit version of Windows, please contact the printer's manufacturer to verify that you have the correct driver installed.

Printing to a legacy parallel printer port on a Windows 64 bit machine may not work correctly when using a hardware lock. USB printers should not be affected.

Clearing Printer Information

Some information specific to individual printers, such as available printer paper sizes, is saved with each plan file.

If you are encountering problems when printing, or unexpected options in the **Page Setup** dialog, select **File> Print> Clear Printer Info** to clear the printer-specific information stored with the plan file.

After using **Clear Printer Info**, select **File> Print> Page Setup** . Make sure the

settings in the **Page Setup** dialog are correct, and then click **OK** and **Save**  the file.

Online Knowledge Base

For answers to frequently asked questions regarding printing and other topics, select **Help> Visit Home Designer Interiors Web**

Site  and browse the Technical Support section of our Web site, www.HomeDesignerSoftware.com.

Our Technical Support specialists post new articles periodically to help resolve problems that you may encounter.

Error Messages

Most common error messages have a known cause and simple resolution. When you encounter an error or warning message in Home Designer Interiors, you can click the **Check Knowledge Base** button in the message box to launch your default internet browser to the Home Designer Knowledge Base on our Web site, www.HomeDesignerSoftware.com.

If an article discussing the message is available it will display, providing information about the message and how best to avoid it.

It is important that abnormal errors be reported to Chief Architect Technical Support so that we can identify and resolve any problems.

The content of an error message is useful in diagnosing its cause. If you encounter an error message, read it carefully and write

down the error number and the exact text of the error message.



Press the Print Screen key on your keyboard to capture a picture of the error message. Open a new word processing document or e-mail message and choose **Edit> Paste** to paste a copy of the error message into the document for later reference.

If you encounter the error more than once, make a note of your steps prior to receiving the message.

Before you report an error, check the Knowledge Base to see if the error is already documented by typing the error message or part of the error message into the search form.

Finally, check to see if there are program updates available. These updates are provided free for the current version of Home Designer Interiors and contain

enhancements and other changes that allow the program to perform at an optimum level. Select **Help> Download Program Updates** from the Home Designer Interiors menu and follow the instructions on our Web site, www.HomeDesignerSoftware.com.

Error Reporting

When an error occurs, you may have the option in the message box to send the report to Chief Architect.

No personal information is sent. When you click **Send**, your default internet browser launches and a Web page appears on screen. This message confirms that the report was sent successfully and may give you further instructions on how to proceed.

Contacting Technical Support

Before contacting Technical Support, take a moment to see if the answer to your question is found in the Reference Manual, Help index, or in our online Knowledge Base. When you contact us, Technical Support will refer you to these resources if the answer can be found there.

Chief Architect's world-class technical support is available Monday through Friday from 6 AM to 5 PM Pacific Standard Time and can be reached at (208) 292-3375 or via our Web site, www.HomeDesignerSoftware.com.

There are several things you can do to ensure a speedy answer to your question when you contact Technical Support.

- Before contacting Technical Support, select **Help> About Home Designer Interiors** and make a note of the first characters of your Product Key and the exact version of Home Designer Interiors you are using. Technical support is available to the owners of software licenses. When you contact Technical Support, be prepared to verify that you are the owner of the software license.
- Before contacting Technical Support, check to see if there are program updates available for download. Our engineering team periodically creates updates to the program to resolve functionality or program issues that were unknown at the time of release. These updates are provided free of charge for the current released version and can be accessed by selecting **Help> Download Program Updates** from the menu.
- When you first encounter a problem or error message, copy the exact wording of the message or a detailed description of the problem. This helps us isolate the problem and provide you with a solution as quickly as possible.
- When placing a call to Technical Support, be at the computer or work station that is experiencing the problem and have Home Designer Interiors running. If you do not have access to the problem computer at the time of the call, the technician may be unable to reproduce the issue and/or sug-

gest a remedy that can be implemented and verified immediately.

- Be prepared to reproduce the problem when you contact us. If the problem cannot be reproduced, there is a reduced chance that we will be able to resolve the problem on your first phone call.

Online Information

Home Designer Interiors has a variety of support resources available on our Web site. These include our **Technical Support Knowledge Base**, the **How do I...? Solution Finder**, downloadable program updates, and ways to contact our Technical Support department. To access these resources, visit:
www.HomeDesignerSoftware.com.

Our support team is happy to assist you in finding the best resource to answer your questions, and can resolve most issues in just a few minutes. In order to allow us to quickly answer your calls, we ask that you limit yourself to one question per support call.

Online Support

Questions can be answered online by the Technical Support department. To submit a technical inquiry online, visit the Technical Support section of our Web site and use the [Online Support Center](#).

This route ensures that your question is delivered to the first available support professional. Requesting assistance of an individual specialist is not recommended, since that person may not be available to answer your question in a timely manner.

Telephone Support

Our Technical Support team is committed to answering your questions as quickly as possible and in the order received. Your call is important to us; however, there are times when we get more calls than expected and you may have to wait a few minutes before speaking to a technician.

Program Paths Dialog

Some technical issues can be caused by problems with support files used by Home Designer Interiors. In the event of such an issue, Chief Architect Technical Support may direct you to the **Program Paths** dialog. This dialog displays a list of files utilized by the software along with the pathname of each.

To avoid unintended problems that could prevent you from using the software, it is strongly recommended that you make no changes to any of the files in this list except with the direct assistance of Technical Support.

Index

Numerics

360 Panorama Export	425
3D	
Data Import.....	420
Delete Surface.....	380
Mice.....	21
Symbols, Importing.....	421
3D Roof Designer	325
3D Views	
Display.....	379
Doll House.....	378
Editing.....	388
Generation, Speed up.....	402
Overviews.....	377
Save.....	389
Working in.....	388
3D Wall Designer	139

A

Adding	
to the Library.....	338
Adjust	
Material Definition.....	369
Align	
Curved Stairs Between Floors.....	113
Curved Walls Between Floors.....	150
Objects.....	112
Text.....	203
Walls.....	149
Alphabets	
International.....	196
Unicode.....	196
Angle Snaps	79
Appearance Preferences	58

Appliances	
Built into cabinets.....	250
Arc	
Panel.....	126
Specification Dialog.....	125
Architectural Blocks	
Displaying.....	352
Edit Sub-Objects.....	352
Explode.....	352
Sub-objects.....	353
Archive Files	42
Area	
Living Area calculation.....	166
of a Polyline.....	128
of Rooms.....	170
Arrow	
Auto Positioning.....	205
Panel.....	125
Text Line With.....	204
Artwork	
Creating textures.....	370–371
Attenuation	275
Attic	
Floor.....	293
Rooms.....	166
Walls.....	151
Auto	
Archive.....	42
Interior Dimensions.....	187
Place Outlets.....	268
Save Files.....	43
Stairwell.....	309
Auto Rebuild	
Attic Walls.....	134
Foundation.....	280
Roofs.....	323
Automatic	

Exterior Dimensions 187

B

Backdrops 415
 Definition 415

Background Color 59

Backup
 Entire Plan 47
 Files 41

Balusters 158
 Definition 297

Base
 Cabinets 249

Bay Windows 227

Bay/Box Window
 Specification Dialog 244

Blend Colors with Materials 364

Blind Cabinets 257

Bonus
 Library Catalogs 334
 Rooms 293

Bow
 Window Specification 244

Bow Windows 227

Box
 Windows 227

Break
 Line 114
 Line, complete 115
 Line, partial 114
 Wall 139

Build
 Foundation 278, 290
 House 50
 New Floor 289
 Roof Dialog 323

Bumping/Pushing 110

C

Cabinet

Defaults 248
 Designer 247
 Modules Library 249
 Specification Dialog 257
 Tools 248

Cabinets

Angled front 255
 Backsplash 259
 Base 249
 Blind 257
 Built-in appliances 250
 Corner 255
 Delete face items 261
 Door/drawer style 249
 Doors, diagonal 259
 Doors, glass 262
 Editing 253
 End cabinets 255
 Fillers 250
 Front Indicators 253
 Front Panel 259
 Full Height 249
 General Defaults 248
 Glass doors 262
 Island 257
 Lazy Susan 259
 Minimum Width 248
 Module Lines 252
 Moving, with Wall 254
 Normal 255
 Peninsula radius 255
 Radius end 255
 Resize Increment 248
 Reverse Appliance 261
 Shaped 255
 Special shapes 255, 258
 Wall 249

CAD

Angle Snaps 79
 Circles 122
 Drawing Tools 121
 Ellipses 122
 Ovals 122
 Polyline 122

Polylines.....	127	Ovals.....	122
Rectangle.....	122	Click Stairs	296
CAD Box		Close	
Specification Dialog.....	130	Plans and Views.....	48
CAD Objects		Program.....	48
Displaying.....	131	Views.....	76
Calculate		Color	
From Room.....	428	Off/On.....	109
Materials on soffits.....	357	Color Chooser	
Camera		Eyedropper.....	373
Activating.....	390	Colors	
Change Settings.....	390	Selecting.....	372
Create Views.....	377	Compatibility	
Field of View.....	387	with other programs.....	36
Move Tools.....	384	Connect	
Move Up/Down One Floor.....	386	Electrical.....	268
Orbit Tools.....	384	Walls.....	141
Specification Dialog.....	390	Contextual Menus	58
Tilt Tools.....	385	In Render views.....	386
Casing		Copy	
Door.....	221	Folders and Library Objects.....	340
Cathedral Ceilings	174	Region as Picture.....	415
Ceiling		Copy/Paste	
Break Lines.....	175	Main Edit Mode.....	83
Heights.....	172	Sticky Mode.....	83
Shelf.....	173	Corner	
Ceilings		Windows.....	228
Cathedral.....	174	Create	
Lowered.....	174	New Plan Dialog.....	38
Over this room.....	179	Cross Hairs	62
Special.....	174	Mouse.....	112
Tray.....	175	Turn On/Off.....	62
Center		Cross Section Slider	387
Doors.....	214	Crown Molding	
Object edit tool.....	112	Cabinets.....	255
Sheet.....	437	Current	
Text.....	203	Floor.....	292
Change		Floor, Delete.....	291
Door Swings.....	214	Curved	
Floor/Reference.....	293–294	Stairs.....	296
Line to arc.....	302	Walls, Draw.....	141
Chimneys	286	Custom Light Intensity Dialog	275
Circle			
Specification Dialog.....	127		
Circles	122		

D

<p>Deck 171</p> <p style="padding-left: 20px;">Framing 172</p> <p style="padding-left: 20px;">Roof Over 171</p> <p>Decks 171</p> <p>Default</p> <p style="padding-left: 20px;">Lights 396</p> <p>Default Sun Light</p> <p style="padding-left: 20px;">Specification Dialog 397</p> <p>Defaults</p> <p style="padding-left: 20px;">Cabinet 248</p> <p style="padding-left: 20px;">Defined 54</p> <p style="padding-left: 20px;">Dimension 183</p> <p style="padding-left: 20px;">Door 209</p> <p style="padding-left: 20px;">Dynamic 55</p> <p style="padding-left: 20px;">Floor 165, 288</p> <p style="padding-left: 20px;">Foundation 278</p> <p style="padding-left: 20px;">General Plan 56</p> <p style="padding-left: 20px;">Material 362</p> <p style="padding-left: 20px;">Reset 55</p> <p style="padding-left: 20px;">Roofs 322</p> <p style="padding-left: 20px;">Room 165</p> <p style="padding-left: 20px;">Settings 54</p> <p style="padding-left: 20px;">Wall 134</p> <p style="padding-left: 20px;">Window 226</p> <p>Define Material Dialog 370</p> <p>Delete</p> <p style="padding-left: 20px;">3D Surface 380</p> <p style="padding-left: 20px;">Current Floor 291</p> <p style="padding-left: 20px;">Floors 291</p> <p style="padding-left: 20px;">Foundation 281</p> <p style="padding-left: 20px;">Library Content 341</p> <p style="padding-left: 20px;">Objects 117</p> <p style="padding-left: 20px;">Roof Planes 323, 325</p> <p style="padding-left: 20px;">Wall Hatching 138</p> <p>Dimension</p> <p style="padding-left: 20px;">Defaults 183</p> <p style="padding-left: 20px;">Tab 194</p> <p style="padding-left: 20px;">Tools 186</p> <p>Dimension Defaults 183</p> <p style="padding-left: 20px;">Dialog 183</p> <p>Dimension Line</p> <p style="padding-left: 20px;">Specification Dialog 193</p> <p>Dimensions</p>	<p style="padding-left: 20px;">Auto Interior 187</p> <p style="padding-left: 20px;">Editing 189</p> <p style="padding-left: 20px;">End to end 187</p> <p style="padding-left: 20px;">Exterior 187</p> <p style="padding-left: 20px;">Interior 187</p> <p style="padding-left: 20px;">Locating railings 154</p> <p style="padding-left: 20px;">Move Objects Using 192</p> <p style="padding-left: 20px;">Moving Labels 190</p> <p style="padding-left: 20px;">Number Height 194</p> <p style="padding-left: 20px;">Tape Measure 188</p> <p style="padding-left: 20px;">Temporary 188</p> <p style="padding-left: 20px;">Zeroes in 185</p> <p>Display</p> <p style="padding-left: 20px;">3D Views 379</p> <p style="padding-left: 20px;">CAD Objects 131</p> <p style="padding-left: 20px;">Drawing Groups 86</p> <p style="padding-left: 20px;">Drawing Sheet 437</p> <p style="padding-left: 20px;">Electrical 270</p> <p style="padding-left: 20px;">Foundations 279</p> <p style="padding-left: 20px;">Images 407</p> <p style="padding-left: 20px;">Objects 87</p> <p style="padding-left: 20px;">Room labels 170</p> <p style="padding-left: 20px;">Walls, Railings, and Fences 142</p> <p>Display Options Dialog 88</p> <p>Doll House View 378</p> <p>Door</p> <p style="padding-left: 20px;">Defaults 209</p> <p style="padding-left: 20px;">Specification Dialog 218</p> <p style="padding-left: 20px;">Tools 210</p> <p>Doors</p> <p style="padding-left: 20px;">Arched 221</p> <p style="padding-left: 20px;">Bifold Doors 211, 216</p> <p style="padding-left: 20px;">Casing 221</p> <p style="padding-left: 20px;">Center 214</p> <p style="padding-left: 20px;">Change Opening/Hinge Side 215</p> <p style="padding-left: 20px;">Change Swing Side 215</p> <p style="padding-left: 20px;">Doorways 210</p> <p style="padding-left: 20px;">Frame 221</p> <p style="padding-left: 20px;">Garage 211</p> <p style="padding-left: 20px;">Garage, opening direction 216</p> <p style="padding-left: 20px;">Handles 222</p> <p style="padding-left: 20px;">Hardware 222</p> <p style="padding-left: 20px;">Hinged Doors 210, 214</p> <p style="padding-left: 20px;">Hinges 222</p> <p style="padding-left: 20px;">Ignore Casing when Resizing 57</p> <p style="padding-left: 20px;">Labels 213</p> <p style="padding-left: 20px;">Library 211, 219</p>
---	---

Lites	221
Locks	222
Openings in railings	217
Pocket Doors	211, 216
Rough opening	219
Size.....	219
Sliding Doors	215
Style.....	219
Swing, change	214
Threshold lines	212
Transoms	217
Type.....	219
Wrapped Openings	217
Doorways	
Adding a Door.....	212
with Railing.....	217
Draw	
Curved Railing.....	141
Curved wall.....	141
Drawing Group	
Edit Tools	86
Move to Back.....	86
Move to Front	86
Drawing Groups	86
Drawing Sheet	
Center	437
Select.....	437
Show.....	437
Dynamic	
Defaults.....	30, 55
Print Preview	437

E

Edit	
Handles	22
Preferences	62
Toolbar.....	24
Edit Area	94
Electrical	
Auto Place Outlets	268
Connections	268
Deleting.....	271
Displaying.....	270

Editing Objects.....	270
General	265
Labels	270
Library	269
Lights	266
Outlets.....	266
Switches.....	267
Tools	266
Wiring.....	268
Electrical Service	
Specification Dialog.....	271
Ellipse	122
Specification Dialog.....	127
End	
Cabinets	256
To-End Dimensions	187
Enhanced Metafiles	413
Error Messages	452
Estimating Software	431
Exit Program	48
Expand/Collapse All	333
Explode	
Architectural Blocks.....	352
Export	
360 Panorama.....	425
EMF	413
From the Library.....	342
Materials List	431
Picture Files.....	411
Windows Metafiles	413
Windows Metafiles Dialog	413
WMF.....	413
Extend	
Slope Downward	150
Extension Lines	
Adding	191
Deleting	192
Editing	191
Extension Snaps	78
Exterior	
Dimensions	187
Room types.....	166
The Exterior Room	167
Walls	136

F

- F6 Key**
- Fill Window 73
- Faster Rendering** 402
- Field of View** 387
- File**
- Backing Up Your Files 41
- Create New 38
- Management 35
- Open 44
- Organization 36
- Fill**
- Patterns 129
- Window 73
- Window Building Only 73
- Fill Style Panel** 129
- Filter**
- Library Search 334
- Fire Box Panel** 285
- Fireplace**
- Direction facing 283
- Interior wall 283
- Library 285
- Masonry 283
- Specification Dialog 284
- Symbol 285
- Fireplaces** 282
- Chimneys 286
- Foundations 284
- Freestanding 283
- In walls 283
- Types 282
- Fix**
- Wall Connections 142
- Fixtures**
- Lights 266
- Floor**
- 3D Overview 377
- Build New Floor 289
- Camera 377
- Defaults 165, 288
- Heights 172
- Overview 377

- Tools 288
- Floor Plan**
- Drawing 30
- View 32
- Floors**
- Adding 289
- Attic 293
- Change Floor/Reference 293–294
- Current Floor 292
- Deleting 291
- Exchange With Floor Above 290
- Exchange With Floor Below 290
- Floor Up/ Floor Down 292
- Maximum number 289
- Reference Floor 293
- Swap Floor/Reference 294
- Folders Preferences** 61
- Fonts** 196
- and Alphabets 196
- Blueprint 196
- Footings** 278
- Foundation**
- Auto Rebuild 280
- Defaults 278
- Walls 137
- Foundations**
- Build 278
- Delete 281
- Display 279
- Garage 282
- Mixed Types 279
- Room supplies floor 179
- Stem Wall 278
- Stepped 282
- Framing**
- Deck 172
- Full**
- Height Cabinets 249

G

- Garage**
- Door Tool 211
- Garages**

Foundation	282
General	
Cabinet Defaults	248
Preferences	60
Getting Help	32
GFCI Outlet	266
Glass, Stained	229
Grid	
Snaps.....	57, 79
Ground Fault Circuit Interrupt	266

H

Half	
Walls.....	158
Half-Walls	135
Hardware	
for Doors	222
Hatch	
Fill Patterns	129
Wall.....	138
Height	
Railings	159
Help	
Tool Tips	32
Home Designer	
Product Key.....	33
Version Number	33
Hotkeys	24, 69
Create List.....	69
House Wizard	
Editing Rooms	50
Multiple Floors	51
Placing Rooms.....	50

I

Image	
Specification Dialog	408
Images	395
Adding to Library.....	407

Creating.....	407
Displaying.....	407
Editing	408
Place	406
Printing	442
Transparency Color	411

Import

3D Data	420
3D Symbols	421

Interior

Dimension Tool	187
Dimensions, Auto	187
Fireplace, wall.....	283
Room types.....	166

Invisible Walls	137
------------------------------	-----

K

Keyboard

Commands	24, 69, 333
----------------	-------------

Kitchen Island	257
-----------------------------	-----

Knee Walls	152, 155
-------------------------	----------

L

Labels

Door	213
Electrical.....	270
Room.....	170
Window.....	231

Landing	303
----------------------	-----

Unlocked	304
----------------	-----

Landings

Custom Shapes.....	303
Height.....	304
Locked.....	304

Layer

Layer Sets	88
------------------	----

Layers

Primary and Secondary	87
Turn off to speed up 3D views.....	402

Left Mouse Button

Definition	21
Library	
Adding Folders	339
Bonus Catalogs	334
Content	334
Deleting Content	341
Export	342
Manufacturer Libraries	335
Renaming Libraries	340
Search	333
Shortcuts	341
Trash	341
Library Browser	330
Adding Items	338
Docking	333
Panels	330
Preferences	60
Library Object	
Specification Dialog	347
Library Objects	
Editing	346
Placing	342
Light	
Ambient	396
Light Sources	395
Default Lights	396
Default Sun Light	396
Fixtures	396
Lights	
Attenuation	275
Casts Shadows	274
Color	274
Custom Intensity	275
Cut Off Angle	274
Direction	274
Drop Off Rate	274
Fixtures	266, 396
Intensity	274
Light Data Tab	273
Show Position in 3D	274
Turn On/Off	397
Types of sources	397
Line	
Color	124
Panel	123
Specification Dialog	123

Line Style	124
Panel	124
Lites	
Craftsman	236
Diamond	236
Doors	221
Normal	236
Prairie	236
Living Area	171
and Room Types	166
Calculation	171
Delete label	171
Label	171
Restore label	171
Show	57
vs. Footprint	171

M

Main	
Edit Mode	83
Manual	
Dimensions	187
Manufacturer Libraries	335
Marquee Select	93
Masonry	
Fireplace	283
Material	
Defaults	362
Eyedropper	365
Material Painter	363
and Walls	365
Blending	364
Modes	363
Using	364
Materials	
Add to Library	338
Artwork	370–371
Blending	370
Brightness	372
Calculating amounts	357
Color	371
Creating	369
Define Material Dialog	370

Editing.....	369
On Soffits	357
Panel.....	366
Stained glass.....	229
Textures.....	395
Walls.....	143
Materials List	427
Calculate from Room.....	428
Conditioned Areas.....	431
Display Options Dialog	429
Editing.....	430
Estimating software.....	431
Export	431
Menus	25
Message Boxes	
Reset	29
message URL http	
//www.homedesignersoftware.com/ useraccess/content.html	336
Metafile Size Dialog	413
Metafiles	413
Middle Mouse Button	21, 72
Minimum	
Alcove	324
Molding	
in Rooms	180
Moldings Tab	
for Rooms.....	180
Monolithic Slab	278
Mouse	
3D.....	21
Pointer Icons	22
Mouse Buttons	
Using.....	21
Move	
Along Rails	147
Folders and Library Objects.....	340
Nudging.....	111
Object Using Dimensions	192
Objects.....	110
Restrictions	111
Walls with Cabinets Attached.....	254
Mulled Unit	
Specification Dialog	232

Mullions	
Window.....	235
Multiple	
Select	93
Muntins	
Window.....	235

N

Newels	
Definition	297
Newels/Balusters Tab	159
Niche	228
No Locate Wall	154
Nudging	111

O

Object	
Based Design.....	19
Object Snaps	78
Extension Snaps	78
One-Click Auto Dimension	187
One-Click Stairs	296
Open	
Below	166
Object.....	28
Plan Files.....	44
View	390
OpenGL	376
Organizing	
your Files.....	36
Outlets	266
Above cabinet	266
Automatic	268
Dishwasher	266
GFCI	266
Manually placed	266
Place.....	268
Sink.....	266
WP	266

Oval 122
 Specification Dialog 127
Overview 17

P

Page Setup Dialog 435
Painting
 Over Materials 370
Pan
 Pan Window Tool 74
 the Display 73
 Using the Keyboard 74
 Using the Mouse 74
 Using the Scroll Bars 74
Panorama Export 425
Paragraph Options Dialog 200
Partition Tool 249
Pass-Through 227
Paste 82
 Hold Position 83
 in Place 83
 Special 83
PDF
 Print to 439
Peninsula Radius Cabinets 256
Picture
 Copy Region as 415
Picture File Box
 Specification Dialog 412
Picture Files
 Export 411
 Import 412
 Scale 414
Pitch
 Above Wall 150
Place
 Images 406
 Library Objects 342
 Outlets 268
Plan
 Create New 38

Drawing 30
 Files, Opening 44
 General Defaults 56
 Saving 39
 View 32
Plant Shelf 173
Pointer
 Cross Hairs 62
Polyline
 Area 128
 Definition 127
 Panel 128
 Specification Dialog 128
Preferences
 Appearance Panel 58
 Colors Panel 59
 Definition of 54
 Dialog 57
 Edit Panel 62
 Folders Panel 61
 General Panel 60
 Global settings 57
 Library Browser Panel 60
 Render Panel 62
 Reset preferences 64
Print 433
 3D Views 438
 Across Multiple Pages 438
 Center Sheet 437
 Clear Printer Info 434–435, 452
 Dialog 439
 Drawing Scale 434
 Drivers 434
 Options 435
 Paper Size 434
 Perspective Views 438
 Preview 437
 Printable Area 437
 Scale to Fit 438
 Terminology 434
 Tiled 438
 to PDF File 439
 To Scale 438
 Troubleshooting 450
Print Image 390
 Dialog 442

Printers	
Select Printer.....	440

R

Radius	
End Cabinets.....	256
Rail Style Tab	157
Railings	135
Balusters	158
for Stairs	315
Glass.....	136
Half Walls.....	135
in a Doorway.....	217
Locate with dimensions	154
Middle Rail	158
Newels	159
No Rail	158
Open	158
Openings	217
Solid.....	158
Stairs	308
Type.....	158
Rebuild	323
3D.....	389
Roofs	323
Rectangular Polyline	122
Redo	118
Reference	
Display Options.....	293
Grid.....	57
Remove	
Backdrop	376
Render	
Graphics card	376
Light Sources.....	395
Preferences	62
Status.....	64
Tips.....	394
Rendering Techniques	398
Defaults.....	400
Options.....	400
Replace from Library	
Button	345

Dialog.....	345
Reset	
Defaults	55
Message Boxes.....	29
Preferences	64
Reshape objects	114
Resize	
House using Dimensions	193
Objects	113
Restrictions	
Moving objects	111
Rich Text	
Defaults	196
Specification Dialog.....	198
Text Color.....	199
Right Button Definition	21
Roof	321
Extend Slope Downward.....	155
Full Gable Wall.....	155
Over this room	179
Panel.....	154
Pitches in Degrees	328
Second pitch	155
Styles, Automatic	323
Tools	322
Roof Designer	322
Roof Hole/Skylight	
Specification Dialog.....	326
Roof Planes	
Delete.....	325
Roofs	321, 323
Auto Rebuild	323–324
Build Roof Dialog	323
Defaults	322
Hole for skylights.....	326
Knee walls	152
Min. Alcove	324
Overhang.....	325
Pitch	150
Skylights	326
Story-and-a-half	152
Room	
Defaults	165
Specification Dialog.....	176
Room Labels	170

Display	170
Edit.....	170
Interior room area.....	170
Interior room dimensions	170
Room area.....	170
Standard room area.....	170
Room Planner	45
Importing Files	45
Room Types	166
Rooms	
Area	170
Attic.....	166
Below Stairs.....	310
Ceiling over.....	179
Editing.....	168
Exterior types.....	166
Foundation floor definition	179
Interior.....	166
Interior area	170
Interior dimensions.....	170
Living Area.....	166
Open Below	166
Roof over.....	179
Room Definition	163
Room Types.....	166
Selecting	167
Standard area	170
The Exterior Room	167
Types	165
Rotate objects	115

S

Sample Plans	
Download.....	446
Save	
3D Views	389
and Save As	39
Plan.....	39
Thumbnail Image.....	42
Scale	
Picture Files.....	414
Printing to.....	438
Text Size	203
to Fit.....	438

Scroll Bars	74
Seat	
in Bay Window.....	242
Select	
Backdrop.....	376
Components of Blocked Units.....	230
Ctrl+Click	93
Library Object Dialog	344
Marquee	93
Material Dialog	367
Multiple Objects.....	93
Next Object	93
Objects button	92
Objects in 3D Views.....	388
Room.....	167
Selected Edge.....	92
Shift+Click.....	93
Similar Objects	92
Select Color Dialog	372
Selection Fill Color	59
Service Data Tab	271
Shelf	249
Shelf Ceiling	173
Shelf Tool	249
Shelf/Partition	
Specification Dialog	263
Shift Key	
Marquee selection	93
Select multiple objects	93
Shininess	372
Shortcut Keys	24, 69
Show	
Living Area.....	57
Reference Grid	57
Sheet.....	437
Shutters	239
Side Windows	23
Skylights	323, 326
Sliding Doors	211
Snap Behaviors	78
Angle Snaps.....	79
Extension Snaps.....	78
Grid Snaps.....	57, 79

Object Snaps	78	Level Floor Plans	291
Soffit		Walls	139
Defaults	355	Stacked Windows	229
Specification Dialog	358	Stair	
Soffits	249, 355	Landing Specification Dialog	317
Calculating Materials	357	Tools	296
Corner	356	Stair Designer	296
Special applications	356	Stair Landing	
Space Planning	49	Specification Dialog	317
Special		Stair Landings	
Shaped Cabinets	255	Custom Shapes	303
Specification Dialogs		Height	304
Arc	125	Locked	304
Bay/Box Window	244	Stair Railing	
Bow Window	244	Solid	308
Cabinet	257	Stair Treads	
CAD Box	130	Automatic	312
CAD Circle	127	Depth	312
CAD Ellipse	127	Lock Number	312
CAD Oval	127	Lock Tread Depth	312
Camera	390	Number	313
Default Sun Light	397	Overhang	314
Dimension Line	193	Thickness	314
Door	218	Staircase	
Electrical Service	271	Specification Dialog	311
Fireplace	284	Stairs	
Image	408	Align Curved Stairs	113
Library Object	347	Auto Stairwell	309
Line	123	Balusters	316
Polyline	128	Change Line/Arc	302
Rich Text	198	Click	296
Roof Hole/Skylight	326	Curved	296, 298
Room	176	Direction	298
Shelf/Partition	263	Edit Handles	301
Soffit	358	Editing	300
Stair Landing	317	Landings	303
Staircase	311	Landings, unlocked	304
Text	201	Large Stringer Base	314
Wall	153	Make Reach	311
Wall Hatch	160	Merge Sections	301
Window	232	Newels	316
Speed		Railings	308
3D View Generation	402	Reach Next Floor	311
Splines	130	Rooms Below	310
Split		Section Width	312
Level Entries	292	Stairwell	308

Starter Treads.....	306
Straight.....	296
Stringers.....	313
Subsections.....	311
Terminology.....	297
Tread Depth.....	305
Treads.....	311
Wrapped.....	307
Stairwell	
Automatic.....	309
Startup Options	18
Status Bar	29
Stem Walls	278
Stepped Foundations	282
Sticky Mode	83
Story-and-a-half	152
Straight	
Stairs.....	296
Swap	
Views.....	74
Work-Reference.....	294
Switch	
Three way.....	269
Symbol	
Surface Normals.....	421
vs. Native Objects.....	346
T	
Tab Key	93
Tape Measure	188
Technical Support	449
Contact.....	453
Error Messages.....	452
Installation Issues.....	450
Online.....	454
Online Articles.....	454
Telephone.....	454
Temporary	
Dimensions.....	188
Temporary Dimensions	188

Text	
Aligning.....	203
Arrows.....	204
Bullets.....	200
Copy, Cut and Paste.....	203
Creating.....	197
Displaying.....	198
Editing.....	201
Layer.....	198
Line Spacing.....	200
Lists.....	200
Move.....	202
Numbering.....	200
Paragraph Options.....	200
Printed Size.....	203
Reshape.....	202
Resize.....	202
Rotate.....	202
Scaling.....	203
Specification Dialog.....	201
Text Style Defaults Dialog	205
Text Styles	205
Texture	
Filename Conflict Dialog.....	424
Textures	395
Thumbnails	42
Creating.....	42
Tiling Views	75
Toolbars	24
Drop-Down.....	67
Edit.....	24
Hide.....	67
Parent-Child.....	67
Transom Windows	217
Transparency	372
Color.....	411
U	
Undo	118
Files.....	43
Undo Zoom.....	73
Unrestricted Movement	111

V

Vents	229
Video Card	
Memory	376
OpenGL.....	376
Status.....	64
Videos	
View Online Help Videos	446
Views	
Tiling.....	75
Virtual Graph Paper	56–57
Visual CAD Snaps	56
Volume	
Of a Polyline	128, 318

W

Walkthroughs	417
Codecs.....	418
Playing.....	418
Recording.....	417
Wall	
Assemblies.....	152
Cabinets.....	249
Defaults.....	134
Niche.....	228
Specification Dialog	153
Tools.....	134
Wall Hatch	
Specification Dialog	160
Walls	
Align between floors.....	149
Align collinear.....	149
and Material Painter.....	365
Attic Walls	151
Connecting	141
Curved	141
Curved, align between floors	150
Delete hatching.....	138
Display surfaces only	142
Drawing.....	139
Editing.....	146
Exterior and Interior	136

Fix Connections	142
Flip layers.....	140
Foundation.....	137
Full Gable Wall.....	155
Grid snapping	141
Half	158
Half Walls	135
Hatching	138
Heights	148
Interior, fireplace in	283
Invisible	137
Knee Wall	155
Length	148
Materials.....	143
Move Along Rails	147
No Locate	154
No Room Def	154
Opening with Railing.....	217
Openings in	141
Removing Breaks.....	142
Resizing Using Dimensions.....	193
Reverse Layers.....	140
Solid Railings.....	158
Thickness	147
Wall Coverings.....	156
Waterproof Outlets	266
Winders	
Definition	297
Window	
Defaults	226
Seat	242
Specification Dialog.....	232
Windows	
Bay and Bow dimensions.....	241
Bay, Box, Bow.....	241
Bench Seat	242
Component	242
Corner	228
Labels	231
Library	228
Match roof	237
Mulled Units.....	229
Mullions.....	235
Muntins.....	235
Pass-Through	227
Shape.....	237
Shutters.....	239

Special Shapes	229
Stacked	229
Stained glass material	229
Transom	217
Trapezoid	237
Treatments	239
Types	226
Vents	229
Windows Metafiles	413
Wrapped	
Openings	217
Stairs	307

Z

Zero

in Dimensions.....	185
--------------------	-----

Zoom.....

Fill Window	73
Mouse Wheel	21, 72
Tools	72
Undo Zoom	73