

**Chief Architect®
Home Designer Interiors® 2015**

User's Guide

**Chief Architect, Inc.
6500 N. Mineral Dr.
Coeur d'Alene, Idaho 83815
www.HomeDesignerSoftware.com**

© 1990–2014 by Chief Architect, Inc. All rights reserved.

No part of this book or the accompanying software may be reproduced or transmitted in any form or by any means, electronic or mechanical, including photocopying, recording, or by any information storage and retrieval system, without permission in writing from Chief Architect, Inc.

Chief Architect® and Home Designer® are registered trademarks of Chief Architect, Inc.

This software uses the FreeImage open source image library. See <http://freeimage.sourceforge.net> for details. FreeImage is used under the FIPL license, version 1.0.

This software uses the Ruby open source library. See <http://www.ruby-lang.org/> for details.

This application incorporates Teigha® software pursuant to a license agreement with Open Design Alliance. Teigha® Copyright © 2003-2013 by Open Design Alliance. All rights reserved.

All other trademarks and copyrights are the property of Chief Architect, Inc. or their respective owners.

Created in the United States of America.

Contents

Chapter 1: Installation

System Requirements	7
Downloading Home Designer Interiors.....	8
Installing Home Designer Interiors	8
Starting Home Designer Interiors.....	14
Migrating Library Catalogs	14
Program Updates	16
Installing on Multiple Computers	17
Uninstalling Home Designer Interiors.....	17

Chapter 2: House Design Tutorial

Before You Begin.....	20
Getting Started	20
Setting Defaults.....	22
Drawing Walls	24
Creating Dimension Lines.....	27
Adjusting Wall Positions.....	29
Creating Rooms	32
Creating a 3D View.....	38
Adding Floors.....	41
Adding Stairs.....	46
Placing Doors and Windows.....	50

Chapter 3: Roof Tutorial

Getting Started with Automatic Roof Styles	58
Hip Roofs.....	60
Gable Roofs	61
Shed Roofs.....	62
Offset Gable Roofs	63
Gambrel Roofs	64
Gull Wing Roofs.....	65
Half Hip Roofs	66
Mansard Roofs.....	67
Roof Style Quick Reference.....	69
Creating Dormers	70
Skylights.....	76
Using the Break Wall Tool to Modify Roofs	77
Adding a Roof to the Stucco Beach House.....	80
Troubleshooting Roof Issues.....	83

Chapter 4: Interior Design Tutorial

Controlling the Display of Objects.....	89
Working with Library Objects.....	90
Applying Room Moldings	94
Applying Wall Coverings	96

Chapter 5: Kitchen and Bath Design Tutorial

Adding Cabinets	99
Placing Appliances.....	104
Editing Cabinets and Appliances.....	106
Creating a Cabinet Island.....	107
Working in 3D Views	111

Chapter 6: Materials Tutorial

Setting Materials Defaults	115
Using the Materials Panel	117
Using the Material Painter	119
Blending Colors with Materials	122
Using the Material Eyedropper	123
Custom Materials, Images, and Backdrops.....	124
Generating a Materials List.....	128

Appendix A: End User License Agreement

Installation

This chapter will walk you through installing your Home Designer software.

Chapter Contents

- System Requirements
- Downloading Home Designer Interiors
- Installing Home Designer Interiors
- Starting Home Designer Interiors
- Migrating Library Catalogs
- Program Updates
- Installing on Multiple Computers
- Uninstalling Home Designer Interiors

System Requirements

In order to install and run Home Designer Interiors, your computer system must meet the following minimum requirements:

- Windows[®] 8/7/Vista; Mac OS X[®] v10.8 (Mountain Lion) or newer
- 2.4 GHz processor
- 2 GB of memory (32 bit); 4 GB of memory (64 bit)
- 5 GB of available hard disk space
- 512 MB dedicated video card or integrated graphics with 2012 or newer drivers
- Recommended minimum monitor resolution: 1152 x 860

- High speed Internet for registration, video access, content downloads
- DVD drive (if software purchased on DVD)

For more information about system recommendations, visit our Web site at www.HomeDesignerSoftware.com.

Downloading Home Designer Interiors

To download and install Home Designer Interiors 2015, begin by logging in to your online Home Designer Interiors account at www.HomeDesignerSoftware.com.

Browse to the Digital Locker page, click the Download  button, and save the file to your local hard drive. Select an easy to find **Save in** location on your computer, such as your Documents folder or Windows Desktop, then click **Save**.

Installing Home Designer Interiors

When the installer file is completely downloaded, the Home Designer Interiors Setup Wizard will launch automatically.

If you have a Home Designer Interiors Program DVD, insert it into your DVD drive:

- In Windows, the Setup Wizard will launch automatically. If it does not, press the Windows key on your keyboard, then select Computer. Right-click on your DVD drive and select **Open** from the menu, then double-click on the file with your program's name and the **.msi** file extension.
- On a Mac, the DVD will open in a Finder window automatically. If it does not, right-click on the disk icon on your desktop and select **Open** from the menu. Then, double-click on the file with the **.pkg** file extension.

Setup Wizard Welcome

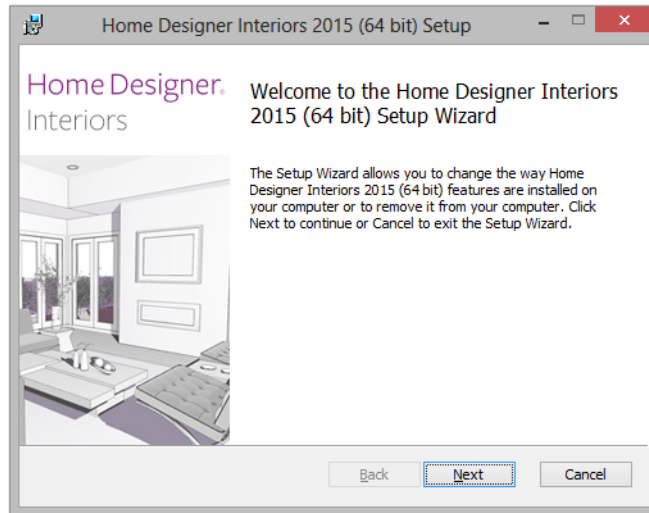

1. Depending on whether or not you have installed the program on this computer before, the text in this window may vary. Click **Next** to continue.

Setup Maintenance

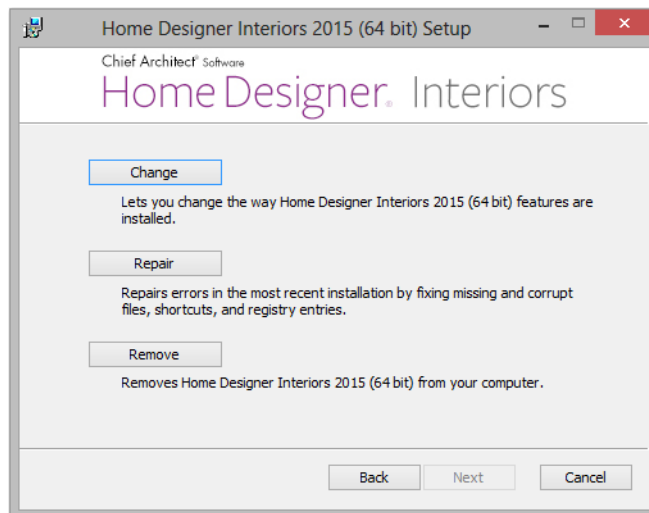

2. If you have installed the program before, this window will display, allowing you to reinstall or uninstall the program. If you are installing the program for the first time, this window will not display.

License Agreement



3. Read the License Agreement carefully. You must check the box beside **I accept the terms and conditions of this license agreement** before installing. See “End User License Agreement” on page 131 of the User’s Guide.
 - Click the **Advanced** button if you’d like to specify a non-default installation location or exclude supplementary content from being installed.
 - Click **Install** to begin installing the software. The Setup Wizard will begin copying files to your hard disk. This may take a few minutes.

Choose Destination Location

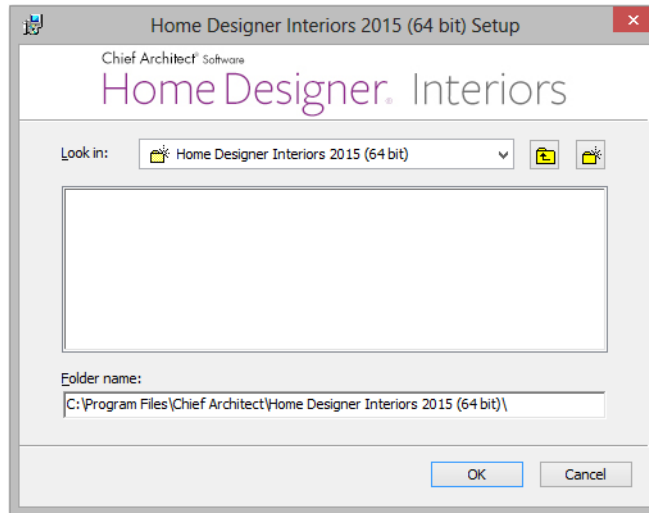

4. This window appears only if you click the **Advanced** button, and then the **Change** button, in the previous windows. Choose the destination folder for the program. By default, the program installs in the C:\Program Files\Chief Architect directory, in a folder with the same name as your program version.
 - If you prefer a different location, click drop-down arrow to the right of the **Look in:** location and navigate to the desired location on your hard drive.
 - You can also type the full pathname of the installation directory in the **Folder name:** field.
 - Click **OK** to proceed to the next window.

Note: Regardless of the location that you specify here, the program's library content will be installed in your computer's ProgramData folder.

Choose Items to Install

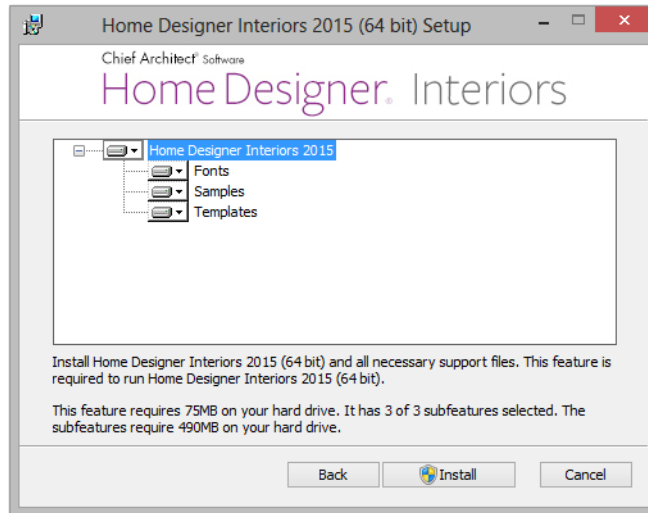

5. You can use this window to specify what features you wish to install.
 - Click on a line item to select it. Information about its contents and hard drive space requirements displays beneath the list of features.
 - Click the drop-down arrow beside a line item to specify how it is installed. By default, **Entire feature will be installed** is selected for all line items.
 - Choose **Entire feature will be unavailable** to prevent a selected subfeature from being installed. When this option is selected, a red X will display beside the line item's drop-down arrow. The top level feature cannot be excluded from installing. If you decide to not proceed with the program installation, click the Cancel button.
 - Click **Install** to install the program and supplemental content as specified.

Install

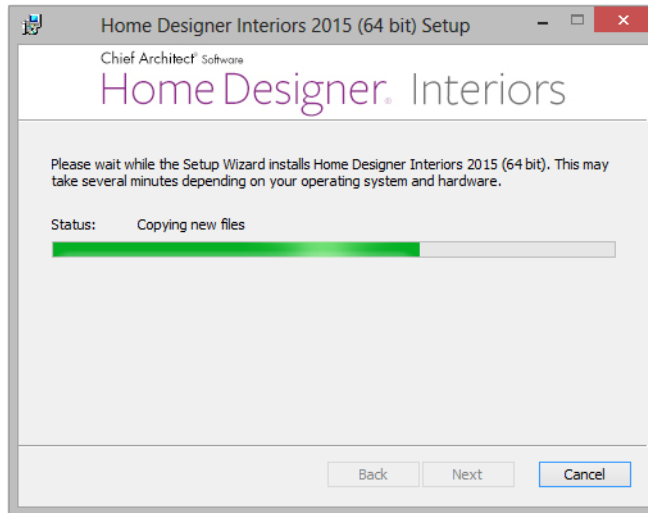

- The Setup Wizard will begin copying files to your hard disk after a few moments and a green progress bar in this window will show the status of this process. This may take a few minutes.

Setup Wizard Complete

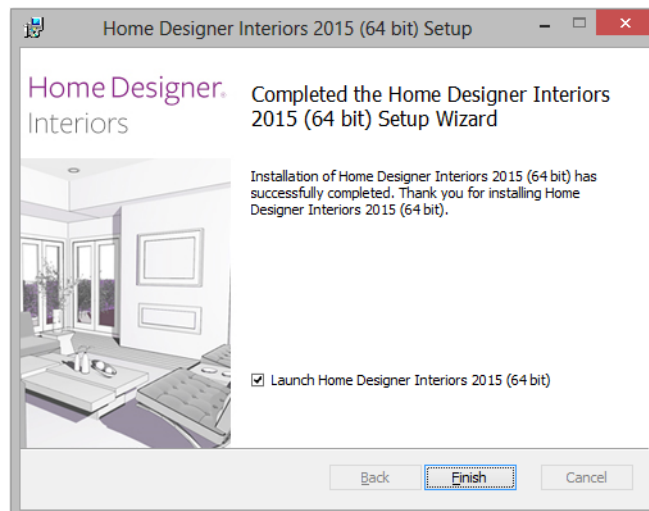

- When all files have been copied, this dialog will display. Click **Finish** to launch Home Designer Interiors.

Starting Home Designer Interiors

You can use the Start menu or the shortcut on your desktop to start Home Designer Interiors. When you launch the program for the first time, the **Product Activation** dialog will open.

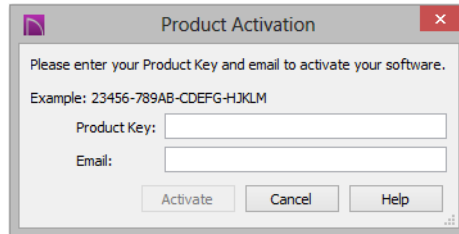

- Enter your **Product Key**, which is located in the account information from your download or on a sticker inside your DVD case.
- Enter your **Email** address.
- Click the **Activate** button to launch the program.

If you do not have a User Account on our web site, the **Create User Account** dialog will open next.

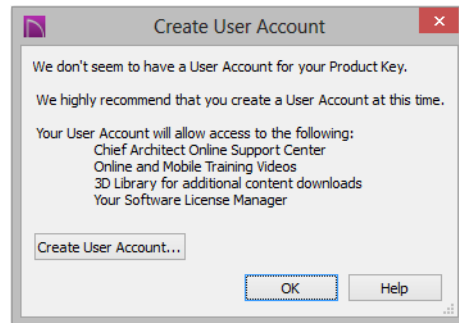

So that you can take full advantage of our online resources, we recommend that you click the **Create User Account** button and take a moment to create a User Account on our web site, www.HomeDesignerSoftware.com.

Migrating Library Catalogs

If you have Home Designer Interiors 2014 or a lesser version 2014 program installed on our computer, the **Migrate Library Catalogs** dialog will display after you activate the license, allowing

you to migrate library content for use in Home Designer Interiors 2015. See “Library Content” on page 286 of the Reference Manual.

Migrate Library Catalogs Dialog

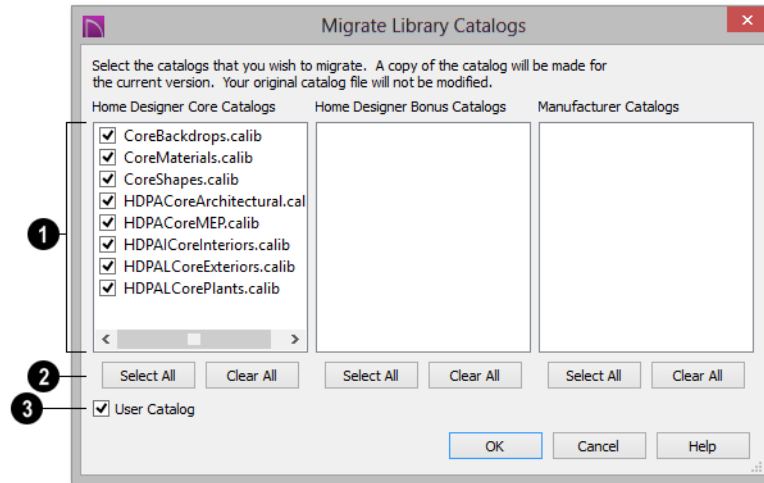

- 1 A list of all **Home Designer Core**, **Home Designer Bonus**, and **Manufacturer Catalogs** installed in your version 2014 library display here.
 - Uncheck the box beside a library catalog’s name to prevent it from migrating into the version 2015 Library Browser.
- 2 **Select All/Clear All** -
 - Click the **Select All** button below a list to migrate all catalogs in that list into the version 2015 library.
 - Click the **Clear All** button below a list to migrate none of the catalogs in that list into the version 2015 library.
- 3 Uncheck **User Catalog** if you do not want to migrate your custom library content into version 2015. When this is checked, your version 2014 custom library content will be migrated and placed in your User Catalog.

Legacy Library Conversion

If you upgraded to Version 2015 from a Home Designer Interiors version between 2012 and 8 and have custom library content from that version on your computer, the **Legacy Library Conversion** dialog will display.

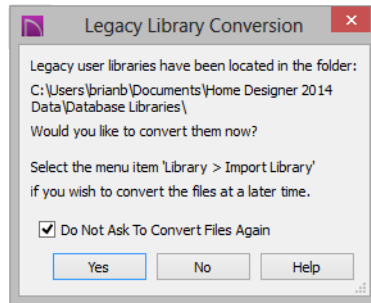

To convert this custom content for use in Version 2015, click **Yes**.

Program Updates

From time to time, Chief Architect releases Home Designer Interiors program updates that are available for download free of charge from the Home Designer Interiors web site, www.HomeDesignerSoftware.com.

When a program update is available, this dialog will display when the program is opened:

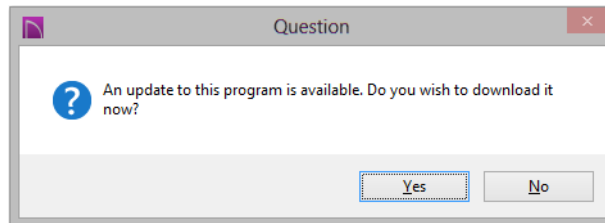

- Click **Yes** to open your default Internet browser to the **Program Updates** section of the Home Designer Web site.
- Click **No** to launch Home Designer Interiors.

At any time, you can select **Help > Download Program Updates** from the Home Designer Interiors menu to launch your default Web browser to the [Program Updates](http://www.HomeDesignerSoftware.com) section of the Home Designer Web site.

Program updates are not patches: when an update is installed, the previous version is uninstalled and then the new version is installed. Library content, Preference settings, and information saved in the program's Data folder are not affected by program updates.

Installing on Multiple Computers

A license of Home Designer Interiors can only be active on one computer at any given time. If you have been running the software on one computer and wish to run it on a different computer, or if you wish to rename your computer, you must deactivate your license first.

For details, please refer to the **End User License Agreement**, found in both the program installer and the User's Guide .pdf.



An active Internet connection is required to deactivate a Home Designer Interiors license.

To deactivate a Home Designer Interiors license

1. Launch Home Designer Interiors on the computer where the license is active.
2. Select **Help> Deactivate License** from the menu.
3. A message will confirm that you wish to deactivate the license. Click **Yes**.
4. After a pause, a second message will inform you that the license has been deactivated.

License activations can also be deactivated in your User Account on our web site, www.HomeDesignerSoftware.com

To manage license activations online

1. Log in to your User Account on our web site, www.HomeDesignerSoftware.com.
2. Browse to your **Digital Locker: Software Downloads and Product Keys** page.
3. Click the link to **Manage your Active Licenses**.
4. Click the **Deactivate** button to deactivate your license on the computer where it is currently active, making it available for use on another computer.

Uninstalling Home Designer Interiors

There are two ways that Home Designer Interiors can be removed from a Windows computer: from the Control Panel and using the Setup Wizard on the program disk. Please note that if you do not have an active Internet connection, your license will not become deactivated.

To remove the program using the Control Panel

1. Open the Windows Control Panel.
2. Double-click Programs.
3. Find Home Designer Interiors and click **Uninstall**.

To remove the program using the Setup Wizard

1. Launch your downloaded program installer or place the disc in the DVD drive and select **Install** Home Designer Interiors from the Home Designer Interiors startup window.
2. On the Setup Maintenance page, select **Uninstall** and click **Next**. A message will display, asking if you would like to remove the selected application and its components.
3. Click **Yes** to remove Home Designer Interiors.

When Home Designer Interiors is uninstalled, neither the Home Designer Interiors Data folder nor the library content is removed from the system. See “Home Designer Interiors Data” on page 37 and “Library Content” on page 286.



If an emergency forces you to reformat your hard drive, reinstall your operating system, or resort to a system restore point, be aware that none of these actions result in a normal program uninstallation or license deactivation.

House Design Tutorial

This House Design Tutorial shows you how to get started on a design project. The tutorials that follow continue with the same plan. When you are finished, you will have created a sample plan named “Stucco Beach House.” You can then apply the tools and techniques learned to your own plans.

In this tutorial you will learn about:

- Before You Begin
- Getting Started
- Setting Defaults
- Drawing Walls
- Creating Dimension Lines
- Adjusting Wall Positions
- Creating Rooms
- Creating a 3D View
- Adding Floors
- Adding Stairs

Before You Begin



Home Designer Interiors may look differently on your screen than it does in the following tutorials.

- Screen captures are taken from a smaller window to optimize image quality, so the size and proportion of your interface may be different.
- Some features, such as the Reference Grid, have been turned off to optimize image quality. For more information, see “General Plan Defaults Dialog” on page 55 of the Reference Manual.
- As the program is updated, features may be added or removed. If you are using the latest version of Home Designer Interiors, you may see buttons and/or menu items that have been added or removed since this tutorial was written. For more information, see “Program Updates” on page 16.
- Depending on your operating system and Windows system settings, dialogs and toolbars may appear differently than they do in the tutorials.

Getting Started



Begin by opening a new, blank plan.

To start Home Designer Interiors

1. Click the Windows Start button and select All Programs.
2. Browse to Chief Architect> Home Designer Interiors 2015> Home Designer Interiors 2015, and click to start the program.
3. When Home Designer Interiors launches, the **Getting Started** window displays. For more information, see “Startup Options” on page 18 of the Reference Manual.
 - Select **New Plan**  to open a new, blank plan.
 - If you have disabled the Startup Options at startup or already have the program open, you can select **File> New Plan**  to open a new, blank plan.

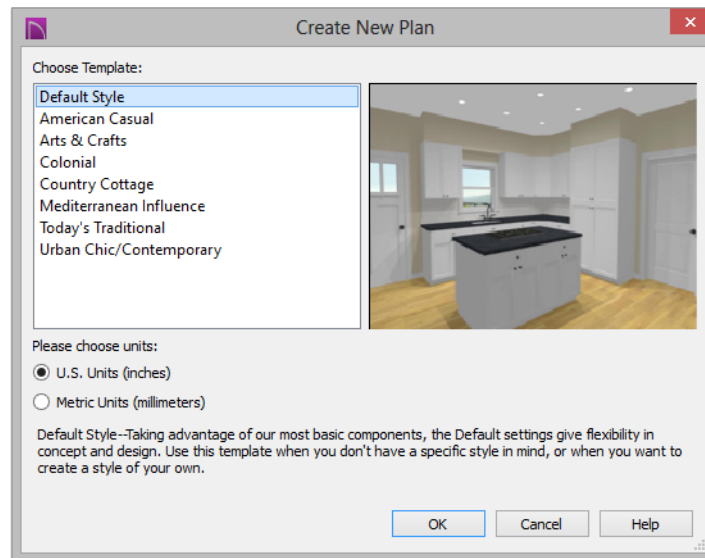
4. The **Create New Plan** dialog displays next.



5. Home Designer Interiors includes a selection of Home Style and Interior template plans, each with different default settings that allow you to begin working in a particular plan style quickly. For this tutorial, select **Home Style Templates** from the drop-down list. The **Default** template and **U.S. Units** are selected by default. Click **OK**. The floor plan view window opens, ready for you to begin drawing.
6. You should begin work on any new file by giving it a name. To do this:
- Select **File> Save**  from the menu to open the **Save Plan File** dialog.
 - Specify the location on your computer where you would like to save the plan.
 - Type a name for your plan.
 - Click **Save**.
7. It is a good idea to save your work on a regular basis as you proceed. To do this, you can:
- Select **File> Save**  from the menu to open the **Save Plan File** dialog
 - Click the **Save**  button on the toolbar.
 - Type Ctrl + S on your keyboard.

For more information about saving files, see “Saving, Exporting, and Backing Up Files” on page 39 of the Reference Manual.

Setting Defaults

Default settings determine the initial characteristics of objects when they are first drawn. When set up in advance, they can help you both save time and avoid mistakes. Before you draw walls and create rooms, therefore, you should always make sure the defaults will meet your needs for the current project. For more information about defaults, see “Preferences and Default Settings” on page 53 of the Reference Manual.

While all defaults are important, there are several that are particularly helpful to be aware of because they help determine the size and structure of the building.

To access a file's default settings

1. Select **Edit> Default Settings**  to open the **Default Settings** dialog.
2. Click on the white arrow next to a category to expand it and show its contents.
 - Click on the black downward facing arrow to collapse the category again.
3. Select a defaults dialog that you would like to open and click the **Edit** button.
 - You can also open the defaults dialog by double-clicking on a line item

Floor Defaults

The **Floor Defaults** dialogs let you set the default floor and ceiling heights and room moldings for each floor. For more information, see “Floor Defaults Dialog” on page 190 of the Reference Manual.

To set the Floor Defaults

1. In the **Default Settings** dialog, select "Floor" from the list and click the **Edit** button to open the **Floor Defaults** dialog for the current floor.
 - In a plan in progress with multiple floors, begin by navigating to the floor where you would like to modify the floor defaults, then open the **Default Settings** dialog.
2. On the Structure panel, note the **Ceiling Height**. The initial value is 109 1/8” (inches). Leave this value unchanged for this tutorial.
3. Click OK to close the **Floor Defaults** dialog.

Wall Defaults

The **Wall Defaults** dialog lets you specify the thickness, materials, and other characteristics of the walls that are drawn by each of the Wall Tools. For more information, see “Wall Type Definitions” on page 122 of the Reference Manual.

To set the Wall Defaults

1. In the **Default Settings** dialog, click on "Walls", and click the **Edit** button.
2. For this tutorial, select "Stucco-6" from the **Exterior Wall** drop down list and click OK.

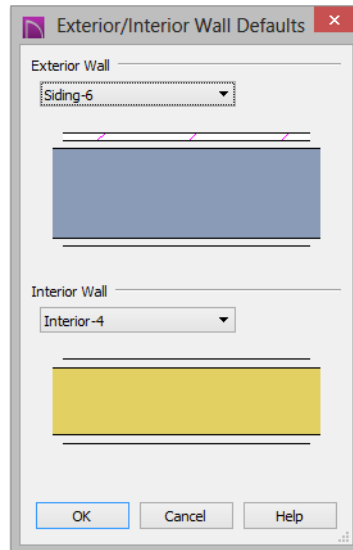
**Dimension Defaults**

Dimension lines are important for both positioning walls and other objects and for annotating your drawing. It is a good idea, therefore, to specify how you want dimensions to locate objects as well as their appearance before you begin drawing.

To set the Dimension Defaults

1. In the **Default Settings** dialog, click on "Dimension" and click the **Edit** button.

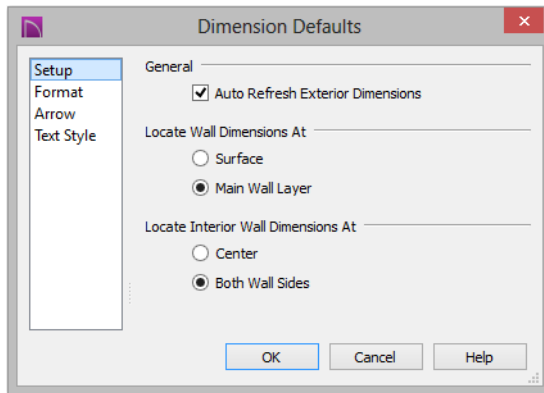

2. Review each of the panels and settings available for setting up your Dimension Defaults.
3. For more information, see “Dimension Defaults Dialog” on page 347 of the Reference Manual.

You may want to review some of the other available defaults when setting up your template. For example, you can modify your Cabinet defaults, where you can set up your materials for Base, Wall and Full Height Cabinets so that any future cabinets placed in the plan will initially use these default settings.

Drawing Walls

Once your defaults are set, a new drawing can be started by drawing some exterior walls. When drawing walls, do not try to size or position them precisely - they can be more easily positioned after they are created. For more information, see “Walls and Railings” on page 105 of the Reference Manual.



To draw exterior walls

1. When drawing a structure’s perimeter walls, it is recommended that you make sure **Grid Snaps** are turned on. You may choose to disable them, though, once the shell walls are in position. See “Snap Behaviors” on page 74 of the Reference Manual for more information.
 - Select **Build> Wall> Straight Exterior Wall**  from the menu or click the corresponding toolbar button, then click and drag from left to right to draw a wall.
2. There are a few things to make note of as you draw a wall.

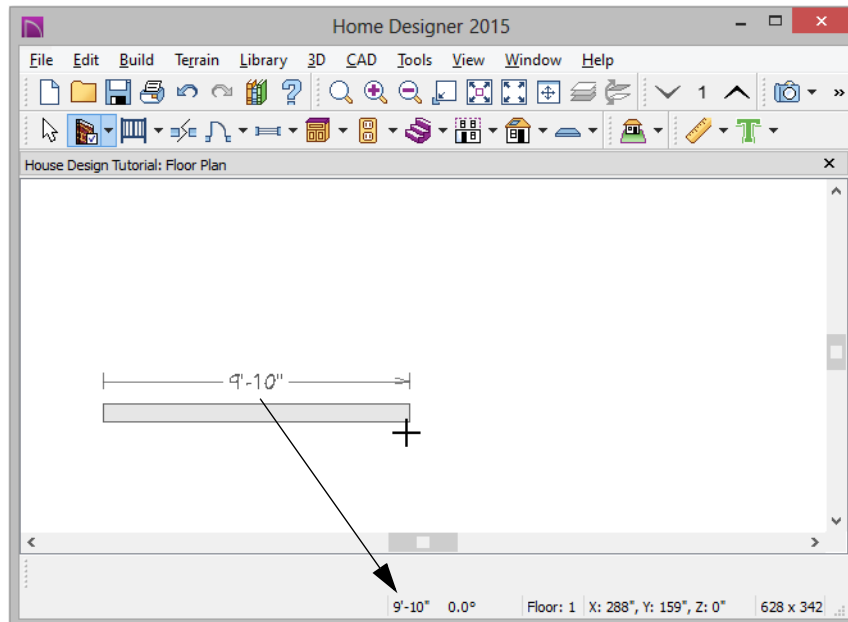
- The wall's length displays in two places: above the wall and in the Status Bar at the bottom of the screen. Its angle is also shown in the Status Bar.



Wall length and angle are indicated in the Status Bar as the wall is drawn

- Wall angles are restricted to increments of 15° when **Angle Snaps**  are on. In most instances, this makes drawing straight walls easy and is desirable; however, you can toggle Angle Snaps on and off by selecting **Edit> Snap Settings> Angle Snaps**  or pressing the F10 key. See “Snap Behaviors” on page 74 of the Reference Manual for more information.
3. Continue drawing walls, creating a rough outline of the building's exterior, as shown in the following image.
 - Exact dimensions are not important yet, but keep the final size of the structure in mind as you draw. The overall lengths of this building's sides are 41' x 39'6".
 - It is helpful to draw exterior walls in a clockwise direction to ensure the proper orientation of wall surfaces.
 - When the walls enclose an area completely, a Living Area label is created. See “Living Area” on page 140 of the Reference Manual.

4. When your walls completely enclose an area, a roof will automatically be generated. For the purposes of this tutorial, this roof can be removed. Select **Build> Roof> Delete Roof** . When asked if you want to turn **Auto Rebuild Roofs** off, click Yes.

Note: The "Auto Rebuild Roofs" and "Auto Refresh Exterior Dimensions" options have been turned off in this tutorial to simplify the display of the building in floor plan view. For more information, see "Build Roof Dialog" on page 211 of the Reference Manual.

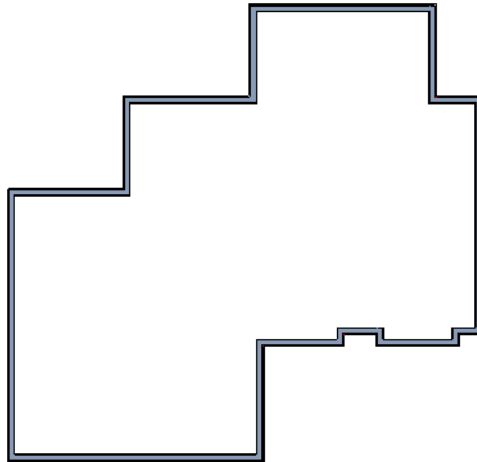

Interior walls are drawn the same way that exterior walls are.



To draw interior walls

1. Select **Build> Wall> Straight Interior Wall**  from the menu or click the corresponding toolbar button.

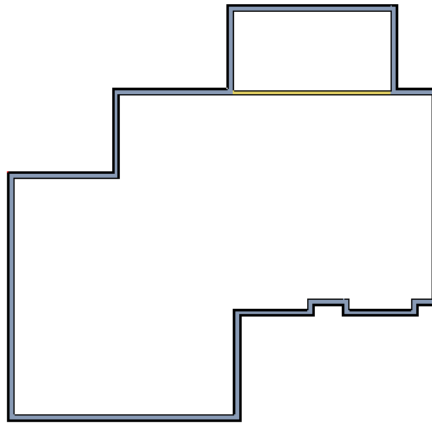
2. Draw an interior wall as shown in the following image.



To delete a wall

1. While the **Select Objects**  tool is active, click on a wall with the pointer to select it.
2. Press the **Delete** key or click the **Delete**  edit button.

Creating Dimension Lines



Dimension lines locate walls, openings in walls, and other objects. In Home Designer Interiors, you can generate two types of automatic dimension lines and draw a variety of manual dimensions and Interior Dimensions. For more information, see “Dimensions” on page 347 of the Reference Manual.

To create automatic exterior dimension lines

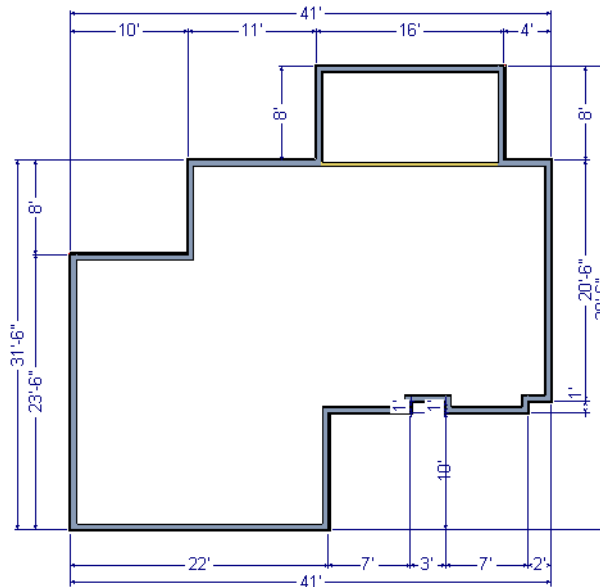
1. Select **CAD> Dimensions > Auto Exterior Dimensions** .



LIVING AREA
1145 sq ft

2. For a closer view of a certain area, click the **Zoom**  tool, click and drag a box around the area you want to see in detail, and release the mouse button. That area fills the screen. For more information, see “View and Window Tools” on page 313 of the Reference Manual.
3. To return to the previous zoom factor, select **Window> Undo Zoom** .
4. If you can't see all the exterior dimension lines at once, select **Window> Fill Window Building Only**  to center your plan on screen.

To draw an interior dimension line

1. Select **CAD> Dimensions> Interior Dimension** .

- Click and drag a line that intersects the interior wall and other walls you want to locate.

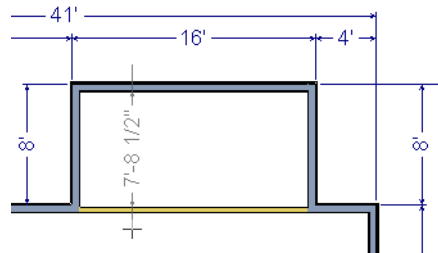

- Release the mouse button to display the interior dimension.

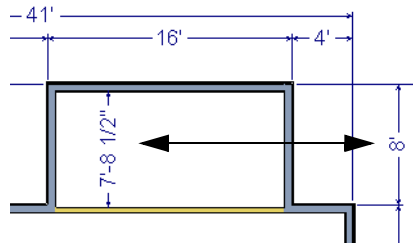



Note: Interior Dimensions locate the framing layer of walls by default rather than wall surfaces.

Adjusting Wall Positions

Now you can adjust the spacing of walls with more precision. There are a couple of ways to move walls into position, but the fastest and most accurate uses dimension lines. For more information about using dimensions to move objects with accuracy, see “Moving Objects Using Dimensions” on page 356 of the Reference Manual.

To move walls using dimensions

- Begin by selecting **Window > Fill Window Building Only**  so the entire building can be seen.
- Click the **Select Objects**  button, then click on a wall that you want to move.
- Click on a dimension line that indicates how far the selected wall is from another wall. There are a couple of ways to determine which dimensions can be used for this purpose:
 - Move the selected wall and see which dimensions update.

- Move your pointer over a dimension. If it is an associated dimension, the icon will change to a pointing hand .

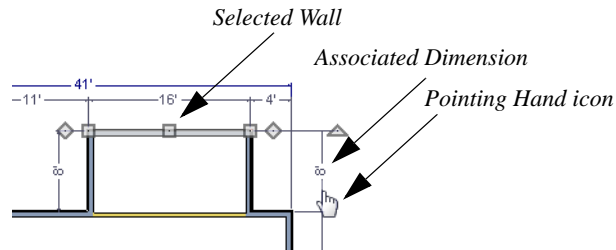

4. Click on the associated dimension and enter a new value. Remember: numbers entered with an apostrophe denote feet and numbers entered with quotes denote inches. If neither apostrophes or quotes are included, the entered value defaults to inches.
5. Use the Enter key on your keyboard to close the dialog and apply the change so that the wall will move the specified distance.
6. Repeat this process for the adjacent exterior wall, continuing in a clockwise direction. It may help to refresh **Auto Exterior Dimensions** (Shift + A) between commands.

 If you use dimensions to reposition walls, you should always work in the same direction, adjusting one wall section after another.

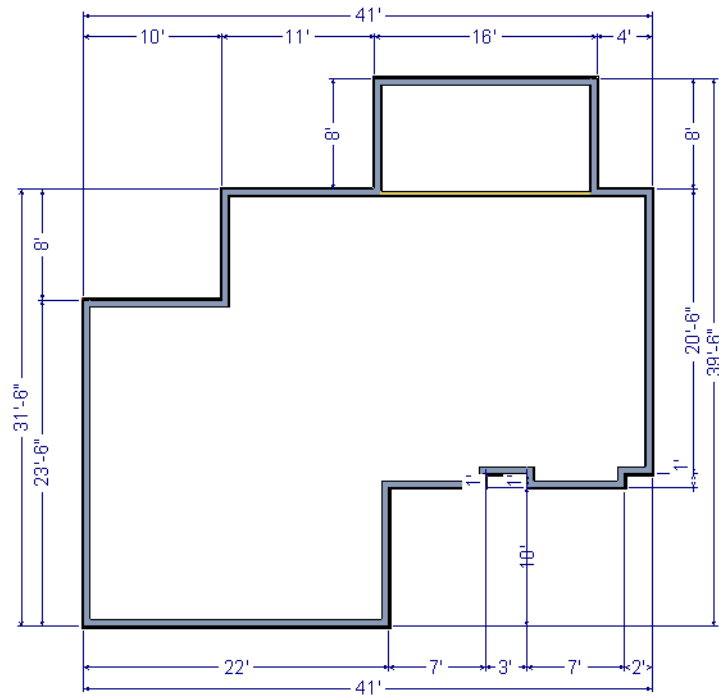

Dimensions can also be used to change the length of a selected wall. Bear in mind, though, that when a wall is resized in this manner its Start point will always be locked and its End point will always be moved. When, adjusting all the walls in a floor plan, it is often easier to move them than to resize them. See “Editing Walls” on page 116 of the Reference Manual.

When you are finished, your dimensions should match those in the following image:



When your exterior walls are in position, you may find it helpful to delete the dimensions.

To delete all dimensions at once



1. Select **Edit > Delete Objects**  to open the **Delete Objects** dialog. See “Delete Objects Dialog” on page 103 of the Reference Manual.
2. Select the **All Rooms On This Floor** radio button.
 - Check **Manual Dimensions** to delete manually-drawn dimension lines such as those drawn by the **Interior Dimension**  tool;
 - Check **Automatic Dimensions** to delete automatically generated dimension lines such as those created by the **Auto Exterior Dimensions**  tool;
 - Click OK.

If you delete Automatic Dimensions, **Auto Refresh Exterior Dimensions** will be turned off. You can turn this feature on again whenever you want in the Dimension Defaults dialog. See “Dimension Defaults” on page 23.

Although using dimensions is generally the fastest and most accurate way to move walls, you can also move them using their edit handles and edit tools.

To move walls using their edit handle

1. Click the **Select Objects**  tool then click on an exterior wall to select it.
2. Click and drag the Move edit handle that displays at the position along the wall where you clicked. Walls can be moved perpendicular to the direction that they are drawn.
3. As you move the wall, the dimension lines that indicate how far it is from other walls will update.

If you have difficulty positioning a wall at a particular location, try zooming in on it using either the **Zoom**  or **Zoom In**  tool or by scrolling with your mouse wheel. You can also use the arrow keys on your keyboard to nudge a selected wall up, down, left, or right on-screen.

Creating Rooms

Once the exterior of the house is in place, you can begin drawing interior walls and creating rooms. Rooms are defined by the walls that enclose them and can be assigned a Room Type that applies attributes such as flooring that are typical to that type of room. For more information about rooms, see “Room Types” on page 137 of the Reference Manual.

To define rooms using interior walls

1. Select **Build> Wall> Straight Interior Wall** , then click and drag to draw interior walls. As with exterior walls, you don't need to worry about exact placement as you draw.

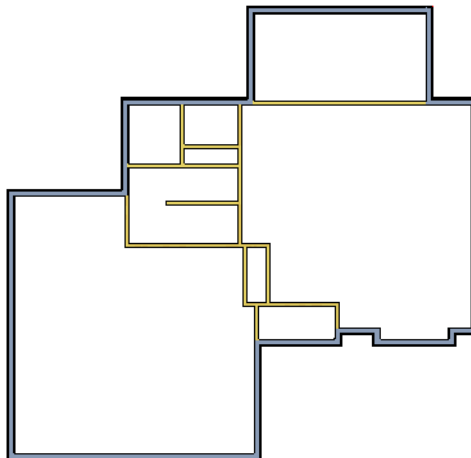

2. Select **Build> Wall> Break Wall**  and click to place two breaks at the locations shown in the following image.

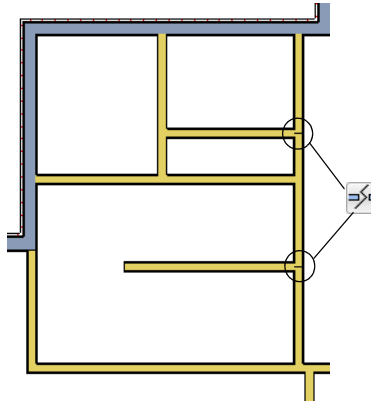

3. Click the **Select Objects**  button, then select the top wall section created by the breaks and delete it. Repeat this process for the bottom wall section, so that only the middle section remains, which is hatched in the image below for illustrative purposes.

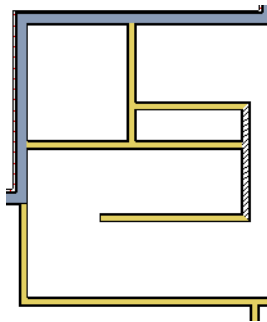

4. Draw a horizontal **Interior Dimension**  inside this new room, then use it to move the vertical interior wall 9' 7 3/4" from the opposing exterior wall.

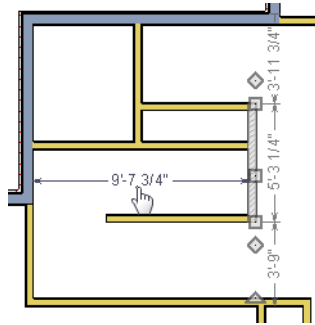

To change a wall's type

1. Select a wall with the incorrect wall type and click the **Open Object**  edit button to open the **Wall Specification** dialog. See "Wall Specification Dialog" on page 123 of the Reference Manual.
2. On the Wall Types panel, click the **Wall Type** drop-down list and select the desired wall type
3. Click **OK** to close the dialog and change the selected wall to the chosen wall type. Repeat this process for each of the wall's that you want to change, as in the image below.

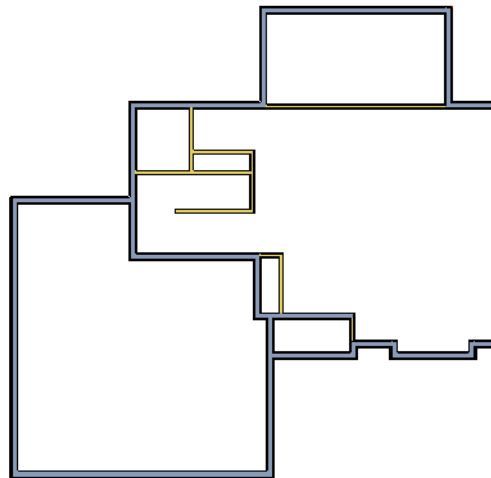



Using Room Dividers

In reality, rooms are not always divided by a physical wall. The separation of two rooms may be marked by a change in the flooring (carpet to tile, for example), or by a change in the interior wall covering. In Home Designer Interiors, a Room Divider or invisible wall can be used to define rooms without creating an actual wall. For more information, see “Room Dividers and Invisible Walls” on page 109 of the Reference Manual.

To create an invisible wall

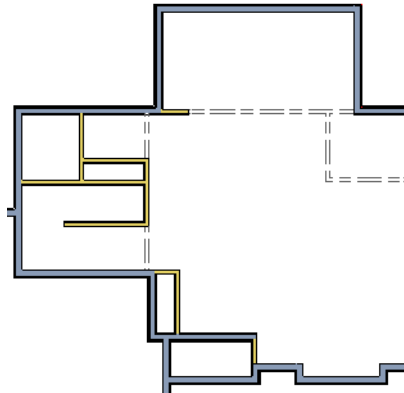
1. Select **Build> Wall> Room Divider**  and draw Room Dividers as shown in the following image.



2. Using the **Select Objects**  tool, select one of the Room Dividers and click on the **Open Object**  edit tool to display the **Wall Specification** dialog. On the **General** panel, note that **Invisible** and **No Locate** are checked.
3. Uncheck **No Locate**, as while this option is selected, it will prevent dimensions from locating the wall, and click **OK**. Repeat this process for any of the remaining invisible walls in the plan that you want to be able to dimension to.

- Adjust the wall spacing of the interior, exterior and invisible walls to match the following image using **Interior Dimensions** , just as you did with exterior walls.

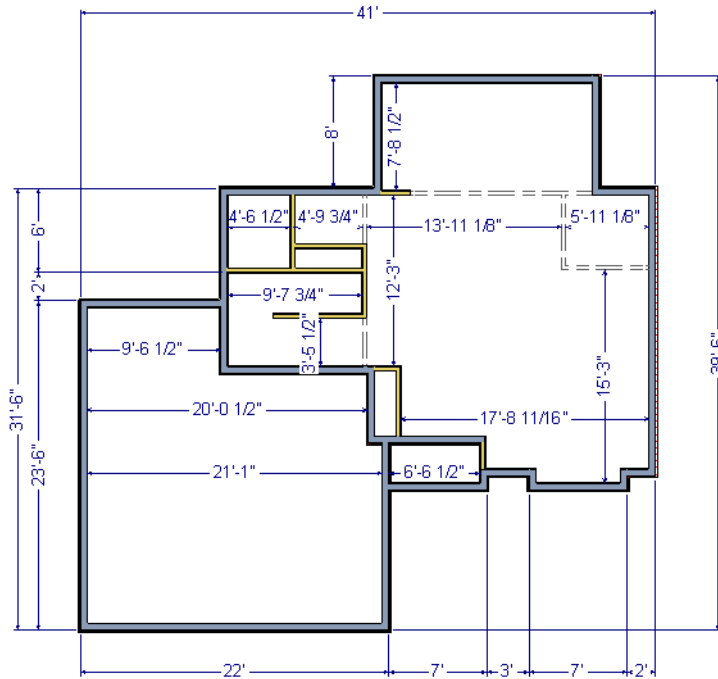

Room Types

Rooms in Home Designer Interiors are given special attributes when they are assigned a Room Type. For example, porches use a concrete floor material and have a ceiling and roof, while decks use floor planking and have no ceiling or roof. For more information, see “Rooms” on page 133 of the Reference Manual.

To designate a Room Type for a room

- Click the **Select Objects**  button, then click in the small room at the bottom of the plan.

- Click the **Open Object**  edit button to open the **Room Specification** dialog.

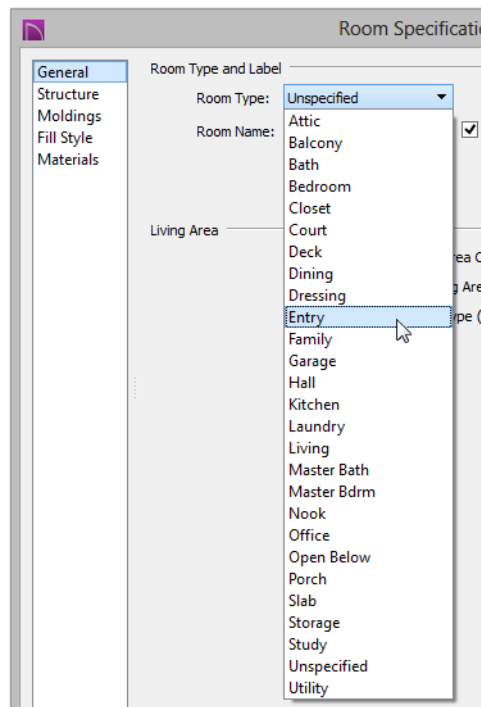

- On the General panel, click the **Room Type** drop-down list and select **Entry**.
- Click **OK** close the dialog and apply your change.

Double-clicking a room when the **Select Objects**  tool is active will also open the **Room Specification** dialog. For more information, see “Room Specification Dialog” on page 144 of the Reference Manual.

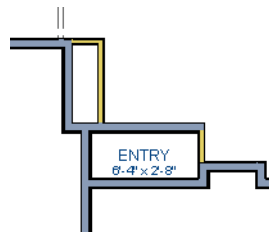

5. Open each of the rooms and assign room types as shown in the following image.

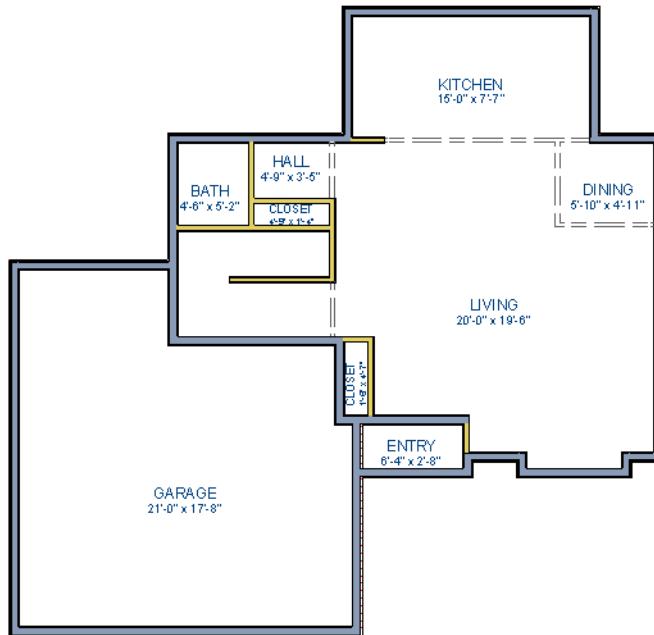

Creating a 3D View

You can create a 3D view of the model to see how it looks so far. For more information, see “3D Views” on page 321 of the Reference Manual.

To create a camera view

1. In floor plan view, click the **Fill Window**  button to zoom out as needed to fill the view window with the entire drawing.
2. Select **3D> Create Camera View>Full Camera**  (or press Shift + J).

- Click at the bottom of the floor plan view window and drag a line that stops at the Entry. The point where you click (A) defines the point of perspective and the line (B) defines the direction of perspective.

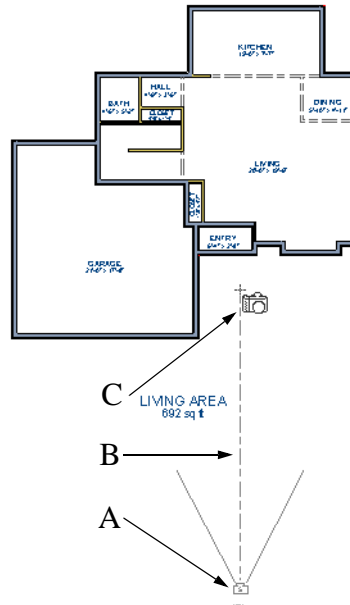

- Release the mouse button to create the 3D camera view. Where the mouse is released (C) is the camera's focal point.
- You can use the **Mouse-Orbit Camera**  tool to change the camera's perspective. The camera will revolve around its focal point (C). See "Repositioning Cameras" on page 326 of the Reference Manual for more information.

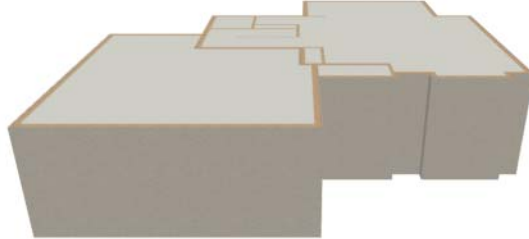

6. To smooth out the edges and create a more realistic rendering of the model, you can select **3D> Camera View Options> Final View**  or **Final View with Shadows** .



Note: Final Views often take significantly longer to generate than Previews, so the 3D view reverts back to the Preview Settings as soon as anything is changed within the view.

7. To return to floor plan view, select **File> Close** from the menu.

To create a Doll House View



1. In floor plan view, select **3D> Create View> Doll House View** . A Doll House View displays a single floor without a ceiling or roof.
2. Select **3D> Move Camera With Mouse> Mouse-Orbit Camera**  (which should be selected by default) then click and drag the mouse on screen to change the camera perspective. You can press the I (in) and the O (out) keys on the keyboard to zoom in and out of the plan. For more information on modifying camera views, see “Editing 3D Views” on page 329 of the Reference Manual.



Adding Floors

Creating new floors in a plan is easy, but it is best to do so only after the first floor plan has been finalized. With this first floor of this plan completed, you can now add a second story and basement. For more information about working with multiple floors, see “Multiple Floors” on page 189 of the Reference Manual.

To add a second floor

1. Select **Build> Floor> Build New Floor** . The **New Floor** dialog displays.
2. Select **Derive new 2nd floor plan from the 1st floor plan** and click **OK** to close the **New Floor** dialog to display the Floor 2 Defaults. You could also create a blank second floor plan and then draw the second story walls manually; however, it is usually faster to automatically generate the perimeter walls and then edit them as needed.
3. Click **OK** and a floor plan for the second floor is created based on the exterior walls of the first floor plan. The second floor perimeter walls will now require some editing. It will be difficult to know where the second story walls should be without knowing where the first floor walls are located.
4. Select **Tools> Reference Floors> Reference Display**  or press the F9 key. The first floor walls are displayed for reference.

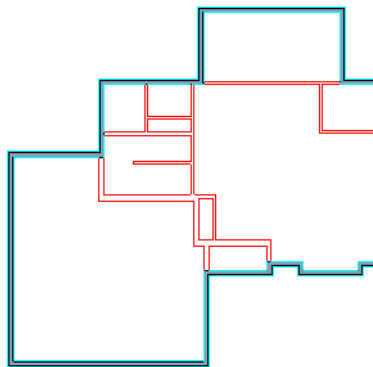

To merge two parallel walls into one

1. Select the topmost horizontal wall, then click and drag its Move edit handle to move it.
2. When the wall becomes aligned with another wall and can merge with it, it will stop at a "sticky point."

3. Release the mouse button. Note that if you keep dragging the mouse, the wall will break free of the sticky point and you can continue moving it.

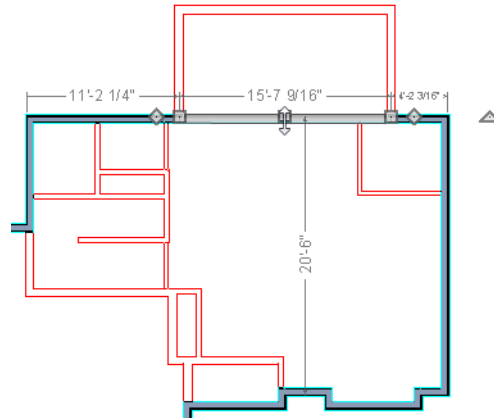

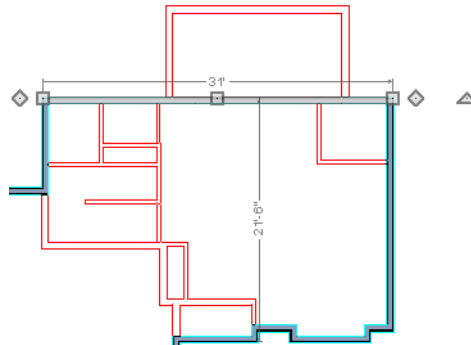

4. When you select the wall now, notice that the edit handles are located along its full length.

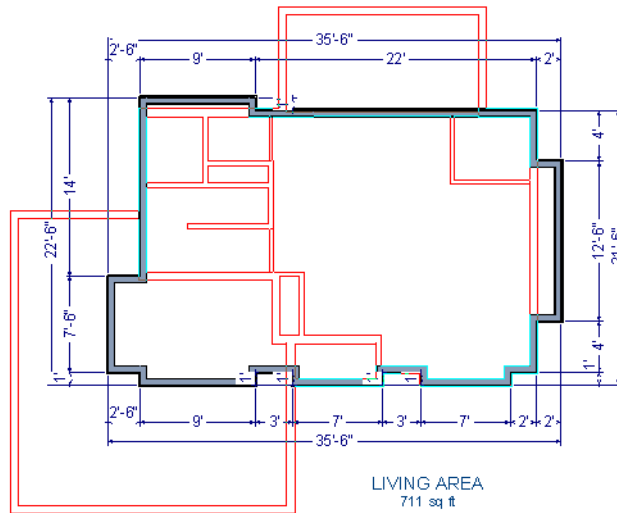

Note: Before merging walls, make sure Object Snaps are turned on. For more information, see "Object Snaps" on page 74 of the Reference Manual.

Use the techniques described above and in “Drawing Walls” on page 24 and “Adjusting Wall Positions” on page 29 to create exterior walls as shown in the following image:





5. At this point, remember to **Save**  the plan.

To create a foundation or basement

1. Select **Build > Floor > Build Foundation** . In the **Build Foundation** dialog:
 - Change the **Wall Height** to 100 inches.
 - Click **OK** to close the dialog and create a foundation level for your plan.
2. Select **Derive New Foundation Plan From the First Floor Plan** and click **OK** to close the **New Floor** dialog. For more information, see “Adding Floors” on page 191 of the Reference Manual.

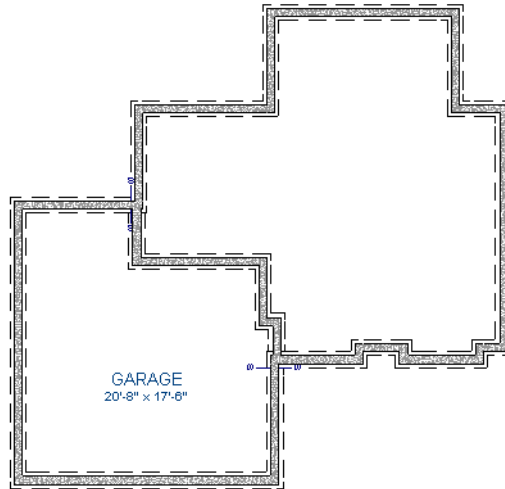
3. You can select **Window> Fill Window Building Only**  from the menu to center the plan on screen.



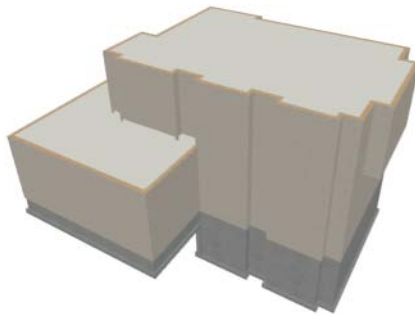

4. Select **3D> Create View>**  to create a 3D view of the entire plan so far.



To add a second story balcony





Now that a second floor has been created, the tools and techniques described earlier can be used to add a second story balcony that is aligned with the floor below.

1. Press **Ctrl + Tab** on your keyboard to switch back to floor plan view and return to Floor 2.
2. If they are not already displayed, click **Reference Display**  to display the first floor walls.
3. Select **Build> Wall> Straight Railing** .

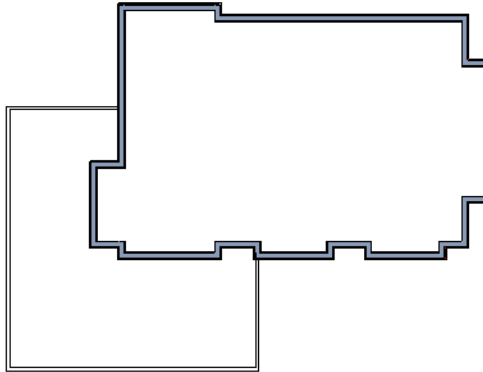
 For best results, do not specify the balcony room as a Deck.

4. Draw a balcony as shown in the following image:



- If **Object Snaps**  are on, the second story balcony railing will likely snap into alignment with the walls on Floor 1 as they are drawn. If not, you can manually align them as described in the following steps.
5. Next, use the **Select Objects**  tool to select one of the railings, and click the **Open Object**  edit button. On the General panel of the **Railing Specification** dialog, increase the Thickness to 8 1/8" and click **OK**.
 6. With the railing still selected, click the **Align with Wall Below**  edit button.
 - If **Align with Wall Below**  is not available, the selected railing either needs to be moved closer to the wall below, or the railing is already aligned with the one below. See “Aligning Walls” on page 118 of the Reference Manual.
 7. Repeat these steps for each section of railing that has a wall directly below it on Floor 1.

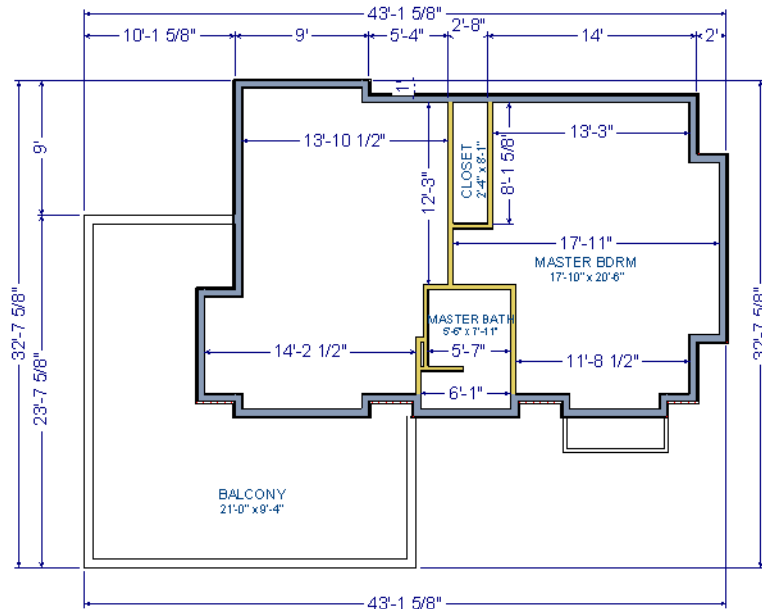

8. Finally, add interior walls to the second floor. When you are finished, it should look similar to this:



Adding Stairs

Now that the structure has three floors, it will require stairs. For more information about stairs, see “The Stair Tools” on page 218 of the Reference Manual.

To draw stairs with a landing

1. Click **Down One Floor**  to go to the first floor. You may want to select **Tools> Reference Floors> Reference Display**  to turn off the display of the reference floor.
2. Select **Build> Stairs> Straight Stairs**  (or press Shift + Y).

- Click and drag to draw a short stair section from right to left, as shown in the following image:

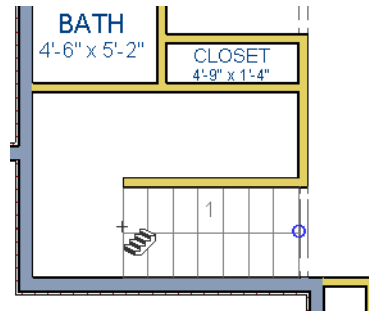

- Draw another stair section from left to right, directly above the first:

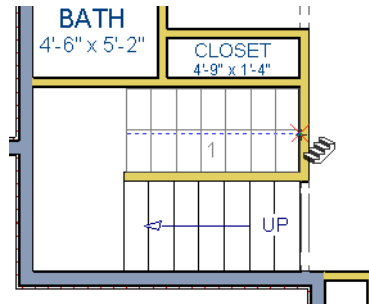

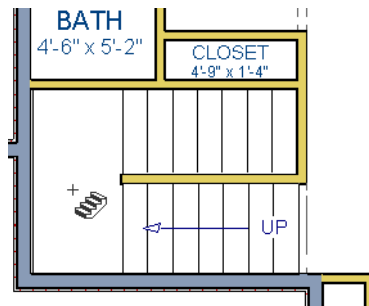

- While the **Straight Stairs** tool is still active, click in the space to the left of the two stair sections to create a landing.





- Click on the landing with either the **Straight Stairs** tool or the **Select Objects** tool active, and if needed, resize it using its edit handles to fit it against the wall.

A stairwell is simply an interior room that has been assigned the Room Type “Open Below”. See “Room Specification Dialog” on page 144 of the Reference Manual.

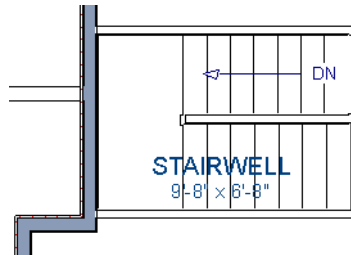

To create a stairwell

1. Select either of the two stair sections.
2. Click the **Auto Stairwell**  edit button to create a stairwell.
3. Click the **Up One Floor**  button to go to Floor 2. Notice that there is now a stairwell room defined by railings directly above the stairs on Floor 1.





It makes sense to draw the basement stairs directly below the stairs to Floor 1. The **Auto Stairwell**  edit tool could be used to create another stairwell; however, in this situation, it will be better to use the existing interior walls to define the stairwell, rather than by the railings that the Auto Stairwell tool generates.

To manually create a stairwell

1. Click the **Down One Floor**  button to go down to Floor 1.
2. Next, click on a stair section inside of the stairwell room and click the **Select Next Object**  edit button as many times as needed until the room is selected instead of the stair.

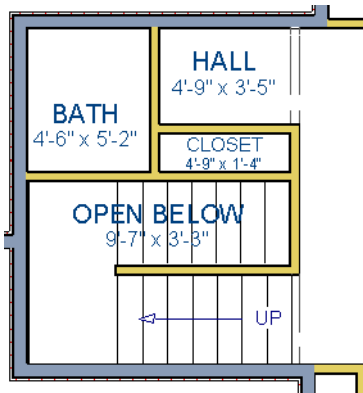

- With the room selected, click the **Open Object**  edit button and in the **Room Specification** dialog, select "Open Below" from the **Room Type** drop-down list and click OK.



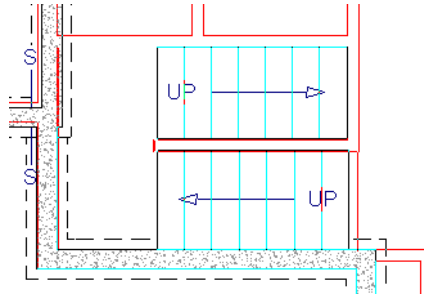

- Go **Down One Floor** to the foundation (Floor 0) level, and turn on the **Reference Display** .
- Select **Build> Stairs> Straight Stairs**  and draw two stair sections directly below the stairs you drew on Floor 1. Do not draw the landing just yet, though.

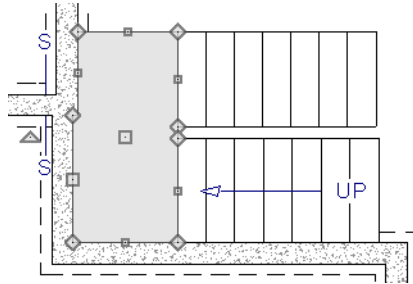

- Select each stair section and adjust its width and position using its edit handles so that it fits within the walls forming the stairwell drawn on Floor 1.
- When the stair sections are positioned properly, click with the **Straight Stairs**  tool to create a landing as you did on Floor 1.

- Next, use the **Select Objects**  tool to select the landing, click on the **Break Line**  edit tool, and click along the landing's edge to place a break, which allows you to reshape it so that it fits against the foundation walls.



- Select **3D> Create View> Full** and create an exterior view of your plan.
- When the view has generated, select **3D> Glass House**  to view the entire model, inside and out.
- Select **3D> Move Camera With Mouse> Mouse-Orbit Camera**  and click and drag the mouse on screen to change the camera perspective. You can press the I (in) and the O (out) keys on the keyboard to zoom in and out of the plan.

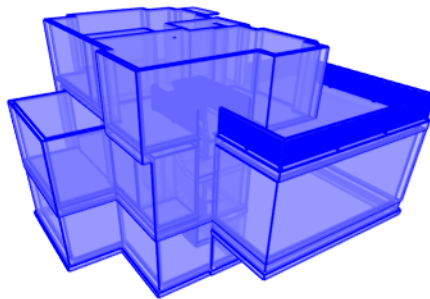

Placing Doors and Windows

Now is a good time to add some doors and windows to the model. For more information about doors and windows, see “Doors” on page 151 of the Reference Manual and “Windows” on page 167 of the Reference Manual.



To add a door

1. If your views are still tiled, close the 3D view and maximize the floor plan view.
2. Select **Build> Door> Hinged Door** .
3. Move the pointer to the entry and click on the front wall, left of its center, to place a door.

To add a window

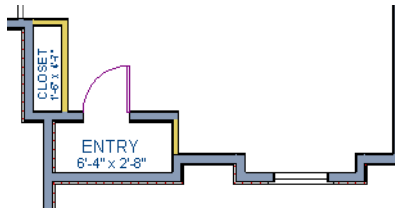
1. Select **Build> Window> Window** .
2. Move the pointer to the entry and click on the wall, right of center, to place a window.

**To edit a door**

1. To better see the results when the door is edited, create a **Full Camera** , view inside the structure, pointed at the entry.
2. Click the **Select Objects**  tool, then click on the door to select it in the 3D view.



3. Click the **Open Object**  edit button to open the **Door Specification** dialog. For more information, see “Door Specification Dialog” on page 160 of the Reference Manual.
4. On the General panel, set the **Door Style** to Glass and set the Width to 36".

5. On the Frame & Lites panel, set the **Frame Bottom** to 8 inches. Press the Tab key to update the preview image on the right side of the dialog so that it reflects your change.
6. On the Lites panel, set the **Lites across** to 3 and **Lites vertical** to 5.
7. On the Hardware panel, set the Handle **In from Door Edge** to 2"
8. Click **OK** to return to the 3D view.



To edit a window

1. Next, click on the window to select it.



2. Click the **Open Object**  edit button to open the **Window Specification** dialog. For more information, see “Window Specification Dialog” on page 174 of the Reference Manual.

3. On the General panel, select “Fixed Glass” from the **Window Type** drop-down list and set the **Width** to 54”.
4. On the Lites panel, change the **Lites Across** to 4 and **Lites Vertical** to 4.
5. Click OK to close the **Window Specification** dialog.



To customize all of your doors and windows in this manner, make your changes in the Door Defaults and Window Defaults dialogs before placing them. For more information, see “Default Settings vs Preferences” on page 54 of the Reference Manual.

To change the door swing

1. Return to floor plan view and select the door.
2. Click the **Change Opening/Hinge Side**  edit button.

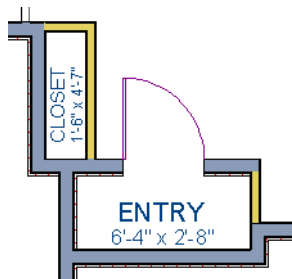



To copy a window or door

1. Return to the 3D view and select the window, or door, you wish to copy.

2. Click the **Copy/Paste**  edit button. For more information about copying objects, see “Copying and Pasting Objects” on page 77 of the Reference Manual.

Doors and windows can be placed, selected, deleted, copied, pasted, and edited in either 2D or 3D views. If there is a window design that you will be using throughout a plan, you can create it once, then just copy and paste it. An even better approach is to set your door and window defaults to the desired settings before placing these objects. For more information, see “Default Settings vs Preferences” on page 54 of the Reference Manual.

To create a doorway

1. Return to floor plan view and **Zoom**  in on the entry room.
2. Select **Build> Door> Doorway**  and click on the front Entry room wall to place a doorway at that location.
3. Select **3D> Create View> Camera**  and create an exterior camera view of the doorway.

To customize the doorway

1. Select the doorway by clicking on its frame and click the **Open Object**  edit button to open the **Door Specification** dialog.
2. On the General panel, change the **Width** to 54" and the **Height** to 96".
3. On the Casing panel, change the **Exterior Casing Width** to 10". Be sure to delete the (D) from the text field. It stands for "default" and if it is not removed, it will continue to apply the default casing width, regardless of the value you specify.
4. Click OK to close the **Door Specification** dialog.

To center a wall opening

1. Return to floor plan view and select the doorway.
2. Click the **Center Object**  edit button, then click inside the entry room, near the interior wall containing the doorway. For more information, see “Using Center Object” on page 99 of the Reference Manual.

Use the tools and techniques you’ve learned to add window and doors to the rest of the plan, as shown in the following images. Doors placed in interior walls become interior doors and have different specifications than exterior doors. If you feel inspired, customize the doors and

windows as you see fit. For example, increase a door's width to 48" or greater and the program will automatically create a double door.

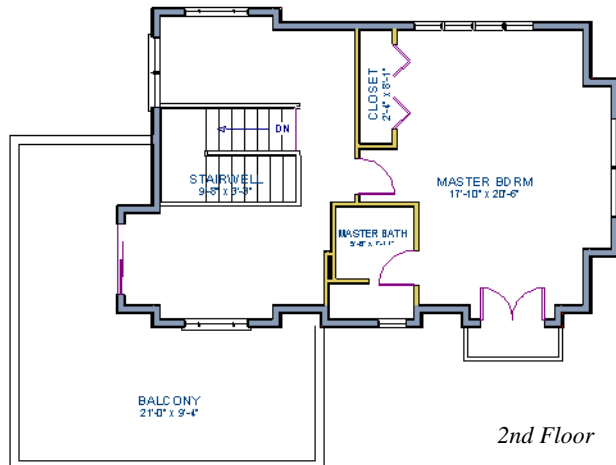
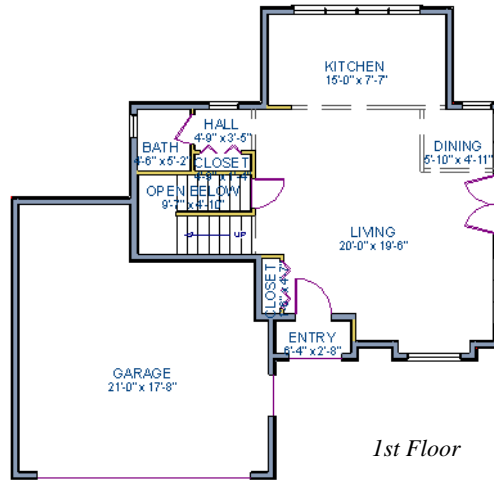

When you have finished, **Save**  your work.

If you would like, you can continue working on this plan in the . You can also learn about materials in the Materials Tutorial or find out more about roofs in the Roof Tutorial.

Roof Tutorial

The majority of Roof Tutorial describes some common roof styles that can be created using settings in the **Wall Specification** dialog and can be completed independent of the other tutorials. It also explains how to add gables over doors and windows, how to create dormers automatically and manually, and how to create skylights.

The Adding a Roof to the Stucco Beach House section continues where the Interior Design Tutorial left off and explains how to add a roof to that plan.

For more information about Roof Tools, see “Roofs” on page 209 of the Reference Manual.



In this tutorial you’ll learn about:

- Getting Started with Automatic Roof Styles
- Hip Roofs
- Gable Roofs
- Shed Roofs
- Offset Gable Roofs
- Gambrel Roofs
- Gull Wing Roofs
- Half Hip Roofs
- Mansard Roofs
- Roof Style Quick Reference
- Creating Dormers
- Skylights
- Using the Break Wall Tool to Modify Roofs
- Adding a Roof to the Stucco Beach House
- Troubleshooting Roof Issues



Getting Started with Automatic Roof Styles

This tutorial uses a simple, rectangular structure to explain how to create common roof styles using roof style directives assigned to the exterior walls.

To begin a new plan

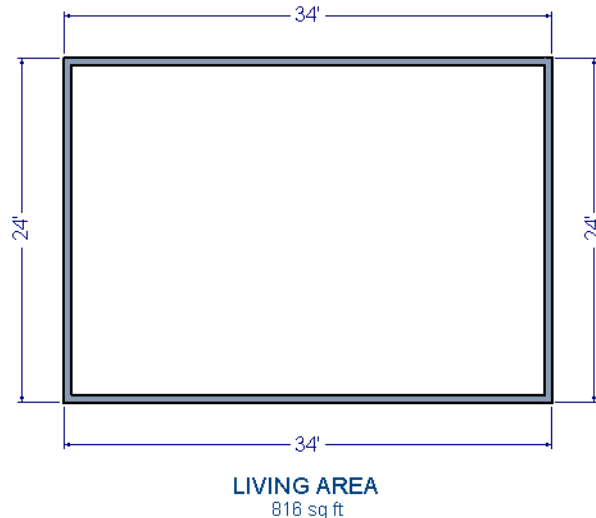
1. If any plans are open, select **File> Close All** from the menu.
2. Select **File> New Plan**  to open a new plan. In the **Create New Plan** dialog, select the Default Style template.
3. Select **Build> Wall> Straight Exterior Wall**  and draw a rectangular floor plan, measuring about 34 feet by 24 feet (approximately 10.4 m by 7.3 m), in a clockwise direction. See “Drawing Walls” on page 111 of the Reference Manual.



4. Select **3D> Create View> Camera** , then click and drag a camera arrow outside of the house and pointed towards it.
 - If you wish, you can select **3D> Toggle Textures**  from the menu to turn off the display of material textures and represent all materials using solid colors.
5. Select **Window> Tile Vertically**  to see both views at the same time.

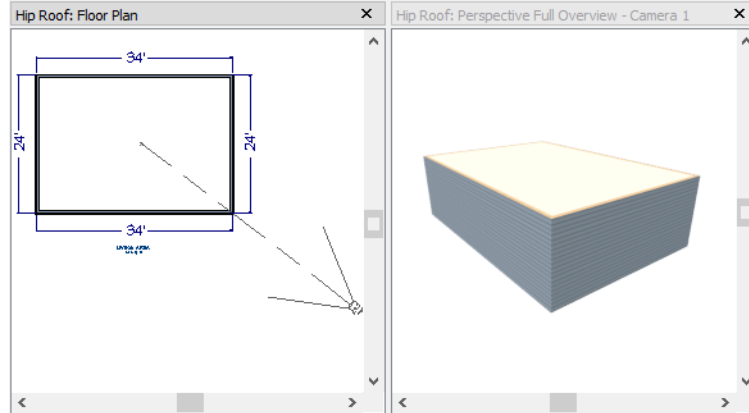



Roof Style Directives in Walls

By default, the program will generate a roof plane bearing on each exterior wall that does not have a room-defining wall directly above it, and will use the pitch specified in the **Build Roof** dialog. The result is a hip style roof; however, if you need a different condition over a particular wall to produce another roof style, you can define it in that wall's specification dialog.

Individual walls can be selected and edited in both 2D and 3D views. When multiple walls are to be edited, however, it is usually quicker and easier to work in floor plan view. See “Editing Walls” on page 116 of the Reference Manual.

To set a wall's roof directives

1. Click the **Select Objects**  button, then click on a wall to select it.
2. Click the **Open Object**  button to open the **Wall Specification** dialog.
3. On the Roof panel:
 - The **Roof Options** control how the roof builds over the selected wall.
 - The **Pitch Options** control how steep the roof that bears on the selected wall is.

Attic Walls

When a roof is generated, attic walls may also be generated. An attic wall fills the space between the walls that define a room and the roof above. The triangular-shaped wall of a gable, for example, is created using an attic wall.



If you do not want to see attic walls in floor plan view, you can turn off their display.

To turn off the display of attic walls

1. In floor plan view, select **Tools> Display Settings> Display Options**  (or press the ~ key) to open the **Display Options** dialog.
2. Find "Walls, Attic" in the Name column, remove the check from the Display column for this item, and click OK. For more information, see "Display Options Dialog" on page 71 of the Reference Manual.

Deleting Roofs

Roof planes can be easily deleted in either of two ways:

- Select **Build> Roof> Delete Roof** .
- Select **Edit> Delete Objects**  and in the **Delete Objects** dialog, select either **All Rooms On This Floor** or **All Floors**; place a check beside **Roof**; and click **OK** to delete all roof planes either on the current floor or in the plan.

If a warning message states that roofs cannot be deleted while **Auto Rebuild Roof** is on, click the **Yes** button to turn off **Auto Rebuild Roof** and delete the roof.

Auto Rebuild Roofs

Auto Rebuild Roofs is a convenient feature in Home Designer Interiors that automatically rebuilds the roof in a plan whenever the exterior walls or floor/ceiling heights are changed. Auto Rebuild Roofs is turned on by default, but this tutorial is presented with this feature disabled; however the information presented here also applies when it is enabled.

To turn on/off Auto Rebuild Roofs

1. Select **Build> Roof> Build Roof**  from the menu.
2. In the **Build Roof** dialog, check or uncheck **Auto Rebuild Roofs** and click **OK**.

Hip Roofs

When roofs are automatically generated, a roof plane is built over every exterior wall in the plan that does not have another wall drawn above it. The result is referred to as a hip roof.

To create a hip roof

1. Begin with the basic rectangular structure described in "Getting Started with Automatic Roof Styles" on page 58.
2. Select **Build> Roof> Build Roof**  from the menu to open the **Build Roof** dialog.



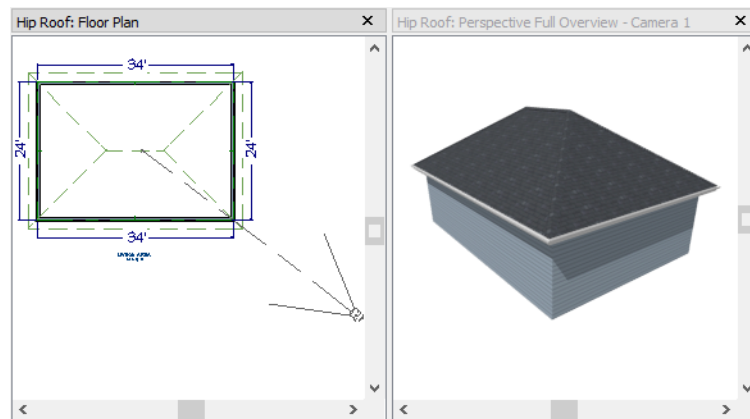

3. Click **OK** to generate a hip roof.



Gable Roofs

If you would like a gable over a particular wall rather than a roof plane bearing on it, you can specify it as a **Full Gable Wall** in the **Wall Specification** dialog. To create basic gable roof, two walls should be specified as **Full Gable Wall**.

To create a gable roof

1. Begin with the basic rectangular structure described in “Getting Started with Automatic Roof Styles” on page 58.
2. .
3. Use the **Select Objects**  tool to select one of the walls drawn vertically on screen.
4. Open the **Wall Specification** dialog and on the Roof panel, check **Full Gable Wall** and click **OK**. See “To set a wall’s roof directives” on page 59.
 - Alternatively, you can click the **Change to Gable Wall(s)**  edit button.
 - To remove the Full Gable Wall attribute from a selected wall, click the **Change to Hip Wall(s)**  edit button.
5. Make the same changes to the other vertically-drawn wall.
6. Select **Build > Roof > Build Roof**  to open the **Build Roof** dialog and click **OK**.

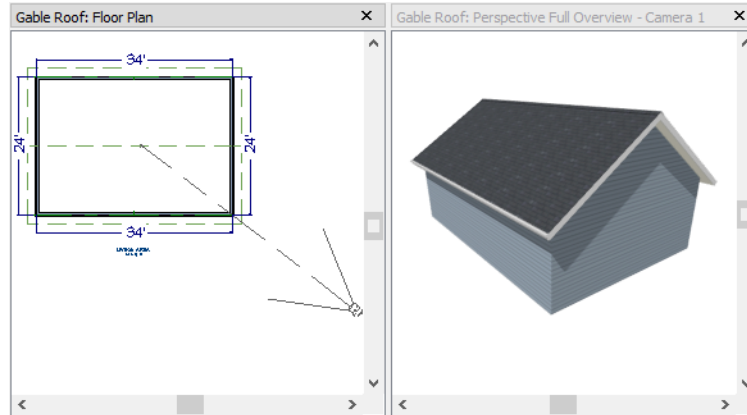

Shed Roofs

To create a single, sloping roof plane, or shed roof, two walls must be specified as **Full Gable Walls**, and one must be a **High Shed/Gable Wall**.

To create a shed roof

1. Begin with the basic rectangular structure described in “Getting Started with Automatic Roof Styles” on page 58.
2. As in the Gable Roofs example, specify the left and right vertical walls as **Full Gable Walls**.
3. Select the lower horizontal wall and open its **Wall Specification** dialog. On the Roof panel, check **High Shed/Gable Wall** and click **OK**. See “To set a wall’s roof directives” on page 59.
4. Select **Build> Roof> Build Roof**  to open the **Build Roof** dialog, specify a **Pitch** of 2 in 12, and click **OK**.

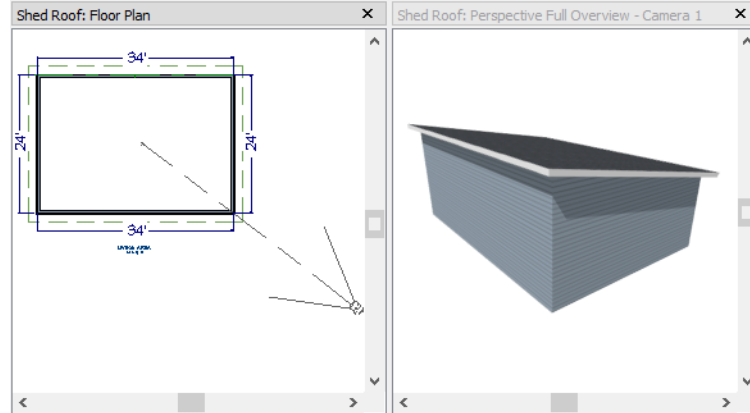

Offset Gable Roofs

An offset gable is a type of gable roof with different pitches on each of the two roof planes and an ridge that is offset from the building's center line. Assign a different pitch to the two roof planes in the **Wall Specification** dialog for the wall supporting each one.

To create an offset gable roof

1. Begin with the basic rectangular structure described in “Getting Started with Automatic Roof Styles” on page 58.
2. As in the Gable Roofs example, specify the left and right vertical walls as **Full Gable Walls**.
3. Select the lower horizontal wall and open its **Wall Specification** dialog. On the Roof panel, leave the **Roof Options** unchecked and change the **Pitch** to 12 in 12. See “To set a wall's roof directives” on page 59.
4. Select **Build > Roof > Build Roof**  to open the **Build Roof** dialog, specify the **Pitch** as 2 in 12, and click **OK**.

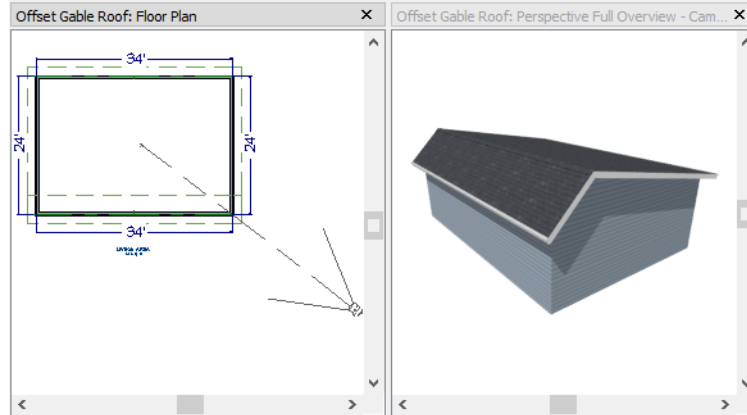

Gambrel Roofs

A gambrel or barn style roof has two pitches on each side of the ridge. The first (lower) pitch on either side is steeper than the pitch near the ridge.

To create a gambrel roof

1. Begin with the basic rectangular structure described in “Getting Started with Automatic Roof Styles” on page 58.
2. As in the Gable Roofs example, specify the left and right vertical walls as **Full Gable Walls**.
3. .
4. Use the **Select Objects**  tool to select one of the walls drawn horizontally on screen.
5. Open the **Wall Specification** dialog and on the Roof panel, change the following settings:
 - Make sure that the **Pitch** value is followed by (D), which means that is set to use the default.
 - Check the box beside **Upper Pitch**.
 - Specify the **Upper Pitch** as 6 in 12 and the **Start Height** as 156".
6. Click **OK** to close the **Wall Specification** dialog. See “To set a wall’s roof directives” on page 59.
7. Make the same changes to the other horizontally-drawn wall.
8. Open the **Build Roof** dialog, specify the **Pitch** as 12 in 12, and click **OK**.

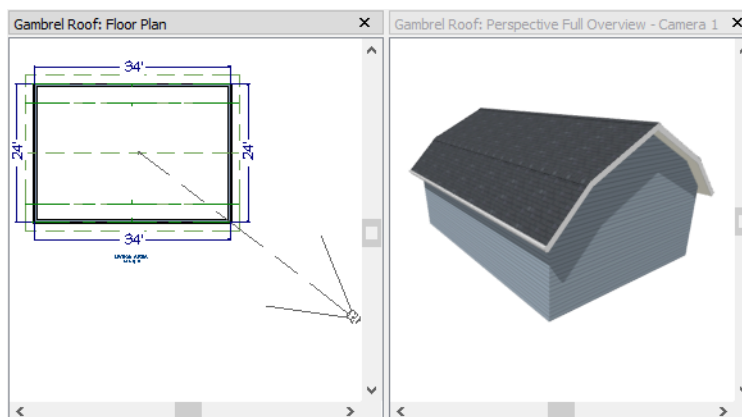

Experiment with alternate pitches and overhangs. Also, try varying the height at which the second pitch begins so that you can see the effect it has on the gambrel roof design.

Gull Wing Roofs

A gull wing roof has two pitches on either side of the ridge, as a gambrel does; but the first pitch of a gull wing is shallower than the steeper upper pitch.

To create a gull wing roof

1. Begin with the basic rectangular structure described in “Getting Started with Automatic Roof Styles” on page 58.
2. As in the Gable Roofs example, specify the left and right vertical walls as **Full Gable Walls**.
3. .
4. Use the **Select Objects**  tool to select one of the walls drawn horizontally on screen.
5. Open the **Wall Specification** dialog and on the Roof panel, and change the following settings:
 - Make sure that the **Pitch** value is followed by (D), which means that is set to use the default.
 - Place a check in the box beside **Upper Pitch**.
 - Keep the **Upper Pitch** as 12 in 12 and change the **Start Height** to 125".
6. Click **OK** to close the dialog. See “To set a wall’s roof directives” on page 59.
7. Make the same changes to the other horizontally-drawn wall.

- Click the **Build Roof**  tool, specify a **Pitch** of 3 in 12, and click **OK** in the **Build Roof** dialog.

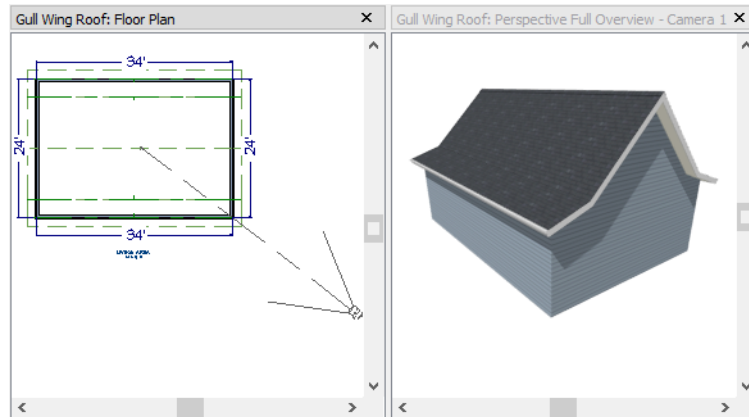

Experiment with the height at which the second pitch begins so that you can see the effect it has on the gull wing roof design.

Half Hip Roofs

A half hip roof has two gable ends. At the top of each gable is a small hip that extends to the ridge.

To create a half hip roof

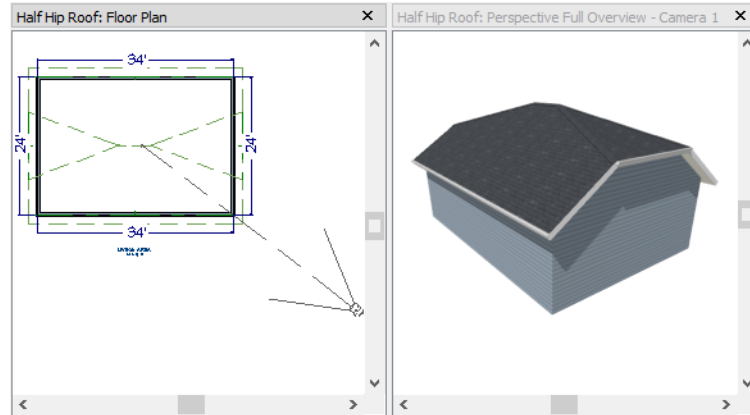

- Begin with the basic rectangular structure described in “Getting Started with Automatic Roof Styles” on page 58.
- As in the Gable Roofs example, specify the left and right vertical walls as **Full Gable Walls**. In addition, change the following **Pitch Option** settings:
 - Check the box beside **Upper Pitch**.
 - Specify the **Upper Pitch** as 3 in 12 and set the **Start Height** at 170”.
- Click the **Build Roof**  tool and click **OK** in the **Build Roof** dialog.



Mansard Roofs

A mansard roof is a hip roof with two pitches on the roof sections above each exterior wall: an extremely steep lower pitch and a gently sloping upper pitch.

To create a mansard roof

1. Begin with the basic rectangular structure described in “Getting Started with Automatic Roof Styles” on page 58.
2. .
3. Use the **Select Objects**  tool to select one of the walls.
4. Open the **Wall Specification** dialog and on the Roof panel, and change the following settings:
 - Check the box beside **Upper Pitch**.
 - Specify the **Upper Pitch** as 1.5 in 12 and the **Start Height** as 132".
5. Click **OK** to close the dialog. See “To set a wall’s roof directives” on page 59.
6. Make the same changes to each of the exterior walls.
7. Click the **Build Roof**  tool, specify a Pitch of 24 in 12, and click **OK** in the **Build Roof** dialog.

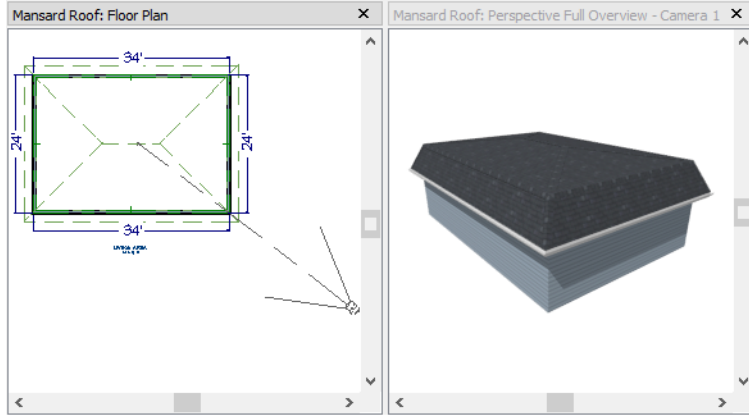

Roof Style Quick Reference

The following chart provides a quick reference for building the roof styles described in this tutorial. The chart shows which walls to change and what to change on the Roof panel of the **Wall Specification** dialog for each wall. These parameters are based on a 34x24-foot model. For different size plans, adjust these numbers.





Roof Type	Wall to Change	Set as Full Gable	Set as High Shed Gable	Lower Pitch	Upper Pitch	Start Height
Gable Roof	Vertical Wall 1					
	Vertical Wall 2					
	Horizontal Wall 1	X				
	Horizontal Wall 2	X				
Shed Roof	Vertical Wall 1	X				
	Vertical Wall 2	X				
	Horizontal Wall 1		X			
	Horizontal Wall 2					
Offset Gable Roof	Vertical Wall 1	X				
	Vertical Wall 2	X				
	Horizontal Wall 1			12 in 12		
	Horizontal Wall 2			3 in 12		
Gambrel Roof	Vertical Wall 1	X				
	Vertical Wall 2	X				
	Horizontal Wall 1			12 in 12	6 in 12	156
	Horizontal Wall 2			12 in 12	6 in 12	156
Gull Wing Roof	Vertical Wall 1	X				
	Vertical Wall 2	X				
	Horizontal Wall 1			3 in 12	12 in 12	125
	Horizontal Wall 2			3 in 12	12 in 12	125
Half Hip Roof	Vertical Wall 1	X			3 in 12	170
	Vertical Wall 2	X			3 in 12	170
	Horizontal Wall 1			6 in 12		
	Horizontal Wall 2			6 in 12		
Mansard Roof	Vertical Wall 1			12 in 12	1.5 in 12	132
	Vertical Wall 2			12 in 12	1.5 in 12	132
	Horizontal Wall 1			12 in 12	1.5 in 12	132
	Horizontal Wall 2			12 in 12	1.5 in 12	132

Creating Dormers

To create dormers in an upper floor, create a new floor for your plan and modify this floor with knee walls and windows to form gables. We'll start with a new 40 x 30 foot plan to learn this technique.



As with automatic dormers, roof pitches of 9 in 12 or greater generally work better than shallow pitches when creating dormers because they provide enough vertical space to build the dormer within.

To create a new plan

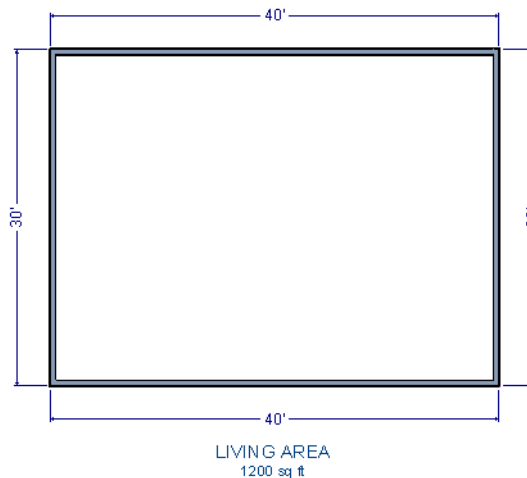
1. Select **File> Close All** from the menu to close any open plans.
2. Select **File> New Plan**  to open a new plan. In the **Create New Plan** dialog, select the Default Style template.
3. Select **File> Save**  from the menu, save the file to an easy to find location, such as Documents, and give the plan a short, descriptive name like Dormer Tutorial.
4. Select **Build> Wall> Straight Exterior Wall**  and draw a rectangular floor plan, 40 feet by 30 feet, in a clockwise direction.
5. Click the **Fill Window Building Only**  button to zoom in on the house.



6. As in the Gable Roofs example, specify the left and right vertical walls as **Full Gable Walls**. See "To set a wall's roof directives" on page 59.



7. Select **Build> Floor> Build New Floor** .
8. Choose the **Derive new 2nd floor plan from 1st floor plan** option in the **New Floor** dialog and click **OK**. In the Floor 2 Defaults dialog, which opens next, click **OK** without making any changes.
9. Select **Build> Roof> Build Roof**  to open the **Build Roof** dialog. On the Roof panel, change the **Pitch** to 12 in 12, and click **OK**.

To create two knee walls

A knee wall is a short wall on an upper floor that is cut off by a roof plane rather than building up to full ceiling height. They are often used to separate loft areas from attic space.

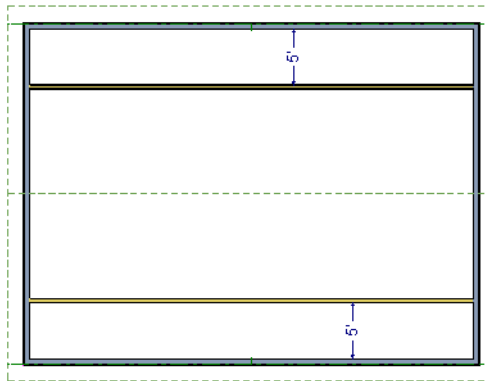
1. Select **Build> Wall> Straight Interior Wall**  and draw a horizontal interior wall from left to right. Position this knee wall so that it is 5 feet from the top exterior wall.
2. Draw another horizontal interior wall and position it 5 feet from the bottom exterior wall. You can reposition the knee walls using dimensions. For more information, see “Moving Objects Using Dimensions” on page 356 of the Reference Manual.



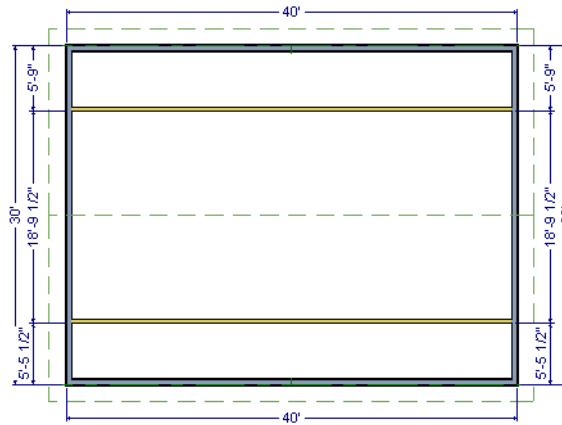

3. Select each of the interior walls one at a time and click the **Open Object**  edit button. Check the box beside **Knee Wall** on the Roof panel of the **Wall Specification** dialog and click **OK**.
4. Select **CAD> Dimensions> Automatic Exterior Dimensions**  to create exterior dimension lines for your plan, which should now look like this:

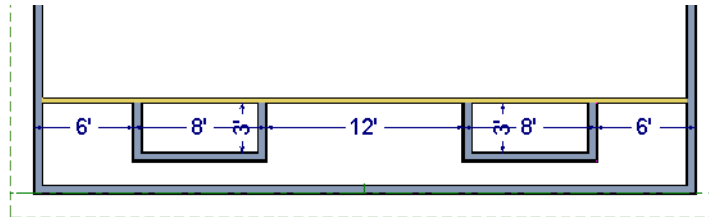

To draw the dormer walls and windows

1. Select **Build> Wall> Straight Exterior Wall**  and draw two rectangular boxes on the outside of the lower knee wall, as shown in the following image.



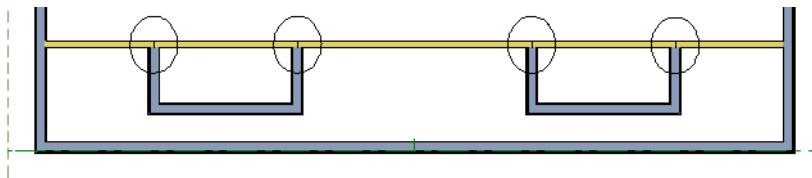

2. Position the front walls of each dormer box 2 feet from the bottom exterior wall. The front dormer walls are those parallel to the bottom wall.
3. Use dimension lines to position the dormer side walls so that the dormers are 6 feet from each vertical exterior wall and 8 feet wide.
4. Select **Build> Wall> Break Wall**  and click along the lower knee wall to place wall breaks where it intersects each of the dormer side walls.



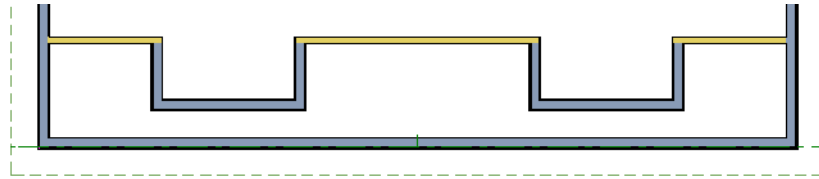

5. Delete the segments of the knee wall located behind the dormers, as in the following image:





6. Select **Build> Window> Window**  and click on each dormer front wall to place a window.
 - When **Object Snaps** are enabled, a "sticky point" will exist at the midpoint of the dormer front wall when you move your mouse along the front wall. For more information, see "Object Snaps" on page 74 of the Reference Manual.
 - You can also use the **Center Object**  edit button to center each window along the wall after it has been placed. See "Using Center Object" on page 99 of the Reference Manual.

To build the roof

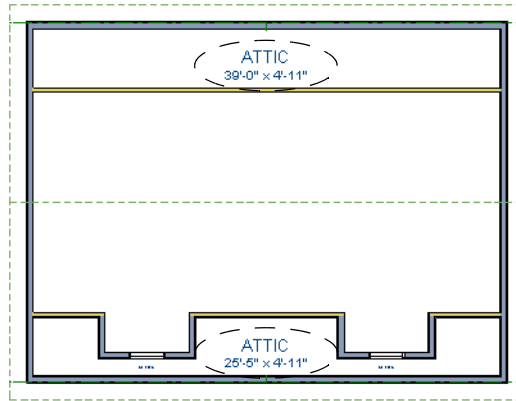
1. Select the two dormer front walls with windows and open their **Wall Specification** dialog. On the Roof panel, check **Full Gable Wall** and click **OK**.
2. Select the four dormer side walls and open their **Wall Specification** dialog. On the Roof panel, confirm that **Pitch** is 12 in 12, and click **OK**.
 - Earlier, a pitch of 12 in 12 was specified in the **Build Roof** dialog: that pitch should have pre-filled here and will work well for these dormers.
1. Click the **Select Objects**  button, then click in the narrow room between the top knee wall and the top exterior wall to select it.
2. Click the **Open Object**  edit button to open the **Room Specification** dialog. On the General panel, select "Attic" as the **Room Type** and click **OK**.
3. Do the same for the lower attic room.



4. Select **Build> Roof> Build Roof**  from the menu.
5. In the **Build Roof** dialog and click **OK**.
6. Select **3D> Create View> Camera** , then click and drag a camera arrow outside of the house and pointed towards it to see the results.



7. Notice that there are small gaps in the dormer side walls. This gap is caused by the difference between the position of the knee walls and the point at which the ceiling intersects the roof plane. This location is marked by the black dotted Ceiling Break Line in floor plan view.

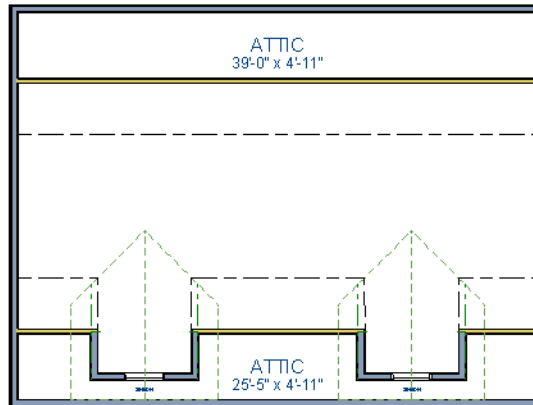

8. Select each of the knee walls and move them back so that they are in alignment with the ceiling plane. When **Object Snaps** are enabled, the walls will snap into position when they are close to the Ceiling Break Lines.

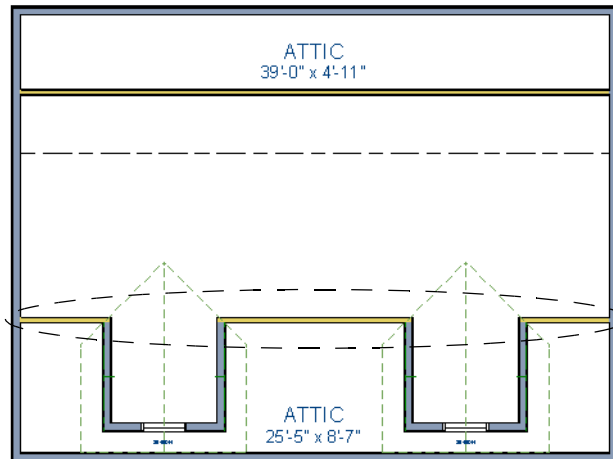



9. Take a look in a 3D view.



You can move the interior walls closer to or further from the outside walls to change the dormers' elevation, or change the pitch for the roof to make the dormers longer. You can create dormers in more complex plans the same way, but you may want to experiment with wall placement and pitch to achieve the desired effect.

Skylights

Skylights can easily be added using the **Skylight**  tool. In floor plan view, select **Build> Roof> Skylight**  then click and drag a rectangular shape within an existing roof plane. When you release the mouse button, a skylight is created and can be repositioned and resized using its edit handles. For more information, see “Skylights” on page 213 of the Reference Manual.

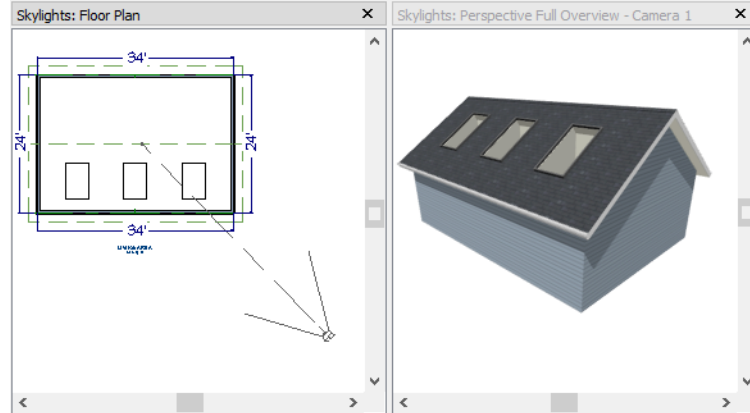

Using the Break Wall Tool to Modify Roofs

Many homes have more than one roof type built above a single exterior wall. One common example is a reverse gable roof, created when a house has gable walls that are perpendicular to one another, as in an L-shaped home.

We can create a reverse gable roof on an L-shaped home using the **Break Wall**  tool.

To create an L-shaped home

1. Select **File> Close All** from the menu.
2. Select **File> New Plan**  to open a new plan. In the **Create New Plan** dialog, select the Default Style template.
3. Draw an L-shaped house with the following dimensions:
 - Left wall - 30 feet long
 - Upper wall - 45 feet long.
 - Right wall 18 feet long.
 - Lower wall extending left from the right wall - 25 feet long.
 - Vertical wall connecting two lower walls - 12 feet long.
 - Lower wall extending right from the left wall - 20 feet long.
4. If desired, turn off **Auto Rebuild Roof** and delete the roof.

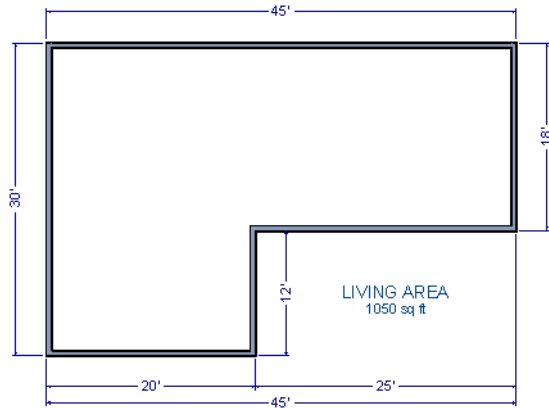

To create a reverse gable in this plan, we need to create three gable walls: two running vertically and one horizontally.

To add a gable roof to the plan

1. Check **Full Gable Wall** on the Roof panel of the **Wall Specification** dialog for these three walls:
 - The far left vertical wall
 - The far right vertical wall
 - The bottom left horizontal wall
2. Click the **Build Roof** button to open the **Build Roof** dialog and click **OK** to build the roof. The roof will look like this:

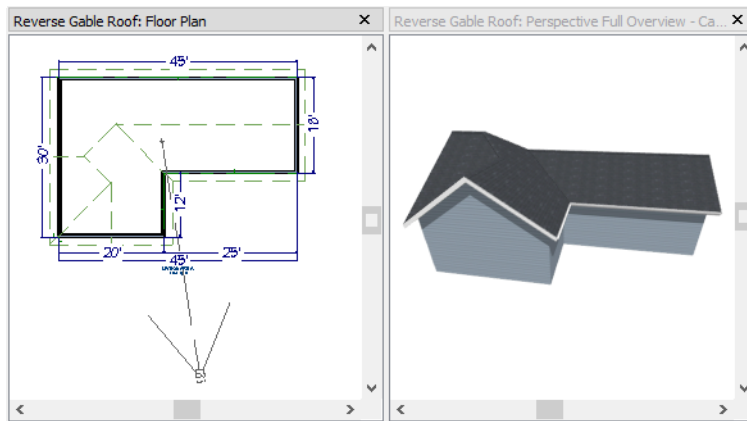

The gable wall on the left produces roof planes that extend too high and interfere with the roof over the front extension of the house. To avoid this, use the Break Wall tool to divide the left wall into two different sections. The upper section can then be specified as a Full Gable without affecting the lower section.

To use the Break Wall tool

1. Select **Build> Wall> Break Wall**  and click the far left wall at a point even with the lower right wall.
 - An easy way to do this is to temporarily stretch the lower right wall across to the left wall;
 - Place a wall break where the walls meet;
 - Then return the lower right wall to its correct position.

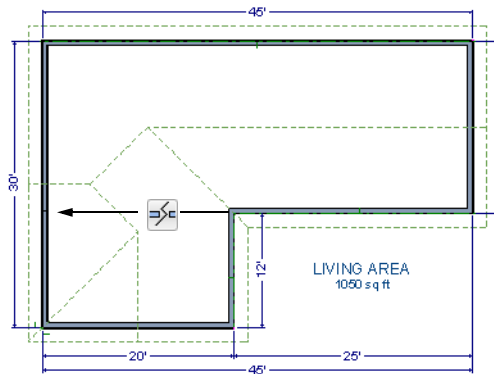

2. Open the lower portion of the wall for specification and on the Roof panel of the **Wall Specification** dialog, clear the **Full Gable Wall** checkbox and click **OK**.
3. Click the **Build Roof**  button and click **OK** to build a roof based on the new wall specifications.

You now have two full gable roof sections meeting to form your L-shaped roof. Your plan should look like the following image:

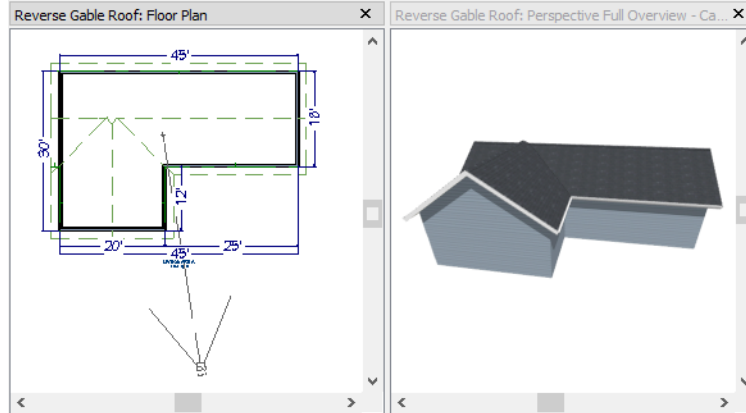

Notice the step in the ridge line. This can be corrected by resizing the lower gable wall. Select the vertical wall to the right of the bottom gable wall and move it to the left 2 feet, reducing the length of the gable wall from 20 to 18 feet. When you are finished, rebuild the roof.

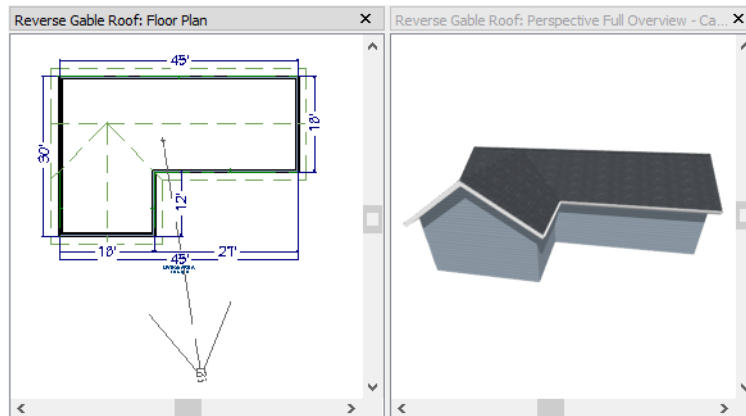

This completes this Roof Tutorial. You can use any combination of the techniques described here to create a wide variety of roof designs.

Adding a Roof to the Stucco Beach House

Now that we have a basic understanding of the automatically roof tools, let's return to our previously saved Stucco Beach House plan, as it looks like our house could use a roof now.





Select **File> Save As**  and give this plan a new name, such as "Beach House Roof Tutorial" before continuing.

Individual walls can be selected and edited in both 2D and 3D views; however, when multiple walls must be edited, it is usually quicker and easier to work in floor plan view. See “Editing Walls” on page 116 of the Reference Manual.

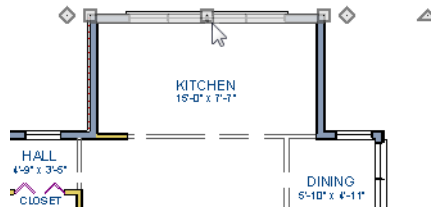
To edit the default roof

1. Close any 3D views that you may have open and work in floor plan view.
2. Starting on Floor 1, use the **Select Objects**  tool to select the top horizontal exterior Kitchen wall:



3. Click the **Open Object**  edit button and specify this wall as a **Full Gable Wall**. See “Gable Roofs” on page 61.
4. Click **Up One Floor**  to go to the second floor.
5. Using the **Select Objects**  tool, select the Balcony room, then click the **Open Object**  edit button. On the Structure panel of the **Room Specification** dialog, uncheck **Roof Over This Room**, then click **OK**.

- Assign the **Full Gable Wall** and **Extend Slope Downward** settings to the exterior walls, as shown in the following image. See “To set a wall’s roof directives” on page 59.

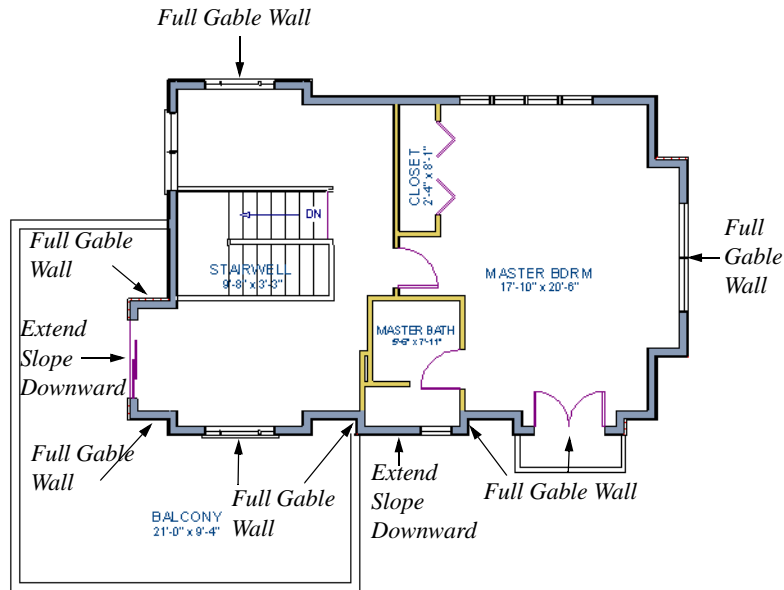

- Once these roof directives have been assigned, the roof can be generated.

To turn on automatic roof generation

- Select **Build> Roof> Build Roof**  to open the **Build Roof** dialog.
- On the Roof panel, check **Auto Rebuild Roofs**. See “Build Roof Dialog” on page 211 of the Reference Manual for more information.
- Set the **Pitch** to 3 in 12.
- You can go to the **Materials** panel to change the material of your roof. Here, an Earth Roof Tile material.
- Click **OK** to close the dialog and generate a roof.

The additional walls that are created are attic walls. See “Attic Walls” on page 59.

- Select **3D> Create View> Full Camera**  to create an exterior view of your plan.

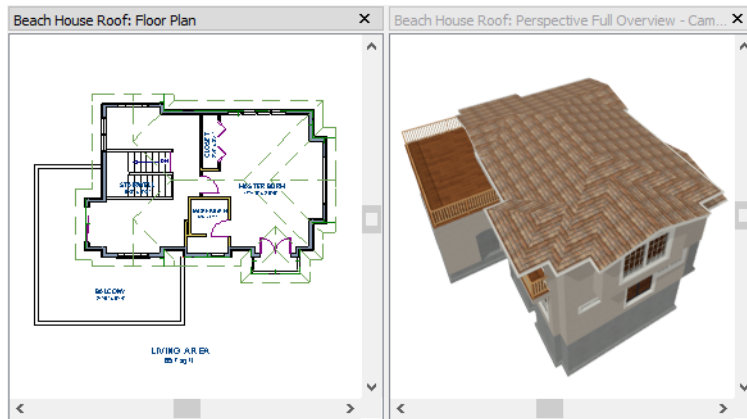

Troubleshooting Roof Issues

Creating a roof can require experimentation and practice. Here are some suggestions for troubleshooting a problematic roof design.

Roof Directives in Walls

As discussed in this chapter and in the Roofs chapter, the program will automatically generate a roof plane bearing over each exterior wall in a plan to produce a hip roof. If you require a different condition over a particular wall, such as a triangular gable or side wall of a shed roof, you can specify that condition on the Roof panel of the **Wall Specification** dialog. See “Roof Panel” on page 124 of the Reference Manual.

Specifying roof directives that do not reflect what you require directly above a selected wall, however, can often result in drastic and unwanted changes to your roof. For example, when two parallel walls are specified as Full Gable Walls, a single ridge will be created between them.

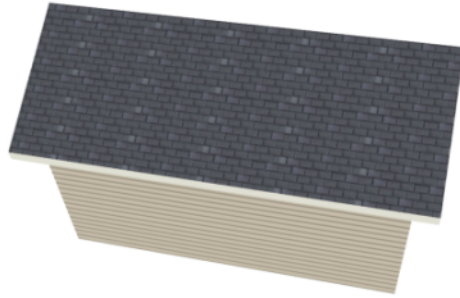
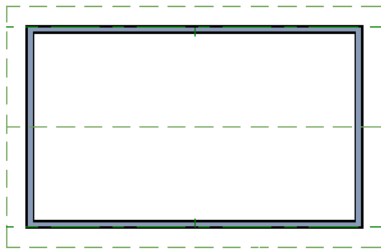

If a wall that is perpendicular to these walls is also specified as a Full Gable Wall, the roof becomes more complex with an additional ridge, two valleys, and two hips.

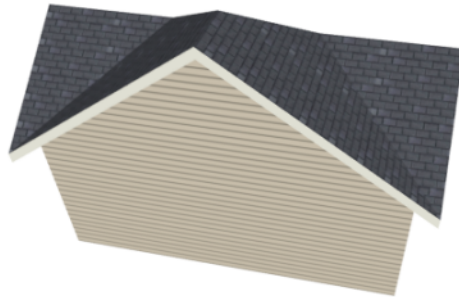
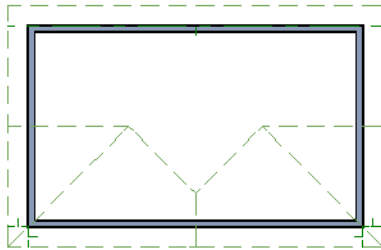

If you are seeing hips or valleys in your roof where you do not expect them, revisit the Roof panel of the walls supporting the affected roof planes.

Roof Heights

The heights of all roof planes are based on the heights of the walls that they bear on. Wall heights, in turn, are determined by the ceiling heights of the rooms that they define. See "Floor and Ceiling Heights" on page 141 of the Reference Manual.

For example, the hip roof over a simple rectangular structure with a consistent ceiling heights (in this case, 109 1/8") has four roof planes.

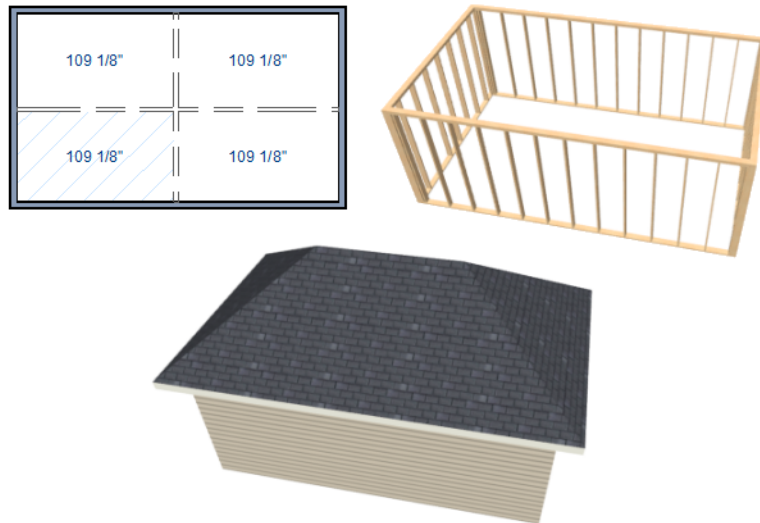

This roof will become considerably more complex if one room inside is given a lowered ceiling height (in this case, 97 1/8").

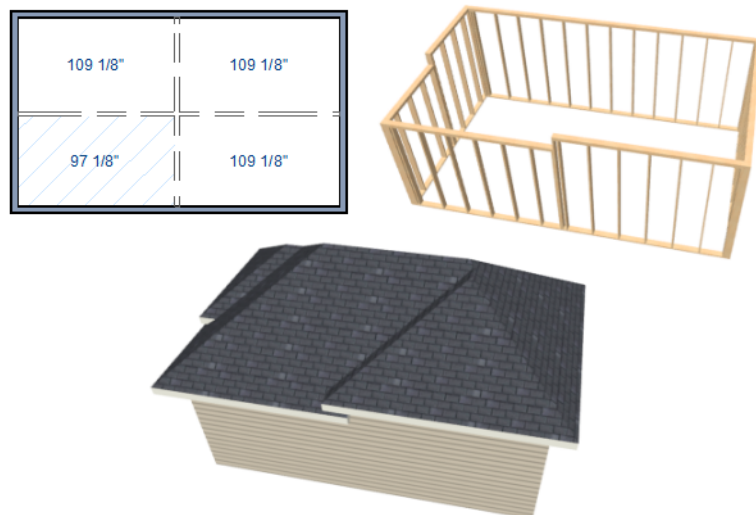

If you generate a roof and it seems to be more complicated and has more roof planes than it should, take a look at the ceiling heights of the rooms in the plan. Often, the correct way to

create a lowered ceiling condition will be to set the ceiling at the default height create a lowered Ceiling Finish. See “Lowered Ceilings” on page 142 of the Reference Manual.

Controlling Roof Ridges

A single roof ridge will generate for as long as the bearing walls that support the roofs on either side of the ridge are the same distance apart. When alcoves or bumpouts are introduced along either bearing wall, the ridge is likely to become broken.

For example, a simple rectangular structure with Full Gable Walls at each end generates a roof with a ridge that runs from Full Gable Wall to Full Gable Wall.

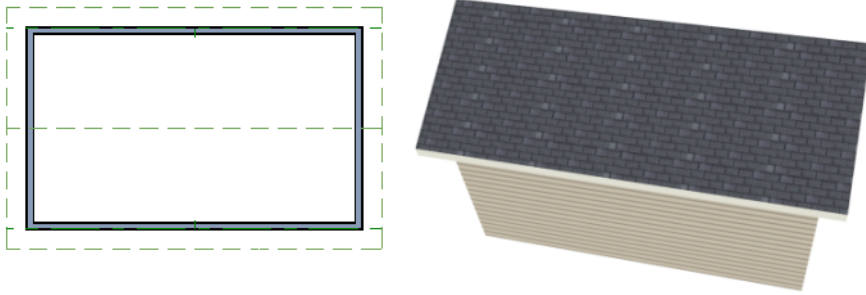

If a bumpout is added that affects the length of either Full Gable Wall, or if an alcove is added anywhere along the length of the structure, the ridge will no longer follow a straight line.

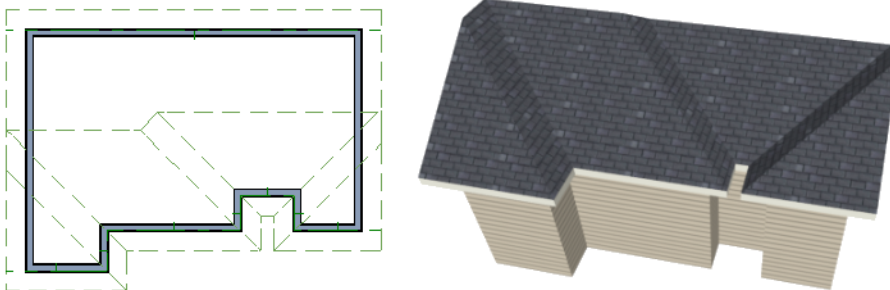

There are a number of ways to maintain a single ridgeline in the presence of alcoves or bumpouts:

- Use the **Break Wall**  tool to control the length of a Full Gable Wall section. See “Using the Break Wall Tool to Modify Roofs” on page 77.

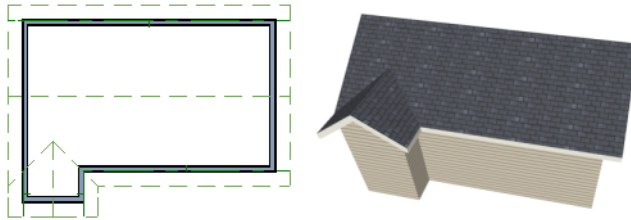

- Increase the **Minimum Alcove Size** to specify what size alcoves are roofed. See “Roof Panel” on page 212 of the Reference Manual.

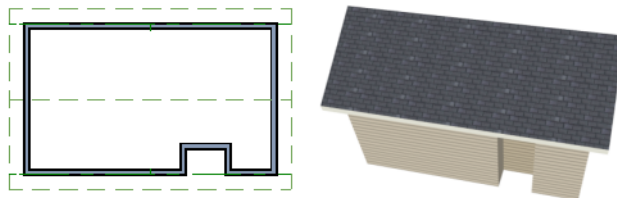

- Use the **Extend Slope Downward** roof directive to allow the roof over a bumpout to extend lower than the ceiling height in that area. See “Roof Directives in Walls” on page 120 of the Reference Manual.

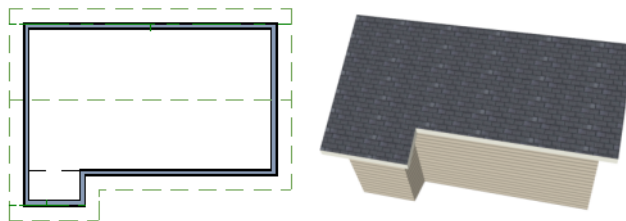

- Specify the area inside of an alcove as an "Open Below" room with a roof but no ceiling, and **Use Soffit Surface for Ceiling** specified. See “Room Types” on page 137 and “Structure Panel” on page 146.

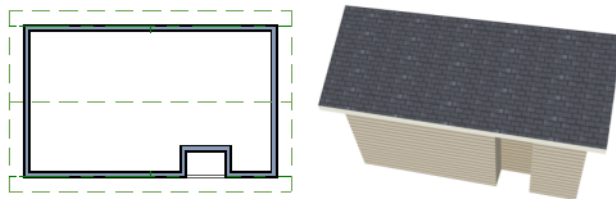

Interior Design Tutorial



The Interior Design Tutorial picks up where the House Design Tutorial left off. The basic structure of the plan is complete, but the plan still needs lights, outlets, and fixtures to be a functional home. In addition, the interior could use some creature comforts such as furniture, wall coverings and moldings. You may want to save this tutorial using a new name to archive your previous work. In this tutorial, you will learn about:

- Controlling the Display of Objects
- Working with Library Objects
- Applying Room Moldings
- Applying Wall Coverings

Controlling the Display of Objects

Every object that you create in Home Designer Interiors exists on a layer that lets you control whether it displays in the current view as well as some aspects of its appearance. For example, the roof that was created in the House Design Tutorial will only be in the way in this tutorial, which discusses the plan's interior. To avoid this, the "Roof Planes" layer can be turned off in floor plan view. For more information, see "Layers" on page 69 of the Reference Manual.

To control the display of objects

1. First, select **File> Save As**  and give this version of the plan a new name, such as "BeachHouse - Interior Tutorial"
2. Select **Tools> Display Settings> Display Options**  or press the ~ key to open the **Display Options** dialog.
3. Press the letter R, find the "Roof Planes" layer and remove the check from the Display column. Turn off the display of "Windows, Labels" and "Doors, Labels", as well. Click OK.

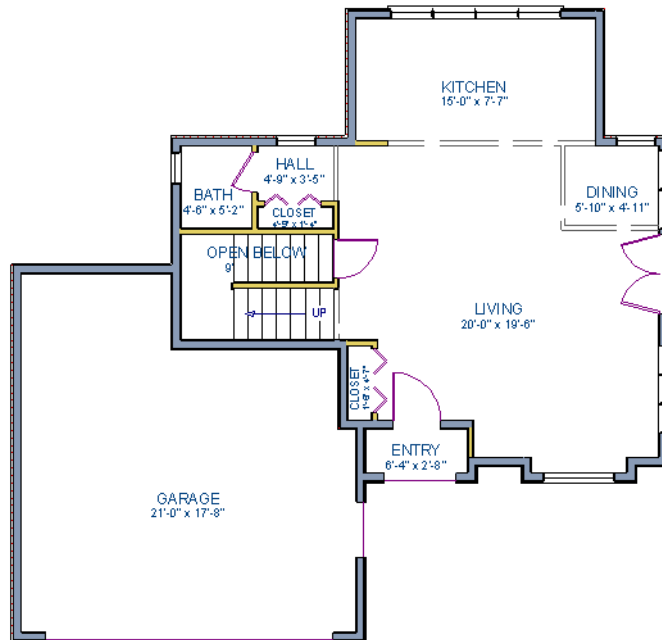



Floor 1 with the display of door and window labels and roof planes turned off

Working with Library Objects

Home Designer Interiors comes with a library that contains thousands of library objects that can be used in a plan. For more information about the library and library objects, see “The Library” on page 281 of the Reference Manual.

To use the Library Search to locate a symbol and place it in the plan

1. Move up to Floor 2 using the **Floor Up**  tool.
2. Select **View > Library Browser**  or press Ctrl + L on your keyboard to open the Library Browser.
3. In the text field, type "bed" and notice that search results will display below as you type. All items with "bed" in any part of their search attributes are included, so in this example, the search results include a variety of items besides furniture.
4. To narrow the search results, click the **Search Filtering Options**  button, then check the box beside **Entire Word**. Now only items with the word "bed" in their attributes are included in the search results.
5. Click on a bed in the search results list to select it for placement.

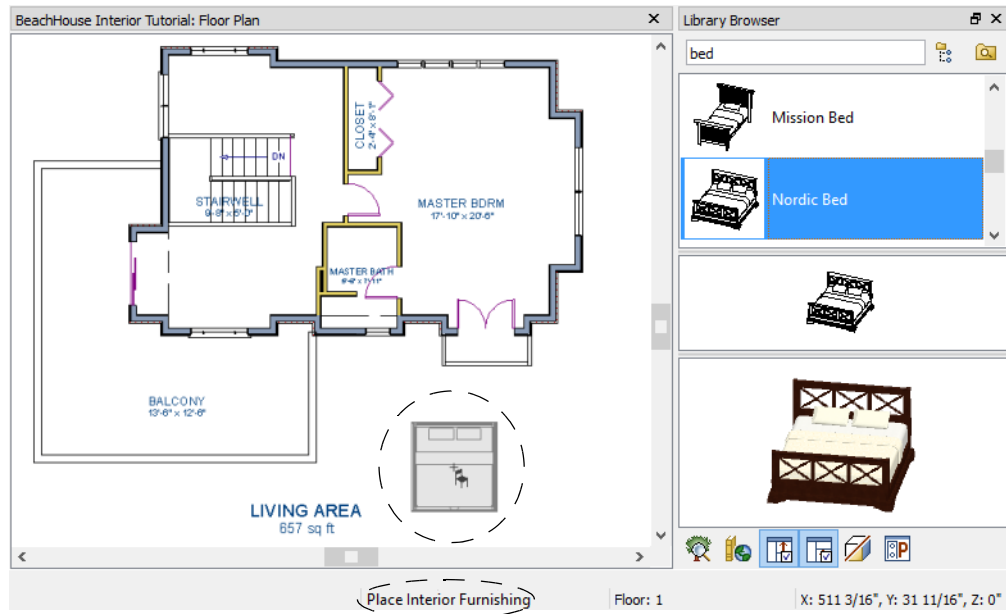

When a library object is selected for placement the mouse pointer icon indicates the type of library object selected, a preview outline of the object follows your pointer as you move it, and basic information displays in the Status Bar at the bottom of the program window.

6. Click in the master bedroom to place the bed.
7. To see where the selected item is located in the Library Browser, right-click on it and select **Show in Browser** from the contextual menu.

8. To switch from a list of search results to the Library Browser tree view, click the **Browse**  button to the right of the text field.

A library object can be selected and edited using the mouse. It also has a specification dialog that offers additional editing options. See “Symbol Object Specification Dialogs” on page 299 of the Reference Manual.

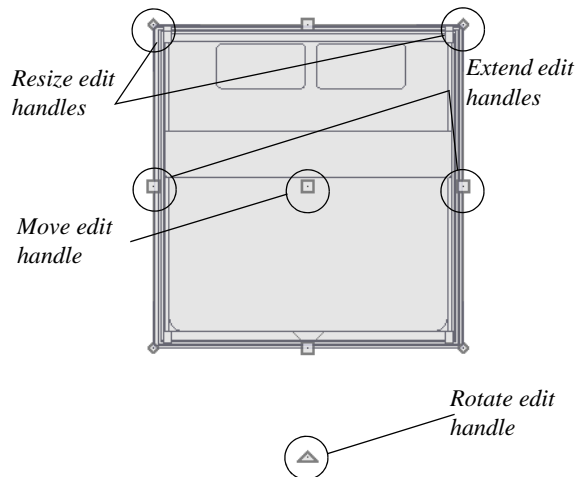

To modify a symbol from the library

1. Click the **Select Objects**  button or press the Spacebar and click on the bed to select it. When selected, the bed displays edit handles. For more information, see “Editing Box-Based Objects” on page 93 of the Reference Manual.

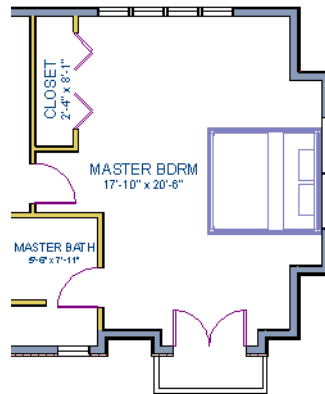

2. Use the Rotate edit handle to rotate the bed.
3. Use the Move edit handle to move the bed up against the right wall.



4. You can modify the materials for the bed by using the **Select Objects**  button tool to select the bed, and clicking the **Open Object**  edit button to open the **Furniture Specification** dialog.
5. On the Materials panel, select the component of the object that you want to apply a new material to: for example, the Bedspread.
6. Click the **Library Material** button to open the **Select Library Object** dialog, where you can search or browse the Library to find and apply a new material to the bedspread portion of the bed. Here, a light brown fabric is used.
7. Repeat this process for any of the other materials on the bed you may want to adjust, then click **OK** to apply the changes which will be visible when you create a camera view.

 You can also apply materials to objects in 3D views using the Material Painter tool. To learn more, see Using the Material Painter in the Materials Tutorial.

Using the tools and techniques learned so far, place fixtures in the bathrooms on Floors 1 and 2.

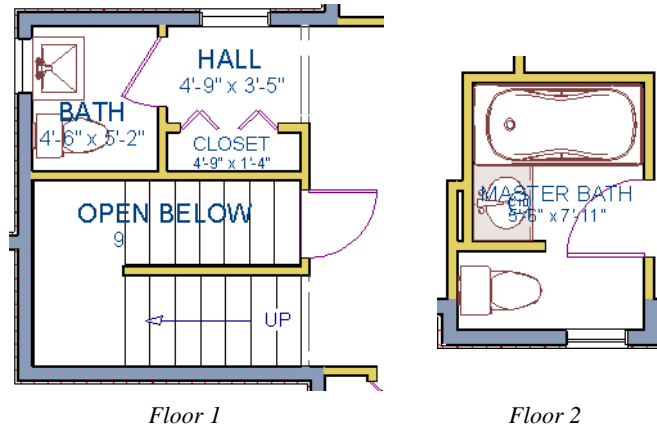



 If existing walls and/or other objects do not allow enough room for a library object to be placed, place the library object where there is enough room and move the object into place while holding down the **Ctrl** key on the keyboard.

Applying Room Moldings

In Home Designer Interiors, you can specify base, crown and chair rail moldings for any room. The library contains a selection of molding profiles. For more information, see “Trim” on page 247 of the Reference Manual.

To add crown molding to a room

Moldings can be added in floor plan or any camera view. So that you can see the results more quickly, begin by creating a camera view of the master bedroom. See “To create a camera view” on page 38 for information about using the **Camera**  tool.

1. Click the **Select Objects**  button or press the Spacebar, then click in a blank space on the floor of the room to select it.
2. Click the **Open Object**  edit button to open the **Room Specification** dialog for the master bedroom.
3. On the Moldings panel:

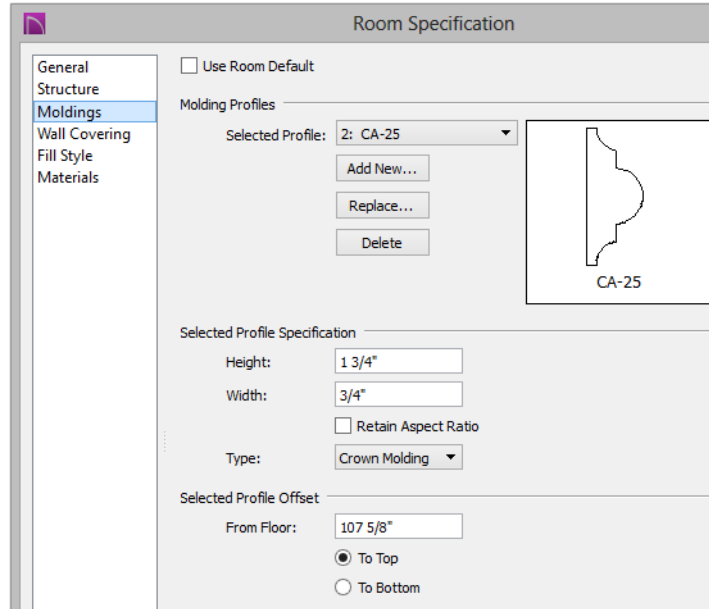

- Uncheck **Default**, and then click the **Add New** button.
- In the **Select Library Object** dialog, either search or browse to find a chair rail profile that you like. When you find one, select it and click **OK**. For more information, see “Select Library Object Dialog” on page 296 of the Reference Manual.
- If you wish, you can specify the **Height** and **Width** of the selected molding. In this tutorial, a **Height** of 2 inches is specified.
- Select "Chair Rail" from the **Type** drop-down list.
- Notice that the **From Floor** value equals the room’s Finished Ceiling Height on the Structure panel. Set this value to 32" inches.
- Click **OK** to close the **Room Specification** dialog.

Crown moldings can be applied to a room in the same manner. Base moldings are already applied in most room types by default, but can be edited, removed or added here, as well.



When you have finished, remember to **Save**  your work.

Applying Wall Coverings

Wall coverings can be used in addition to a wall's surface material to create accents like wallpaper borders or wainscoting. For more information about wall coverings, see "Wall Materials" on page 114 of the Reference Manual.

To apply a wall covering

1. Select the master bedroom and click the **Open Object**  edit button to open the **Room Specification** dialog,
2. On the Wall Covering panel:

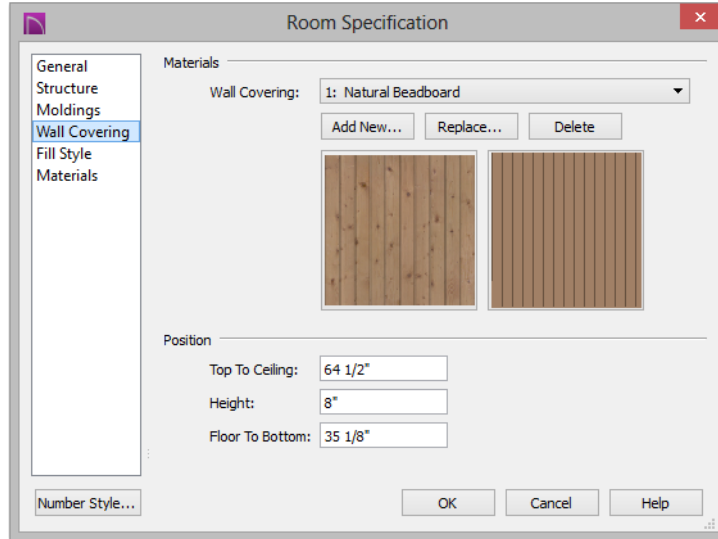

- Click the **Add New** button to open the **Select Library Object** dialog.
- Select an appropriate material for your wall covering, and click **OK**. In this example, a Natural Beadboard material is used.
- Change the **Height** to 28 inches, and change the **Floor to Bottom** value to 3 1/2 inches to allow for the distance between the base and chair rail moldings.
- Click **OK** to close the **Room Specification** dialog.



 Additional wall covering materials can be downloaded into the Manufacturer Catalogs. See "Downloading Library Content" on page 287 of the Reference Manual.

If you would like, you can continue adding interior elements from the Library Browser before continuing to work on this plan in the Kitchen and Bath tutorial.



Kitchen and Bath Design Tutorial

This tutorial continues where the Materials Tutorial left off. You should save this tutorial using a new name to archive your previous work.



The tools and techniques used to design kitchens and bathrooms are very similar. This tutorial focuses on kitchen design. When you're finished you can use what you've learned to finish up the bathrooms as well. In this tutorial you will learn about:

- Adding Cabinets
- Placing Appliances
- Editing Cabinets and Appliances
- Creating a Cabinet Island
- Editing Cabinets and Appliances
- Working in 3D Views

Adding Cabinets



Begin by selecting **File> Save As** , and name the plan BeachHouse - Kitchen Bath Tutorial.

To place a base cabinet

1. **Zoom**  in on the Kitchen area in floor plan view.
2. Select **Build> Cabinet> Base Cabinet** .
3. Click to place a base cabinet anywhere in the kitchen.

Once a cabinet is placed, it can be edited like other objects.

To select and edit a cabinet

1. Cabinets can be selected using one of the following methods.
 - Click on the cabinet while the **Select Objects**  tool is active.
 - Click on the cabinet while any of the **Cabinet Tools**  are active.
 - Right-click on the cabinet when another tool is active.
2. When the cabinet is selected, edit handles, a front indicator, and a temporary dimension display. As with other objects, the arrow that displays when the pointer is held over an edit handle indicates what edit function that edit handle will perform. See “Editing Box-Based Objects” on page 93 of the Reference Manual.

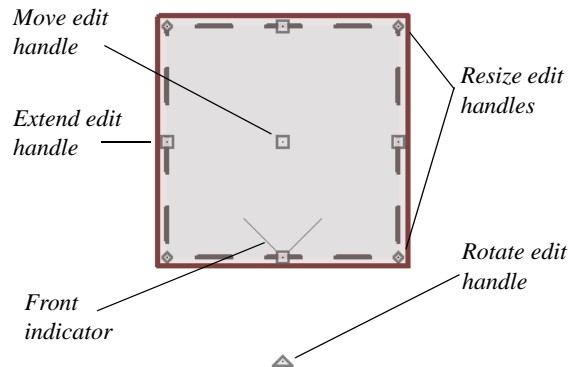

- Move a cabinet using the Move edit handle. By default, you can move a cabinet parallel to its sides or its front and back edges. To allow unrestricted movement, hold down the Ctrl key or click and drag using the right mouse button.
 - Resize two sides of a cabinet using a Resize edit handle, located in each corner.
 - Extend a cabinet's edge on one side using an Extend edit handle.
 - Rotate a cabinet using the Rotate edit handle, which is always offset to one side.
 - A temporary dimension updates as the cabinet is moved or resized.
3. When a cabinet is selected, you can also click the **Open Object**  edit button to open its specification dialog and make a wide variety of changes to the cabinet. For more information, see “Cabinet Specification Dialog” on page 263 of the Reference Manual.

To lay out base cabinets for this tutorial

1. Place and position six base cabinets and edit their widths as shown in the following image:

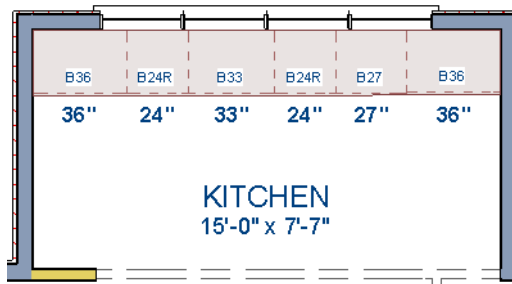



- Two of the cabinets are 36", two are 24" wide, one is 33" and one is 27" wide.
- A cabinet snaps to another if they are in alignment, facing the same direction, and of the same type.

Note: The display of cabinet module lines has been turned on in the following images. See "Displaying Cabinets" on page 258 of the Reference Manual for more information.

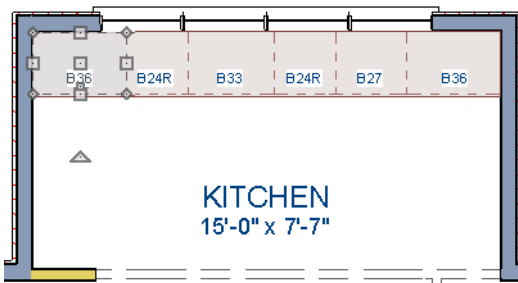

To create corner cabinets

1. Select the 36" wide base cabinet on the left.

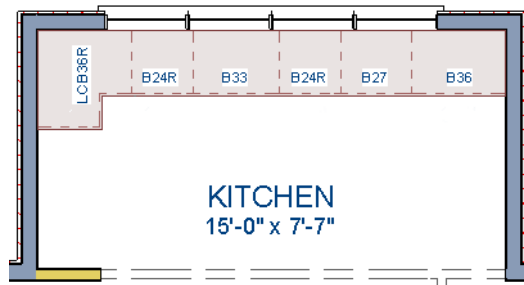

2. Click the **Open Object**  edit button to open the **Base Cabinet Specification** dialog. On the General panel:
 - Specify a **Width** greater than the Depth. The selected cabinet's width should already have been changed to 36", which works well with a 24" depth. If it isn't, change it to 36" now.
 - Click the **Special** drop-down list and select "Corner".
 - On the Front panel, uncheck the box beside **Diagonal Door**.
 - Click **OK** to change the cabinet into a corner cabinet.



3. With the cabinet still selected, use its Rotate edit handle to rotate it so its back faces the wall corner if necessary.
4. A different approach can be used to create a corner cabinet in the right corner. Begin by selecting the cabinet on the right and pressing the **Delete** key or clicking the **Delete**  edit button.
5. Select **Build> Cabinet> Base Cabinet** , then move your mouse pointer into the corner. When the cabinet preview changes to a corner cabinet, click once.
6. Uncheck **Diagonal Door** for this new cabinet as described in step #2, above.

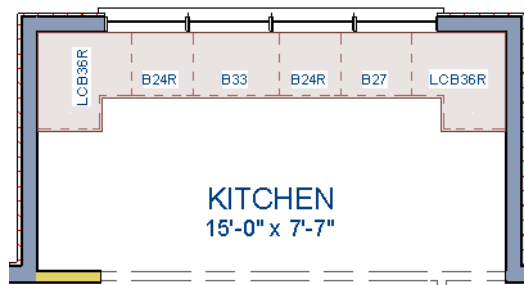



 To move a row of cabinets, select one cabinet, then click and drag the Move edit handle towards the other cabinets. The selected cabinet will push the others. See "Bumping/Pushing" on page 97 of the Reference Manual.

To place wall cabinets

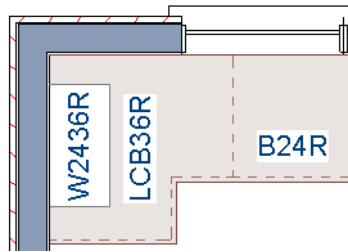
1. Select **Build> Cabinet> Wall Cabinet** .
2. Click above the left corner base cabinet to place a wall cabinet as shown.



3. Click the **Open Object**  edit button to open the **Wall Cabinet Specification** dialog:
 - On the General panel, specify a **Width** of 33".
 - On the Door/Drawer panel, change the **Door Style** to "Framed", and check the box beside **Glass Doors**.
 - On the Moldings panel, click the **Add New** button to add crown molding to the cabinet.
 In this example, a crown molding profile with a **Height** of 2 1/2", a **Width** of 2 1/2", and a Vertical **Offset** of - 2 1/2" is used. For more details, see "To add crown molding to a room" on page 94.
 - Click **OK** to apply these changes to the wall cabinet.
4. With the wall cabinet still selected:
 - Click the **Copy/Paste**  edit button.
 - Click near the opposite wall to place a second wall cabinet identical to the first.
 - With the new cabinet still selected, click the **Center Object**  edit button.
 - Move your mouse pointer over the original wall cabinet so that it becomes highlighted.
 - When you see a dashed horizontal line running through the original wall cabinet, click once. The dashed line is a centering axis, and the new cabinet will become aligned with the original.

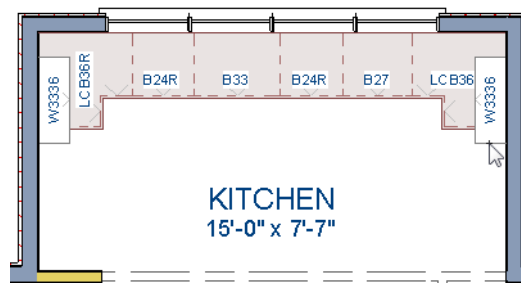



Note: The display of cabinet face indicator lines has been turned on in the following images. See “Displaying Cabinets” on page 258 of the Reference Manual for more information.

With the wall cabinets in place, you may want to add soffits to enclose the space between them and the ceiling.

To place soffits

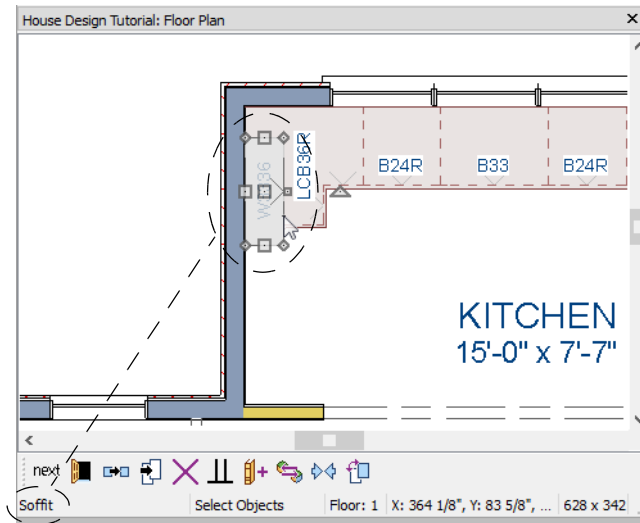
1. Select **Build> Cabinet> Soffit**  then click above the wall cabinets to place soffits.
2. Adjust their width and orientation to match the wall cabinets below.



 When objects are very close to one another or occupy the same vertical space in floor plan view, it may be difficult to select the intended object. You can select an objects, then click the **Select Next Object**  edit button or press the Tab key to select a neighboring object. The Status Bar indicates which object is currently selected.

For more information about cabinets, see “Cabinets” on page 253 of the Reference Manual.

Placing Appliances

Appliances come in two basic varieties, freestanding and built-in. For more information about library objects such as appliances, see “The Library” on page 281 of the Reference Manual.

To place a freestanding appliance

1. Select **View> Library Browser**  to open the Library Browser.
2. In the Core Catalog, browse to Architectural> Appliances> Refrigerators, locate a refrigerator, and select it for placement.
3. On the left side of the kitchen, click in the empty space below the base corner cabinet to place the refrigerator.

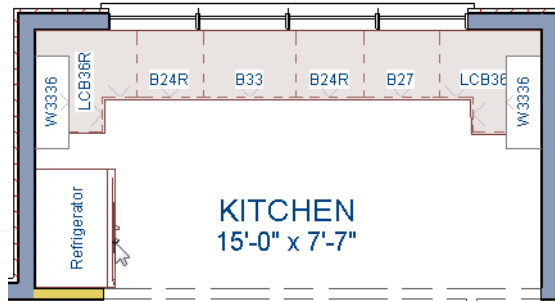

4. In the Appliances catalog, find an electric range and place it in the empty space on the right side of the kitchen.

To place a built-in appliance

1. Select **View> Library Browser**  to open the Library Browser.
2. In the Core Catalog, browse to Architectural> Fixtures> Sinks, locate a sink, and select it for placement. In this example, the Self Rimming Offset 32" sink is used.
3. Click on the base cabinet near the top of the screen that is 33" wide to insert the sink into that cabinet.
4. In Core Catalog> Architectural> Appliances> Dishwashers, select a dishwasher for placement, and click on the cabinet to the right of the sink.

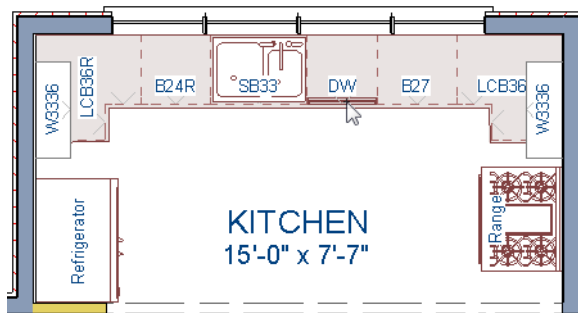

Editing Cabinets and Appliances

Like most objects, cabinets and appliances can also be edited in their own specification dialogs. This method allows a higher degree of customization than using just the edit handles.

To edit cabinets in the Cabinet Specification dialog

1. Select the cabinet to the left of the sink and click the **Open Object**  edit button to open the **Base Cabinet Specification** dialog.
2. Click on the drawer in the preview image on the right side of the dialog. Notice that clicking anywhere on the preview takes you to the Front panel.
3. Click the **Add New** button to open the **New Cabinet Face Item** dialog.

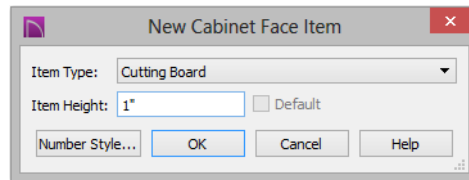

4. Click the **Item Type** drop-down list and select Cutting Board, assign an **Item Height** of 1 inch, and click **OK** to return to the **Cabinet Specification** dialog.
5. A new Cutting Board face item, as well as a new Separation, will be added below the drawer that you selected.
6. Click on the Cutting Board in the preview, then click the **Move Up** button three times to move the cutting board above the drawer.
7. Select the Separation and click the **Move Up** button three times, as well.
8. Click OK to close the **Base Cabinet Specification** dialog.

These steps can be used to create a wide variety of cabinet front configurations, such as a bank of drawers.

To edit appliances in the Fixture Specification dialog

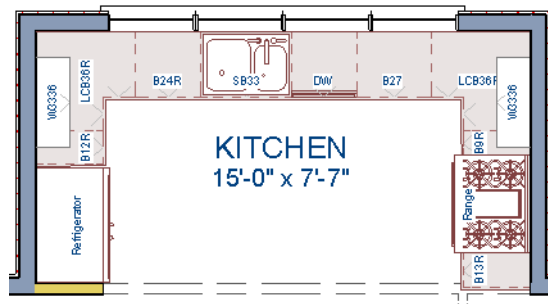

1. Select the refrigerator and click the **Open Object**  edit button to open the **Fixture Specification** dialog.
2. On the General panel, change the **Depth** to 28 and click **OK**.

Finally, add some narrow base cabinets to fill in the gaps beside the appliances. You can also add a wall cabinet and soffit above the range.



Creating a Cabinet Island

To create a cabinet island

1. Select **Build> Cabinet> Base Cabinet** .
2. Click to place a base cabinet in the kitchen area, and select it.
3. Click the **Open Object**  edit button to open the **Base Cabinet Specification** dialog.
 - On the General panel, specify a **Width** of 33" and a **Depth** of 27".
 - On the Front panel, create three **Double Drawers** with an **Item Height** of 8 1/2".

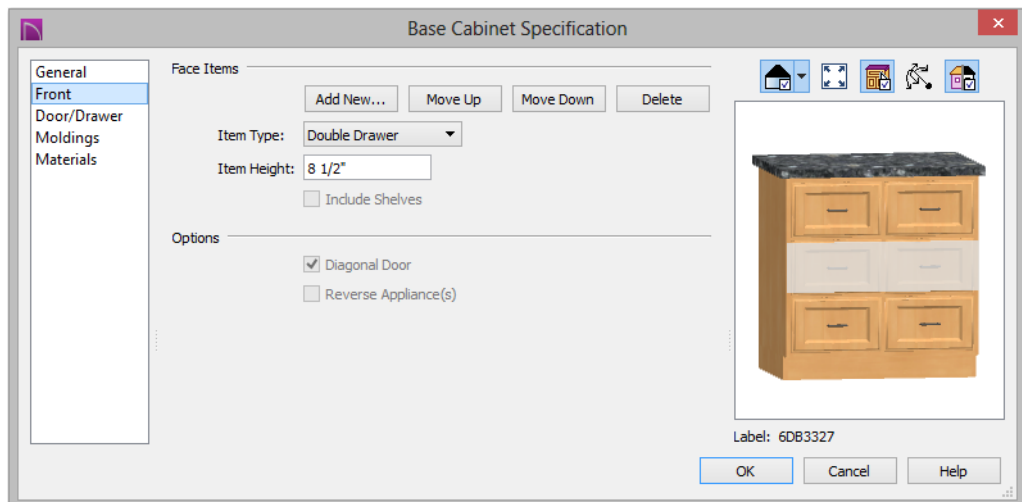

- On the Door/Drawer panel, set the Drawer Handle to **Knob**.
- Click **OK** to close the dialog and apply your changes.

4. With the Base Cabinet still selected, click the **Copy/Paste**  edit button, then
 - Click and drag the Move edit handle downward on screen until the preview outline snaps directly below the existing cabinet.
 - Release the mouse button to create a copy of the original cabinet, as in the image below:

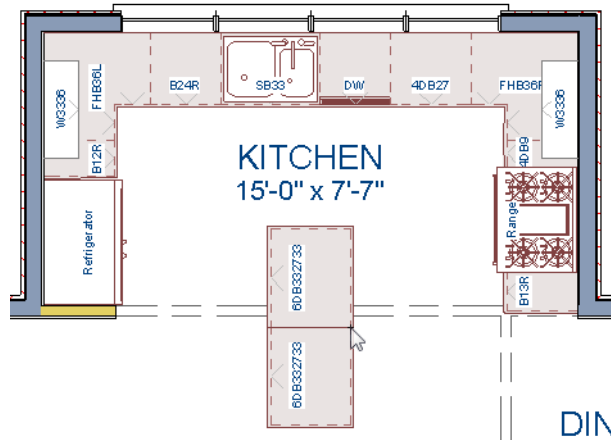

For the next portion of this tutorial, the display of cabinet labels is turned off. To do this, select **Tools > Display Options** . In the **Display Options** dialog, locate the "Cabinets, Labels" layer, remove the checkmark in the **Disp** column, and click **OK**.

Next a countertop for a breakfast bar can be created using a specially edited base cabinet.

To place a cabinet that will become a countertop

1. In floor plan view, place a **Base Cabinets**  and orient it so that its back is to the side of the lower base cabinet, near the dining room.

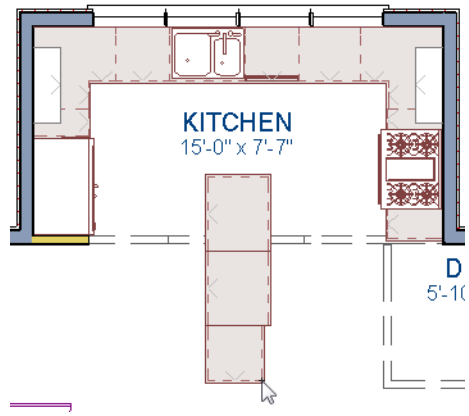

2. Adjust its width so that they align with the cabinets behind them.
3. Adjust its depth to 10 inches.

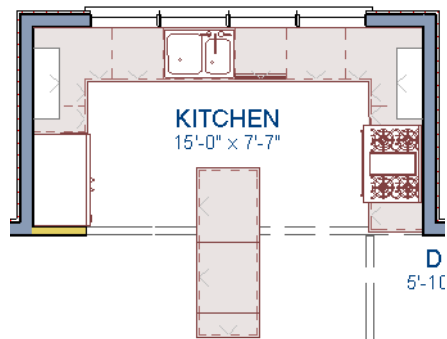

4. Select the 10 inch deep cabinet and click the **Open Object**  edit button.
5. On the Front panel of the **Base Cabinet Specification** dialog, click on the Toe Kick in the preview diagram to select it, then click the **Delete** button.
6. On the General panel of the dialog, select "Peninsula Radius" from the **Special Type** drop down list, then set the **Height (Including Countertop)** as 2" and the **Floor to Bottom** value as 34".

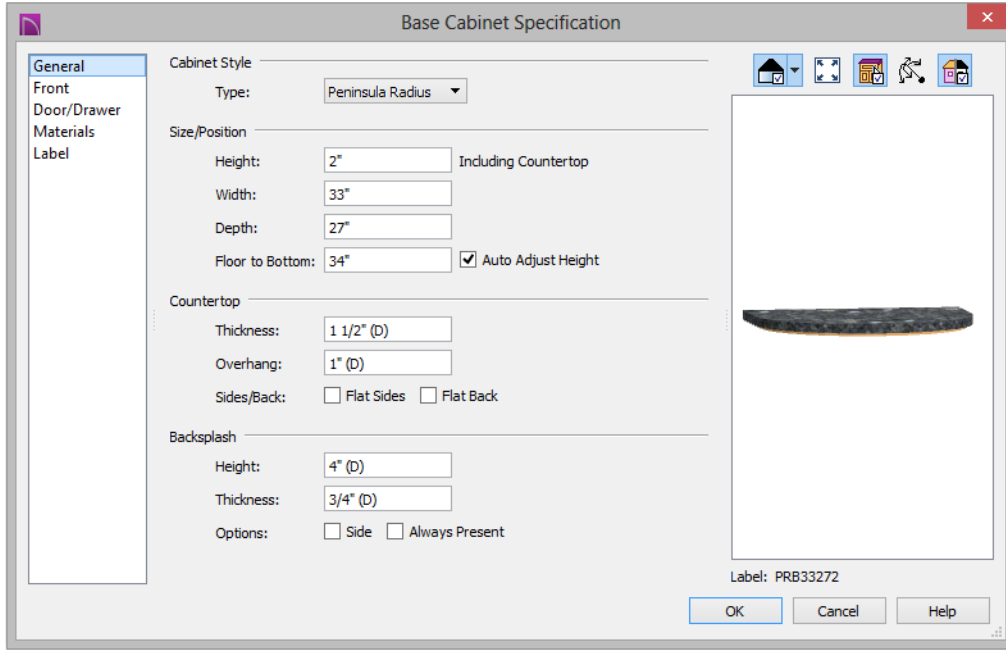

7. Press the Tab key and notice that the preview image on the right side of the dialog updates to show a countertop with a narrow band of cabinet material beneath it, then click OK.
8. Create a **Camera**  view to see the results.



Working in 3D Views

Like other objects, cabinets can be edited in 3D views. This method of editing is very powerful and allows objects to be edited easily in vertical space. Next we'll edit wall cabinets and add a range hood. For more information about working in 3D views, see "Working in 3D" on page 332 of the Reference Manual.

To create a 3D view

1. Select **3D > Create Camera View > Full Camera** , then click and drag a camera arrow towards the group of cabinets that includes the electric range.

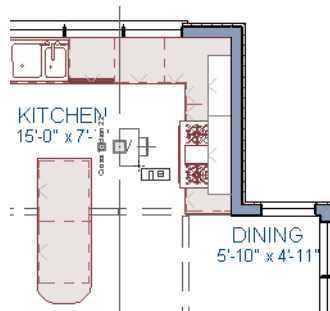

To edit the cabinets in a 3D view

1. Click the **Select Objects**  button, then click on the wall cabinet above the range, which should have double doors and be slightly wider than the base cabinet below it.
2. Click on the cabinet's bottom edit handle and drag it upwards.





3. When the temporary dimension indicates that the cabinet height is 18 inches, release the mouse button.



Finishing Touches

A wide variety of furniture, accessories, and other items is available in the Library Browser at Core Catalogs> Interiors, which you can use to furnish this and other plans.

To view our kitchen using the Cross Section Slider and Final View

1. In floor plan view, click **Fill Window** .
2. Create a **Full Camera**  view that starts from the exterior and release the mouse button in the kitchen. See “To create a camera view” on page 38.
3. Use the **Mouse-Orbit Camera**  tool to adjust the camera's perspective. If you want, you can turn off the display of the backdrop in the **3D Backdrop** dialog. For more information, see “Backdrop Dialog” on page 322 of the Reference Manual.

4. Select **3D> Cross Section Slider**  to open the **Cross Section Slider** dialog.

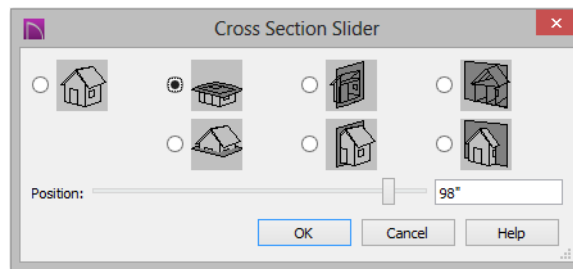

5. Select the flat cut line and use the **Position** slider to specify the location of the cutting plane. See “Cross Section Slider” on page 331 of the Reference Manual.
6. Select **3D> Final View**  to create a higher quality final view.



Materials Tutorial

Materials display on the surfaces of objects in 3D views and can make a 3D view appear highly realistic. When applied to most objects, material quantities will also be calculated in the Materials List.

This tutorial continues from where the Interior Design Tutorial ended. You may want to save this tutorial using a new name to archive your previous work. In this tutorial you will learn about:

- Setting Materials Defaults
- Using the Materials Panel
- Using the Material Painter
- Blending Colors with Materials
- Using the Material Eyedropper
- Custom Materials, Images, and Backdrops
Generating a Materials List

Setting Materials Defaults

Material default settings determine the materials used by different objects when they are initially created. Setting the correct material defaults before beginning a project may help you save time. For more information, see “Preferences and Default Settings” on page 53 of the Reference Manual.

To set material defaults

1. Select **Edit> Default Settings**  to open the **Default Settings** dialog.

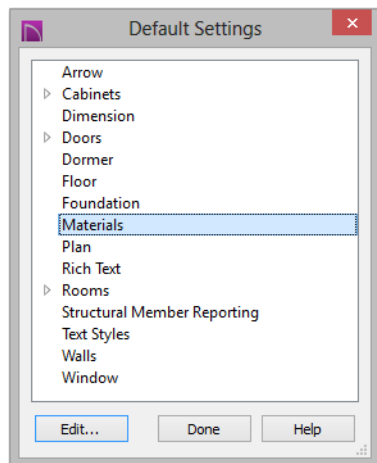

2. There are two options. You can do either or both:
 - Select an item in the tree list and click the **Edit** button to open the defaults dialog for that type of object. The default dialogs for architectural objects such as doors and windows have a Materials panel that allows you to set the material defaults for object components. See “Using the Materials Panel” on page 117.
 - Select **Materials** and click the **Edit** button to open the **Material Defaults** dialog. Here you can set the material defaults for many different objects, including some that do not have default dialogs. See “Material Defaults” on page 309 of the Reference Manual.

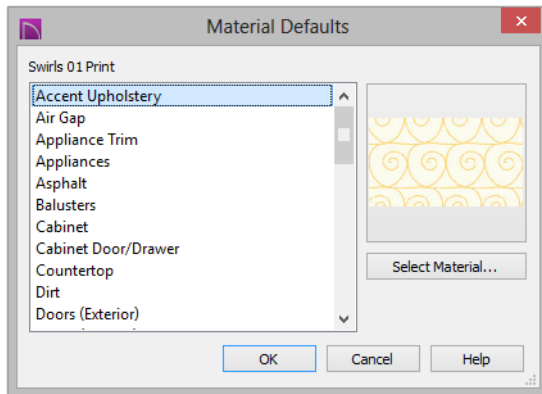



- When you are finished, click **OK** to close the defaults dialog, then click **Done** to close the **Default Settings** dialog.

Once an object has been placed in a plan, the materials applied to it can be changed in a number of ways.

Using the Materials Panel

Most objects' materials can be assigned in their specification dialog in both 2D and 3D views. The materials used by a door, for example, can be edited on the Materials panel of the **Door Specification** dialog. For more information, see "Materials Panel" on page 304 of the Reference Manual.

To change material on an object using the Materials panel

- Click the **Select Objects**  button, then click on the double door leading from the master bedroom to the deck on Floor 2 to select it.
- Click the **Open Object**  edit button to open the **Door Specification** dialog.
- Select one of the door's components from the list on the left.

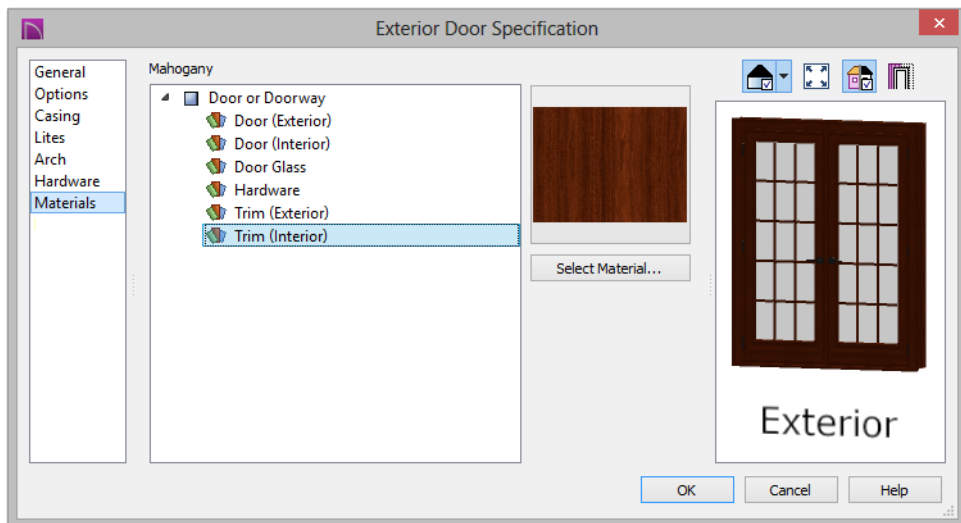

- Click on the name of a material component in the tree list to select it.
 - Click the **Select Material** button to open the **Select Library Object** dialog.
- Find and select a material and click **OK**, to apply it to the selected component.

5. You can continue to specify component materials. The preview in the dialog updates as changes are made. When finished, click **OK** to close the specification dialog.
6. Create a **Camera**  view of the door to see the results.



The materials used in individual rooms can also be specified. Rooms can be selected in both floor plan and 3D views:

- In floor plan view, click in an empty space within a room. When selected, the whole room is highlighted. If you accidentally select an object other than the room, you can press the Tab key on the keyboard until the room is selected.
- In camera views and overviews, click on the floor of the room to select it.

To edit a room using the Materials panel

1. Select the master bedroom and click the **Open Object**  to open the **Room Specification** dialog.
2. In the tree list on the Materials panel, select "Molding" under the Crown Molding component and click the **Select Material** button to open the **Select Library Object** dialog.
3. In the **Select Library Object** dialog, select a material and click **OK** to close the dialog.
4. Click **OK** to close the **Room Specification** dialog.

5. The results can be seen in a **Full Camera**  view.





Using the Material Painter

The **Material Painter**  tool allows you to select a material and then apply it to an object in a 3D view.

There are five Material Painter Modes which specify how broadly or narrowly the selected material will be applied to surfaces in your plan. In this tutorial, the **Component Mode** is used. For more information, see “The Material Painter” on page 302 of the Reference Manual.

To apply a material using the Material Painter

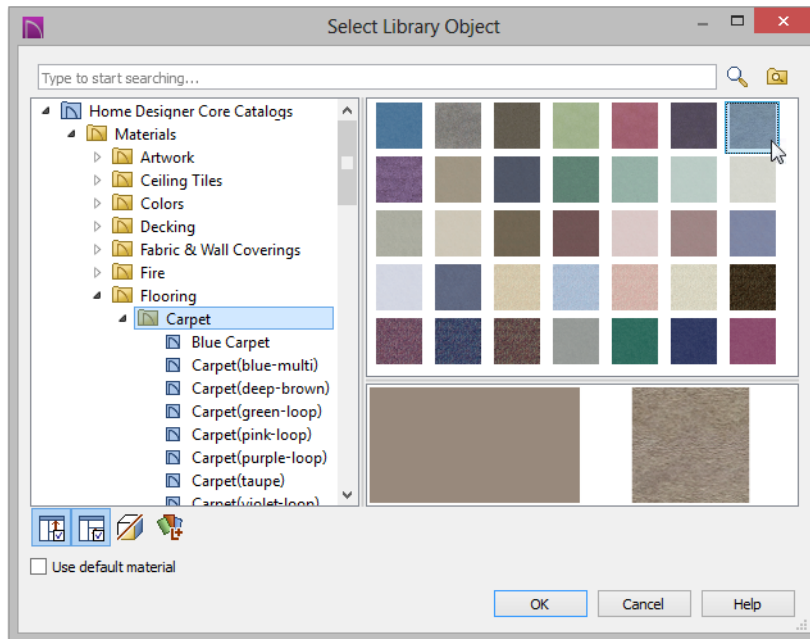

1. While still in the 3D view of the door, select **3D> Material Painter**  and confirm that there is a checkmark next to **Material Painter Component Mode** .
2. Click the **Material Painter**  button to open the **Select Library Object** dialog. Browse to **Flooring> Carpeting**, select a carpet material, and click OK.





3. Move your cursor into the 3D view and notice that it displays a spray can icon  .
4. Click on the floor of the master bedroom to apply the selected material to that surface, which is a component of the room.



 You can also place an area rug symbol from the library in a room and assign to it whatever material you wish. See “Placing Library Objects” on page 294.

With the **Material Painter**  tool you can apply a material to nearly any surface, including many that can't be individually selected like the base molding on a wall or the frame of a window. When either the **Component**  or **Object**  Modes is active, you can continue to apply the selected material to objects until a different tool is selected.



To add artwork to a frame

1. A variety of frames can be found in the Interiors library category. Place a wall or desk frame in your plan and create a camera view in which it can be seen.
2. Select **3D> Material Painter** and confirm that there is a checkmark next to **Material Painter Component Mode** .
3. Click the **Material Painter**  button to open the **Select Library Object** dialog and select a painting, photo or print from the Artwork library.
4. Move your cursor over the middle area of the frame and click to apply the selected artwork.









The artwork displayed in a frame can also be specified in the frame's specification dialog. See “Symbol Object Specification Dialogs” on page 299 of the Reference Manual.

Blending Colors with Materials



Instead of using the **Material Painter**  to replace a material with a new one, you can use it with the **Blend Colors With Materials**  feature to blend a color with a textured material such as the carpet in the master bedroom and create a new material. For more information, see “Blend Colors With Materials” on page 303 of the Reference Manual.



To blend a color with a texture

1. In a 3D view, select **3D> Material Painter> Material Painter** .
2. In the **Select Library Object** dialog, select a solid color for the carpet from the Generic Colors library, then click OK.
3. When you move your cursor into the view, it displays a paint roller icon .
 - When **Blend Colors with Materials**  is active and a solid color is loaded in the Material Painter, your cursor displays the paint roller icon .
 - If you see the spray can icon  instead, select **3D> Material Painter> Blend Colors With Materials**  to turn this feature on.
4. Click on the carpet to blend the selected color with the carpet texture. The result is a new material with the textured appearance of the carpet as well as the color you selected.



Using the Material Eyedropper

The **Material Eyedropper**  tool allows you to load a material that can be seen on a surface in a 3D view into the **Material Painter**  tool and then apply it to another surface. For example, in the master bedroom the wood material assigned to the crown molding is different than the material assigned to the chair rail and base molding. They can easily be made the same using the **Material Eyedropper**  tool.

1. Return to the Camera view.
2. Select **3D> Material Painter> Material Eyedropper**  and notice that the mouse pointer displays an eyedropper icon .



3. Click once on the crown molding to load the wood material. Notice that the mouse pointer changes to a spray can , indicating that the loaded material is ready to apply to another object.

4. Click on the chair rail and base moldings to apply the loaded material.



Custom Materials, Images, and Backdrops

Home Designer Interiors allows you to customize your 3D views by importing your own materials, image objects, and backdrops that display in 3D views. For more information about images, see “Pictures, Images, and Walkthroughs” on page 377 of the Reference Manual.

Note: The following steps make use of image files that are not included with the program. You can use image files that are already on your computer or you can create new ones. You can even use the same image file to create a material, an image, and a backdrop. Learning the tools and techniques described is more important than the appearance of the final product.

Creating Materials

You can create your own custom materials and save them in the library for use in any plan. Many materials are represented in 3D views using textures, which are digital images that have been specially edited to tile seamlessly when applied to a 3D surface. Bear in mind, therefore, that not all images will necessarily serve as effective material textures.

To add a new material to the library

1. Select **View > Library Browser**  or press Ctrl + L to open the Library Browser.
2. Right-click on the User Catalog 'folder and select **New > Material** from the contextual menu to open the **Define Material** dialog.

3. Give the new material a short, descriptive **Name**.

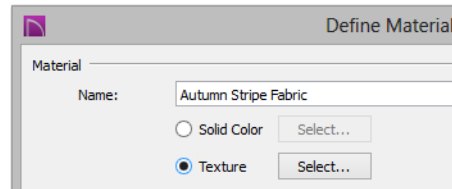

4. Click the **Texture** radio button, then click the **Browse** button to open the **Select Texture File** dialog, where you can choose an image file saved on your computer to be the new material's texture.

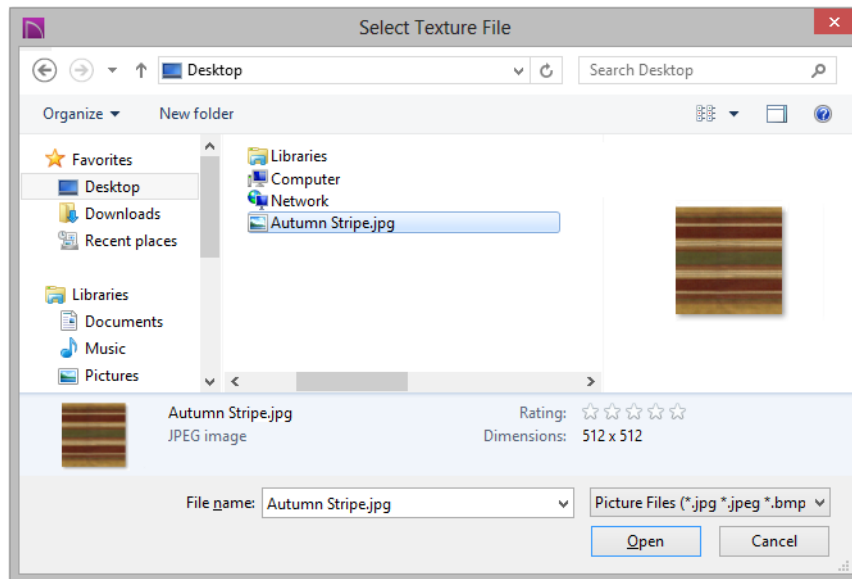

5. Select an image file and click the **Open** button to return to the **Define Material** dialog.
6. Specify the **Scale** of the texture, which controls how large the image will appear on the surfaces it is applied to.
7. Click **OK** to add the new material to the **User Catalog**.

For more information, see “Define Material Dialog” on page 307 of the Reference Manual.

Creating Images

In Home Designer Interiors, image objects are more than just 2D pictures. Images have size and height attributes and can contain transparency information. In floor plan view, they display only as 2D symbols; but in 3D views, the visual information that images contain can be seen.

To create an image and save it to the library

1. Right-click on the User Catalog folder, then select **New> Image**  from the contextual menu to open the **Image Specification** dialog. For more information, see “Image Specification Dialog” on page 380 of the Reference Manual.
2. On the Image panel, click the **Browse** button and browse to an image file saved on your computer. Here, an image of a cat that has transparency data associated with it is used; however, you can use any image.

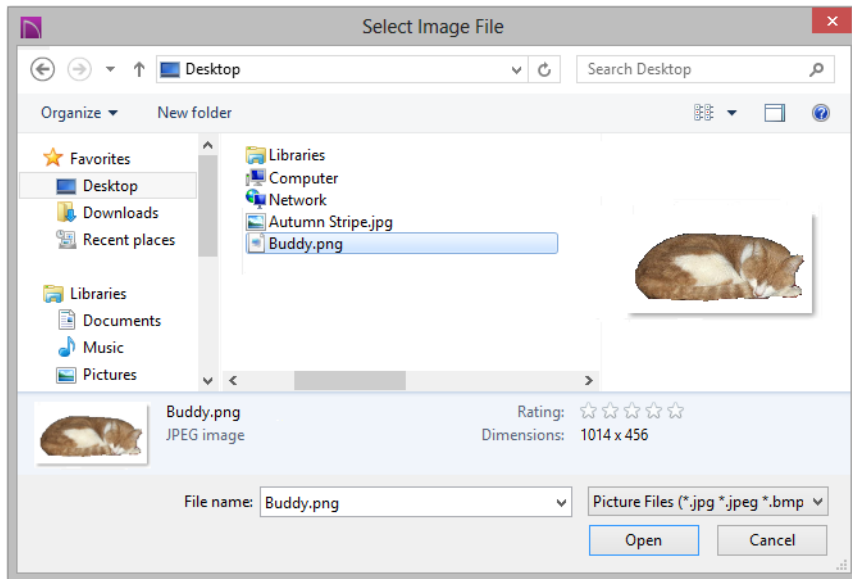

3. Click **Open** to return to the **Image Specification** dialog.
4. On the Image panel, enter the **Height** or **Width**, adjusting one will adjust the other, maintaining the correct proportion. Enter a **Height Above Ground** value to specify the elevation at which the image displays. A value of 24 inches works well in this case as we'll be placing the image on a piece of furniture.
5. Specify the transparency settings on the Transparency panel.
6. Click **OK** to close the **Image Specification** dialog and add the new image to the **My Images** category in the Images library.

Images can be placed in a plan just as plants, furnishings and fixtures are: by selecting the image and clicking any floor plan view, camera view or overview.

Importing Backdrops

Backdrops are images that display behind 3D views. In Home Designer Interiors, you can take a photo of a site, save it to the library as a backdrop, and display it behind 3D views to create a realistic rendering of your model and its surrounding view.

To import a backdrop and save it to the library

1. Select **File> Import> Backdrop**  and browse to an image on your computer.
2. Select the image and click **Open** to add it to the User Catalog.

To apply a backdrop to 3D views

1. Select **3D> 3D Backdrop**  to open the **Backdrop** dialog.
2. Click the **Select Backdrop** button and in the **Select Library Object** dialog, find and select your new backdrop in the User Catalog and click **OK**.

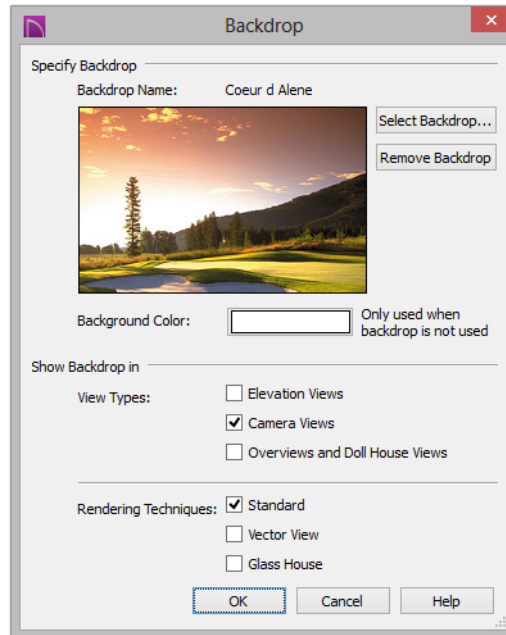

3. Click **OK** to close the **Backdrop** dialog.

You can see your custom material, image, and backdrop by creating a **Full Camera**  view.







Generating a Materials List

To conclude this tutorial, we'll generate a materials list for the house. You can generate a materials list for each room in your plan individually. For more information, see "Materials Lists" on page 409 of the Reference Manual.

Note: The Materials List is only a rough cost estimate. Always compare the Materials List with a manual take-off before ordering materials for a project.

To calculate a materials list for an individual room

1. Click the **Select Objects**  button, then click in a room to select it.
2. With the room selected, click the **Calculate from Room**  edit button or select **Tools> Materials List> Calculate from Room** . The program calculates a list of the objects and materials contained in the selected room.
3. Click in the "Price" column for any line item and type in a dollar amount.
4. Notice that the subtotal and Total both update to reflect the pricing change. You can specify prices for every material in the list, allowing you to generate a cost estimate for the selected room.
5. If you wish, you can select **File> Export Materials List**  and save the list as a Tab-delimited **.txt** file, which can be opened in a spreadsheet application.

6. Close the materials list window by selecting **File> Close** from the menu, by pressing F4, or by clicking the  in the upper right hand corner (for the current window, not the program).

End User License Agreement

Chief Architect, Inc.

**End User Software License Agreement for
Chief Architect® Software**

NOTICE TO USER:

PLEASE READ CAREFULLY: THIS IS A CONTRACT. BY INSTALLING, COPYING OR USING THIS SOFTWARE, YOU AGREE TO BE BOUND BY ALL THE TERMS AND CONDITIONS OF THIS LICENSE AGREEMENT, ON YOUR OWN BEHALF AND ON THE BEHALF OF THE ENTITY BY WHOM YOU ARE EMPLOYED OR REPRESENT. IF YOU DO NOT AGREE WITH THE TERMS OF THIS AGREEMENT, DO NOT INSTALL, USE OR COPY THE SOFTWARE. INSTEAD, RETURN THE SOFTWARE WITHIN THE SPECIFIED GUARANTEE PERIOD TO THE PLACE OF PURCHASE FOR A REFUND OF YOUR PURCHASE PRICE.

This Chief Architect, Inc. End User License Agreement ("License Agreement", or "EULA") is a legal agreement between you (an individual or entity) and Chief Architect, Inc., and sets forth the terms and conditions under which you are licensed to use the Software. "Software" means (A) all of the contents of the CD-ROM(s), DVD(s), electronic download, online media, or any other media which is accompanied by this Agreement, including, but not limited to (i) Chief

Architect or third party software, (ii) printed, "online" or electronic explanatory materials ("Documentation"), (iii) digital images, sample plans, textures, images, symbols, photographs, videos or other artistic works ("Graphical Files"), (B) hardware or software security key, if any, and (C) modified versions, updates, upgrades, downloadable content, additions and copies of the software, if any, licensed to you by Chief Architect, Inc. (collectively, "Updates").

1. GRANT OF LICENSE TO USE SOFTWARE: Chief Architect, Inc. grants you a non-exclusive, non-transferable (except as provided below) license ("License") to use the Software in object code only (and specifically not in source code) subject to the following terms and conditions:

(a)Software: Unless otherwise agreed to in writing, Chief Architect, Inc. grants you the right to use one copy of the Software on only one computer at one location at any one time. This software is licensed for use by you and only you. You may not share your license of this software with any other person, and you agree not to allow any other person to use your license of this software. In order to use this software, each person must purchase their own valid license;

(b)Storage/Network Use: You may store or install the Software on a network server or other storage device only to install and run the Software on an internal network. You must, however, purchase and dedicate a separate license of the Software for each computer and each concurrent user of the Software installed or accessed from a network server or other storage device. A single license for the Software may not be shared or used concurrently on different computers;

(c)Backup: You may make a backup copy of the Software for archival purposes. If printed Documentation accompanies the Software, it may not be copied. If the Software is accompanied by Documentation in electronic form, you may print out one (1) copy for your use which, in turn, may not be copied. A copy of the Software must include all copyright notices and this License Agreement;

(d)If you receive one copy of the Software electronically and a second copy on media or by any other means, the second copy may be used for archival purposes only and may not be transferred to or used by any other person. This license does not grant you any right to any enhancement or update unless otherwise agreed to in writing by Chief Architect, Inc.;

(e)The Student Edition of the Software must be used only by a student for qualified educational purposes and only while actively studying at a qualified educational institution. The Student Edition of the Software shall not be used for commercial purposes;

(f)The NKBA Exam Version of the Software must be used only by a registered NKBA Exam applicant and only for the purpose of preparing for and taking the NKBA Exam. The NKBA Exam Version has a limited timeout period and cannot be upgraded. The NKBA Exam Version of the Software shall not be used for commercial purposes;

(g)Academic Licenses are licensed for use by educational institutions for educational purposes only. If the Software is licensed as an Academic License and you are not a qualified

educational institution using the Software for qualified educational purposes, then your license(s) of the Software are invalid.

2. OTHER RIGHTS AND RESTRICTIONS:

(a)Reverse Engineering: You may not modify, translate, reverse engineer, decompile, disassemble, or modify the Software in any way or use any other method to convert the Software or any component of the Software into human-readable code, create derivative works based upon the Software, Documentation, or Graphical Files or allow anyone else to do so;

(b)Renting: You may not rent, lease, sub-license, lend, duplicate or distribute the Software, Documentation, or Graphical Files without the prior written consent of Chief Architect, Inc., which, if given, is subject to the transferee's consent to the terms and conditions of this License Agreement;

(c)Copying: You may not copy or reproduce the Software, Documentation, or Graphical Files (except for personal back-up purposes);

(d)Upgrades: If the Software is being licensed to you as an upgrade, renewal, or update to software previously licensed to you, you must cease using the software previously licensed to you, including any and all copies installed on your computers, once you have successfully installed and commenced use of the upgrade, renewal, or update software. You may not transfer, sell, or loan the software version previously licensed to you to any other person or entity. Any unauthorized attempt to transfer or sell the software previously licensed to you will result in automatic termination of your current software license. You may, however, maintain a copy of the software previously licensed to you for your own archival purposes only;

(e)The Student Edition has a limited timeout period and cannot be upgraded;

(f)Proprietary Notices: You may not remove any proprietary notices or labels from the Software, Documentation, or Graphical Files;

(g)Protection: You may not utilize any computer hardware or software designed to defeat any hardware or software copy-protection device, should the Software be equipped with such protection. You may not disable any copy-protection or security control features of the Software;

(h)Licensing and Authentication: This Software uses security technology to authenticate your software installation and protect your license from unauthorized use. You agree to allow the Software to send this security information to the Chief Architect security servers for authentication. You may not disable any such security, licensing, or control features of the Software;

(i)Public Access: You may not copy the Software, Graphical Files, or any component of the Software onto any public network. You may not, in any manner, make it accessible to others, including via internet Web site, telecommunication transmittal, electronic bulletin board, cloud service, or any other form of electronic distribution system;

(j)Distribution: This Software and all components of the Software are licensed for your use only. You may not share or distribute the Software to any other party or entity. You may share only images, textures, and symbols used by your design with other licensed users of the software; however, you may not share or distribute these files or exported versions of these files to any other party or entity for use as library content with other software programs. Use of Chief Architect Graphical Files as library content within other software programs is a violation of this License Agreement.

3. TRANSFERRING YOUR SOFTWARE: You may permanently transfer your license to another person or entity only upon written approval by Chief Architect, Inc., and according to the following terms and conditions:

(a)You must fill out, sign, and return to Chief Architect, Inc. the Certificate of Transfer of Ownership prior to any transfer of the Software. This is available through the Chief Architect, Inc.'s Customer Service Department. Call Chief Architect, Inc.'s Customer Service Department prior to any transfer in order to receive this document;

(b)The transferor or transferee must pay to Chief Architect, Inc. a license transfer fee for each license transferred to complete the process of transfer of ownership;

(c)You may permanently transfer a current, valid and eligible license for the Software, for which full price was paid. If you received a discount or rebate on the Software, you must pay to Chief Architect, Inc. the difference in price between your discounted price and the full price of the Software for each license transferred. You must deliver the Software to the transferee in its entirety and must not retain any copy of the Software on any computer or storage media, including backup or archival copies;

(d)You may transfer an Additional License and still retain other licenses of the Software only by paying to Chief Architect, Inc. the difference in price between the full retail price of the Software and the net price paid (including discounts and rebates) for each Additional License transferred;

(e)If you own multiple licenses and you wish to transfer a license, the license to be transferred shall be the license for which you received the largest discount or rebate;

(f)Your License will automatically terminate upon any transfer of the Software;

(g)If the Software being transferred is an Upgrade, you must cease using all prior versions of the Software, Documentation, and Graphical Files as well. You must uninstall all versions of the software and you may not use or retain any copy of any prior version of the Software;

(h)You may not transfer any earlier versions of Software which have been upgraded;

(i)You may not transfer a license of the Software that was purchased under the Chief Architect National Accounts program;

(j)You may not transfer a Not For Resale (NFR) license of the Software. You also may not transfer a Presentation license, a Student license, or an Academic license of the Software;

(k) You may not transfer any NKBA Exam Version license of the Software;

(l) The recipient of the transfer shall agree to all the terms of this License Agreement as a condition of the transfer.

4. **TITLE:** Title, ownership, rights, and intellectual property rights in and to the Software, Documentation, Graphical Files, and any other accompanying materials shall remain with Chief Architect, Inc. or the respective third party. Title, ownership, rights, and intellectual property rights in and to each of the Sample Drawings and any accompanying materials shall remain with each Licensor from whom Chief Architect, Inc. licensed each Sample Drawing and any accompanying materials. Unauthorized copying of the Software, Documentation, Graphical Files, or Sample Drawings, or failure to comply with the foregoing restrictions, will result in the automatic termination of this License Agreement. Unauthorized duplication of the Software, Documentation, Graphical Files, or Sample Drawings constitutes copyright infringement and in the United States is punishable in a federal criminal action by a fine of up to \$250,000 and imprisonment of up to five (5) years. In addition, federal civil penalties allow the recovery of actual damages based on the number of unauthorized copies produced or statutory damages of up to \$100,000 for willful copyright infringement.

5. **THIRD PARTY CONTENT:** All trademarks and logos belong to their respective owners. All Graphical Files and Content, including symbols, images, textures, backdrops, text, and videos are the copyright subject matter of Chief Architect, Inc. or third parties. The Graphical Files and Content included with the Software are provided for use with the Software only. You shall not use the Graphical Files or Content included with the Software for any other purpose outside of the Software plan files. You shall not sell or distribute the Graphical Files or Content for any purpose whatsoever. You shall not use the Graphical Files or Content with other software. Chief Architect, Inc. and third party content, symbols, text, or textures shall not be copied, redistributed, or sold separately from the Software. Chief Architect, Inc. and third party product content is provided for representational purposes only. Chief Architect, Inc. and third parties assume no responsibility for any discrepancies between actual product appearance and that represented in the Software, or between actual pricing, characteristics, and specifications, and that mentioned anywhere in the Software or Documentation.

6. **MONEY-BACK GUARANTEE PERIOD:** The Software has a money-back guarantee for satisfaction. During the money-back guarantee period (the "Guarantee Period") following your first purchase of the Software, you may request to return the Software, Documentation, Security Device (if any), and packaging, along with the original purchase receipt, for a refund of the purchase price, less any applicable shipping fees, taxes, duties, discounts, and rebates paid. This money-back guarantee does not apply to license transfers. You agree to contact Chief Architect, Inc. in order to obtain and perform proper return material authorization ("RMA") steps prior to returning the Software. You also agree to uninstall and deactivate the Software and all of its related files and content from your computer prior to returning the product.

If, after returning the Software, Documentation, Security Device (if any), and packaging for a refund, you repurchase any version of the Software again, you are, by the act of repurchasing the Software, acknowledging satisfaction with the Software, and by doing so agree to purchase and keep the Software permanently without the option to return it for a refund.

7. GRANT OF LICENSE TO USE SAMPLE DRAWINGS: Chief Architect, Inc. has licensed from third parties (the "Licensors") sample drawings that may be included in the Software. These Sample Drawings are provided to you by Chief Architect, Inc. solely for demonstrative and illustrative purposes to help you more quickly learn and better understand the functional capabilities of the Software, and are licensed to you solely for these limited purposes. You may not reproduce, distribute or use these Sample Drawings for any other purpose without the prior written consent of Chief Architect, Inc. and the Licensor(s) from whom these Sample Drawings were licensed by Chief Architect, Inc..

8. LIMITED SOFTWARE WARRANTY: Chief Architect, Inc. warrants that for a period of sixty (60) days from the date of your purchase of the Software as evidenced by an original copy of your receipt, the media upon which the Software is furnished will be free from defects in materials and workmanship under normal use. **EXCEPT FOR THE ABOVE EXPRESS LIMITED WARRANTIES, CHIEF ARCHITECT, INC. MAKES NO WARRANTIES AS TO THE SOFTWARE, EXPRESS, IMPLIED, STATUTORY, OR IN ANY COMMUNICATION WITH YOU. CHIEF ARCHITECT, INC. SPECIFICALLY DISCLAIMS ANY OTHER WARRANTY INCLUDING THE IMPLIED WARRANTY OF MERCHANTABILITY OR FITNESS FOR A PARTICULAR PURPOSE WITH REGARD TO THE SOFTWARE, AND THE ACCOMPANYING WRITTEN MATERIALS. CHIEF ARCHITECT, INC. DOES NOT WARRANT THAT YOUR USE OF THE SOFTWARE WILL BE UNINTERRUPTED OR THAT THE OPERATION OF THE SOFTWARE WILL BE ERROR-FREE.** If this Software was purchased in the United States, the above exclusions may not apply to you as some states do not allow the exclusion of implied warranties. In addition to the above warranty rights, you may also have other rights, which vary from state to state.

9. CUSTOMER REMEDIES: The entire liability of Chief Architect, Inc. and your exclusive remedy under the warranty provided as to Software set forth above will be, at Chief Architect, Inc.'s sole discretion: (i) to replace the media; (ii) to attempt to correct or work around software media errors, if any; or (iii) if the above remedies are impracticable to refund the license fee you paid, if any, for the Software. The latter remedy is subject to pre-authorized return of the Software, Documentation, Security Device (if any) and packaging to Chief Architect, Inc. or to the Authorized Chief Architect, Inc. Dealer or Reseller from whom the Product was obtained together with an original copy of your receipt.

Repaired, corrected or replaced software media and documentation shall be covered by this limited warranty for the period remaining under the warranty that covered the original Software or, if longer, for thirty (30) days after the date Chief Architect, Inc. shipped the repaired or replaced software media or documentation to you. Only if you inform Chief Architect, Inc. of the problem with the software media or documentation during the applicable warranty period

and provide evidence of the date you acquired the Software will Chief Architect, Inc. honor this warranty.

10. NO WARRANTY AS TO THE SAMPLE DRAWINGS, SAMPLE PLANS, LIBRARY CONTENT, OR VIDEOS: CHIEF ARCHITECT, INC. MAKES NO WARRANTY WHATSOEVER AS TO THE SAMPLE DRAWINGS, SAMPLE PLANS, LIBRARY CONTENT, OR TRAINING VIDEOS WHICH ARE PROVIDED TO YOU SOLELY FOR DEMONSTRATIVE AND ILLUSTRATIVE PURPOSES. CHIEF ARCHITECT, INC. MAKES NO WARRANTY THAT THE DIMENSIONS IN THE SAMPLE DRAWINGS, SAMPLE PLANS, LIBRARY CONTENT, OR VIDEOS ARE ACCURATE AND FREE OF DISCREPANCIES. CHIEF ARCHITECT, INC. MAKES NO WARRANTY THAT THE LIBRARY CONTENT, SAMPLE DRAWINGS, OR SAMPLE PLANS COMPLY WITH ANY BUILDING CODES. THE LIBRARY CONTENT, SAMPLE DRAWINGS, AND SAMPLE PLANS ARE PROVIDED TO YOU "AS IS," AND CHIEF ARCHITECT, INC. AND THE LICENSORS OF THE LIBRARY CONTENT, SAMPLE DRAWINGS, AND SAMPLE PLANS DISCLAIM ANY AND ALL WARRANTIES WITH RESPECT TO THE LIBRARY CONTENT, SAMPLE DRAWINGS, AND SAMPLE PLANS, WHETHER EXPRESS OR IMPLIED OR ARISING BY CUSTOM OR TRADE USAGE, AND, SPECIFICALLY, MAKE NO WARRANTY OF MERCHANTABILITY OR FITNESS FOR ANY PARTICULAR PURPOSE.

11. DISCLAIMER AND LIMITATION OF LIABILITY: COMPUTER-AIDED DESIGN SOFTWARE AND OTHER TECHNICAL SOFTWARE ARE TOOLS INTENDED TO BE USED BY TRAINED AND EXPERIENCED INDIVIDUALS ONLY. THEY ARE NOT SUBSTITUTES FOR YOUR TRAINED, EXPERIENCED AND PRACTICAL JUDGMENT. COMPUTER-AIDED DESIGN SOFTWARE AND OTHER TECHNICAL SOFTWARE ARE INTENDED TO ASSIST WITH ARCHITECTURAL, PREMISES OR PRODUCT DESIGN AND ARE NOT SUBSTITUTES FOR INDEPENDENT TESTING OF STRUCTURAL INTEGRITY, ENGINEERING, SOUNDNESS, SAFETY, AND UTILITY. DUE TO THE LARGE VARIETY OF POTENTIAL APPLICATIONS FOR THE SOFTWARE, THE SOFTWARE HAS NOT BEEN TESTED IN ALL SITUATIONS UNDER WHICH IT MAY BE USED. CHIEF ARCHITECT, INC. SHALL NOT BE LIABLE IN ANY MANNER WHATSOEVER FOR THE RESULTS OBTAINED THROUGH THE USE OF THE SOFTWARE. PERSONS USING THE SOFTWARE ARE RESPONSIBLE FOR THE SUPERVISION, MANAGEMENT AND CONTROL OF THE SOFTWARE AND THEIR EMPLOYEES OR CONTRACTORS WHO USE THE SOFTWARE. THIS RESPONSIBILITY INCLUDES, BUT IS NOT LIMITED TO, THE DETERMINATION OF APPROPRIATE USES FOR THE SOFTWARE AND THE SELECTION OF THE SOFTWARE AND OTHER PROGRAMS TO ACHIEVE INTENDED RESULTS. PERSONS USING THE SOFTWARE ARE ALSO RESPONSIBLE FOR ESTABLISHING THE ADEQUACY OF INDEPENDENT PROCEDURES FOR TESTING THE RELIABILITY AND ACCURACY OF ANY PROGRAM OUTPUT, INCLUDING ALL ITEMS DESIGNED OR MEASURED BY USING THE SOFTWARE.

UNDER NO CIRCUMSTANCES WILL CHIEF ARCHITECT, INC., ITS DEALERS, RESELLERS, DISTRIBUTORS, OR THE LICENSORS OF THE GRAPHICAL FILES, SAMPLE DRAWINGS, AND SAMPLE PLANS BE LIABLE FOR ANY DAMAGES, WHETHER ARISING FROM TORT OR CONTRACT, INCLUDING LOSS OF DATA, LOST PROFITS, COST OF COVER, OR OTHER SPECIAL, INCIDENTAL, CONSEQUENTIAL OR INDIRECT DAMAGES ARISING OUT OF THE USE OR INABILITY TO USE THE SOFTWARE, DOCUMENTATION, GRAPHICAL FILES, OR THE SAMPLE DRAWINGS AND SAMPLE PLANS. CHIEF ARCHITECT, INC., ITS DEALERS, RESELLERS, DISTRIBUTORS, AND THE LICENSORS OF THE GRAPHICAL FILES, SAMPLE DRAWINGS, AND SAMPLE PLANS ASSUME NO LIABILITY OR RESPONSIBILITY FOR, AMONG OTHER THINGS, INADVERTENT DISCREPANCIES, CONSTRUCTION INTERPRETATIONS OR CONSTRUCTED RESULTS. THESE LIMITATIONS WILL APPLY EVEN IF CHIEF ARCHITECT, INC., ITS DEALERS, RESELLERS, DISTRIBUTORS, OR THE LICENSORS OF THE GRAPHICAL FILES, SAMPLE DRAWINGS, AND SAMPLE PLANS HAVE BEEN ADVISED OF THE POSSIBILITY OF SUCH DAMAGE. YOU ACKNOWLEDGE THAT THE LICENSE FEE REFLECTS THIS ALLOCATION OF RISK. FURTHER, IN NO EVENT SHALL THE LIABILITY OF CHIEF ARCHITECT, INC., ITS DEALERS, RESELLERS, DISTRIBUTORS, AND THE LICENSORS OF THE GRAPHICAL FILES, SAMPLE DRAWINGS, AND SAMPLE PLANS UNDER ANY PROVISION OF THIS AGREEMENT EXCEED THE LICENSE FEE PAID TO CHIEF ARCHITECT, INC. FOR THE SOFTWARE, DOCUMENTATION, GRAPHICAL FILES, AND THE SAMPLE DRAWINGS AND SAMPLE PLANS. BECAUSE SOME STATES DO NOT ALLOW THE EXCLUSION OR LIMITATION OF LIABILITY FOR CONSEQUENTIAL OR INCIDENTAL DAMAGES, THE ABOVE LIMITATION MAY NOT APPLY TO YOU.

12. **TERMINATION:** This license shall terminate automatically if you fail to comply with the terms, conditions, and limitations described in this license. No notice shall be required from Chief Architect, Inc. to effectuate such termination. Upon termination, you must immediately uninstall and deactivate the Software. You must also return or destroy all copies of the Software and Documentation.

13. **U.S. GOVERNMENT RESTRICTED RIGHTS:** The Software and Documentation are provided with RESTRICTED RIGHTS for U.S. Government customers. Use, duplication or disclosure by the Government is subject to restrictions as set forth in subparagraph (c)(1)(ii) of The Rights in Technical Data and Computer Software clause at DFARS 252.227-7013 or subparagraphs (c)(i) and (2) of the Commercial Computer Software-Restricted Rights at 48 CFR 52.227-19 as applicable. The manufacturer is Chief Architect, Inc., 6500 N. Mineral Dr., Coeur d'Alene, Idaho 83815.

14. **GOVERNING LAW:** This License Agreement shall be governed by the laws of the State of Idaho without regard to conflicts of law principles. This License Agreement shall not be governed by the United Nations Convention of Contracts for the International Sale of Goods,

the application of which is hereby expressly excluded. If either you or Chief Architect, Inc. employs attorneys to enforce any right arising out of this Agreement, the prevailing party shall be entitled to recover reasonable attorney's fees and costs.

15. ENTIRE AGREEMENT: This agreement constitutes the complete and exclusive agreement between you and Chief Architect, Inc. with respect to the subject matter hereof and supersedes all prior oral or written understandings, communications or agreements not specifically incorporated herein. This agreement may not be modified except in a writing duly signed by an authorized representative of Chief Architect, Inc. and you. **THE ACCEPTANCE OF ANY PURCHASE ORDER PLACED BY YOU IS EXPRESSLY MADE CONDITIONAL ON YOUR CONSENT TO THE TERMS SET FORTH HEREIN.**

Index

Numerics

3D Views	
Create	38

A

Adding	
Floors	41
Foundations	41
Appliances	104
Artwork	
Adding	121
Auto	
Check for Program Updates	16
Exterior Dimensions	28
Stairwell	48
Auto Rebuild	
Roofs	58, 82

B

Backdrop Dialog	127
Backdrops	
Importing	127
Selecting	127
Basements	41
Blend Colors with Materials	122
Break	
Wall	77

C

Cabinets	
Base	99
Corner	101
Creating	99
Editing	100
Soffits	104
Wall, placing	102
Camera	
Views, Creating	38
Carpet	
Adding	119
Chair Rails	
Adding	94
Corner	
Cabinet	101
Cross Section Slider	112
Crown Molding	
Adding to rooms	94

D

Defaults	
Material	116
Dimensions	27
Auto Exterior	28
Doors	
Adding	51
Copying	53
Editing	51
Placing	51
Dormers	72
Manually Drawn	70

F

Final View 112

Foundation

 Creating..... 41

G

Gable

 Roofs..... 61

Gambrel Roofs..... 64

Gull Wing Roofs..... 65

H

Half Hip Roofs..... 66

Hip

 Roofs..... 60

I

Image

 Specification Dialog..... 126

Images

 Creating..... 125

Installation 7

Interior

 Dimensions 28

Invisible Walls..... 35

L

Library Objects

 Placing 91

Library Search 91

M

Mansard Roofs 67

Material

 Defaults 116

 Eyedropper 123

Material Painter..... 119

 Blending..... 122

Materials

 Applying..... 117

 Artwork 121

 Blending 122

 Changing 117

 Creating 124

Materials Defaults..... 115

Materials List..... 128

Materials Panel..... 117

Merging Walls..... 41

Molding 94

Mouse-Orbit Camera..... 40, 50

O

Open

 Plan 20

P

Plan

 Templates 21

Program Updates

 Auto Check 16

R

Reference

 Display..... 41

Roof Type Quick Reference..... 69

Roofs

 Gable..... 61

Gambrel	64
Gull Wing.....	65
Half Hip	66
Hip	60
Mansard	67
Manual Dormers	70
Offset Gable	63
Shed	62
Rooms	
Creating	32
Room Labels	36
Room Types	36
Selecting	118
Rugs	
Area rugs, creating.....	120

S

Select	
Room	118
Shed	
Roofs	62
Skylights	
Creating	76
Soffits	104
Stair Designer	46
Stair Landing	
Creating	46
Stairwell	48
Create manually.....	48
Starting the Program	20
Startup Options	20

T

Templates	21
------------------------	----

U

Updates	
Auto Check.....	16

W

Wall	
Cabinets, placing.....	102
Coverings	96
Walls	
Drawing	24
Merging	41
Windows	
Copying	53
Editing	52
Placing	51

