

Chief Architect®
Home Designer Architectural® 2020
3D Home Design Software

User's Guide

A step-by step introduction to the software.

Chief Architect, Inc.
6500 N. Mineral Dr.
Coeur d'Alene, Idaho 83815
HomeDesignerSoftware.com

© 1990–2019 by Chief Architect, Inc. All rights reserved.

No part of this documentation or the accompanying software may be reproduced or transmitted in any form or by any means, electronic or mechanical, including photocopying, recording, or by any information storage and retrieval system, without permission in writing from Chief Architect, Inc.

Chief Architect® and Home Designer® are registered trademarks of Chief Architect, Inc.

This software uses Open CASCADE Technology. See www.opencascade.com for details. Open CASCADE is used under the GPL version 2.1 license.

This software uses the FreeImage open source image library. FreeImage is used under the FIPL license, version 1.0. See <http://freeimage.sourceforge.net> for details.

This application incorporates Teigha® software pursuant to a license agreement with Open Design Alliance. Teigha® Copyright © 2003-2018 by Open Design Alliance. All rights reserved.

This software uses the Ruby open source library. See <http://www.ruby-lang.org/> for details.

3D input device development tools and related technology are provided under license from 3Dconnexion. © 3Dconnexion 1992 - 2018. All rights reserved.

The City Blueprint and Country Blueprint fonts are © 1992–1999 Payne Loving Trust. All rights reserved.

This software uses the OpenCV open source computer vision library. OpenCV is used under the 3-clause BSD License. See <https://www.opencv.org/> for details.

All other trademarks and copyrights are the property of Chief Architect, Inc. or their respective owners.

Created in the United States of America.

Contents

Chapter 1: Installation

System Requirements.....	7
Downloading Home Designer Architectural.....	8
Installing Home Designer Architectural.....	8
Starting Home Designer Architectural.....	15
Migrating Settings and Content.....	15
Program Updates.....	17
Creating a Chief Architect Account.....	17
Installing on Multiple Computers.....	18
Uninstalling Home Designer Architectural.....	18

Chapter 2: House Design Tutorial

Before You Begin.....	22
Getting Started.....	22
Setting Defaults.....	23
Drawing Walls.....	25
Creating Dimension Lines.....	28
Adjusting Wall Positions.....	31
Creating Rooms.....	33
Creating a 3D View.....	39
Adding Floors.....	41
Adding Stairs.....	46
Placing Doors and Windows.....	50

Chapter 3: Roof Tutorial

Getting Started with Automatic Roof Styles.....	58
Hip Roofs.....	61
Gable Roofs.....	61
Dutch Gable Roofs.....	62
Shed Roofs.....	63
Offset Gable Roofs.....	64
Gambrel Roofs.....	65
Gull Wing Roofs.....	66
Half Hip Roofs.....	67
Mansard Roofs.....	68
Roof Style Quick Reference.....	70
Roof Returns.....	71
Adding Gables over Doors and Windows.....	71
Automatic Dormers.....	73
Manually Drawn Dormers.....	73
Skylights.....	80
Using the Break Wall Tool to Modify Roofs.....	80
Adding a Roof to the Stucco Beach House.....	84
Troubleshooting Roof Issues.....	86

Chapter 4: Interior Design Tutorial

Controlling the Display of Objects.....	93
Working with Library Objects.....	94
Applying Room Moldings.....	98
Applying Wall Coverings.....	100

Chapter 5: Kitchen and Bath Design Tutorial

Adding Cabinets.....	103
----------------------	-----

Placing Appliances.....	108
Editing Cabinets and Appliances.....	110
Creating a Cabinet Island.....	111
Creating Architectural Blocks.....	113
Working in Elevation Views.....	114

Chapter 6: Materials Tutorial

Setting Materials Defaults	119
Using the Materials Panel.....	121
Using the Material Painter	123
Blending Colors with Materials	125
Using the Material Eyedropper.....	126
Custom Materials, Images, and Backdrops	128
Generating a Materials List.....	134

Chapter 7: Landscaping Tutorial

Creating a Terrain Perimeter.....	138
Creating a Walkout Basement	141
Creating a Retaining Wall	143
Adding a Driveway	145
Adding Terrain Features	147
Adding Library Objects to Your Plan.....	153

Chapter 8: Deck Tutorial

Decks and Porches.....	157
Drawing Decks.....	157
Drawing Stairs	159
Changing Planking Orientation	160
Adding Exterior Furniture	160

Installation

This chapter will walk you through installing your Home Designer software.

Chapter Contents

- System Requirements
- Downloading Home Designer Architectural
- Installing Home Designer Architectural
- Starting Home Designer Architectural
- Migrating Settings and Content
- Program Updates
- Creating a Chief Architect Account
- Installing on Multiple Computers
- Uninstalling Home Designer Architectural

System Requirements

In order to install and run Home Designer Architectural, your computer system must meet the following minimum requirements:

- 64-bit Windows[®] 10/8/7; macOS[™] High Sierra or Mojave
- Multi-core processor
- 4 GB of memory
- 5 GB of available hard disk space
- Video card minimum: 1 GB of memory; OpenGL 3.3 on Windows; OpenGL 4.1 on Mac

- Recommended minimum monitor resolution: 1152 x 864
- High speed internet for registration, license authentication, deactivation, video access, content downloads
- USB port (if installing from backup USB drive)

Internet access for license authentication is required once every 14 days.

For more information about system recommendations, visit our Web site at HomeDesignerSoftware.com.

Downloading Home Designer Architectural

To download and install Home Designer Architectural 2020, begin by logging in to your online Home Designer Architectural account at HomeDesignerSoftware.com.

Browse to the Digital Locker page, select the version that you would like, click the Download button, and save the file to your local hard drive. Select an easy to find **Save in** location on your computer, such as your Documents folder or Windows Desktop, then click **Save**.

Installing Home Designer Architectural

When the installer file is completely downloaded, browse to its save location and double-click on it to launch the program installer.

If you have a Home Designer Architectural Program USB drive, insert it into a port on your computer:

- In Windows, the Setup Wizard will launch automatically. If it does not, press the Windows key on your keyboard, then type the word Computer and press Enter. Right-click on the USB drive and select **Open** from the menu, then double-click on the Windows Installer file.
- On a Mac, the USB drive will open in a Finder window automatically. If it does not, right-click on the disk icon on your desktop and select **Open** from the menu. Then, double-click on the file with the **.pkg** file extension.

Setup Wizard Welcome

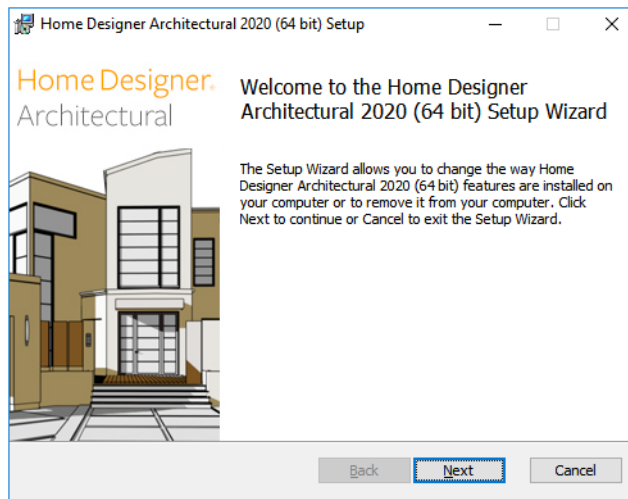

1. Depending on whether or not you have installed the program on this computer before, the text in this window may vary. Click **Next** to continue.

Setup Maintenance

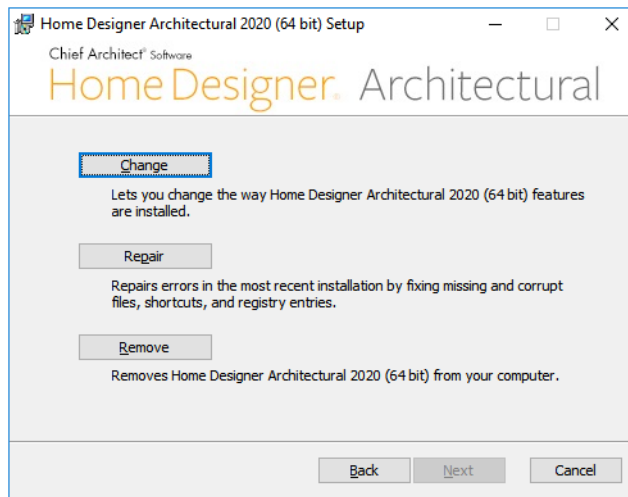

2. If you are installing the program for the first time, this window will not display. If you have installed the program before it will, allowing you to reinstall or uninstall the program.

License Agreement

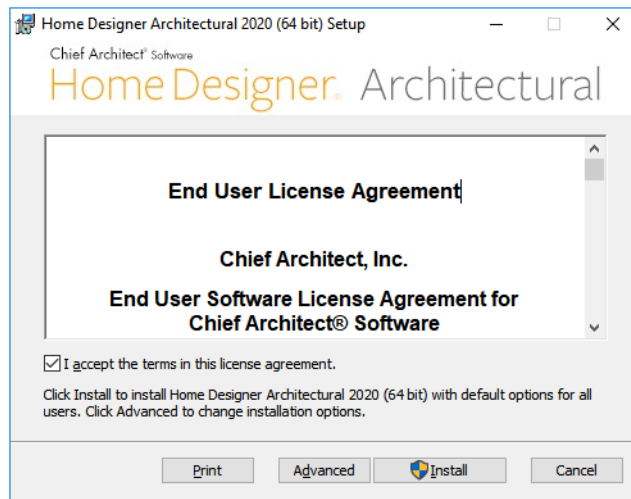

3. Read the License Agreement carefully. You must check the box beside **I accept the terms and conditions of this license agreement** before installing.
 - In the Windows version, click the **Advanced** button if you'd like to specify a non-default installation location, exclude supplementary content from being installed, or choose whether a desktop shortcut is created.
 - Click **Install** to begin installing the software.

Advanced Options

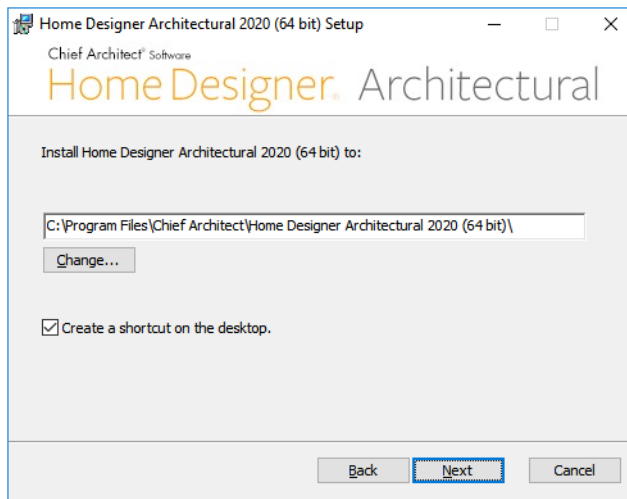

4. This window is only found in the Windows version, and only if you click the **Advanced** button in the previous window. By default, the Windows version of the program installs in a folder with the same name as the program version located at C:\Program Files\Chief Architect. You can, if you wish, choose a different destination folder on the local machine.
 - Type a full pathname to the destination folder in the text field.
 - Click the **Change** button to browse to a destination folder in the next window.
 - Uncheck **Create a shortcut on the desktop** if you prefer that a desktop shortcut icon not be created.

Choose Installation Location

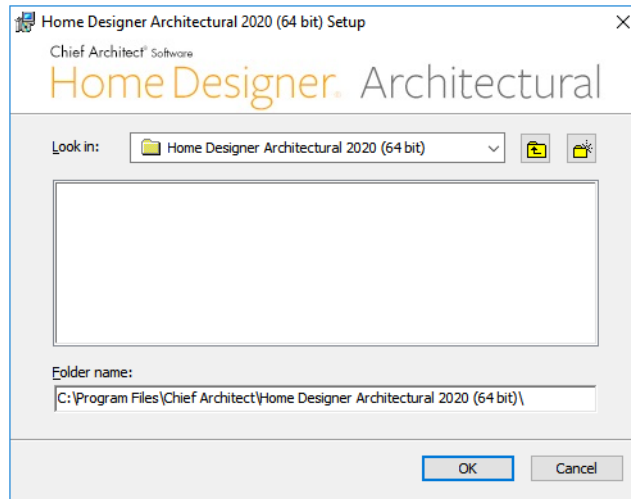

5. This window is only found in the Windows version, and only if you clicked the **Change** button in the previous window. By default, the Windows version of the program installs in a folder with the same name as the program version located at C:\Program Files\Chief Architect.
 - Select a destination folder from the **Look in:** drop-down list.
 - Any folders located inside the selected destination folder display in the field below.
 - The full pathname of the installation directory is stated in the **Folder name:** field. You can type a different pathname if you wish.
 - Click **OK** to proceed to the next window.

Note: Regardless of the location that you specify here, the program's library content will be installed in your computer's ProgramData folder.

Choose Items to Install

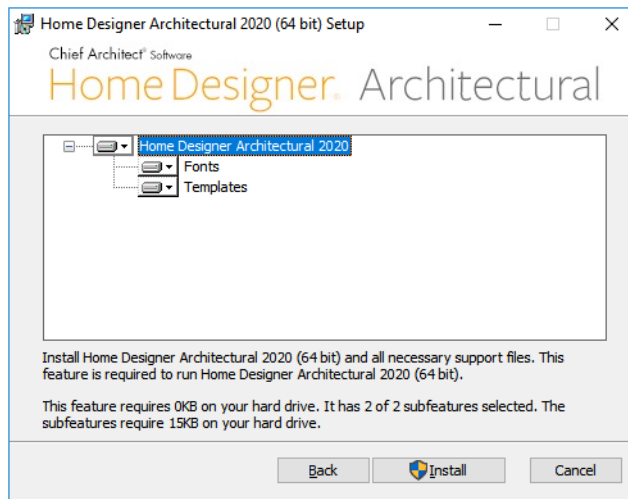

6. You can use this window to specify what features you wish to install.
 - Click on a line item to select it. Information about its contents and hard drive space requirements displays beneath the list of features.
 - Click the drop-down arrow beside a line item to specify how it is installed. By default, **Entire feature will be installed** is selected for all line items.
 - Choose **Entire feature will be unavailable** to prevent a selected subfeature from being installed. When this option is selected, a red X will display beside the line item's drop-down arrow. The top level feature cannot be excluded from installing. If you decide to not proceed with the program installation, click the Cancel button.
 - Click **Install** to install the program and supplemental content as specified.

Install

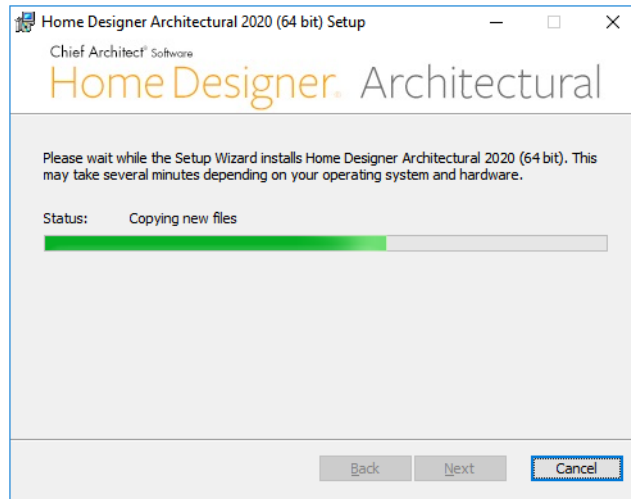

7. The Setup Wizard will begin copying files to your hard disk after a few moments and a green progress bar in this window will show the status of this process. This may take a few minutes.

Setup Wizard Complete

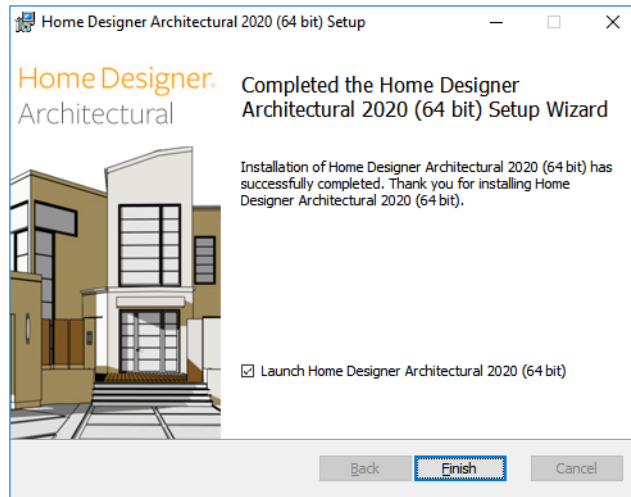

8. When all files have been copied, this window will display.

- In Windows, click **Finish** to launch Home Designer Architectural.
- On a Mac, click on **Applications** to open Finder, where you can launch the program.

Starting Home Designer Architectural

In Windows, you can use the Start menu or the shortcut on your desktop to start Home Designer Architectural. On a Mac, open Finder and browse to Applications.

Product Activation

When you launch the program for the first time, the **Product Activation** dialog will open.

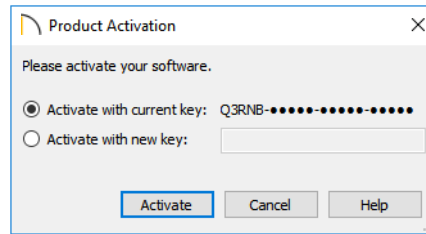

- If you are launching the software for the first time, enter your **Product Key**, which is located in the account information from your download or on your shipping invoice.
- If the program has been previously activated on the current computer, two options will be available. **Activate with current key** will be selected by default and the first five characters of the current product key will display.
- To activate a different license instead, select **Activate with new key** and enter a different product key in the text field.
- Click the **Activate** button to launch the program. Not available unless a valid product key has been entered.

If your product key is not associated with a User Account on our web site, the **Create Chief Architect Account** dialog will open next. So that you can take full advantage of our online resources, click the **Register License** button and take a moment to associate your software license with a User Account on our web site. See “Creating a Chief Architect Account” on page 17.

Migrating Settings and Content

If you have Home Designer Architectural version 2014 through 2019 installed on your computer, the **Migrate Settings** dialog will open after you activate the license, allowing you to

migrate Preference settings, toolbars, library content, and more for use in Home Designer Architectural 2020. If multiple legacy versions are present on the system, only the data associated with the most recent will be migrated. See “Library Content” on page 405.

Migrate Settings Dialog

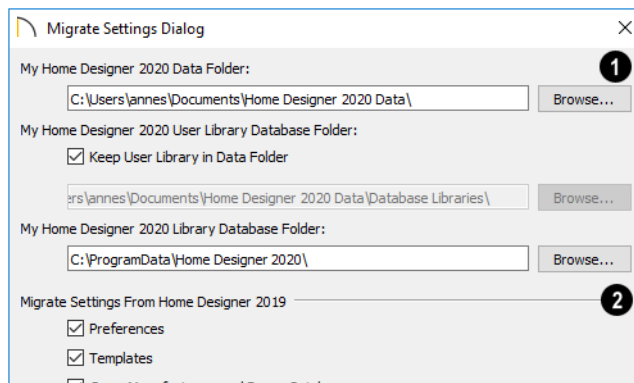

1 Folder Locations -

- The full pathname of the **My Home Designer Architectural 2020 Data Folder** is listed here. The default location for the Data folder is in your Documents directory. Type a new pathname or click the **Browse** button to select a new location if you wish. See “Home Designer Architectural Data” on page 43.
- The full pathname of the **My Home Designer Architectural 2020 Library Database Folder** is listed here. The default location for this folder is in the directory intended for shared application data in your operating system (C:\ProgramData in Windows; /Library/Application Support in macOS). Type a new pathname or click the **Browse** button to select a new location if you wish. See “Library Content Location” on page 406.
- The full pathname of the **My Home Designer Architectural 2020 User Library Database Folder** is listed here. The default location for this folder is in your Data folder. Type a new pathname or click the **Browse** button to select a new location if you wish. See “Home Designer Architectural Data” on page 43.

2 Migrate Settings from - The program version that settings will be migrated from is stated at the end of this heading. Check the box beside each category of settings or content that you would like to migrate into the current program version:

- **Hotkeys.** See “Hotkeys” on page 79.
- **Preferences.** See “Preferences Dialog” on page 67.
- **Templates.** See “Template Plans” on page 44.

- **Toolbars.** See “Toolbar Arrangement” on page 77.
- **Core, Manufacturer, and Bonus Catalogs.** See “Library Content” on page 405.
- **User Catalog.** See “The User Catalog” on page 405.

Click OK to migrate the selected data. When the migration is complete, a message will indicate whether there were any errors during the migration process and give you an opportunity to review the Migrate Settings Log. If you encounter an error, contact Chief Architect Technical Support for assistance. See “Contacting Technical Support” on page 616.

Program Updates

From time to time, Chief Architect releases Home Designer Architectural program updates that are available for download free of charge from the Home Designer Architectural web site, HomeDesignerSoftware.com.

When a program update is available, this dialog will display when the program is opened:

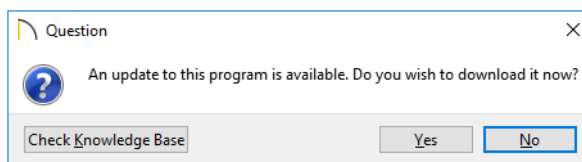

- Click **Yes** to open your default Internet browser to the **Program Updates** section of the Home Designer Web site.
- Click **No** to launch Home Designer Architectural.

At any time, you can select **Help > Download Program Updates** from the Home Designer Architectural menu to launch your default Web browser to the [Program Updates](#) section of the Home Designer Web site.

Program updates are not patches: when an update is installed, the previous version is uninstalled and then the new version is installed. Library content, Preference settings, and information saved in the program’s Data folder are not affected by program updates.

Creating a Chief Architect Account

Your online Chief Architect Account allows you to take advantage of a variety of valuable resources on our web site including catalog downloads, license management, and technical support. See “Chief Architect Account Login” on page 528.

There are two ways to create an account:

- If your product key is not associated with an account on our web site, the **Create Chief Architect Account** dialog will open when you activate your license. Click the **Register License** button in this dialog.
- Select **Help > Create Chief Architect Account**.

Installing on Multiple Computers

A license of Home Designer Architectural can only be active on one computer at any given time. If you have been running the software on one computer and wish to run it on a different computer, or if you wish to rename your computer, you must deactivate your license first.

For details, please refer to the **End User License Agreement**, found in both the program's installer and the Help.

 An active Internet connection is required to deactivate a Home Designer Architectural license.

To deactivate a Home Designer Architectural license

1. Launch Home Designer Architectural on the computer where the license is active.
2. Select **Help > Manage License** from the menu.
3. The Manage License dialog confirms that you wish to deactivate the license. Click **Yes**.
4. After a pause, the program will close.

License activations can also be deactivated in your User Account on our web site, HomeDesignerSoftware.com

To manage license activations online

1. Log in to your User Account on our web site, HomeDesignerSoftware.com.
2. Browse to your **Digital Locker: Software Downloads and Product Keys** page.
3. Click the link to **Manage your Active Licenses**.
4. Click the **Turn Off** button to deactivate your license on the computer where it is currently active, making it available for use on another computer.

Uninstalling Home Designer Architectural

Home Designer Architectural can be removed from a Mac by moving it to the Trash. This does not deactivate the license, however, so you may want to deactivate your license before removing the program.

On a Windows® computer, there are two ways that Home Designer Architectural can be removed: from the Control Panel and using the Setup Wizard on the program disk. Please note that if you do not have an active Internet connection, your license will not become deactivated.

To remove the program using the Windows Control Panel

1. Open the Windows Control Panel.
2. Double-click Programs.
3. Find Home Designer Architectural and click **Uninstall**.

To remove the program using the Setup Wizard

1. Launch your downloaded program installer or place the USB drive in a port and select **Install** Home Designer Architectural from the Home Designer Architectural startup window.
2. On the Setup Maintenance page, select **Uninstall** and click **Next**. A message will display, asking if you would like to remove the selected application and its components.
3. Click **Yes** to remove Home Designer Architectural.

When Home Designer Architectural is uninstalled, neither the Home Designer Architectural Data folder nor the library content is removed from the system. See “Home Designer Architectural Data” on page 43 and “Library Content” on page 405.



If an emergency forces you to reformat your hard drive, reinstall your operating system, or resort to a system restore point, be aware that none of these actions result in a normal program uninstallation or license deactivation.

House Design Tutorial

This House Design Tutorial shows you how to get started on a design project. The tutorials that follow continue with the same plan. When you are finished, you will have created a sample plan named “Stucco Beach House.” You can then apply the tools and techniques learned to your own plans.

In this tutorial you will learn about:

- Before You Begin
- Getting Started
- Setting Defaults
- Drawing Walls
- Creating Dimension Lines
- Adjusting Wall Positions
- Creating Rooms
- Creating a 3D View
- Adding Floors
- Adding Stairs
- Placing Doors and Windows

Before You Begin



Home Designer Architectural may look differently on your screen than it does in the following tutorials.

- Screen captures are taken from a smaller window to optimize image quality, so the size and proportion of your interface may be different.
- Some features, such as the Reference Grid, have been turned off to optimize image quality. For more information, see “General Plan Defaults Dialog” on page 66 of the Reference Manual.
- As the program is updated, features may be added or removed. If you are using the latest version of Home Designer Architectural, you may see buttons and/or menu items that have been added or removed since this tutorial was written. For more information, see “Program Updates” on page 17.
- Depending on your operating system and system settings, dialogs and toolbars may appear differently than they do in the tutorials.



Getting Started

Begin by opening a new, blank plan.

To begin a new plan

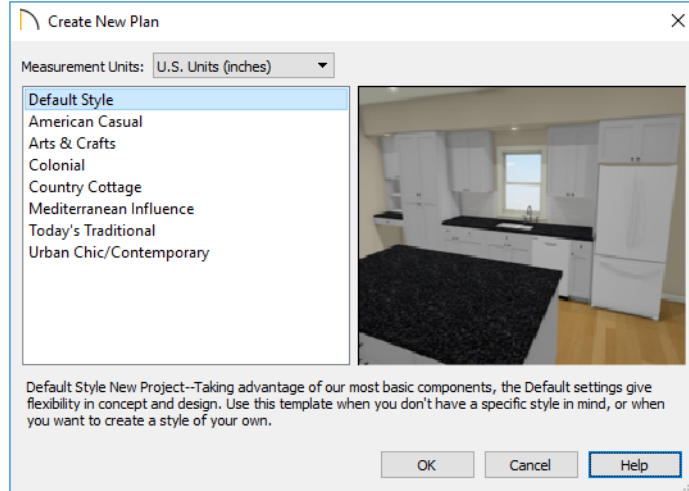
1. When Home Designer Architectural launches, the **Getting Started** dialog displays. For more information, see “Startup Options” on page 22 of the Reference Manual.
 - Select **New Plan**  to open a new, blank plan.
 - You can also select **File> New Plan**  to open a new, blank plan.
 - For more information, see “File Management” on page 41 of the Reference Manual.
2. The **Create New Plan** dialog displays next.



3. Home Designer Architectural includes a selection of Home Style template plans, each with different default settings that allow you to begin working in a particular plan style quickly. The **Default** template and **U.S. Units** are selected by default. Click **OK**. The floor plan view window opens, ready for you to begin drawing.
4. You should begin work on any new file by giving it a name. To do this:
 - Select **File> Save**  from the menu to open the **Save Plan File** dialog.
 - Specify the location on your computer where you would like to save the plan.
 - Type a name for your plan.
 - Click **Save**.
5. It is a good idea to save your work on a regular basis as you proceed. To do this, you can:
 - Select **File> Save**  from the menu to open the **Save Plan File** dialog.
 - Click the **Save**  button on the toolbar.
 - Type **Ctrl + S** on your keyboard.

For more information about saving files, see “Saving, Exporting, and Backing Up Files” on page 46 of the Reference Manual.

Setting Defaults

Default settings determine the initial characteristics of objects when they are first drawn. When set up in advance, they can help you both save time and avoid mistakes. Before you draw walls and create rooms, therefore, you should always make sure the defaults will meet your needs for the current project. For more information about defaults, see “Preferences and Default

Settings” on page 63 of the Reference Manual.

While all defaults are important, there are several that are particularly helpful to be aware of because they help determine the size and structure of the building.

To access a file's default settings

1. Select **Edit> Default Settings**  to open the **Default Settings** dialog.
2. Click on the arrow next to a category to expand it and show its contents.
 - Click on the arrow again to collapse the category.
3. Select a defaults dialog that you would like to open and click the **Edit** button.
 - You can also open the defaults dialog by double-clicking on a line item.

Floor Defaults

The **Floor Defaults** dialogs let you set the default floor and ceiling heights and room moldings for each floor. For more information, see “Floor Defaults Dialog” on page 334 of the Reference Manual.

To set the Floor Defaults

1. In the **Default Settings** dialog, select "Current Floor" from the list and click the **Edit** button to open the **Floor Defaults** dialog for the current floor.
 - Click the arrow to the left of "Floors and Rooms" to expand the category.
 - Expand the "Floor Levels" subcategory as well.
 - Select "1st Floor" and click the Edit button.
2. On the **STRUCTURE** panel, note the **Ceiling Height**. The initial value is 109 1/8” (inches). Leave this value unchanged for this tutorial.
3. Click **OK** to close the **Floor Defaults** dialog.

To reset the Floor Defaults

1. Select **Edit> Reset to Defaults**.
2. Under **Reset Scope**, choose either a particular floor, or **All Floors**.
3. Click **OK** and floor and ceiling heights for any room that was changed in the Room Specification dialog will be restored to the Floor default values.

Wall Defaults

The **Wall Defaults** dialogs let you specify the thickness, materials, and other characteristics of the walls that are drawn by each of the Wall Tools. For more information, see “Wall Type Definitions” on page 177 of the Reference Manual.

To set the Wall Defaults

1. In the **Default Settings** dialog, click on the arrow next to "Walls", select "Exterior Wall" and click the **Edit** button.
2. For this tutorial, go to the WALL TYPES panel, select "Stucco-6" from the **Wall Type** drop down list and click OK.

Dimension Defaults

Dimension lines are important for both positioning walls and other objects and for annotating your drawing. It is a good idea, therefore, to specify how you want dimensions to locate objects as well as their appearance before you begin drawing.

To set the Dimension Defaults

1. In the **Default Settings** dialog, click on "Dimension" and click the **Edit** button.

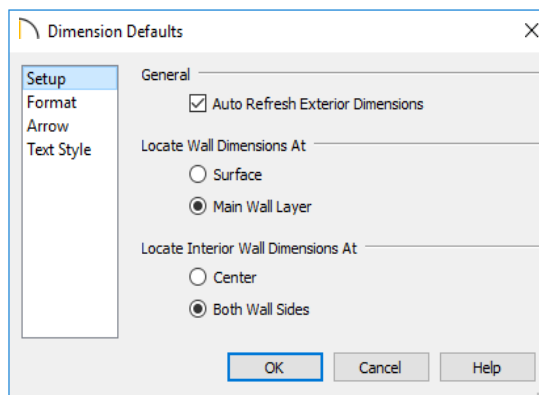

2. Review each of the panels and settings available for setting up your Dimension Defaults.
3. For more information, see “Dimension Defaults Dialog” on page 215 of the Reference Manual.

You may want to review some of the other available defaults when setting up your template. For example, you can modify your Cabinet defaults, where you can set up your materials for Base, Wall and Full Height Cabinets so that any future cabinets placed in the plan will initially use these default settings.

Drawing Walls



Once your defaults are set, a new drawing can be started by drawing some exterior walls. When drawing walls, do not try to size or position them precisely - they can be more easily positioned

after they are created. For more information, see “Walls, Railings, and Fencing” on page 153 of the Reference Manual.

To draw exterior walls

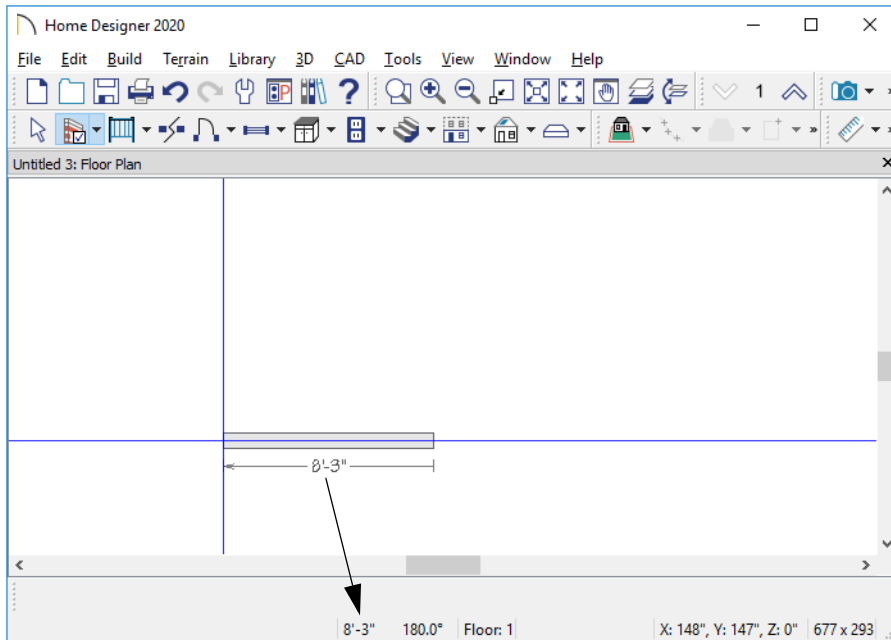
1. When drawing a structure's perimeter walls, it is recommended that you make sure **Grid Snaps** are turned on. You may choose to disable them, though, once the shell walls are in position. See “Snap Behaviors” on page 90 of the Reference Manual for more information.
 - Select **Build> Wall> Straight Exterior Wall**  from the menu or click the corresponding toolbar button, then click and drag from left to right to draw a wall.
2. There are a few things to make note of as you draw a wall.
 - The wall's length displays in two places: above the wall and in the Status Bar at the bottom of the screen. Its angle is also shown in the Status Bar:



- Wall angles are restricted to increments of 15° when **Angle Snaps**  are on. In most instances, this makes drawing straight walls easy and is desirable; however, you can toggle Angle Snaps on and off by selecting **Edit> Snap Settings> Angle Snaps**  or pressing the F10 key. See “Snap Behaviors” on page 90 of the Reference Manual for more information.

3. Continue drawing walls, creating a rough outline of the building's exterior, as shown in the following image.
 - Exact dimensions are not important yet, but keep the final size of the structure in mind as you draw. The overall lengths of this building's sides are 41' x 39'6".
 - It is helpful to draw exterior walls in a clockwise direction to ensure the proper orientation of wall surfaces.
 - When the walls enclose an area completely, a Living Area label is created. See "Living Area" on page 201 of the Reference Manual.
4. When your walls completely enclose an area, a roof will automatically be generated. For the purposes of this tutorial, this roof can be removed. Select **Build> Roof> Delete Roof** . When asked if you want to turn **Auto Rebuild Roofs** off, click Yes.

Note: The "Auto Rebuild Roofs" and "Auto Refresh Exterior Dimensions" options have been turned off in this tutorial to simplify the display of the building in floor plan view. For more information, see "Build Roof Dialog" on page 375 of the Reference Manual.

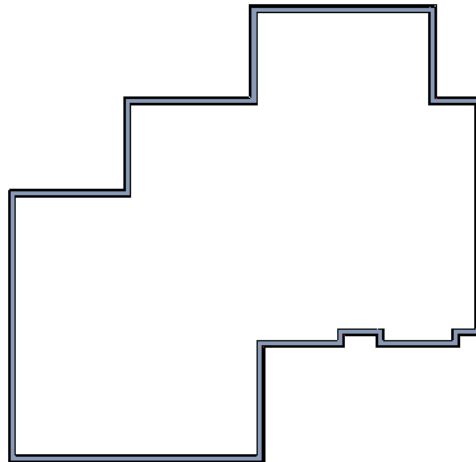



Interior walls are drawn the same way that exterior walls are.

To draw interior walls

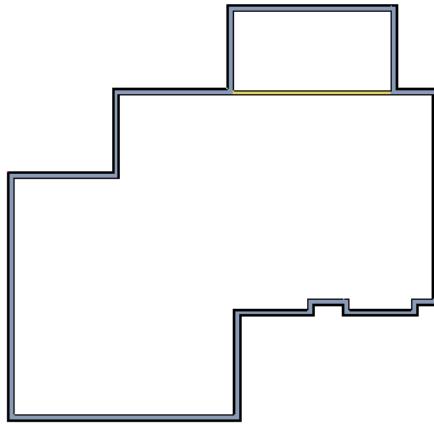
1. Select **Build> Wall> Straight Interior Wall**  from the menu or click the corresponding toolbar button.
2. Draw an interior wall as shown in the following image.



To delete a wall

1. While the **Select Objects**  tool is active, click on a wall with the pointer to select it.
2. Press the **Delete** key or click the **Delete**  edit button.

Creating Dimension Lines



Dimension lines locate walls, openings in walls, and other objects. In Home Designer Architectural, you can generate two types of automatic dimension lines and draw a variety of manual dimensions and Interior Dimensions. For more information, see “Dimensions” on page 215 of the Reference Manual.

To create automatic exterior dimension lines

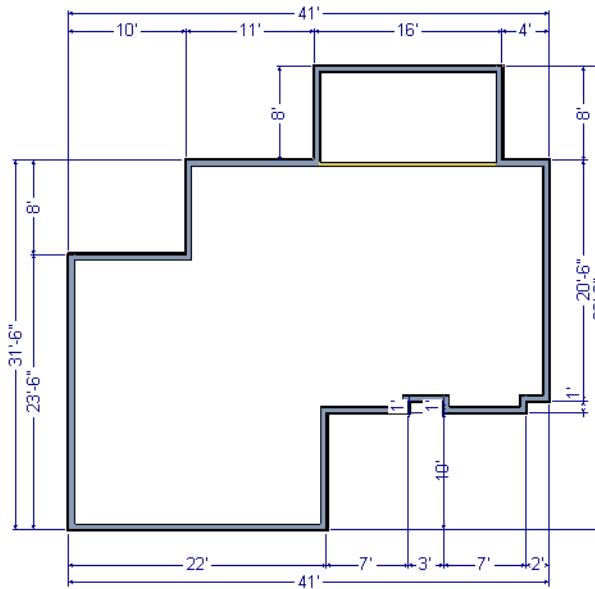
1. Select **CAD > Dimensions > Auto Exterior Dimensions** .



LIVING AREA
1145 sq ft

2. For a closer view of a certain area, click the **Zoom**  tool, click and drag a box around the area you want to see in detail, and release the mouse button. That area fills the screen. For more information, see “Window and View Tools” on page 81 of the Reference Manual.
3. To return to the previous zoom factor, select **Window> Undo Zoom** .
4. If you can't see all the exterior dimension lines at once, select **Window> Fill Window Building Only**  to center your plan on screen.

To draw an interior dimension line

1. Select **CAD> Dimensions> Interior Dimension** .
2. Click and drag a line that intersects the interior wall and other walls you want to locate.

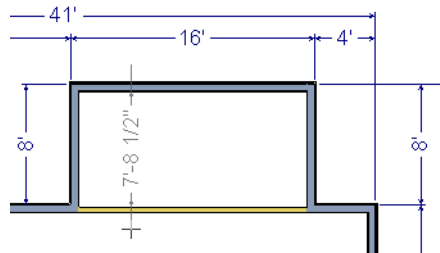

3. Notice that Interior Dimension lines locate the interior side of exterior walls, while other types of dimension lines locate the exterior side.

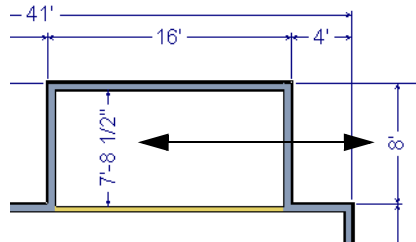



Note: Interior Dimensions locate the Main Layer framing layer of walls by default rather than wall surfaces. See "Wall Type Definitions Dialog" on page 179 of the Reference Manual. This and other options can be changed in the Dimension Defaults dialog. See "Dimension Defaults Dialog" on page 215 of the Reference Manual.

Adjusting Wall Positions

With the perimeter walls in place, you can adjust their position with precision. There are several ways to do this, but the fastest and most accurate uses dimension lines. For more information, see “Moving Objects Using Dimensions” on page 224 of the Reference Manual.

To move walls using dimensions

1. Begin by selecting **Window > Fill Window Building Only**  so the entire building can be seen.
2. Click the **Select Objects**  button, then click on a wall that you want to move.
3. Click on a dimension line that indicates how far the selected wall is from another wall. There are a couple of ways to determine which dimensions can be used for this purpose:
 - Move the selected wall and see which dimensions update.
 - Move your pointer over a dimension. If it is an associated dimension, the icon will change to a Pointing Hand .

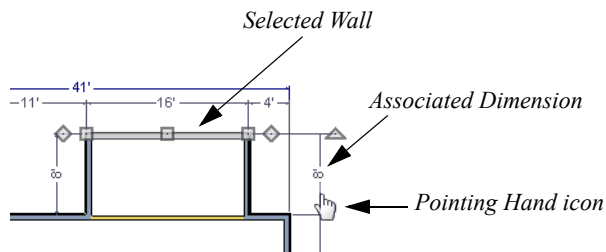

4. With the Pointing Hand icon visible, click on the associated dimension and enter a new value.
 - Remember: Type an apostrophe to denote feet and quotes to denote inches.
 - If neither apostrophes nor quotes are included, inches will be used.
5. Press the Enter key on your keyboard to move the wall to the newly specified distance.
6. Repeat this process for the adjacent exterior wall, continuing in a clockwise direction.



When using dimensions to reposition walls, you should always work in the same direction, adjusting one wall section after another.

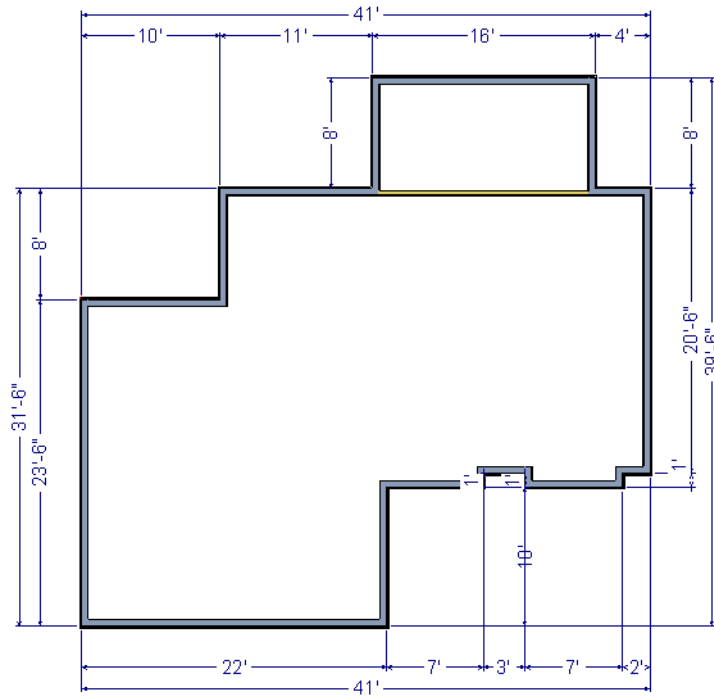

When you are finished, your dimensions should match those in the following image:



Dimensions can also be used to change the length of a selected wall. Bear in mind, though, that the when a wall is resized in this manner its Start point will always be locked and its End point will always be moved. Because of this, it is often easier to move walls than to resize them. See “Editing Walls” on page 170 of the Reference Manual.

When your exterior walls are in position, you may find it helpful to delete the dimensions.

To delete all dimensions at once



1. Select **Edit > Delete Objects**  to open the **Delete Objects** dialog. See “Delete Objects Dialog” on page 135 of the Reference Manual.
2. Select the **All Rooms On This Floor** radio button, then under the CAD heading:
 - Check **Manual Dimensions** to delete manually-drawn dimension lines such as those drawn by the **Interior Dimension**  tool;
 - Check **Automatic Dimensions** to delete automatically generated dimension lines such as those created by the **Auto Exterior Dimensions**  tool;
 - Click the **Delete** button, then **Done**.

If you delete Automatic Dimensions, **Auto Refresh Exterior Dimensions** will be turned off. You can turn this feature on again whenever you want in the **Dimension Defaults** dialog. See “Dimension Defaults” on page 25 of the Reference Manual.

Although using dimensions is generally the fastest and most accurate way to move walls, you can also move them using their edit handles and edit tools.

To move walls using their edit handles

1. Click the **Select Objects**  tool then click on an exterior wall to select it.
2. Click and drag the Move edit handle that displays at the position along the wall where you clicked. Walls can be moved perpendicular to the direction that they are drawn.
3. As you move the wall, the dimension lines that indicate how far it is from other walls will update.

If you have difficulty positioning a wall at a particular location, try zooming in on it using either the **Zoom**  or **Zoom In**  tool or by scrolling with your mouse wheel. You can also use the arrow keys on your keyboard to nudge a selected wall up, down, left, or right on-screen.

Creating Rooms

When the exterior walls enclose an area, a single, large room is created. Once the exterior walls are in position, you can add interior walls and to create multiple rooms. Rooms can be assigned a Room Type that applies attributes such as flooring that are typical of that type of room. For more information about rooms, see “Room Types” on page 195 of the Reference Manual.

To define rooms using interior walls

1. Select **Build> Wall> Straight Interior Wall** , then click and drag to draw interior walls. As with exterior walls, you don't need to worry about exact placement as you draw.

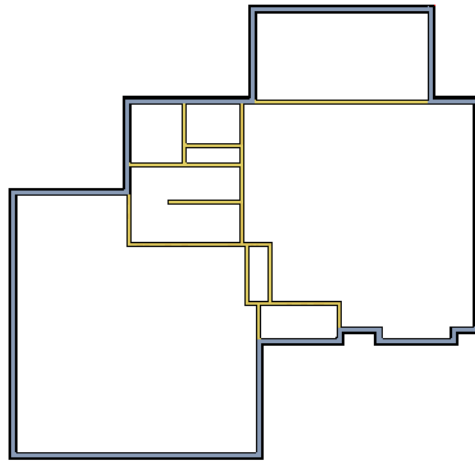

2. Select **Build> Wall> Break Wall**  and click to place two breaks at the locations shown in the following image.

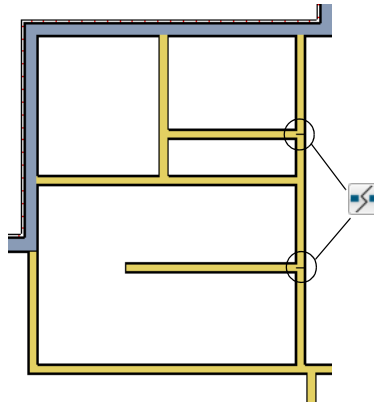

3. Click the **Select Objects**  button, then select the top wall section created by the breaks and delete it. Repeat this process for the bottom wall section, so that only the middle section remains, which is hatched in the image below for illustrative purposes.

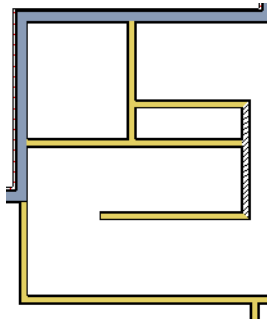

4. Draw a horizontal **Interior Dimension**  inside this new room, then use it to move the vertical interior wall 9' 7 3/4" from the opposing exterior wall.

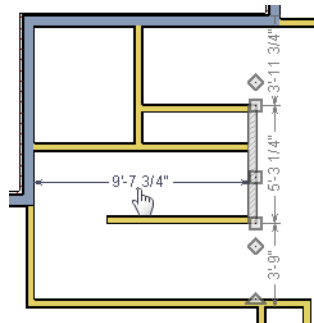

To change a wall's type

1. Select a wall with the incorrect wall type and click the **Open Object**  edit button to open the **Wall Specification** dialog. See “Wall Specification Dialog” on page 181 of the Reference Manual.
2. On the GENERAL panel, click the **Wall Type** drop-down list and select the desired wall type.
3. Click **OK** to close the dialog and change the selected wall to the chosen wall type. Repeat this process for each of the walls that you want to change, as in the image below.

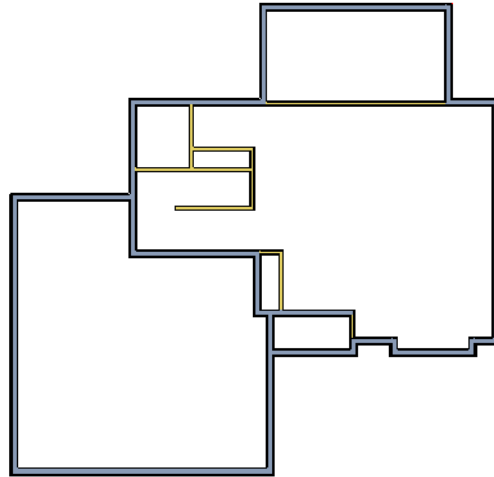





Using Room Dividers

In reality, rooms are not always divided by a physical wall. The separation of two rooms may be marked by a change in the flooring (carpet to tile, for example), or by a change in the interior wall covering. In Home Designer Architectural, a Room Divider or invisible wall can be used to define rooms without creating an actual wall. For more information, see “Room Dividers and Invisible Walls” on page 161 of the Reference Manual.

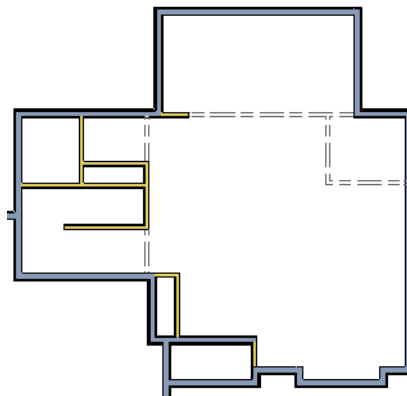
To create a room divider

1. Select **Build> Wall> Room Divider**  and draw Room Dividers as shown in the following image.



- Using the **Select Objects**  tool, select one of the Room Dividers, and click the **Open Object**  edit tool. On the GENERAL panel of the **Wall Specification** dialog, note that **Invisible** and **No Locate** are checked.
- Uncheck **No Locate** and click **OK**. When No Locate is selected, it will prevent dimensions from locating the wall.
- Adjust the wall spacing of the interior, exterior, and Room Divider walls using **Interior Dimensions** , just as you did with exterior walls, to match the following image:

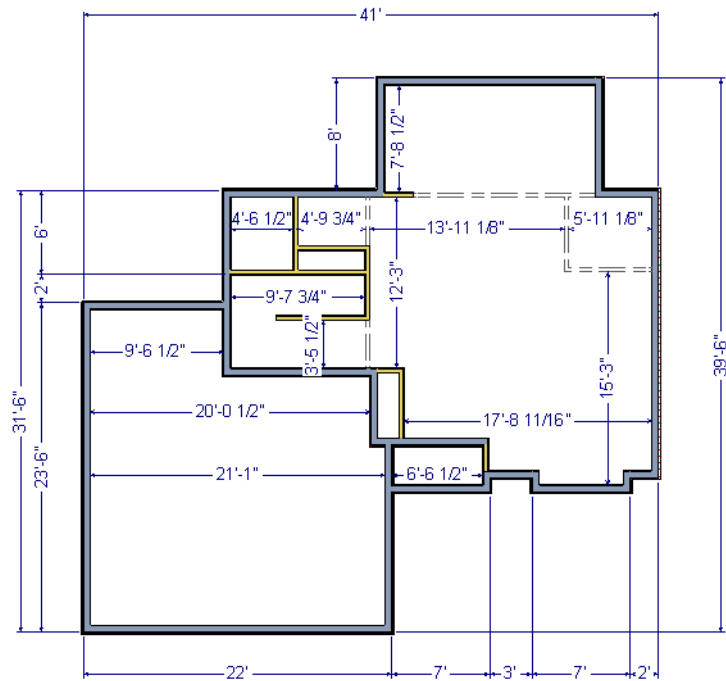

Room Types

Rooms in Home Designer Architectural are given special attributes when they are assigned a Room Type. For example, porches use a concrete floor material and have a ceiling and roof, while decks use floor planking and have no ceiling or roof. For more information, see “Rooms” on page 193 of the Reference Manual.

To designate a Room Type for a room

- Click the **Select Objects**  button, then click in the small room at the bottom of the plan.

2. Click the **Open Object**  edit button to open the **Room Specification** dialog.
3. On the GENERAL panel, click the **Room Type** drop-down list and select **Entry**.

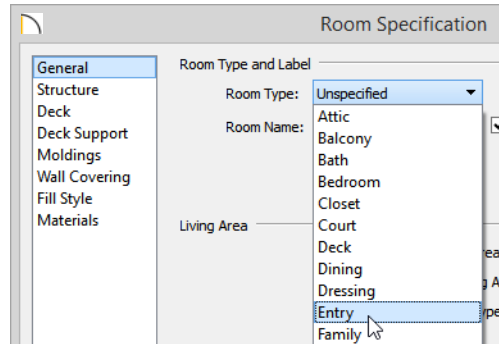

4. Click **OK** close the dialog and apply your change.

Double-clicking inside of a room when the **Select Objects**  tool is active will also open the **Room Specification** dialog. For more information, see “Room Specification Dialog” on page 208 of the Reference Manual.

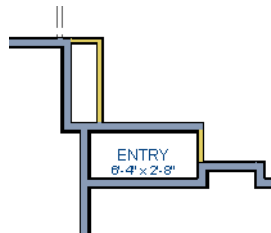

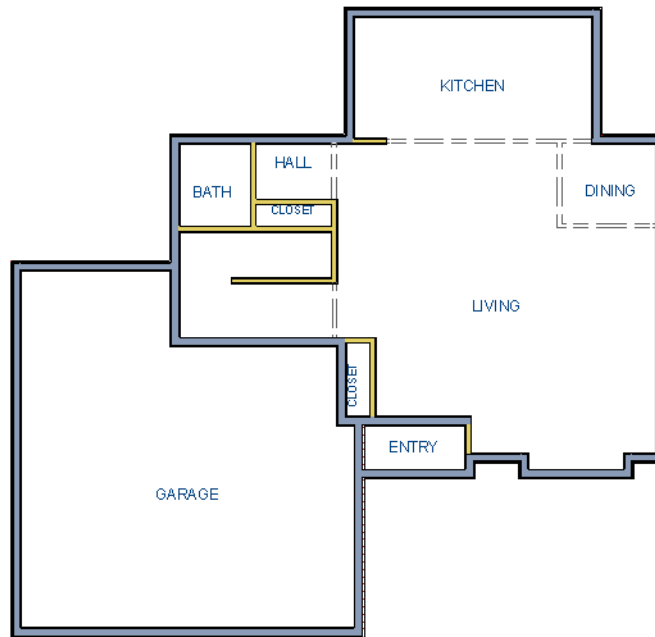

5. Open each of the rooms and assign room types as shown in the following image.





Creating a 3D View

You can create a 3D view of the model to see how it looks so far. For more information, see “3D Views” on page 459 of the Reference Manual.

To create a camera view

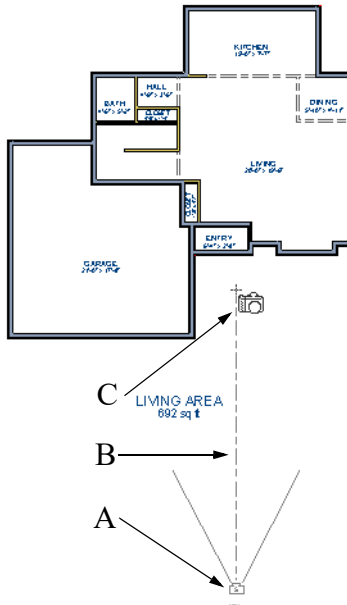
1. In floor plan view, click the **Fill Window**  button to zoom out as needed to fill the view window with the entire drawing.
2. Select **3D> Create Camera View>Full Camera**  (or press Shift + J).
3. Click at the bottom of the floor plan view window and drag a line that stops at the Entry. The point where you click (A) defines the point of perspective and the line (B) defines the direction of perspective.



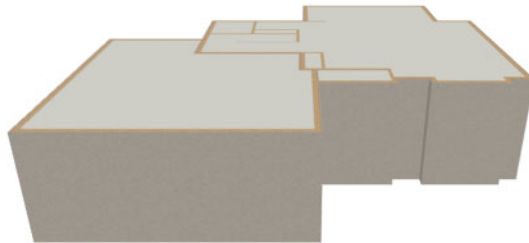

4. Release the mouse button to create the 3D camera view. Where the mouse is released (C) is the camera's focal point.
5. You can use the **Mouse-Orbit Camera**  tool to change the camera's perspective. The camera will revolve around its focal point (C). See "Repositioning Cameras" on page 467 of the Reference Manual for more information.



6. To return to floor plan view, select **File> Close** from the menu.

To create a Doll House View

1. In floor plan view, select **3D> Create Camera View> Doll House View** . A Doll House View displays the floor without a ceiling or roof.
2. Select **3D> Move Camera With Mouse> Mouse-Orbit Camera**  (which should be selected by default) then click and drag the mouse on screen to change the camera perspective. You can press the I (in) and the O (out) keys on the keyboard to zoom in and out of the plan. For more information on modifying camera views, see “Editing 3D Views” on page 473 of the Reference Manual.



Adding Floors

Creating new floors in a plan is easy, but it is best to do so only after the first floor plan has been finalized. With this first floor of this plan completed, you can now add a second story and basement. For more information about working with multiple floors, see “Multiple Floors” on page 333 of the Reference Manual.

To add a second floor

1. Select **Build> Floor> Build New Floor** . The **New Floor** dialog displays.
2. Select **Derive new 2nd floor plan from the 1st floor plan** and click **OK** to close the **New Floor** dialog to display the Floor 2 Defaults. You could also create a blank second floor plan and then draw the second story walls manually; however, it is usually faster to automatically generate the perimeter walls and then edit them as needed.
3. Click **OK** and a floor plan for the second floor is created based on the exterior walls of the first floor plan. The second floor perimeter walls will now require some editing. It will be

difficult to know where the second story walls should be without knowing where the first floor walls are located.

4. Select **Tools> Reference Floors> Floor Reference Display**  or press the F9 key. The first floor walls are displayed for reference.

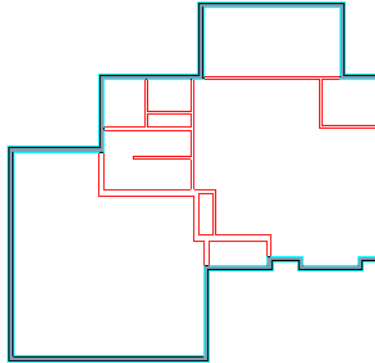

To merge two parallel walls into one

1. Select the topmost horizontal wall, then click and drag its Move edit handle to move it.
2. When the wall becomes aligned with another wall and can merge with it, it will stop at a "sticky point."
3. Release the mouse button. Note that if you keep dragging the mouse, the wall will break free of the sticky point and you can continue moving it.

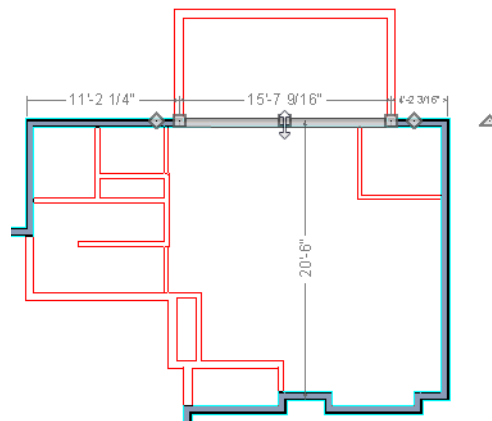

4. When you select the wall now, notice that the edit handles are located along its full length.

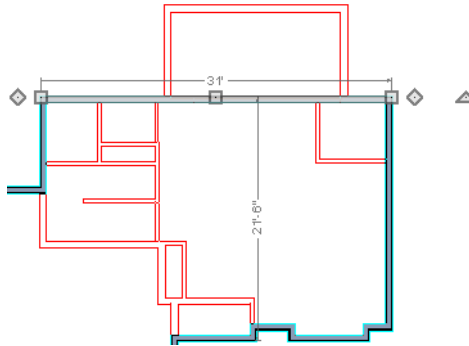

Note: Before merging walls, make sure Object Snaps are turned on. For more information, see “Object Snaps” on page 90 of the Reference Manual.

Use the techniques described above and in “Drawing Walls” on page 25 and “Adjusting Wall Positions” on page 31 to create exterior walls as shown in the following image:

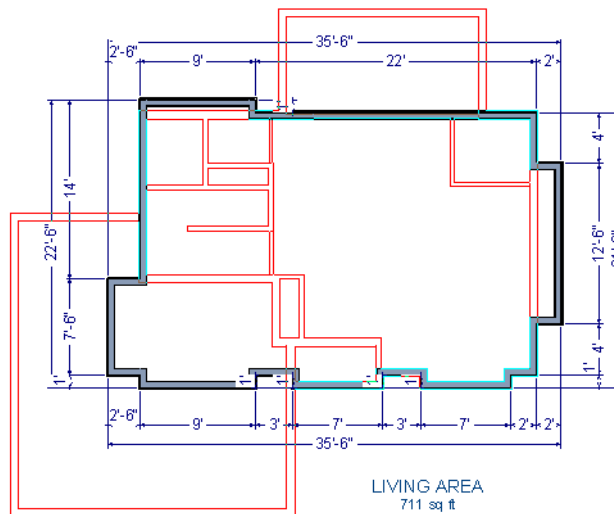



5. Remember to **Save**  your plan as you work.

To create a foundation or basement

1. Select **Build > Floor > Build Foundation** . In the **Build Foundation** dialog:

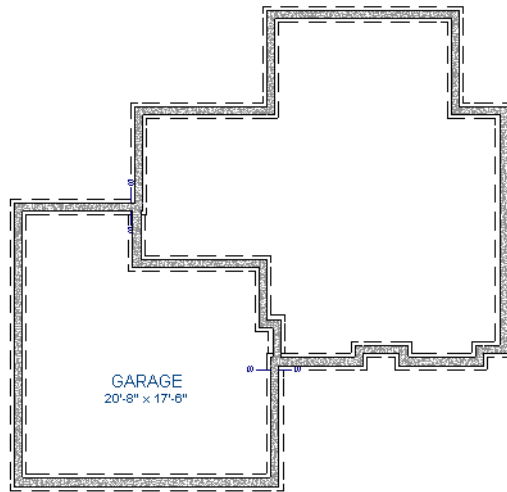
- Change the **Wall Height** to 100 inches.
 - Click **OK** to close the dialog and create a foundation level for your plan.
2. Select **Derive New Foundation Plan From the First Floor Plan** and click **OK** to close the **New Floor** dialog. For more information, see “Adding Floors” on page 335 of the Reference Manual.
 3. You can select **Window> Fill Window Building Only**  from the menu to center the plan on screen.



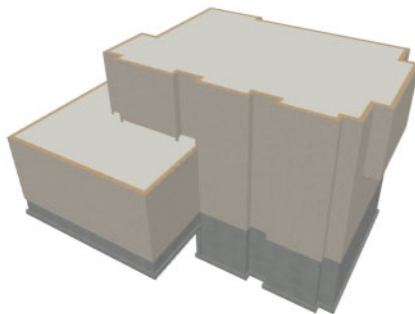

4. Select **3D> Create Camera View> Perspective Full Overview**  to create an exterior 3D overview of the entire plan so far.



To add a second story balcony

Now that a second floor has been created, the tools and techniques described earlier can be used to add a second story balcony that is aligned with the floor below.





1. Press Ctrl + Tab on your keyboard to switch back to floor plan view and return to Floor 2.
2. If they are not already displayed, select **Tools> Reference Floors> Reference Floor Display**  or press the F9 key to display the positions of the first floor walls on Floor 2.
3. Select **Build> Railing and Deck> Straight Railing** .

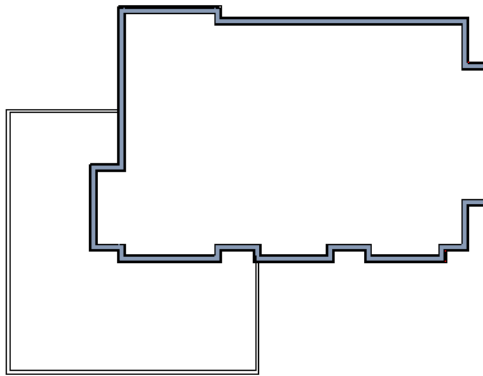

For best results, do not use the Deck Railing tool or specify the balcony room as a Deck.

4. Draw a balcony as shown in the following image:



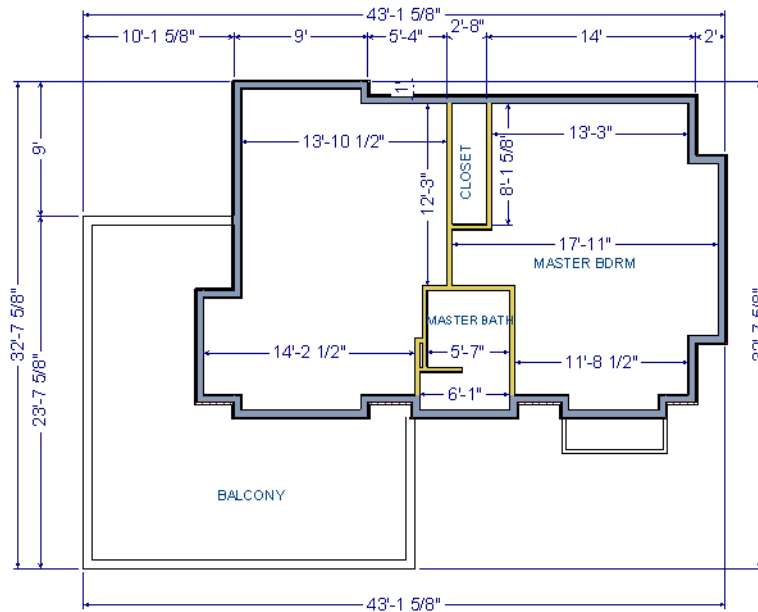

5. If **Object Snaps**  are on, the second story balcony railing will likely snap into alignment with the walls on Floor 1 as they are drawn. If not, you can manually align them:
 - With a railing selected, click the **Align with Wall Below**  edit button.
 - If **Align with Wall Below**  is not available, the selected railing either needs to be moved closer to the wall below, or the railing is already aligned with the one below. See “Aligning Walls” on page 173 of the Reference Manual.
6. Use the **Select Objects**  tool to select one of the railings, then click the **Open Object**  edit button. On the GENERAL panel of the **Railing Specification** dialog, increase the Thickness to 8 1/8” and click **OK**.
7. Repeat these steps for each section of railing that has a wall directly below it on Floor 1.
8. Finally, add interior walls to the second floor. When you are finished, it should look similar to this:



Adding Stairs

Now that the structure has three floors, it will require stairs. For more information about stairs, see “The Stair Tools” on page 342 of the Reference Manual.

To draw stairs with a landing

1. Click **Down One Floor**  to go to the first floor. You may want to press F9 to turn off the **Reference Floor Display** .
2. Select **Build> Stairs> Draw Stairs**  (or press Shift + Y).
3. Click and drag to draw a short stair section from right to left, as shown in the following image:

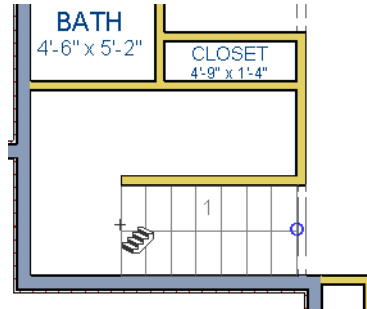

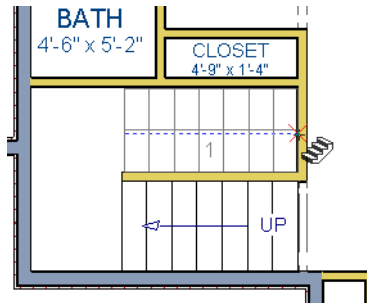

4. Draw another stair section from left to right, directly above the first:



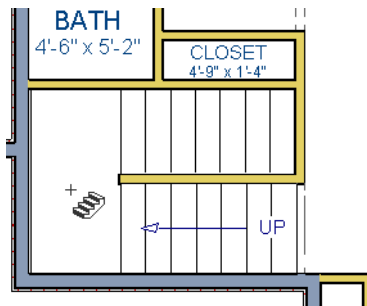

5. While the **Draw Stairs**  tool is still active, click in the space to the left of the two stair sections to create a landing.





6. Click on the landing with either the **Draw Stairs**  or **Select Objects**  tool active, and if needed, resize it using its edit handles to fit it against the wall.

A stairwell is simply an interior room that has been assigned the Room Type “Open Below”. See “Room Specification Dialog” on page 208 of the Reference Manual.

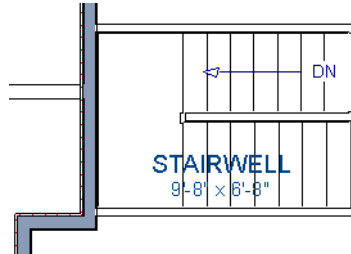

To create a stairwell

1. Select either of the two stair sections.
2. On the edit toolbar, click the **Auto Stairwell**  button to create a stairwell.
3. Click the **Up One Floor**  button to go to Floor 2. Notice that there is now a stairwell room defined by railings directly above the stairs on Floor 1.





It makes sense to draw the basement stairs directly below the stairs to Floor 1. The **Auto Stairwell**  edit tool could be used to create another stairwell; however, in this situation, it will be better to use the existing interior walls to define the stairwell, rather than by the railings that the Auto Stairwell tool generates.

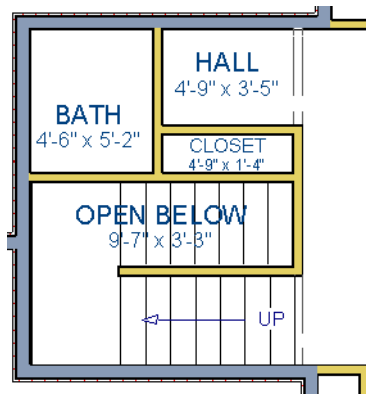

To manually create a stairwell

1. Click the **Down One Floor**  button to go down to Floor 1.
2. Next, click on a stair section inside of the stairwell room and click the **Select Next Object**  edit button as many times as needed until the room is selected instead of the stair.
3. With the room selected, click the **Open Object**  edit button and in the **Room Specification** dialog, select "Open Below" from the **Room Type** drop-down list and click OK.



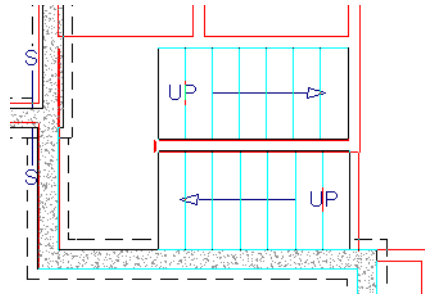

4. Go **Down One Floor**  to the foundation (Floor 0) level, and press F9 to turn on the **Reference Floor Display** .
5. Select **Build> Stairs> Draw Stairs**  and draw two stair sections directly below the stairs you drew on Floor 1. Do not draw the landing just yet, though.

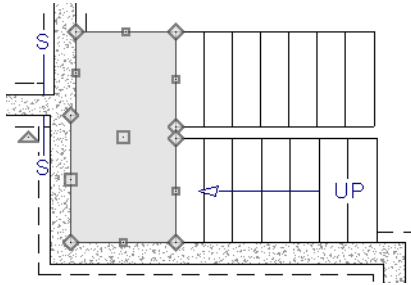

6. Select each stair section and adjust its width and position using its edit handles so that it fits within the walls forming the stairwell drawn on Floor 1.
7. When the stair sections are positioned properly, click with the **Draw Stairs**  tool to create a landing as you did on Floor 1.
8. Next, use the **Select Objects**  tool to select the landing, click the **Break Line**  edit button, and click along the landing's edge to place a break. This divides the edge into two sections with a corner handle between them, allowing you to reshape it so that it fits against the foundation walls.



9. Select **3D> Create Camera View> Perspective Full Overview**  to create an exterior 3D view of your plan.
10. When the 3D view has generated, select **3D> Rendering Techniques> Glass House**  to view the entire model inside and out with partially transparent surfaces.
11. Select **3D> Move Camera With Mouse> Mouse-Orbit Camera**  and click and drag the mouse on screen to change the camera perspective. You can press the I (in) and the O (out) keys on the keyboard to zoom in and out of the plan.

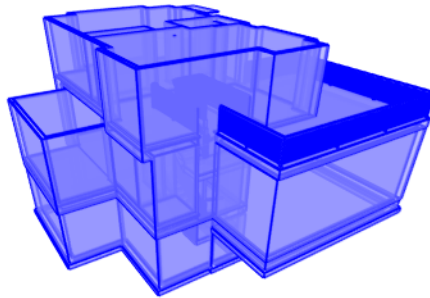

Placing Doors and Windows

Now is a good time to add some doors and windows to the model. For more information about doors and windows, see “Doors” on page 243 of the Reference Manual and “Windows” on page 261 of the Reference Manual.

To add a door

1. If your views are still tiled, close the 3D view and maximize the floor plan view.



2. Select **Build> Door> Hinged Door** .
3. Move the pointer to the entry and click on the front wall, left of its center, to place a door.

To add a window

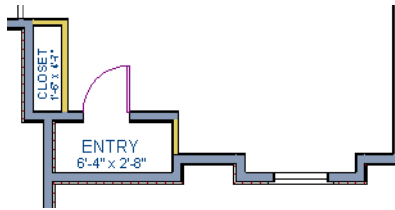
1. Select **Build> Window> Window** .
2. Move the pointer to the entry and click on the wall, right of center, to place a window.



To edit a door

1. To better see the results when the door is edited, create a **Full Camera** , view inside the structure, pointed at the entry.
2. Click the **Select Objects**  tool, then click on the door to select it in the 3D view.



3. Click the **Open Object**  edit button to open the **Door Specification** dialog. For more information, see “Door Specification Dialog” on page 254 of the Reference Manual.
4. On the **GENERAL** panel, set the **Door Style** to "Glass", the **Width** to 36", and the **Panel Frame Bottom** to 8". Press the Tab key to update the preview image on the right side of the dialog so that it reflects your change.

5. On the LITES panel, set the **Lites Across** to 3 and **Lites Vertical** to 5.
6. On the HARDWARE panel, set the Handle **In from Door Edge** to 2".
7. Click **OK** to return to the 3D view.



To edit a window

1. Next, click on the window to select it.



2. Click the **Open Object**  edit button to open the **Window Specification** dialog. For more information, see “Window Specification Dialog” on page 269 of the Reference Manual.
3. On the GENERAL panel, select “Fixed Glass” from the **Window Type** drop-down list and set the **Width** to 54".

4. On the LITES panel, change both the **Lites Across** and **Lites Vertical** to 4.
5. Click OK to close the **Window Specification** dialog.



To save time, make these changes in the Door Defaults and Window Defaults dialogs before doors and windows are placed. For more information, see “Default Settings vs Preferences” on page 64 of the Reference Manual.

To change the door swing

1. Return to floor plan view and select the door.
2. Click the **Change Opening/Hinge Side**  edit button.

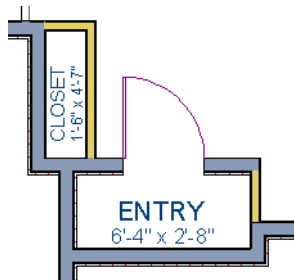



To copy a window or door

1. Return to the 3D view and select the window, or door, you wish to copy.
2. Click the **Copy/Paste**  edit button. For more information about copying objects, see “Copying and Pasting Objects” on page 93 of the Reference Manual.

Doors and windows can be placed, selected, deleted, copied, pasted, and edited in either 2D or 3D views. If there is a window design that you will be using throughout a plan, you can create it once, then just copy and paste it. An even better approach is to set your door and window defaults to the desired settings before placing these objects. For more information, see “Default Settings vs Preferences” on page 64 of the Reference Manual.

To create a doorway

1. Return to floor plan view and **Zoom**  in on the entry room.
2. Select **Build> Door> Doorway**  and click on the front Entry room wall to place a doorway at that location.
3. Select **3D> Create Camera View> Full Camera**  and create an exterior camera view of the doorway.

To customize the doorway

1. Select the doorway by clicking on its frame and click the **Open Object**  edit button to open the **Door Specification** dialog.
2. On the GENERAL panel, change the **Width** to 54" and the **Height** to 96".
3. On the CASING panel, change the **Exterior Casing Width** to 10". Be sure to delete the (D) from the text field. It stands for "default" and if it is not removed, it will continue to apply the default casing width, regardless of the value you specify.
4. Click **OK** to close the **Door Specification** dialog.

To center a wall opening

1. Return to floor plan view and select the doorway.
2. Click the **Center Object**  edit button, then click inside the entry room, near the interior wall containing the doorway.
3. When a dashed centering axis displays in the room, click once to center the door. For more information, see “Using Center Object” on page 128 of the Reference Manual.

Use the tools and techniques you've learned to add window and doors to the rest of the plan, as shown in the following images. Hinged and Sliding Doors placed in interior walls become interior doors and have different specifications than exterior doors. See “Interior vs Exterior Doors” on page 244 of the Reference Manual.

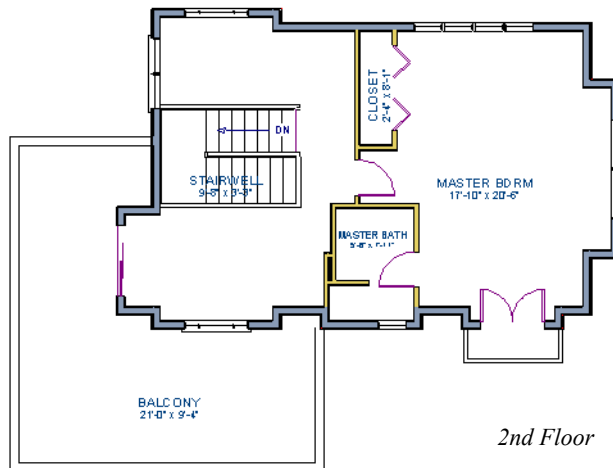
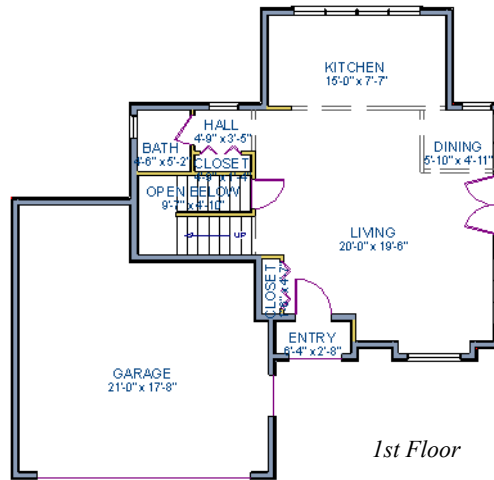

When you have finished, **Save**  your work.

If you would like, you can continue working on this plan in the Interior Design Tutorial or Kitchen and Bath Design Tutorial. You can also learn about materials in the Materials Tutorial or find out more about roofs in the Roof Tutorial.

Roof Tutorial

The majority of Roof Tutorial describes some common roof styles that can be created using settings in the **Wall Specification** dialog and can be completed independent of the other tutorials. It also explains how to add gables over doors and windows, how to create dormers automatically and manually, and how to create skylights.

The Adding a Roof to the Stucco Beach House section continues where the House Design Tutorial left off and explains how to add a roof to that plan.

For more information about Roof Tools, see “Roofs” on page 373 of the Reference Manual.



In this tutorial you’ll learn about:

- Getting Started with Automatic Roof Styles
- Hip Roofs
- Gable Roofs
- Dutch Gable Roofs
- Shed Roofs
- Offset Gable Roofs
- Gambrel Roofs
- Gull Wing Roofs
- Half Hip Roofs
- Mansard Roofs
- Roof Style Quick Reference
- Roof Returns
- Adding Gables over Doors and Windows
- Automatic Dormers
- Manually Drawn Dormers
- Skylights
- Using the Break Wall Tool to Modify Roofs
- Adding a Roof to the Stucco Beach House
- Troubleshooting Roof Issues



Getting Started with Automatic Roof Styles

This tutorial uses a simple, rectangular structure to explain how to create common roof styles using roof style directives assigned to the exterior walls.

To begin a new plan

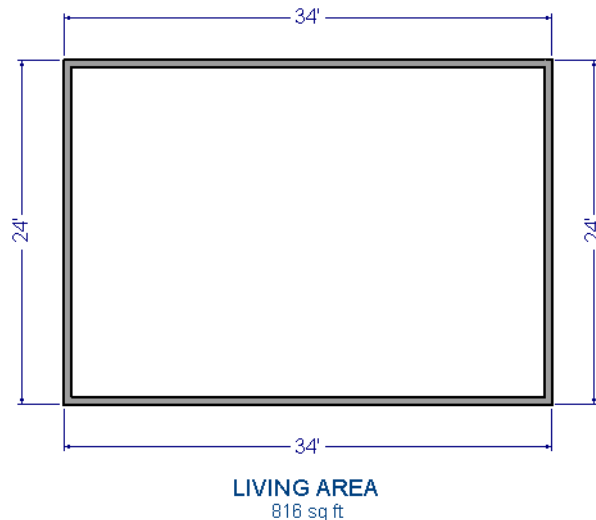
1. If any plans are open, select **File> Close All** from the menu.
2. Select **File> New Plan**  to open a new plan. In the **Create New Plan** dialog, select the Default Style template.
3. Select **Build> Wall> Straight Exterior Wall**  and draw a rectangular floor plan, measuring about 34 feet by 24 feet (approximately 10.4 m by 7.3 m), in a clockwise direction. See “Drawing Walls” on page 163 of the Reference Manual.



4. Select **3D> Create Camera View> Perspective Full Overview**  to create a 3D overview of the house.
 - If you wish, you can select **3D> Toggle Textures**  from the menu to turn off the display of material textures and represent all materials using solid colors.
5. Select **Window> Tile Vertically**  to see both views at the same time.

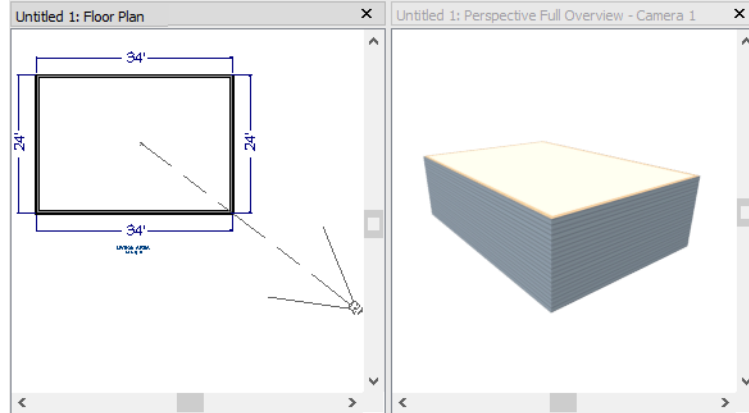



Roof Style Directives in Walls

By default, the program will generate a roof plane bearing on each exterior wall that does not have a room-defining wall directly above it, and will use the pitch specified in the **Build Roof** dialog. The result is a hip style roof; however, if you need a different condition over a particular wall to produce another roof style, you can define it in that wall's specification dialog.

Individual walls can be selected and edited in both 2D and 3D views. When multiple walls are to be edited, however, it is usually quicker and easier to work in plan view. See “Editing Walls” on page 170 of the Reference Manual.

To set a wall's roof directives

1. Click the **Select Objects**  button, then click on a wall to select it.
2. Click the **Open Object**  button to open the **Wall Specification** dialog.
3. On the **ROOF** panel:
 - The **Roof Options** control how the roof builds over the selected wall.
 - The **Pitch Options** control how steep the roof that bears on the selected wall is.

To reset all roof directives

1. Select **Edit > Reset to Defaults**.
2. In the **Reset to Defaults** dialog, set the Reset Scope to **All Floors**, check **Roof Directives in Walls**, and click **OK**.

Attic Walls

When a roof is generated, attic walls may also be generated. An Attic wall fills the space between the walls that define a room and the roof above. The triangular-shaped wall of a gable, for example, is created using an Attic wall.



If you do not want to see attic walls in plan view, you can turn off their display.

To turn off the display of attic walls

1. In plan view, select **Tools> Display Options**  (or press the ~ key) to open the **Display Options** dialog.
2. Find "Walls, Attic" in the Name column, remove the check from the Display column for this item, and click OK. For more information, see "Display Options Dialog" on page 100 of the Reference Manual.

Deleting Roofs

Roof planes can be easily deleted in either of two ways:

- Select **Build> Roof> Delete Roof** .
- Select **Edit> Delete Objects**  and in the **Delete Objects** dialog, select either **All Rooms On This Floor** or **All Floors**; place a check beside **Roof**; and click **OK** to delete all roof planes either on the current floor or in the plan.

If a warning message states that roofs cannot be deleted while **Auto Rebuild Roof** is on, click the **Yes** button to turn off **Auto Rebuild Roof** and delete the roof.

Auto Rebuild Roofs

Auto Rebuild Roofs is a convenient feature in Home Designer Architectural that automatically rebuilds the roof in a plan whenever the exterior walls or floor/ceiling heights are changed. Auto Rebuild Roofs is turned on by default, but this tutorial is presented with this feature disabled; however the information presented here also applies when it is enabled.

To turn on/off Auto Rebuild Roofs

1. Select **Build> Roof> Build Roof**  from the menu.
2. In the **Build Roof** dialog, check or uncheck **Auto Rebuild Roofs** and click **OK**.

Hip Roofs

When roofs are automatically generated, a roof plane is built over every exterior wall in the plan that does not have another wall drawn above it. The result is referred to as a hip roof.

To create a hip roof

1. Begin with the basic rectangular structure described in “Getting Started with Automatic Roof Styles” on page 58.
2. Select **Build> Roof> Build Roof**  from the menu to open the **Build Roof** dialog.
3. Click **OK** to generate a hip roof.

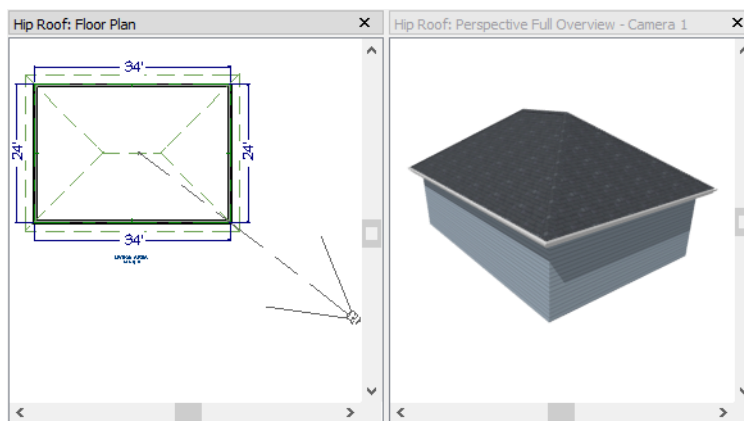



Gable Roofs

If you would like a gable over a particular wall rather than a roof plane bearing on it, you can specify it as a **Full Gable Wall** in the **Wall Specification** dialog. To create basic gable roof, two walls should be specified as **Full Gable Wall**.

To create a gable roof

1. Begin with the basic rectangular structure described in “Getting Started with Automatic Roof Styles” on page 58.
2. Use the **Select Objects**  tool to select one of the walls drawn vertically on screen.
3. Open the **Wall Specification** dialog and on the **ROOF** panel, check **Full Gable Wall** and click **OK**. See “To set a wall’s roof directives” on page 59.

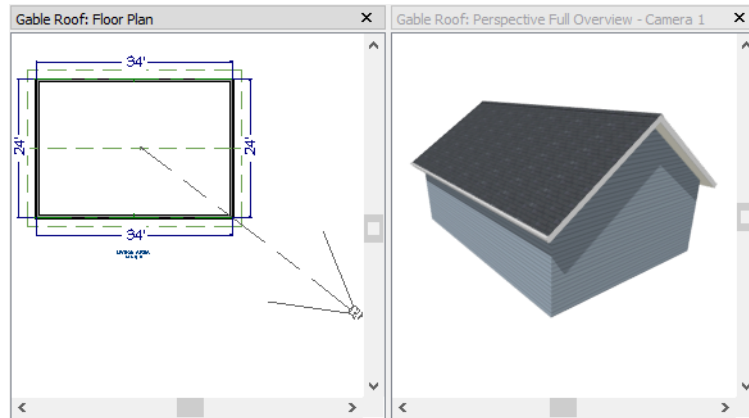

- Alternatively, you can click the **Change to Gable Wall(s)**  edit button.
 - To remove the Full Gable Wall attribute from a selected wall, click the **Change to Hip Wall(s)**  edit button.
4. Make the same changes to the other vertically-drawn wall.
 5. Select **Build> Roof> Build Roof**  to open the **Build Roof** dialog and click **OK**.



Dutch Gable Roofs

A Dutch gable, sometimes called a Dutch hip, is a combination of hip and gable roof styles in which a gable is located at the end of the ridge, at the top of a hip roof plane.

To create a Dutch gable roof

1. Begin with the basic rectangular structure described in “To begin a new plan” on page 58.
2. Use the **Select Objects**  tool to select one of the walls drawn vertically on screen.
3. Open the **Wall Specification** dialog and on the **ROOF** panel, change the following settings:
 - Check the box beside **Dutch Gable Roof**.
 - Specify the **Starts at Height** as 180".
4. Click **OK** to close the **Wall Specification** dialog. See “To set a wall’s roof directives” on page 59.
5. Make the same changes to the other vertically-drawn wall.
6. Select **Build> Roof> Build Roof**  to open the **Build Roof** dialog and click **OK**.

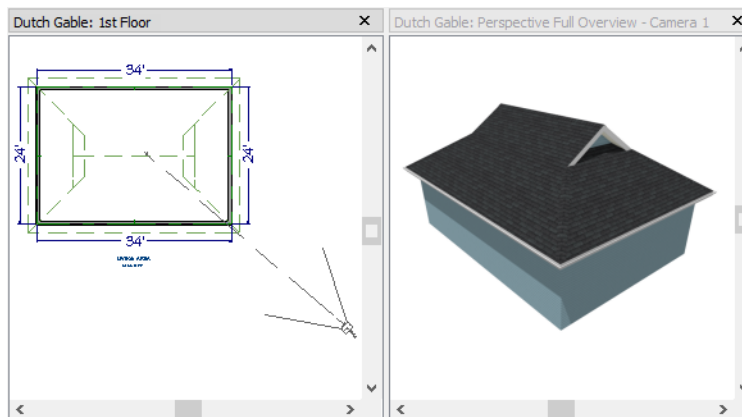

Shed Roofs

To create a single, sloping roof plane, or shed roof, two walls must be specified as **Full Gable Walls**, and one must be a **High Shed/Gable Wall**.

To create a shed roof

1. Begin with the basic rectangular structure described in “Getting Started with Automatic Roof Styles” on page 58.
2. As in the Gable Roofs example, specify the left and right vertical walls as **Full Gable Walls**.
3. Select the lower horizontal wall and open its **Wall Specification** dialog. On the **ROOF** panel, check **High Shed/Gable Wall** and click **OK**. See “To set a wall’s roof directives” on page 59.
4. Select **Build> Roof> Build Roof**  to open the **Build Roof** dialog, specify a **Pitch** of 2 in 12, and click **OK**.

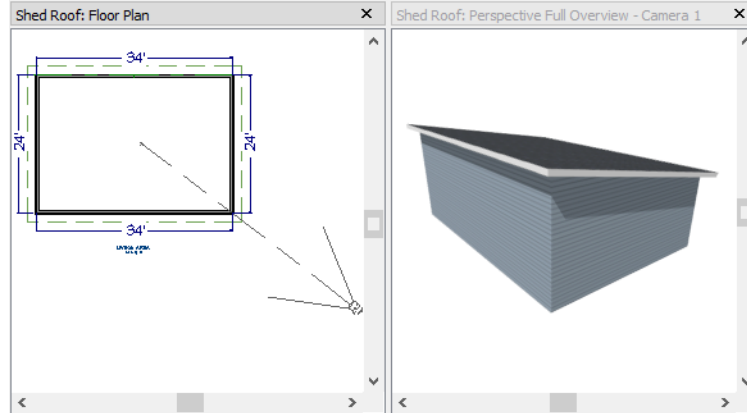

Offset Gable Roofs

An offset gable is a type of gable roof with different pitches on each of the two roof planes and a ridge that is offset from the building's center line. Assign a different pitch to the two roof planes in the **Wall Specification** dialog for the wall supporting each one.

To create an offset gable roof

1. Begin with the basic rectangular structure described in “To begin a new plan” on page 58.
2. As in the Gable Roofs example, specify the left and right vertical walls as **Full Gable Walls**.
3. Select the lower horizontal wall and open its **Wall Specification** dialog. On the **ROOF** panel, leave the **Roof Options** unchecked and change the **Pitch** to 12 in 12. See “To set a wall's roof directives” on page 59.
4. Select **Build > Roof > Build Roof**  to open the **Build Roof** dialog, specify the **Pitch** as 2 in 12, and click **OK**.

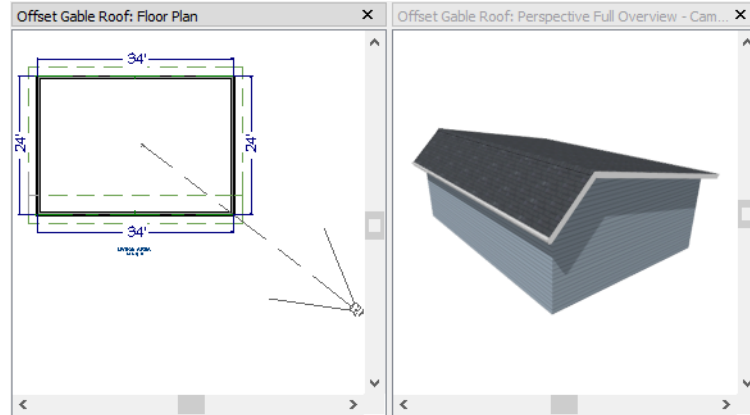

Gambrel Roofs

A gambrel or barn style roof has two pitches on each side of the ridge. The first (lower) pitch on either side is steeper than the pitch near the ridge.

To create a gambrel roof

1. Begin with the basic rectangular structure described in “Getting Started with Automatic Roof Styles” on page 58.
2. As in the Gable Roofs example, specify the left and right vertical walls as **Full Gable Walls**.
3. Use the **Select Objects**  tool to select one of the walls drawn horizontally on screen.
4. Open the **Wall Specification** dialog and on the **ROOF** panel, change the following settings:
 - Make sure that the **Pitch** value is followed by (D), which means that is set to use the default.
 - Check the box beside **Upper Pitch**.
 - Specify the **Upper Pitch** as 6 in 12 and the **Start Height** as 156".
5. Click **OK** to close the **Wall Specification** dialog. See “To set a wall’s roof directives” on page 59.
6. Make the same changes to the other horizontally-drawn wall.
7. Open the **Build Roof** dialog, specify the **Pitch** as 12 in 12, and click **OK**.

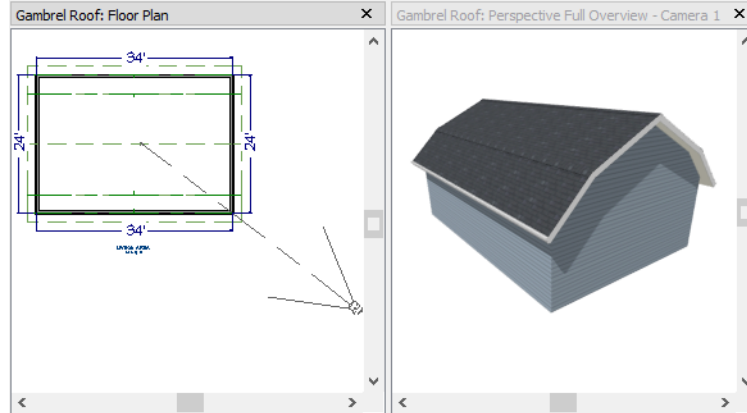



Experiment with alternate pitches and overhangs. Also, try varying the height at which the second pitch begins so that you can see the effect it has on the gambrel roof design.

Gull Wing Roofs

A gull wing roof has two pitches on either side of the ridge, as a gambrel does; but the first pitch of a gull wing is shallower than the steeper upper pitch.

To create a gull wing roof

1. Begin with the basic rectangular structure described in “Getting Started with Automatic Roof Styles” on page 58.
2. As in the Gable Roofs example, specify the left and right vertical walls as **Full Gable Walls**.
3. Use the **Select Objects**  tool to select one of the walls drawn horizontally on screen.
4. Open the **Wall Specification** dialog and on the **ROOF** panel, and change the following settings:
 - Make sure that the **Pitch** value is followed by (D), which means that is set to use the default.
 - Place a check in the box beside **Upper Pitch**.
 - Keep the **Upper Pitch** as 12 in 12 and change the **Start Height** to 125".
5. Click **OK** to close the dialog. See “To set a wall’s roof directives” on page 59.
6. Make the same changes to the other horizontally-drawn wall.
7. Click the **Build Roof**  tool, specify a **Pitch** of 3 in 12, and click **OK** in the **Build Roof** dialog.

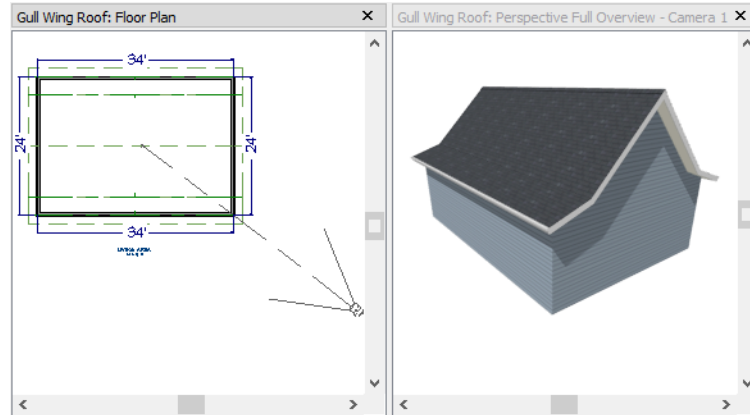

Experiment with the height at which the second pitch begins so that you can see the effect it has on the gull wing roof design.

Half Hip Roofs

A half hip roof has two gable ends. At the top of each gable is a small hip that extends to the ridge.

To create a half hip roof

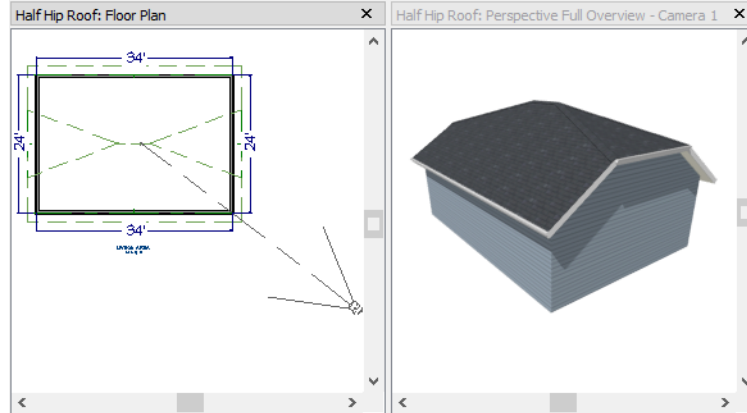

1. Begin with the basic rectangular structure described in “Getting Started with Automatic Roof Styles” on page 58.
2. As in the Gable Roofs example, specify the left and right vertical walls as **Full Gable Walls**. In addition, change the following **Pitch Option** settings:
 - Check the box beside **Upper Pitch**.
 - Specify the **Upper Pitch** as 3 in 12 and set the **Start Height** at 170".
3. Click the **Build Roof**  tool and click **OK** in the **Build Roof** dialog.



Mansard Roofs

A mansard roof is a hip roof with two pitches on the roof sections above each exterior wall: an extremely steep lower pitch and a gently sloping upper pitch.

To create a mansard roof

1. Begin with the basic rectangular structure described in “Getting Started with Automatic Roof Styles” on page 58.
2. Use the **Select Objects**  tool to select one of the walls.
3. Open the **Wall Specification** dialog and on the **ROOF** panel, and change the following settings:
 - Check the box beside **Upper Pitch**.
 - Specify the **Upper Pitch** as 1.5 in 12 and the **Start Height** as 132".
4. Click **OK** to close the dialog. See “To set a wall’s roof directives” on page 59.
5. Make the same changes to each of the exterior walls.
6. Click the **Build Roof**  tool, specify a **Pitch** of 24 in 12, and click **OK** in the **Build Roof** dialog.

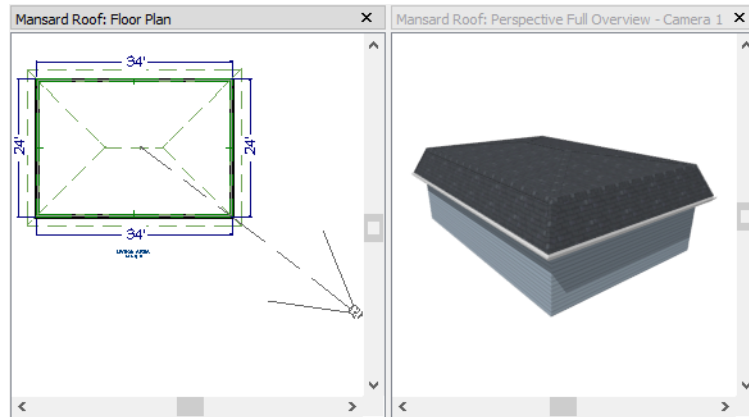

Roof Style Quick Reference

The following chart provides a quick reference for building the roof styles described in this tutorial. The chart shows which walls to change and what to change on the **ROOF** panel of the **Wall Specification** dialog for each wall. These parameters are based on a 34x24-foot model. For different size plans, adjust these numbers.

Roof Type	Wall to Change	Set as Full Gable	Set as High Shed Gable	Lower Pitch	Upper Pitch	Start Height
Gable Roof	Vertical Wall 1					
	Vertical Wall 2					
	Horizontal Wall 1	X				
	Horizontal Wall 2	X				
Shed Roof	Vertical Wall 1	X				
	Vertical Wall 2	X				
	Horizontal Wall 1		X			
	Horizontal Wall 2					
Offset Gable Roof	Vertical Wall 1	X				
	Vertical Wall 2	X				
	Horizontal Wall 1			12 in 12		
	Horizontal Wall 2			3 in 12		
Gambrel Roof	Vertical Wall 1	X				
	Vertical Wall 2	X				
	Horizontal Wall 1			12 in 12	6 in 12	156
	Horizontal Wall 2			12 in 12	6 in 12	156
Gull Wing Roof	Vertical Wall 1	X				
	Vertical Wall 2	X				
	Horizontal Wall 1			3 in 12	12 in 12	125
	Horizontal Wall 2			3 in 12	12 in 12	125
Half Hip Roof	Vertical Wall 1	X			3 in 12	170
	Vertical Wall 2	X			3 in 12	170
	Horizontal Wall 1			6 in 12		
	Horizontal Wall 2			6 in 12		
Mansard Roof	Vertical Wall 1			12 in 12	1.5 in 12	132
	Vertical Wall 2			12 in 12	1.5 in 12	132
	Horizontal Wall 1			12 in 12	1.5 in 12	132
	Horizontal Wall 2			12 in 12	1.5 in 12	132

Roof Returns

A roof return is a small decorative roof plane that connects to the low side of a gable roof overhang and extends below the upper triangular portion of the gable wall. While you can build these manually, the following pictures illustrate the three styles of roof returns that can be produced automatically in Home Designer Architectural.

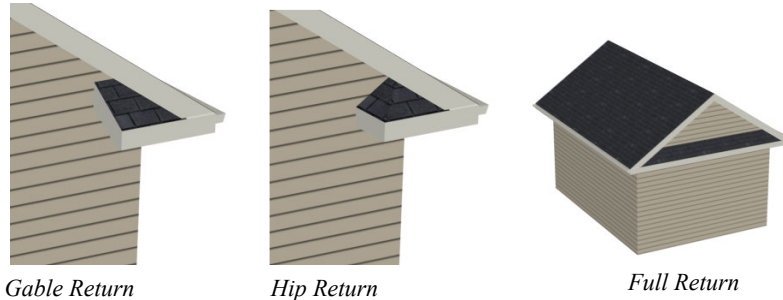

The first two are called **Gable** and **Hip** returns, since the returns themselves end in either a gable or a hip. The third is called a **Full** return because it extends under the entire gable, connecting both sides. Full roof returns are sometimes referred to as water tables.

The Auto Roof Return settings are found on the ROOF panel of the **Wall Specification** dialog. Roof returns can be specified for any wall, but they will only generate on **Full Gable Walls**.

Auto Roof Return

Length:

Extend:

Roof Type: Gable Hip Full



Slope: Sloping Flat

Specify the horizontal **Length** of the returns in inches; the distance to **Extend** the returns past the main roof overhang; the style of roof return; and whether the returns are sloping or flat. As long as your model has a roof, the specified roof returns will be generated when you click **OK**. For more information, see “Roof Returns” on page 388 of the Reference Manual.



Adding Gables over Doors and Windows

You can add a gable roof over a door or window.



To create a gable roof over a door or window

1. Select a door or window, then click the **Gable Over Door/Window**  edit button.
2. Click the **Build Roof**  tool and click **OK** in the **Build Roof** dialog.
3. A gable is created with an overhang of one foot on each side of the door or window.

To remove a gable roof over a door or window

1. Select the door or window and click the **Delete Gable Over Opening**  edit button.
2. Click the **Build Roof**  tool and click **OK** in the **Build Roof** dialog.
3. When you rebuild the roof, the gable will be removed.

To create a gable over several doors and/or windows

1. Select a door, window, or mulled unit.
2. Hold down the Shift key and click on additional doors and/or windows to add them to your selection set.
3. Click the **Gable Over Door/Window**  edit button.
4. Click the **Build Roof**  tool and click **OK** in the **Build Roof** dialog to create a gable over the selected wall openings.



Automatic Dormers

The **Dormer**  tool offers a quick and convenient alternative to drawing dormers manually. With just a few clicks an entire dormer is placed, complete with roof, roof hole, walls, and window.

There is a limit to how low the roof pitch can be set when creating dormers. Generally, 9 in 12 is the lowest pitch that will provide enough elevation to contain a dormer.

A **Dormer**  can be placed anywhere within a roof plane, as long as there is enough space to contain it.

Select **Build> Roof> Dormer**  and click within an existing roof plane to place a floating dormer at that location. Once a dormer is created, it can be moved, resized and opened for specification. For more information, see “Editing Auto Dormers” on page 386 of the Reference Manual.





A Dormer cannot initially be placed so that its walls align with an exterior wall. Once it is created, its front wall can often be aligned with an exterior wall below; however, its side walls must remain inside the exterior walls.

Manually Drawn Dormers

To create dormers in an upper floor, create a new floor for your plan and modify this floor with knee walls and windows to form gables. This example starts with a new 40 x 30 foot plan.



As with automatic dormers, roof pitches of 9 in 12 or greater generally work better than shallow pitches when creating dormers because they provide enough vertical space to build the dormer within.

To create a new plan

1. Select **File> Close All** from the menu to close any open plans.
2. Select **File> New Plan**  to open a new plan. In the **Create New Plan** dialog, select the Default Style template.
3. Select **File> Save**  from the menu, save the file to an easy to find location, such as Documents, and give the plan a short, descriptive name like Dormer Tutorial.
4. Select **Build> Wall> Straight Exterior Wall**  and draw a rectangular floor plan, 40 feet by 30 feet, in a clockwise direction.

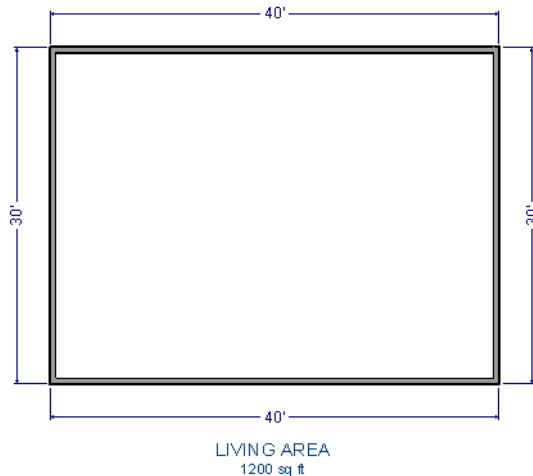
5. Click the **Fill Window Building Only**  button to zoom in on the house.



6. As in the Gable Roofs example, specify the left and right vertical walls as **Full Gable Walls**. See “To set a wall’s roof directives” on page 59.
7. Select **Build> Floor> Build New Floor** .
8. Choose the **Derive new 2nd floor plan from 1st floor plan** option in the **New Floor** dialog and click **OK**. In the Floor 2 Defaults dialog, which opens next, click **OK** without making any changes.
9. Select **Build> Roof> Build Roof**  to open the **Build Roof** dialog. On the **ROOF** panel, change the **Pitch** to 12 in 12, and click **OK**.

To create two knee walls



A knee wall is a short wall on an upper floor that is cut off by a roof plane rather than building up to full ceiling height. They are often used to separate loft areas from attic space.

 You can create a custom wall type for the knee walls, such as a wall with only a framing layer and one sheetrock layer. See “Wall Type Definitions Dialog” on page 179 of the Reference Manual.

1. Select **Build> Wall> Straight Interior Wall**  and draw a horizontal interior wall from left to right. Position this knee wall so that it is 5 feet from the top exterior wall.
2. Draw another horizontal interior wall and position it 5 feet from the bottom exterior wall. You can reposition the knee walls using dimensions. For more information, see “Moving

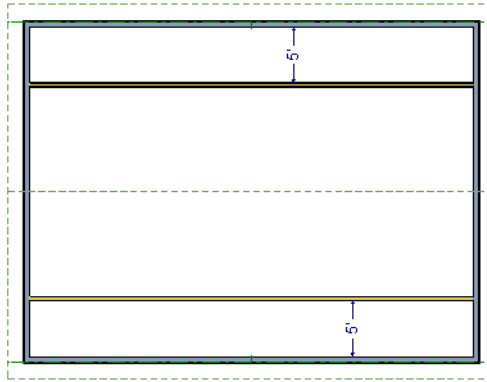
Objects Using Dimensions” on page 224 of the Reference Manual.



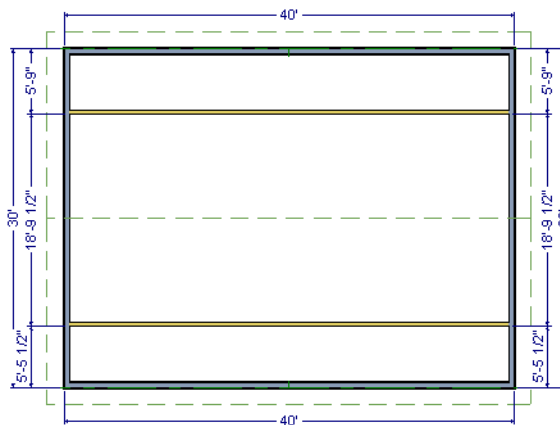

3. Select each of the interior walls one at a time and click the **Open Object**  edit button. Check the box beside **Knee Wall** on the ROOF panel of the **Wall Specification** dialog and click **OK**.
4. Select **CAD> Dimensions> Automatic Exterior Dimensions**  to create exterior dimension lines for your plan, which should now look like this:

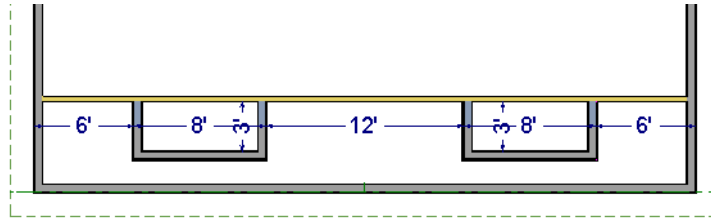

To draw the dormer walls and windows

1. Select **Build> Wall> Straight Exterior Wall**  and draw two rectangular boxes on the outside of the lower knee wall, as shown in the following image.



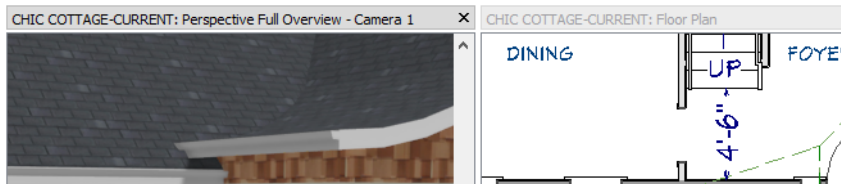

2. Position the front walls of each dormer box 2 feet from the bottom exterior wall. The front dormer walls are those parallel to the bottom wall.
3. Use dimension lines to position the dormer side walls so that the dormers are 6 feet from each vertical exterior wall and 8 feet wide.
4. Select **Build> Wall> Break Wall**  and click along the lower knee wall to place wall breaks where it intersects each of the dormer side walls.





5. Delete the segments of the knee wall located behind the dormers, as in the following image:





6. Select **Build> Window> Window**  and click on each dormer front wall to place a window.
 - When **Object Snaps** are enabled, a "sticky point" will exist at the midpoint of the dormer front wall when you move your mouse along the front wall. For more information, see "Object Snaps" on page 90 of the Reference Manual.
 - You can also use the **Center Object**  edit button to center each window along the wall after it has been placed. See "Using Center Object" on page 128 of the Reference Manual.

To build the roof

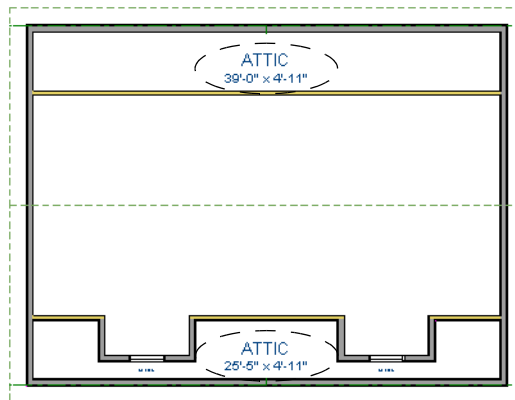
1. Select the two dormer front walls with windows and open their **Wall Specification** dialog. On the ROOF panel, check **Full Gable Wall** and click **OK**.
2. Select the four dormer side walls and open their **Wall Specification** dialog. On the ROOF panel, confirm that **Pitch** is 12 in 12, and click **OK**.
 - Earlier, a pitch of 12 in 12 was specified in the **Build Roof** dialog; that pitch will be in use here by default and will work well for these dormers.
1. Click the **Select Objects**  button, then click in the narrow room between the top knee wall and the top exterior wall to select it.
2. Click the **Open Object**  edit button to open the **Room Specification** dialog. On the GENERAL panel, select "Attic" as the **Room Type** and click **OK**.
3. Do the same for the lower attic room.



4. Select **Build> Roof> Build Roof**  from the menu.
5. In the **Build Roof** dialog, click **OK** to rebuild the roof.
6. Select **3D> Create Camera View> Perspective Full Overview**  to create a 3D overview of the house and see the results.

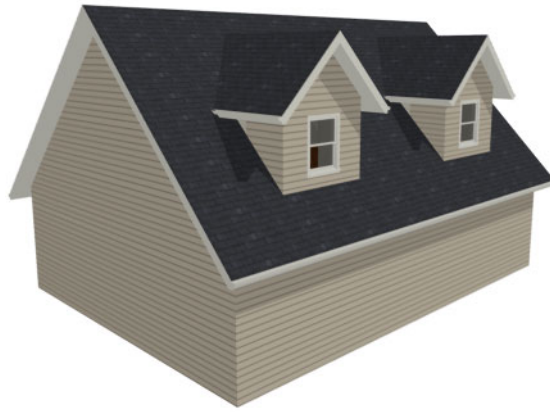

7. Notice that there are small gaps in the dormer side walls. This gap is caused by the difference between the position of the knee walls and the point at which the ceiling intersects the roof plane. This location is marked by the black dotted Ceiling Break Line in plan view.

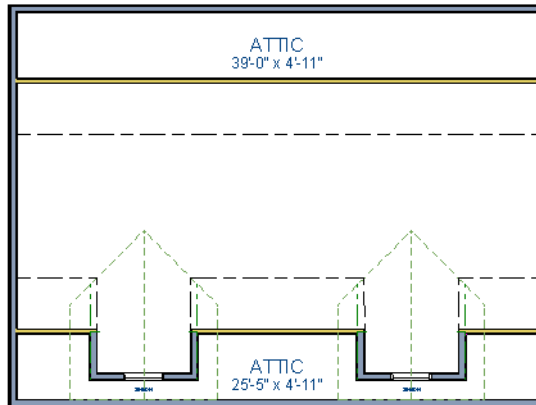

8. Select each of the knee walls and move them back so that they are in alignment with the ceiling plane. When **Object Snaps** are enabled, the walls will snap into position when they are close to the Ceiling Break Lines.

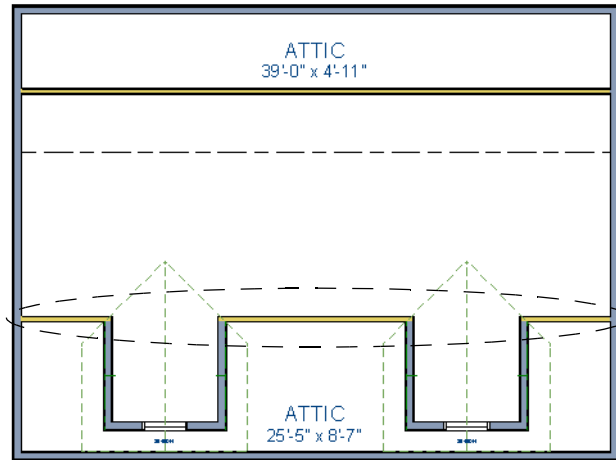

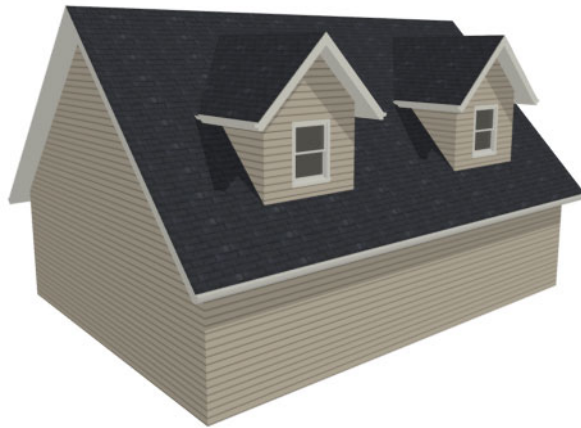

9. Create a 3D view to see how the roof and dormers look now.



You can move the interior walls closer to or further from the outside walls to change the dormers' elevation, or change the pitch for the roof to make the dormers longer. You can create dormers in more complex plans the same way, but you may want to experiment with wall placement and pitch to achieve the desired effect.

Skylights

Skylights can easily be added using the **Skylight**  tool. In plan view, select **Build> Roof> Skylight**  then click and drag a rectangular shape within an existing roof plane. When you release the mouse button, a skylight is created and can be repositioned and resized using its edit handles. For more information, see “Skylights” on page 382 of the Reference Manual.

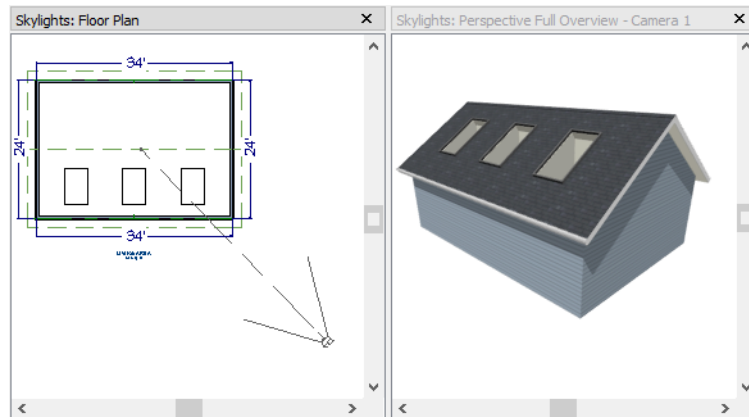

Using the Break Wall Tool to Modify Roofs

Many homes have more than one roof type built above a single exterior wall. One common example is a reverse gable roof, created when a house has gable walls that are perpendicular to one another, as in an L-shaped home.

We can create a reverse gable roof on an L-shaped home using the **Break Wall**  tool.

To create an L-shaped home

1. Select **File> Close All** from the menu.
2. Select **File> New Plan**  to open a new plan. In the **Create New Plan** dialog, select the Default Style template.
3. Draw an L-shaped house with the following dimensions:
 - Left wall - 30 feet long
 - Upper wall - 45 feet long.
 - Right wall 18 feet long.
 - Lower wall extending left from the right wall - 25 feet long.

- Vertical wall connecting two lower walls - 12 feet long.
 - Lower wall extending right from the left wall - 20 feet long.
4. If desired, turn off **Auto Rebuild Roof** and delete the roof.

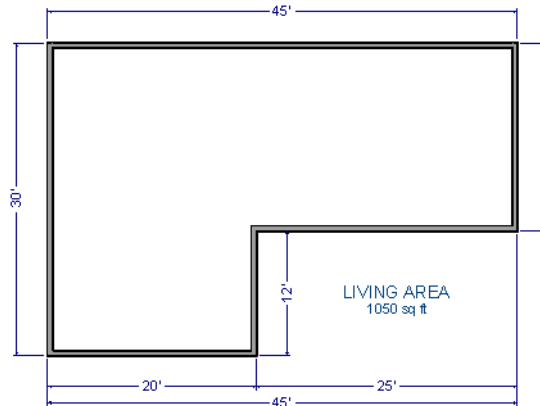

To create a reverse gable in this plan, three gable walls are required: two running vertically and one horizontally.

To add a gable roof to the plan

1. Check **Full Gable Wall** on the ROOF panel of the **Wall Specification** dialog for these three walls:
 - The far left vertical wall
 - The far right vertical wall
 - The bottom left horizontal wall
2. Click the **Build Roof**  button to open the **Build Roof** dialog and click **OK** to build the roof. The roof will look like this:

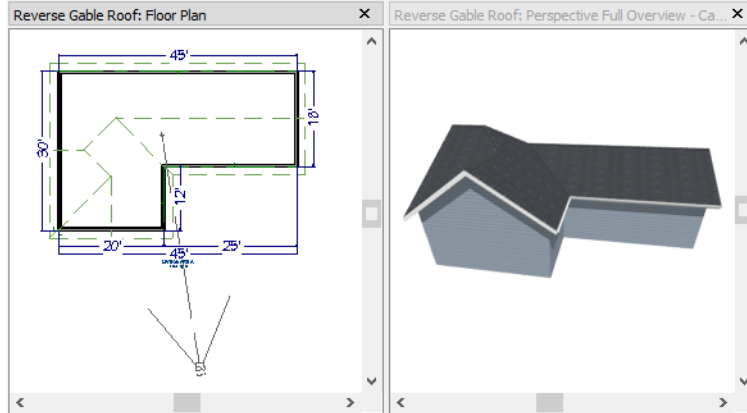

The gable wall on the left produces roof planes that extend too high and interfere with the roof over the front extension of the house. To avoid this, use the Break Wall tool to divide the left wall into two different sections. The upper section can then be specified as a Full Gable without affecting the lower section.

To use the Break Wall tool

1. Select **Build> Wall> Break Wall**  and click the far left wall at a point even with the lower right wall.
 - An easy way to do this is to temporarily stretch the lower right wall across to the left wall;
 - Place a wall break where the walls meet;
 - Then return the lower right wall to its correct position.

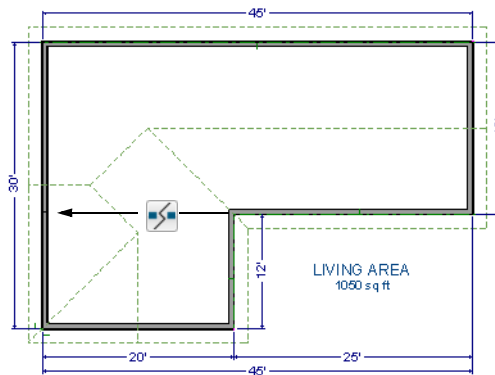

2. Open the lower portion of the wall for specification and on the **ROOF** panel of the **Wall Specification** dialog, clear the **Full Gable Wall** checkbox and click **OK**.
3. Click the **Build Roof**  button and click **OK** to build a roof based on the new wall specifications.

You now have two full gable roof sections meeting to form your L-shaped roof. Your plan should look like the following image:

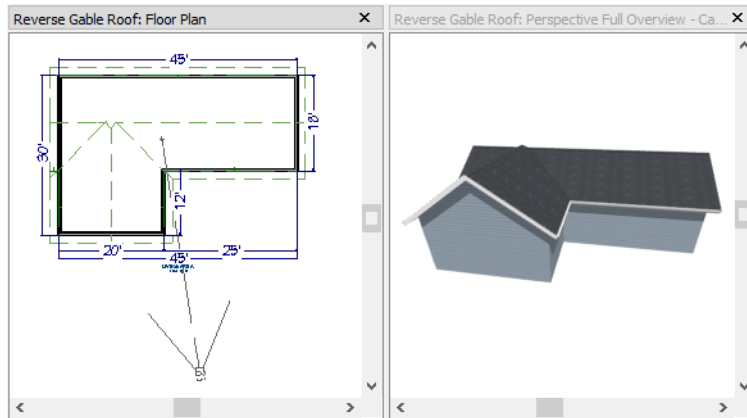

Notice the step in the ridge line. This can be corrected by resizing the lower gable wall. Select the vertical wall to the right of the bottom gable wall and move it to the left 2 feet, reducing the length of the gable wall from 20 to 18 feet. When you are finished, rebuild the roof.

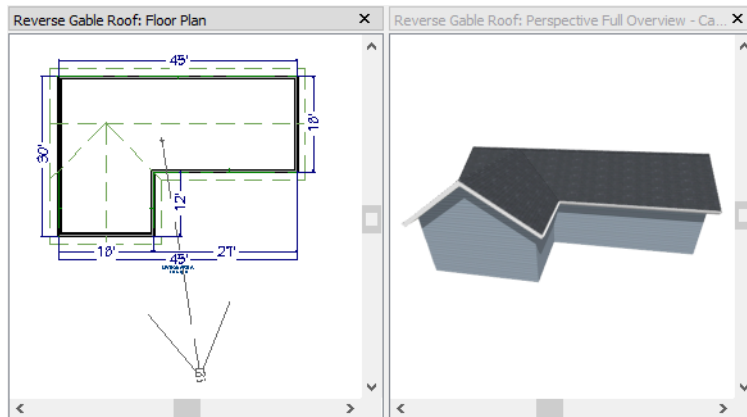

This completes this Roof Tutorial. You can use any combination of the techniques described here to create a wide variety of roof designs.

Adding a Roof to the Stucco Beach House





With a basic understanding of how automatically generated roofs work, you can return to the Stucco Beach House plan and add a roof. Select **File> Save As**  and give this plan a new name, such as "Beach House Roof Tutorial" before continuing.

Individual walls can be selected and edited in both 2D and 3D views; however, when multiple walls must be edited, it is usually quicker and easier to work in plan view. See “Editing Walls” on page 170 of the Reference Manual.

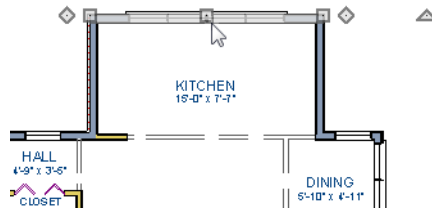
To edit the default roof

1. Close any 3D views that you may have open and work in plan view.
2. Starting on Floor 1, use the **Select Objects**  tool to select the top horizontal exterior Kitchen wall:



3. Click the **Open Object**  edit button and specify this wall as a **Full Gable Wall**. See “Gable Roofs” on page 61.
4. Click **Up One Floor**  to go to the second floor.
5. Using the **Select Objects**  tool, select the Balcony room, then click the **Open Object**  edit button. On the STRUCTURE panel of the **Room Specification** dialog, uncheck **Roof Over This Room**, then click **OK**.

- Assign the **Full Gable Wall** and **Extend Slope Downward** settings to the exterior walls, as shown in the following image. See “To set a wall’s roof directives” on page 59.

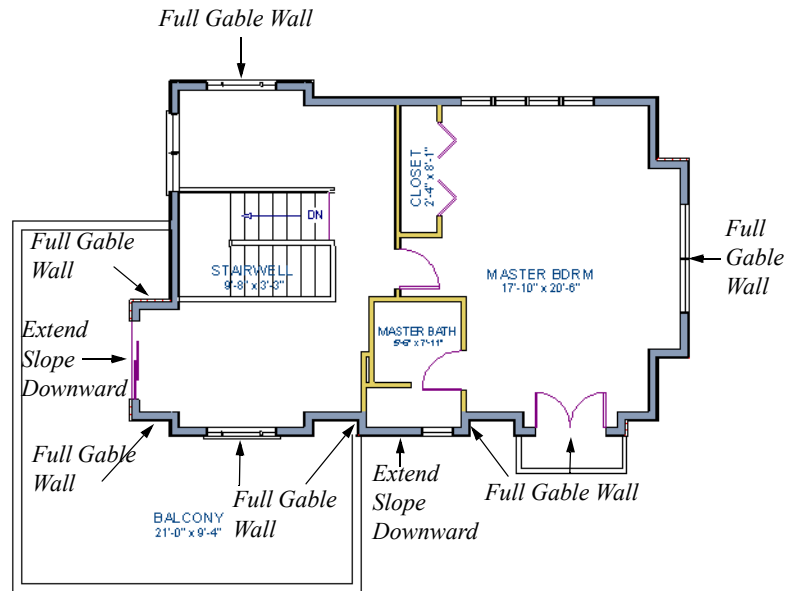

- Once these roof directives have been assigned, the roof can be generated.

To turn on automatic roof generation

- Select **Build> Roof> Build Roof**  to open the **Build Roof** dialog.
- On the **ROOF** panel, check **Auto Rebuild Roofs**. See “Build Roof Dialog” on page 375 of the Reference Manual for more information.
- Set the **Pitch** to 3 in 12.
- You can go to the **MATERIALS** panel to change the material of your roof. Here, an Earth Roof Tile material.
- Click **OK** to close the dialog and generate a roof.

The additional walls that are created are attic walls. See “Attic Walls” on page 60.

6. Select **3D> Create Camera View> Perspective Full Overview**  to create an exterior view of your plan.

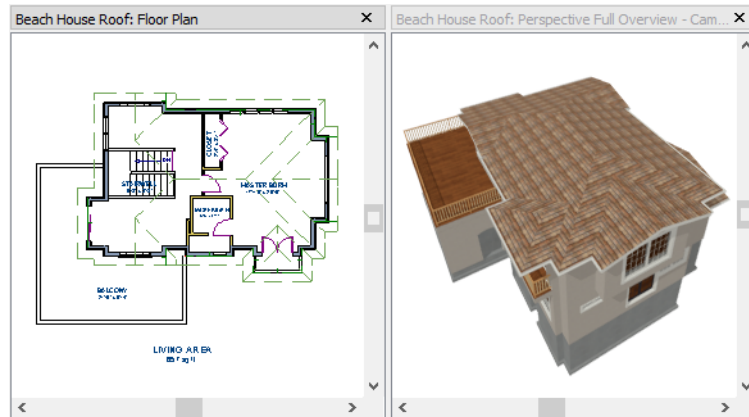

7. Remember to **Save**  your plan as you work.

When you are ready, you can continue working on this plan in the Interior Design Tutorial.

Troubleshooting Roof Issues

Creating a roof can require experimentation and practice. Here are some suggestions for troubleshooting a problematic roof design.

Roof Directives in Walls

As discussed in this chapter and in the Roofs chapter of the Home Designer Architectural 2020 Reference Manual, the program will automatically generate a roof plane bearing over each exterior wall in a plan to produce a hip roof. If you require a different condition over a particular wall, such as a triangular gable or side wall of a shed roof, you can specify that condition on the **ROOF** panel of the **Wall Specification** dialog. See “Roof Panel” on page 183 of the Reference Manual.

Specifying roof directives that do not reflect what you require directly above a selected wall, however, can often result in drastic and unwanted changes to your roof. For example, when two parallel walls are specified as Full Gable Walls, a single ridge will be created between them.

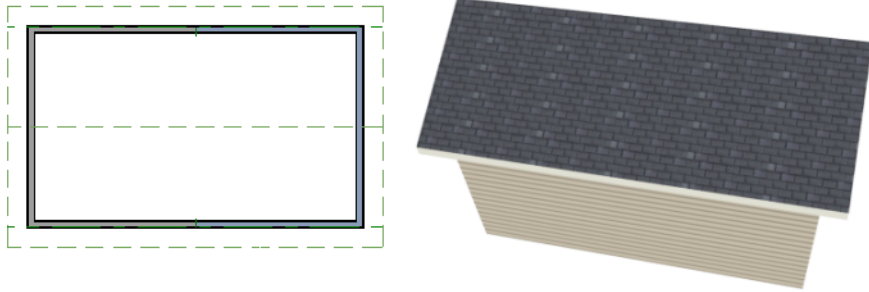

If a wall that is perpendicular to these walls is also specified as a Full Gable Wall, the roof becomes more complex with an additional ridge, two valleys, and two hips.

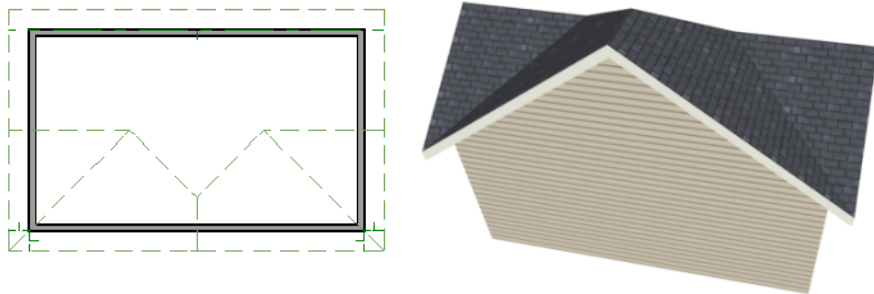

If you are seeing hips or valleys in your roof where you do not expect them, revisit the ROOF panel of the walls supporting the affected roof planes.

To review how to restore wall directives back to their default state, see “To reset all roof directives” on page 59.

Roof Heights

The heights of all roof planes are based on the heights of the walls that they bear on. Wall heights, in turn, are determined by the ceiling heights of the rooms that they define. See “Floor and Ceiling Heights” on page 204 of the Reference Manual.

For example, the hip roof over a simple rectangular structure with a consistent ceiling heights (in this case, 109 1/8") has four roof planes.

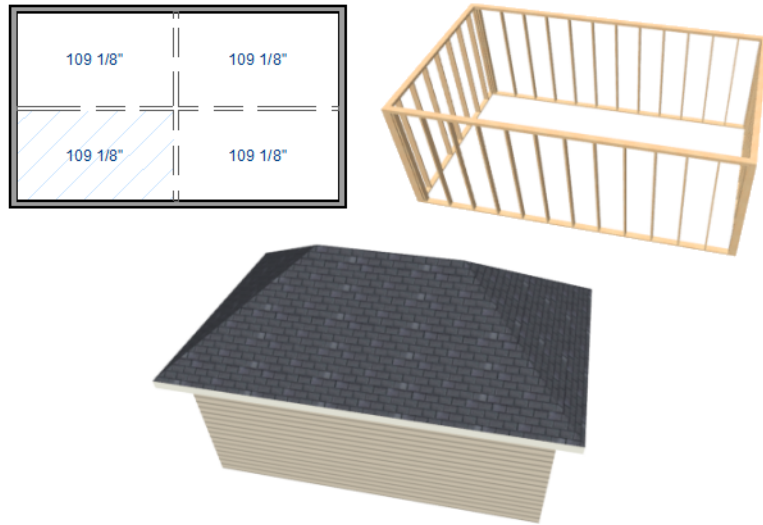

This roof will become considerably more complex if one room inside is given a lowered ceiling height (in this case, 97 1/8").

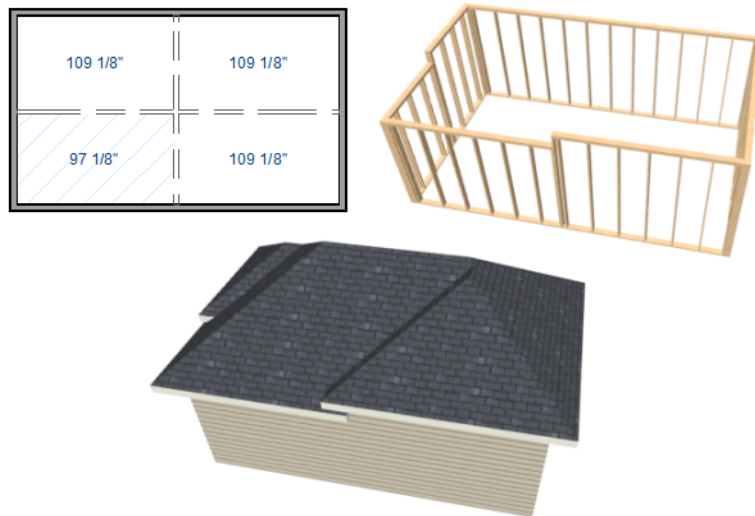

If you generate a roof and it seems to be more complicated and has more roof planes than it should, take a look at the ceiling heights of the rooms in the plan. Often, the correct way to

create a lowered ceiling condition will be to set the ceiling at the default height create a lowered Ceiling Finish. See “Lowered Ceilings” on page 206 of the Reference Manual.

Controlling Roof Ridges

A single roof ridge will generate for as long as the bearing walls that support the roofs on either side of the ridge are the same distance apart. When alcoves or bump outs are introduced along either bearing wall, the ridge is likely to become broken.

For example, a simple rectangular structure with Full Gable Walls at each end generates a roof with a ridge that runs from Full Gable Wall to Full Gable Wall.

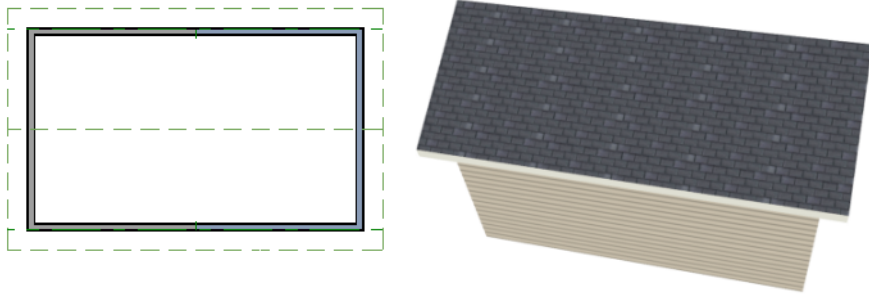

If a bump out is added that affects the length of either Full Gable Wall, or if an alcove is added anywhere along the length of the structure, the ridge will no longer follow a straight line.

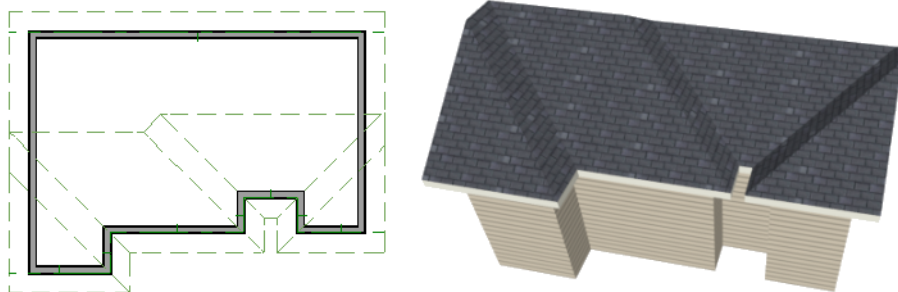

There are a number of ways to maintain a single ridge line in the presence of alcoves or bump outs:

- Use the **Break Wall**  tool to control the length of a Full Gable Wall section. See “Using the Break Wall Tool to Modify Roofs” on page 80.

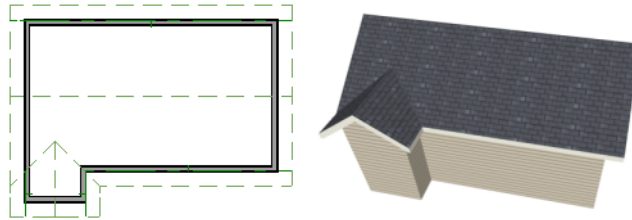

- Increase the **Minimum Alcove Size** to specify what size alcoves are roofed. See “Roof Panel” on page 376 of the Reference Manual.

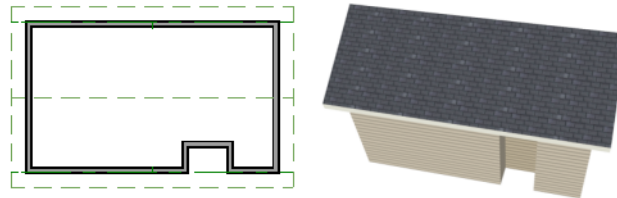

- Use the **Extend Slope Downward** roof directive to allow the roof over a bump out to extend lower than the ceiling height in that area. See “Roof Directives in Walls” on page 175 of the Reference Manual.

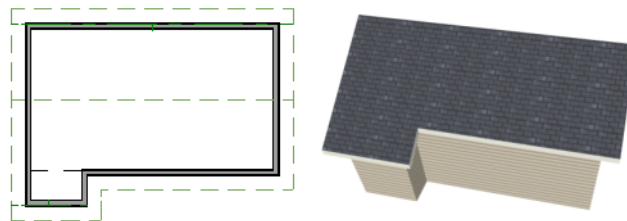

- Specify the area inside of an alcove as an "Open Below" room with a roof but no ceiling, and **Use Soffit Surface for Ceiling** specified. See “Room Types” on page 195 and “Structure Panel” on page 210 of the Reference Manual.

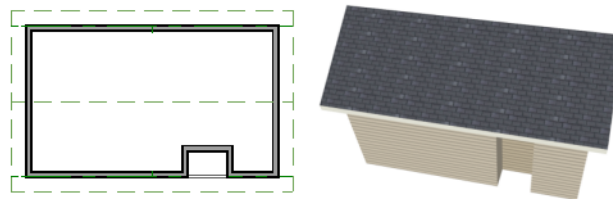

Interior Design Tutorial



The Interior Design Tutorial picks up where the Roof Tutorial left off. The basic structure of the plan is complete, but the plan still needs lights, outlets, and fixtures to be a functional home. In addition, the interior could use some creature comforts such as furniture, wall coverings and moldings. You may want to save this tutorial using a new name to archive your previous work. In this tutorial, you will learn about:

- Controlling the Display of Objects
- Working with Library Objects
- Applying Room Moldings
- Applying Wall Coverings

Controlling the Display of Objects

Every object that you create in Home Designer Architectural exists on a layer that lets you control whether it displays in the current view as well as some aspects of its appearance. For example, the roof that was created in the House Design Tutorial will only be in the way in this tutorial, which discusses the plan's interior. To avoid this, the "Roof Planes" layer can be turned off in floor plan view. For more information, see "Layers" on page 98 of the Reference Manual.

To control the display of objects

1. First, select **File> Save As**  and give this version of the plan a new name, such as "BeachHouse - Interior Tutorial"
2. Select **Tools> Display Options**  or press the ~ key to open the **Display Options** dialog.
3. Press the letter R, find the "Roof Planes" layer and remove the check from the Display column. Turn off the display of "Windows, Labels" and "Doors, Labels", as well. Click OK.

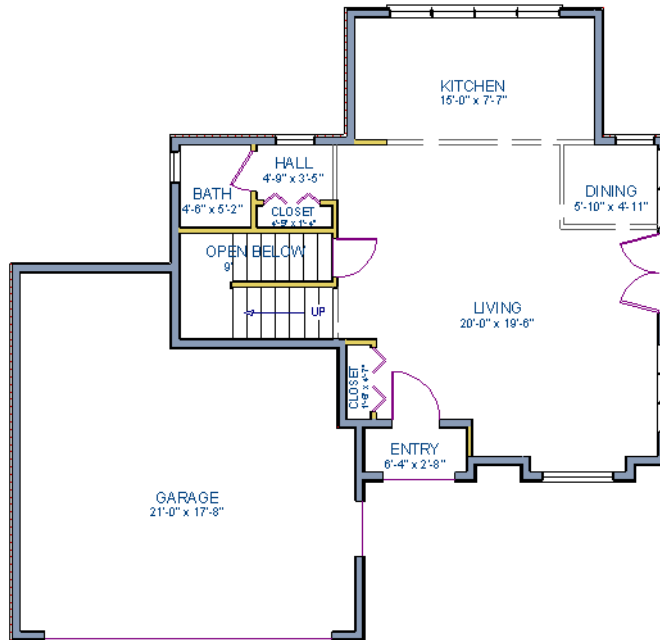



Floor 1 with the display of door and window labels and roof planes turned off

Working with Library Objects

Home Designer Architectural comes with a library that contains thousands of library objects that can be used in a plan. For more information about the library and library objects, see “The Library” on page 399 of the Reference Manual.

To use the Library Search to locate a symbol and place it in the plan

1. Move up to Floor 2 using the **Floor Up**  tool.

2. Select **View > Library Browser**  or press Ctrl + L on your keyboard to open the Library Browser.
3. In the text field, type "bed" and notice that search results will display below as you type. All items with "bed" in any part of their search attributes are included, so in this example, the search results include a variety of items besides furniture.
4. To narrow the search results, click the **Search Filtering Options**  button, then
 - Check the box beside **Entire Word**.
 - Click the arrow beside **Type** then check the box beside **Furnishings (Interior)**. Now only items with the word "bed" in their attributes and are interior furnishing will be included in the search results.
5. Click on a bed in the search results list to select it for placement.

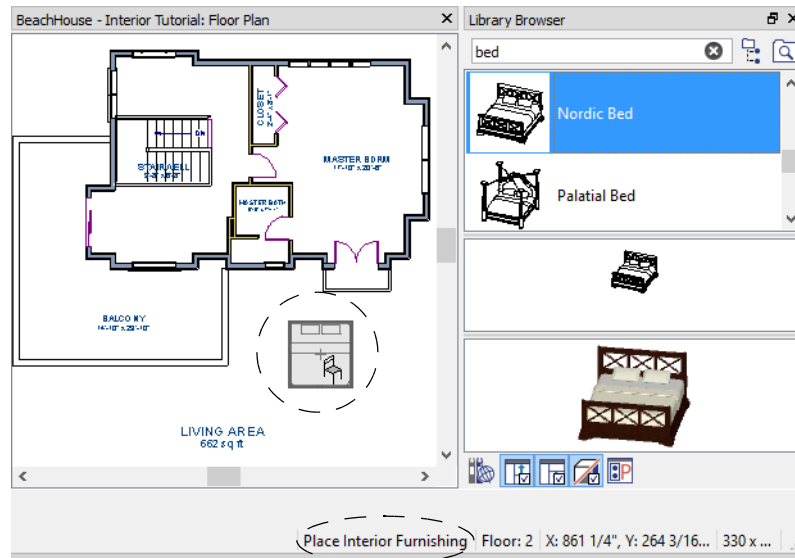

 When a library object is selected for placement the mouse pointer icon indicates the type of library object selected, a preview outline of the object follows your pointer as you move it, and basic information displays in the Status Bar at the bottom of the program window.

6. Click in the master bedroom to place the bed.
7. To see where the selected item is located in the Library Browser, right-click on it and select **Show in Browser** from the contextual menu.
8. To switch from a list of search results to the Library Browser tree view, click the **Browse**  button to the right of the text field.

Using the techniques described above, place fixtures in the bathrooms on Floors 1 and 2.

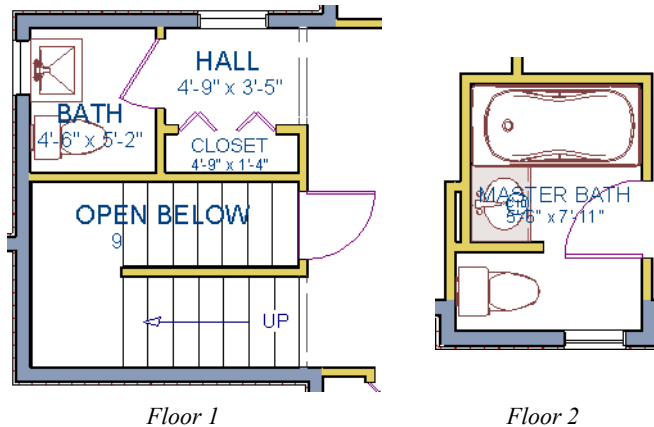

 If existing walls and/or other objects do not allow enough room for a library object to be placed, place the library object where there is enough room and move the object into place while holding down the **Ctrl** key on the keyboard.

Once a library object has been placed into a plan, it can be edited in a variety of ways.

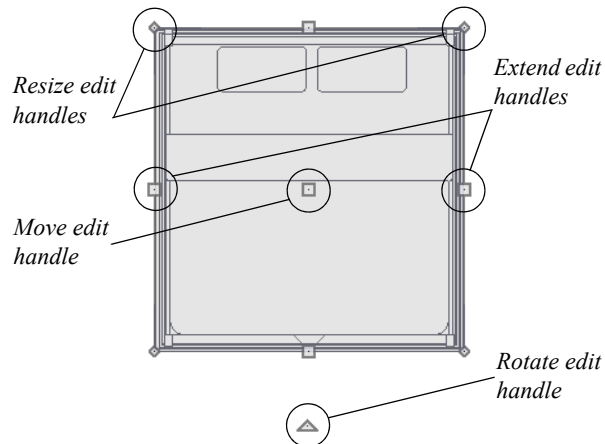

To modify a symbol from the library

1. Click the **Select Objects**  button or press the Spacebar and click on the bed to select it. When selected, the bed displays ten edit handles. For more information, see “Editing Box-Based Objects” on page 120 of the Reference Manual.

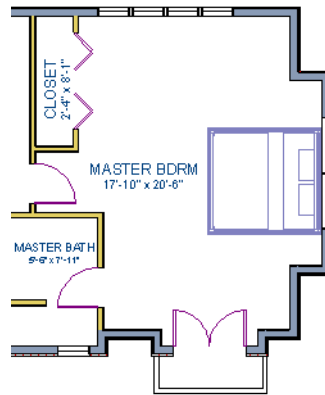

- Use the Rotate edit handle to rotate the bed.
- Use the Move edit handle to move the bed up against the right wall.





- You can modify the materials for the bed by using the **Select Objects**  button tool to select the bed, and clicking the **Open Object**  edit button to open the **Furniture Specification** dialog. See “Symbol Object Specification Dialogs” on page 419 of the Reference Manual.
- On the **MATERIALS** panel, select the component of the object that you want to apply a new material to: for example, the Bedspread.
- Click the **Select Material** button to open the **Select Material** dialog, where you can search or browse the Library to find and apply a new material to the bedspread portion of the bed. Here, a light brown fabric is used.
- Repeat this process for any of the other materials on the bed you may want to adjust, then click **OK** to apply the changes which will be visible when you create a camera view.



You can also apply materials to objects in 3D views using the Material Painter tool. To learn more, see Using the Material Painter in the Materials Tutorial.

You can replace a library object in your plan with a different item from the library using the **Replace From Library**  edit button. This can be particularly helpful if you have multiple copies of the same object throughout the plan, as you might with a fixture like a sink or toilet, and would like to replace them all at once.

To replace a library object

- While the **Select Objects**  tool is active, click on the bed to select it.
- Click the **Replace From Library**  edit button to open the **Replace From Library** dialog.

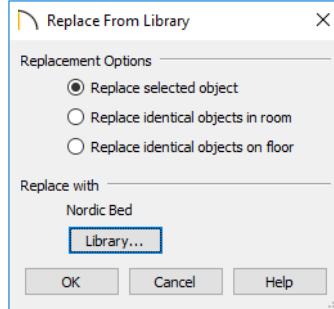



3. Select one of the **Replacement Options** to replace the current object only, all identical objects in the room, or all identical objects on the current floor.
4. Click the **Library** button to select a replacement item from the library.
5. Click **OK** to return to the **Replace From Library** dialog, then click **OK** once more.

Applying Room Moldings

In Home Designer Architectural, you can specify base, crown and chair rail moldings for any room. The library contains a selection of molding profiles. For more information, see “Trim Tools” on page 391 of the Reference Manual.

To add crown molding to a room

Moldings can be added in floor plan or any camera view. So that you can see the results more quickly, begin by creating a camera view of the master bedroom. See “To create a camera view” on page 39 for information about using the **Full Camera**  tool.

1. Click the **Select Objects**  button or press the Spacebar, then click in a blank space on the floor of the room to select it.
2. Click the **Open Object**  edit button to open the **Room Specification** dialog for the master bedroom.
3. On the **MOLDINGS** panel:

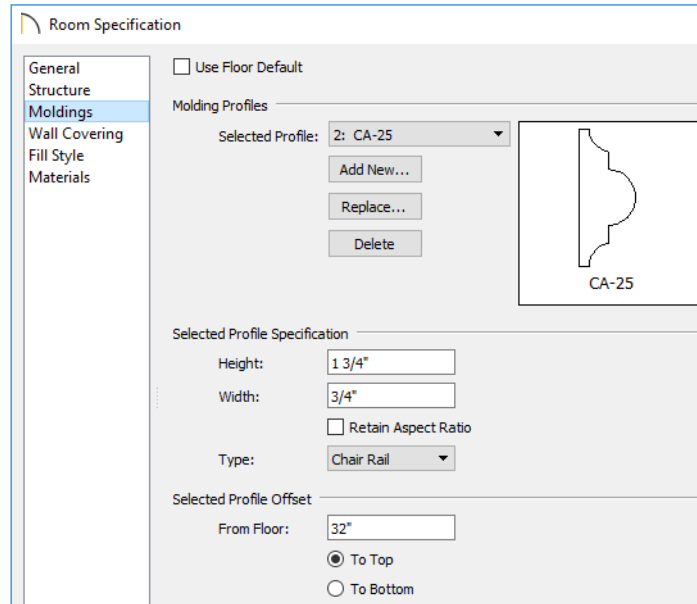

- Uncheck **Use Floor Default**, and then click the **Add New** button.
- In the **Select Library Object** dialog, either search or browse to find a chair rail profile that you like. When you find one, select it and click **OK**. For more information, see “Select Library Object Dialog” on page 415 of the Reference Manual.
- If you wish, you can specify the **Height** and **Width** of the selected molding. In this tutorial, a **Height** of 2 inches is specified.
- Select "Chair Rail" from the **Type** drop-down list.
- Notice that the **From Floor** value equals the room’s Finished Ceiling Height on the **STRUCTURE** panel. Set this value to 32" inches.
- Click **OK** to close the **Room Specification** dialog.

Crown moldings can be applied to a room in the same manner. Base moldings are already applied in most room types by default, but can be edited, removed or added here, as well.



When you have finished, remember to **Save**  your work.

Applying Wall Coverings

Wall coverings can be used in addition to a wall's surface material to create accents like wallpaper borders or wainscoting. For more information about wall coverings, see “Wall Materials” on page 167 of the Reference Manual.

To apply a wall covering

1. Select the master bedroom and click the **Open Object**  edit button to open the **Room Specification** dialog.
2. On the WALL COVERING panel:

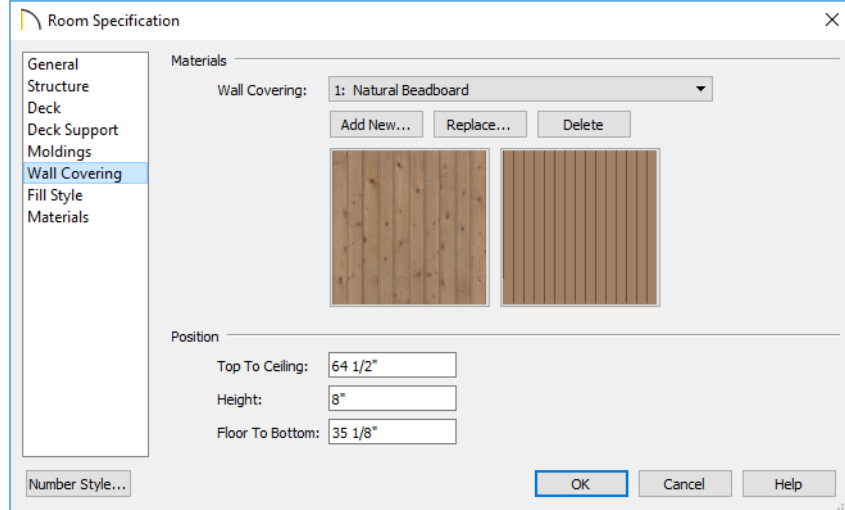

- Click the **Add New** button to open the **Select Material** dialog.
- Select an appropriate material for your wall covering, and click **OK**. In this example, a Natural Beadboard material is used.
- Change the **Height** to 28 inches, and change the **Floor to Bottom** value to 3 1/2 inches to allow for the distance between the base and chair rail moldings.
- Click **OK** to close the **Room Specification** dialog.



Additional wall covering materials can be downloaded into the Manufacturer Catalogs. See "Downloading Library Content" on page 406 of the Reference Manual.

If you would like, you can continue adding interior elements from the Library Browser before continuing to work on this plan in the Kitchen and Bath Design Tutorial.



Kitchen and Bath Design Tutorial

This tutorial continues where the Interior Design Tutorial left off. You should save this tutorial using a new name to archive your previous work.



The tools and techniques used to design kitchens and bathrooms are very similar. This tutorial focuses on kitchen design. When you're finished you can use what you've learned to finish up the bathrooms as well. In this tutorial you will learn about:

- Adding Cabinets
- Placing Appliances
- Editing Cabinets and Appliances
- Creating a Cabinet Island
- Creating Architectural Blocks
- Editing Cabinets and Appliances
- Working in Elevation Views

Adding Cabinets



Begin by selecting **File> Save As** , and name the plan BeachHouse - Kitchen Bath Tutorial.

To place a base cabinet

1. **Zoom**  in on the Kitchen area in plan view.
2. Select **Build> Cabinet> Base Cabinet** .
3. Click to place a base cabinet anywhere in the kitchen.

Once a cabinet is placed, it can be edited like other objects.

To select and edit a cabinet

1. Cabinets can be selected using one of the following methods.
 - Click on the cabinet while the **Select Objects**  tool is active.
 - Click on the cabinet while any of the **Cabinet Tools**  are active.
 - Right-click on the cabinet when another tool is active.
2. When the cabinet is selected, edit handles and a front indicator display. The arrow that displays when the pointer is held over an edit handle as well as the Status Bar indicate what function that handle will perform. See “Editing Box-Based Objects” on page 120 of the Reference Manual.

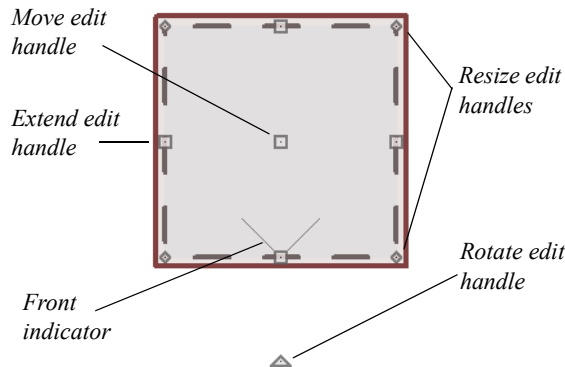

- Move a cabinet using the Move edit handle. By default, you can move a cabinet parallel to its sides or its front and back edges. To allow unrestricted movement, hold down the Ctrl key or click and drag using the right mouse button.
 - Resize two sides of a cabinet using a Resize edit handle, located in each corner.
 - Extend a cabinet's edge on one side using an Extend edit handle.
 - Rotate a cabinet using the Rotate edit handle, which is always offset to one side.
 - A temporary dimension updates as the cabinet is moved or resized.
3. When a cabinet is selected, you can also click the **Open Object**  edit button to open its specification dialog and make a wide variety of changes to the cabinet. For more information, see “Cabinet Specification Dialog” on page 296 of the Reference Manual.

To lay out base cabinets for this tutorial

1. Place and position six base cabinets and edit their widths as shown in the following image:

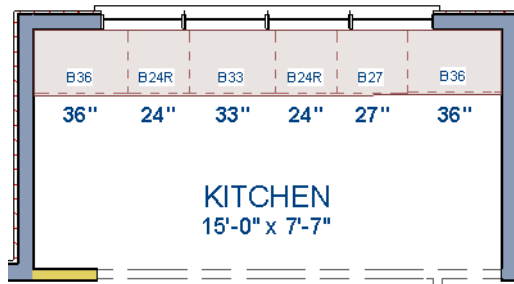



- Two of the cabinets are 36", two are 24" wide, one is 33" and one is 27" wide.
- A cabinet snaps to another if they are in alignment, facing the same direction, and of the same type.

Note: The display of cabinet module lines has been turned on in the following images. See "Displaying Cabinets" on page 290 of the Reference Manual for more information.

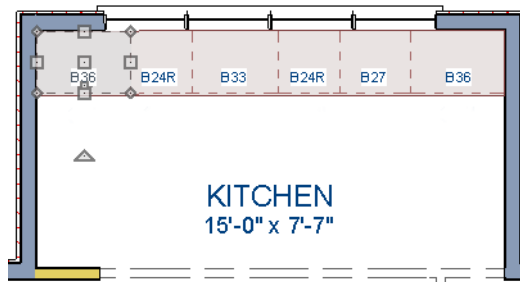

To create corner cabinets

1. Select the 36" wide base cabinet on the left.

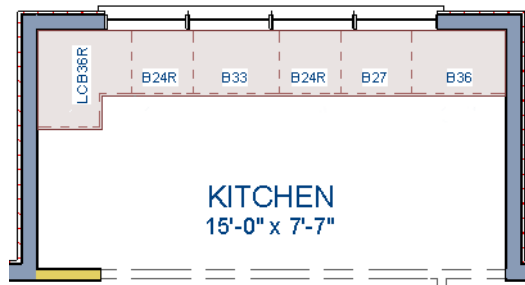

2. Click the **Open Object**  edit button to open the **Base Cabinet Specification** dialog. On the **GENERAL** panel:
 - Specify a **Width** greater than the Depth. The selected cabinet's width should already have been changed to 36", which works well with a 24" depth. If it isn't, change it to 36" now.
 - Click the **Special** drop-down list and select "Corner".
 - Uncheck the box beside **Diagonal Door**.
 - Click OK to close the dialog and apply your changes.



3. With the cabinet still selected, use its Rotate edit handle to rotate it so its back faces the wall corner if necessary.
4. A different approach can be used to create a corner cabinet in the right corner. Begin by selecting the cabinet on the right and pressing the **Delete** key or clicking the **Delete**  edit button.
5. Select **Build> Cabinet> Base Cabinet** , then move your mouse pointer into the corner. When the cabinet preview changes to a corner cabinet, click once.
6. Uncheck **Diagonal Door** for this new cabinet as described in step #2, above.

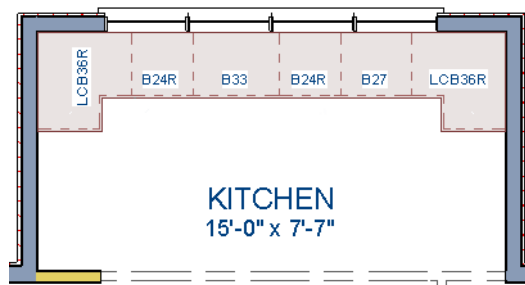



 To move a row of cabinets, select one cabinet, then click and drag the Move edit handle towards the other cabinets. The selected cabinet will push the others. See "Bumping/Pushing" on page 126 of the Reference Manual.

To place wall cabinets

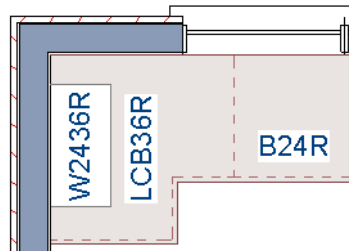
1. Select **Build> Cabinet> Wall Cabinet** .
2. Click above the left corner base cabinet to place a wall cabinet as shown.



3. Click the **Open Object**  edit button to open the **Wall Cabinet Specification** dialog:
 - On the GENERAL panel, specify a **Width** of 33".
 - On the DOOR/DRAWER panel, change the **Door Style** to "Framed", and check the box beside **Glass Doors**.
 - On the MOLDINGS panel, click the **Add New** button to add crown molding to the cabinet.
 In this example, a crown molding profile with a **Height** of 2 1/2", a **Width** of 2 1/2", and a **Vertical Offset** of - 2 1/2" is used. For more details, see "To add crown molding to a room" on page 98.
 - Click **OK** to apply these changes to the wall cabinet.
4. With the wall cabinet still selected:
 - Click the **Copy/Paste**  edit button.
 - Click near the opposite wall to place a second wall cabinet identical to the first.
 - With the new cabinet still selected, click the **Center Object**  edit button.
 - Move your mouse pointer over the original wall cabinet so that it becomes highlighted.
 - When you see a dashed horizontal line running through the original wall cabinet, click once. The dashed line is a centering axis, and the new cabinet will become aligned with the original.

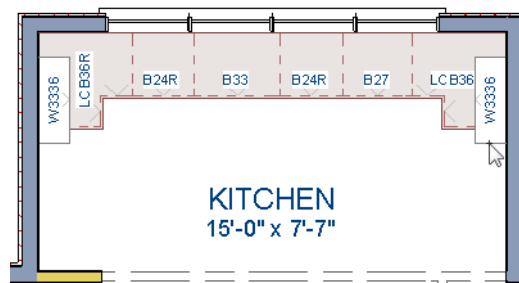



Note: The display of cabinet face indicator lines has been turned on in the following images. See “Displaying Cabinets” on page 290 of the Reference Manual for more information.

With the wall cabinets in place, you may want to add soffits to enclose the space between them and the ceiling.

To place soffits

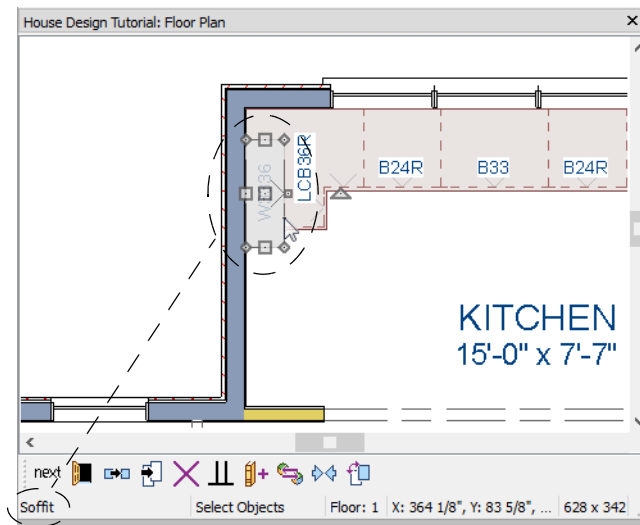
1. Select **Build> Cabinet> Soffit**  then click above the wall cabinets to place soffits.
2. Adjust their width and orientation to match the wall cabinets below.



 When objects are very close to one another in plan view, it may be difficult to select the intended object. When an object is selected, click the Select Next Object edit button or press the Tab key to select a nearby object. See “Select Next Object” on page 107 of the Reference Manual.

For more information about cabinets, see “Cabinets” on page 283 of the Reference Manual.

Placing Appliances

Appliances come in two basic varieties, freestanding and built-in. For more information about library objects such as appliances, see “The Library” on page 399 of the Reference Manual.

To place a freestanding appliance

1. Select **View> Library Browser**  to open the Library Browser.
2. In the Core Catalogs, browse to Architectural> Appliances> Refrigerators, locate a refrigerator, and select it.
3. On the left side of the kitchen, click in the empty space below the base corner cabinet to place the refrigerator.

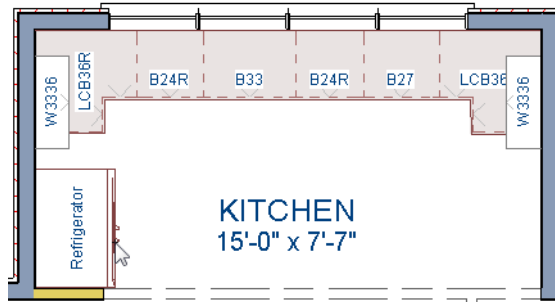

4. In the Appliances catalog, find an electric range and place it in the empty space on the right side of the kitchen.

To place a built-in appliance

1. Select **View> Library Browser**  to open the Library Browser.
2. In the Core Catalogs, browse to Architectural> Fixtures> Sinks, locate a sink, and select it for placement. In this example, the Self Rimming Offset 32" sink is used.
3. Click on the base cabinet near the top of the screen that is 33" wide to insert the sink into that cabinet.
4. In Core Catalogs> Architectural> Appliances> Dishwashers, select a dishwasher for placement, and click on the cabinet to the right of the sink.

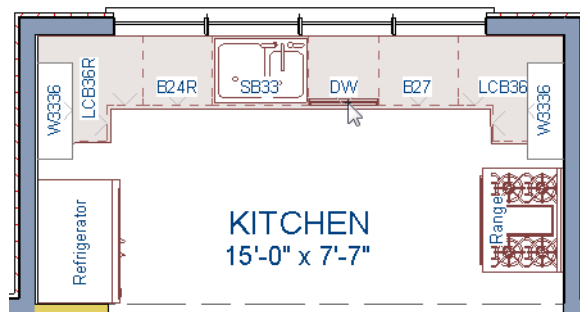

Editing Cabinets and Appliances

Like most objects, cabinets and appliances can be edited in their specification dialogs. This method allows a higher degree of customization than using just the edit handles.

To edit cabinet face items

1. Select the cabinet to the left of the sink and click the **Open Object**  edit button to open the **Base Cabinet Specification** dialog.
2. Click on the upper separation between the countertop and the drawer in the preview image on the right side of the dialog. Notice that clicking anywhere on the preview takes you to the FRONT panel.
3. On the FRONT panel:
4. Uncheck **Use Default**, then click the **Add New** button to open the **New Cabinet Face Item** dialog.

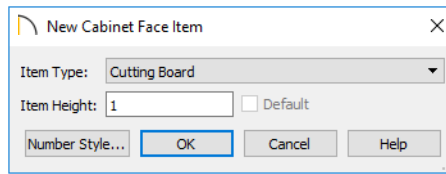

5. Select "Cutting Board" from the **Item Type** drop-down list, assign an **Item Height** of 1 inch and click **OK** to return to the **Cabinet Specification** dialog.
6. A new Cutting Board face item, as well as a new Separation, are added below the separation that you selected.
7. Click OK to close the **Base Cabinet Specification** dialog.

These steps can be used to create a wide variety of cabinet front configurations, such as a bank of drawers.

To edit appliances in the Fixture Specification dialog

1. Select the refrigerator and click the **Open Object**  edit button to open the **Fixture Specification** dialog.
2. On the GENERAL panel, change the **Depth** to 28.
3. Check the box next to **Reverse Symbol** and click **OK**.

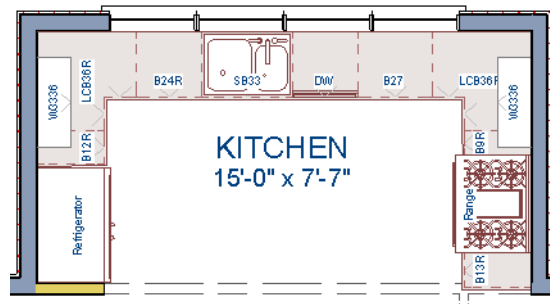

Finally, add some narrow base cabinets to fill in the gaps beside the appliances. You can also add a wall cabinet and soffit above the range.



Creating a Cabinet Island

A cabinet island with custom countertop can also be created using the Cabinet Tools. For more information, see “Editing Custom Countertops” on page 289 of the Reference Manual.

To create a cabinet island

1. Select **Build> Cabinet> Base Cabinet** , then click to place a base cabinet in the middle of the kitchen area.
2. Select the cabinet and click the **Open Object**  edit button to open the **Base Cabinet Specification** dialog.
3. On the GENERAL panel, specify a **Width** of 33" and a **Depth** of 27".
4. On the FRONT panel, create three **Double Drawers**, each with an **Item Height** of 7 1/2". See “To edit cabinet face items” on page 110.

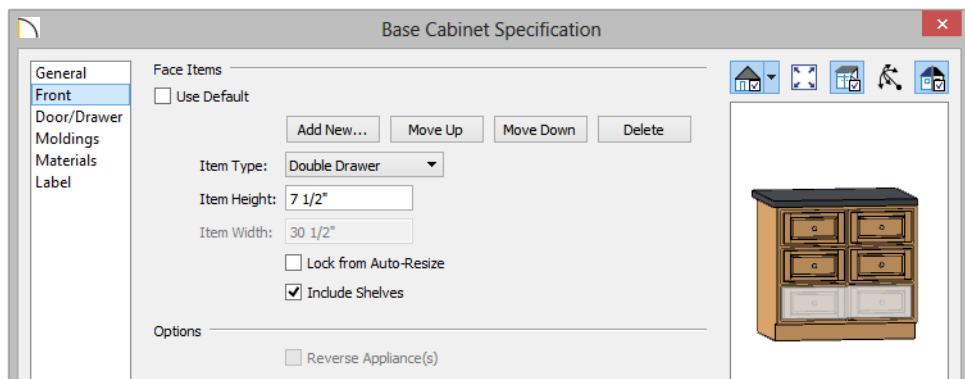

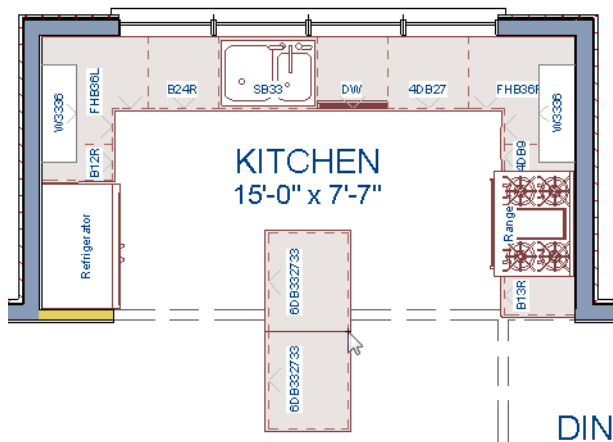

5. On the DOOR/DRAWER panel, set the Drawer Handle **Style** as "Knob", then click **OK** to close the dialog and apply your changes.

6. With the base cabinet still selected, click the **Copy/Paste**  edit button, then:
 - Click and drag the Move edit handle downward on screen until the preview outline snaps directly below the existing cabinet.
 - Release the mouse button to create a copy of the original cabinet, as in the image below:



In the next portion of this tutorial, the display of cabinet labels is turned off. To do this, select **Tools> Display Options** . In the **Layer Display Options** dialog, locate the "Cabinets, Labels" layer, remove the check mark in the **Disp** column, and click **OK**.

To create a custom countertop

1. Click the **Select Objects**  button, then click on the island cabinet closest to the sink to select it.
2. Click the **Generate Custom Countertop**  edit button. A new Custom Countertop polyline will be created, replacing the cabinet's countertop, and will be selected.
3. With the new custom countertop selected, use its edit handles to reshape it so it covers all of the island cabinets.
4. Click on the bottom vertical edge of the countertop polyline to make it the Selected Edge. For more information, see "Selected Edge" on page 106 of the Reference Manual.
5. Click the **Change Line/Arc**  edit button to change the Selected Edge from a straight line into a curved arc.
 - Use the triangular Reshape edit handle located along the arc's radius to adjust the curvature of the arc.
 - To temporarily suppress snapping, you can hold down the Ctrl key while you drag the Reshape handle.

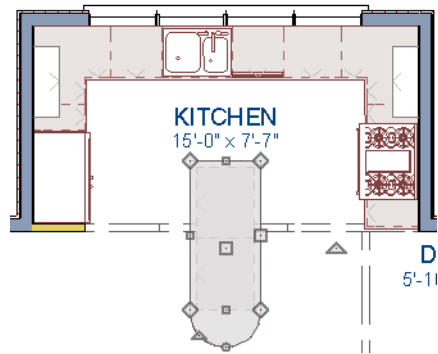

6. Create a **Full Camera**  view to see the results.



A Custom Countertop can also be drawn using the **Custom Countertop**  tool and have an edge molding applied to it. For more information, see “Custom Countertops” on page 288 of the Reference Manual.

Creating Architectural Blocks

Groups of architectural objects can be blocked together and saved to the library for use in other plans. See “Architectural Blocks” on page 423 of the Reference Manual.

To create an architectural block

1. In plan view, group select all objects you would like to include in the architectural block.

2. One way to group select the objects is to hold down the **Shift** key and select additional objects to add them to the selection set. There are many other ways to select and group select objects. For more information, see “Selecting Objects” on page 106 of the Reference Manual.

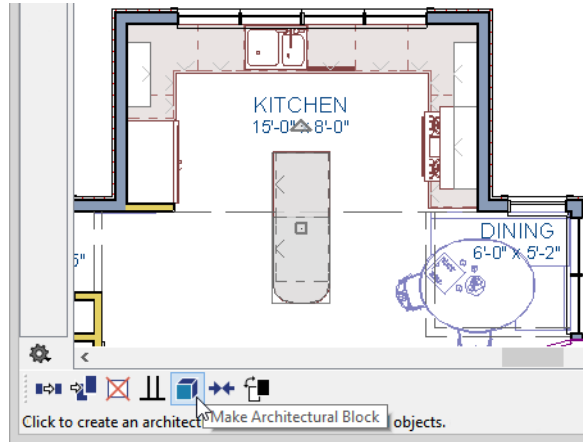

3. Click the **Make Architectural Block**  edit button.

To add an object to the library

1. Select the architectural block.
2. Click the **Add to Library**  edit button to add the architectural block to the User Catalog in the Library Browser.
3. Right-click on the new item in the User Catalog and select **Rename** from the contextual menu to change the name from "Untitled" to something descriptive like "Kitchen Bar".

If you want, you can organize the content in your User Catalog by creating folders and then moving items into those folders. For more, see “Organizing the Library” on page 410 of the Reference Manual.

To explode an architectural block



1. Select an architectural block.
2. Click the **Explode Architectural Block**  edit button.

Working in Elevation Views

Like other objects, cabinets can be edited in elevation views. This method of editing is powerful because it allows objects to be easily edited in vertical space. Next we'll edit wall

cabinets and add a range hood. For more information about working in 3D views, see “Working in 3D” on page 476 of the Reference Manual.

To create an elevation view

1. In plan view, select **3D > Create Camera View > Elevation** . Click and drag a line of sight pointed directly at the range.
2. **Zoom**  in as needed.



To edit the cabinets in an elevation view

1. Click the **Select Objects**  button, then click on the wall cabinet above the range.
2. Click on the cabinet's bottom edit handle and drag it upwards.

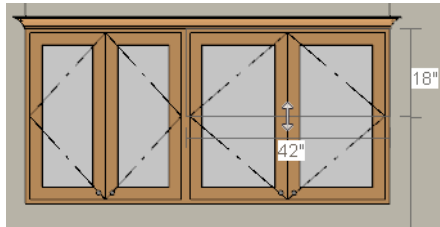

3. When the temporary dimension indicates that the cabinet height is 18 inches, release the mouse button.

To place a range hood



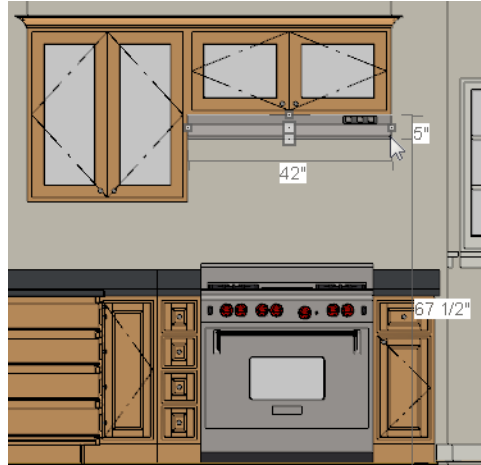

1. Find a range hood in the Fixtures catalog and select it for placement.
2. Click above the range to place the hood.
3. If necessary, you can adjust its position and size using its edit handles.
4. When you are finished, Close  the elevation view and return to plan view.



Finishing Touches

A wide variety of furniture, accessories, and other items is available in the Library Browser at Core Catalogs> Interiors, which you can use to furnish this and other plans.

To use the Cross Section Slider tool

1. In plan view, click **Fill Window** .
2. Create a **Full Camera**  view that begins on the exterior of the structure, near the kitchen, and release the mouse button in the kitchen. See “To create a camera view” on page 39.
3. Use the **Mouse-Orbit Camera**  tool to adjust the camera’s perspective. If you want, you can turn off the display of the backdrop in the **Camera Specification** dialog. For more information, see “3D Backdrop Panel” on page 481 of the Reference Manual.
4. Select **3D> Cross Section Slider**  to open the **Cross Section Slider** dialog.

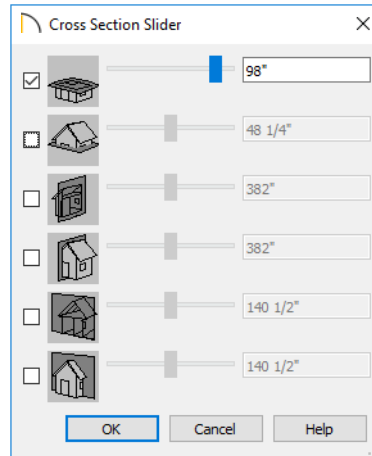

5. Select the horizontal cut line and use the **Position** slider to specify the location of the cutting plane. See "Cross Section Slider" on page 475 of the Reference Manual.



6. Be sure to **Save**  your work.

If you would like, you can continue working on this plan in the Materials Tutorial.

Materials Tutorial

Materials display on the surfaces of objects in 3D views and can make a 3D view appear highly realistic. When applied to most objects, material quantities will also be calculated in the Materials List.

This tutorial continues from where the Kitchen and Bath Design Tutorial ended. You may want to save this tutorial using a new name to archive your previous work. In this tutorial you will learn about:

- Setting Materials Defaults
- Using the Materials Panel
- Using the Material Painter
- Blending Colors with Materials
- Using the Material Eyedropper
- Custom Materials, Images, and Backdrops
- Generating a Materials List

Setting Materials Defaults

Material default settings determine the materials used by different objects when they are initially created. Setting the correct material defaults before beginning a project may help you save time. For more information, see “Preferences and Default Settings” on page 63 of the Reference Manual.

To set material defaults

1. Select **Edit > Default Settings**  to open the **Default Settings** dialog.

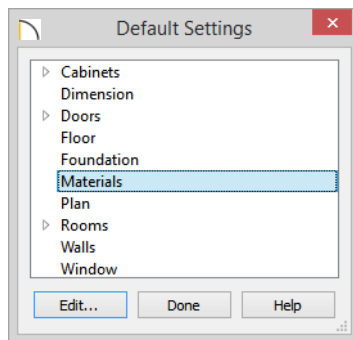

2. There are two options. You can do either or both:
 - Select an item in the tree list and click the **Edit** button to open the defaults dialog for that type of object. The default dialogs for architectural objects such as doors and windows have a **MATERIALS** panel that allows you to set the material defaults for object components. See “Using the Materials Panel” on page 121.
 - Select **Materials** and click the **Edit** button to open the **Material Defaults** dialog. Here you can set the material defaults for many different objects, including some that do not have default dialogs. See “Material Defaults” on page 438 of the Reference Manual.

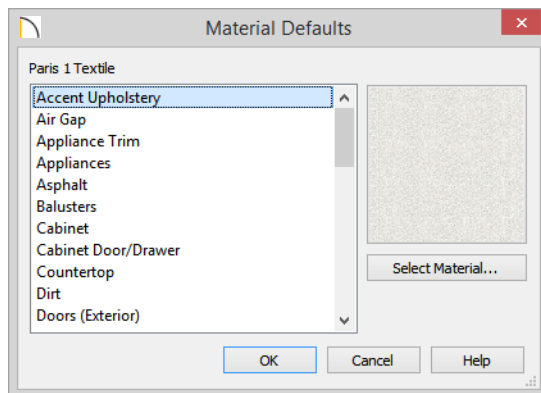



3. When you are finished, click **OK** to close the defaults dialog, then click **Done** to close the **Default Settings** dialog.

Once an object has been placed in a plan, the materials applied to it can be changed in a number of ways.

Using the Materials Panel

Most objects' materials can be assigned in their specification dialog in both 2D and 3D views. The materials used by a door, for example, can be edited on the **MATERIALS** panel of the **Door Specification** dialog. For more information, see “Materials Panel” on page 442 of the Reference Manual.

To change material on an object using the Materials panel

1. Click the **Select Objects**  button, then click on the double door leading from the master bedroom to the deck on Floor 2 to select it.
2. Click the **Open Object**  edit button to open the **Door Specification** dialog.
3. Select one of the door's components from the list on the left.

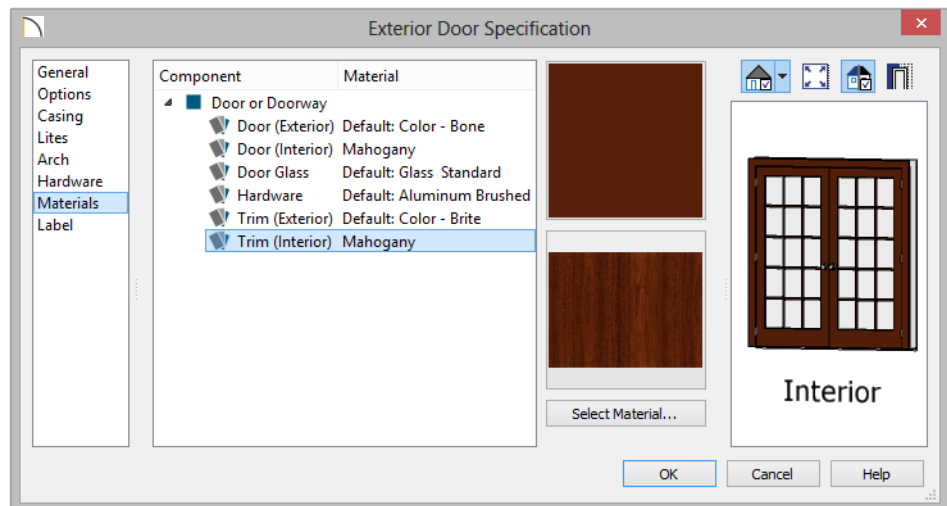

- Click on the name of a material component in the tree list to select it.
 - Click the **Select Material** button to open the **Select Material** dialog.
4. Find and select a material and click **OK**. to apply it to the selected component.
 5. You can continue to specify component materials. The preview in the dialog updates as changes are made. When finished, click **OK** to close the specification dialog.

6. Create a **Full Camera**  view of the door to see the results.



The materials used in individual rooms can also be specified. Rooms can be selected in both floor plan and 3D views:

- In floor plan view, click in an empty space within a room. When selected, the whole room is highlighted. If you accidentally select an object other than the room, you can press the Tab key on the keyboard until the room is selected.
- In camera views and overviews, click on the floor of the room to select it.

To edit a room using the Materials panel

1. Select the master bedroom and click the **Open Object**  to open the **Room Specification** dialog.
2. In the tree list on the MATERIALS panel, select "Molding" under the Crown Molding component and click the **Select Material** button.
3. In the **Select Material** dialog, select a material and click **OK** to close the dialog.
4. Click **OK** to close the **Room Specification** dialog.

5. The results can be seen in a **Full Camera**  view.

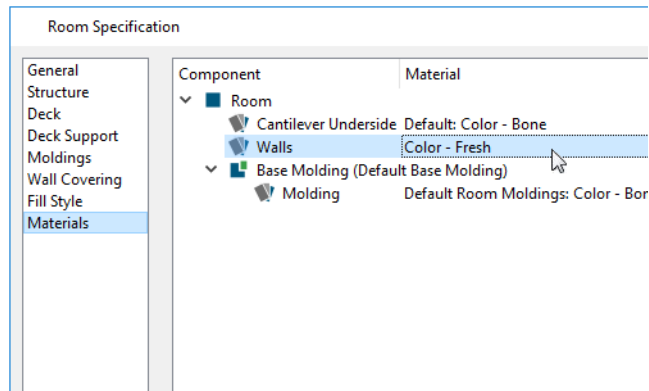



Using the Material Painter

The **Material Painter**  tool allows you to select a material and then apply it to an object in a 3D view.

There are five Material Painter Modes which specify how broadly or narrowly the selected material will be applied to surfaces in your plan. In this tutorial, the **Component Mode** is used. For more information, see “Material Painter Tools” on page 439 of the Reference Manual.

To apply a material using the Material Painter

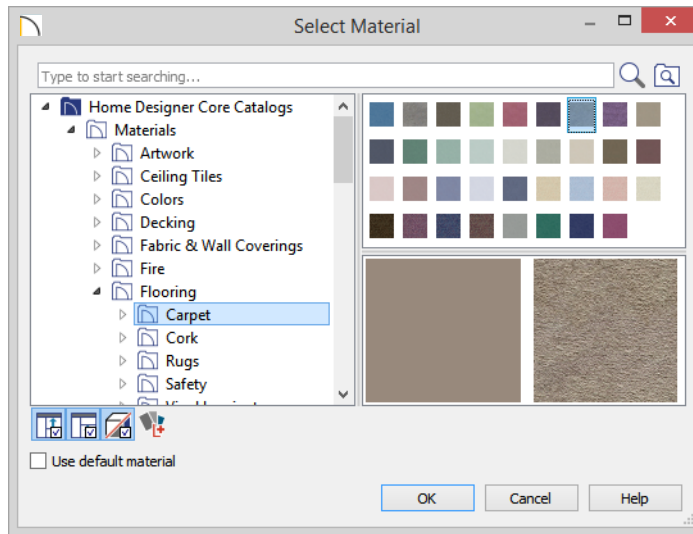

1. While still in the 3D view of the door, select **3D> Material Painter**  and confirm that there is a checkmark next to **Material Painter Component Mode** .
2. Click the **Material Painter**  button to open the **Select Material** dialog. Browse to **Flooring> Carpeting**, select a carpet material, and click OK.





3. Move your cursor into the 3D view and notice that it displays a spray can icon .
4. Click on the floor of the master bedroom to apply the selected material to that surface, which is a component of the room.



 You can also place an area rug symbol from the library and assign to it whatever material you wish. See “Placing Library Objects” on page 413.

With the **Material Painter**  tool you can apply a material to nearly any surface, including many that can't be individually selected like the base molding on a wall or the frame of a window. When either the **Component**  or **Object**  Modes is active, you can continue to apply the selected material to objects until a different tool is selected.



To add artwork to a frame

1. A variety of frames can be found in the Interiors library category. Place a wall or desk frame in your plan and create a camera view in which it can be seen.
2. Select **3D> Material Painter** and confirm that there is a checkmark next to **Material Painter Component Mode** .
3. Click the **Material Painter**  button to open the **Select Material** dialog and choose a painting, photo or print from the Artwork library.
4. Move your cursor over the middle area of the frame and click to apply the selected artwork.









The artwork displayed in a frame can also be specified in the frame's specification dialog. See "Symbol Object Specification Dialogs" on page 419 of the Reference Manual.

Blending Colors with Materials

Instead of using the **Material Painter**  to replace a material with a new one, you can use it with the **Blend Colors With Materials**  feature to blend a color with a textured material such as the carpet in the master bedroom and create a new material. For more information, see



“Blend Colors With Materials” on page 441 of the Reference Manual.

To blend a color with a texture



1. In a 3D view, select **3D> Material Painter> Material Painter** .
2. In the **Select Material** dialog, select a solid color for the carpet from the Generic Colors library, then click OK.
3. When you move your cursor into the view, it displays a paint roller icon .
 - When **Blend Colors with Materials**  is active and a solid color is loaded in the Material Painter, your cursor displays the paint roller icon .
 - If you see the spray can icon  instead, select **3D> Material Painter> Blend Colors With Materials**  to turn this feature on.
4. Click on the carpet to blend the selected color with the carpet texture. The result is a new material with the textured appearance of the carpet as well as the color you selected.



Using the Material Eyedropper

The **Material Eyedropper**  tool allows you to load a material that can be seen on a surface in a 3D view into the **Material Painter**  tool and then apply it to another surface. For example, in the master bedroom the wood material assigned to the crown molding is different

than the material assigned to the chair rail and base molding. They can easily be made the same using the **Material Eyedropper**  tool.

1. Return to the Camera view.
2. Select **3D> Material Painter> Material Eyedropper**  and notice that the mouse pointer displays an eyedropper icon .



3. Click once on the crown molding to load the wood material. Notice that the mouse pointer changes to a spray can , indicating that the loaded material is ready to apply to another object.

4. Click on the chair rail and base moldings to apply the loaded material.



Custom Materials, Images, and Backdrops



Home Designer Architectural allows you to customize your 3D views by importing your own materials, image objects, and backdrops that display in 3D views. For more information about images, see “Pictures, Images, and Walkthroughs” on page 503 of the Reference Manual.

Note: The following steps make use of image files that are not included with the program. You can use your own image files to create materials, images, and backdrops.

Creating Materials

You can create your own custom materials and save them in the library for use in any plan. Many materials are represented in 3D views using textures, which are digital images that have been specially edited to tile seamlessly when applied to a 3D surface. Bear in mind, therefore, that not all images will necessarily serve as effective material textures.

To add a new material to the library

1. Select **View> Library Browser**  or press Ctrl + L to open the Library Browser.
2. Right-click on the User Catalog and select **New> Material**  from the contextual menu.
3. In the **Define Material** dialog, give the new material a short, descriptive **Name**.

4. Click the **Texture** radio button, then click the **Browse** button to open the **Select Texture File** dialog, where you can choose an image file saved on your computer to be the new material's texture.

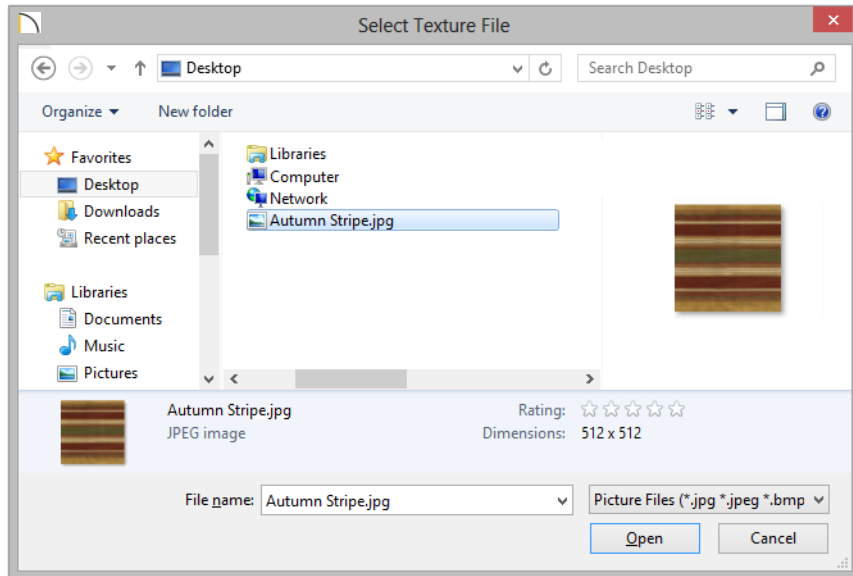

5. Select an image file and click the **Open** button to return to the **Define Material** dialog.

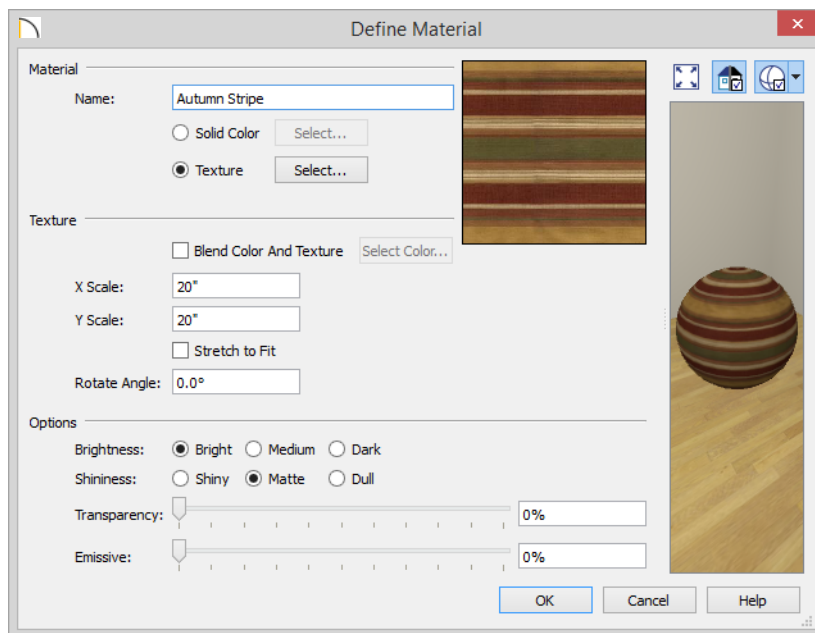

6. Specify the **Scale** of the texture, which controls how large the image will appear on the surfaces it is applied to.
7. Under the Options heading, Specify additional attributes of the material. A Matte material will most closely resemble cloth, which is what this material will be used for.
8. Click **OK** to add the new material to the **User Catalog**.

For more information, see “Define Material Dialog” on page 450 of the Reference Manual.

Creating Images

In Home Designer Architectural, image objects are more than just 2D pictures. Images have size and height attributes and can contain transparency information. In floor plan view, they display only as 2D symbols; but in 3D views, the visual information that images contain can be seen.

To create an image and save it to the library

1. Right-click on the User Catalog folder, then select **New> Image**  from the contextual menu to open the **Image Specification** dialog. For more information, see “Image Specification Dialog” on page 506 of the Reference Manual.

2. On the **IMAGE** panel, click the **Browse** button and browse to an image file saved on your computer. Here, an image of a cat that has transparency data associated with it is used; however, you can use any image.

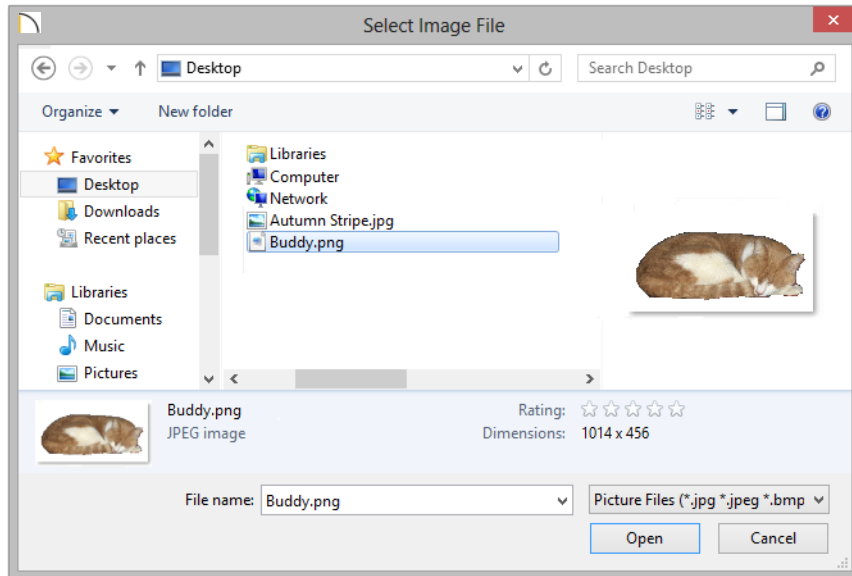

3. Click **Open** to return to the **Image Specification** dialog.
4. On the **IMAGE** panel, enter the **Height** or **Width**, adjusting one will adjust the other, maintaining the correct proportion. Enter a **Height Above Ground** value to specify the

elevation at which the image displays. A value of 24 inches works well in this case as we'll be placing the image on a piece of furniture.

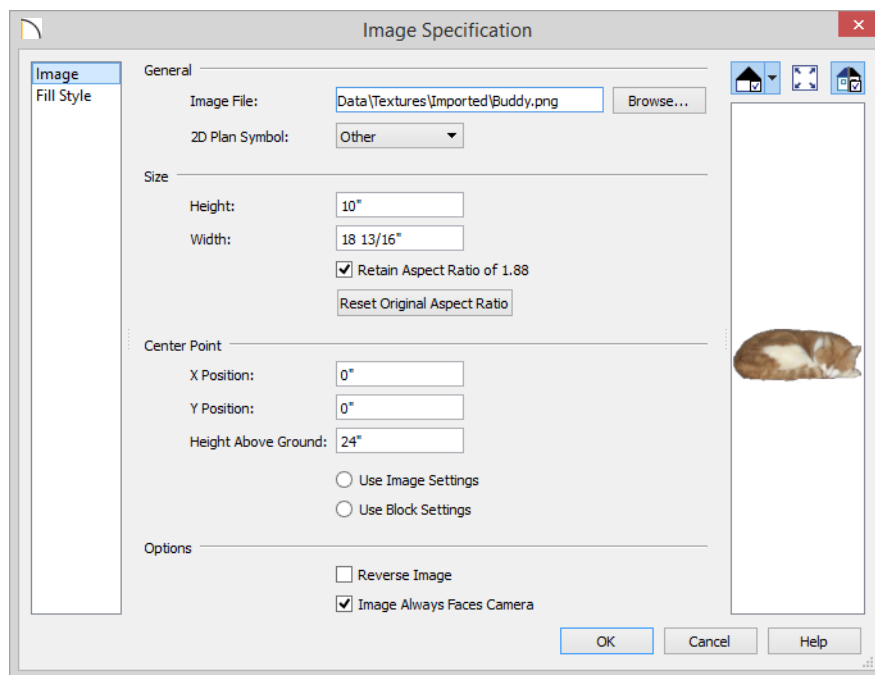

5. Specify the transparency settings on the TRANSPARENCY panel. Since this example is a png file with transparency already applied, selecting **Use Transparency From the Image File** is the best choice.
6. Click **OK** to close the **Image Specification** dialog and add the new image to the **My Images** category in the Images library.

Images can be placed in a plan just as plants, furnishings and fixtures are: by selecting the image and clicking any floor plan view, camera view or overview.

Importing Backdrops

Backdrops are images that display behind 3D views. In Home Designer Architectural, you can take a photo of a site, save it to the library as a backdrop, and display it behind 3D views to create a realistic rendering of your model and its surrounding view.

To import a backdrop and save it to the library

1. Select **File> Import> Backdrop**  and browse to an image on your computer.

2. Select the image and click **Open** to add it to the User Catalog.

To apply a backdrop to 3D views

1. Select **3D > 3D Backdrop**  to open the **Backdrop** dialog.
2. Click the **Select Backdrop** button and in the **Select Library Object** dialog, find and select your new backdrop in the User Catalog and click **OK**.

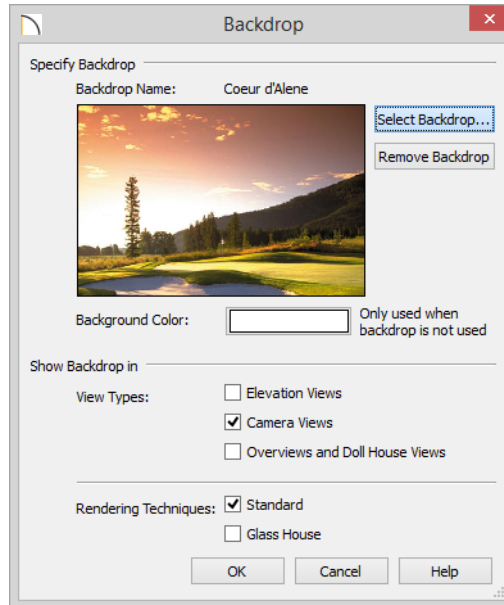

3. Click **OK** to close the **Backdrop** dialog.

You can see your custom material, image, and backdrop by creating a **Full Camera**  view.





Generating a Materials List

To conclude this tutorial, we'll generate a materials list for the house. You can generate a materials list for a single room, an area of the plan on one floor, or the whole plan. For more information, see "Materials Lists" on page 593 of the Reference Manual.



Note: The Materials List is only a rough cost estimate. Always compare the Materials List with a manual take-off before ordering materials for a project.

To generate a materials list for the whole plan



1. Select **Tools> Materials List> Calculate Materials for All Floors** . A materials list is generated for all floors of the house.
2. Locate the an item, such as one under the Fixtures category.
3. Click in the "Price" column and type in a value. Notice that the subtotal and Total both update to reflect the pricing change. You can specify prices for every material in your plan, allowing you to generate a cost estimate.
4. If you wish, you can select **File> Export Materials List**  and save the list as a Tab-delimited **.txt** file, which can be opened in a spreadsheet application.

Close the materials list by selecting **File> Close Window** from the menu. You can generate a materials list to estimate the cost of an entire plan or just a portion of a plan. For more information, see "Materials Lists" on page 593 of the Reference Manual.

To calculate a materials list for an individual room

1. Click the **Select Objects**  button, then click in a room to select it.
2. With the room selected, click the **Calculate Materials for Room**  edit button or select **Tools> Materials List> Calculate Materials for Room** . The program calculates a list of the objects and materials contained in the selected room.

To calculate a materials list for just the deck

1. In floor plan view, select **Tools> Materials List> Calculate from Area** .
2. Click and drag a rectangle surrounding the an area to display a materials list for the area within the rectangle. The resulting materials list only includes objects and materials located within the rectangle.
3. When you have finished, remember to **Save**  your work.

When you are ready, you can continue working on this plan in the Landscaping Tutorial.

Landscaping Tutorial

This tutorial describes how to use Home Designer Architectural's Terrain Tools. In it, you will learn how to add elevation information to your terrain, how to create terrain features, and how to add plants and other objects from the library.

It is a good idea to become familiar with the Terrain Tools before beginning your own terrain project.

In this tutorial, you will learn about:

- Creating a Terrain Perimeter
- Creating a Walkout Basement
- Creating a Retaining Wall
- Adding a Driveway
- Adding Library Objects to Your Plan

This tutorial continues from where the Materials Tutorial left off, so you may want to save this plan using a new name to archive your previous work.

Creating a Terrain Perimeter

The Terrain Perimeter is a closed polyline that defines the boundary of the terrain that generates in 3D views, and of the contour lines that generate in floor plan view. It can also be used to represent a lot boundary. See “Terrain Perimeter” on page 547 of the Reference Manual.

To create and resize a terrain perimeter

1. On Floor 1 of your plan, select **Terrain > Create Terrain Perimeter**  from the menu or click the corresponding toolbar button. See “Toolbar Arrangement” on page 77 of the Reference Manual.
 - If this menu option is not available in a given plan file, a terrain perimeter already exists.
2. Select **Window > Fill Window**  to fill the screen with the Terrain Perimeter.

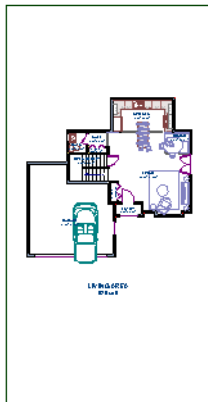

3. Select **View > Temporary Dimensions**  and make sure temporary dimensions are turned on. When they are enabled, a checkmark displays at the bottom corner of the tool icon.
4. Select the Terrain Perimeter by clicking on either the left or right vertical edges. Notice the temporary dimension indicating that the selected edge of the Terrain Perimeter is 100 feet from the opposite edge.
5. Click on the temporary dimension and enter 150 feet using an apostrophe to denote feet (150'), then press **Enter**. The program will default to inches if no apostrophe is included. For more information about using dimensions to relocate objects, see “Moving Objects Using Dimensions” on page 224 of the Reference Manual.

6. Select the top edge of the Terrain Perimeter and use the temporary dimension to position it 200 feet from the opposite edge using the same technique.
7. Click **Window> Fill Window**  to fill the screen with the Terrain Perimeter.

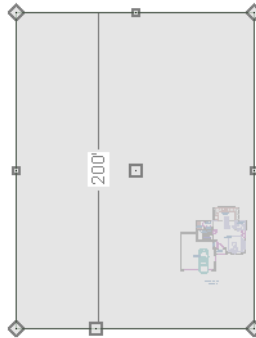



 The Reference Grid, or Virtual Graph Paper, is a visual aid that helps create a sense of scale when drawing. The Reference Grid is turned off for these tutorials but can be turned on or off in the Plan Defaults dialog. See “General Plan Defaults Dialog” on page 66 of the Reference Manual.

Your house may already be centered on the Terrain Perimeter. If it is not, you can move it.

To move the terrain perimeter

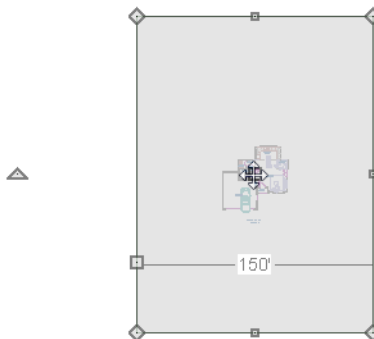
1. Select the Terrain Perimeter and place your pointer over the Move edit handle.
2. Move the Terrain Perimeter so that the house is centered.



In addition to adjusting the size of your rectangular Terrain Perimeter, you can also use the **Change Line/Arc**  and **Break Line**  edit tools to modify its shape.

To edit the shape of the terrain perimeter

1. To place a break on the right segment of the Terrain Perimeter, creating a new corner edit handle at that location, and two separate edges on either side of that handle, use the **Break Line**  edit tool.

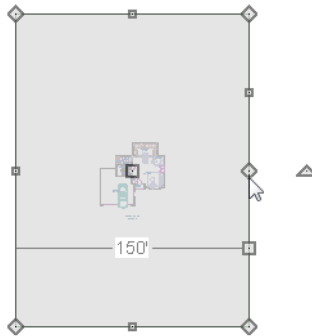

2. You can then use the new edit handles to adjust the size and shape of the Terrain Perimeter. For more information, see “Editing Closed-Polyline Based Objects” on page 117 of the Reference Manual.

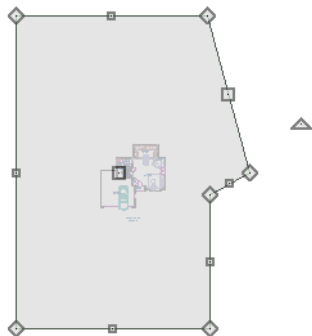

3. Select the bottom edge of the Terrain Perimeter, and click the **Change Line/Arc**  edit button, and notice that this segment changes in to an Arc, which can then be modified using its edit handles. For more information on modifying arcs, see “Editing Arc Based Objects” on page 111 of the Reference Manual.
4. Changes to the shape of the Terrain Perimeter can be seen in 3D views as well as in floor plan view.

- To tile floor plan view and a camera view, select **Window> Tile Vertically** .
- When a 3D view is active, press the I key or the O key to move the camera In or Out.

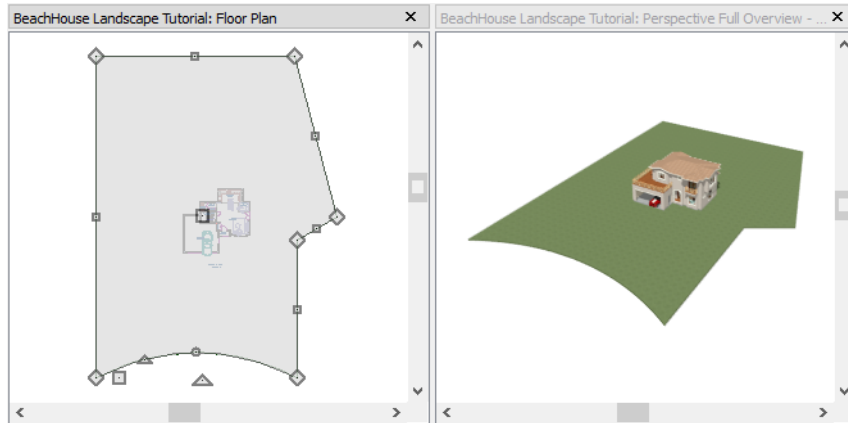



While you can work with two views tiled, you may see slower performance when you do. To avoid this, simply close a 3D view when you are done viewing or working in it.

Creating a Walkout Basement

Our terrain is currently flat because there is no elevation data in the plan. For more information about elevation information, see “Elevation Data Tools” on page 549 of the Reference Manual.



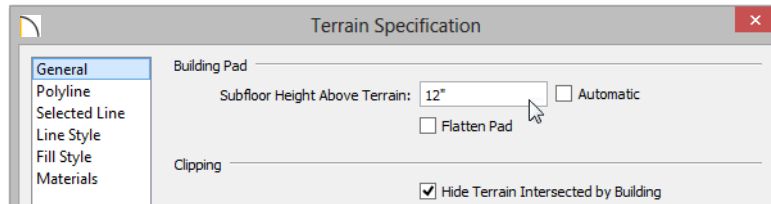

To add elevation information to your plan

1. Select **Window> Fill Window**  to fill the window with the Terrain Perimeter.
2. Using the **Select Objects**  tool, select the Terrain Perimeter and click on the **Open Object**  edit button to display the Terrain Specification dialog.
3. On the GENERAL panel, make sure **Flatten Pad** and **Auto Calculate Elevation** are unchecked, and change the **Subfloor Height Above Terrain** to 12 inches.

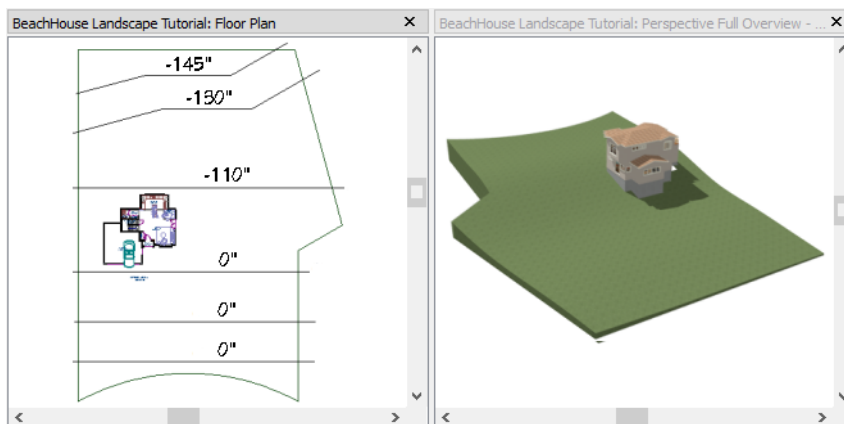

- **Flatten Pad** flattens the building pad around the house. When this is unchecked, the terrain can slope where it intersects the house.
 - **Auto Calculate Elevation** places the house at average terrain height. When this is unchecked, the building's height relative to the terrain can be specified.
 - The **Subfloor Height Above Terrain** is the distance between the default floor height of Floor 1 and a terrain elevation of 0". In this example, an Elevation of 12 inches is used to lower the terrain 12 inches below the first floor.
4. Click OK to close the **Terrain Specification** dialog.
 5. Next, Select **Terrain> Elevation Data> Elevation Line**  and draw elevation lines as shown in the following image.
 - When the ends of an Elevation Lines are drawn near one another, they will snap together to form a polyline.



6. To enter elevation information, click the **Select Objects**  button and select an Elevation Line.
7. Click the **Open Object**  edit button and on the ELEVATION panel of the **Elevation Line Specification** dialog, enter an Elevation value.
 - Values entered are in inches unless the foot (') mark is added.
 - Negative values should be preceded with a hyphen (-).
8. Select **Terrain> Build Terrain**  and notice the contour lines that are created in floor plan view in between the Elevation Lines that you drew.
9. To make it easier to draw, you may want to turn off the display of these lines. Select **Tools> Display Options**  to open the **Display Options** dialog. Remove the check from the Disp column for the layer "Terrain, Primary Contours" and click OK. See "Display Options Dialog" on page 100 of the Reference Manual for more information.



Creating a Retaining Wall

Adding a retaining wall helps create a flat building pad near the garage. For more information see “Retaining Walls” on page 556 of the Reference Manual.

To draw a retaining wall

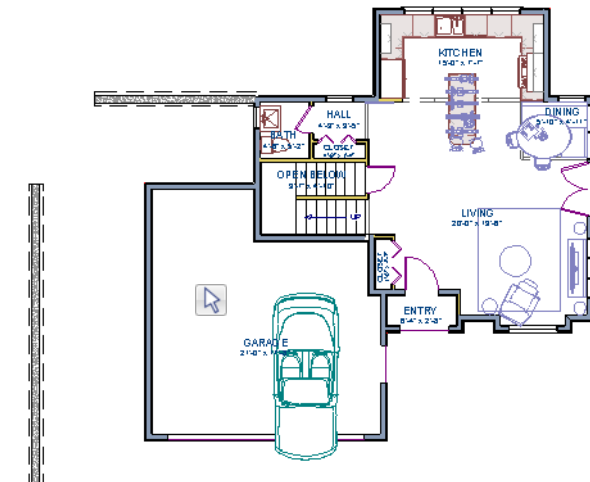
1. Go to Floor 1.
2. Select **Terrain> Wall and Curb> Straight Retaining Wall** . Draw two straight wall sections as shown in the following image.



3. Select **Terrain> Terrain Wall and Curb> Curved Retaining Wall**  and draw a curved retaining wall that connects at both ends to the two straight sections. Don't worry about the angle now: it will be adjusted in a moment.
4. Click the **Select Objects**  button, then click and drag the small triangular Reshape edit handle that displays along the curved wall. As you drag this handle, the curved wall's centerpoint and length change.

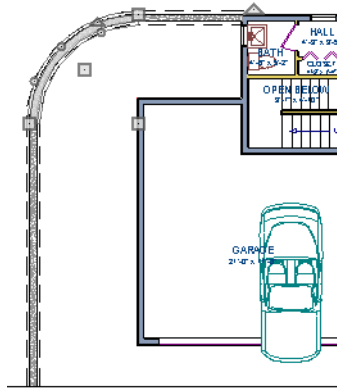

5. Draw two **Elevation Lines**  just inside the retaining wall to define the height of this area when terrain is generated. These Elevation Lines can stay at their default height of 0".

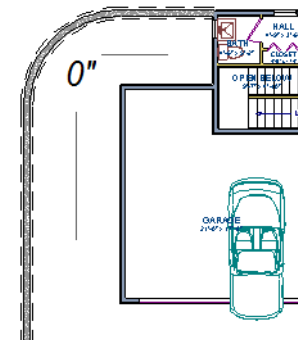

6. Take a look in a **Full Overview** . Your plan should look similar to the image below.





 Open 3D views are redrawn whenever changes are made to the plan, even if the 3D views are not active. Closing 3D views when they are not needed will help maximize your computer's performance.

Adding a Driveway

A driveway can now be added to the plan.





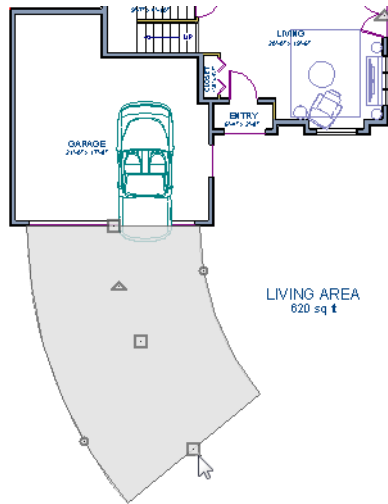

To add a driveway to the plan

1. Select **File> Close** to return to floor plan view. You should still be on Floor 1.
2. Click the **Fill Window**  button to fill your screen with the Terrain Perimeter.
3. Select **Terrain> Road and Sidewalk> Driveway Area**  then click and drag to draw a driveway.



Once drawn, you can edit the driveway's shape using its edit tools.

To edit the driveway's shape

1. Click the **Select Objects**  button, then click on the driveway to select it.
2. Click the **Break Line**  edit button, then click along any edge of the driveway to place a new corner edit handle at that location. The edge that you clicked on becomes divided into two edges that join at the new handle.
3. Continue adding breaks to create as many edges as you wish. Click the **Select Objects** button when you are finished.
4. With the **Select Objects**  tool active, click and drag any of the edit handles that display along the edges of the driveway to adjust its shape and size as needed.
5. If you would like to change a straight edge into a curved edge, click on that edge to select it and click the **Change Line/Arc**  edit button.
6. To change a curved edge back into a straight edge, select it and click the **Change Line/Arc**  edit button once more.
7. Next, draw a **Terrain> Road and Sidewalk> Straight Road**  and **Terrain> Road and Sidewalk> Straight Sidewalk**  to complete the design.

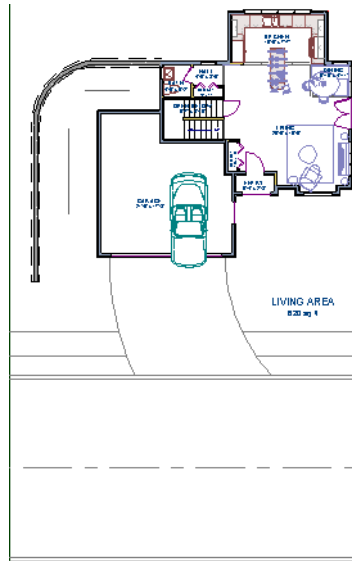



8. Finally, take a look at your plan in a **Perspective Full Overview**  to see the results.







Adding Terrain Features

A beach, a water line, and a pathway to the house can be created using Terrain Features. For more information, see “Terrain Feature Tools” on page 553 of the Reference Manual.

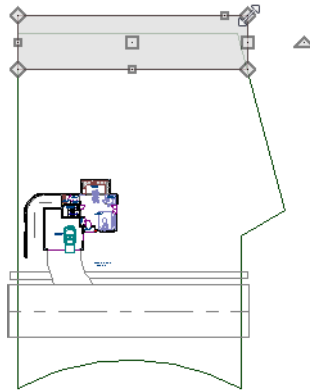
To create a beach

1. Close the overview and return to floor plan view.
2. Select **Window> Fill Window**  then select **Window> Zoom Out**  to give us some working space outside the Terrain Perimeter.
3. Select **Terrain> Feature> Rectangular Feature**  and draw a Terrain Feature that extends to the boundaries of the Terrain Perimeter.



4. Select the Terrain Feature and click the **Open Object**  edit button to open the **Terrain Feature Specification dialog**.
 - On the GENERAL panel, the **Height** should be at 0 inches.
 - On the MATERIALS panel, select the Terrain Feature component in the tree list. Click the **Select Material** button and choose a sand material from the Landscaping folder.
 - Click OK to close the **Select Library Object** dialog then click **OK** to close the **Terrain Feature Specification** dialog and return to floor plan view.
5. With the Terrain Feature still selected, use the **Break Line**  edit tool to place two breaks in the front of the rectangular feature.
6. Next, select one of the segments you have created, and click the **Change Line/Arc**  edit tool, and use the triangular edit handle to adjust the shape of the curved segment, and repeat this procedure for the remaining front segments of the Terrain Feature, as in the image below.

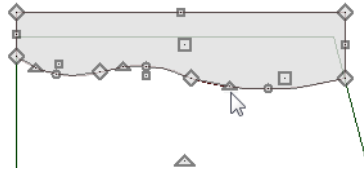



7. Take a look at the new beach in a **Perspective Full Overview** . Notice that only the portion of the Terrain Feature that is included within the Terrain Perimeter is modeled.

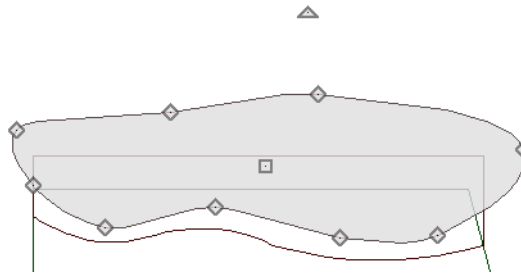

To create a body of water

1. Return to floor plan view, select **Terrain > Water Feature > Round Pond**  and draw another spline feature, within the existing beach Terrain Feature and resize it similar to the following image:



2. Select the pond and click the **Open Object**  edit button. On the **GENERAL** panel of the **Terrain Feature Specification** dialog, raise the **Height** to 1 inch. This will position the water material above the beach.
3. Click OK and take a look in a **Perspective Full Overview** .

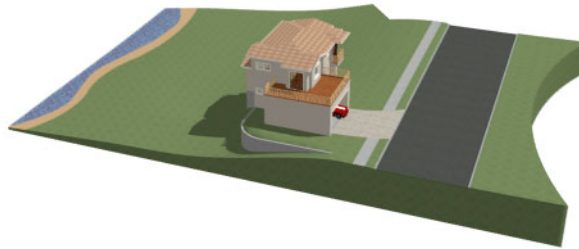

4. Using the techniques described above, you can create nearly any type of landscaping features that you might want, such as raised garden beds, landscaping walls, stone patios and ponds.

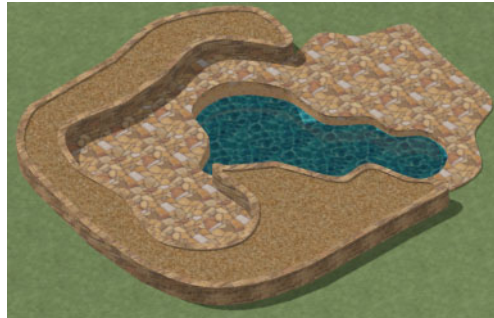



To use an Elevation Region

An Elevation Region contains absolute elevation data for an enclosed region and is ideal for creating a flat surface in your terrain.

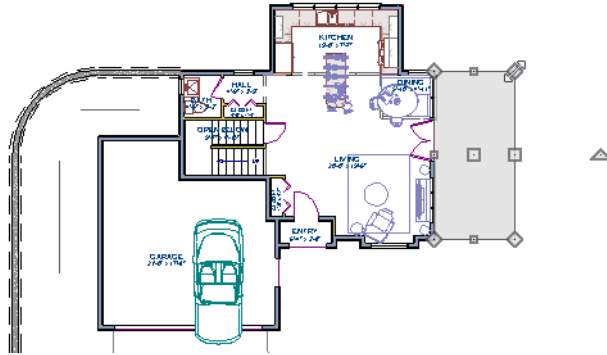
1. Select **Terrain> Elevation Data> Elevation Region** , then click and drag to draw a rectangular region to the right of the structure in front of the door.



2. Select the Elevation Region and click the **Open Object**  edit button. On the ELEVATION panel of the **Elevation Region Specification** dialog, enter an **Elevation** of -8" and click OK.
3. Create a **Perspective Full Overview**  to see the changes that this makes to the terrain.



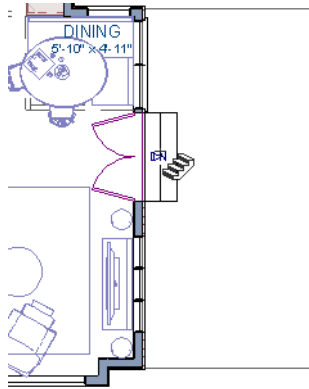

4. Return to floor plan view and select **Build> Stairs> Click Stairs** , then click outside of the doorway to create a set of stairs from the door down to the newly created Elevation Region.

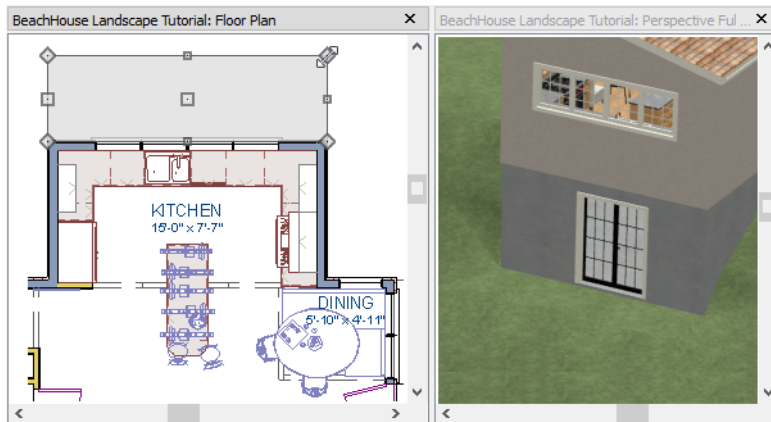

A typical walkout basement has an upper flat area where you enter the house on the first floor, and a lower flat area where you walk out to ground level from the basement. You can create the lower flat region by replacing the Elevation Line at that location with an Elevation Region that has the same Elevation value of -110".



To add fencing and a gate

1. Select **Build> Fencing> Straight Fencing**  then click and drag to create a basic fence.
2. If the Library Browser is not open, select **View> Library Browser**  to open it.
3. In the Core Catalogs, browse to **Architectural> Fences & Railings> Picket Gate**, and click on the fence at the location you want to add the gate.

Adding Library Objects to Your Plan



The library contains many objects that can be added to a landscaping plan such as plant images, exterior fixtures, and outdoor furniture. There are two ways to find objects in the library: by browsing and by searching. For more information about library objects, see “The Library” on page 399 of the Reference Manual.

To browse the Plants library category

1. If the Library Browser is not open, select **View> Library Browser**  to open it.
2. In the Core Catalogs, browse to **Plants> Trees> Deciduous**.
3. Note the many tree species to choose from. Many of these folders contain subfolders with different varieties of that species.

If you know exactly what tree you would like to place in your plan, browsing to it is an efficient way to find and select it; however, with so many options available it is often helpful to perform a search.

To search using the Plant Chooser

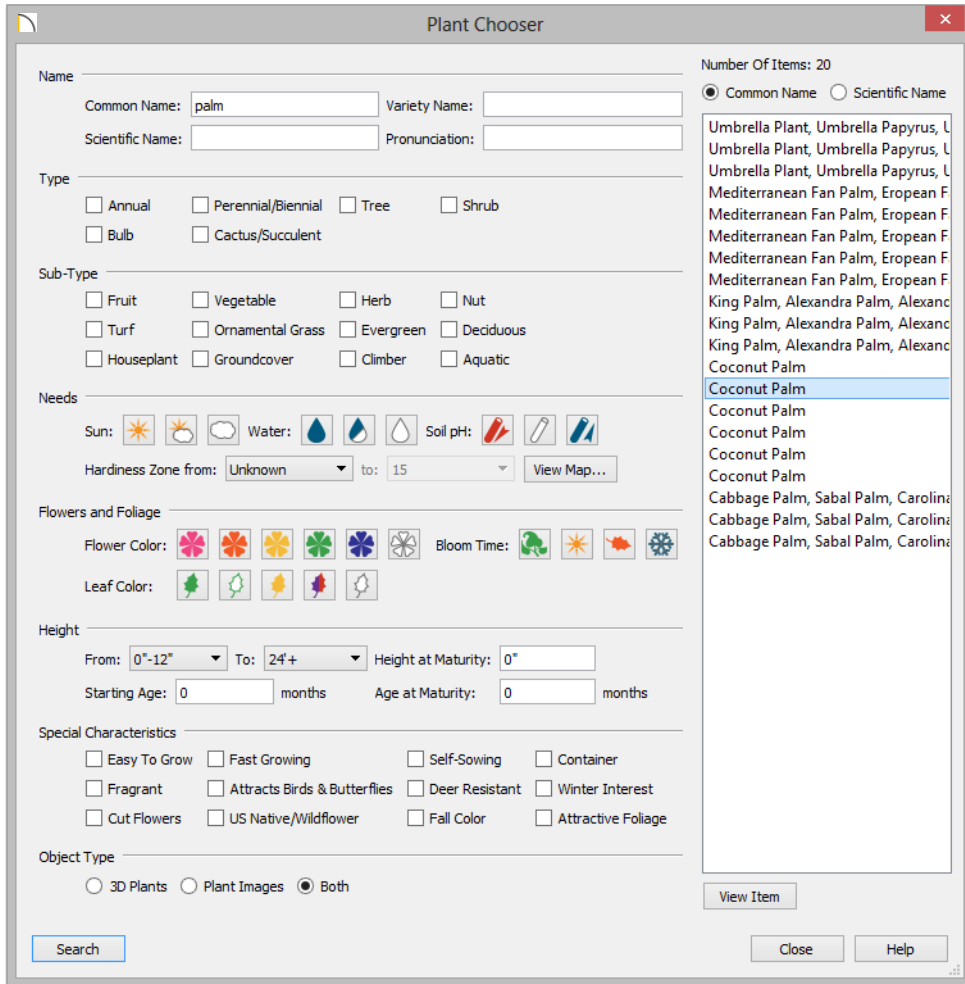

1. With the Library Browser still open, click the **Plant Chooser**  button at the bottom of the Library Browser to open the **Plant Chooser** dialog. This dialog can also be opened by selecting **Terrain> Plant> Plant Chooser** .
2. On the PLANT INFORMATION panel, enter “palm” in the **Common Names** field, and click the **Search** button to see the search results on the right.

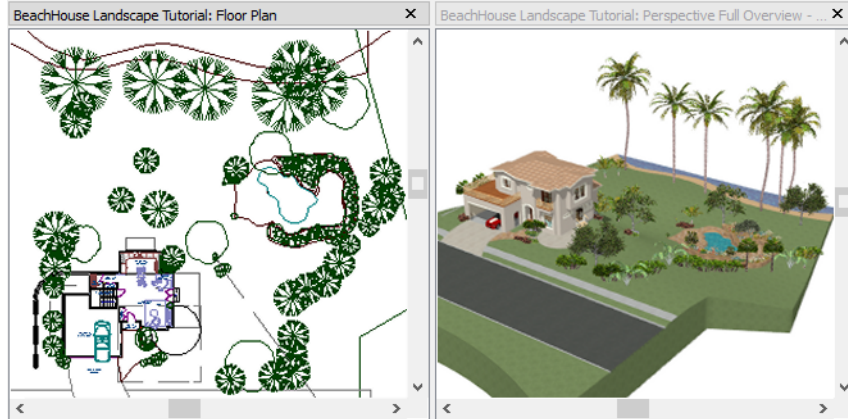

3. Above the search results, move the radio button to **Common Name**.
4. Select a Coconut Palm from the search results, then:
 - Click the **View Item** button to open the **Plant Information** dialog, where you can read size and growing information about the selected plant.
 - Click the **Close** button to close the dialog, locate the plant in the Library Browser, and select it for placement.
5. Click in floor plan view or a 3D view to place the selected plant at that location. You can continue placing the selected plant image until another tool or library object is selected.
6. Repeat this process for any additional plants that you want to place in your design.



Finishing Touches

1. In the Library Browser , expand the Core Catalogs.
2. The Exteriors catalog contains a selection of landscaping, deck and patio accessories, outdoor furniture, and other objects that you can place in your plan.
3. Additional objects, such as Sprinkler Heads, exterior fixtures, and other objects such as rocks can also be added to customize your landscaping design.
4. When you have finished your landscaping design, create a **Full Camera**  view to see the results.



Deck Tutorial

The Deck Tutorial continues where the Landscaping Tutorial left off, and explains how to create a deck off the back of the house and connect it to the terrain with an exterior staircase. You may want to save this tutorial using a new name to archive your previous work.

In this tutorial you will learn about:

- Decks and Porches
- Drawing Decks
- Drawing Stairs
- Changing Planking Orientation
- Adding Exterior Furniture







Decks and Porches

Decks and porches are exterior rooms that are defined by the deck railings and exterior walls that enclose them. When an exterior room is drawn using the **Deck Railing**  tool, the room is automatically assigned the exterior room type of Deck. For more information, see “Room Types” on page 195 of the Reference Manual.



Drawing Decks

Railings and Deck Railings are drawn just like walls. For more information, see “Railing and Deck Tools” on page 156 of the Reference Manual.

To draw a deck

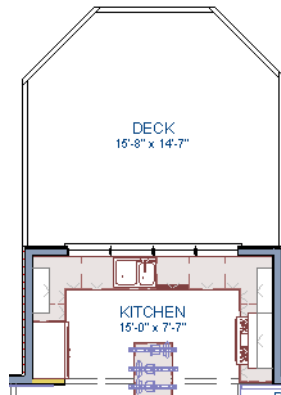
1. In floor plan view, select **Tools> Display Options**  to open the **Display Options** dialog. Click in the Disp column to remove the checkmark for both the "Terrain, Elevation Data" and "Plants" layers and click **OK**. See "Display Options Dialog" on page 100.
2. Make sure **Angle Snaps**  and **Object Snaps**  are turned on.
3. Go to Floor 0 and **Zoom**  in on the back portion of the house.
4. Select **Build> Railing and Deck> Straight Deck Railing** .
5. Draw five Deck Railings as shown in the following image. The angled railings are drawn at a 45° angle to the others. For more information, see "Drawing Walls" on page 25.
 - The Status Bar at the bottom of the program window will state a wall's length and angle as it is being drawn.
 - Notice that when a room is created using **Deck Railing** , the room is automatically specified as a Deck and given a room label.





6. Click the **Select Objects**  button, then click in the Deck room to select it.
7. Click the **Open Object**  edit button to open the **Room Specification** dialog:
 - On the **STRUCTURE** panel, note that by default, **Roof Over This Room** and **Ceiling Over This Room** are unchecked for Deck rooms. You can select these options if you would like; however, for this tutorial they will remain unchecked.
8. Create a **Full Camera**  view showing the first floor deck and notice that the program automatically generated planking, posts, and beams.





Drawing Stairs

A set of stairs can now be drawn to connect the deck to the terrain. For more information, see “Stairs, Ramps, and Landings” on page 341 of the Reference Manual.

To draw deck stairs to the terrain

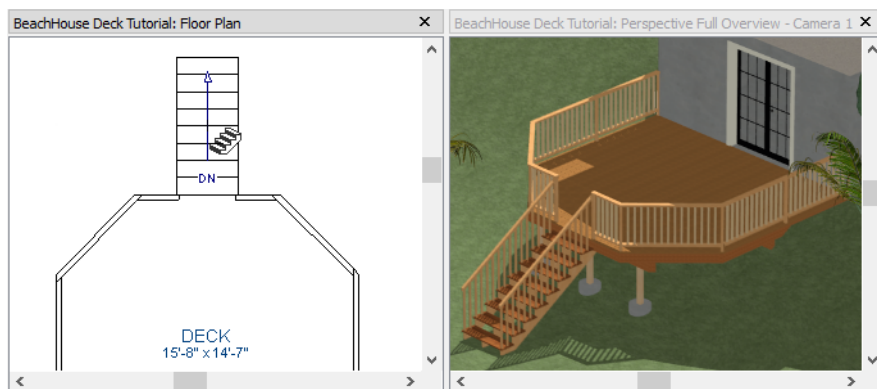
1. Select **Window> Tile Vertically**  to see a side by side of both the 2D and 3D views.
2. In the floor plan view, and on Floor 0, select **Build> Stairs> Click Stairs** .
3. Click just to the outside of the deck platform, as shown in the following image:





4. In most cases when using the **Click Stairs**  tool, an opening will be added automatically to the deck railing at the top of a staircase.

5. If an opening is not created, select **Build> Door> Doorway**  in either floor plan or a 3D view, then click on the deck railing to create an opening in front of the staircase.

Changing Planking Orientation

The angle of the deck planking can be controlled in the **Room Specification** dialog.

To create angled deck planking

1. Click the **Select Objects**  button, then click in the Deck room in floor plan view to select it.
2. Click the **Open Object**  edit button.
3. On the DECK panel of the **Room Specification** dialog:
 - Uncheck the **Automatic** checkbox next to **Plank Direction**, and then change the **Plank Direction** to 45° and click **OK**.
 - For more information about the settings on this panel, see “Deck Panel” on page 213 of the Reference Manual.

Adding Exterior Furniture

A selection of exterior furnishings is available in the Library Browser and can be accessed either by browsing or using the Search feature. For more information, see “The Library Browser” on page 400 of the Reference Manual.

To add furniture to the deck

1. Select **View> Library Browser**  to open the Library Browser.
2. Browse to Home Designer Core Catalogs> Exterior> Outdoor Living> Outdoor Furniture and select a chair for placement. In this example, a Wicker Dining Chair from the Furniture Sets folder is selected.

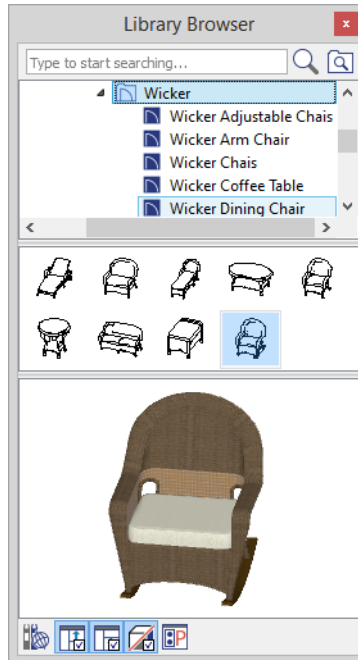

3. In floor plan view or a 3D view, click on the deck to place a chair symbol. You can continue clicking to place more chairs.
4. Use the Library Search to find an outdoor grill, select it for placement, and place it on the deck.
5. Next, add some exterior lighting and any other desired exterior elements to your deck design.
6. Finally, create a **Full Camera**  view to see the results.



Index

Numerics

3D Views	
Create	39

A

Adding	
Floors	41
Foundations	41
Library Objects	153
Appliances	108
Artwork	
Adding	125
Auto	
Calculate Elevation	142
Check for Program Updates	17
Dormers, Creating	73
Exterior Dimensions	28
Stairwell	48
Auto Rebuild	
Roofs	58, 85

B

Backdrop Dialog	133
Backdrops	
Importing	132
Selecting	133
Basements	41
Blend Colors with Materials	125
Break	
Wall	80

C

Cabinets	
Base	103
Corner	105
Creating	103
Editing	104
Soffits	108
Wall, placing	106
Camera	
Views, Creating	39
Carpet	
Adding	123
Chair Rails	
Adding	98
Corner	
Cabinet	105
Cross Section Slider	116
Crown Molding	
Adding to rooms	98

D

Deck	
Railing	158
Decks	
Drawing	158
Defaults	
Material	120
Dimensions	28
Auto Exterior	28
Doors	
Adding	50
Copying	53
Editing	51
Placing	50

Dormers	75
Automatic	73
Manually Drawn	73

E

Elevation	
Lines	142

F

Flatten Building Pad	142
Foundation	
Creating	41
Furniture	160

G

Gable	
Over Door/Window	71
Roofs	61
Gambrel Roofs	65
Gull Wing Roofs	66

H

Half Hip Roofs	67
Hip	
Roofs	61

I

Image	
Specification Dialog	131
Images	
Creating	130
Installation	7
Interior	
Dimensions	29

Invisible Walls	36
------------------------------	----

L

Library Objects	
Placing	94
Library Search	94

M

Mansard Roofs	68
Material	
Defaults	120
Eyedropper	126
Material Painter	123
Blending	125
Materials	
Applying	121
Artwork	125
Blending	126
Changing	121
Creating	128
Materials Defaults	119
Materials List	134
Materials Panel	121
Merging Walls	42
message URL http	
//www.opencascade.com/doc/occt-7.3.0/ overview/html/index.html	2
Molding	98
Mouse-Orbit Camera	41, 50

P

Plan	
Templates	23
Plant Chooser	153
Ponds	149
Program Updates	
Auto Check	17

R

Reference	
Display	42
Replace from Library	97
Retaining Wall, creating	143
Roof Type Quick Reference	70
Roofs	
Auto Dormer	73
Gable	61
Gambrel	65
Gull Wing.....	66
Half Hip	67
Hip	61
Mansard	68
Manual Dormers	73
Offset Gable	64
Returns	71
Shed	63
Rooms	
Creating	33
Room Labels	37
Room Types	37
Selecting	122
Rugs	
Area rugs, creating.....	124

S

Select	
Room	122
Shed	
Roofs	63
Skylights	
Creating	80
Soffits	108

Stair Designer	46
Stair Landing	
Creating.....	46
Stairs	
Drawing	159
Stairwell	48
Create manually	48
Starting the Program	22
Startup Options	22

T

Templates	23
------------------------	----

U

Updates	
Auto Check	17

W

Wall	
Cabinets, placing.....	106
Coverings	100
Walls	
Drawing	25
Merging	42
Retaining, creating	143
Water Features	149
Windows	
Copying	53
Editing	52
Placing	51

