

**Chief Architect®  
Home Designer® Architectural 2017**

**Reference Manual**

**Chief Architect, Inc.  
6500 N. Mineral Dr.  
Coeur d'Alene, Idaho 83815  
[www.HomeDesignerSoftware.com](http://www.HomeDesignerSoftware.com)**

© 1990–2016 by Chief Architect, Inc. All rights reserved.

No part of this documentation or the accompanying software may be reproduced or transmitted in any form or by any means, electronic or mechanical, including photocopying, recording, or by any information storage and retrieval system, without permission in writing from Chief Architect, Inc.

Chief Architect® and Home Designer® are registered trademarks of Chief Architect, Inc.

This software uses the FreeImage open source image library. See <http://freeimage.sourceforge.net> for details. FreeImage is used under the FIPL license, version 1.0.

This software uses the Ruby open source library. See <http://www.ruby-lang.org/> for details.

This application incorporates Teigha® software pursuant to a license agreement with Open Design Alliance. Teigha® Copyright © 2003-2013 by Open Design Alliance. All rights reserved.

3D input device development tools and related technology are provided under license from 3Dconnexion. © 3Dconnexion 1992 - 2013. All rights reserved.

All other trademarks and copyrights are the property of Chief Architect, Inc. or their respective owners.

Created in the United States of America.

# Contents

---

## Chapter 1: Program Overview

Startup Options .....	22
The Home Designer Architectural Environment .....	23
Using the Mouse.....	25
View and Side Windows.....	27
Toolbars and Hotkeys .....	28
Menus.....	29
Dialogs .....	30
The Status Bar .....	33
Message Boxes.....	33
Preferences and Default Settings .....	34
Drawing a Plan .....	35
Viewing Your Plan .....	36
Getting Help .....	37
About Home Designer .....	38
Product Upgrade Options.....	38
Home Designer Trial Software.....	38

---

## Chapter 2: File Management

Compatibility with Other Programs.....	42
Organizing Your Files.....	43
Home Designer Architectural Data .....	43
Creating a New Plan.....	44

<b>Saving, Exporting, and Backing Up Files.....</b>	<b>45</b>
<b>Thumbnail Images.....</b>	<b>48</b>
<b>Auto Archive .....</b>	<b>49</b>
<b>Undo Files.....</b>	<b>50</b>
<b>Opening and Importing Files .....</b>	<b>50</b>
<b>Referenced Files.....</b>	<b>52</b>
<b>Backup Entire Plan .....</b>	<b>54</b>
<b>Closing Views and Files .....</b>	<b>54</b>
<b>Exiting Home Designer Architectural .....</b>	<b>55</b>

---

## **Chapter 3: Preferences and Default Settings**

<b>Default Settings vs Preferences .....</b>	<b>58</b>
<b>Dynamic Defaults .....</b>	<b>59</b>
<b>Reset to Defaults .....</b>	<b>59</b>
<b>General Plan Defaults Dialog .....</b>	<b>60</b>
<b>Preferences Dialog.....</b>	<b>61</b>
<b>Angle Style Dialog .....</b>	<b>69</b>

---

## **Chapter 4: Toolbars and Hotkeys**

<b>Toolbar Arrangement .....</b>	<b>71</b>
<b>Hotkeys .....</b>	<b>73</b>

---

## **Chapter 5: Layers**

<b>Displaying Objects.....</b>	<b>76</b>
<b>Layer Sets.....</b>	<b>76</b>
<b>Display Options Dialog .....</b>	<b>77</b>

---

## **Chapter 6: Creating Objects**

<b>Architectural vs CAD Objects.....</b>	<b>80</b>
<b>Snap Behaviors .....</b>	<b>80</b>
<b>Object Snaps .....</b>	<b>80</b>
<b>Angle Snaps.....</b>	<b>81</b>
<b>Grid Snaps.....</b>	<b>81</b>
<b>Creating Objects.....</b>	<b>82</b>
<b>Copying and Pasting Objects .....</b>	<b>83</b>

---

## **Chapter 7: Editing Objects**

<b>Selecting Objects.....</b>	<b>88</b>
<b>Editing Line Based Objects .....</b>	<b>90</b>
<b>Editing Arc Based Objects.....</b>	<b>92</b>
<b>Editing Open Polyline Based Objects.....</b>	<b>95</b>
<b>Editing Closed-Polyline Based Objects .....</b>	<b>98</b>
<b>Editing Box-Based Objects .....</b>	<b>101</b>
<b>Editing Spline Based Objects .....</b>	<b>103</b>
<b>Editing Circles, Ovals and Ellipses .....</b>	<b>105</b>
<b>Displaying Objects.....</b>	<b>107</b>
<b>Moving Objects.....</b>	<b>109</b>
<b>Aligning Objects .....</b>	<b>110</b>
<b>Resizing Objects.....</b>	<b>112</b>
<b>Reshaping Objects .....</b>	<b>113</b>
<b>Rotating Objects .....</b>	<b>114</b>
<b>Matching Properties.....</b>	<b>115</b>
<b>Deleting Objects.....</b>	<b>116</b>
<b>Undo and Redo .....</b>	<b>118</b>

---

## Chapter 8: Walls, Railings, and Fencing

Wall Defaults.....	120
Wall Tools .....	122
Railing and Deck Tools .....	123
Fencing Tools .....	125
Exterior and Interior Walls.....	125
Foundation Walls .....	126
Pony Walls.....	126
Room Dividers and Invisible Walls .....	127
Polygon Shaped Decks .....	128
Hatch Wall .....	129
Break Wall .....	129
Drawing Walls .....	130
Connecting Walls.....	131
Displaying Walls .....	132
Measuring Walls.....	134
Editing Walls.....	135
Editing Straight/Curved Wall Combinations .....	138
Aligning Walls.....	138
Roof Directives in Walls.....	140
Attic Walls.....	141
Wall Type Definitions .....	142
Wall Type Definitions Dialog .....	144
Wall Specification Dialog.....	146
Railing and Fencing Specification Dialogs.....	154
Wall Hatch Specification Dialog .....	157

---

## Chapter 9: Rooms

Floor and Room Defaults.....	160
------------------------------	-----

Room Definition.....	160
Selecting Rooms.....	161
Displaying Rooms.....	162
Editing Rooms.....	163
Room Types.....	164
Room Labels.....	166
Decks.....	167
Floor and Ceiling Heights.....	168
Stepped Floor and Ceiling Platforms.....	169
Special Ceilings.....	170
Room Specification Dialog.....	172

---

## Chapter 10: Doors

Door Defaults.....	179
The Door Tools.....	180
Displaying Doors.....	182
Editing Doors.....	183
Changing Door Swings.....	185
Special Doors.....	187
Door Specification Dialog.....	189

---

## Chapter 11: Windows

Window Defaults.....	198
The Window Tools.....	198
Special Windows.....	200
Grouped Windows.....	201
Displaying Windows.....	202
Editing Windows.....	203
Window Specification Dialog.....	205
Bay, Box, and Bow Windows.....	213

<b>Bay, Box, Bow Windows and Roofs .....</b>	<b>215</b>
<b>Bay/Box and Bow Window Specification Dialogs .....</b>	<b>216</b>

---

## **Chapter 12: Multiple Floors**

<b>Floor Defaults Dialog .....</b>	<b>220</b>
<b>Floor Tools .....</b>	<b>220</b>
<b>Adding Floors .....</b>	<b>221</b>
<b>Displaying Floors.....</b>	<b>222</b>
<b>Exchanging Floors.....</b>	<b>222</b>
<b>Deleting Floors.....</b>	<b>223</b>
<b>Split Levels .....</b>	<b>223</b>
<b>The Current Floor .....</b>	<b>224</b>
<b>The Attic Floor.....</b>	<b>225</b>
<b>The Reference Floor .....</b>	<b>225</b>

---

## **Chapter 13: Foundations**

<b>Foundation Defaults .....</b>	<b>228</b>
<b>Building a Foundation.....</b>	<b>229</b>
<b>Displaying Foundations .....</b>	<b>230</b>
<b>Editing Foundations .....</b>	<b>230</b>
<b>Aligning Foundation Walls.....</b>	<b>232</b>
<b>Deleting Foundations .....</b>	<b>232</b>
<b>Foundations and Rooms .....</b>	<b>232</b>
<b>Foundations and the Terrain.....</b>	<b>234</b>
<b>The Slab Tools .....</b>	<b>235</b>
<b>Editing Slabs .....</b>	<b>235</b>
<b>Slab Specification Dialog .....</b>	<b>235</b>
<b>Fireplaces .....</b>	<b>237</b>
<b>Fireplace Specification Dialog.....</b>	<b>239</b>
<b>Library Fireplaces.....</b>	<b>240</b>



Chimneys .....	241
----------------	-----

---

## Chapter 14: Roofs

Roof Defaults .....	244
The Roof Tools .....	244
Automatic Roofs .....	245
Build Roof Dialog .....	245
Displaying Roofs .....	247
Editing Roofs .....	248
Gable/Roof Lines .....	248
Skylights .....	251
Skylight Specification Dialog .....	252
Dormers .....	254
Editing Auto Dormers .....	255
Dormer Specification Dialog .....	256
Roof Returns and Other Details .....	257
Roof Pitches in Degrees .....	258

---

## Chapter 15: Stairs, Ramps, and Landings

Stair Defaults .....	259
The Stair Tools .....	260
Anatomy of a Staircase .....	260
Drawing Stairs and Ramps .....	262
Displaying Stairs, Ramps, and Landings .....	263
Editing Stairs and Ramps .....	264
Merging Stair and Ramp Sections .....	265
Landings .....	266
Maintaining Tread Depth .....	269
Flared Stairs and Curved Treads .....	269
Starter Treads .....	272

<b>Wrapped Stairs</b> .....	<b>273</b>
<b>Other Special Railings and Stairs</b> .....	<b>274</b>
<b>Creating a Stairwell</b> .....	<b>275</b>
<b>Rooms Below Staircases</b> .....	<b>276</b>
<b>Staircase Specification Dialog</b> .....	<b>277</b>
<b>Ramp Specification Dialog</b> .....	<b>283</b>
<b>Stair Landing Specification Dialog</b> .....	<b>285</b>

---

## **Chapter 16: Electrical**

<b>The Electrical Tools</b> .....	<b>290</b>
<b>Auto Place Outlets</b> .....	<b>291</b>
<b>Creating Wiring Schematics</b> .....	<b>292</b>
<b>Electrical Library Content</b> .....	<b>293</b>
<b>Displaying Electrical Objects</b> .....	<b>293</b>
<b>Editing Electrical Objects</b> .....	<b>294</b>
<b>Electrical Service Specification Dialog</b> .....	<b>295</b>

---

## **Chapter 17: Trim Tools**

<b>Trim and Molding Defaults</b> .....	<b>302</b>
<b>Corner Boards</b> .....	<b>302</b>
<b>Corner Board Specification Dialog</b> .....	<b>303</b>
<b>Quoins</b> .....	<b>303</b>
<b>Quoin Specification Dialog</b> .....	<b>304</b>
<b>Editing Corner Boards and Quoins</b> .....	<b>305</b>
<b>Millwork</b> .....	<b>305</b>
<b>Moldings Panel</b> .....	<b>306</b>

---

## **Chapter 18: Cabinets**

<b>Cabinet Defaults</b> .....	<b>310</b>
-------------------------------	------------

<b>The Cabinet Tools.....</b>	<b>310</b>
<b>Cabinet Fillers.....</b>	<b>313</b>
<b>Placing Cabinets .....</b>	<b>313</b>
<b>Custom Countertops .....</b>	<b>314</b>
<b>Custom Backsplashes .....</b>	<b>315</b>
<b>Displaying Cabinets.....</b>	<b>316</b>
<b>Editing Cabinets .....</b>	<b>317</b>
<b>Editing Cabinet Styles.....</b>	<b>318</b>
<b>Special Cabinets.....</b>	<b>319</b>
<b>Cabinet Specification Dialog .....</b>	<b>321</b>
<b>Shelf/Partition Specification Dialog.....</b>	<b>328</b>
<b>Custom Countertop Specification Dialog.....</b>	<b>329</b>
<b>Custom Backsplash Specification Dialog .....</b>	<b>330</b>
<b>Backsplash Layer Definition Dialog .....</b>	<b>331</b>

---

## **Chapter 19: Terrain**

<b>Terrain Perimeter.....</b>	<b>333</b>
<b>Elevation Data Tools .....</b>	<b>335</b>
<b>Terrain Modifier Tools .....</b>	<b>338</b>
<b>Terrain Feature Tools .....</b>	<b>339</b>
<b>Garden Bed Tools.....</b>	<b>340</b>
<b>Water Feature Tools.....</b>	<b>341</b>
<b>Stepping Stone Tools .....</b>	<b>342</b>
<b>Terrain Wall and Curb Tools.....</b>	<b>342</b>
<b>Terrain Objects in the Library .....</b>	<b>343</b>
<b>Displaying Terrain.....</b>	<b>343</b>
<b>Editing Terrain Objects.....</b>	<b>344</b>
<b>Terrain Specification Dialog.....</b>	<b>345</b>
<b>Elevation Point Specification Dialog.....</b>	<b>347</b>
<b>Elevation Line/Region Specification Dialog.....</b>	<b>348</b>

<b>Hill / Valley Specification Dialog .....</b>	<b>349</b>
<b>Raised / Lowered Region Specification Dialog .....</b>	<b>349</b>
<b>Terrain Feature Specification Dialog .....</b>	<b>350</b>
<b>Garden Bed Specification Dialog .....</b>	<b>353</b>
<b>Terrain Path Specification Dialog.....</b>	<b>353</b>
<b>Importing Elevation Data .....</b>	<b>355</b>
<b>Import Terrain Assistant .....</b>	<b>355</b>
<b>Import GPS Data Assistant .....</b>	<b>357</b>

---

## **Chapter 20: Roads, Driveways and Sidewalks**

<b>Road, Driveway and Sidewalk Tools .....</b>	<b>361</b>
<b>Displaying Road Objects.....</b>	<b>363</b>
<b>Editing Road Objects .....</b>	<b>363</b>
<b>Road Specification Dialog.....</b>	<b>363</b>

---

## **Chapter 21: Plants and Sprinklers**

<b>Plant Tools.....</b>	<b>366</b>
<b>Plant Chooser Dialog.....</b>	<b>367</b>
<b>Hardiness Zones .....</b>	<b>369</b>
<b>Plant Image Specification Dialog .....</b>	<b>369</b>
<b>Sprinkler Tools .....</b>	<b>373</b>
<b>Sprinkler Specification Dialog .....</b>	<b>373</b>
<b>Plant Schedules .....</b>	<b>374</b>
<b>Schedule Columns and Numbering .....</b>	<b>374</b>
<b>Plant Schedule Specification Dialog .....</b>	<b>375</b>

---

## **Chapter 22: Other Objects**

<b>General Shapes .....</b>	<b>379</b>
<b>Soffits .....</b>	<b>379</b>

Special Applications for Soffits .....	380
Soffit Specification Dialog.....	382

---

## **Chapter 23: Architectural Blocks**

Creating Architectural Blocks.....	387
Displaying Architectural Blocks .....	389
Editing Architectural Blocks .....	389
Architectural Block Specification Dialog .....	390
Architectural Blocks and Sub-Objects .....	391

---

## **Chapter 24: The Library**

The Library Browser .....	394
Searching the Library .....	397
Library Content.....	398
Downloading Library Content .....	400
Importing Library Catalogs .....	401
Adding Library Content .....	402
Organizing the Library .....	403
Exporting Library Catalogs .....	406
Placing Library Objects.....	406
Select Library Object Dialog.....	408
Replace From Library .....	408
Displaying Library Objects .....	409
Editing Library Objects.....	410
Symbol Object Specification Dialogs .....	411

---

## **Chapter 25: Materials**

About Materials .....	416
Material Defaults .....	416

<b>The Material Painter .....</b>	<b>417</b>
<b>Materials Panel .....</b>	<b>420</b>
<b>Select Material Dialog .....</b>	<b>422</b>
<b>Viewing Materials.....</b>	<b>423</b>
<b>Editing Materials.....</b>	<b>423</b>
<b>Creating Materials .....</b>	<b>424</b>
<b>Mapping Patterns and Textures .....</b>	<b>425</b>
<b>Material Types.....</b>	<b>427</b>
<b>Define Material Dialog.....</b>	<b>429</b>
<b>Select Color Dialog .....</b>	<b>438</b>

---

## **Chapter 26: Window and View Tools**

<b>View Tools .....</b>	<b>442</b>
<b>Zoom Tools.....</b>	<b>442</b>
<b>Undo Zoom.....</b>	<b>443</b>
<b>Fill Window.....</b>	<b>443</b>
<b>Panning the Display.....</b>	<b>443</b>
<b>Working in Multiple Views .....</b>	<b>444</b>
<b>Closing Views.....</b>	<b>446</b>

---

## **Chapter 27: 3D Views**

<b>OpenGL and Hardware .....</b>	<b>448</b>
<b>Types of 3D Views .....</b>	<b>448</b>
<b>Backdrop Dialog.....</b>	<b>448</b>
<b>3D View Tools .....</b>	<b>450</b>
<b>Creating Camera Views.....</b>	<b>450</b>
<b>Creating Overviews.....</b>	<b>451</b>
<b>Elevation Views.....</b>	<b>452</b>
<b>Displaying 3D Views.....</b>	<b>453</b>
<b>Repositioning Cameras .....</b>	<b>455</b>

Editing 3D Views .....	461
Cross Section Slider.....	463
Working in 3D.....	464
Saving and Printing 3D Views.....	466
Camera Specification Dialog .....	467

---

## **Chapter 28: 3D Rendering**

Rendering Tips.....	470
Lighting .....	472
Displaying Lights .....	473
Light Types.....	475
Light Specification Dialog.....	476
Adjust Sunlight Dialog .....	477
Rendering Techniques.....	478
Rendering Technique Options.....	479
Speeding up 3D View Generation .....	482

---

## **Chapter 29: Dimensions**

Dimension Unit Defaults .....	485
Dimension Defaults Dialog.....	485
The Dimension Tools.....	488
Displaying Dimension Lines .....	490
Editing Dimension Lines.....	491
Editing Extension Lines .....	493
Moving Objects Using Dimensions .....	494
Dimension Line Specification Dialog .....	496

---

## **Chapter 30: Text**

Text Defaults .....	497
---------------------	-----

<b>Fonts and Alphabets</b> .....	<b>498</b>
<b>The Text Tools</b> .....	<b>499</b>
<b>Creating Text</b> .....	<b>499</b>
<b>Displaying Text</b> .....	<b>500</b>
<b>Rich Text Specification Dialog</b> .....	<b>500</b>
<b>Text Specification Dialog</b> .....	<b>503</b>
<b>Editing Text</b> .....	<b>504</b>
<b>Copying and Pasting Text</b> .....	<b>505</b>
<b>Text Arrows</b> .....	<b>506</b>
<b>Text Styles</b> .....	<b>507</b>

---

## **Chapter 31: CAD Objects**

<b>The CAD Drawing Tools</b> .....	<b>511</b>
<b>Line Specification Dialog</b> .....	<b>513</b>
<b>Arc Specification Dialog</b> .....	<b>515</b>
<b>CAD Circle/Oval/Ellipse Specification Dialog</b> .....	<b>517</b>
<b>Polylines</b> .....	<b>518</b>
<b>Polyline Specification Dialog</b> .....	<b>518</b>
<b>Box Specification Dialog</b> .....	<b>520</b>
<b>Splines</b> .....	<b>520</b>
<b>Displaying CAD Objects</b> .....	<b>522</b>

---

## **Chapter 32: Project Planning**

<b>Space Planning</b> .....	<b>523</b>
<b>Room Box Specification Dialog</b> .....	<b>525</b>
<b>Plan Check</b> .....	<b>526</b>
<b>Loan Calculator</b> .....	<b>528</b>



---

## Chapter 33: Pictures, Images, and Walkthroughs

Picture Files vs Pictures and Image Objects.....	530
Images.....	530
Displaying Images.....	531
Editing Images .....	532
Image Specification Dialog .....	532
Pictures .....	536
Picture File Box Specification Dialog .....	537
Metafiles .....	537
Metafile Box Specification Dialog .....	538
PDF Files .....	538
PDF Box Specification Dialog.....	540
Displaying Pictures, Metafiles, and PDF Boxes.....	540
Editing Pictures, Metafiles, and PDF Boxes .....	540
Copy Region as Picture .....	541
3D Backdrops.....	542
Walkthroughs .....	543
Walkthrough Path Specification Dialog.....	547

---

## Chapter 34: Importing and Exporting

Import Room Planner File.....	552
DXF File Format.....	552
Exporting 2D DXF Files.....	552
Additional 2D Export Information .....	553
3D Data Import Requirements.....	554
Importing 3D Symbols .....	556
Symbol Specification Dialog .....	556
3D Symbols and Materials.....	558
Exporting a 3D Model.....	559

---

## Chapter 35: Printing

Introduction to Printing.....	562
The Printing Tools.....	563
Drawing Sheet Setup Dialog.....	563
Print Preview .....	565
Printing to Scale.....	565
Printing Across Multiple Pages.....	566
Printing to a PDF File .....	567
Print View Dialog .....	567
Print Image Dialog .....	570
Print Model .....	571

---

## Chapter 36: Object Labels

Object Labels .....	575
Label Panel.....	576

---

## Chapter 37: Materials Lists

The Materials List Tools.....	580
Creating an Accurate Materials List.....	581
Structural Member Reporting .....	581
Organizing Materials Lists .....	582
Materials List Display Options Dialog .....	583
Editing Materials Lists.....	584
Printing and Exporting the Materials List.....	585
Conditioned Area Totals.....	585

---

## Appendix A: Additional Resources

Reference Manual.....	587
-----------------------	-----

<b>User's Guide.....</b>	<b>587</b>
<b>Online Help Videos.....</b>	<b>588</b>
<b>Home Designer Web Site .....</b>	<b>588</b>
<b>Online Home Designer Samples Gallery .....</b>	<b>588</b>
<b>HomeTalk Online User Forum.....</b>	<b>588</b>
<b>Technical Support .....</b>	<b>589</b>

---

## **Appendix B: Technical Support Services**

<b>Reference and Training Resources .....</b>	<b>591</b>
<b>Troubleshooting Common Technical Issues .....</b>	<b>592</b>
<b>Troubleshooting Printing Problems .....</b>	<b>592</b>
<b>Error Messages .....</b>	<b>594</b>
<b>Contacting Technical Support.....</b>	<b>595</b>
<b>Program Paths Dialog .....</b>	<b>596</b>



# Program Overview

Home Designer Architectural allows design professionals and home enthusiasts to design effectively and quickly produce 3D models and working drawings.

Home Designer Architectural is designed to help home enthusiasts visualize, develop and share their design ideas. Home Designer Architectural uses parametric design technology, which means that as you draw, a 3D model is created and is updated as you make changes. You can tile a floor plan view next to a 3D view and watch one update automatically as you draw in the other.

## Chapter Contents

- Startup Options
- The Home Designer Architectural Environment
- Using the Mouse
- View and Side Windows
- Toolbars and Hotkeys
- Menus
- Dialogs
- The Status Bar
- Message Boxes
- Preferences and Default Settings
- Drawing a Plan
- Viewing Your Plan
- Getting Help
- About Home Designer
- Home Designer Trial Software

## Startup Options



When Home Designer Architectural opens, the **Startup Options** dialog displays, allowing you to choose how you want to begin working in the program or access useful resources.

The **Startup Options** dialog can be opened at any time by selecting **File> Startup**

**Options**



- 1 Select a **File** command to open a .plan file.
- 2 Click **New Plan** to open a new, blank plan. See “Creating a New Plan” on page 44.

- Choose **Open Plan** to work on an existing plan file. See “Opening and Importing Files” on page 50.
- 2 **Recent Files** lists the full pathnames of the most recently opened files. Click on a name to open the file.



Move your mouse pointer over a name to see the file's full pathname.

- 3 A selection of useful online **Resources** is available here. Select one to launch your default internet browser to a page on our web site, [www.HomeDesignerSoftware.com](http://www.HomeDesignerSoftware.com).
  - Select **Overview Video** to watch a browsable collection of videos outlining the software's features and uses.
  - Select **Training Videos** to access a searchable collection of videos focused on specific topics.
  - Select **Download Catalogs** to visit our 3D Library of downloadable bonus and manufacturer library catalogs. See "Library Content" on page 398.

- 4 Click **Getting Started** to launch your default internet browser to the Getting Started page on our web site. There, you will find links to a variety of online resources to help you begin using the program.
- 5 Click **My Account** to launch your default internet browser to the Log In page on our web site.
- 6 Your software version's **Build** number and the first five characters of your **Product Key** display here for reference.

To prevent the **Startup Options** dialog from displaying when you launch Home Designer Architectural, uncheck **Show Options on Startup** in the **Preferences** dialog. See "General Panel" on page 64.

---

## The Home Designer Architectural Environment

### Object-Based Design

Home Designer Architectural's parametric, object-based design technology means you place and edit objects, rather than work with the many individual lines or surfaces used to represent them.

You can quickly select and edit the location, size, shape, style and other properties of objects as well as change the materials applied to their surfaces.

Use Home Designer Architectural's editing capabilities to make the objects you place in a plan match the objects they represent in real life. For example, you can set up your windows and doors to match those available from your supplier.

### 3D Drafting

In Home Designer Architectural, the entire drawing area is laid out on a Cartesian grid, a three dimensional coordinate system described using the X, Y, and Z axes. The current position of your mouse pointer displays in the Status Bar at the bottom of the program window.

Architectural objects take up space in all three dimensions and their height, width and depth can be specified in Imperial or metric units. In addition, the location of objects can be precisely defined using coordinates, again specified in Imperial or metric units.

CAD objects such as lines and arcs take up space in two dimensions in the current view.

Their dimensions can also be specified in Imperial or metric units and their locations precisely defined using coordinates.

### Easy Access to Tools

You can access Home Designer Architectural’s features in various ways using the mouse and keyboard.

- Menus provide access to most tools.

- Convenient toolbar buttons allow fast access to tools and let you customize the interface.
- Keyboard shortcuts are available for most tools.
- Contextual menus display with a right-click of the mouse.
- The Status Bar at the bottom of the screen provides tool descriptions and other information about the current task.

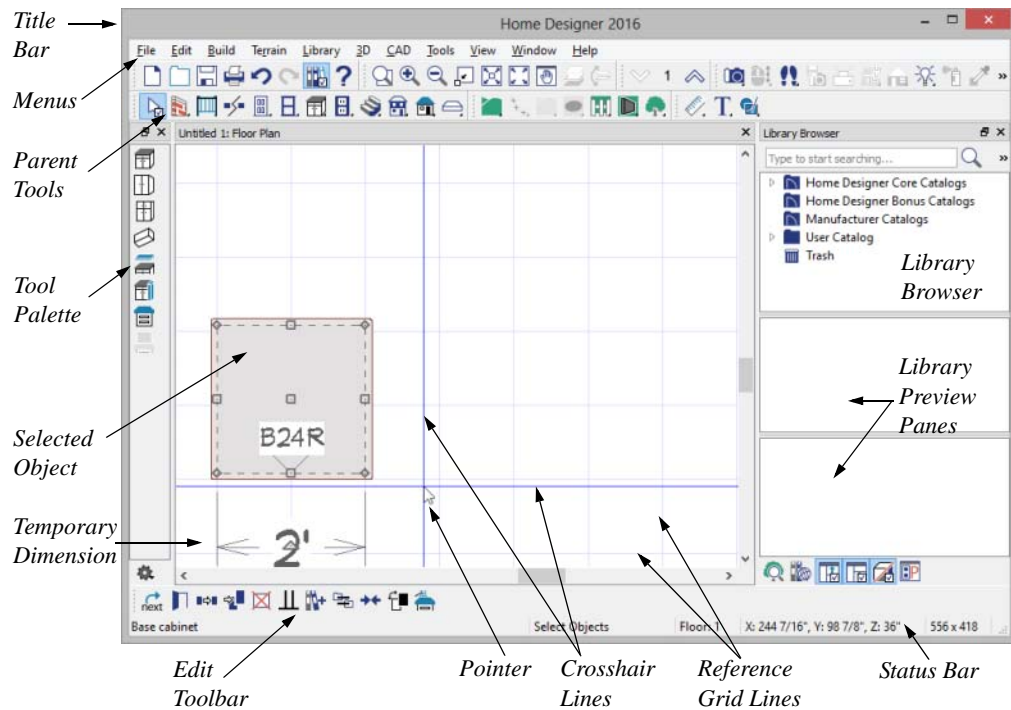

### Interface Toggles

A number of useful drawing and editing behaviors, as well as the display of important elements in the interface, can be easily enabled and disabled using the menus. For example:

- Object Snaps, Angle Snaps, and Grid Snaps can be toggled on or off as needed. I See “Snap Behaviors” on page 80.
- Display Elements like Print Preview, Show Line Weights, and the Reference



Display can be turned on when needed and then toggled off.

When a setting is turned on, its icon in the menu will display a small checkmark at its lower right corner and have a border around it in.

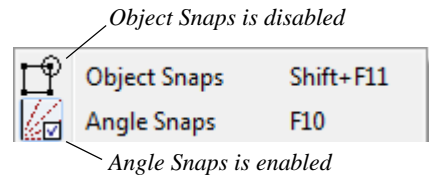

Many of these interface elements are global Preferences while others are file-specific default settings. See “Default Settings vs Preferences” on page 58.

## Using the Mouse

Many objects, such as doors and cabinets, are created by clicking the left mouse button. Others, such as walls, stairs and dimension lines, are created by dragging the pointer from one end of the object to the other.



The **left button** is the primary button used in Home Designer Architectural. Unless specified otherwise, Home Designer

Architectural documentation refers to the left mouse button.

Note: If you are left-handed and have re-programmed your mouse, reverse the instructions for left and right buttons in this manual.



The **Right button** has several uses.

Right-click to select any object. If, for example, the **Straight Exterior Wall**  tool is active, the left mouse button allows you to select only walls. You can select other object types such as cabinets with the right mouse button.

You can also use the right mouse button to open a context sensitive menu with additional editing commands. See “Contextual Menus” on page 29.



The **Middle button** can be used to pan in most view types. To close a tabbed view window, click on its tab using the middle mouse button. You can also program it to work as a double-click.

If your mouse does not have a middle mouse button, in the Mac version of Home Designer Architectural you can use the left button and the Command key to achieve the same results.



The **Mouse Wheel** can be used to zoom in and out in most view types. See “Zoom Tools” on page 442.

### 3D Mice

3Dconnexion®'s 3D mice can be used to navigate in Home Designer Architectural. For information about navigating in camera

views and overviews, see “3Dconnexion® 3D Mice” on page 457.

## Using a Trackpad

In addition to the standard trackpad gestures on your system, in Home Designer Architectural you can pinch to zoom.

In OS X 10.10 (Yosemite), use the click-hold gesture to pan; in 10.9 (Mavericks) and prior, click-hold and two finger panning are supported. Panning is not supported in the Windows version of the software, however.

## Edit Handles

When you select an object, its edit handles display.

When you pass the mouse over an edit handle, information about what the handle does displays in the Status Bar and the pointer changes to show how you can use that handle.

- A two-headed arrow indicates that the object, corner or edge can be moved in the direction of the arrows.
- A four-headed arrow indicates that the selected object or edge may be moved in multiple directions.
- A circular arrow indicates that the selected object can be rotated.

Resize handles display along the edges of the object are used to change the size. See “Resizing Objects” on page 112.



The Move handle at the object’s center lets you move the object. Depending on the type

of object(s) selected and how far you are zoomed in or out, the position of the Move handle may shift so that it remains on-screen. See “Moving Objects” on page 109.

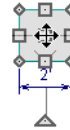

The triangular Rotate handle lets you rotate the object. See “Rotating Objects” on page 114.





You can cancel any edit handle operation before it is completed by pressing the Esc key on your keyboard or by pressing any two mouse buttons at the same time.



The edit handles that display depend on the type of object selected, the current view, and how far you are zoomed out.

Edit handles do not resize as you zoom in or out. If you are zoomed out far enough, some edit handles may be hidden so that they do not stack over one another. As you zoom in, these handles become visible again.

## Mouse Pointer Icons

The appearance of the mouse pointer in Home Designer Architectural will vary, depending on which tool is active. For example, when the **Select Objects**  tool is active, it will look like a white arrow, and when a **Cabinet Tool**  is active, it will look like a base cabinet with a small cross.

In addition, one or more additional icons may follow the mouse pointer if Angle Snaps is not in use or if a problematic condition exists in the file:

Icon	Setting
	Angle Snaps
	Fix Wall Connections

---

## View and Side Windows

Home Designer Architectural's main program window has a number of important features that let you interact with the program, such as toolbars and menus. It also features two different kinds of windows: view windows and side windows.

### View Windows

View windows are sometimes referred to as “the drawing area” because most of them are windows in which you can draw or place architectural and/or CAD objects. There are a number of different types of view windows in Home Designer Architectural:

- Floor plan view
- Camera views and overviews
- Elevation views
- Materials Lists

View windows can be navigated by panning and zooming; and, they have scroll bars on the right side and on the bottom. You can turn off the display of the scroll bars by selecting **View > Scrollbars**. See “View Tools” on page 442.

Although only one view window can be active at any given time, there is no limit to the number of view windows that can be open. View windows can be tiled or tabbed, and you can navigate between them in a

number of different ways. See “Window and View Tools” on page 441.

You can also tear a view window out of the main program window. This creates a second, separate program window complete with toolbars and menus. Individual view windows can be torn out and transferred between program windows.

### Side Windows

Side windows provide access to a variety of tools and content that helps you add detail your drawings.

Side windows are so-named because they are typically docked to either the left or right side of the program window - although, they can also be docked to the top or bottom, or undocked entirely. There are several different types of side window:

- Child Tool Palette
- The Library Browser

Each of these side windows can be opened via the **View** menu or by clicking the toolbar button associated with it. Similarly, each can be closed by clicking the **Close** button in its title bar or tab, via the **View** menu, or by clicking its toolbar button. See “View Tools” on page 442.

To undock a side window, either drag its title bar out into the drawing area or click the

Undock button on its title bar. To dock a side window, drag its title bar to any side of the program window. You can also double-click on its title bar to return it to its last docked location.

Two or more side windows can be docked together to form a shared side window, and can be tiled and/or tabbed within that shared window. To create a shared side window, begin by docking a side window to a side of the main program window, then:

- To create tabbed side windows, drag a second side window over the first. When the docked window becomes highlighted, release the mouse button.

- To create tiled side windows, drag a second side window over the first. When the docked window becomes highlighted, slowly drag the mouse towards one of its sides. When a highlighted space is created along that side, release the mouse button.

You can choose to disable **Side Window Drag Docking** in the **Preferences** dialog, and you can also enable **Top/Bottom Docking**. See “Appearance Panel” on page 62.

Side windows can also be set to their initial states in the **Preferences** dialog. See “Reset Options Panel” on page 69.

---

## Toolbars and Hotkeys

Using the toolbar buttons is the fastest, easiest way to access many program features. If a tool is active, a small checkmark will display at the lower left of its button icon. When you pass the pointer over a toolbar button, a “tool tip” displays the name of the tool and a more detailed description displays in the Status Bar at the bottom of the program window. When you see one of these tool tips, press the F1 key to get more information about that item. See “Getting Help” on page 37.

Home Designer Architectural’s tools are organized into families of related tools which can be accessed using either of two styles of toolbar interface: the Child Tool Palette or Drop Down tools. You can select the interface that you prefer in the **Preferences** dialog. See “Appearance Panel” on page 62.

### The Edit Toolbar

When you select an object, the edit toolbar appears. By default, it is located at the bottom of the program window, just above the Status Bar. The buttons on the edit toolbar can be used to edit the selected object(s). Which buttons display depends on the type of object selected, the current view, and how you selected the object.



The edit toolbar buttons are the same as the options in the contextual menu when you right-click on an object. See “Contextual Menus” on page 29.

### Hotkeys

Many commands can be invoked from the keyboard. Press Alt on your keyboard and press the underlined letter in a menu name to

access that menu, as well as items in the menus and submenus.

Other keys or key combinations will invoke a variety of program commands. If a Home

Designer Architectural menu item has a keyboard shortcut, or hotkey, associated with it, that hotkey will display to the right of its name in the menu.

## Menus

Home Designer Architectural uses a standard Windows menu format. The menus are located below the title bar in the program window and can be used to access nearly all tools in the program. Click on a menu name to expand it, then click on a menu item to either activate that tool or access the item's submenu. Items with a submenu have an arrow to the right of the name.

Menu items with an icon to their left have a toolbar button associated with them.

The menus can be accessed using the keyboard. Press the Alt key once to enable this functionality - one letter in each menu will become underlined. Press the key associated with one of these underlined letters to expand its menu - one letter in each menu item's name will be underlined. Press the key associated with one of these letters to activate that tool or access the item's submenu. Press the Esc key to undo your last selection, or click with the mouse to exit out of this functionality.

Many tools in Home Designer Architectural also have hotkeys associated with them. If a

menu item has a hotkey, it will display to the right of the item's name. See "Hotkeys" on page 73.



*Edit menu items with button icons to the left and hotkeys to the right*

In the Home Designer Architectural documentation, menu paths are written in this format: **Build> Window> Box**

**Window** .

### Contextual Menus

Contextual menus are context-sensitive menus that display tools relevant to a selected object or view. To open a contextual menu, right-click on an object, in an empty space in a view window, or in a text field in a dialog box.

The options in an object's contextual menu are usually the same as those on an object's Edit toolbar. See "The Edit Toolbar" on page 28.

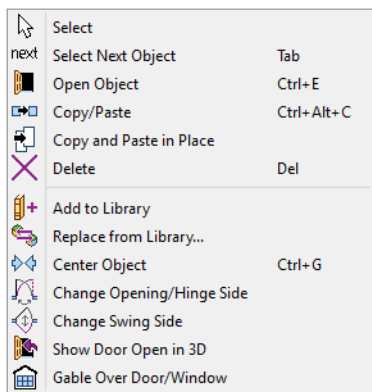

Contextual menus can be enabled or disabled in the **Preferences** dialog. When contextual

menus are disabled, right-clicks perform generic object selection, much like when the

**Select Objects**  tool is active. See “Appearance Panel” on page 62.

## Dialogs

Default and preference settings, object specifications, display settings, and many other functions are accessed through dialog boxes.

Many dialogs have multiple panels, which are listed in a tree list on the left side of the dialog. Click on a panel name in the list to make it active. In Windows, panels can also be navigated using the keyboard. Press:

- Ctrl + Tab or Ctrl + F6 to navigate forward;
- Ctrl + Shift + Tab or Ctrl + Shift + F6 to navigate backward.



When a panel name is active, you can also navigate the tree list using the Up and Down arrow keys.

By default, dialogs always open to the first panel in the list; if you prefer, you can choose to **Open Dialogs to the Last Panel Visited**. See “General Panel” on page 64,

Dialog panels and settings can be accessed using the mouse. You can also navigate the settings on a given dialog panel using the keyboard. For example:

- Line items in tree lists can be browsed using the arrow keys. Up and Down navigate the list, while Left and Right expand and contract categories.
- Press the Tab key to shift focus from the tree list to the first setting on the selected panel.
- Press the Tab key to shift focus from one setting to the next, or Shift + Tab to go in the reverse direction.
- A checkbox can be checked or cleared by pressing the Spacebar or the + or - keys, respectively, while it is in focus.
- Columns of radio buttons can be navigated using the Up and Down arrow keys; rows can be navigated using the

Left and Right arrows. Select a radio button by pressing the Spacebar while it is in focus.

- Settings in list boxes can be navigated using the Up and Down arrow keys. When a checkbox is in focus, it can be checked or cleared by pressing the Spacebar.
- Drop-down lists can be browsed using the Up and Down arrow keys. When the mouse pointer is directly over the drop-down, the mouse scroll wheel can also be used; on a Mac, the list must also be expanded. In Windows only, you can press Tab to select the highlighted item in the list and proceed to the next setting.
- Settings with spin control arrows  can be adjusted by typing in the text field or using the Up and Down arrow keys. When the mouse pointer is directly over the setting, the mouse scroll wheel can also be used.
- Slider bars  can be adjusted by typing in the text field or using the Left and Right arrow keys. When the mouse pointer is directly over the slider bar, the mouse scroll wheel can also be used.
- Line items in tables can be group selected using the Ctrl or Shift keys, or by pressing Ctrl+A.
- Press Enter on your keyboard to close most dialogs and apply your changes.

Note: Keyboard navigation in dialogs may vary somewhat depending on your computer platform.

In the Mac version of the software, Dictation is supported in dialogs. Select **Edit> Start**

**Dictation**, then open a dialog. Say the word “Numeral” before a number to enter it as a numeric value or immediately follow a number with a unit such as “foot” to enter it as a measurement.

The units of measurement used in dialogs are determined by your choice of template files. See “Creating a New Plan” on page 44.

The number format used in dialogs are set based on your operating system’s defaults.

## Math Operations in Dialogs

Basic addition, subtraction, multiplication, and division can be performed in the text boxes where numeric values are entered.

Note that settings for angle, pitch, or bearing do not support math, nor do those with spin controls or slider bars.

- To add, type the + character followed by the amount that you wish to add. Spaces are ignored and including a unit of measurement is optional.
- To subtract, type the - character followed by the amount you wish to subtract. As with adding, spaces are ignored and a unit of measurement is optional.
- To multiply, type the \* character followed by the amount you wish to multiply by. Spaces are ignored, and only one of the values being multiplied can have a unit of measurement.
- To divide, type the / character followed by the amount you wish to divide by. To divide, there must be a space before the / - if there is not, the input may be treated as a fraction. The denominator, or value typed after the /, cannot have a unit of measurement.

Math expressions support a single operation only: more than one operation character (+, -, \*, /) at a time is not allowed.

Basic math operations can also be used to move objects using dimensions. See “Moving Objects Using Dimensions” on page 494.

## Dialog Size and Position

Dialog boxes can be both moved and resized to suit your needs. By default, the program will remember both the position and size that you specify for a dialog and use it the next time you open it. You can specify whether the program does this always, per session, or never in the **Preferences** dialog. You can also reset the default sizes and positions. See “Reset Options Panel” on page 69.

- To move a dialog, position your mouse pointer within its title bar and then simply click and drag.
- To resize a dialog, position your mouse pointer on any edge or corner and then click and drag outward or inward. If you drag an edge, only that edge will move; if you drag a corner, the two adjacent edges will move.

When a dialog is resized, some elements within it may resize in response: for example, some list boxes and text fields. Some elements within a dialog box can also be resized independently. See “Dialog Panel Splitters” on page 33.

Note that all dialogs have a minimum size limitation but no maximum size. If a dialog opens on a monitor with resolution too low to display its full extents, it will have vertical and/or horizontal scroll bars.

Note: Some of the dialog box images in the software documentation have been resized smaller than their actual minimum size.

## Specification Dialogs



Each object in Home Designer Architectural has a unique specification dialog where you can enter size, style and other information specific to the selected object. To access it, select the object and click the **Open Object** edit button. You can also double-click on an object with the **Select Objects**  tool active to open its specification dialog. See “Selecting Objects” on page 88.

Most objects also have a defaults dialog that lets you specify the initial values in the specification dialog.

## Dialog Preview Panes

Many specification dialogs have a preview pane that shows how changes affect the selected object. This preview updates when you click in a different field or press the **Tab** key on your keyboard.

When you click in the preview pane, your mouse pointer changes to a four-headed arrow and you can rotate around the object as well as zoom in and out using the mouse scroll wheel. Some objects, notably walls, doors, and windows, have Interior and Exterior labels to indicate which side is visible in the preview. Click the **Fill**

**Window**  button above the preview pane to zoom in or out so that the object fills the extents of the pane, maintaining the current rotation.



A selection of Rendering Techniques can be applied to the preview in most dialogs: Standard, Vector View, and Glass House. See “Rendering Techniques” on page 478. Click

the **Color**  button to turn color in the preview off or on. Some objects have additional tools that affect object previews. For example, the **Cabinet Specification**

dialogs have a **Select Cabinet Face Item**  button. Object specific tools like this are discussed in the documentation for that object type.

## Dialog Panel Splitters

Many dialog panels are divided into up to three sections: a list of panels on the left, an object preview on the right, and a central area where settings are located. The vertical splitters separating these sections each have a pale, dotted handle.

To resize the panel list or preview, as well as the area in the middle, move your mouse pointer over the vertical division line: when the splitter cursor  can be seen, click and drag to the left or right.

---

## The Status Bar

The Status Bar at the bottom of the main program window displays information about the current state of the program.

This information depends on a variety of conditions such as the type of object selected, and the current position of the pointer. The information may include the following:

- The type of object currently selected or the total number of group-selected objects.
- A description of the edit handle that the pointer is over.
- A brief description of the toolbar button or menu item highlighted by the mouse.
- The name of the active tool and its hot-key, if it has one.
- The length and/or angle of an object as it is being drawn.
- The layer that the selected object is on.
- Basic information about a selected library object, folder, or catalog.
- The current floor.
- The size of the active window in pixels.

---

## Message Boxes

As you work in Home Designer Architectural, the program will occasionally prompt you to examine your settings, alert you if you command it to do something that

could potentially cause a problem, or notify you if it encounters a problem that needs your attention.

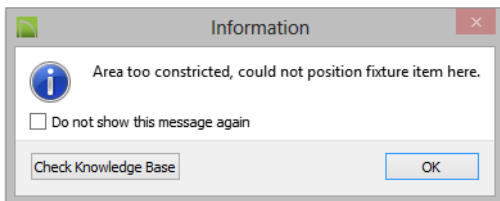

Situations where such message boxes may display include:

- Closing a file or view without saving;
- Modifying an object that is set to rebuild automatically;
- A file referenced outside the program, such as an image or texture, is missing;
- Creating an object in a space too small to contain it.

As with dialog boxes, you can access the options in a message box using the mouse or navigate them using the keyboard.

A few messages have a **Send Report** button. Click this button to send details regarding the issue that prompted the message to Chief Architect via the internet.

Some message boxes include a “Remember my choice” or a “Do not show this again” checkbox. Check this box to prevent messages of this specific type from displaying in the future. When this box is checked, some options in the message box may become inactive.

To allow all message boxes to display again, click the **Reset Message Boxes** button in the **Preferences** dialog. See “Reset Options Panel” on page 69.

---

## Preferences and Default Settings

Preferences and default settings control many aspects of the user interface and tool behavior in Home Designer Architectural. You can use these settings to customize the program to suit your personal work style.

For more information about defaults and preferences, see “Preferences and Default Settings” on page 57.

### Preferences

Preference settings let you change program behavior to suit your workflow. For example, you can:

- Turn certain display elements on or off.
- Choose background and editing feedback colors.

- Set rendering specifications to maximize efficiency and quality.

Preference settings are global, affecting all plan files.

### Defaults

Most objects in Home Designer Architectural derive their initial properties from their respective default dialogs.

For example, a newly placed **Window**  gets its initial values from the **Window Defaults** dialog and a newly placed **Hinged**

**Door**  gets its initial values from the **Door Defaults** dialog.

Once an object is placed in a plan, its initial properties can be overridden, but setting up your defaults before you begin drawing can save you considerable time as you build a model in the program.

Default settings, unlike Preferences, are file specific.

## Dynamic Defaults

Most default settings are static: if you change one, any objects of that type in the current file will not be affected. A few defaults, however, are dynamic: they are tied to existing objects in the drawing and if you change the default, those objects may be affected. See “Dynamic Defaults” on page 59.

---

## Drawing a Plan

When you draw a plan in Home Designer Architectural, you are placing 3D objects that represent building components. Home Designer Architectural comes with predefined default settings so you can start drawing plans immediately. You should review these default settings to be sure they match your drawing and building methods. See “Preferences and Default Settings” on page 57.

### Set the Defaults

1. Specify the defaults for walls.
2. Set material defaults for roof, walls, and rooms.
3. Set style defaults for doors, windows, cabinets and other objects.

### Draw the Floors

1. While the size of the drawing area in Home Designer Architectural is limited only by the resources on your computer, it is best to begin your drawing near the origin, 0,0,0. See “3D Drafting” on page 23.

2. Draw the exterior walls on Floor 1. See “Drawing Walls” on page 130.
3. Adjust the perimeter shape and size as required. See “Using the Edit Handles” on page 136.
4. Place any first floor bearing walls.
5. Define types for special rooms such as garages and decks in the plan. See “Room Types” on page 164.
6. Place perimeter doors and windows. See “Doors” on page 179 and “Windows” on page 197.
7. Build additional floors. See “Adding Floors” on page 221.
8. Specify the default ceiling height for each floor as soon as it is created. See “Floor Defaults Dialog” on page 220.
9. Adjust the perimeter shape of additional floors as needed. See “Editing Walls” on page 135.
10. Align edited or moved walls with those above or below where appropriate. See “Aligning Walls” on page 138.

## Entering Dimensions

When using Imperial units, enter distances as inches or feet and inches, in fractional or decimal form. Millimeters are the default unit for all metric distances. See “Dimensions” on page 485.

- To enter feet, include the ( ' ) marker or the program assumes inches.
- In most cases, the program allows precision to 1/16th of an inch. Fractions with denominators 2, 4, 8 and 16 are allowed.
- The program usually converts decimals to fractions.

## Build the Foundation

1. Derive the foundation plan from the first floor. See “Building a Foundation” on page 229.
2. Adjust the foundation perimeter shape as needed.

3. Place interior foundation walls as needed for the first floor bearing walls.
4. Place any other foundation walls required.
5. **Align with Above** as needed. See “Aligning Walls” on page 138.

## Add Structure and Details

1. Build non-structural interior walls. Begin on floor one and work up in multiple story structures.
2. Add walls where needed to create features such as chimney chases, plumbing walls, or Open Below areas.
3. Finish the relevant interior structure including interior doors, doorways, cabinets, fixtures, and fireplaces.
4. Build the terrain and landscaping. See “Terrain” on page 333.

---

## Viewing Your Plan

You can see your model in a variety of different 2D and 3D views. You can display more than one view at a time; and in any view, you can pan or zoom in or out. See “Window and View Tools” on page 441.

Floor plan view is a 2D view of the model and is most commonly used for drawing and editing. In floor plan view, each floor displays separately and you can only edit one floor at a time; however, you have extensive control over which objects display at any given time, can easily switch between floors, and can also display items on a second floor for reference. See “Multiple Floors” on page 219.

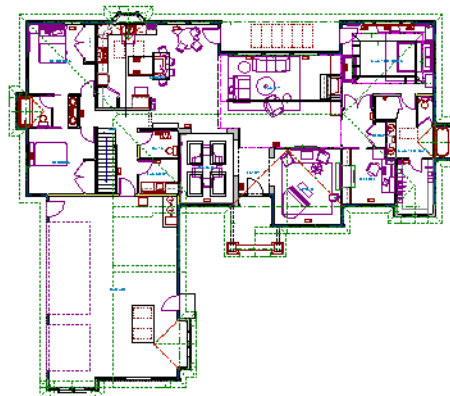

You can create interior and exterior 3D views of your model from any perspective. As in floor plan view, you can select and edit many objects in 3D views and control which objects are visible. See “3D Views” on page 447.



You can also create **Doll House Views** that show only the current floor plus any floors beneath it. Ceilings on the current floor are omitted so you can see the interior, visualize the relationships between spaces, and plan traffic flow.



**Framing Overviews** display framing in 3D. You can customize 3D views to serve special purposes such as this.



All views can be exported as a graphic image. See “To export a picture” on page 536.

---

## Getting Help

 There are many forms of help available in Home Designer Architectural including: Tool Tips, the Status Bar, and the online Help menu.

All these forms of help assume you have a basic working knowledge of your operating system, including how to use a mouse, open, close and save files, copy, paste, and right-click to access contextual menus. Help also assumes you are familiar with basic computer terminology.

More information is available in the product documentation in electronic format and on Home Designer’s official web site, [www.HomeDesignerSoftware.com](http://www.HomeDesignerSoftware.com).

See “Additional Resources” on page 587.

### Tool Tips

When you move the pointer over a toolbar button or menu item, a **Tool Tip** displays, offering a brief description of the tool. More information displays in the Status Bar at the bottom of the window.

### Contextual Help

 Online **Help** is a searchable menu that provides information about all of the tools in Home Designer Architectural. Select **Help > Launch Help** to open the program’s

Help and explore the table of contents, browse the Index, or Search for keywords.

The Help can also be used to provide instant information about toolbar buttons, menu items, and objects in your plan.

- When you move the cursor over a toolbar button or menu item, a brief summary of that tool displays in the Status Bar. Press the F1 key to open online Help to a page with more information about the tool.

- When an object is selected, edit handles display. Place the cursor over an edit handle and press **F1** to open online Help to a page with information about that handle.
- Press the **Help** button in any dialog box to open online Help to a page describing the options in that dialog.

Chief Architect strives to make our documentation as helpful as possible for all of our customers. Please send any suggestions to [documentation@chiefarchitect.com](mailto:documentation@chiefarchitect.com).

---

## About Home Designer

Select **Help> About Home Designer Architectural** in Windows® or **Home Designer> About Home Designer** in Mac OS X® to view information about your

software license, the program's version number, and its release date.

Contact information for Chief Architect, Inc. is available on the MORE INFORMATION panel.

---

## Product Upgrade Options

Select **Help> Product Upgrade Options** to launch your default web browser to the Home Designer web page,

[www.homedesignersoftware.com](http://www.homedesignersoftware.com), where you can learn about options for upgrading your software license.

---

## Home Designer Trial Software

Free Trial versions of some Home Designer programs are available for download at [www.HomeDesignerSoftware.com](http://www.HomeDesignerSoftware.com).

The Trial software offers the same functionality as a purchased license with a few limitations:

- File Saving
- Printing
- File Exporting
- Recording of Walkthroughs
- Printing or Exporting of Materials Lists
- Library Browser restrictions

## Converting the Trial Version

An installation of the Home Designer Architectural Trial software can be converted into a full working version of the program at any time by purchasing a software license. There are several ways to begin this process in the Trial:

- Click the **Purchase Full Version Now** button in any Trial Restriction message box.
- Select **Help> Purchase Home Designer Architectural** .

- Select **File> Startup Options**  and then click the **Purchase Full Version Now** button.

Once you have purchased a license, you can activate it while the Trial software is running.

### *To activate the full version*

1. Select **Help> Activate Full Version**.
2. In the **Product Activation** dialog, type or paste the **Product Key** associated with your software license.
3. Click the **Activate Full Version** button.





# File Management

Home Designer Architectural saves the complete 3D model of a structure and surrounding terrain as well as any CAD data associated with the model in **.plan** files.

All commands related to opening, saving and closing plans are located in the File menu. You can also open plans from the **Startup Options** dialog. See “Startup Options” on page 22.

Just as with files created in other software applications, you should back up your plan files externally on a regular basis to avoid accidental loss of work.

## Chapter Contents

- Compatibility with Other Programs
- Organizing Your Files
- Home Designer Architectural Data
- Creating a New Plan
- Saving, Exporting, and Backing Up Files
- Thumbnail Images
- Auto Archive
- Undo Files
- Opening and Importing Files
- Referenced Files
- Backup Entire Plan
- Closing Views and Files
- Exiting Home Designer Architectural

---

## Compatibility with Other Programs

Plans produced in the following programs can all be read by Home Designer Architectural 2017.

- Chief Architect® X1 through X8 (limited editability if enabled)
- Chief Architect® 5.0 through 11.3 (read only)
- 3D Home Architect® 3.0 and 4.0
- Chief Architect® Home Edition 5.0
- All Better Homes and Gardens Home Designer® products, Interior Designer, and Landscaping and Deck Designer, Versions 6 through 8.
- All Chief Architect Home Designer® products, Interior Designer, and Landscaping and Deck Designer, Versions 9 through 2015.
- Trading Spaces® Design Companion™

Note: 3D Home Architect 5.0 was not developed by Chief Architect, Inc. Plans written using 3D Home Architect 5.0 or later cannot be read by Home Designer Architectural software.

Files that have been opened and saved in Home Designer Architectural 2017 cannot be read by any of the program versions listed above. To continue to read files in the program in which they were created, be sure

to create copies of your files before opening them in Home Designer Architectural 2017.

Plans produced in the Windows® version of Home Designer Architectural 2017 can be read in the Mac® version, and vice versa.

### Opening Chief Architect Plans in Home Designer Programs

Plans created in Chief Architect Versions 5 through X8 and Home Designer Pro Versions 6 through 2017 can be opened in the latest Home Designer programs for viewing and annotating, but not for general editing or drawing of architectural objects.

Plans created in build 11.4 or later of Chief Architect X1 or Home Designer Pro 8, or in later program versions, can be set to allow limited editability in other Home Designer programs. When this permission is enabled, a Home Designer user can use all of their program's drawing tools and can edit objects in the plan that those tools can create. If an object cannot be created in the Home Designer program, however, it will not be editable.

In addition, Chief Architect and Home Designer Pro have the ability to lock layers. Objects cannot be drawn on locked layers; objects on locked layers cannot be selected; and locked layers cannot be unlocked in the other Home Designer programs. See "Layers" on page 75.

---

## Organizing Your Files

You should keep your plan files separate from the support files needed to run Home Designer Architectural. To keep files organized, you may find it helpful to create a new folder for each project.

Home Designer Architectural files may use imported images, textures and other custom content saved in their own external data files. Consider storing copies of all external files in the same folder as the plan files that use them so that they are easily found.

Here is one way to organize your files:

- Create a folder in your Documents directory called “Home Designer Architectural Plans” or another name you prefer. See your operating system’s Help to learn how to create folders.

- Inside this folder, make a new folder for each client or project. Save all the files for that client or project inside this folder, including plan files and referenced external files. See “Saving, Exporting, and Backing Up Files” on page 45.

Bear in mind, though, that path names exceeding 260 characters cannot be opened by Home Designer Architectural. As a result, it is a good idea to limit the number of embedded folders you use in your file organization method.

Once you understand the file management of Home Designer Architectural, you can decide on a naming convention that suits your needs.

---

## Home Designer Architectural Data

When Home Designer Architectural 2017 is installed, the program automatically creates a folder in the user Documents directory called **Home Designer Architectural 2017 Data**. This folder contains important user-specific information saved in the following folders and files and should not be moved, renamed or deleted:

- **Archives** - A folder of automatically archived plan files. See “Auto Archive” on page 49.
- **Backdrops** - A folder of custom backdrop images. See “3D Backdrops” on page 455.

- **Images** - A folder of custom images. See “Adding Materials and Images” on page 402.
- **Database Libraries** - A folder of user library data. See “Library Content” on page 398.
- **Scripts** - A folder for custom Ruby scripts associated with Chief Architect plans.
- **Templates** - A folder of plan template files. See “Creating a New Plan” on page 44.
- **Textures** - A folder where you can save image files used to create custom material textures. See “Creating Materials” on page 424.

- **Toolbars** - A folder of toolbar files. See “Toolbar Arrangement” on page 71.

 If the Home Designer Architectural 2017 Data folder is renamed, moved or deleted, the program will automatically replace it using default information from the Home Designer Architectural installation folder. When this occurs, customized user settings and custom user library content will not be available.

Because the Home Designer Architectural 2017 Data contains custom user data, it is not deleted when the program is uninstalled. See “Uninstalling Home Designer Architectural” on page 17 of the User’s Guide.

---

## Creating a New Plan



To open the **Create New Plan** dialog, select **File> New Plan**.

You can also choose **New Plan** in the **Startup Options** dialog. See “Startup Options” on page 22.

## Template Plans



When you select **File> New Plan** in Home Designer Architectural, the **Create New Plan** dialog opens, letting you select a template for your new plan. The resulting new plan uses either metric or Imperial units of measurement and predefined default settings, layer settings, wall definitions, and page setup information.

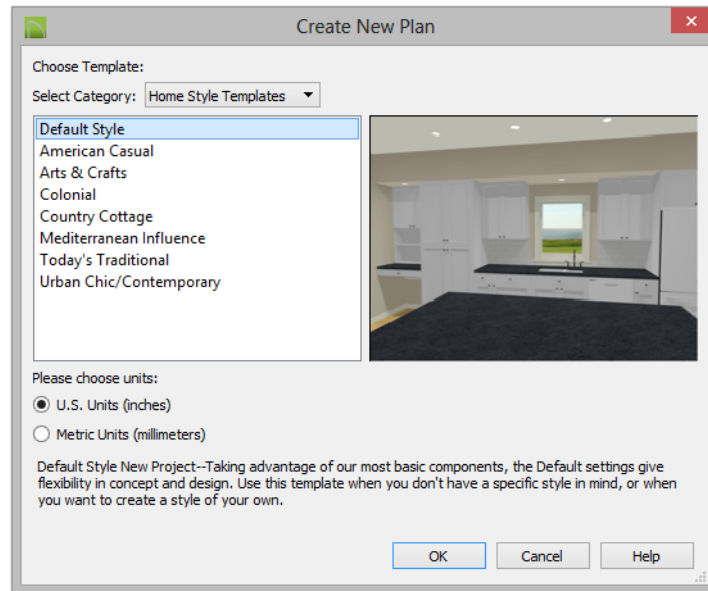

Home Designer Architectural includes a selection of plan templates, each with different default settings that allow you to begin working in a particular plan style quickly.

Choose a category from the drop-down list, then select a style template from the scrollable list beneath it. If you are uncertain as to the right style for your plan, choose

Default, as you cannot change the plan style template once a plan has been created.

Select either **U.S. Units** or **Metric Units** of measurement, and click **OK**. The floor plan view window opens, ready for you to begin drawing.

New, blank plans are called **Untitled.plan**. Unless these files are named and saved, they will be lost when closed.

---

## Saving, Exporting, and Backing Up Files

Saving, exporting, and backing up your files are three separate tasks that accomplish different things:

- Saving a plan file retains your work so that it can be later opened in Home Designer Architectural.
- Exporting a file allows you to save certain kinds of data in a format that can be used by a program other than Home Designer Architectural.
- Backing up your files involves taking steps to make sure that your valuable data is protected and available when needed.

Whether you are saving, exporting, or backing up your data, it is important that you select a location on your computer for the files you create, and also specify a short, meaningful name that you will be able to identify in the future.

### *To save an untitled plan file*

1. Select **File> Save**  to open the **Save File** dialog.
2. Specify a location on your computer where you would like to save the file. See “Organizing Your Files” on page 43.
3. In the **File name** text field, type a name for the file.
4. Home Designer Architectural automatically assigns the **File of type** and file extension **.plan**.
5. When both the Save in location and File name are correct, click **Save**.







Although the program warns you if you try to exit without saving, you should get in the habit of saving plan files before exiting the program.



## Saving Plan Files





When you first save a new, untitled file, you must select a location for it on your computer and give it a name. There are two options for saving plan files: **File> Save** and **File> Save As**.

Both **Save**  and **Save As**  can be used to save your plan files; however, they accomplish this in two different ways.

- **File> Save**  saves the current state of your plan file without changing its name and should normally be used for saving your work.
- **File> Save As**  opens the **Save File** dialog, allowing you to save the plan file using a different name or location on your computer.

Initially, all **Open**  and **Save As**  operations go to the “My Documents” folder of your computer. After that, the location last visited is remembered and subsequent

**Open**  or **Save As**  commands default to the directory last used for that operation. This path is saved when the program exits. The next time Home Designer Architectural is launched, these defaults are used.

## Save File Dialog

The **Save File** dialog uses the operating system’s file save dialog format, and is also used when exporting files. The dialog name

may vary, depending on the type of file being saved or exported.

A similar **Select Folder** dialog allows you to select a folder to which files can be exported.

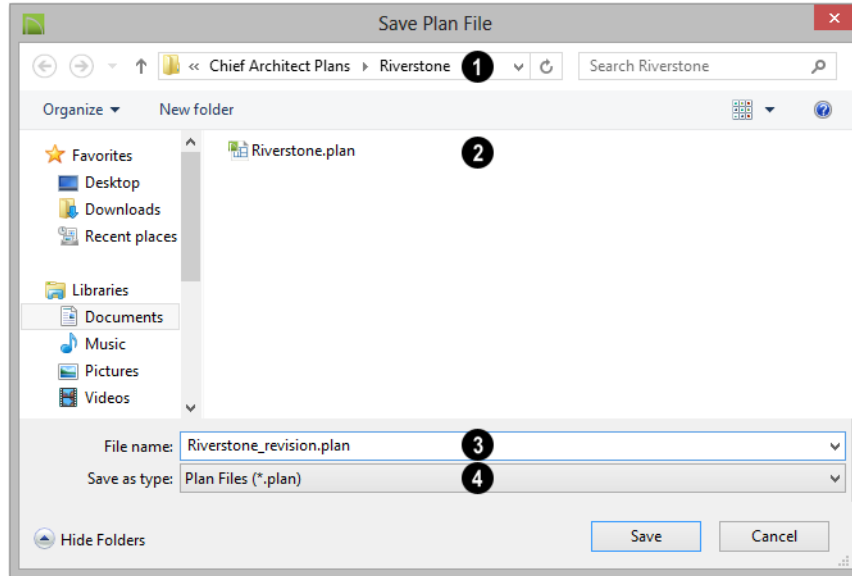

- 1 Choose a location on your local computer for the file you are saving.
- 2 Any existing folders and/or files in the current location display here.
- 3 In the **File Name** field, type a name for the file. If you select an existing file from the space above, its name will display here automatically.
- 4 When saving a file, the program will choose the appropriate file type from the **Save as type** drop-down list. When exporting, you may need to choose a specific file type.

### Saving Revision Files

Revisions are a common aspect of any design project. There are a number of possible strategies for organizing revision files:

- Prepending the file name;

- Appending the file name;
- Saving revisions in separate folders.

To avoid confusion and potential mistakes, it is recommended that you always give files unique names - including revision files. If you choose to organize your revisions by saving them in separate folders, you should also give each file a unique name that makes it impossible to confuse it with another file saved in a different folder.



### Exporting Files

Home Designer Architectural has a number of options for exporting and importing information out of and your drawings. See “Pictures, Images, and Walkthroughs” on page 529.

Often, file export dialogs are simply versions of the **Save File** dialog.

Similarly, file import dialogs are often similar to the **Open File** dialog. See “Importing Files” on page 51.

## Backup Entire Plan

**File > Save As**  is a simple way to transfer a plan to a different location on your computer. Bear in mind, though, that plan files often reference external data files such as imported textures, images, and backdrops. These external files are not affected when **Save As**  is used.

If you transfer a plan file from one computer to another, the program will warn you of missing files if the external data files used by the plan cannot be found when you open it.

When transferring plans to another computer that does not have these external files, use the **Backup Entire Plan**  tool. See “Backup Entire Plan” on page 53.

## Backing Up Your Files

It is always a good idea to create backup copies of all your important files on your computer.

It is strongly recommended, however, that you never save directly onto removable media such as a USB thumb drive, CD, or DVD. Instead, copy your files to such locations only after you have saved them on your computer’s hard drive and exited the program.

Archive folders are used by Home Designer Architectural to manage prior versions of your files. You should not view these files as a substitute for your own backup routine, and should never save a file in an archive folder. See “Auto Archive” on page 49.

When backing up your Home Designer Architectural files, consider backing up not only your **.plan** files, but your custom user data, as well - including library content, toolbar configurations, and textures. This custom data is all located in the Home Designer Architectural Data folder, so it can be easily backed up. See “Home Designer Architectural Data” on page 43.

You can, if you wish, create a folder inside the Data folder for your **.plan** files, as well. See “Organizing Your Files” on page 43.

---

## Thumbnail Images

A thumbnail is a miniature image that helps identify a file in the **Open Plan File** dialog in Windows. Any view of a plan can be saved as the thumbnail.

The program automatically creates a thumbnail image when you first save a new plan. You can choose to generate small or large thumbnails.

### *To create a custom thumbnail image*

1. You must save the file and give it a name before you can save a thumbnail.
2. Create the 2D or 3D view that you want to use as a thumbnail for the current file.
3. With the desired view active, select **File > Save Thumbnail Image** .



Thumbnail images are saved in the plan file that they are associated with.

---

## Auto Archive

The first time a plan is saved, Home Designer Architectural creates an Archive folder in the Home Designer Architectural Data folder. The Archive folder contains Auto Save and Archive files.

The program does not create Auto Save and Archive files for untitled plans. In order for these to be created, a file must have been previously saved and given a name and save location on your computer. Further, Archive files are only updated when you save your work.

Auto Save and Archive files should not be viewed as a substitute for regularly saving your work by selecting **File> Save**  or pressing Ctrl + S on the keyboard, nor should they be considered an alternative to your own file backup routine.

### Archive Files

Every time a drawing is saved, Archive files that keep a historical archive of your plan are automatically created or updated.

 If you do not save your work regularly, your archive files will not be updated.



Plan files from previous versions of the program are automatically moved to the archive folder when the plan is opened and saved in Home Designer Architectural.

Archive files are meant to be for emergency use only. If you must access an archive file,

open it as you would any other file. See “Creating a New Plan” on page 44. As soon as the file is open, use **Save As**  to save this file to another location.

### Legacy Archive Files

Plan files saved in the current program version are not backwards-compatible: that is, they cannot be opened in older versions of the software.

If you open a Home Designer plan file from a previous program version and immediately **Save**  it (not **Save As** ), the Auto Archive utility will create an additional archive file using the original program version format. This archive file is a copy of the original and can still be opened in the original program version.

### Auto Save Files

As you work, Home Designer Architectural automatically creates Auto Save files at regular intervals when changes are made to a file but not saved by selecting **File>**

**Save** .

These Auto Save files are appended **\_auto\_save.plan** and are saved in the Archive folder.

When you close a file normally, its Auto Save file is retained until the next time the file is opened - at which time the Auto Save file is overwritten.

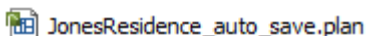

*Auto Save file after normal shut-down*

Auto save files created as a result of an improper program shutdown are appended **\_auto\_save\_bak.plan**.

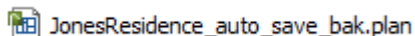

*Auto Save file after abnormal shut-down*



If your computer shuts down accidentally, you can recover some of your work by opening the **\_auto\_save\_bak** file.



A file is auto saved only if you have saved it previously. Auto Save does not work for unnamed files.

When you reopen a file after a computer shut down or system crash, the program will notify you if an Auto Save file newer than the original file is found and give you the option to one that file.



Even with Auto Save, you should save your work manually on a regular basis using any of the following methods:

- Click the **Save**  button.
- Select **File> Save** .
- Press Ctrl + S on the keyboard.

---

## Undo Files

Home Designer Architectural stores a set number of copies of all open plan file changes, known as undo files. Undo files are referenced whenever you select **Edit>**

**Undo**  or **Edit> Redo** . See “Undo and Redo” on page 118.

Undo files are stored in your operating system’s Temp directory. When Home Designer Architectural is closed normally, any current Undo files are deleted.

---

## Opening and Importing Files

Opening and importing files are often similar tasks, but accomplish two very different things:

- Opening a file refers to opening it in the program in which it was created. Only plan files can be opened in Home Designer Architectural. See “Compatibility with Other Programs” on page 42.

- Importing a file brings data that was created in a different program into Home Designer Architectural. A number of different file types can be imported into Home Designer Architectural.



Select **File> Open Plan** to open an existing **.plan** file located on your computer. Home Designer Architectural

automatically browses to the directory last used.

 Before opening a file located on a removable storage device, server, or other computer on a network, copy it to your local machine's hard drive first.

## Open File Dialog

The **Open File** dialog uses the operating system's file open dialog format, and is also used when importing files. The dialog name may vary, depending on your operating

system and the type of file being opened or imported.

A similar **Select Folder** dialog allows you to select an entire folder of files to import.

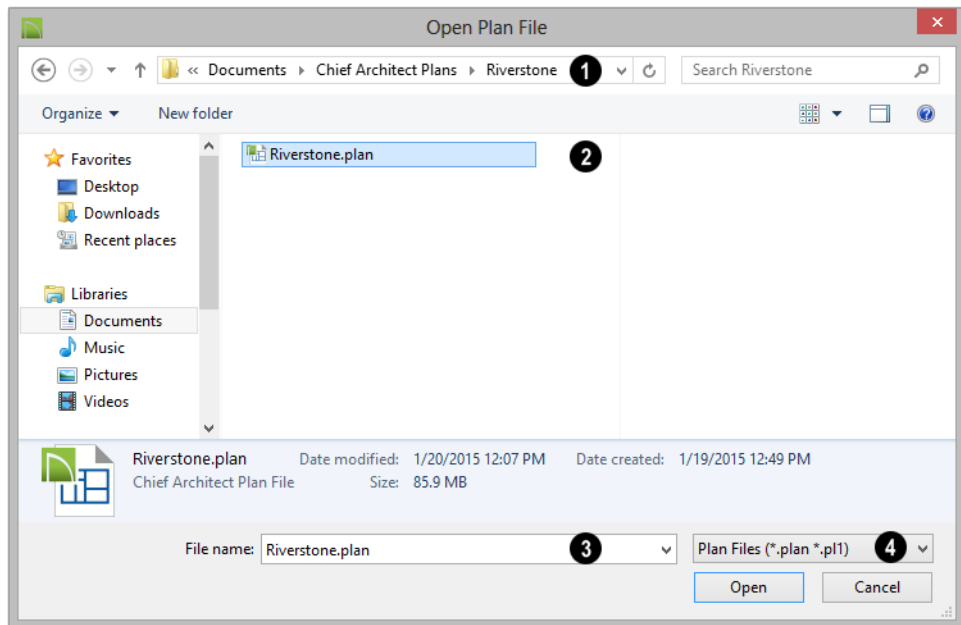

- 1 Choose the location on your local computer for the file you are opening.
- 2 Any existing folders and/or files in the current location display here.
- 3 In the **File Name** field, type the file's name. If you select the file in the space

above, its name will automatically display here.

- 4 When opening or importing a file, the program will usually choose the appropriate file type from the **Save as type** drop-down list. When importing, you may need to choose a specific file type.

Plan files open to the floor that was active when the file was last saved and closed.

## Importing Files

Home Designer Architectural has a number of options for exporting and importing information out of and into your drawings. Often, file import dialogs are simply versions of the **Open File** dialog. See “Pictures, Images, and Walkthroughs” on page 529.

Similarly, file export dialogs are often similar to the **Save File** dialog. See “Exporting Files” on page 47.

## Recently Opened Files

A list of recently opened and saved plan files can be accessed by selecting **File> Open Recent Files**. Select one of these files to open it without using the **Open File** dialog.

The names of recent files also display in the **Startup Options** dialog. Click on the name of a file to open it. See “Startup Options” on page 22.

---

## Referenced Files

Home Designer Architectural plan files often reference a variety of external files for added detail, including:

- Material Textures
- Images
- Plant Images
- 3D Backdrops
- Picture Files
- PDF Files

Whenever any view in a plan is opened, the program checks for referenced files used in that view and will notify you if any of those files cannot be found by opening the **Missing Files** dialog.

You can also open this dialog at any time by selecting **Tools> Checks> Missing Files**. When accessed this way, all missing files associated with the current file are listed: not just those used in the current view.

## Missing Files Dialog

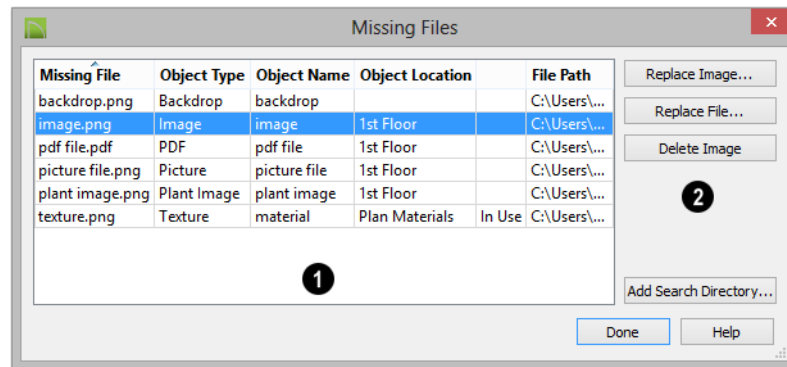

- 1** The table lists any Missing Files as well as useful information about each:
- Object Type indicates how the missing file is used in the program
  - **Object Name** states the name of the object in CA that references the file.
  - **Object Location** indicates where in the file the object can be found.
  - The next column indicates whether a missing texture is in use in the plan.
  - **File Path** states the last known location of the missing file on your computer system.

Click on a line item in the table to select it and resolve it using the options on the right. Multiple line items can be selected; however, the selections on the right may be limited. See “Shift and Ctrl Select” on page 89.

- 2** The buttons on the right offer options for resolving a selected missing file. The names of these buttons will vary somewhat, depending on the type of file(s) selected in the list on the left
- Click the top **Replace Object** button to replace any instances of an object or

material referencing the selected missing file with a different object or material from the library. Not available for PDF files or picture files.

- Click the **Replace File** button to open the **Browse for Missing File** dialog and select a file saved on your system to replace the missing one. See “Opening and Importing Files” on page 50.
- Click the **Delete Object** button to remove the object or material referencing the missing file from the plan. Not available for material textures that are In Use.
- Click the **Add Search Directory** button to direct the program to a particular folder to search for missing files in. The list of Search folders can be reset in the **Preferences**  dialog. See “Reset Options Panel” on page 69.

You can prevent this dialog from opening automatically by checking **Do not display missing files again during this session** at the bottom of the dialog. This option is not available when the dialog is opened manually.

## Backup Entire Plan



Because Home Designer Architectural plans often contain many references to other external files, it is necessary to copy all the associated files to a new location when a plan is moved. You can do this easily by selecting **File> Backup Entire Plan**.

Backing up an entire plan is important when:

- Migrating legacy files created in older program versions.
- Transferring files to another computer or sending them to another user.
- Archiving or backing up your work.

### To back up a plan

1. To copy all associated plan files to a new directory, select **File> Backup Entire Plan** . The **Backup Entire Plan** dialog opens.

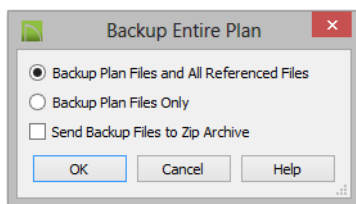

- Choose **Backup All Files** to copy the plan file and all externally referenced files such as inserted picture files,

metafiles, and texture, image, and backdrop graphics files.

- Choose **Backup Plan Files Only** to copy any externally linked files and inserted picture files, but no graphics or texture files. This is best used only when transferring a file to a computer that already has the graphics files installed.
  - Check **Send Backup Files to Zip Archive** to save the files in a zipped folder instead of a regular folder.
  - Click **OK**.
2. The **Select the Plan Backup Folder** dialog opens next. This is a typical Save File dialog. See “Saving, Exporting, and Backing Up Files” on page 45.
  3. Navigate to a folder on your system and select it. If you did not opt to save the files in a zipped folder, the destination folder must be empty.
  4. With the destination folder for the backup selected, click **OK**.



When Send Backup to Zip Archive is unchecked, you must select an empty folder for the Backup Entire Plan feature to work. If you select an existing folder that is not empty, the backup is cancelled.

## Closing Views and Files

There are several ways to close a view window:

- Select **File> Close** to close the active window.

- Press **Ctrl + W** or **Ctrl + F4** on the keyboard to close the active window.
- Click the **Close** button in the active view's title bar or in any view's tab.
- A tabbed view can be closed by clicking on its tab using the middle mouse button.
- Select **File> Close All Views** to close all currently open view windows instead of just the active window.

If a plan has only one view window open and you try to close it, the program will prompt you to save before closing if there are any unsaved changes.



Although the program warns you if you try to exit without saving, you should get in the habit of saving plan files before exiting.

---

## Exiting Home Designer Architectural

Select **File> Exit** to exit the program. If you have not saved any open plans, you are reminded to do so. It is better to save your work before exiting than to save on exit.

When you exit from the program using **File> Exit**, all Autosave files and Undo files are automatically deleted.

On a Mac, if you click the program window's red **Close** button, the window will close but the program itself will continue to run. To close it down completely, right-click on its icon on the Dock and select **Quit** from the contextual menu.





# Preferences and Default Settings

Preferences are global settings that affect the functionality and appearance of the Home Designer Architectural environment, while default settings control what objects look like when they are initially created. You can save time by becoming familiar with these settings and customizing them before you begin a new drawing.

## Chapter Contents

- Default Settings vs Preferences
- Dynamic Defaults
- Reset to Defaults
- General Plan Defaults Dialog
- Preferences Dialog
- Angle Style Dialog

## Default Settings vs Preferences

Default and preference settings have important effects on how the tools in Home Designer Architectural function. Default settings are file specific, while Preferences are global, taking effect regardless of what file is open.

Defaults and Preferences can be customized to suit your needs, so it is recommended that you become familiar with them and learn how you can use them to your advantage.

### Default Settings



Default settings determine the initial characteristics of objects when they are first drawn. For example, when you place a base cabinet in a plan, its size, materials, front items, hardware are determined by settings in the **Base Cabinet Defaults** dialog.

Defaults are file-specific, which means that any changes that you make to the default settings in one plan file will have no effect on other plans.

You can access a complete list of the various default settings in the current plan file by selecting **Edit> Default Settings**  from the menu.

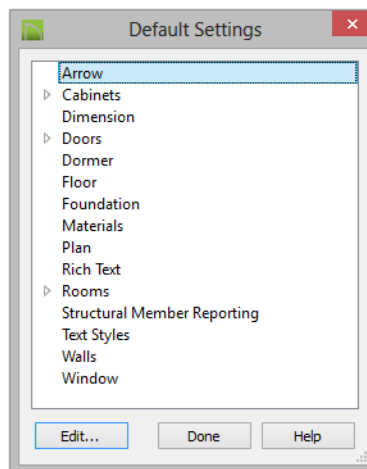

- Click the + beside a category to expand it and access the defaults for items related to that category.
- To open the defaults dialog associated with an item in the list, double-click on the line item, or click on the item and then click the **Edit** button.

### Preferences



Preference settings influence the overall environment of the program, such as what the interface looks like and how the tools are accessed. See “Preferences Dialog” on page 61.

Unlike default settings, Preferences are global, which means that any changes that you make to them will take effect in all plan files.

To access the **Preferences** dialog, select **Edit> Preferences**  from the menu.

## Dynamic Defaults

Dynamic defaults are values that can be changed globally throughout a model.

- If you change a dynamic default value in a defaults dialog, all objects of that type that are set to use the default will update automatically to use the new value.
- Any objects of that type that are not using the default value because of editing will not be affected if you change the default.

Dynamic defaults are found in the default dialogs of a variety of objects, including dimension lines, walls, doors, cabinets and rooms.

Materials are another example of an attribute that uses Dynamic Defaults. See “Material Defaults” on page 416.

In object specification dialogs, dynamic defaults are followed by either a (D) in the value field or a Default checkbox.

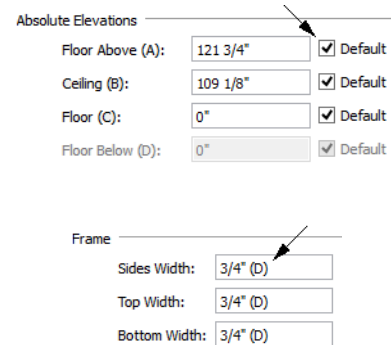

Absolute Elevations

Floor Above (A): 121 3/4"  Default

Ceiling (B): 109 1/8"  Default

Floor (C): 0"  Default

Floor Below (D): 0"  Default

Frame

Sides Width: 3/4" (D)

Top Width: 3/4" (D)

Bottom Width: 3/4" (D)

To edit a dynamic default, delete the (D) or remove the check from **Default** box and type the desired value.

To reset a value back to the dynamic default, type the letter D in the field or click the Default checkbox.

## Reset to Defaults

Select **Edit > Reset to Defaults** to open the **Reset to Defaults** dialog.

This dialog allows you to reset critical structural settings in the current plan to the default values.

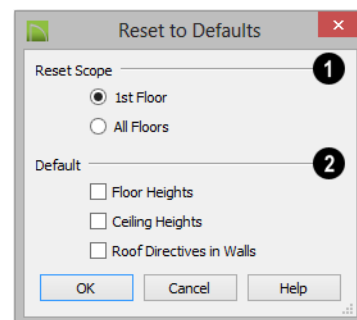

Reset to Defaults

Reset Scope

1st Floor

All Floors

Default

Floor Heights

Ceiling Heights

Roof Directives in Walls

OK Cancel Help

- 1 The settings can be cleared for the **current floor** or for **All Floors**.

- 2 Specify which settings you want to reset to **Default**.
- **Floor and Ceiling Heights** - Floor and ceiling heights for any room can be changed in the **Room Specification** dialog. Check to reset the default values as specified in the **Floor Defaults** dialog. See “Floor Defaults Dialog” on page 220.

- **Roof Directives** - You can specify how the roof builds above an exterior wall in its **Wall Specification** dialog. When Roof Directives are reset, all items on the ROOF panel are unchecked and any value, such as the roof pitch, is reset to the default. See “Roof Directives in Walls” on page 245.

## General Plan Defaults Dialog

The settings in the **General Plan Defaults** dialog control basic features of the Home Designer Architectural environment in plan files. Just as with other default settings, they are file specific, which means that they can

be set differently in individual plan files. To open this dialog, select **Edit> Default**

**Settings** , select **Plan**, and click the **Edit** button.

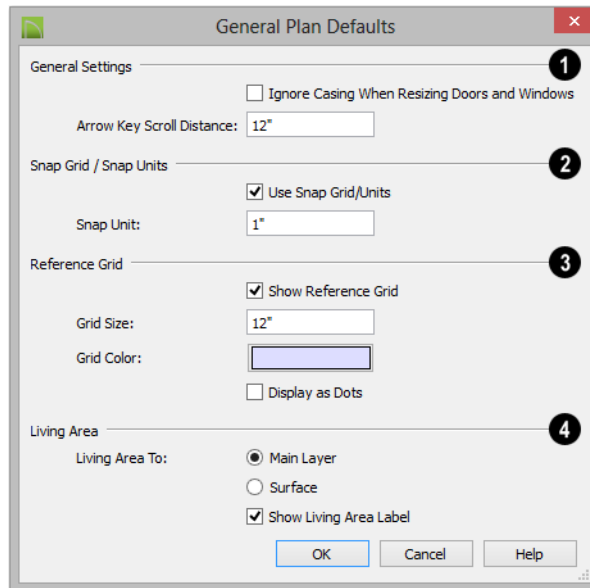

- 1 **General Settings** - Specify the default functionality for a variety of general behaviors in the program.

- Casing is the trim that surrounds a door or window. When you resize a door or window, its sides are kept away from intersecting walls by the width of the casing.

- Check **Ignore Casing for Opening Resize** to allow wall openings to be positioned against an intersecting wall. Clear this box retain sufficient space for the opening's specified trim width.
- The **Arrow Key Scroll Distance** setting determines how far to scroll in floor plan view when you press an arrow key. The initial default is 12 inches (300 mm). See “Using the Arrow Keys” on page 444.
  - ② The **Snap Grid** allows you to snap objects to specific points on-screen as they are moved or resized. See “Grid Snaps” on page 81.
    - Check **Use Snap Grid/Units** to enable Grid Snaps.
    - Specify the **Snap Unit** you wish to use. The initial default is 1 inch (10 mm).
    - ③ Specify the display of the **Reference Grid**.
  - Check **Show Reference Grid** to display the Reference Grid, the virtual graph paper used to create a sense of scale in floor plan view.
  - Specify the **Reference Grid Size**.
  - Check **Display as Dots** to display the Reference Grid using dots rather than lines.
  - ④ Specify how the **Living Area** label is calculated and whether it displays in floor plan view. Not available in layout files. See “Living Area” on page 167.
    - Select **Main Layer** to have the Living Area calculation measure from the walls' Main Layer.
    - Select **Surface** to have the Living Area calculation measure from the walls' exterior surface.
    - Uncheck **Show “Living Area”** to disable the display of the Living Area label.

---

## Preferences Dialog



The settings in the **Preferences** dialog are global: they apply to all plan files and are preserved between sessions. To access this dialog, select **Edit> Preferences** in Windows<sup>®</sup> or **Chief Architect> Preferences** in Mac OS X<sup>®</sup>. Unlike most dialogs in the program, it is not necessary to have a plan file open to access the **Preferences** dialog.

The **Preferences** dialog's list of panels is organized in a tree structure with categories and subcategories. A white arrow next to a

category indicates that it has subcategories. Click the arrow to make the subcategories visible; to hide them, click the filled arrow.

**Preferences** dialog panels:

- Appearance Panel
- Colors Panel
- Library Browser Panel
- General Panel
- Folders Panel
- Edit Panel
- Render Panel
- Video Card Status Panel
- Reset Options Panel

## Appearance Panel

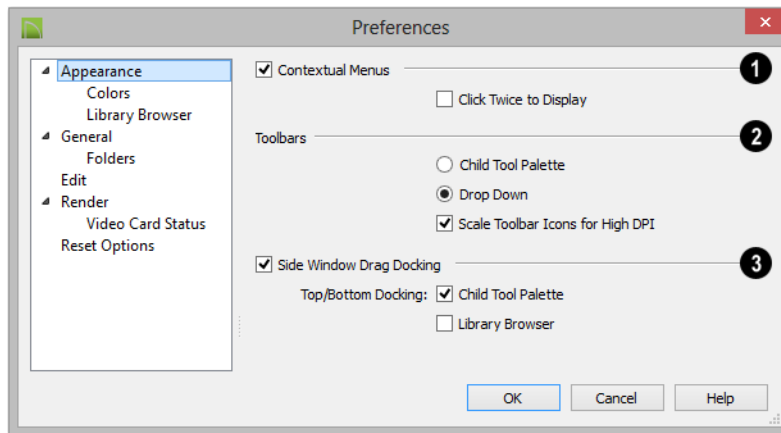

1 Check **Contextual Menus** to activate contextual menus that display when you right-click. See “Contextual Menus” on page 29.

- Check **Click Twice to Display** to require two right-clicks on an object before the contextual menu displays. This allows the first right-click to be used for object selection. See “Selecting Objects” on page 88.

In 3D views, the two clicks must be on the same object surface in order for the contextual menu to display: Clicking on two different surfaces of the same object is treated like two single-clicks.

- 2 Specify how **Toolbars** present child tools when a parent button is clicked.
- Choose **Parent-Child** to display child tools as buttons at the end of the toolbar where the parent button resides.

- Choose **Drop Down** to display child tools when the drop-down arrow to the right of the parent button is clicked.
- Uncheck **Scale Toolbar Icons for High DPI** to prevent toolbar icons from becoming larger on systems using high DPI resolution. When checked, toolbar buttons will increase in size when high DPI is used.

3 Uncheck **Side Window Drag Docking** to prevent undocked side windows from docking when moved using the mouse. A side window can still be docked to its last docked location by double-clicking its title bar. See “View and Side Windows” on page 27.

- **Top/Bottom Docking** - Check the box beside a side window’s name to allow it to dock on the top and bottom edges of the program window. Does not affect docking to the left and right sides.

## Colors Panel

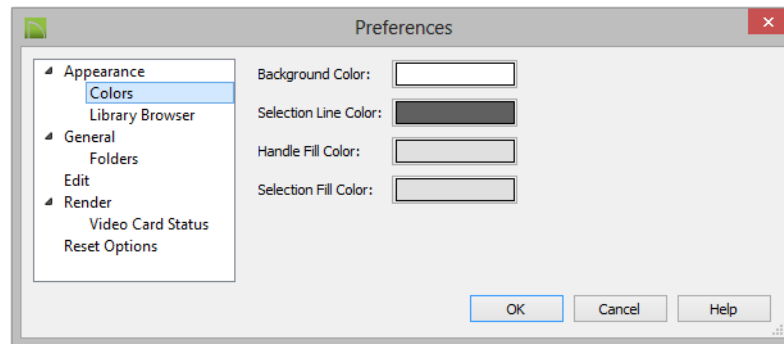

Click a color bar to open the **Select Color** dialog. See “Select Color Dialog” on page 438.

- Specify the **Background Color** for all views except some 3D views. See “Rendering Techniques” on page 478. The background color for 3D views that do not use the Vector View Rendering Technique or a backdrop image is set in the **3D Backdrop** dialog. See “Backdrop Dialog” on page 448.
- Specify the **Selection Line Color**, which is the color of the lines that represent object(s) and their edit handles when they are selected.

- Specify the **Handle Fill Color**, which is the fill color of the edit handles for selected objects.
- Specify the **Selection Fill Color**, which is the fill color for selected objects. Note that depending on the fill assigned to a selected object, its Selection Fill color may vary.

Note: If the Selection Line and Handle Fill Colors are similar, it may be difficult to distinguish between active and inactive CAD Points.

## Library Browser Panel

The **LIBRARY BROWSER** panel controls the appearance of the Library Browser window. See “The Library Browser” on page 394.

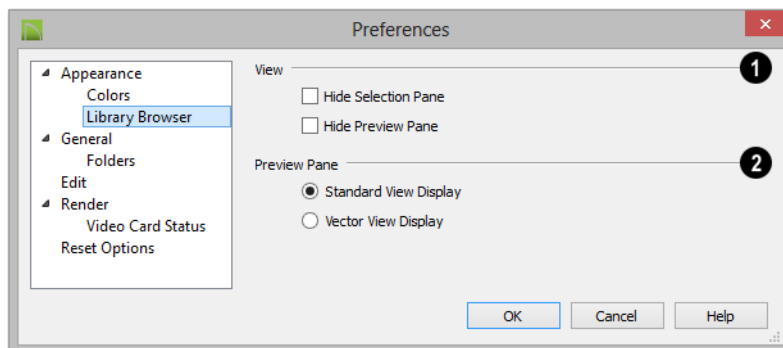

**1** View options control the display of the main sections of the Library Browser.

- Check **Hide Selection Pane** to hide the pane that displays objects in a selected library or library folder.
- Check **Hide Preview Pane** to hide the pane that shows a preview of a selected object.

**2** Specify whether selected library items in the **Preview Pane** are displayed using the **Standard** or **Vector View** Rendering Technique. See “Rendering Techniques” on page 478.

To restore the original size and position of the Library Browser and other side windows, click the **Restore Side Windows** button on the Reset Options Panel.

## General Panel

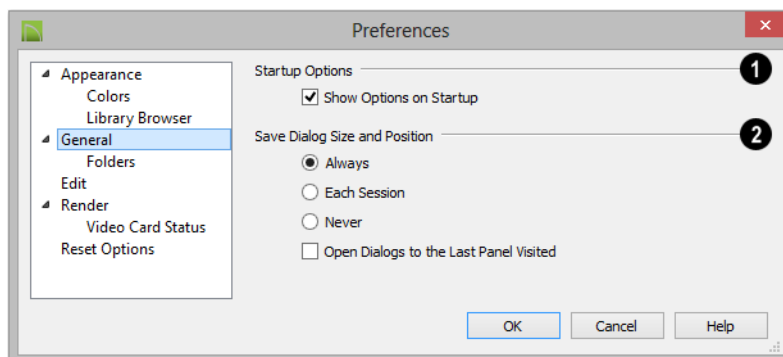



- 1 Check **Show Options at Startup** to open the **Startup Options** dialog when Home Designer Architectural is launched. See “Startup Options” on page 22.
- 2 Specify when the program should **Save Dialog Size and Position: Always, Per**

**Session**, or **Never**. See “Dialog Size and Position” on page 32.

- Check **Open Dialogs to the Last Panel Visited** to open panelled dialogs to the last panel that you accessed during the current program session. When unchecked, dialogs always open to the first panel. See “Dialogs” on page 30.

## Folders Panel

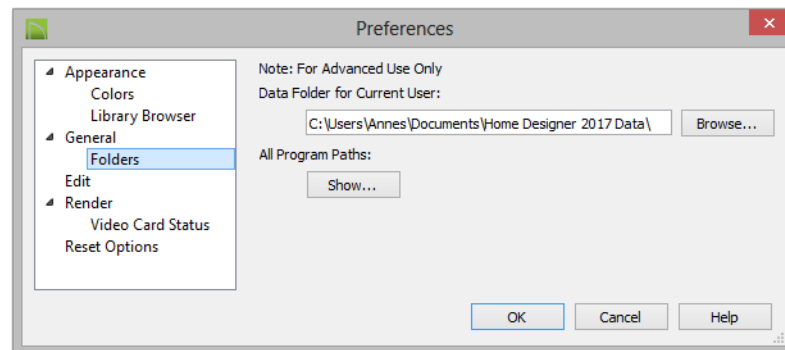

Important user-specific information is stored in the **Home Designer Architectural 2017 Data** folder, which is located in your Documents directory by default. See “Home Designer Architectural Data” on page 43.

While you cannot change the name of this directory, you can change its location. To avoid unexpected results, it is best to use a location on your local hard drive.

If you move this folder on your computer without specifying its location here, the program will automatically replace it using default information from the Home Designer

Architectural installation folder. The same result will occur if you specify a location on a network or removable device and this location becomes inaccessible. When this occurs, customized user settings will not be used and custom library content will not be available.

**All Program Paths** - Click the **Show** button to open the **Program Paths** dialog, where you can find the location of files that may be needed for troubleshooting purposes. See “Program Paths Dialog” on page 596.

## Edit Panel

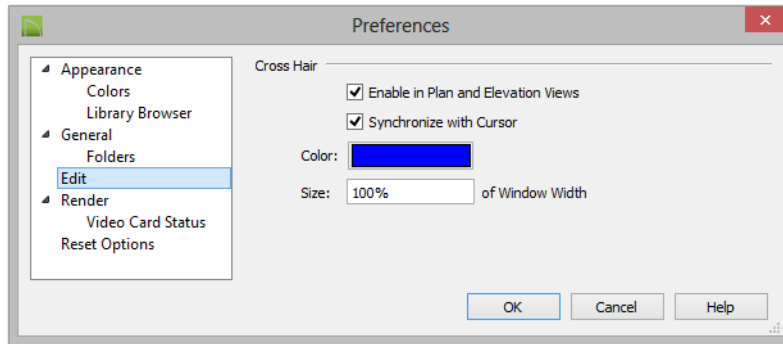

You can use a cursor with **Cross Hairs** and control its appearance.

- Check **Enable in Plan and Elevation Views** to use a cross hair cursor in floor plan and elevation views. This option is checked by default.
- When **Synchronize with Cursor** is checked, the mouse pointer and cross hairs always move together on screen. If you feel that they do not keep up with

your mouse movements, try unchecking this option.

- Click the **Color** bar to open the **Select Color** dialog and specify the color of the cross hairs.
- Cross hair **Size** is specified as a percentage of the view **Window Width**. Specify the **Size** as 100% to extend the cross hairs across the entire screen.

## Render Panel

The settings on the **RENDER** panel control how 3D views are generated.

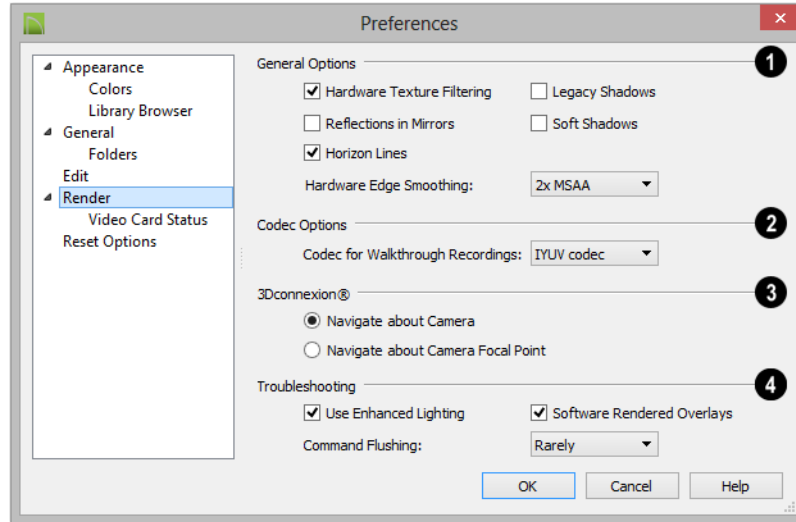

- 1** The **General Options** settings affect the quality and rendering time of both Render Previews and Final Views. See “Previews vs Final Views” on page 471.
- Check **Legacy Shadows** to generate shadows using the method used in version X5 and prior. Legacy shadows are significantly slower than standard shadows, but are often of higher quality with smoother edges. If your video card does not support standard shadows, Legacy Shadows will be used automatically.
  - **Soft Shadows** displays shadows with soft edges instead of hard edges in **Final Views with Shadows** .
  - **Hardware Texture Filtering** uses your video card to filter textures and improve their appearance: noticeably, on surfaces angled away from the camera. In some rare instances, this may slow rendering time somewhat. Not supported by some video cards.
  - **Reflections in Mirrors** allows flat surfaces using a Mirror material to display reflections of other objects in the scene. Reflections may slow program performance in 3D views, particularly when multiple mirrors are present. This is unchecked by default; however, reflections are used in Final Views. See “Reflections” on page 470.
  - **Horizon Lines** are lines that generate along the curved edges of symbol objects in Vector Views. Uncheck this box to increase the speed of Vector View generation but also suppress these lines. See “Vector View” on page 478.
  - **Hardware Edge Smoothing** uses the video card to remove the jagged edges that sometimes result along surface edges, producing cleaner lines. Select an MSAA (Multi Sample Anti-Aliasing) multiplier from the drop-down list: the higher the multiplier, the smoother the surface edges and longer the rendering time. The

options available in this list may be limited, depending on what your video card is able to support.

**2** Select a **Codec for Walkthrough Recordings** from the drop-down list. By default, “Cinepak codec” is selected in the 32-bit Windows version of the software, “IYUV codec” in the 64-bit Windows version, and “H.264” in the Mac version; but any other codecs that you may have installed on your system will also display in the list. See “Walkthroughs” on page 543.

**3** The **3Dconnexion®** settings affect how 3D mice function in Perspective 3D views. See “3Dconnexion® 3D Mice” on page 457.

- Select **Navigate about Camera** to center mouse movement about the location of the camera.
- Select **Navigate about Camera Focal Point** to center mouse movement about the location of the camera’s focal point. See “To create a camera view” on page 450.

**4** The **Troubleshooting** settings can be used to troubleshoot performance in 3D views.

- When **Use Enhanced Lighting** is checked, Standard rendered views generate lighting effects that require a video card that supports OpenGL 2.0. Unchecking this box may speed up Standard rendering times somewhat; however, the quality of lighting effects will be reduced. Not available if your video card does not support OpenGL 2.0. See “OpenGL and Hardware” on page 448.
- **Software Rendered Overlays** helps address specific errors that can occur with certain video cards and is checked by default. In some rare instances, this may slow rendering time somewhat. Note that it will become checked automatically if the program encounters certain error conditions.
- **Command Flushing** - Select an option from the drop-down list to control how often the program flushes cached video memory. “Rarely” is selected by default and will produce fastest rendering times on most systems, but “Frequently” may be helpful for older video cards.

## Video Card Status Panel

The VIDEO CARD STATUS panel displays information about your video card, including the vendor and the OpenGL version it uses. See “OpenGL and Hardware” on page 448.

This information may be important if you are having problems generating 3D views.

Notice the **Max Lights** value. This indicates how many lights can be rendered in a 3D view. This value should be 8 or higher, depending on your video card. See “Lighting” on page 472.

## Reset Options Panel

In order for some of the Reset Options to take effect, you will need to restart Home Designer Architectural.

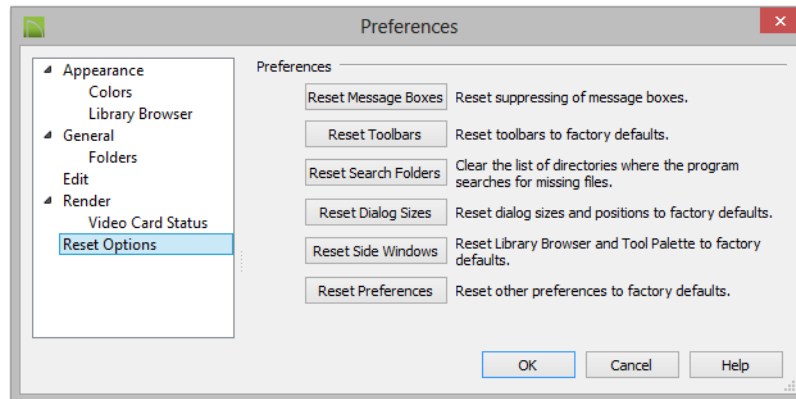

- If message boxes have been suppressed, you can make them display again by clicking **Reset Message Boxes**. See “Message Boxes” on page 33.
- Click the **Reset Toolbars** button to reset all toolbars to their original states. If you are encountering warning messages regarding toolbars, this option may resolve the issue. See “Toolbars and Hot-keys” on page 71.
- Home Designer Architectural retains a list of locations where you have located missing files in the past. If you find that the program takes a long time searching before informing you that files are missing, you can click the **Reset Search Folders** button to clear this list. See “Referenced Files” on page 52.
- Click the **Reset Dialog Sizes** button to restore all dialog boxes to their original sizes and positions. See “Dialogs” on page 30.
- Click the **Reset Side Windows** button to restore all side windows to their original sizes and positions. Tool Palette Settings  are also reset. See “Side Windows” on page 27.
- Click the **Reset Preferences** button to restore all preferences to those originally installed with the program.

---

## Angle Style Dialog

At the bottom of the **Terrain Specification** dialog, you can click the **Angle Style** button

to open the **Angle Style** dialog. See “Terrain Specification Dialog” on page 345.

The selection in this dialog is global, affecting all plans during the current program session, and controls the format of angles in dialog boxes as well as in the Status Bar. See “The Status Bar” on page 33.

Although this setting controls the format of values used in dialogs, it does not limit how you can enter these values. For example, if you set your Number Style to use Inches, values will display using fractional inches. You can, however, enter values using decimal inches, inches and feet, or even decimal feet. When the dialog you’re typing in updates, the value will be converted to fractional inches.

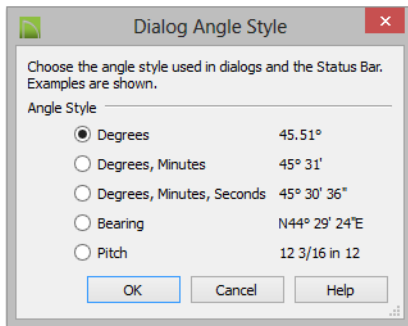

Angles can be displayed using one of five methods:

- **Degrees/Minutes/Seconds** - Measured counterclockwise from a line drawn horizontally to the right of the angle’s vertex. Useful for most drawing tasks. Select the level of accuracy that you require.
- **Bearings** - Measured from a vertical line representing North/ South, Quadrant Bearings use directional bearings in their measurements. Useful for site drawings.
- **Pitch** - Defined as a ratio of vertical rise to horizontal run. In Imperial units, the run is always 12”; in metric units it is 1000 mm.

# Toolbars and Hotkeys

Two of the most efficient ways to access Home Designer Architectural's tools are the toolbars and keyboard shortcuts, also referred to as hotkeys.

## Chapter Contents

- Toolbar Arrangement
- Hotkeys

---

## Toolbar Arrangement

Home Designer Architectural's toolbars provide fast access to the program's most commonly used tools and settings, and are organized so that related tools are grouped together and easy to find.



If a tool or setting is active, a small checkmark will display at the lower left corner of its button icon.

The toolbars that display in a given view depend on the view type. For example, the toolbars that are available in floor plan and 3D views are not available in Materials Lists.

Some toolbars are available in more than one type of view. If a tool cannot be used in that view, its icon will appear pale grey in color.

Many of Home Designer Architectural's tools are organized into families of related tools which can be accessed using either of two styles of toolbar interface: the **Child Tool Palette** or **Drop Down** tools. You can select the interface that you prefer in the **Preferences** dialog. See "Appearance Panel" on page 62.

## Drop-Down Tools

Click on the arrow to the right of a button to display a drop-down list of related tools. For

example, click the arrow to the right of the **Window**  button to display a drop-down list of the other Window Tools.

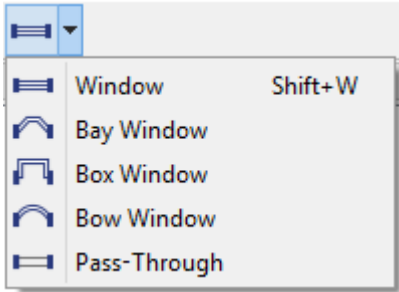

The most recently selected tool displays in the toolbar.

### Child Tool Palette

An alternative to Drop-Down toolbars is the Parent button and Child Tool Palette interface. Parent toolbar buttons have a blue triangle in the lower right corner. When you select a Parent button, its Child tools display in the Child Tool Palette. If the Child Tool Palette has been closed, it will open.

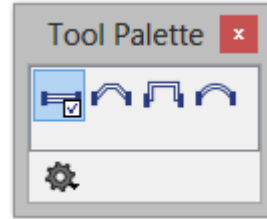

You can open the Tool Palette at any time, even when Drop Down tools are enabled, by selecting **View > Tool Palette**. See “View Tools” on page 442.

When you click the **Window Tools**  Parent button, for example, its Child buttons display in the Child Tool Palette.



By default, the Child Tool Palette is docked on the left side of the program window; but it can be undocked and moved, as well as resized and closed, just like other side windows. See “Side Windows” on page 27.

Click the **Settings**  button at the bottom of the palette to select how the tools within it are presented:

- Select **Fit Palette**  to resize the palette so that it is one row wide.
- Select **Grid View**  to display only the button icons of the child tools in a grid that may have multiple rows, depending on the width of the palette side window.
- Select **List View**  to display child tools in a vertical list with each tool’s button icon and name in a row.

As long as it is open, the Child Tool Palette will also display the members of a selected tool’s family when the Drop Down interface is active. If you select a tool that does not belong to a family, the previously selected tool’s family will continue to display in the Tool Palette.

### The Edit Toolbar

When you select an object, its edit toolbar opens. By default, it is located at the bottom of the program window, just above the Status



Bar. The buttons on the edit toolbar can be used to edit the selected object. Which buttons display depends on the type of object selected, the current view, and how you selected the object.



## Moving Toolbars

You can move any toolbar to a different location by clicking and dragging its dotted grab bar. Toolbars can be docked to any side

of the program window, or they can be undocked and left floating.

Undocked toolbars can be moved outside of the program window, and they can be closed completely. They can also be reshaped; however, they cannot be resized in such a manner that any buttons become hidden.

The location of moved toolbars is not saved between program sessions. The next time you use Home Designer Architectural, the toolbars will be back in their original locations.

## Hotkeys

Many Home Designer Architectural tools have a keyboard shortcut, or hotkey, associated with them. If such a hotkey exists, it will display to the right of the tool's name in the menu.

Edit	Build	Terrain	Library	3D	CAD
↶	Undo			Ctrl+Z	
↷	Redo			Ctrl+Y	

*Edit menu items with button icons to the left and hotkeys to the right*

To use a hotkey, simply press the appropriate key or combination of keys on your keyboard instead of selecting the menu item or clicking the toolbar button. For example, press the Ctrl and Z keys at the same time to perform an **Undo** .

Note: If a key or key combination is in use as a system hotkey, it cannot be used as a program hotkey.

## Create Hotkey List

A list of the hotkeys available to the current program user can be saved in **.html** or **.xhtml** format.

Select **Tools> Create Hotkey List** to open the **Save Hotkey List File** dialog, a standard Save dialog, and create a hotkey list that can then be opened in a web browser window and printed, if you wish.



# Layers

Layers are used to organize and manage the display of all objects in all views. A layer can be thought of as a transparency sheet with objects placed on it for viewing. Nearly all views use multiple layers, like a stack of transparencies put together to show different types of objects.

You can find out which layer an object is on by selecting the object and looking at the Status Bar. You can customize how each layer displays in a particular view in the **Display Options** dialog.

Multiple layers are organized into Layer Sets, which allow you to control which objects display in different views.

## Chapter Contents

- Displaying Objects
- Layer Sets
- Display Options Dialog

## Displaying Objects

The display of objects in different views is controlled by layer sets and layers in the **Display Options** dialog. See “Display Options Dialog” on page 77.

### Primary and Secondary Layers

Every object is placed on a layer which controls whether it displays in a given view. This layer is referred to as the object’s primary layer, and you can see its name in the Status Bar when the object is selected. See “The Status Bar” on page 33.

In addition, some objects have secondary layers which may alter the appearance of objects on the primary layer, but do not control whether the objects display or not.

For example, the primary layer for base cabinets is “Cabinets, Base”. In addition, base cabinets have a number of secondary layers that control the display of the countertop, face indicators, door opening indicators, module lines and labels.

Note: If an object’s primary layer is turned off, information on its secondary layers will not display - even if those layers are turned on.

All layers with a check in the “Disp.” column display when the current layer set is active. Objects that are not displayed cannot be seen or selected. If you try to place or draw an object on a layer that is hidden, the program asks if you want to turn the layer on.

Name	Disp
Architectural Blocks	✓
Architectural Blocks, Labels	
Audio/Video	✓
Auto Dormers	✓
Cabinets, Base	✓

Some objects cannot stand alone in a drawing: they can only be inserted into another object. If the display of an object that contains an inserted object is turned off, the display of the inserted object will be turned off, as well. For example, if the display of a wall is turned off, any doors and windows in that wall will not display either. See “Inserted Objects” on page 407.

The **Color** attribute assigned to a layer determines how the lines representing objects on that layer appear in floor plan and Elevation views.

Many objects, including CAD and text objects, allow you to override the line color without changing the layer’s color attribute.

## Layer Sets

**Layer Sets** are used to control the layer settings for different views in a plan file.

A layer set consists of a complete list of the layers in the current plan along with the

display settings for each layer as set for a particular type of view. These display settings can be modified, and can be different for each type of view. See “Display Options Dialog” on page 77.

Layer sets are file specific, which means that changes made in one plan file have no effect on the settings in other files.

Home Designer Architectural uses a different layer set for the each type of view of your plan:

- Floor plan view.
- Camera views and Overviews. See “3D View Tools” on page 450.
- Elevation views. See “Elevation Views” on page 452.
- Framing Overviews. See “Framing Overview” on page 452.
- Reference Floor. See “The Reference Floor” on page 225.

- Print Model. See “Print Model” on page 571.

While any view is active, select **Tools>**

**Display Options**  to make changes to the layer set used for that view type.

Any changes made to settings in the **Display Options** dialog for one particular view will affect all views using that same layer set. For example, if you make changes for a camera view, all camera views and overviews in the current plan will be affected. See “Display Options Dialog” on page 77.

Unlike other layer sets, the Print Model layer set cannot be modified.

## Display Options Dialog



The display of objects in all views is controlled in the **Display Options** dialog. To make changes to the display settings for a particular type of view, open a view of that type and select **Tools> Display Options**.

If the display of a particular layer is turned off and an object assigned to that layer is placed in the plan, the program will automatically ask you if the layer should be turned on so that the new object will be visible. After you make your choice, the object will be created - even if you select “No.”

Only displayed objects are included when DXF and EMF files are exported, and only displayed objects print.

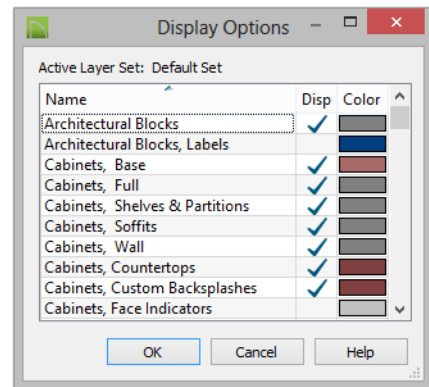

The **Properties** for the layer set that is active in the current view are presented in a table of layers and their attributes. See “Layer Sets” on page 76.

- Click on a column header to sort all layers by that column. Click again to sort in reverse order.

- Remove the check from the “Disp.” column to turn off the display of a category of objects.
- Click a color bar to open the **Select Color** dialog and set the display color for objects on that layer in floor plan and Elevation views. See “Select Color Dialog” on page 438.
- Click the size grip at the lower right corner and drag to resize the dialog box.

Note: Not all objects display in all views. For instance, invisible walls do not appear in camera views or materials lists.

# Creating Objects

There are a wide variety of objects in Home Designer Architectural that you can use to create 3D models and plan drawings. Although these objects are sometimes very different from one another, the methods used to create them are similar.

Once an object is created, it can be selected and edited to meet the requirements of your project. The editing characteristics common to most objects are described elsewhere. See “Editing Objects” on page 87.

## Chapter Contents

- Architectural vs CAD Objects
- Snap Behaviors
- Object Snaps
- Angle Snaps
- Grid Snaps
- Creating Objects
- Copying and Pasting Objects

---

## Architectural vs CAD Objects

There are two broad categories of objects in Home Designer Architectural: architectural objects and CAD objects.

CAD objects such as lines, arcs, text, and dimensions are 2D objects that can be created and edited in floor plan view and Elevation views but do not display in 3D camera views and overviews. See “The CAD Drawing Tools” on page 511.



In contrast, architectural objects such as walls, cabinets, doors, windows, and stairs display in 2D and 3D views.

Some architectural objects, such as custom countertops and slabs, have some behaviors in common with CAD objects and are referred to as CAD-based.

---

## Snap Behaviors

There are three categories of snap behavior in Home Designer Architectural that affect how objects are created and how they can be edited:

- **Object Snaps** , which snap CAD and architectural objects to other objects.
- **Angle Snaps** , which snap objects at specific angles.

- **Grid Snaps** , which snap objects to points on a grid.

You can select **Edit> Snap Settings** to quickly turn Object, Angle and Grid Snaps on or off.

To temporarily disable Snap Behaviors and other move restrictions, press the Ctrl key while dragging an edit handle. See “Moving Objects” on page 109.

---

## Object Snaps



**Object Snaps** allow you to position objects precisely relative to each other; for example, to position lines so that their endpoints meet.

Object Snaps can be turned on or off by selecting **Edit> Snap Settings> Object Snaps**.

There are many locations on an object that other objects can snap to.

- Object endpoints and corners

- The midpoints of object edges
- Object center points
- Intersection points where an object drawn at an allowed angle meets another object.

In addition, **On Object** snapping occurs anywhere on an object’s edges and is most noticeable when Angle and Grid Snaps are turned off.

When multiple objects are selected, the selection set’s only snap point is its midpoint.



## Extension Snaps

Extension snaps allow you to snap to a point that is not actually on an object. Instead, these snaps locate points that are either colinear to the end of a wall or orthogonal (at a 90° angle) to it.

Extension snaps function when you are drawing or editing walls and create a “sticky point” where the wall being drawn reaches a point that is either colinear or orthogonal to another wall’s end point. See “Drawing Walls” on page 130.



---

## Angle Snaps



It is often important that objects be drawn at exact angles. This can be accomplished using **Angle Snaps**. Angle Snaps allow you to draw walls, lines, and other objects at angles in 7.5° increments. Angle Snaps also affect the way objects rotate, the radius of arcs, and a variety of other operations.

Angle Snaps can be turned on or off by selecting **Edit> Snap Settings> Angle**

**Snaps** . When Angle Snaps are disabled, the Angle Snaps  icon will display near the mouse pointer.

---

## Grid Snaps



**Grid Snaps** allow you to snap objects to points on an on-screen grid. This grid cannot be seen directly, but as you draw, move or resize an object, you can sometimes see it snapping at regular increments. See “Moving Objects” on page 109 and “Resizing Objects” on page 112.

The size of this Snap Grid can be controlled in the **Plan Defaults** dialog. See “General Plan Defaults Dialog” on page 60.

It is recommended that you draw and position the exterior walls of your plan with

**Grid Snaps**  enabled. Once these walls are in place, you may choose to turn Grid Snaps off to finish the rest of the drawing.

Grid Snaps are turned on and off by selecting **Edit> Snap Settings>Grid Snaps**  or in the **Plan Defaults** dialog.

In addition to the Snap Grid, the **Reference Grid** is provided to give you a visual sense of scale. The Reference Grid is composed of 12” x 12” squares and is useful for zooming in and out, or for general layout guidelines, but is not used for snapping. The Reference Grid can be toggled on and off by selecting **View> Reference Grid**. See “View Tools” on page 442.

### Grid Snaps and Angle Snaps

Of the three snap behaviors, Grid Snaps have the lowest priority and are overridden by Angle Snaps and Object Snaps.

When Grid snaps and Angle Snaps are both enabled, objects are drawn and edited using Polar Coordinates. For example, if the grid **Snap Unit** is set to 12" (1 foot), drawing a new wall at an Allowed Angle snaps the wall length to 0", 12", 24", and so on.



To draw a line or wall at an Allowed Angle but with unrestricted length, disable Grid Snaps and leave Angle Snaps on.

---

## Creating Objects

In Home Designer Architectural, there are three ways to create objects: by clicking to place an object, by clicking and dragging to draw an object, or by importing custom symbols, pictures or metafiles.

If you create an object using any of these methods and the layer it will go on is turned off, the program will ask you if you want to display the layer. See “Object Creation and Layers” on page 83.

While the size of the drawing area in Home Designer Architectural is limited only by the resources on your computer, it is best to begin your drawing near the origin, 0,0,0. The current position of your mouse pointer displays in the Status Bar at the bottom of the program window. See “3D Drafting” on page 23.

### Click-to-Create

Many objects, including doors and windows, cabinets, library symbols, text, pictures, and images are created by clicking. Select a library object or one of the drawing tools mentioned above, then click in the drawing area to place the object at that location.

Continue clicking to place the selected object until another tool is selected.

If you click at a location where there is not enough room for the object to be placed, one of two things may happen:

- Some objects, notably cabinets, doors, and windows, will resize smaller to fit into the space.
- Most objects cannot resize in this manner, so the program will present a warning message indicating that there is not sufficient space at the current location.

When most drawing tools are active or library symbols selected for placement, a preview outline follows your mouse pointer, indicating the size and shape of the object to be created. If your pointer is positioned at a location where the object cannot be placed, this preview outline will not display.

As you move the mouse pointer, the center point of the object’s back edge will snap to active snap points when **Grid Snaps**  or **Object Snaps** are enabled. See “Snap Behaviors” on page 80.

Many architectural objects can be created in floor plan view or any 3D view. In order to place a stand-alone, click-to-create object in 3D, it is necessary to click near a wall or within the Terrain Perimeter as these objects help orient the new object within the 3D space.

## Clicking and Dragging

Other objects, including walls and railings, straight stairs, and CAD and CAD-based objects are created by clicking and dragging to define either a path or an enclosed area. Select a tool, then click and drag in the drawing area to draw an object between your start and end points.

Continue drawing the selected object until another tool is selected.

You can temporarily slow the movement of the mouse as you drag by holding down the Shift key on your keyboard..

You can cancel any click-and-drag drawing operation before it is completed by pressing the Esc key on your keyboard, or by pressing any two mouse buttons at the same time.

## Importing Objects

Custom symbols, pictures and metafiles can be imported into the program and placed in

the drawing area with a click. See “Importing and Exporting” on page 551 and “Pictures, Images, and Walkthroughs” on page 529.

## Object Creation and Layers

When it is created, every object is placed on a layer which controls whether and how it displays. See “Layers” on page 75.

If you try to create an object on a layer that is not set to display in the current view, the program will ask if you want to turn that layer on. See “Message Boxes” on page 33.

- Click **Yes** to create the object and turn on its layer in the current view.
- Click **No** to create the object but leave its layer turned off in the current view.
- Click **Cancel** to not create the object and leave the layer turned off.

---

## Copying and Pasting Objects

New objects can also be created by cutting, copying, and pasting existing objects, either individually or in groups. Objects can be copied from one floor to another, one view window to another, and one file to another. Because copying uses your system’s clipboard, some objects can be pasted into other applications, as well.



Objects created in an Imperial plan should not be pasted into a metric file, or vice versa. See “Template Plans” on page 44.

Objects cannot be pasted into any views that they cannot be created in normally. For example, CAD objects cannot be pasted into a 3D camera view or overview.

A few objects, such as Terrain Perimeters and camera symbols, cannot be copied.

## Cut



Select **Edit > Cut** or press **Ctrl + X** to remove the selected object(s) from the file and save them in the system clipboard. To paste the selection in Home Designer Architectural or another application, select

**Edit> Paste** or press **Ctrl + V** while in that application to enable the Paste function.

## Copy



Select **Edit> Copy** or press **Ctrl + C** to copy the selected object(s) to the system clipboard. To paste the selection in Home Designer Architectural or another application, select **Edit> Paste** or press **Ctrl + V** while in that application to enable the Paste function.

## Paste



Select **Edit> Paste** or press **Ctrl + V** to enable Paste mode, then left- or right-click in the current view to paste the selected object(s) previously copied to the system clipboard at that location. If pasting from another application, click in the destination view in Home Designer Architectural first to make sure it is active.

Once pasted, these object(s) are selected. Objects pasted in 3D views are selected on their top surfaces.

If the selection being pasted consists of text, it is placed in a Text object.



## Copy/Paste



Click the **Copy/Paste** edit button to copy the selected object(s) to the system clipboard and immediately enable the **Paste**  function in Home Designer Architectural.

The **Copy/Paste**  edit button activates Paste mode in which each available edit tool and handle makes a copy in addition to its



primary function and two new edit buttons display on the edit toolbar.

- Click the **Sticky Mode**  edit button remain in the current mode and place multiple copies of the selected object(s).
- Click the **Main Edit Mode**  edit button or press the Esc key to return to the selected objects's main edit toolbar.

If you paste a selection in a file other than its original source file, when you return to the original, Paste mode is still enabled.



The **Copy/Paste**  edit button can be used with the edit handles in either of two ways: by clicking or by dragging an edit handle.

### To Copy/Paste by clicking

1. Select an object or objects to copy.
2. Click the **Copy/Paste**  edit button, select **Edit> Copy**  from the menu or press **Ctrl + C** to copy and then **Ctrl + V** to activate the Paste functionality. The cursor displays the Copy/Paste icon.
3. If you wish to paste the copy in a different view or program window, open that window.
4. If your cursor does not display the Copy/Paste icon, select **Edit> Paste** from the menu or press **Ctrl + V**.
5. Left- or right-click once to paste a copy of the object at that location.



### To Copy/Paste by dragging

1. Select an object or objects to copy.

- Click the **Copy/Paste**  edit button, select **Edit > Copy**  from the menu or press **Ctrl + C**. The cursor displays the Copy/Paste icon.
- Drag an edit handle:
  - Drag the Move edit handle to position the copy at a new location.
- You can position the copy accurately with respect to the original by watching the moved distance in the Status Bar at the bottom of the screen.

## Sticky Mode

 Normally, after an action is performed using the edit tools or handles while in an edit mode such as Paste mode, you return to the Main Edit Mode. Click the **Sticky Mode** edit button to remain in Paste mode and continue pasting copies of the selected object(s).

To exit Paste mode and return to the main edit toolbar for the selected object, click the **Main Edit Mode**  edit button or press the Esc key on your keyboard. If you have not pasted a copy of the selected object and immediately click **Copy/Paste**  after returning to the Main Edit Mode, **Sticky Mode**  is still enabled.

## Copy and Paste in Place



 Click the **Copy and Paste in Place** edit button to create a copy of the selected object(s) at the same location as the original. The copy remains selected so you can perform additional operations.

Because multiple walls, railing and fencing cannot share the same space, the **Copy and Paste in Place**  edit button is not available for these objects.

## Paste Hold Position

 When copying between different floors or view windows, you can paste a copy at the same absolute position as the original selection using **Paste Hold Position**.

### To use Paste Hold Position

- Select the object(s) to be copied.
- Click the **Copy/Paste**  edit button.
- Switch to the desired floor or plan file and select **Edit > Paste > Paste Hold Position** .
- A copy is placed at the same X, Y coordinates on the new floor or in the new plan as the original's position.

## Paste Special

 The **Paste Special** tool allows you to choose a representation for the selection to be pasted.

Selections can be pasted as:

- Enhanced Windows Metafiles (EMF). See “Metafiles” on page 537.
- Device Independent Bitmaps (BMP). See “Importing Pictures” on page 536.
- Unformatted non-unicode text (TXT).
- File Name (a path to a file). Depending on the file type, it will be either opened or imported (if supported).
- Unformatted text (HTML). Pastes as text.

- Model Objects - Home Designer Architectural format, not compatible with other programs.

***To use Paste Special***

1. Select an object, image, text or file on your computer and copy it.
2. Switch to the desired Home Designer Architectural view window and select **Edit> Paste> Paste Special** .

3. In the **Paste Special** dialog, select the desired representation for the selection and click OK.
4. Click in the drawing area to place the copy at that location.

**Copy Region as Picture**



The **Copy Region as Picture** tool allows you to copy any portion of the screen and save it as a picture. See “Copy Region as Picture” on page 541.

# Editing Objects

Just as the methods used to create different objects in Home Designer Architectural are similar, the options for moving, rotating, resizing, and otherwise editing them are also alike.

Edit handles allow objects to be resized, relocated, or rotated using the mouse. Edit toolbar buttons and the contextual menus access edit tools relevant to the selected object(s). Most objects have a specification dialog that allows you to edit it in ways that are specific to that type of object.

The editing characteristics common to most objects are described in this chapter. Unique, object-specific editing behaviors and the specification dialogs are covered in their respective chapters.

## Chapter Contents

- Selecting Objects
- Editing Line Based Objects
- Editing Arc Based Objects
- Editing Open Polyline Based Objects
- Editing Closed-Polyline Based Objects
- Editing Box-Based Objects
- Editing Spline Based Objects
- Editing Circles, Ovals and Ellipses
- Displaying Objects
- Moving Objects
- Aligning Objects
- Resizing Objects
- Reshaping Objects
- Rotating Objects
- Matching Properties
- Deleting Objects
- Undo and Redo

## Selecting Objects

“Select” refers to selecting an object for editing. An object must be selected before it can be edited.

In order for an object to be selected, it must be visible in the current view. See “Layers” on page 75.

When an object is selected, it displays edit handles and a grey selection fill color. In 3D views, a selected object will also display lines representing the selected edge or surface. The size of the edit handles does not change as you zoom in or out. To prevent them from stacking on one another, some edit handles may not display as you zoom away from the selected object.

When an object is selected, its edit toolbar also displays, typically on the upper left side of the Home Designer Architectural program window. See “The Edit Toolbar” on page 28.

Information about the selected object or objects may also display in the Status Bar. See “The Status Bar” on page 33.

A selected object remains selected until another object is selected, a different tool is activated, the Esc key on the keyboard is pressed, or any two mouse buttons are pressed at the same time.



### Select Objects



Any object created using Home Designer Architectural can be selected using the **Select Objects** tool. Select **Edit > Select Objects**, click the toolbar button or press the **Space** bar on your keyboard to activate this tool, then click on an object to select it.

You can also select objects or open context sensitive menus using the right mouse button when any tool is active.

### Selecting Similar Objects

If a tool other than **Select Objects**  is active, you can only select objects of that type using the left mouse button. For example, if the **Straight Exterior Wall**  tool is active, you can only select walls using the left mouse button.

This can be useful for selecting an object when many objects of a different type occupy the same space in floor plan view.

Objects can be selected using the right mouse button, regardless of which tool is active.

### Right-Clicking

Regardless of which tool is active, you can select an eligible object by right-clicking on it once. When you right-click to select an object a contextual menu also appears, displaying the object’s edit tools. See “Contextual Menus” on page 29.

If a drawing tool is active and you right-click to select an object, you can unselect it by left-clicking in an empty space in the drawing area. Although a drawing tool is active, it is not used. If you then left-click a second time, the active tool will be used.

### Selected Edge

When you click on a polyline- or box-based object, the edge that you click nearest becomes the selected edge and displays an



edit handle larger than those on other edges. The handle on this edge may also display at the point where you clicked to select it.

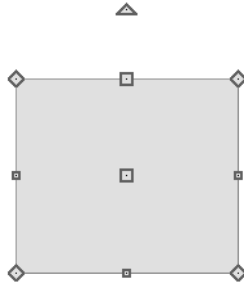

This edge can be edited on the **SELECTED LINE** or **SELECTED ARC** panel of the object's specification dialog, as well as using a variety of edit toolbar buttons. It can also be moved using dimensions. See "Moving Objects Using Dimensions" on page 494, "Line Panel" on page 513 and "Arc Panel" on page 516.

## Select Next Object



If there is more than one object in a particular space, it may be difficult to select the desired object. When a nearby object is selected, click the **Select Next Object** edit button or press the Tab key until the desired object becomes selected. This function cannot be applied to groups of selected objects.

## Marquee Select

Groups of objects can be selected by holding down either the Shift or Ctrl key when the **Select Objects**  tool is active and then dragging a marquee around the objects to be selected. An object does not need to be completely enclosed by the marquee to be

selected: it will be selected if the marquee includes only a small portion of it.

If an object is currently selected and a selection marquee is drawn around it, that object becomes de-selected. If an object is currently selected and a marquee is drawn around other objects, the original object remains selected and the other objects are added to the selection set.

When using the marquee-select method, both CAD and architectural objects included in the marquee are selected. To remove an object from the selection set, hold down the Shift key and click it.

The Shift key can also be used to marquee-select objects of a similar type. For example, click the **Hinged Door**  child button, hold down the Shift key, drag a marquee, release the mouse button, and only door objects within the marquee are selected. The Ctrl key will always marquee-select objects of all types, regardless of the active tool.



To make marquee selection easier, you can turn off the display of objects you do not want to include in your selection set. See "Displaying Objects" on page 76.

## Shift and Ctrl Select

You can select a group of objects by adding them to the selection set one by one. Select an object, hold down either the Shift or Ctrl key, and click additional objects to select them.

More than one type of object can be selected using this method, but the ability to edit the group-selected items is limited to attributes that all selected objects have in common.

To remove an object from a selection set, click it once more - again, with either the Shift or Ctrl key pressed.

The Shift and Ctrl keys can be used to select multiple items in a variety of contexts, such as: the Library and Project Browsers, lists in dialog boxes, and files to be imported.

### Edit Area



The **Edit Area** tool allows you to quickly define an area of your plan and select the objects in that area. Once

selected, they can then be repositioned, rotated, or deleted. Select **Edit> Edit Area**, then click and drag a rectangular marquee around the area that you would like to move.

Unlike other selection methods, the **Edit Area** tool cuts walls, railings and fencing where the selection marquee intersects them, allowing you to edit only the selected portion of these objects.

Some objects, such as cabinets, are included in the selection only if more than half of the object is contained within the marquee.

## Editing Line Based Objects

Objects are considered line-based when they can be edited similar to CAD lines using their edit handles.

CAD lines, straight walls and railings, straight stairs and straight roads are examples of line-based objects.

Most line-based objects can be connected to other like objects to form polylines or polyline-based objects. See “Editing Open Polyline Based Objects” on page 95 and “Editing Closed-Polyline Based Objects” on page 98.

Some objects, notably walls, have line-based editing behavior only when selected on certain surfaces. See “Editing Walls” on page 135.

Wall openings such as doors and windows have line-based editing behavior in floor plan view only but cannot be rotated, reversed or converted to an arc. See “Editing Doors” on page 183 and “Editing Windows” on page 203.

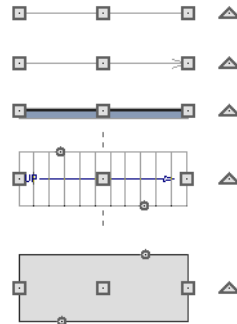

Other objects, such as stairs and roads, have additional edit handles that allow you to concentrically adjust the object’s width.

### Using the Edit Handles

When selected, a typical line-based object displays four edit handles: a Move handle, two Extend/Change Angle handles, and a Rotate handle.

Any action performed using the edit handles can be cancelled by pressing the Esc key or any two mouse buttons at the same time.

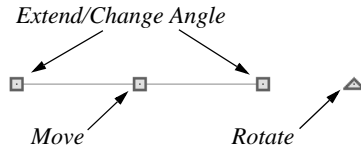

### Move

- Movement may be limited or stopped by other objects or Snap Behaviors. Move restrictions can be overridden by holding down the Ctrl key while dragging. See “Unrestricted Movement” on page 109.

### Rotate

- The **Rotate** handle is used to rotate the object about its center. See “Rotating Objects” on page 114.

### Extend/Change Angle

- Drag a square end handle parallel to the selected line to change its length.
- Drag a square end handle at an angle to the selected line to change its angle.

When **Angle Snaps**  are on, the line snaps to Allowed Angles. See “Angle Snaps” on page 81.

### Adjust Width

Some line-based objects, such as stairs and roads, have additional handles that allow the width of the object to be adjusted.

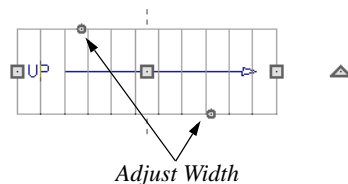

- Click and drag a small, round **Expand** handle to increase or decrease the object’s width. By default, objects are resized in 1" increments. This Snap Unit is defined in the **Plan Defaults** dialog. See “General Plan Defaults Dialog” on page 60.

## Using Dimensions



Dimensions can be used to position line-based objects relative to other objects. See “Moving Objects Using Dimensions” on page 494.

Dimensions cannot, however, be used to adjust the length of line-based objects, or the width of line-based objects such as stairs.

## Using the Specification Dialog













Line-based objects can be edited using their specification dialogs. See “Line Specification Dialog” on page 513.

## Using the Edit Toolbar

A selected line-based object can be edited in a variety of ways using the buttons on the edit toolbar.

The following toolbar buttons may display on the edit toolbar for a selected line-based object:

- Click the **Select Next Object**  edit button to select nearby objects instead of the selected object. See “Selecting Objects” on page 88.
- Click the **Open Object**  edit button to open the specification dialog for the

- selected object. See “Specification Dialogs” on page 32.
- Click the **Copy/Paste**  edit button to copy the selected object(s) to the system clipboard so they can be pasted elsewhere. See “Copying and Pasting Objects” on page 83.
  - Click the **Copy and Paste in Place**  edit button to create a copy of the selected object(s) at the same location as the original. See “Copy and Paste in Place” on page 85.
  - Click the **Delete**  edit button to delete the selected object(s). See “Deleting Objects” on page 116.
  - Click the **Make Parallel/Perpendicular**  edit button to make the selected object(s) parallel or perpendicular to a straight edge. See “Using Make Parallel/Perpendicular” on page 111.
  - Click the **Center Object**  edit button to center an object along along a wall within a room or relative to a cabinet fixture. See “Using Center Object” on page 111.
  - Click the **Move to Front of Group**  edit button to display the selected object in front of other objects in the same drawing group. See “Move to Front of Group” on page 108.
  - Click the **Break Line**  edit button to add a new corner or pivot point to the selected object. See “Break Line” on page 113.
  - Click the **Complete Break**  edit button to break the selected object into two separate objects. See “Break Line” on page 113.
  - Click the **Change Line/Arc**  edit button to change a line-based object to an arc, or vice versa. See “Change Line/Arc” on page 114.

---

## Editing Arc Based Objects

Objects are considered arc-based when they can be edited similar to CAD arcs using their edit handles.

CAD arcs, curved walls and railings, curved stairs, and curved roads are examples of arc-based objects.

Most arc-based objects can be connected to other like objects to form polylines or polyline-based objects. See “Editing Open Polyline Based Objects” on page 95 and “Editing Closed-Polyline Based Objects” on page 98.

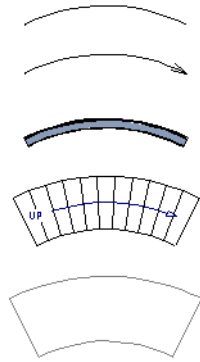

Some objects, notably curved walls, have arc-based editing behavior only when selected on certain surfaces. See “Editing Walls” on page 135.

Other objects, such as curved stairs and roads, have additional edit handles that allow you to concentrically adjust the object’s width.

### Using the Edit Handles

When selected, a typical arc-based object displays seven edit handles.

Any action performed using the edit handles can be cancelled by pressing the Esc key or any two mouse buttons at the same time.

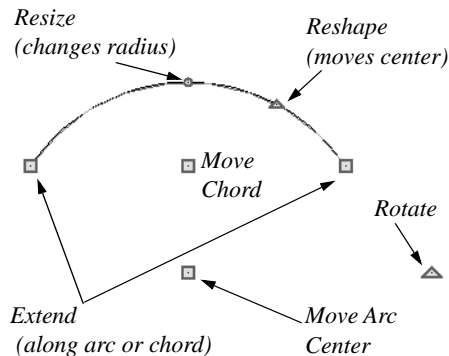

### Move

- Two Move edit handles allow the arc to be relocated without changing its shape. One is located at the center of the chord and the other, at the arc center.
- Movement may be limited or stopped by other objects or Snap Behaviors. Move restrictions can be overridden by holding down the Ctrl key while dragging. See “Unrestricted Movement” on page 109.

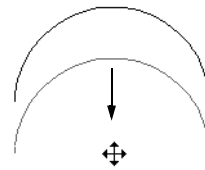

*Move edit handle*

### Rotate

- The **Rotate** handle is used to rotate the arc about its center. See “Rotating Objects” on page 114.

### Extend

- The end edit handles expand or contract the arc when moved along the arc radius or chord.
- If you follow the path of the arc, the end edit handles allow you to adjust the arc length.
- The angle formed by the center point of the arc and its two endpoints is referred to as the Included Angle. If **Angle**

**Snaps**  are on, the Included Angle of the arc can be rotated at Allowed Angles. See “Angle Snaps” on page 81.

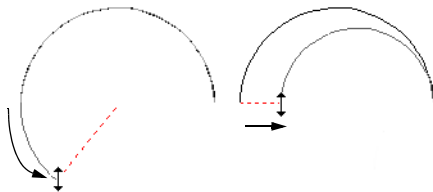

*Extend edit handles*

### Resize

- Drag the small, round **Resize** edit handle to change the radius and included angle of the arc while maintaining its center.

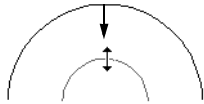

*Resize edit handle*

### Reshape

- Drag the small triangular **Reshape** handle to change the length and location of the center without moving the endpoints.

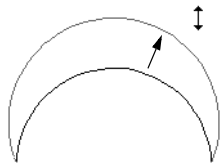

*Reshape edit handle*

### Adjust Width

Some arc-based objects, such as stairs, have additional handles that allow the width of the object to be adjusted.

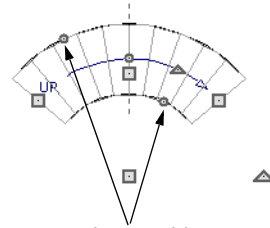

*Adjust Width*

- Click and drag a small, round edit handle to increase or decrease the object’s width. By default, objects are resized according to the Snap Unit defined in the **Plan Defaults** dialog. See “General Plan Defaults Dialog” on page 60.

### Using Dimensions



Dimensions can be used to position arc-based objects. Dimension lines typically locate tangent extension lines and any extension lines that may be parallel to those lines rather than the arc itself. See “Moving Objects Using Dimensions” on page 494.

### Using the Specification Dialog













Arc-based objects can be edited using their specification dialogs. See “Arc Specification Dialog” on page 515.

### Using the Edit Toolbar

A selected arc-based object can be edited in a variety of ways using the buttons on the edit toolbar.

The following toolbar buttons may display on the edit toolbar for a selected arc-based object:

- Click the **Select Next Object**  edit button to select nearby objects instead of the selected object. See “Selecting Objects” on page 88.
- Click the **Open Object**  edit button to open the specification dialog for the selected object. See “Specification Dialogs” on page 32.
- Click the **Copy/Paste**  edit button to copy the selected object(s) to the system clipboard so they can be pasted elsewhere. See “Copying and Pasting Objects” on page 83.
- Click the **Copy and Paste in Place**  edit button to create a copy of the selected object(s) at the same location as the original. See “Copy and Paste in Place” on page 85.
- Click the **Delete**  edit button to delete the selected object(s). See “Deleting Objects” on page 116.
- Click the **Center Object**  edit button to center an object along along a wall within a room or relative to a cabinet fixture. See “Using Center Object” on page 111.
- Click the **Move to Front of Group**  edit button to display the selected object in front of other objects in the same drawing group. See “Move to Front of Group” on page 108.
- Click the **Break Line**  edit button to add a new corner or pivot point to the selected object. See “Break Line” on page 113.
- Click the **Complete Break**  edit button to break the selected object into two separate objects. See “Break Line” on page 113.
- Click the **Change Line/Arc**  edit button to change an arc-based object to a line, or vice versa. See “Change Line/ Arc” on page 114.

---

## Editing Open Polyline Based Objects

Open polyline-based objects are composed of individual line- and arc-based objects that are connected at their end points but do not form an enclosed area. See “Polylines” on page 518.

Objects are considered open polyline-based when they can be edited similar to open CAD polylines using their edit handles.

Open CAD polylines, connected walls, stairs, and roads are examples of open polyline-based objects.

For information about editing closed polyline-based objects, see “Editing Closed-Polyline Based Objects” on page 98.

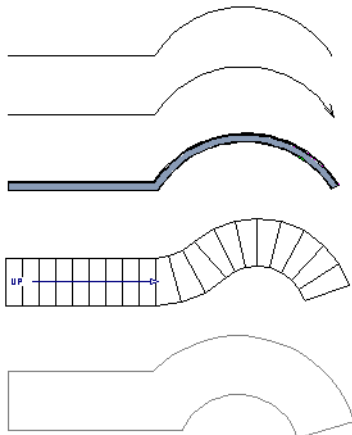

Other objects, such as connected stair and road segments, have additional edit handles that allow you to concentrically adjust the width of all segments of the object.

## Using the Edit Handles

A polyline can be composed of many segments. See “Polylines” on page 518.

When selected, an open polyline-based object displays a Move handle, a Rotate handle, a Reshape handle at the intersection of each segment, and an Extend handle at each end.

Each straight, line-based segment also has a Move edit handle along its length.

Each curved, arc-based segment has its own Move handle at the center of its chord, a Resize handle and, if it has an unlocked center, a Reshape handle. See “Editing Arc Based Objects” on page 92.

When a polyline is selected, the edge that you click nearest is called the selected edge, and certain operations affect only this edge.

The Move handle of the selected edge is larger than that of other edges. It displays along the length of a line segment, or at the center of the chord on an arc segment. See “Selected Edge” on page 88.

Any action performed using the edit handles can be cancelled by pressing the Esc key or any two mouse buttons at the same time.

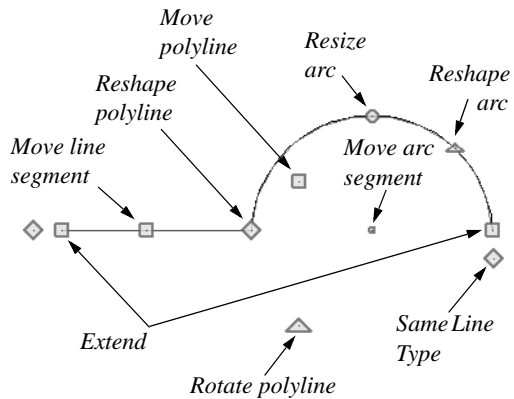

### Move

- Click and drag the Move handle to move the object.
- Movement may be limited or stopped by other objects or Snap Behaviors. Move restrictions can be overridden by holding down the Ctrl key while dragging. See “Unrestricted Movement” on page 109.

### Rotate

- The **Rotate** handle is used to rotate the object about its center. Its position varies depending on which edge is currently selected. See “Rotating Objects” on page 114.

### Extend

- Click and drag an Extend handle to lengthen or shorten the unconnected end



of the selected line or arc segment, or to change the radius of the selected arc. See “Editing Arc Based Objects” on page 92.

### Reshape

- Click and drag a Reshape edit handle to change the angle and/or length of the segments on either side of it, or the size of the object.

### Move Line Segment

- The **Move Line Segment** edit handle is found on straight segments of open polylines and moves the straight section . Adjacent segments may extend or contract in their original directions to maintain their connections.

### Move Arc

- Click and drag the Move Arc edit handle to change the radius and/or chord length or position. Adjacent segments may extend, contract, or change angle to maintain their connections.

### Resize Arc

- Click and drag the Resize Arc edit handle to change the radius, chord length and chord position of the arc segment. Adjacent segments may extend, contract, or change angle to maintain their connections.

### Reshape Arc

- Click and drag the Reshape Arc edit handle to change the radius of the arc without moving its end points.

### Adjust Width

Some open polyline-based objects, such as stairs and roads, have additional handles that allow the width of the object to be adjusted.

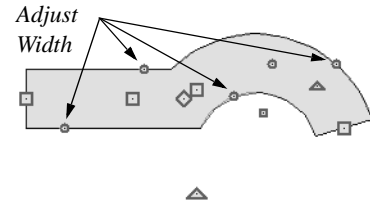

- Click and drag a small, round edit handle to increase or decrease the object’s width. By default, objects are resized in 1" increments. This Snap Unit is defined in the **Plan Defaults** dialog. See “General Plan Defaults Dialog” on page 60.

## Using Dimensions



Dimensions can be used to move or reshape polyline-based objects. See “Moving Objects Using Dimensions” on page 494.

## Using the Specification Dialog















Open polyline-based objects can be edited using their specification dialogs. See “Polyline Specification Dialog” on page 518.

## Using the Edit Toolbar

A selected open polyline-based object can be edited in a variety of ways using the buttons on the edit toolbar.

The following toolbar buttons may display on the edit toolbar for a selected open polyline-based object:

- Click the **Select Next Object**  edit button to select nearby objects instead of the selected object. See “Selecting Objects” on page 88.

- Click the **Open Object**  edit button to open the specification dialog for the selected object. See “Specification Dialogs” on page 32.
- Click the **Copy/Paste**  edit button to copy the selected object(s) to the system clipboard so they can be pasted elsewhere. See “Copying and Pasting Objects” on page 83.
- Click the **Copy and Paste in Place**  edit button to create a copy of the selected object(s) at the same location as the original. See “Copy and Paste in Place” on page 85.
- Click the **Delete**  edit button to delete the selected object(s). See “Deleting Objects” on page 116.
- Click the **Make Parallel/Perpendicular**  edit button to make the selected straight edge parallel or perpendicular to another straight edge. See “Using Make Parallel/Perpendicular” on page 111. Not available when the selected edge is an arc.
- Click the **Center Object**  edit button to center an object along a wall within a room or relative to a cabinet fixture. See “Using Center Object” on page 111.
- Click the **Move to Front of Group**  edit button to display the selected object in front of other objects in the same drawing group. See “Move to Front of Group” on page 108.
- Click the **Break Line**  edit button to add a new corner or pivot point to the selected object. See “Break Line” on page 113.
- Click the **Complete Break**  edit button to break the selected object into two separate objects. See “Break Line” on page 113.
- Click the **Change Line/Arc**  edit button to change a line-based polyline edge to an arc, or vice versa. See “Change Line/Arc” on page 114.
- Click the **Record Walkthrough Along Path**  edit button to record a walk-through video of your model along the path defined by the selected polyline. See “Walkthroughs” on page 543.

---

## Editing Closed-Polyline Based Objects

Closed polyline-based objects are composed of individual line- and arc-based objects joined end-to-end and forming an enclosed area. See “Polylines” on page 518.

Objects are considered closed polyline-based when they can be edited similar to closed CAD polylines using their edit handles.

Closed CAD polylines and terrain features are examples of closed polyline-based objects.

For information about editing open polyline-based objects, see “Editing Open Polyline Based Objects” on page 95.

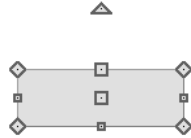

Some objects, such as connected road segments, have additional edit handles that allow you to concentrically adjust the width of all segments of the object.

### Using the Edit Handles

A polyline can be composed of many segments. See “Polylines” on page 518.

When selected, a closed polyline-based object displays a Move handle, a Rotate handle, and a Reshape handle at the intersection of each segment.

Each straight, line-based segment has a Move edit handle along its length.

Each curved, arc-based segment has its own Move handle at the center of its chord, a Resize handle and a Reshape handle. See “Editing Arc Based Objects” on page 92.

When a polyline is selected, the edge that you click nearest is called the selected edge, and certain operations affect only this edge. The Move handle of the selected edge is larger than that of other edges. It displays along the length of a line segment, or at the center of the chord on an arc segment. See “Selected Edge” on page 88.

Any action performed using the edit handles can be cancelled by pressing the Esc key or any two mouse buttons at the same time.

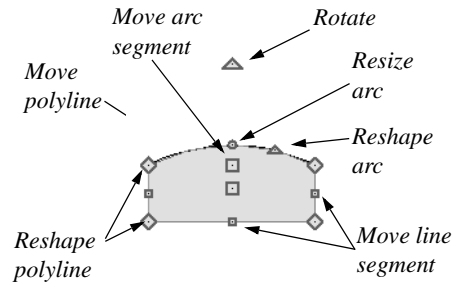

### Move

- Click and drag the Move handle to move the object.
- Movement may be limited or stopped by other objects or Snap Behaviors. Move restrictions can be overridden by holding down the Ctrl key while dragging. See “Unrestricted Movement” on page 109.

### Rotate

- The **Rotate** handle is used to rotate the object about its center. Its position varies depending on which edge is currently selected. See “Rotating Objects” on page 114.

### Reshape

- Click and drag a Reshape edit handle to change the angle and/or length of the segments on either side of it, or the size of the object.

### Move Line Segment

- The **Move Line Segment** edit handle is found on straight segments of closed polylines and moves the straight section. Adjacent segments may extend or contract in their original directions to maintain their connections.

### Move Arc

- Click and drag the Move Arc edit handle to change the radius and/or chord length or position. Adjacent segments may extend, contract, or change angle to maintain their connections.

### Resize Arc

- Click and drag the Resize Arc edit handle to change the radius, chord length and chord position of the arc segment. Adjacent segments may extend, contract, or change angle to maintain their connections.

### Reshape Arc

- Click and drag the Reshape Arc edit handle to change the radius of the arc without moving its end points.

## Using Dimensions



Dimensions can be used to move or reshape closed polyline-based objects. See “Moving Objects Using Dimensions” on page 494.

## Using the Specification Dialog





Closed polyline-based objects can be edited using their specification dialogs. See “Polyline Specification Dialog” on page 518.

## Using the Edit Toolbar



A selected closed polyline-based object can be edited in a variety of ways using the buttons on the edit toolbar.

The following toolbar buttons may display on the edit toolbar for a selected closed polyline-based object:

- Click the **Select Next Object** edit button to select nearby objects instead of the selected object. See “Selecting Objects” on page 88.
- Click the **Open Object** edit button to open the specification dialog for the selected object. See “Specification Dialogs” on page 32.
- Click the **Copy/Paste** edit button to copy the selected object(s) to the system clipboard so they can be pasted elsewhere. See “Copying and Pasting Objects” on page 83.
- Click the **Copy and Paste in Place** edit button to create a copy of the selected object(s) at the same location as the original. See “Copy and Paste in Place” on page 85.
- Click the **Delete** edit button to delete the selected object(s). See “Deleting Objects” on page 116.
- Click the **Make Parallel/Perpendicular** edit button to make the selected straight edge parallel or perpendicular to another straight edge by either rotating the selected edge or the entire polyline. See “Using Make Parallel/Perpendicular” on page 111. Not available when the selected edge is an arc.
- Click the **Center Object** edit button to center an object along along a wall within a room or relative to a cabinet fixture. See “Using Center Object” on page 111.

- Click the **Move to Front of Group**  edit button to display the selected object in front of other objects in the same drawing group. See “Move to Front of Group” on page 108.
- Click the **Break Line**  edit button to add a new corner or pivot point to the selected object. See “Break Line” on page 113.
- Click the **Complete Break**  edit button to break an edge of the selected

object into two separate objects. See “Break Line” on page 113.

- Click the **Change Line/Arc**  edit button to change a line-based polyline edge to an arc, or vice versa. See “Change Line/Arc” on page 114.
- Click the **Record Walkthrough Along Path**  edit button to record a walk-through video of your model along the path defined by the selected polyline. See “Walkthroughs” on page 543.

## Editing Box-Based Objects

Objects are considered box-based when they can be edited similar to CAD boxes using their edit handles.

Box-based objects are similar to closed polyline-based objects, but must always have four sides with right-angled corners.

In addition to the CAD Box tools, Text objects, many library symbols, pictures and images are examples of box-based objects.

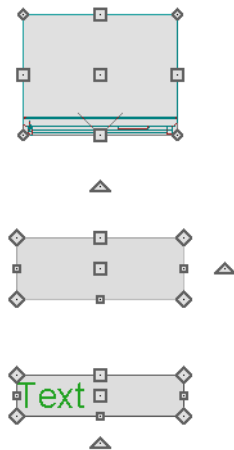

## Using the Edit Handles

When selected, a box-based object displays ten edit handles. Unlike polylines, boxes must always have four sides with right-angled corners.

Any action performed using the edit handles can be cancelled by pressing the Esc key or any two mouse buttons at the same time.

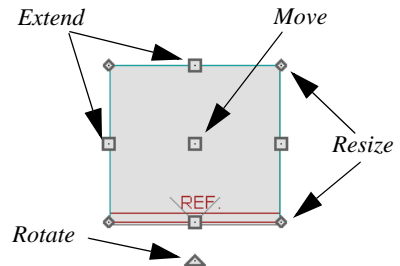

- Click and drag the Move handle to move the object.
- Movement may be limited or stopped by other objects or Snap Behaviors. Move restrictions can be overridden by holding

down the Ctrl key while dragging. See “Unrestricted Movement” on page 109.

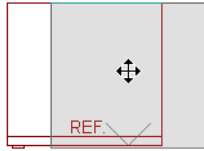

- The four **Resize** handles located at each corner are used to increase or decrease the size of the object.

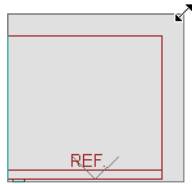

- The four **Extend** handles display along each edge. If you select an object on an edge, the Extend handle displays at the point where you clicked; otherwise, it displays at the center of the edge.

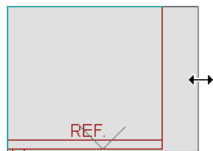

- The triangular **Rotate** handle located near the selected edge of the object is used to rotate it about its center. The pointer changes to a circular arrow  when moved over this handle. See “Rotating Objects” on page 114.

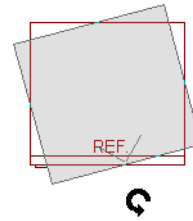

## Using Dimensions



Dimensions can be used to move or reshape box-based objects. See “Moving Objects Using Dimensions” on page 494.

## Using the Specification Dialog











Box-based objects can be edited using their specification dialogs. See “Box Specification Dialog” on page 520.

## Using the Edit Toolbar

A selected box-based object can be edited in a variety of ways using the buttons on the edit toolbar.

The following toolbar buttons may display on the edit toolbar for a selected box-based object:

- Click the **Select Next Object**  edit button to select nearby objects instead of the selected object. See “Selecting Objects” on page 88.
- Click the **Open Object**  edit button to open the specification dialog for the selected object. See “Specification Dialogs” on page 32.

- Click the **Copy/Paste**  edit button to copy the selected object(s) to the system clipboard so they can be pasted elsewhere. See “Copying and Pasting Objects” on page 83.
- Click the **Copy and Paste in Place**  edit button to create a copy of the selected object(s) at the same location as the original. See “Copy and Paste in Place” on page 85.
- Click the **Delete**  edit button to delete the selected object(s). See “Deleting Objects” on page 116.
- Click the **Make Parallel/Perpendicular**  edit button to make the selected straight edge parallel or perpendicular to another straight edge. See “Using Make Parallel/Perpendicular” on page 111. Not available when the selected edge is an arc.
- Click the **Center Object**  edit button to center an object along along a wall within a room or relative to a cabinet fixture. See “Using Center Object” on page 111.
- Click the **Move to Front of Group**  edit button to display the selected object in front of other objects in the same drawing group. See “Move to Front of Group” on page 108.

---

## Editing Spline Based Objects

A Spline is a curve that passes smoothly through a set of points, or vertices. Splines are typically used in situations where an irregular, free-flowing curve is needed.

Objects are considered spline-based when they can be edited similar to CAD splines using their edit handles. See “Draw Spline” on page 513.

Sprinkler lines, spline terrain curbs, spline terrain walls and both round and kidney-shaped terrain features are spline-based objects. See “Terrain” on page 333.



### Using the Edit Handles

When a spline is selected, several different types of handles display.

Any action performed using the edit handles can be cancelled by pressing the Esc key or any two mouse buttons at the same time.

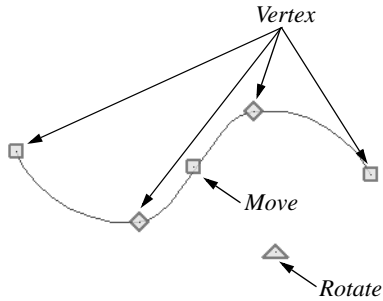

### Move

- Click and drag the Move handle to move the object.
- Movement may be limited or stopped by other objects or Snap Behaviors. Move restrictions can be overridden by holding down the Ctrl key while dragging. See “Unrestricted Movement” on page 109.

### Rotate

- Click and drag the Rotate edit handle to rotate the entire spline.

### Vertex

- The Vertex edit handles display along the spline at each vertex. Click and drag a Vertex edit handle to change the length, angle and curve of adjacent segments without affecting other vertices.



## Using the Specification Dialog









Spline-based objects can be edited using their specification dialogs. See “Polyline Specification Dialog” on page 518.

## Using the Edit Toolbar



A selected spline-based object can be edited in a variety of ways using the buttons on the edit toolbar.



The following toolbar buttons may display on the edit toolbar for a selected spline-based object:

- Click the **Select Next Object**  edit button to select nearby objects instead of the selected object. See “Selecting Objects” on page 88.
- Click the **Open Object** edit button to open the specification dialog for the selected object. See “Polyline Specification Dialog” on page 518.
- Click the **Copy/Paste**  edit button to copy the selected object(s) to the system clipboard so they can be pasted elsewhere. See “Copying and Pasting Objects” on page 83.
- Click the **Copy and Paste in Place**  edit button to create a copy of the selected object(s) at the same location as the original. See “Copy and Paste in Place” on page 85.
- Click the **Delete**  edit button to delete the selected object(s). See “Deleting Objects” on page 116.
- Click the **Make Parallel/Perpendicular**  edit button to make the selected spline edge parallel or perpendicular to another straight edge. See “Using Make Parallel/Perpendicular” on page 111.
- Click the **Center Object**  edit button to center an object along a wall within a room or relative to a cabinet



fixture. See “Using Center Object” on page 111.

- Click the **Move to Front of Group**  edit button to display the selected object in front of other objects in the same drawing group. See “Move to Front of Group” on page 108.
- Click the **Break Line**  edit button to add a new corner or pivot point to the selected object. See “Break Line” on page 113.

- Click the **Complete Break**  edit button to break an edge of the selected object into two separate objects. See “Break Line” on page 113.
- Click the **Record Walkthrough Along Path**  edit button to record a walk-through video of your model along the path defined by the selected polyline. See “Walkthroughs” on page 543.

## Editing Circles, Ovals and Ellipses

Objects created using the **Circle, Oval, and Ellipse Tools** are unusual in that no architectural objects share their functionalities.

### Using the Edit Handles

When selected, circles, ovals and ellipses display eleven edit handles.

Unlike **Ovals**  and **Ellipses** , a

**Circle**  cannot be edited into any other shapes; it can only be a circle.

Any action performed using the edit handles can be cancelled by pressing the Esc key or any two mouse buttons at the same time.

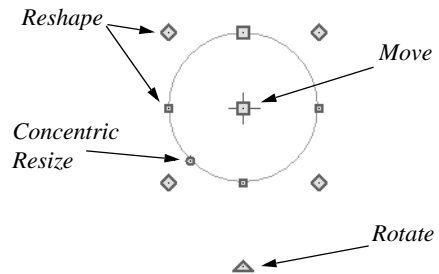

### Move

- Click and drag the Move handle to move the object. .
- Movement may be limited or stopped by other objects or Snap Behaviors. Move restrictions can be overridden by holding down the Ctrl key while dragging. See “Unrestricted Movement” on page 109.

### Rotate

- Click and drag the Rotate handle of an oval or ellipse to change its orientation.

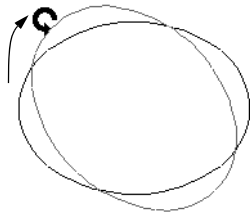

### Reshape

- The eight edit handles beyond the perimeter are Reshape edit handles. Move them in or out to resize and reshape an oval or ellipse.

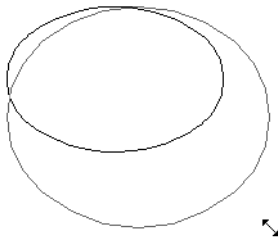

- Unlike ovals and ellipses, circles cannot be reshaped. When a Reshape handle is dragged on a circle, it is only resized.

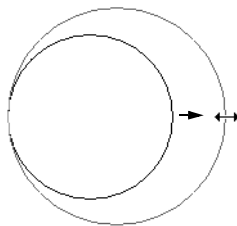

### Concentric Resize

- The Concentric Resize edit handle displays on the perimeter of a circle between a corner Reshape handle and the center. Click and drag this handle to resize the circle without moving its center point.

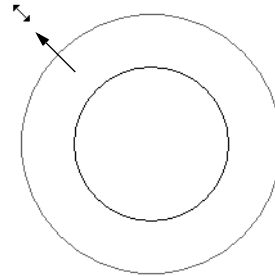

### Using Dimensions

-  Dimensions can be used to move or resize circle-based objects. See “Moving Objects Using Dimensions” on page 494.



### Using the Specification Dialog

-  Circles, ovals and ellipses can be edited using their specification dialogs. See “CAD Circle/Oval/Ellipse Specification Dialog” on page 517.







### Using the Edit Toolbar

A selected circle, oval or ellipse can be edited in a variety of ways using the buttons on the edit toolbar.

The following toolbar buttons may display on the edit toolbar for a selected circle, oval or ellipse:

- Click the **Select Next Object**  edit button to select nearby objects instead of the selected object. See “Selecting Objects” on page 88.
- Click the **Open Object**  edit button to open the specification dialog for the

selected object. See “Specification Dialogs” on page 32.

- Click the **Copy/Paste**  edit button to copy the selected object(s) to the system clipboard so they can be pasted elsewhere. See “Copying and Pasting Objects” on page 83.
- Click the **Copy and Paste in Place**  edit button to create a copy of the selected object(s) at the same location as the original. See “Copy and Paste in Place” on page 85.
- Click the **Delete**  edit button to delete the selected object(s). See “Deleting Objects” on page 116.
- Click the **Make Parallel/Perpendicular**  edit button to make the selected edge parallel or perpendicular to another straight edge. See “Using Make Parallel/Perpendicular” on page 111.
- Click the **Center Object**  edit button to center an object along along a wall within a room or relative to a cabinet fixture. See “Using Center Object” on page 111.
- Click the **Move to Front of Group**  edit button to display the selected object in front of other objects in the same drawing group. See “Move to Front of Group” on page 108.

---

## Displaying Objects

The display of objects in 2D and 3D views can be controlled by layer. See “Displaying Objects” on page 76.

### Line and Fill Styles



Line style and color can be controlled by layer or overridden in the specification dialogs for many objects. See “Line Style Panel” on page 514.

In addition, some objects have a fill style that can be specified in the objects’ specification dialogs. See “Fill Style Panel” on page 519.

### Color On/Off



The display of color on-screen can be toggled on and off in any view by selecting **View> Color**.

- If **Color**  is toggled off in any 3D view other than a Vector View, the view will be displayed in grayscale.
- If **Color**  is toggled off in floor plan view or a Vector View, the view will be displayed in black and white.

You can also print in color or gray scale. See “Print View Dialog” on page 567.

### Drawing Groups

Each object in a plan file belongs to one of three drawing groups, which influences whether it displays in front of or behind other objects.

- The **Default Group** is where most objects are placed when first created.

- Objects on the **Back Group** display behind those in the other two drawing groups.
- Objects on the **Front Group** display in front of those in the other two drawing groups.

Most objects are drawn in the Default Group. Notable exceptions are imported pictures, which are placed in the Back Group, and Walkthrough Paths, which are placed in the Front Group. Objects in the Default Group display in front or behind one another according to program-defined rules that can be modified in only limited ways.

### Move to Front of Group



Click the **Move to Front of Group** edit button to move the selected object(s) so that it displays in front of other objects in the same drawing group.

**Move to Front of Group**  only affects the display of objects when they are of the same type: for example, CAD objects, furnishings, base cabinets, or wall cabinets. It cannot make a base cabinet display in front of a wall cabinet; but it can make a selected wall cabinet display in front of other wall cabinets.

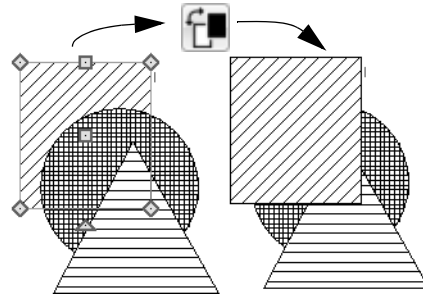

**Move to Front of Group**  is not available for Walkthrough Paths.

### Textures

The appearance of architectural objects in 3D views is affected by the materials applied to the objects' surfaces. See "Materials" on page 415.

In Standard rendered views, you can turn on or off the display of textures by selecting **3D> Toggle Textures** .

### Delete Surface



In any 3D view, select **3D> Delete Surface**, then click a surface in the view to temporarily remove the surface from the current view. See "Delete 3D Surface" on page 455.

### Refresh Display

**Refresh Display** redraws the current window to clean up extra lines, show missing items, and correct random on-screen effects caused by changes to a model. Select **View> Refresh Display** or press the F5 key to refresh the on-screen display.

## Moving Objects

Objects can be moved using the edit handles as well as a variety of edit tools. Multiple selected objects can also be moved as a group. See “Selecting Objects” on page 88.

### Using the Edit Handles

Select an object, then click the **Move** edit handle and drag it to a new location. When your pointer is over the Move handle, it displays a four-headed arrow.

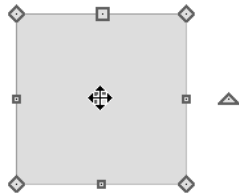

When moved, the selected object moves orthogonal, or at a right angle to, any of its edges.

As an object is moved, it jumps at set increments when **Grid Snaps**  are enabled. See “Grid Snaps” on page 81.

If an selected object passes over its original location as it is being moved, it will snap to that location.

You can temporarily slow the movement of your mouse as you drag an edit handle by holding down the Shift key on your keyboard.

### Bumping/Pushing

When an object bumps into another object while it is being moved, it stops. If you do not release the mouse button and continue to

drag, however, the selected object resumes movement and continues past the obstructing object.

Instead of dragging through and past one or more obstructing objects, you can instead push them. To do this, bump an object into an obstructing object and release the mouse button. Then, click and drag the Move edit handle a second time in the same direction.

Walls, wall openings, cabinets, furnishings and fixtures, and CAD and CAD-based objects are examples of objects that can bump into as well as push other objects.

**Bumping/Pushing** does not affect objects moved using dimensions. See “Moving Objects Using Dimensions” on page 494.

### Unrestricted Movement

Many objects have restrictions placed on their movement by their own properties or specification settings. Architectural objects, for example, bump into other 3D objects as they are being moved.

Other move restrictions are activated by the **Snap Settings**. See “Snap Behaviors” on page 80.

These restrictions can be overridden when necessary by holding down the Ctrl key while dragging to move an object.

#### *To move an object freely*

1. Select the object.
2. Hold down the Ctrl key.
3. Click the Move edit handle and drag it to the new location.

You can also press the Ctrl key while dragging an object's Move handle to override move restrictions.

## Nudging

You can use the arrow keys on your keyboard to move a selected object or objects by single **Snap Grid** increments in 2D and 3D views. This is referred to as nudging. See "Grid Snaps" on page 81.

### In Floor Plan View

To nudge an object in floor plan view, select it and press any of the four arrow keys: Up, Down, Left, or Right.

### In 3D Views

In 3D views, nudging is relative to the selected surface. If, for example, you select the front of a cabinet in 3D and nudge it to the left, it will move to the left in floor plan view. If you instead select the back of a cabinet in 3D and nudge it to the left, it will move to the right in floor plan view.

When multiple objects are selected, the surface that was clicked on last is considered

the selected surface. When nudged, all selected objects will move relative to that surface. See "Shift and Ctrl Select" on page 89.

If an object is rotated, the directions that it can be nudged in 2D are not affected; however, in 3D, they are. If, for example, a cabinet is rotated 45°, it will nudge to the left in floor plan view. When nudged in 3D, however, it will move at a 45° angle: or parallel to the selected surface.

## Center Object



The **Center Object** edit button allows you to move walls, cabinets and other objects so that they are centered along a wall within a room or relative to a window or cabinet.

## Using Dimensions



Objects or the selected edges of some objects can be moved using dimensions. See "Moving Objects Using Dimensions" on page 494.

---

## Aligning Objects

It is often important to align objects such as text boxes or walls, or to align objects on different floors. There are several methods to choose from.

### Using the Mouse Cross Hairs

Objects can be aligned by eye using the mouse cross hairs as a reference. This method can help you draw, place and edit

objects quickly and with reasonable accuracy, but is not necessarily as accurate as some of the other approaches described here.

The mouse cross hairs can be turned on and off in the **Preferences** dialog. See "Edit Panel" on page 66.

### Using Snap Settings

With **Object Snaps**, you can snap the edge of a selected object to that of another. Select

an edge of an object. Drag it to the edge of another object, then release the mouse.

With **Grid Snaps**  on and **Angle**

**Snaps**  off, select the left side of the object, and drag from the center move handle. This snaps the selected side to the grid.

When both **Grid Snaps**  and **Angle**

**Snaps**  on, objects snap at increments equal to the **Snap unit** specified in the **Plan Defaults** dialog rather than onto the grid itself. This does not align objects to the grid unless they were already snapped to the grid. See “Snap Behaviors” on page 80.

## Using Dimensions



Create a temporary or manual dimension relative to an object such as a wall or line, and relocate the objects to the same dimension. See “Moving Objects Using Dimensions” on page 494.



Text objects can be aligned using settings in the Text Specification dialog. See “Aligning Text” on page 505.

## Using Make Parallel/Perpendicular



The **Make Parallel/Perpendicular** edit button allows you to make a selected object parallel or perpendicular to any straight edge.

If you select an edge of a polyline-based object, adjacent edges extend or contract to maintain contact, but other edges are remain unchanged. The selected edge rotates about

its endpoint if selected near the end, or about its center if you click within its middle third.

### To use Make Parallel/Perpendicular

1. Select an object on the edge that you would like to make parallel or perpendicular to another object.
  - Click near the center of the edge to rotate it about the center.
  - Click near an end to rotate the edge about that end.
2. Click the **Make Parallel/Perpendicular**  edit button
3. Click on a straight edge such as a wall.
4. If the first object is within 45° of parallel to the second object, it is made parallel. Otherwise, it is made perpendicular to the second object.

## Using Center Object



The **Center Object** edit button can be used to center a variety of objects relative to another object. Center Object can be used in floor plan, elevation, and 3D views.

### To center an object

1. Select an object.
2. Click the **Center Object**  edit button.
3. Move the mouse pointer over the object you would like to center the selected object relative to.
  - As the pointer passes over an eligible object, it becomes highlighted and a dashed centering axis line displays.

4. When the desired centering axis displays, click once to center the selected object along that axis line.

#### *To center an object in a room*

1. Select an object such a cabinet.
2. Click the **Center Object**  edit button.
3. Move the mouse pointer in the room that you would like to center the selected object relative to.
  - As you move the pointer, a centering axis will display along the wall it is closest to.
  - The selected object does not have to be inside a room in order to be centered relative to that room.

4. When a centering axis displays along the correct wall, click once.
5. The object is moved perpendicular to the centering axis.

If you click outside an exterior wall instead of clicking inside, the selected object is centered along the edge of the Exterior Room. See “The Exterior Room” on page 161.

### Aligning Objects on Different Floors

Objects on different floors can be aligned with one another using the **Reference**

**Display** . See “The Reference Floor” on page 225.

---

## Resizing Objects

Objects can be resized using the edit handles and specification dialogs.

### Using the Edit Handles

The end, corner and/or side edit handles can be used to resize a selected object.

To override any movement restrictions caused by snap settings or the presence of other objects, press the Ctrl key while dragging an edit handle.

As an object is resized, any dimensions indicating its size will update to reflect your changes. You can use dimensions as references to help you achieve the correct size for most objects.

You can temporarily slow the movement of your mouse as you drag an edit handle by

holding down the Shift key on your keyboard.

### Using the Specification Dialog



Most objects can be accurately resized in their specification dialogs. See “Specification Dialogs” on page 32.

### Using Dimensions



Many objects can be resized by selecting an edge and then moving that edge using dimensions. See “Moving Objects Using Dimensions” on page 494.

Walls can also be resized using dimensions; however, it is important to understand that the selected edges of other objects cannot be resized using dimensions - they can only be



moved. To resize an edge, select an adjacent edge and move that edge instead.

## Reshaping Objects

There is a variety of ways to reshape objects using the edit handles, specification dialogs and edit toolbar buttons.

Some objects, notably circles and box-based objects, cannot be reshaped - only resized. See “Resizing Objects” on page 112.

### Using the Edit Handles

Depending on the type of object selected, the end, corner and/or side edit handles can be used to reshape a selected object.

To override any movement restrictions caused by snap settings or the presence of other objects, press the Ctrl key while dragging an edit handle.

You can temporarily slow the movement of your mouse as you drag an edit handle by holding down the Shift key on your keyboard.

### Using the Specification Dialog



A variety of CAD and CAD-based objects can be reshaped by editing values on either the **SELECTED LINE** or **SELECTED ARC** panel of their specification dialogs. See “Polyline Specification Dialog” on page 518.

### Using Dimensions



Both temporary and manually drawn dimensions can be used to increase or

decrease the distance between the edge a line- or polyline-based object and another, parallel edge or line.

### Break Line



The **Break Line** edit tool can be used to break an individual line-, arc-, or spline-based object into two segments. The edges of a polyline-based object can also be broken.

**Note:** The Break Line edit button is not available for box-based objects, objects created with the Circle Tools, or some architectural objects such as stairs.

There are two types of breaks: partial and complete. Partial breaks create a new corner, or pivot point, while complete breaks actually sever an edge into two segments.

#### *To create a partial break*



1. Click the object, object edge, or object centerline that you want to break into two segments.
2. Click the **Break Line**  edit button once or press the 3 key.
3. Click the edge to create a new corner edit handle at that location and two separate edges on either side of that handle.

If you click and drag one of the edit handles on either side of the partial break, the edge moves at a right angle to itself and another

edge forms, connecting the moved edge with the one on the other side that does not move.

You can remove an edge from a polyline-based object by clicking and dragging a corner handle until it snaps to an adjacent corner handle.

### *To create a complete break*

1. Click the object, object edge, or object centerline that you want to break into two segments.
2. Click the **Break Line**  edit button.
3. Click the **Complete Break**  edit button.
4. Click on an edge to create a complete break at that location.

The edge that you clicked on will be divided into two separate sections, one of which will be selected. You can now move or edit the selected edge completely independent of the object or edge on the other side of the break. Click on the other edge to select it instead.

### *To remove a break from an edge*

1. Make sure that **Object Snaps** are enabled. See “Object Snaps” on page 80.

2. Select the object that has a break that you want to remove.
3. Click on the corner edit handle associated with the break that you want to remove and drag it to an adjacent corner handle.
4. Release the mouse button and the handle that you selected will be removed.

## Change Line/Arc

 Select an individual line-based or arc-based object or a segment of a polyline-based object and click the **Change Line/Arc** edit button to convert the selected segment from a line to an arc or vice versa.

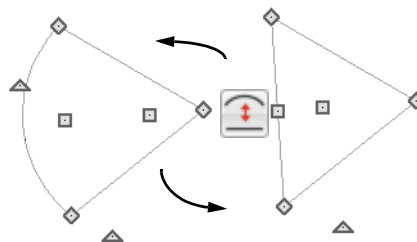

## Make Parallel/Perpendicular

 The **Make Parallel** edit button can be used to reshape a polyline by making a selected edge parallel or perpendicular to another straight edge. See “Using Make Parallel/Perpendicular” on page 111.

---

## Rotating Objects

Objects can be rotated using the edit handles as well as a variety of edit tools. Multiple selected objects can also be rotated as a group. See “Selecting Objects” on page 88.

By default, an object or group of objects rotate about the center point of the selection set.

## Using the Edit Handles

Select an object, then click the triangular **Rotate** edit handle and drag it in any direction. When your pointer is over the Rotate handle, it displays a curved arrow.

The angles of line-based objects can also be changed by dragging an end handle in a direction other than parallel to the object. The object rotates about the opposite end point. See “Editing Line Based Objects” on page 90.

Objects snap to Allowed Angles as they are rotated. See “Angle Snaps” on page 81.

To override any movement restrictions caused by snap settings or the presence of other objects, press the Ctrl key while dragging an edit handle.

You can temporarily slow the movement of your mouse as you drag an edit handle by

holding down the Shift key on your keyboard.

## Using the Specification Dialog



The exact angle of some objects such as lines, arcs, walls and the selected edges of polylines can be specified on either the GENERAL panel, SELECTED LINE panel, or SELECTED ARC panel of that object’s specification dialog. See “Polyline Specification Dialog” on page 518.

## Reverse Plan



The **Reverse Plan** tool is a quick way to mirror a plan so that everything on all floors of the entire plan is swapped left to right.

Select **Tools> Reverse Plan**  to reflect an entire plan right to left, as though it were reflected about a vertical line.

---



## Matching Properties





The **Object Eyedropper** tool allows you to select attributes from one object and apply them to other, similar objects.

### To use the Object Eyedropper



1. Begin by selecting the **Object Painter Mode** that you want to use. Select **Tools> Object Painter**, then:
  - Select **Object Painter Object Mode**  to apply attributes to individual objects, one at a time.

- Select **Object Painter Room Mode**  to apply attributes to an individual object as well as all objects in the same room that are identical to it with a single click.
- Select **Object Painter Floor Mode**  to apply attributes to an individual object as well as all objects on the same floor that are identical to it with a single click.
- Select **Object Painter Plan Mode**  to apply attributes to an individual object as well as all objects in the entire

- plan that are identical to it with a single click.
2. Select **Tools> Object Painter> Object Eyedropper** , and notice that your mouse pointer displays an eyedropper  icon.
  3. Move your mouse pointer over an object in the current view. If it becomes highlighted and “Object to pick” information is stated on the left side of the Status Bar, click once to load the object’s attributes so they can be applied to other, similar objects.
  4. Notice that your mouse pointer now displays a spray can  icon.
  5. Move your mouse pointer over an object that is similar to the one selected in step 1: if it becomes highlighted and “Load Properties to” information is stated in the Status Bar, the object is eligible to receive the loaded attributes.
  6. Click on an eligible object to apply attributes to it as well as any other identical objects, depending on which Object Painter Mode is active.
  7. Continue clicking to apply attributes until the Esc key is pressed or another tool is activated.

## Deleting Objects

Objects can be deleted in a variety of ways:

- Select an object or group of objects, then click the **Delete**  edit button, select **Edit> Delete**  from the menu, or press the either the Delete or Backspace key on your keyboard.
- Entire categories of objects can be deleted using the **Delete Objects** dialog.

- Objects are deleted if the floor they are placed on is deleted. See “Deleting Floors” on page 223.

If an object has a line with arrow attached to it, the arrow is deleted if the object is deleted. To prevent the arrow from being deleted, drag the attached end away from the object before deleting it.

### Delete Objects Dialog

 In floor plan view, use the **Delete Objects** dialog to delete all objects of one or more specified types in one room, on the current floor, or on all floors in the plan.

Note that the **Delete Objects** dialog does not delete CAD objects or plant schedules drawn in cross section/elevation views .

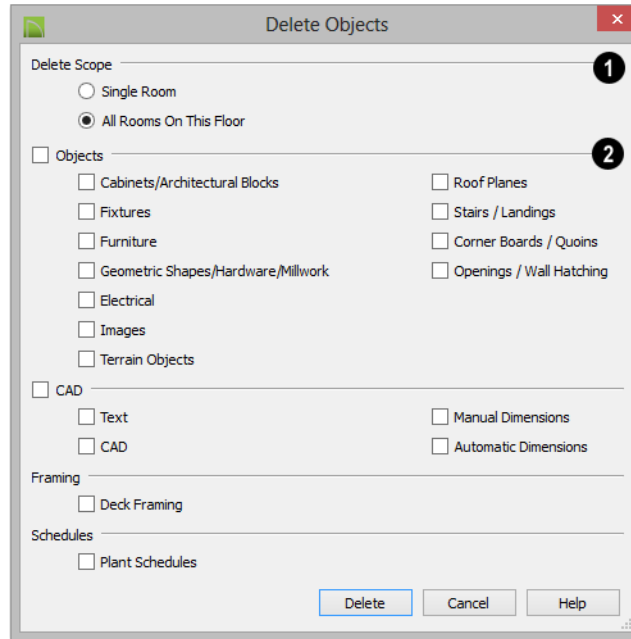

- 1 Select a **Delete Scope**:
  - Choose **Single Room** to delete objects only in rooms on the current floor that you specify.
  - Choose **All Rooms on This Floor** to delete objects in all rooms on the current floor.
- 2 Specify categories of **Objects to Delete** by checking the box beside each category that you wish to delete.
  - Check the box beside any heading to select all of the categories within it; clear the box beside a heading to deselect all of its categories.

### *To use the Delete Objects dialog*

1. Select **Edit> Delete Objects**  to open the **Delete Objects** dialog.
2. Specify the **Delete Scope** as **Single Room** or **All Rooms On This Floor**.
3. Check the box for each category of objects you want to delete. Click **Select All** to check all the boxes or **Clear All** to uncheck all boxes.
4. When the scope is set to **Single Room**:
  - Move your cursor into the drawing area and click in a room of the plan to delete objects of the selected type within that room without closing the dialog.
  - Only objects with their center point located in the room are deleted.
  - Continue clicking on rooms or choose a different Delete Scope.

- Click **Done** when all selections have been deleted.
5. If you select **All Rooms On This Floor**, you do not need to click in floor plan view. The **Delete** button becomes available, and clicking it closes the dialog and deletes the specified objects.

Objects such as roofs or Auto Exterior Dimensions that are set to automatically rebuild or refresh cannot be deleted while that behavior is enabled. If objects of this sort are selected for deletion, the program will ask whether you want to turn off the automatic redraw behavior.

## Deleting Polyline Edges

To remove an edge from a polyline, drag a corner handle until it overlaps an adjacent corner handle to remove the edge between them and merge them into a single handle. See “Reshaping Objects” on page 113.

## Delete Surface



In any 3D view, select **3D> Delete Surface**, then click a surface in the view to temporarily remove the surface from the current view without permanently affecting the object. See “Delete 3D Surface” on page 455.



---

## Undo and Redo





The **Undo** and **Redo** commands allow you to both undo the last action performed, as well as redo actions that were recently Undone.

The ten most recent actions can be Undone or Redone. Actions that can be Undone and Redone include creating, editing, and deleting objects.

To Undo an action, select **Edit> Undo** , click the **Undo**  button, or press **Ctrl + Z** on your keyboard.

The Redo command is only available immediately after Undo has been used. To Redo an Undone action, select **Edit>**

**Redo** , click the **Redo**  button or press **Ctrl + Y** on your keyboard.

It is important to note that **Undo**  and **Redo**  do not affect all actions in the program, including:

- Save and Save As. See “Saving, Exporting, and Backing Up Files” on page 45.
- Changes made in the Library Browser. See “The Library Browser” on page 394.
- Changes made in a Materials List. See “Materials Lists” on page 579.
- Changes made in a dialog while the dialog box is open. See “Dialogs” on page 30.
- Changes made to the display by panning the display or zooming in or out. See “Undo Zoom” on page 443.
- Changes made to the position of a camera, or its Rendering Technique. See “Editing 3D Views” on page 461.

# Walls, Railings, and Fencing

Walls are the single most important building component in Home Designer Architectural. By creating walls and defining the rooms created by the walls, you are telling the program how you want the 3D model built.

There are several ways that walls can be created in Home Designer Architectural. The most common is to simply draw them with the Wall Tools.

In addition, exterior walls can be generated automatically when a new floor is built by using another floor as a model. For more, see “Adding Floors” on page 221.

Another feature that can be used to generate walls automatically is the **Space Planning Assistant**. See “Space Planning” on page 523.

## Chapter Contents

- Wall Defaults
- Wall Tools
- Railing and Deck Tools
- Fencing Tools
- Exterior and Interior Walls
- Foundation Walls
- Pony Walls
- Railing and Deck Tools
- Room Dividers and Invisible Walls
- Polygon Shaped Decks
- Hatch Wall
- Break Wall
- Drawing Walls
- Connecting Walls
- Displaying Walls
- Measuring Walls
- Editing Walls
- Aligning Walls
- Roof Directives in Walls
- Attic Walls
- Wall Type Definitions
- Wall Type Definitions Dialog

- Wall Specification Dialog
- Wall Hatch Specification Dialog
- Railing and Fencing Specification Dialogs



## Wall Defaults





Default Settings can be accessed by selecting **Edit> Default Settings**. Click the + next to “Walls” to display the walls sub-headings. Select a subheading and click the **Edit** button to open the **Wall Defaults** dialog associated with your selection.

The settings in the various wall defaults dialogs determine what wall types are drawn when the different wall tools are used. It is a good idea to be familiar with these settings and how they relate to your style of building. See “Wall Type Definitions” on page 142.

### Exterior and Interior Wall Defaults Dialogs

Specify the initial attributes of walls drawn using the **Exterior Wall**  and **Interior Wall**  tools in the **Exterior** and **Interior Wall Defaults** dialogs. See “Wall Tools” on page 122.

- 1 Select the wall type drawn using the **Exterior Wall**  tool.
- 2 Select the wall type drawn using the **Interior Wall**  tool.

Click the **Define** button to the left of either drop-down list to open the **Wall Type Definitions** dialog, where you can modify the selected wall types. See “Wall Type Definitions Dialog” on page 144.

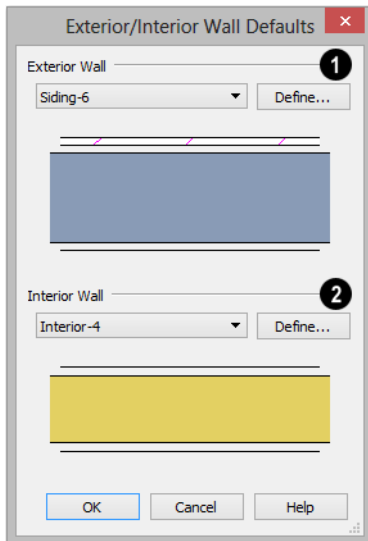



## Pony Wall Defaults

Specify the wall types used for the upper and lower portions of Pony Walls  and other data associated with pony walls in the **Pony**

**Wall Defaults** dialog. See “Pony Walls” on page 126.

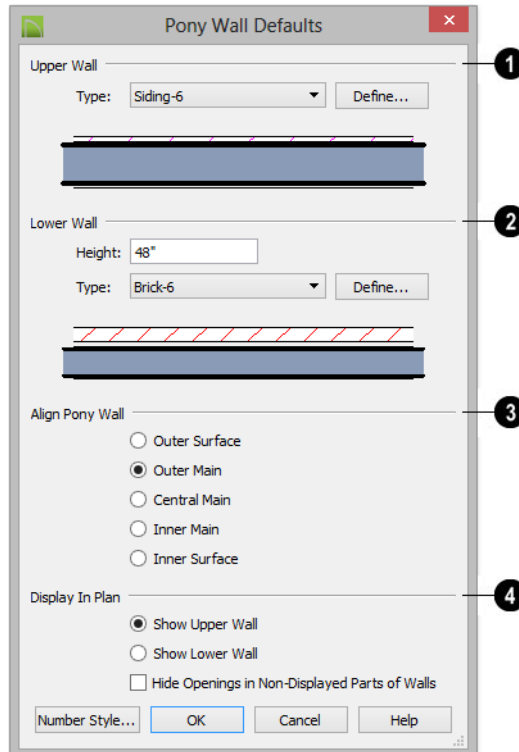

**1 Upper Wall** - From the drop-down list, select the default wall type for the upper portion of pony walls.

- Click the **Define** button to open the **Wall Type Definitions** dialog, where you can create and modify wall types. See “Wall Type Definitions Dialog” on page 144.

**2 Lower Wall** - From the drop-down list, select the default wall type for the lower portion of pony walls.

- **Height of Lower Wall** - Specify the default height of the lower portion of pony walls.

- Click the **Define** button to open the **Wall Type Definitions** dialog.

**3 Align Pony Wall** - Specify the default option for aligning the layers of the upper and lower pony walls. See “Wall Types Panel” on page 150.

- 4 **Display In Plan View** - Specify how pony walls appear in floor plan view.
- Select **Show Upper Wall** to display this wall type in floor plan view instead of the lower wall type.
- Select **Show Lower Wall** to display this wall type in floor plan view instead of the upper wall type.

- Check **Hide Openings in Non-Displayed Parts of Walls** to hide any doors and windows located in the parts of pony walls that are not visible. When unchecked, these openings will display along with those located in the visible parts of pony walls.

---

## Wall Tools

Select **Build> Wall** to access the Wall Tools. The type of wall drawn by each wall tool is specified in its corresponding defaults dialog.

The **Curved Wall** tools are similar to their corresponding **Straight Wall Tools**. Select **Build> Curved Wall** to access these tools.

### Exterior Walls



The **Exterior Wall** and **Curved Exterior Wall** tools draw walls using the default wall type specified for exterior walls in the **Exterior/Interior Wall Defaults** dialog. See “Exterior and Interior Walls” on page 125.

### Interior Walls



The **Interior Wall** and **Curved Interior Wall** tools draw walls using the wall type specified for interior walls. The interior wall type is defined in the **Exterior/Interior Wall Defaults Defaults** dialog.

Note: Whether a wall is recognized as an exterior or interior wall by the program is determined by its position in the model, not by the tool used to draw it. See “Exterior and Interior Walls” on page 125.

### Foundation Walls



The **Foundation Wall** and **Curved Foundation Wall** tools draw foundation walls. Foundation walls normally have a footing and can be drawn on any floor of the model, not just the foundation floor. See “Foundation Walls” on page 126.

### Pony Walls



A **Pony Wall**, also called a split wall, is defined as a wall with two separate wall types, one for the upper portion and another for the lower portion.

The **Pony Wall** and **Curved Pony Wall** tools draw pony walls using the information specified in the **Pony Wall Defaults** dialog. See “Pony Walls” on page 126.

## Half-Walls



The **Half-Wall** and **Curved Half-Wall** tools create solid railings: walls that are 36" (900 mm) high topped with a handrail.

## Room Dividers



**Room Dividers** are Invisible walls with a thickness of 0" (mm) that are used to define separate room areas in a plan. They can display in floor plan view but not in 3D views. See "Room Dividers and Invisible Walls" on page 127.

## Hatch Wall



The **Hatch Wall** tool applies a hatch pattern to a wall that displays in floor plan views. You must click the wall that you

want to apply the hatch pattern to. You can then select the hatch and resize it if you want to only hatch a portion of a wall. See "Hatch Wall" on page 129.

## Break Wall



The **Break Wall** tool applies a break in a wall. Once a wall is broken, the two wall segments are separate walls that can be modified independent of each other. See "Break Wall" on page 129.

## Define Wall Types



The **Define Wall Types** tool opens the **Wall Type Definitions** dialog, where wall types can be created, copied and edited. See "Wall Type Definitions Dialog" on page 144.

---

## Railing and Deck Tools



Select **Build > Railing and Deck** to access the Railing and Deck Tools. Railings are typically used to define interior spaces, while the various Deck tools are used to define exterior Deck rooms.

With the exception of the Polygon Shaped Deck tool, each of the tools in this family have both Straight and Curved versions, and are created and edited just like walls. See "Drawing Walls" on page 130.

To create a break in a railing for a stairway or other access, use a **Doorway** . This keeps the railing continuous and maintains room definition. See "Room Definition" on page 160.

When first drawn, railings are specified as **No Locate**, which prevents **Auto Exterior**

**Dimensions**  from locating them. This attribute may also be helpful if you do not want a railing to divide an area into two separate rooms. See "General Panel" on page 147.

## Railings



The **Railing** and **Curved Railing** tools create railings that are primarily used to define interior spaces.

Railings are ideal for a number of tasks:

- Creating changes in floor and/or ceiling height. See "Floor and Ceiling Heights" on page 168.

- Creating stairwells. See “Creating a Stairwell” on page 275.



### Deck Railing



The **Straight Deck Railing** and **Curved Deck Railing** tools draw decks, complete with framing and bounded by a railing. If a foundation level exists, supports for the deck are also created. See “Decks” on page 167.

When a room is defined using deck railing, its **Room Type** is automatically set to “Deck”. See “Decks” on page 167.

### Deck Edges



The **Straight Deck Edge** and **Curved Deck Edge** draw decks complete with framing, but without a railing. No deck supports are created.

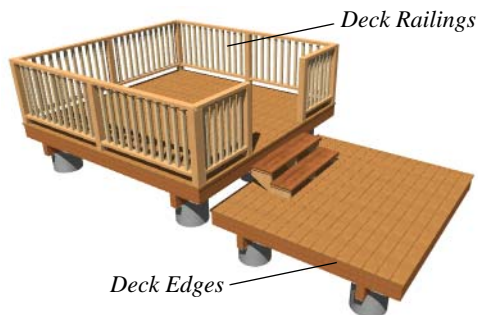

### Polygon Shaped Deck



The **Polygon Shaped Deck** tool opens the **New Polygon Shaped Deck** dialog, where you can specify the exact size and number of sides of a new polygonal deck room and then click in floor plan view to create that deck room. See “Polygon Shaped Decks” on page 128.

### Railing Types

A variety of railing types can be specified in the **Railing** and **Deck Railing Specification** dialogs. See “Rail Style Panel” on page 154. Available types include:

- **Baluster** creates railings composed of newel posts, balusters, a railing, and an optional bottom rail.
- **Solid** produces a framed railing wall, or Half Wall. See “Half-Walls” on page 123.
- If **Panels** is selected, you can choose a panel style such as glass or ironwork from the library. See “Newels/Balusters Panel” on page 156.

Newels and balusters do not display in floor plan view.

## Fencing Tools

 Select **Build> Fencing** or click the **Fencing Tools** to access the fencing tools. Fencing automatically follows the shape of the terrain.

 The **Fencing** and **Curved Fencing** tools are used to draw fences, which are similar to railings but by default do not define room areas. Fencing is created and edited much like walls and railings, and normally used outside of a building and follows the shape of the terrain. See “Terrain” on page 333.



You can specify a fence panel style in the **Fencing Specification** dialog. See “Railing and Fencing Specification Dialogs” on page 154.

## Exterior and Interior Walls

 Most walls are drawn using either the **Straight Exterior Wall** and **Straight Interior Wall** tools.

 Exterior and interior walls can also be drawn using the **Curved Exterior Wall** and **Curved Interior Wall** tools.

The only difference between the Exterior and Interior Wall Tools is the wall type used: Exterior Walls use a wall type set up to model a wall with siding, while Interior Walls model interior walls with sheetrock. You can specify the default wall type for each tool in the **Exterior/Interior Wall Defaults** dialog. See “Exterior and Interior Wall Defaults Dialogs” on page 120.

To draw a wall using a different wall type, you can change the default wall type for either tool in the **Exterior** and **Interior Wall Defaults** dialogs. You can also draw a wall

using the default type and then change the wall type in the **Wall Specification** dialog.

Whether a wall is recognized by the program as an actual exterior or interior wall is based on its position in the model, not by which tool you use to draw the wall.

- Any wall or wall segment that is entirely surrounded by interior room areas is considered to be an interior wall.
- Any wall or wall segment that defines an exterior room or is exposed to the outside of the building is considered to be an exterior wall. See “Room Types” on page 164.

---

## Foundation Walls



Foundation walls are similar to the interior and exterior walls but also have a footing. Foundation walls can either be created automatically when a foundation floor is created or manually by drawing them using the **Straight** or **Curved Foundation Wall** tool. See “Building a Foundation” on page 229.



The initial foundation wall type and footing size can be changed for individual walls in the **Wall Specification** dialog. See “Wall Specification Dialog” on page 146.

---

## Pony Walls



A **Pony Wall**, sometimes called a split wall, is a wall with two separate wall types, one above the other.

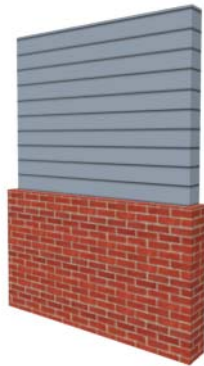

Walls drawn using the **Pony Wall**  tool are created using the wall types and other information specified in the **Pony Wall**



**Defaults** dialog. See “Pony Wall Defaults” on page 121.

The height where the upper portion meets the lower can be adjusted in 3D views using the wall’s edit handles as well as in the **Wall Specification** dialog. The upper and lower sections of a pony wall are linked, so if either portion is modified along the division between the two, the other portion of the pony wall adjusts to match.

### Displaying Pony Walls

You can specify whether the upper or lower portion of pony walls displays in floor plan view in the **Pony Wall Defaults** dialog. This **Display in Plan View** option can also be set for individual walls in the **Wall Specification** dialog. See “Wall Types Panel” on page 150.

Just as with other walls, the appearance of the portion of a pony wall that displays can be controlled. See “Displaying Walls” on page 132.

Only the portion of a pony wall that displays can be snapped to; however, regardless of what part is displaying, the upper wall will be used to **Align with Wall Above** , and the lower part will be used to **Align with Wall Below** . See “Editing Walls” on page 135 and “Aligning Walls” on page 138.

Windows and doors in pony walls are visible in floor plan view regardless of which part of the pony wall displays. If a window or door is completely contained by one part of a pony wall, it will display in floor plan view if the

other part of the pony wall is shown; but the wall’s layer fill pattern or Hatch Wall fill pattern will display over it.

## Changing Wall Types

The default upper and lower parts of a pony wall can be specified in the **Pony Wall Defaults** dialog. See “Pony Wall Defaults” on page 121.

The upper and lower parts of a pony wall can be redefined as different wall types in the **Wall Specification** dialog. See “Wall Types Panel” on page 150.

Note: The only way to control the materials displaying on a pony wall is by changing the wall types.

---

## Room Dividers and Invisible Walls



The **Room Divider** tool is used to define separate room areas in a plan; typically, by dividing a large room area into two or more smaller areas. See “Room Definition” on page 160.

Common uses for Room Dividers  include dividing areas of an open floor plan into areas with different purposes.

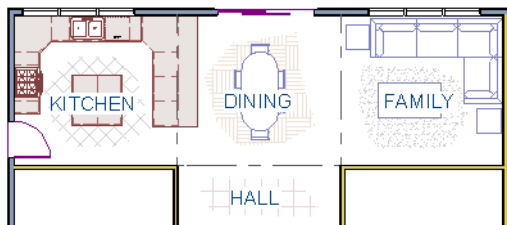

*Room Dividers separate this dining area from adjacent rooms*

Room Dividers can also be used to define areas with different floor or ceiling materials or heights.

**Room Dividers**  are simply walls that are specified as Invisible and have a single layer of an “Air Gap” material with a thickness of 0” (mm).

If a zero-thickness **Room Divider**  separates two rooms with different floor and/or ceiling heights, its wall type will be changed to the current plan’s default Interior Wall so that the platform step created by the height difference can be enclosed.

Any wall, regardless of its wall type or thickness, can also be specified as Invisible - or vice versa - in the **Wall Specification** dialog. See “General Panel” on page 147.

Room Dividers are placed on the “Walls, Invisible” layer by default, as are walls that are specified as Invisible.

Walls specified as Invisible can display in floor plan view but not in 3D views or the Materials List. See “Displaying Walls” on page 132.

It is not possible to place doors, windows, or fireplaces into an Invisible wall; however, if a wall with openings in it is specified as Invisible, any openings in it will remain.

## Important Notes on Invisible Walls

- Floor, wall and ceiling areas are calculated separately for rooms divided by Invisible walls.
- Invisible walls are ignored by the **Auto Place Outlets**  tool; it functions as though they were not present.
- Cabinets, fixtures and furniture can be moved freely through Invisible walls.
- Invisible walls can be drawn through a cabinet to attach to the wall behind.
- Room Dividers are automatically generated to connect “island” rooms to the larger structure around them. See “Room Definition” on page 160.

## Polygon Shaped Decks



Select **Build > Railing and Deck > Polygon Shaped Deck** to open the **New Polygon Shaped Deck** dialog and create a polygon shaped deck with regular sides.

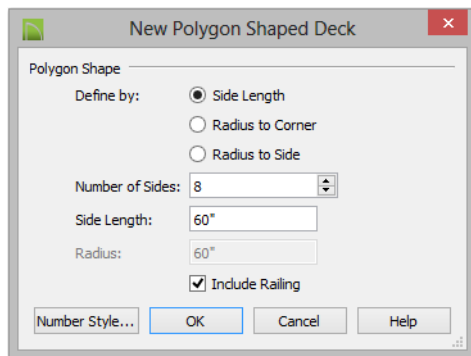

The settings in this dialog are saved between program sessions.

### *To create a polygon shaped deck*

1. Click the radio button beside an option to specify whether you want to **Define Polygon by Side Length, Radius to Corner** or **Radius to Side**.
2. Specify the desired **Number of Sides**.
3. Specify the desired **Side Length** or,
4. Specify the desired **Radius**.
5. Uncheck **Include Railing** to produce a deck platform defined by Deck Edges. This option is not available in the **New Polygon Shaped Room** dialog.
6. Click **OK**, then click once in floor plan view to create the specified polygon shaped deck.



## Hatch Wall

 The **Hatch Wall** tool can be used to fill wall segments with a single hatch pattern in floor plan view.

To apply wall hatching, select **Build> Wall>**

**Hatch Wall** , then click on a wall. The hatch pattern covers the entire length and width of the wall segment.

Note: The Hatch Wall tool cannot be used to apply a hatch pattern to Invisible Walls. See “Room Dividers and Invisible Walls” on page 127.

**Hatch Wall**  places a hatch pattern across all layers of the selected wall layers, covering any fill styles specified for that wall type.

In many cases, it is preferable to create a wall type definition rather than use the **Hatch**

**Wall**  tool because multiple fill styles can be used. See “Wall Type Definitions Dialog” on page 144.

Once created, wall hatching can be selected, edited and deleted much like other line-based objects. See “Editing Line Based Objects” on page 90.

If you use the **Hatch Wall**  tool to apply a hatch pattern to a wall that has been divided into multiple segments using the **Break**

**Wall**  tool, the pattern is only applied to the segment that you clicked on. See “Break Wall” on page 129.



Like doors and windows, wall hatching cannot extend across multiple wall segments. Unlike these objects, hatching cannot be located by dimension lines.

The wall hatch pattern can be specified in the **Wall Hatch Specification** dialog. See “Wall Hatch Specification Dialog” on page 157.

When editing or deleting wall hatching, make sure that it is selected rather than the wall by noting that “Wall Hatching” displays in the Status Bar. See “The Status Bar” on page 33.

## Break Wall

To divide a wall or railing, select **Build> Wall> Break Wall** and click on the wall. The wall is divided into two wall sections at the point where you click.

 The **Break Wall**  tool remains active, so you can continue to place breaks in walls. When you are finished, select a different tool.

If a wall break is placed near the intersection of two walls, the break is positioned at the center of the intersection.

Once a break is placed, click the **Select**

**Objects**  tool and select the original wall. If edit handles display near the break, the wall was correctly broken.

Walls separated by a break can be rejoined. Select one of the segments, then click on the

end edit handle located at the break and drag it a few plan inches (mm) away from the break. See “Connecting Walls” on page 131.

The **Break Wall**  tool can be used to create aligned walls on either side of a gap. See “Creating a Nook” on page 139.

---

## Drawing Walls

Walls, railings, and fencing are drawn similar to the way CAD lines are drawn: select a Wall Tool and then click and drag from end to end in the drawing area. Walls can be drawn in floor plan view, camera views, and overviews. See “Draw Lines” on page 511.

Drawing walls to create a floor plan is simple if you keep a few things in mind:

- Draw exterior walls first to define the building’s footprint, then draw the interior walls after the perimeter is in place.
- It is easiest to draw walls at the approximate location and length needed and then move or resize them precisely using dimensions later. See “Moving Objects Using Dimensions” on page 494.
- When drawing and positioning exterior walls, make sure **Grid Snaps**  are enabled. Once these walls are in place, you may prefer to turn Grid Snaps off to draw and position interior walls and other objects. See “Grid Snaps” on page 81.
- As walls are drawn, “sticky” points identify points that are either collinear or orthogonal to the end points of other walls, making alignment easier. See “Extension Snaps” on page 81.
- When walls enclose an area to form a room, the program will orient all exterior walls so that the siding material faces outward. See “Wall Type Definitions” on page 142.

- To flip the layers of a wall after it is drawn, select it and click the **Reverse Layers**  edit button. See “Editing Walls” on page 135.
- Initial wall heights are determined by the default floor and ceiling heights of the current floor.

### Wall Positioning

The recommended method of drawing walls is to draw them at their approximate location and length, then move them into position with accuracy using dimensions. To make this task quick and efficient:

- Notice the temporary wall that displays as you draw. Its length and angle display in the Status Bar at the bottom of the window and adjust as you move the mouse. Release the mouse button to draw the wall at the displayed length and angle. See “The Status Bar” on page 33.
- Use Snaps to help ensure proper wall alignment and orientation. See “Snap Behaviors” on page 80.

Once walls are drawn, they can be accurately dimensioned and moved as needed. See “Measuring Walls” on page 134.

### Wall Openings

To create a door or doorway, do not draw wall sections with a gap between them. Walls

should be drawn to completely enclose rooms, and then door and window objects should be placed in the walls to create openings later. See “Doors” on page 179 and “Windows” on page 197.

Masonry fireplaces placed in walls are also considered to be wall openings. See “Fireplaces” on page 237.

## Temporary Dimensions

Temporary dimensions will display along the length of a wall as it is drawn, helping you draw walls to the desired length. Although dimensions display as you are drawing, you do not need to position walls precisely when you first draw them: they can be easily moved into place at any time. See “Editing Walls” on page 135.

## Drawing Curved Walls

Drawing a curved wall, curved railing, or curved fence is similar to drawing a CAD arc. See “Draw Arc” on page 512.

A straight wall can also be converted into a curved wall and vice versa using the **Change Line/Arc**  edit button. See “Change Line/Arc” on page 114.



To create a room in the shape of a circle, you must draw two curved walls.

## Space Planning Assistant



The **Space Planning Assistant Tools** allow you to place and arrange room boxes that can then be converted into a fully editable house plan, including walls. See “Space Planning” on page 523.

---

## Connecting Walls

When walls are drawn sufficiently close to one another, they will snap together to form an intersection. This snapping occurs when the walls’ center lines are within a distance defined by the larger of the two walls’ widths and will occur even when **Object Snaps** are turned off. See “Object Snaps” on page 80.

If the two walls in question have identical specifications and are collinear, they will merge to become a single wall. See “Aligning Collinear Walls” on page 138.

When three or more walls connect to form a completely enclosed area, that area defines a room. See “Rooms” on page 159.

When walls snap together to form an intersection and **Object Snaps** are enabled,

the program joins them at their Main Layers. See “Aligning Walls” on page 138.

- The wall that is being drawn or edited will move, lengthen, or shorten slightly to meet the other wall.
- The other wall will not move; however, its length may be affected.

## Fix Wall Connections

Occasionally, intersecting walls may not properly connect. When this is the case and the connection in question is on the current floor, a circle will display at its location and the **Connect Walls**  icon will display near your mouse pointer.

## Removing Wall Breaks

The **Break Wall**  tool allows you to break a wall into two or more separate wall segments. See “Break Wall” on page 129.

To merge two collinear walls separated by a break, select one of the segments, then click on the end edit handle located at the break and drag it a few plan inches (mm) away from the break.

If the two walls do not merge, either one or both walls have been moved and they are no longer collinear, or one or both has been edited in some way and they are no longer identical. Open the **Wall Specification** dialog for each wall and determine how they differ. See “Wall Hatch Specification Dialog” on page 157.

---

## Displaying Walls



While the structure and appearance of each wall type is controlled in the **Wall Type Definitions** dialog, the display of walls in all views is controlled in the **Display Options** dialog. See “Displaying Objects” on page 76.

If a “Walls” layer is turned off, any doors and windows placed in walls on that layer will not display, either. See “Displaying Doors” on page 182 and “Displaying Windows” on page 202.

### In Floor Plan View

The appearance of each wall type, including line weights and colors and wall layer fill styles, is specified in the **Wall Type Definitions** dialog. See “Wall Type Definitions Dialog” on page 144.

There are also several options for controlling how walls are displayed in floor plan view. In the **Display Options** dialog, you can specify whether or not various types of walls display. Walls are placed on layers with “Walls” at the beginning of the layer name, such as “Walls, Normal”.

Note: In floor plan view, railings not specified as Solid display their Main Layer regardless of whether “Walls, Layers” or “Walls, Main Layer Only” is turned on.

Either the upper or lower portion of a Pony Wall can display in floor plan view. Only the portion that displays can be snapped to or aligned with walls above or below. See “Pony Walls” on page 126.

It is sometimes helpful to display the walls from a floor other than the current floor. To do this, select and display a reference floor. See “The Reference Floor” on page 225.

### In 3D Views

As in floor plan view, the display of walls can be controlled by layer in the **Display Options** dialog.

Each layer of a wall is generated when you create a 3D view. You can see the different layers in 3D using the **Delete Surface**  tool. See “Delete 3D Surface” on page 455.

While most architectural objects in the program can display in both floor plan and 3D views, a few cannot. Invisible walls and Wall Hatching are examples of objects that do not display in 3D.

## Wall Materials

There are several ways that materials can be assigned to walls, depending on how the walls and the rooms they define have been defined. See “Rooms” on page 159.

When you draw a wall, it uses the materials specified in its wall type definition. See “Wall Type Definitions” on page 142.

You can change the surface material of an individual wall in the **Wall Specification** dialog. If you select “Use Default” as the material and the wall is used to define a room, the program refers to the material specified in the **Room Specification** dialog. See “Wall Specification Dialog” on page 146.

You can also change a room’s wall material in the **Room Specification** dialog. See “Materials Panel” on page 420. To restore the default Wall Type material, select **Use Default** in the **Select Material** dialog. See “Select Material Dialog” on page 422.

Wall materials can also be changed using the **Material Painter**  tool, but bear in mind that depending on which Material Painter Mode is in use, only a portion of the wall may be painted and that the entire room may be affected rather than the individual wall. See “Material Painter and Walls” on page 419.

Note: Wall materials that are specified on the Materials panel of either the Wall or Room Specification dialog are not calculated in the Materials List.

## In the Materials List

The materials that make up wall assemblies are listed under different Categories in the Materials List:

- **Siding** - Lists all materials located outside of each wall’s Main Layer, such as siding, sheathing, and housewrap.
- **Framing** - Lists the Main Layer material(s) for all walls as well as railings specified as Solid. Non-framed walls’ Main Layer materials are also listed here when those walls are not specified as Foundation.
- **Insulation** - Insulation is calculated for all exterior walls that are not specified as Railing, regardless of the wall type definition.
- **Wallboard** - Lists all materials located inside of each wall’s Main Layer, such as drywall. Includes all materials aside from framing, concrete, and rebar in walls that do not define rooms.

Does not include Wall Coverings or materials specified in either the **Room** or **Wall Specification** dialog. See “Materials Panel” on page 154.

- **Interior Trim** - Lists base, crown and chair rail moldings, and Wall Covering materials specified in the **Wall** and **Room Specification** dialogs. See “Wall Covering Panel” on page 152.

- **Foundation** - Lists the concrete for all walls specified as Foundation as well as their footings. See “Foundation Walls” on page 126.

With the exception of wallboard, windows and doors are taken into account in the calculation of these totals.

Additional wall-related information is listed in the **General** category, including the total

linear feet of each wall type per floor and the thermal envelope wall area per floor. See “Conditioned Area” on page 586.

A wall type’s Main Layer plays a central role in determining how wall materials are calculated. For this and other reasons, correct Main Layer assignment is very important. See “The Main Layer” on page 142.

---

## Measuring Walls

Accurate wall measurements are an essential aspect of any drawing, and can be achieved by following two basic rules:

- Be aware of what part of a wall assembly dimensions are locating;
- Position walls using dimensions rather than edit handles or edit tools.

These rules can easily be met when you keep the following recommendations in mind.

### Use Dimension Defaults

Dimensions can be set to locate walls at their Dimension Layers or at their surfaces.

Before drawing dimensions - and particularly, before using them to move your walls into position - make sure that your Dimension Defaults are set up to meet your needs. See “Dimension Defaults Dialog” on page 485.

If a wall is specified as Invisible, dimensions will locate it at its centerline regardless of your Dimension Defaults settings. If the Invisible wall divides rooms with different floor heights, dimensions will locate the edge of the wall facing the room where the floor is lower.

### Edit Dimension Lines

Once a dimension line has been drawn, its extension lines can be edited to locate a number of locations on a wall assembly:

- The exterior surface
- The Main Layer’s exterior
- The center line of the wall assembly
- The Main Layer’s center line
- The Main Layer’s interior
- The interior surface

See “Editing Extension Lines” on page 493.

### Moving Walls Using Dimensions

By far, the most precise method of positioning walls is using dimension lines. To produce accurate measurements, remember to:

- Be aware of what part of your walls is being located by dimensions.
- Avoid specifying dimension values with greater accuracy than your dimensions are

set to display. See “Format Panel” on page 487.

See “Using Dimensions” on page 136.

## Use Object, Angle and Grid Snaps

Object Snaps, Angle Snaps, and Grid Snaps make it easier to align walls when they are being drawn as well as when they are edited. See “Snap Behaviors” on page 80.

**Object Snaps** help to ensure consistent wall connections and are particularly helpful when aligning collinear walls.

When **Grid Snaps** are enabled, walls are drawn on a regularly spaced grid, which helps avoid inaccurate wall placement. This can become particularly important if you forego positioning walls using dimensions in favor of using edit handles to move them.



Using Grid Snaps is recommended when you are laying out exterior shell walls, but may be inconvenient when positioning interior walls or other objects.

**Angle Snaps** make it easy to accurately draw walls at regular angles, ensuring walls that are truly parallel or perpendicular to one another and separated by consistent distances.

## No Locate

If a wall is specified as **No Locate** in the **Wall Specification** dialog, it will be ignored by **Auto Exterior Dimensions**  in floor plan view, as will any doors or windows placed in it. See “Dimensions” on page 485.

By default, **Railings**, **Deck Railings**, and **Room Dividers** are specified as No Locate. See “General Panel” on page 147.



Once a dimension line has been created, it can be edited so that it locates a No Locate wall or railing that is perpendicular to it. See Editing Dimension Lines.

## Editing Walls

Walls can be selected individually and as a group in all views. When a wall is selected, it displays edit handles and an edit toolbar that can be used to edit it in various ways. When a wall is selected, temporary dimensions will also display.

The ways in which a wall can be edited depends on the current view and which edge is selected. See “Selecting Objects” on page 88.

## Selecting Walls

- When you try to select a wall in a 3D view, the interior or exterior room that it defines may be selected first. Click the **Select Next Object**  edit button or press the Tab key on your keyboard to select the wall itself.
- In floor plan view, if wall hatching has been applied to a wall using the **Hatch Wall**  tool, the hatching may be

selected first. Click **Select Next**

**Object**  to select the wall itself. See “Hatch Wall” on page 129.

## Using the Edit Handles

A selected wall can be modified in a variety of ways using its edit handles in any view. The handles that are available will depend on the current view type.

- In floor plan view, straight and curved walls can be edited like other line- and arc-based objects. See “Editing Line Based Objects” on page 90 and “Editing Arc Based Objects” on page 92.
- In a camera view or overview, click on the top surface of a wall to display the same edit handles as in floor plan view, allowing you to rotate, move, and extend or shorten the length of the wall.
- Moving a wall in any view will move any cabinets attached to that wall, as well.
- In an Elevation view, the side edges of straight walls can be moved to shorten or lengthen the segment. Curved walls can be shortened in this manner, but not lengthened.
- In a camera view or overview, click on an interior or exterior surface to display an edit handle at the center of each side edge, allowing you to shorten or lengthen the wall. Curved walls can be shortened in this manner, but not lengthened.
- When a wall is connected to other walls, it can only be moved perpendicular to itself or, in the case of curved walls, perpendicular to its chord using the Move edit handle.

## In the Specification Dialog



The appearance and structure of walls can be customized in the **Wall Specification** dialog. See “Wall Specification Dialog” on page 146.

The characteristics of the roof directly above a selected wall can also be specified in the **Wall Specification** dialog. See “Roof Panel” on page 148.

## Using the Edit Tools







A selected wall or walls can be edited in a variety of ways using the buttons on the edit toolbar. See “The Edit Toolbar” on page 28.

## Using Dimensions



Automatic, manually-drawn, and temporary dimension lines can be used to both resize and move walls with accuracy. Select a wall, then click on a dimension line that locates it and type in the value that you need. See “Moving Objects Using Dimensions” on page 494.

When a wall is resized using dimensions, the inline text field used to edit the dimension will have three unique buttons:

- Horizontal walls have **Move Left End** , **Move Both Ends** , and **Move Right End** .
- Vertical walls have **Move Top End** , **Move Both Ends** , and **Move Bottom End** .

Choose the option that you want to use before pressing the Enter key.



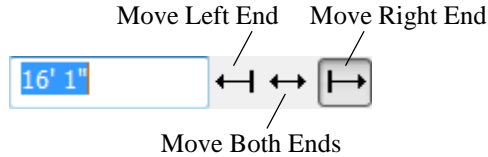

If both ends of the selected wall intersect walls that are not parallel to one another, a fourth option will be available: **Move Along**

**Rails** . When this option is used, the selected wall both resizes and changes position so that it remains connected to the other walls when you press the Enter key.

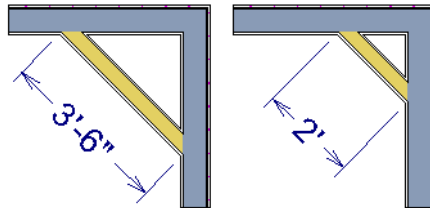

*Move Along Rails resizes and moves a selected wall.*

Depending on your **Dimension Defaults** settings, dimension lines may locate wall surfaces or Main Layers. See “Dimension Defaults Dialog” on page 485.

## Wall Thickness

The initial thickness of a wall is determined by its wall type definition. You can change a wall’s thickness by modifying the definition of its wall type. If you do this, all instances of the wall type used in the plan will be affected - not just an individual object. See “Wall Type Definitions” on page 142.

You can also specify a selected wall’s thickness in its **Wall Specification** dialog. See “General Panel” on page 147.

If a selected wall’s thickness is changed:

- A copy of the wall’s wall type is created with the same name but appended with a number equal to the thickness of the Main Layers, and that new type is assigned to the wall. See “The Main Layer” on page 142.
- The change in thickness will be applied to new wall type’s innermost Main Layer.
- The Main Layer must be at least 1/16” thick, and the wall’s thickness cannot be less than the original wall type’s total thickness minus the thickness of its Main Layer.

If a wall type’s thickness is modified, the wall will resize about the outside edge of its Main Layer. In some instances, the wall may appear to move as a result of changes made to the thicknesses of its layers.

## Wall Heights

The height of a wall is controlled by the ceiling height of the room(s) it defines. If the ceiling or floor height of a room is changed, the height of the walls that define it also change.

- The initial ceiling height for all rooms on a floor is set in the **Floor Defaults** dialog for that floor. See “Floor Defaults” on page 160. Whenever possible, it is best to set all ceiling heights using the default.
- The ceiling height of a single room can be set in its **Room Specification** dialog. See “General Panel” on page 172.
- The height of the edge dividing an upper and lower pony wall can be defined in the **Wall Specification** dialog. See “Wall Types Panel” on page 150.

## Wall Length

Wall length can be modified in several different ways:

- Using dimensions. See “Measuring Walls” on page 134.
- In the **Wall Specification** dialog. See “General Panel” on page 147.
- By dragging the end edit handles. See “Editing Line Based Objects” on page 90 and “Editing Arc Based Objects” on page 92.

Bear in mind that if you try to resize a wall by a small amount using one of its edit handles and that wall is connected to another wall at that end, its length will not change because its end will snap back to the existing intersection. See “Connecting Walls” on page 131.

The most accurate way to specify wall length is using dimensions. By default, wall length is measured at the outside edge of the Main Layer. You can instead specify that dimension lines locate surfaces in the **Dimension Defaults** dialog. See “Dimension Defaults Dialog” on page 485.

---

## Editing Straight/Curved Wall Combinations

If you move a straight wall connected to a curved wall with a locked center, the curved wall extends along its curve and the straight wall will either lengthen or shorten as needed to stay connected to the curved wall.

If the connection between the straight and curved wall cannot be maintained because of the curved wall’s radius, it will be broken.

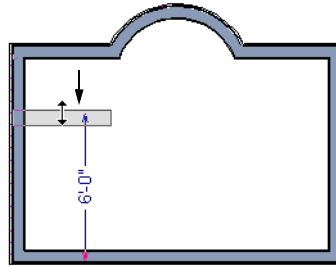

---

## Aligning Walls

Wall alignment refers to the way wall segments line up with one another, either on the same floor or on the floor above or below. Walls may need to be aligned in a variety of situations.

To make alignment easier when drawing or resizing walls, “sticky” points identify points that are either collinear or orthogonal to the

end points of other walls. See “Extension Snaps” on page 81.

### Aligning Collinear Walls

Collinear walls are parallel walls connected end to end and drawn on the same floor. When collinear walls join end-to-end, the walls snap together. If these walls have the same wall type and identical specifications,

and if **Object Snaps** are enabled, they will merge to become a single wall segment.

### Creating a Nook

Walls can be aligned across an opening such as a nook, so that they are collinear, using the **Break Wall**  tool.

#### *To align walls across a gap*

1. Select a wall to build a nook into and click the **Break Wall**  edit button.
2. Click at a point on the wall close to one side of the nook area. Do not worry about exact placement right now.
3. Click again near the other side of the nook. Two short lines at each location where you clicked indicate Wall Breaks.

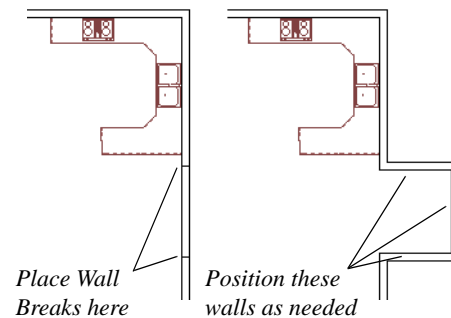

4. Right-click the middle section of the wall to select the wall section.
5. Click the middle Move handle and drag the wall outward.
6. Draw side walls to connect the wall back to the rest of the house.
7. Move these short walls using dimensions to accurately size the nook.

## Aligning Walls Between Floors



Walls can be aligned between floors by clicking the **Align With Wall Above**  and **Align With Wall Below**  edit buttons.

Walls on different floors are aligned by the outer edges of their Main Layers. See “The Main Layer” on page 142.





In order for these edit tools to be available, the areas of the walls in question must be partially aligned, or overlapping.

#### *To align walls between floors*

1. Select a wall that you want to align with another wall either above or below it.
2. If the wall is above or below the other wall along only part of its length, you must click on it along that part. Select **Tools > Reference Floors > Reference Display On**  to help make sure you click on the correct part of the wall.
3. When you have selected the wall at the desired location, click either the **Align With Wall Above**  or **Align With Wall Below**  edit button.



## Aligning Curved Walls Between Floors

Curved walls are aligned between floors using the same technique to align straight walls. If the centers and radii of the walls are within a few inches of each other, the **Align With Wall Above**  and **Align With Wall Below**  edit buttons are enabled for the

selected wall. The selected curved wall will take on the radius and center of the referenced wall when the walls are aligned.

### Aligning Pony Walls Between Floors

When aligning a pony wall with either the wall above or below:

- **Align With Wall Below**  will always align the lower pony wall with the wall below, as specified in the lower pony wall's Wall Type Definition. See "Wall Type Definitions" on page 142.
- **Align With Wall Above**  will always align the upper pony wall with the wall above, as specified in the upper pony wall's Wall Type Definition.



---

## Roof Directives in Walls

To automatically generate a roof plane using values other than the defaults or to not generate a roof plane bearing on a particular wall (as for a gable or the sides of a shed roof), you can change the settings in the **Wall Specification** dialog. See "Roof Panel" on page 148.

### Hip, Gable, and Shed Roofs

By default, the program will produce a roof plane over each exterior wall to create a hip roof. You can instead specify a gable or shed roof above the selected wall.

- Check **Full Gable Wall** to create a gable with a ridge centered above the selected wall(s).
- Check **High Shed/Gable Wall** for the side walls or the wall under the high side of a shed roof.
- You can also select a wall and click the **Change to Gable Wall(s)**  edit button, or change it back by clicking the **Change to Hip Wall(s)**  edit button.

### Pitch

The default pitch for roof planes is set in the **Build Roof** dialog. However, any exterior wall can define the pitch of the roof plane built above it.

You can also specify a second, upper pitch above a given wall. Mansard, gambrel, gull wing and half-hip are examples of roof styles that use two pitches. See "Roof Tutorial" on page 55 of the User's Guide.

### Roof Returns

Check **Auto Roof Return** to generate roof returns on the selected wall. In most cases, roof returns only generate on Full Gable Walls. See "Roof Returns" on page 257.

### Extend Slope Downward

Check **Extend Slope Downward** to extend the roof plane downward over a bump out, instead of creating additional roof planes. The two connecting walls that create the bump out must be Full Gable walls.

In the following image, the bearing wall of the bump out has **Extend Slope Downward**

checked. The two short side walls are **Full Gable Walls**.

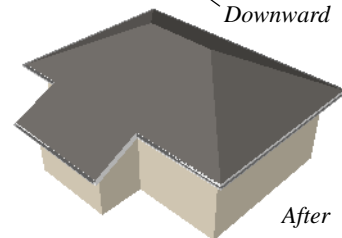
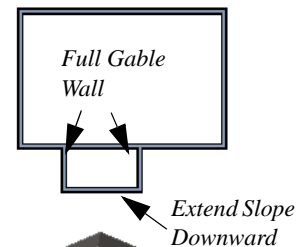
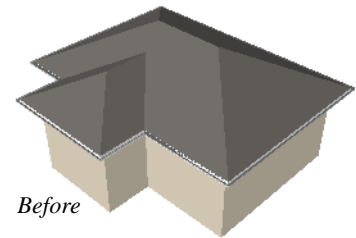

---

## Attic Walls

In Home Designer Architectural, walls are built between the floor and ceiling platforms of the current floor. See “Floor and Ceiling Heights” on page 168. When the program detects an open space between a wall and the roof plane above it, it automatically creates an Attic Wall on the floor above that wall to fill in the gap.

Attic Walls are typically found above Full Gable Walls, forming a gable or closing the top portion of a side wall of a shed roof. Attic Walls are often found on the Attic floor, but

can be generated on other floors, as well. See “The Attic Floor” on page 225.



If you do not want to keep a particular Attic Wall in your plan, specify it as Invisible. See “Room Dividers and Invisible Walls” on page 127.

### Removing Attic Walls

Occasionally, the program will generate an Attic wall where one is not wanted. There are several ways to address this:

- Turn off the display of the “Walls, Attic” layer.
- Specify the Attic Wall as **Invisible**. See “Room Dividers and Invisible Walls” on page 127.
- Select the Attic Wall and **Delete**  it. The program will specify the wall as Invisible automatically. If you delete this Invisible wall, a new Attic Wall will be created.

## Knee Walls

Knee Walls are a bit like Attic Walls in that they are not meant to generate to full ceiling height. Instead, they build upward until they encounter a roof plane. Unlike Attic Walls,

however, Knee Walls are used in the interior of a structure, typically to separate unused areas from rooms on the upper floor of a story-and-a-half structure. See “Room Types” on page 164.

Home Designer Architectural does not specify walls as Knee Walls automatically. If an interior wall is drawn in a location where the roof is lower than the ceiling height, you should specify it as a Knee Wall in the **Wall Specification** dialog. See “Roof Panel” on page 148.

For best results, Knee Walls should be drawn perpendicular to the pitch of the roof and should intersect with Full Gable Walls on each end.

---

## Wall Type Definitions

Every wall drawn in a plan is assigned a wall type, and its Wall Type Definition determines its structure, its appearance in floor plan view, and its default materials. Wall types can be viewed, edited, and created in the **Wall Type Definitions** dialog. See “Wall Type Definitions Dialog” on page 144.

Walls can have up to ten layers defined, each representing a different material. All of these layers can be calculated in the Materials List. The materials assigned to the surface layers of the wall type definition also determine the wall’s appearance in 3D views. See “Materials Lists” on page 579.



Wall framing will only generate in a wall when a Framing material such as Fir Stud 16” OC or Metal Stud 24” OC is specified for its framing layer.

You can specify the default wall type that is drawn by the Exterior, Interior Wall and Pony Wall tools and can specify the wall type of any wall after it is drawn in the **Wall Specification** dialog. See “Wall Defaults” on page 120 and “General Panel” on page 147.

The structural layer of a wall type is its Main Layer, which controls a number of things:

### The Main Layer

In most circumstances, each wall type’s Main Layer should be specified as the structural layer. The Main Layer determines many things, including:

- Floor and ceiling platforms and automatically built foundation walls normally build to the outer edge of the Main Layer.

- At intersections, walls join at the interior surfaces of their Main Layers. See “Connecting Walls” on page 131.
- Windows are placed relative to the outer surface of the outermost Main Layer.
- Exterior walls on different floors are aligned by the exterior edges of their outermost Main Layer.
- Roof baselines are placed at the outer edge of the outermost Main Layer.
- Roof baselines and gable/roof lines that are manually drawn snap to the outermost edge of the Main Layer.
- Walls resize about the exterior surface of their Main Layers when their thickness, wall type, or Wall Type Definition is changed.
- Object Snaps locate the interior and exterior edges of a wall’s Main Layers. See “Object Snaps” on page 80.
- By default, dimension lines locate walls at their Main Layer. See “Dimension Defaults Dialog” on page 485.

All of this information is reliant on the Main Layer, so creating your wall type definitions accurately beforehand and specifying the Main Layer correctly is very important.

### Multiple Main Layers

In standard light frame construction, walls build to one another’s framing layers, and floor and ceiling platforms are built to bear over the wall framing; however, some building techniques configure these components in other ways. You can control how walls of a given type are intersected, and also where platforms build to, by specifying multiple Main Layers.

By default, when multiple Main Layers are specified:

- Intersecting walls build to the interior surface of the innermost Main Layer.
- Floor platforms build to the exterior surface of the outermost Main Layer.
- A selected wall’s edit handles display along the exterior of the outermost Main Layer.
- The exterior surface of the outermost Main Layer is the Dimension Layer

See “Wall Type Definitions Dialog” on page 144.

### Interior and Exterior Surfaces

Every wall has an interior and exterior surface - including walls in a plan that are recognized by the program as being interior walls. See “Exterior and Interior Walls” on page 125.

Having separate designations for a wall’s two surfaces allows you to specify different materials for each in the **Wall Specification** dialog. See “Materials Panel” on page 154.

In the **Wall Type Definitions** dialog, the exterior surface is shown at the top of the Wall Layers table. In floor plan view, you can identify a selected wall’s exterior surface by the location of its edit handles, which display on the exterior of the Main Layer.

### Legacy Wall Types

In Home Designer Architectural version 9 and prior, a generic, single-layer wall type was used as the default for railings, deck railings and fencing: the Adjustable Thickness Wall.

When plans that include this wall type - in the drawing itself or set as a default - are opened in Home Designer Architectural 2017, the legacy wall type is replaced by a new wall type named “Wall-X”, where X is the thickness of the wall’s Main Layer, rounded up. There are a few exceptions:

- If legacy wall types with the same thickness but different materials are found, they use the same naming convention appended with an additional \_X.
- If a wall using a legacy wall type is specified as a Foundation wall, the resulting wall type will be named “Foundation Wall-X”.
- If a legacy wall type has the same attributes as a wall type installed with Home

Designer Architectural 2017, such as 8” Concrete Stem Wall, it will be replaced by that wall type.

Unless a wall is specified as a Foundation wall, Deck Railing, or Fencing, it will be treated as a framed wall and its new wall type will acquire two additional 1/2” (13 mm) thick wall layers: an interior and an exterior layer. These new layers will use the interior and exterior materials of the original wall. The wall’s original layer will maintain its original thickness, acquire a framing material, and will become the new wall type’s Main Layer.

Foundation, Deck Railing, and Fencing wall types converted in this manner will continue to have only one layer.

---

## Wall Type Definitions Dialog



The **Wall Type Definitions** dialog is used to redefine existing wall types in the current plan file. Select **Build> Wall> Define Wall Types** to open this dialog.

You can also click the **Define** button on the GENERAL panel of the **Wall Specification** dialog. See “General Panel” on page 147.

Changes made to an existing wall type definition affect all walls in the current plan using that wall type. Walls in other plan files are unaffected.

If changes to a wall type affect its thickness, any walls in the plan using that wall type will resize about their exterior surfaces. The position of the exterior will be unchanged and other layers will move as required.



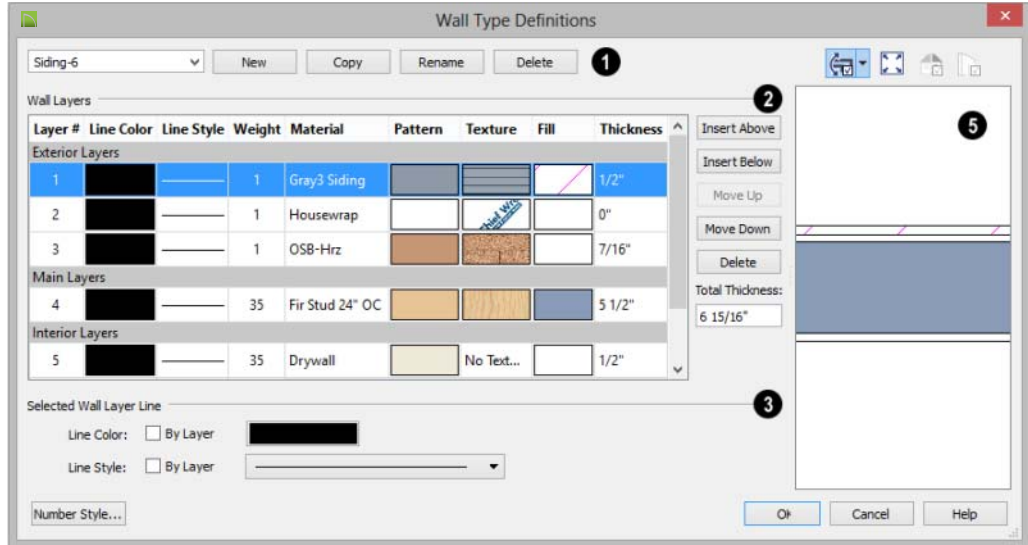

- 1** Manage the list of wall types available in the current plan.

  - Click the drop-down list to display all wall types in the current plan. Select a wall type from the list to display its definition. You can rename a wall type by typing in a new name. Note that wall type names in a plan must be unique.
  - To create a new wall type, click **New** to define a new wall type from scratch or click **Copy** to copy the current wall type. A copied wall type can then be renamed and redefined.
  - Click **Rename** to rename an existing wall type, or simply click on its name and type a new name.
  - To remove a wall type from the current plan, select it and click **Delete**. Wall types that are in use or set as plan defaults cannot be deleted.
- 2** The selected wall type's **Wall Layers** are listed here. Wall layers are listed from exterior at the top to interior at the bottom. The last item listed is the interior surface line rather than a true layer.

  - The list is divided into three sections: Exterior, Main, and Interior Layers. To move a layer from one section to another, use the Move Up and Move Down buttons to the right.
  - A wall type's thickest structural layer is typically set as the Main Layer; however, multiple Main Layers can be specified. See "The Main Layer" on page 142.
  - Click in the Texture column to open the **Select Material** dialog and choose a material for the selected wall layer. See "Select Library Object Dialog" on page 408.
  - Click in the **Fill** column to open the **Layer Fill Style** dialog and specify a fill style for the selected wall layer. This dialog is sim-

ilar to the **FILL STYLE** panel for CAD objects. See “Fill Style Panel” on page 519.

- Click in the **Thickness** column to type the selected layer’s thickness, or depth. Very thin layers can be created, but for best results, avoid using a thickness of 0.

The buttons on the right side of the table allow you to reorganize the wall type definition’s layers.

- Click the **Insert Above** button to create a new layer directly above, or outside, the selected layer in the wall type definition. The new layer is a copy of the original.
- Click the **Insert Below** button to create a new layer directly below, or inside, the selected layer in the wall type definition. The new layer is a copy of the original.
- Click the **Move Up** button to swap the selected layer’s position with that of the layer immediately outside of it or to move it into the layer section directly outside of it. Not available for the outer-most layer or for a single Main Layer.
- Click the **Move Down** button to swap the selected layer’s position with that of the layer immediately inside of it or to move it into the layer section directly inside of

it. Not available for the inner-most layer or for a single Main Layer.

- Click **Delete** to remove the selected layer from the wall type definition.
- The **Total Thickness** of the wall assembly displays here. If you change this value, the thickness of the Main Layer automatically updates to account for the difference.

**3** Specify the attributes of the **Selected Wall Layer Line**, which is the line defining the selected layer’s exterior.

- Define the **Color** and **Style** for the selected Wall Line.
- Check **By Layer** if you want the line to assume the attributes of the wall’s layer as defined in the **Layer Display Options** dialog. See “Displaying Objects” on page 76.

Wall layer fill styles are overridden if you use the **Hatch Wall**  tool on a wall in floor plan view. See “Hatch Wall” on page 129.

**4** A preview of the selected wall type definition displays here. See “Dialog Preview Panes” on page 32.

---

## Wall Specification Dialog



To open the **Wall Specification** dialog, select a wall and click the **Open Object** edit button.

The panels of the **Wall Specification** dialog are also found in the **Railing**, **Deck Railing**, and **Fencing Specification** dialogs. See “Railing and Fencing Specification Dialogs” on page 154.

## General Panel

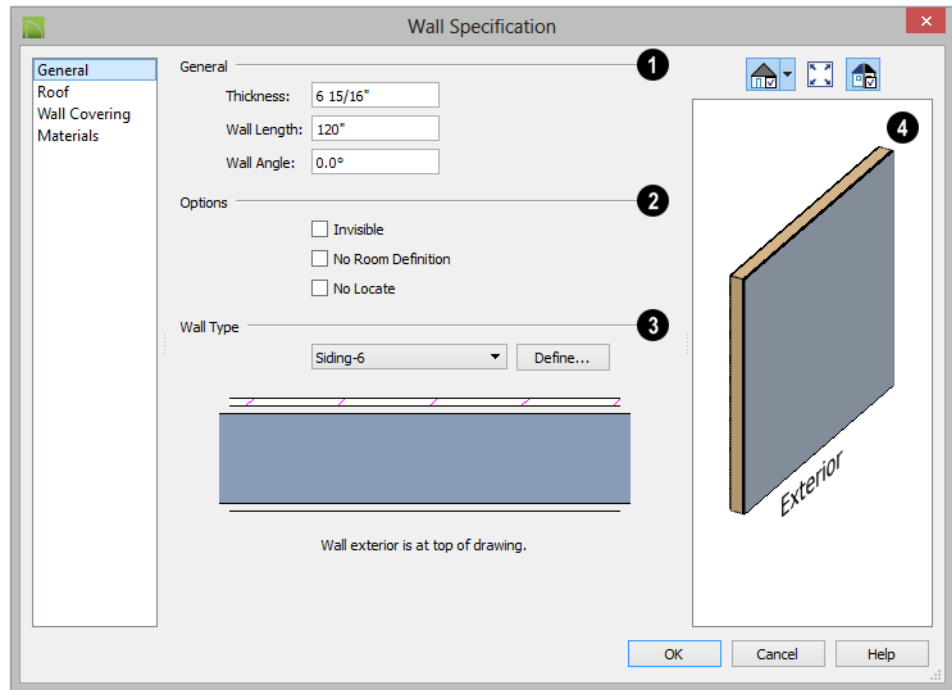

- 1 Specify **General** properties of the selected wall or railing.
  - The **Thickness** of the selected wall displays and can be changed here. If the wall is a Post to Overhead Beam railing, this setting also affects the width of the beam. See “Wall Thickness” on page 137.
  - **Wall Angle** - The current absolute angle of the wall in a floor plan view is shown. If you type in a new angle, any walls attached to it will not move. If the selected wall is curved, this value describes the angle of the chord and cannot be modified.
  - **Wall Length** - The current length is shown. If you type a new length, any walls attached to the selected wall will not move. If the selected wall is curved, this value cannot be modified.
- 2 Check any of the **Options** to modify the selected wall accordingly. In most cases, multiple options can be selected. Not available for fencing.
  - Check **Invisible** to specify the wall as invisible. Invisible walls can display in floor plan view but not in 3D views or the Materials List. **Room Dividers**  are invisible by default. See “Room Dividers and Invisible Walls” on page 127.
  - Check **No Room Def.** to display the wall in floor plan and/or 3D views but not cre-
- 3 The **Wall Type** dropdown menu is set to 'Siding-6'. A 'Define...' button is next to it. Below the dropdown is a 2D perspective drawing of a wall section with a blue face and a tan top edge.
- 4 A 3D perspective drawing of a wall section, showing a blue face and a tan top edge. The word 'Exterior' is written below the wall.

ate room definition. See “Room Definition” on page 160.

- Check **No Locate** to prevent **Auto Exterior Dimensions**  from locating the wall in floor plan view. See “No Locate” on page 135.

- 3 Select the **Wall Type** assigned to the selected wall from the drop-down list. A preview diagram of the selected wall

type’s layers, as seen in floor plan view, displays below.

- 4 A preview of the selected wall, including any doors, windows, and/or fireplaces inserted into it, displays on the right. If the selected wall is specified as Invisible, its plan view will display here by default. See “Dialog Preview Panes” on page 32.

## Roof Panel

Any automatically generated roof style other than a hip requires roof information to be defined in the exterior walls. On the ROOF panel, you can specify how the selected wall interacts with the roof plan, defining the portion of the roof plan that bears on it..

The ROOF panel is not available for Foundation Walls or Fencing. See “Foundation Walls” on page 126 and “Fencing Tools” on page 125.

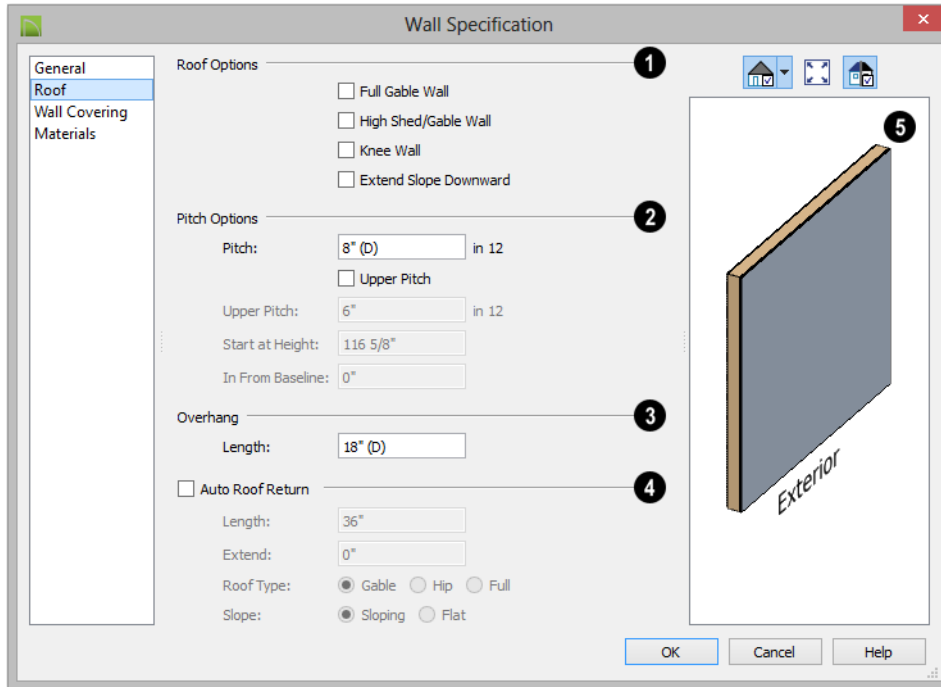

- 1 **Roof Options** - Specify the shape of the wall relative to the roof.
  - Check **Full Gable Wall** to create a gable end over the selected wall.
  - Check **High Shed/Gable Wall** to specify the selected wall as the high end of a shed roof.
  - Check **Knee Wall** to define the selected interior wall as a knee wall. Only an interior wall can be defined as a knee wall. A knee wall's height is defined by the roof above, not the ceiling height. See "Knee Walls" on page 142.
  - Check **Extend Slope Downward** to continue a roof down over a bump out in an exterior wall. See "Extend Slope Downward" on page 140.
- 2 **Pitch Options** - Specify the pitch or pitches of the roof plane(s) above the selected wall.
  - Enter a value to define the **Pitch** of the roof plane bearing on the selected wall.
  - Check **Upper Pitch** to create a roof with two pitches or, if the selected wall is a Full Gable Wall, a half hip condition.
  - Enter the **Pitch** of the second, upper roof.
  - Specify the **Height** that the Upper Pitch **Starts at**, or define the distance **in from**

**Baseline** that the second pitch begins. The two values are dynamic. Press the Tab key to update the relative numbers.

- 3 Specify the **Overhang Length**, which is the horizontal distance from the outside of the wall's Main Layer to the eave. See "Wall Type Definitions" on page 142.
- 4 Check **Auto Roof Return** to generate roof returns on the selected wall. In most cases, roof returns only work for Full Gable Walls. See "Roof Returns" on page 257.
  - Specify the horizontal **Length** of the roof return in inches (mm).
  - Enter a value in inches (mm) to **Extend** the roof returns past the overhang.
  - Specify a **Gable, Hip, or Full** roof return.
  - Specify a **Sloping or Flat** roof return.
- 5 A preview of the selected wall, including any doors, windows, and/or fireplaces inserted into it, displays on the right. See "Dialog Preview Panes" on page 32.



Additional information about using the settings on this panel can be found in the "Roof Tutorial" on page 55 of the Reference Manual.

## Foundation Panel

The FOUNDATION panel is only available for Foundation Walls and Pony Walls. See

"Foundation Walls" on page 126 and "Pony Walls" on page 126.

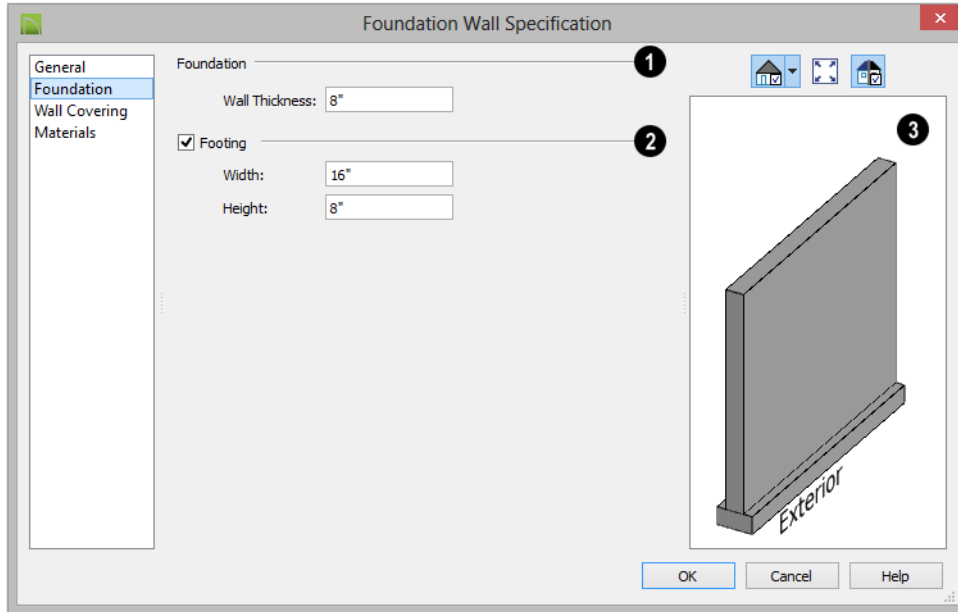

- 1 Specify the **Foundation** properties of the selected wall.
  - The **Thickness** of the selected wall displays and can be changed here.
- 2 Check **Footing** to assign a concrete footing to the selected wall(s) and enable the settings below. Only available when Foundation Wall is checked, above.
  - Specify the **Width** and **Height** of the footing below the selected foundation wall
- 3 A preview of the selected wall, including any doors, windows, and/or fireplaces inserted into it, displays on the right. See “Dialog Preview Panes” on page 32.

## Wall Types Panel

The WALL TYPES panel is only available for Pony Walls. See “Pony Walls” on page 126.

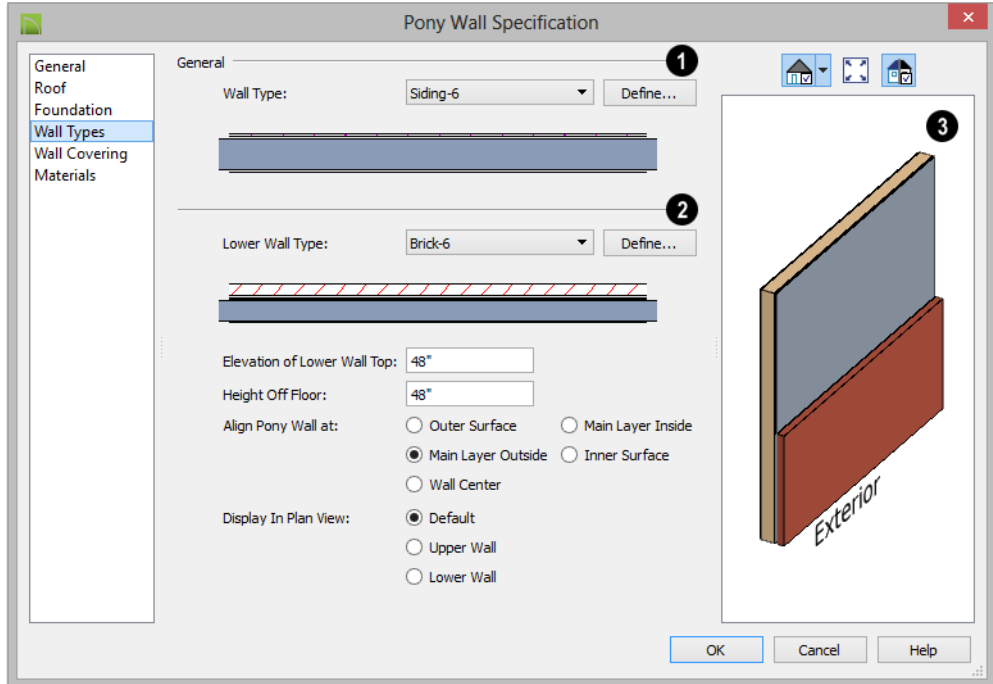

- 1 Choose the selected wall's **Wall Type** from the drop-down list of all currently available types. A preview of the selected wall type displays below the drop-down list.
  - Click the **Define** button to open the **Wall Type Definitions** dialog to create or modify existing wall types. See “Wall Type Definitions Dialog” on page 144.
- 2 Select the **Lower Wall Type**, the wall type of the lower portion of the pony wall, from the drop-down list. A preview of the selected wall type displays directly below.
  - Click the **Define** button to open the **Wall Type Definitions** dialog.

Specify the height of the division between the upper and lower walls. These two

settings are dynamic: if one is changed, the other will update accordingly.

- Specify the **Elevation of Lower Wall Top**, which is the division between the upper and lower walls. This is an absolute value: regardless of the wall's location, it is always measured from 0" (mm) - the default floor height for Floor 1. See “Floor Defaults Dialog” on page 220.
- Specify the **Height Off Floor** of the division between the upper and lower walls. This value is measured from the floor height of the room(s) defined by the selected wall. If the wall defines rooms with different floor heights, “No change” will display.

**Align Pony Walls** - Specify how the layers of the selected wall's Upper and Lower portions align.

- Select **Outer Surface** to align wall types at their outer surfaces.
- Select **Main Layer Outside** to align wall types at the exterior edge of their main layers.
- Select **Wall Center** to align the centers of the main layers of both wall types.
- Select **Main Layer Inside** to align the wall types at the interior side of their main layers.
- Select **Inner Surface** to align wall types at their interior surfaces.
- **No Change** is used by default when multiple pony walls with different alignment settings are selected. Choose this to leave

the alignment as it was when the dialog was opened.

Specify which part of the pony wall you would like to **Display in Plan View**. See "Displaying Pony Walls" on page 126.

- Select **Default** to display the portion of the pony wall specified in the **Pony Wall Defaults** dialog.
- Select **Upper Wall** to display the upper portion of this pony wall in floor plan view regardless of the default setting.
- Select **Lower Wall** to display the lower portion of this pony wall in floor plan view regardless of the default setting.

**3** A preview of the selected wall, including any doors, windows, and/or fireplaces inserted into it, displays on the right. See "Dialog Preview Panes" on page 32.

## Wall Covering Panel

The WALL COVERING panel is also available in the **Room Specification** dialog. See Room Specification Dialog.



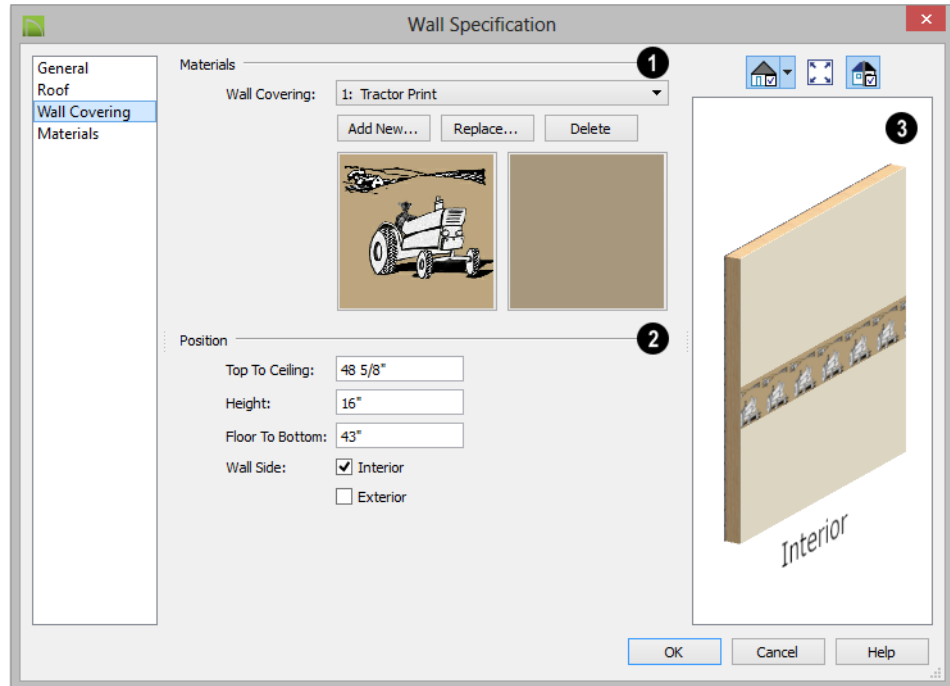

1 All wall covering materials applied to the selected wall are listed here. Select one from the drop-down list to edit its position or remove it from the wall.

- Click **Add New** to apply a new wall covering to the selected wall. See “Select Library Object Dialog” on page 408.
- Click **Replace** to replace the current wall covering with a new one from the library.
- Click **Delete** to remove the current wall covering from the selected wall.

Preview panes showing the current wall covering display the row of buttons.

2 Specify the **Position** of the selected wall covering.

- Enter the heights of the current wall covering’s **Top To Ceiling** and **Floor To Bottom**. The wall covering’s **Height** from its top edge to its bottom edge can also be specified.
- Check **Interior** and/or **Exterior** to apply the wall covering to the inside and/or outside of the selected wall. Interior is checked by default. Not available for rooms. See “Wall Type Definitions” on page 142.

3 Most wall coverings are best previewed using the Standard Rendering Technique. See “Dialog Preview Panes” on page 32.

## Rail Style Panel

The RAIL STYLE panel is only available for Railings, Half Walls, Deck Railings, and Fencing. See “Rail Style Panel” on page 154.

## Newels/Balusters Panel

The NEWELS/BALUSTERS panel is only available for Railings, Half Walls, Deck Railings, and Fencing. See “Newels/Balusters Panel” on page 156.

## Materials Panel

All walls - including interior walls, railings and fencing - have an “Exterior Wall

Surface” and an “Interior Wall Surface”. See “Interior and Exterior Surfaces” on page 143.

The materials specified on the MATERIALS panel affect the appearance of walls and Solid Railings in 3D views but are not calculated in the Materials List. See “Materials Lists” on page 579.

For most railing types, the “Exterior Wall Surface” component only affects the appearance of the floor platform under the railing, and “Interior Wall Surface” component is not used. For fencing, neither material component is used.

---

## Railing and Fencing Specification Dialogs



To open the **Railing** or **Fencing Specification** dialog, select a railing or fencing and click the **Open Object** edit button.

The **Railing** and **Fencing Specification** dialogs are the same as the **Wall Specification** dialog, but have two panels that apply only to Railings, Half Walls, Deck Railings, and Fencing. See “Wall Specification Dialog” on page 146.

## Rail Style Panel

The RAIL STYLE panel is only available for Railings, Deck Railings, and Fencing. See “Railing and Deck Tools” on page 123,

“Fencing Tools” on page 125, and “Fencing Tools” on page 125.

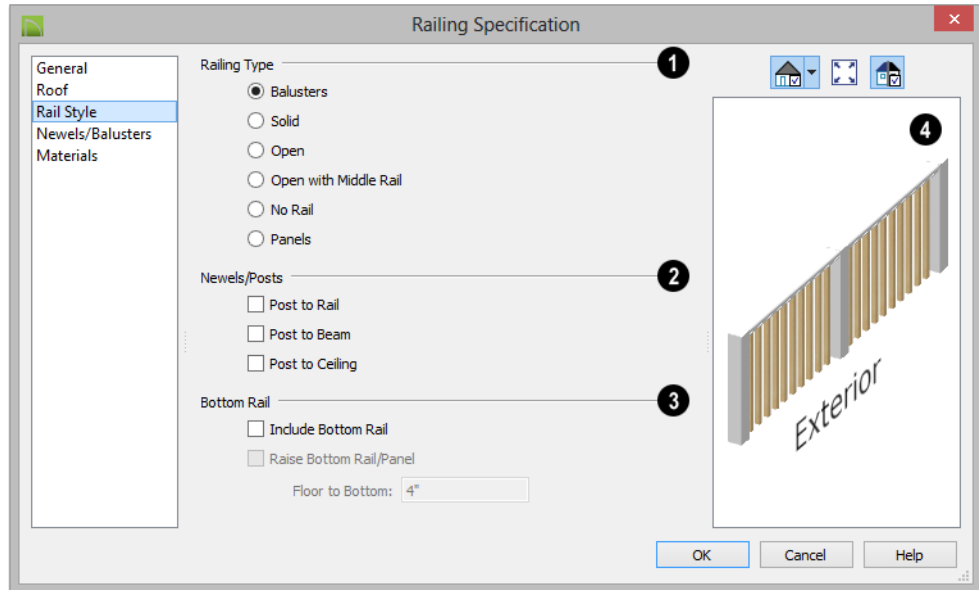

- 1 Railing Type** - Select the radio button for the desired railing type. A preview of the selected type displays to the left.
- Check **Balusters** to create regularly spaced balusters between larger newel posts.
  - Check **Solid** to create a solid railing or Half Wall.
  - Check **Open** to create a railing with only newel posts and top and bottom rails.
  - Check **Middle Rail** to create a railing with newel posts and top, bottom, and middle rails.
  - Check **No Rail** to eliminate rails, leaving only newels or posts and an overhead beam, if selected.
  - Check **Panels** to create a railing composed of panels. You can specify the panel style on the NEWELS/BALUSTERS panel..

- 2** Specify the properties of the selected railing's **Newels/Posts**.
- Check **Post to Rail** to create newel posts from the floor to the top rail. This option is selected by default.
  - Check **Post to Overhead Beam** to create newel posts from floor to an overhead beam placed just under the ceiling height. The beam's width is based on the Thickness of the selected railing wall.
  - Check **Post to Ceiling** to extend the newel posts to the ceiling.
  - When none of the above Post options is selected, newel posts will build to the top of the railing.
- 3** The **Bottom Rail** options control the placement of the bottom rail, or shoe. If neither box is checked, the bottom rail is placed at floor platform level. Not available for railings specified as Solid or No Rail.

- Uncheck **Include Bottom Rail** to eliminate the bottom rail and extend the balusters to the floor. Also not available for Panel railings.
- Check **Raise Bottom Rail/Panel**, then specify the **Floor to Bottom** distance,

measured up from the floor platform to the bottom rail or panel.

- ④ A preview of the selected railing or fence, including any doorways or gates inserted into it, displays on the right. See “Dialog Preview Panes” on page 32.

## Newels/Balusters Panel

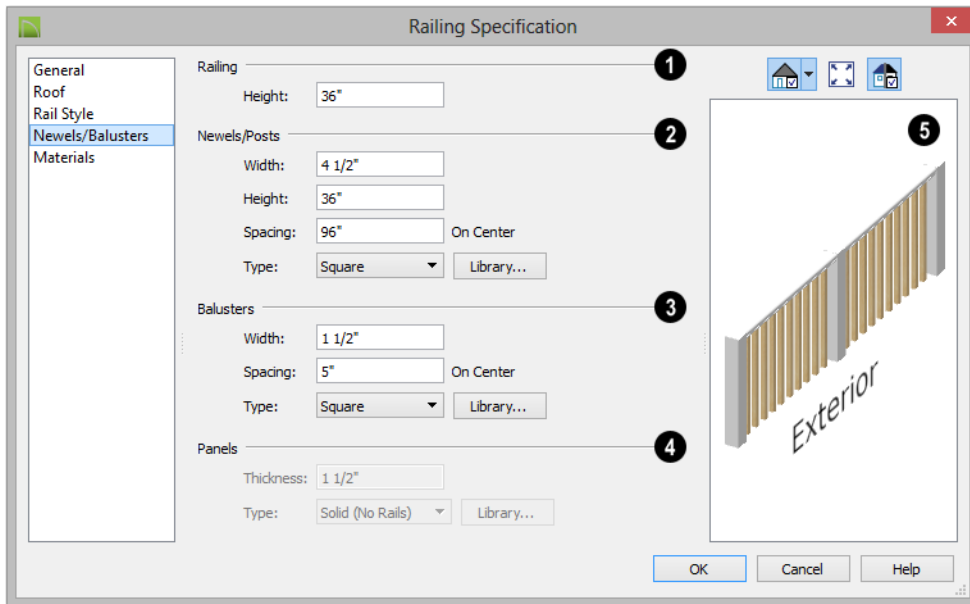

- ① Specify the height of the **Railing**.
- Specify the **Railing Height**. For interior railings, this is measured from the height of the floor finish.
- ② Specify the characteristics of the selected railing’s **Newels/Posts**.
- Specify the **Width** of each newel at its widest point.
- Specify the **Height**, which is the height from the floor or ground to the top of the newel. Not available if Post to Rail, Post to Overhead Beam or Post to Ceiling is selected on the RAIL STYLE panel.
- Specify the on-center **Spacing** of the newel posts.
- **Type** - Select Square, Round, or Library newels.

Note: Selecting Library from the drop-down list is the same as clicking the Library button to the immediate right and allows you to select a symbol from the library. See “Select Library Object Dialog” on page 408.

- 3 Specify the characteristics of the selected railing’s **Balusters**. These settings are only available when the railing type is “Balusters”.
  - Specify the **Width** or diameter of each baluster at its widest point.
  - Specify the on-center **Spacing** of the balusters.
  - **Type** - Select Square, Round, or Library balusters .

- 4 Specify the characteristics of the selected railing’s **Panels**. These settings are only available when the railing type is “Panels”.
  - Specify the panel’s **Thickness**.

- **Panel Type** is only available when the railing type has been specified as Panels on the RAIL STYLE panel. Select “Solid (No Rails)”, “Solid (With Rails)”, or “Library” to select a symbol to be used as a railing panel.

- 5 A preview of the selected railing or fence, including any doorways or gates inserted into it, displays on the right. See “Dialog Preview Panes” on page 32.

## Wall Hatch Specification Dialog

 To open the **Wall Hatch Specification** dialog, select a Wall Hatch and click the **Open Object** edit button. See “Hatch Wall” on page 129.

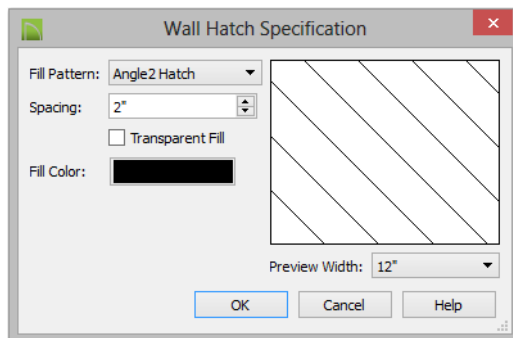

- Choose a **Fill Pattern** from the drop-down list. A preview of the selected pattern displays to the right.

The options that follow are disabled until you select a pattern other than **None** from the **Fill Pattern** drop-down list.

- Define the **Spacing** for the selected fill pattern. Hatch spacing set at 12" matches grid/reference spacing set at 12".
- Check **Transparent Pattern Fill** to make the fill pattern transparent. When you check this option, any objects behind the fill pattern are visible through it.
- **Fill Color** - Click the color bar to select a color for the fill pattern lines or fill color if a solid fill is specified. This overrides the layer color. See “Select Color Dialog” on page 438.
- Choose a **Preview Width** from the drop-down list. This value controls how large an area the preview represents. The

selected value indicates the length of each side of the preview in plan inches (mm).

# Rooms

When walls or railings create an enclosed area, a “room” is created. You can select rooms defined in this manner like other objects in Home Designer Architectural.

Rooms are assigned a Room Type. Each Room Type has predefined characteristics. For example, a room defined as Porch is assigned certain attributes that are different than a Kitchen.

Floor and ceiling heights, baseboard, chair-rail, and crown moldings and materials can be defined room-by-room or for the entire floor.

## Chapter Contents

- Floor and Room Defaults
- Room Definition
- Selecting Rooms
- Displaying Rooms
- Editing Rooms
- Room Types
- Room Labels
- Decks
- Floor and Ceiling Heights
- Stepped Floor and Ceiling Platforms
- Special Ceilings
- Room Specification Dialog

## Floor and Room Defaults



Select **Edit > Default Settings** to open the **Default Settings** dialog where you can access several defaults dialogs which directly affect rooms.

### Floor Defaults

Default values for rooms are specified in the **Floor Defaults** dialog for the current floor. This dialog also controls important information that the program uses to create 3D models - particularly floor and ceiling heights and materials. Moldings can also be specified in the **Floor Defaults** dialog.

Only the defaults for the first floor of a building can be set ahead of time. The program uses the setting from the first floor to create subsequent floors. Once a new floor is built, its floor defaults can be changed. See “Floor Defaults Dialog” on page 220.

### Floor 1 Default Height

Home Designer Architectural always defines the default height of Floor 1 at 0'-0". This height value is measured from the top of the subfloor and is the constant by which the heights of structural elements in the

programlike walls, floors, and ceilings are measured. The heights of architectural objects can be measured relative to this absolute height, as well. As such, this default cannot be changed.

### Room Defaults

Additional material defaults for several categories of Room Types can also be specified:

- Normal Rooms
- Kitchens/Baths/Utility Rooms
- Decks
- Garage/Porches/Slabs

These Room Defaults dialogs are accessed by expanding the “Rooms” category in the **Default Settings** dialog. Select a room type and click the **Edit** button to open the defaults dialog for that room type. See “Room Types” on page 164.

These dialogs allow you to specify the floor and ceiling covering materials for different Room Types. See “Materials Panel” on page 177.

---

## Room Definition

A room is a totally enclosed area defined by any combination of joined walls or railings, visible or invisible. To be recognized as a room by Home Designer Architectural, a room must have an unbroken perimeter.

Unless otherwise specified, rooms generate floor and ceiling platforms automatically.

Most rooms are also automatically covered by the roof when one is built. There are exceptions to this, such as rooms defined as Decks. See “Room Types” on page 164.

If a room is drawn within a larger structure and none of its walls connect to the exterior walls, either directly or indirectly by



connecting to walls that do, it is referred to as an “island” room. The program will connect such a room to the larger structure with an Invisible Wall. See “Room Dividers and Invisible Walls” on page 127.

Room definition disappears if part or all of a surrounding wall is deleted. It is a good idea to finalize the position of walls before defining rooms with names and attributes such as floor height and ceiling height.

## Subdividing Rooms

When a room area is first defined, it inherits its characteristics from the **Floor Defaults** dialog for that floor. If the room is then specified as a particular type, it may inherit properties from the **Room Defaults** dialog associated with its type.

If a new room is created by subdividing a larger room, it inherits its characteristics from that larger room - including any non-default settings.

If two rooms are separated by an Invisible wall, their interior areas will be measured from the wall’s centerline and characteristics like the floor finish materials and moldings will break along that line.

- If the two rooms have different floor heights, the break will occur at the wall edge that faces the room where the floor is lower.
- If the two rooms have different ceiling heights, the break will occur at the wall edge that faces the room where the ceiling is higher.

---

## Selecting Rooms

Room definition is established when a room is completely enclosed by walls. You can confirm that a room has room definition by using the **Select Objects**  tool to select it. When a fully-enclosed room is selected, the room highlights.



*The room at left is selected*

## The Exterior Room

You can also select the exterior of a model. This allows you to control the building’s exterior wall coverings and materials using the **Room Specification** dialog.

Click just outside an exterior wall using the **Select Objects**  tool to select the Exterior Room. When it is selected, a highlighted band around the plan’s exterior displays. This band represents the selection area for the Exterior Room.

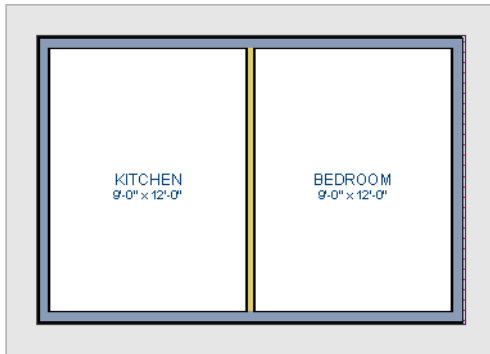



*The Exterior Room is selected*

In camera views and overviews, the Exterior Room can be selected by clicking on the exterior surface of an exterior wall using the **Select Objects**  tool.

## In 3D Views

Click on the floor of a room or on a wall surface inside the room in a 3D view using the **Select Objects**  tool. If you select another object instead of the room, click

**Select Next Object**  edit button or press the Tab key until the room is selected. The Status Bar indicates which object is currently selected.

The Exterior Room can also be in 3D views selected by clicking once on the exterior surface of an exterior wall using the **Select Objects**  tool.

Note: If the wall height of the Exterior Room is adjusted in a 3D view, the default Floor or Ceiling Height of the entire floor is changed. See “Floor and Room Defaults” on page 160.

## Displaying Rooms

Unlike most things in Home Designer Architectural, a room is not an individual object. Rather, a room is defined by the walls that enclose it.

### In Floor Plan View

Rooms typically display a transparent fill in floor plan view. You can, however, specify a solid color or fill pattern for all the rooms on an entire floor in the **Floor Defaults** dialog, or for individual rooms in the **Room Specification** dialog. See “Fill Style Panel” on page 177.

In order for room fill styles to display, the “Rooms” layer must be turned on. See “Displaying Objects” on page 76.

Room labels that include the room’s name as well as its size and other information can be set to display in floor plan view. See “Room Labels” on page 166.

### In 3D Views

Rooms can be viewed in 3D views created by any of the 3D view tools. The **Dollhouse View** tool can be used to see all rooms on the current floor without their ceilings. See “Creating Overviews” on page 451.

### In the Materials List

The contents of a room, including furnishings and floor and ceiling materials can be calculated using the **Calculate From**

**Room** tool. See “Calculate for Room” on page 580.

---

## Editing Rooms

Once a room is defined by walls or railings, its structure and appearance can be edited using the edit buttons or the **Room Specification** dialog.

### In 3D Views

The floor and ceiling heights for floors, rooms, and individual walls can be edited using edit handles in 3D views. Lowered ceilings cannot be edited in 3D. See “3D Views” on page 447.

The default floor and ceiling heights for an entire model can be edited by selecting the Exterior Room. See “The Exterior Room” on page 161.

#### *To change default ceiling heights in 3D*

1. Create a 3D view of the exterior of your plan.
2. Click on the exterior surface of a wall to select the Exterior Room. The Status Bar indicates when the exterior room is selected. See “The Exterior Room” on page 161.
3. Click and drag the edit handle on the top wall edge to adjust the default ceiling height, or the edit handle on the bottom edge to adjust the default floor height. Temporary dimensions display.

Note: Any rooms that do not update when the default floor or ceiling height is changed are not using the default values. To use the default values for a specific room, check Default for any of the room height values in its specification dialog. See “General Panel” on page 172.

#### *To adjust room heights in 3D*

1. Create a 3D view of your plan.
2. Click on the surface of a wall that faces the room to select it. When the room is selected in 3D:
  - The room highlights.
  - The Status Bar says “Room”. See “The Status Bar” on page 33.
  - Two edit handles display on the top and bottom edges of the highlighted wall.
3. Click and drag the edit handle on the top wall edge to adjust the room ceiling height, or the handle on the bottom edge to adjust its floor height. Temporary dimensions display.
4. As you drag a handle, notice that all walls defining that room are affected.

Room materials such as floor, ceiling, and wall materials can be changed in 3D views using the **Material Painter** . See “The Material Painter” on page 417.

## In the Specification Dialog



Floor and ceiling heights, floor platform structure, moldings, wall coverings, and materials can all be specified in the **Room Specification** dialog. See “Room Specification Dialog” on page 172.

## Using the Edit Tools

A selected room can be edited using the edit toolbar. See “The Edit Toolbar” on page 28.

- Click the **Calculate Materials for Room**  edit button to create a materials list of the contents of the selected room, not including walls. See “Calculate for Room” on page 580.

---

## Room Types

When a room is first created by enclosing an area with walls, it is assigned a generic room type of “Unspecified.”

Once your floor plan is laid out, each room should be assigned a **Room Type** in the **Room Specification** dialog. See “General Panel” on page 172. The Room Type applies appropriate structural and display properties to the room.

When you assign a Room Type, a label showing the room’s Type displays in floor plan view.

You can edit the text of a room label in floor plan view, but the type of room originally assigned remains until it is changed in the **Room Specification** dialog. See “Editing Room Labels” on page 166.

### Available Room Types

There are three categories of room types: Interior, Exterior and Hybrid.

**Interior** - Living, Dining, Family, Kitchen, Nook, Bath, Master Bath, Master Bedrm, Bedroom, Study, Office, Entry, Hall, Closet, Dressing, Storage, Laundry, Utility and Unspecified.

**Exterior** - Court, Deck, Balcony.

**Hybrid** - Open Below, Garage, Slab, Porch, Attic.

### Effects of Room Types

The program applies specific structural and display properties to rooms depending on the assigned Room Type.

#### Living and Conditioned Areas

- All interior type rooms are included in Living Area calculations by default; exterior and hybrid type rooms are not.
- With the exception of Unspecified rooms, all interior type rooms are included in Conditioned Area calculations. Open Below rooms are also included; however, exterior and other hybrid type rooms are not. See “Conditioned Area Totals” on page 585.

#### Ceilings and Roofs

- Interior rooms have a ceiling and roof above them unless specified otherwise.
- Exterior rooms are assumed to be open to the outside and do not generate a roof above them, or room moldings.

- Attic rooms are ignored by the program's automatic roof generator.
- Garage, Slabs, and Porches are treated like exterior rooms in all cases except that they generate a ceiling and a roof above them.
- A room's default ceiling structure and finish definitions are determined by its Room Type. See "Room Defaults" on page 160.

### Floors and Foundations



- Open Below is a unique type of interior room. It has no floor platform and can be used for defining stairwell openings.
- Walls that define the garage have a foundation under them with a concrete slab at the top of stem wall or grade beam.
- The floor in Garage and Slab rooms display in 3D on Floor 0, not the first floor. See "Garages" on page 233.
- A room's default floor structure and finish definitions are determined by its Room Type. See "Room Defaults" on page 160.
- Courts, decks and balconies do not generate foundations.

### Doors and Windows

- A window placed in a wall between an exterior room and an interior room always faces out toward the exterior.
- Windows placed between interior type rooms generate a warning message.
- Doors placed between interior and exterior type rooms display threshold lines and are considered Exterior. See "Interior vs Exterior Doors" on page 179.

- Doors placed between interior type rooms do not display thresholds and are considered Interior.
- Open Below rooms are treated as interior rooms for window and door placement.

### Electrical

- The **Auto Place Outlets**  tool adds outlets automatically to all interior rooms except bathrooms. Only one outlet over each sink is added for a bathroom.
- The **Auto Place Outlets**  tool places fewer outlets in hybrid rooms.
- The **Auto Place Outlets**  tool does not place outlets in exterior type rooms, Porches or Open Below rooms.
- Any outlet manually placed in an exterior room automatically becomes a waterproof outlet designed for exterior use.

### Trim and Molding

- Moldings are not automatically drawn in exterior or hybrid rooms.
- Baseboards and chair rails are not initially drawn in Open Below rooms, but crown molding, if present, is.

### Plan Check

- **Plan Check**  uses the room type and its characteristics for basic plan checking. For example, a closet does not need a smoke detector but a bedroom does. See "Plan Check" on page 526.

## Room Labels

A label can display in floor plan view for any area defined as a room. There are two parts to each room label:

- The Room Name, which is similar to a **Text**  object and can be selected and edited. See “The Text Tools” on page 499.
- The room area, which is not a standard text entry and cannot be directly edited.

You can assign a custom Room Name, move a room label or even delete it without affecting the Room Type. See “Room Types” on page 164.



Room labels can move or even disappear when room entries are revalidated.

### Displaying Room Labels

The display of room labels is controlled in the **Display Options** dialog. Room labels are placed on the “Rooms, Labels” layer and use the Text Style assigned to that layer. See “Display Options Dialog” on page 77.

You can specify how the area of rooms is reported by the program by turning on the display of one or more of these layers:

- **Rooms, Standard Area** is measured from the center of interior walls that define the room and from either the outside surface or outside of the Main Layer of exterior walls, depending on the **Living Area to** setting in the **General Plan Defaults** dialog. It is rounded to the nearest square foot or mm and does not include the area within bay, box and bow windows. See “Exterior and Interior Walls” on page 125

and “General Plan Defaults Dialog” on page 60.

- **Rooms, Interior Area** is measured from the inner surfaces of all the room's walls.
- **Rooms, Interior Dimensions** is also measured from the inner surfaces of the room walls.

The display of room labels can also be controlled on a room by room basis in the Room Specification dialog. See “General Panel” on page 172.

### Editing Room Labels

Room labels are similar to simple **Text**  objects and can be changed, moved and resized much like any other text object. You can also modify a room label's Text Style and other attributes in the **Room Label Specification** dialog.

The text of a room label cannot be modified in its specification dialog, however: it must be specified in the **Room Specification** dialog. See “General Panel” on page 172.

If you delete a room label, the Room Type and Room Name remain unchanged in the **Room Specification** dialog. To restore the label, check the **Show Room Label** checkbox on the GENERAL panel of that dialog.

### Room Area

Unlike the rest of a room label, the room area and dimensions are not standard text entries and cannot be edited or changed. The room area moves, resizes and rotates with the rest

of the room label, but you can turn the area and dimensions on or off separately in the **Display Options** dialog. See “Displaying Rooms” on page 162.

The **Interior Area** room area calculation includes the areas within bay, box or bow windows, while the Standard Area and Interior Dimensions calculations do not.

## Living Area

The Living Area label is an automatically generated label that reports the area of the current floor specified as living space. By default, Interior Rooms are defined as part of the Living Area, while Exterior and Hybrid Rooms are not. See “Available Room Types” on page 164.

Regardless of its Room Type, you can specify whether any room is included in the Living Area Calculation in the **Room Specification** dialog. See “General Panel” on page 172.

A Living Area label is created as soon as a room area is defined by walls and/or railings and is recalculated every time you add, remove, resize, or redefine a room. If multiple buildings are created, each will have its own Living Area label. If none of a structure’s rooms are included in the Living Area Calculation, however, no Living Area label will display for it.

To turn off the display of all Living Area labels in a plan, uncheck **Show Living Area Label** in the **General Plan Defaults** dialog or turn off the “Room Labels” layer in the **Display Options** dialog. See “General Plan Defaults Dialog” on page 60.

The Living Area label can be moved or deleted. To restore a deleted Living Area label, select **Tools> Plan Check** . You can click the **Done** button immediately, without actually completing Plan Check. See “Plan Check” on page 526.

## Living Area vs. Footprint

The Living Area should not be mistaken for the footprint of a house. Only true livable areas are included in the Living Area calculation. By default, exterior and hybrid room types such as Garage, Deck, and Porch are not included. Neither is any room labeled Open Below or Attic. See “Available Room Types” on page 164.

Regardless of its room type, you can specify whether a room is included in the Living Area calculation in the **RoomSpecification** dialog. See “General Panel” on page 172.

Living Area is measured from either the outside surface or the outer surface of the Main Layer of exterior walls. See “Wall Type Definitions” on page 142.

---

## Decks

A Deck room is an exterior-type room that uses deck planking and framing to create a floor platform rather than using a single floor surface that spans the entire room area.

To draw a deck, select **Build> Railing and Deck> Deck Railing** , then click and drag to draw a railing.

- To create a deck without a railing, use one of the **Deck Edge** tools. See “Fencing Tools” on page 125.
- You can also create a regular, polygon-shaped deck using the **Polygon Shaped Deck**  tool. See “Polygon Shaped Deck” on page 124.

A room does not have to be defined by Deck Railing to be specified as a “Deck.” See “Room Types” on page 164. You can also define a room as a “Deck” in the **Room Specification** dialog. See “General Panel” on page 172.

By default, decks do not have roofs. If you want a roof over a deck, check **Roof Over This Room** in the **Room Specification** dialog. See “Structure Panel” on page 173.

To give the roof a visible means of support, you can select the **Post to Beam** option in the **Wall Specification** dialog. See “Rail Style Panel” on page 154.

Openings in deck railings can be created using **Doorways** . See “Openings in Railings” on page 187.

## Deck Framing and Planking

When a Deck room is created, the floor platform is modeled using joists, beams, posts, and planking.

Deck framing, planking, posts, and beams are placed on their own layers with names that begin with “Framing, Deck”: for example, “Framing, Deck Posts”. These layers cannot be turned on in floor plan view but are shown in 3D views.

---

## Floor and Ceiling Heights

Default floor and ceiling heights are defined in the **Floor Defaults** dialog for each floor, including the foundation. Use the **Floor Defaults** dialog to change these values on a floor-by-floor basis. See “Floor and Room Defaults” on page 160.

Use the **Room Specification** dialog to set floor heights on a room-by-room basis. See “Room Specification Dialog” on page 172.

Different rooms on the same floor can have unique floor and ceiling heights, allowing you to create:

- Split levels and bi-levels
- Sunken living rooms and garages
- Cathedral and coffered ceilings.



In 3D views, you can adjust the default floor and ceiling height for the entire floor or the floor and ceiling height for an individual room. See “In 3D Views” on page 163.

In order to raise or lower an area’s floor or ceiling height, you must give it a room definition. To create room definition without



enclosing an area with solid walls, use

**Railings** .

Ceiling and floor heights are interrelated. Changing the floor height in one room can affect ceiling heights of the rooms below.

- If a room's floor is lowered, its ceiling height is increased while the ceiling below that room drops.
- If the floor is raised, the ceiling height decreases while the ceiling below that room is raised.

If the rooms above a particular room have more than one floor height, the room's ceiling is stepped.

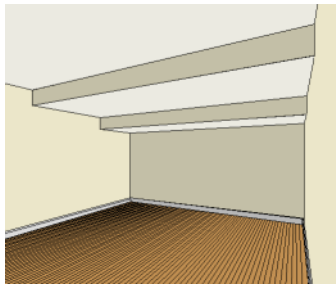

In a situation like this, a Lowered Ceiling can be used to cover “steps” made by different floor heights on the floor above. See “General Panel” on page 172.

To ensure that steps in floor and ceiling platforms have solid sides, define their room areas using Invisible Railings.

## Split Levels

A split level can be created by raising or lowering the floor and ceiling heights of various areas of the plan.

In the following example, the lowest floor height is 0, the next is 24, and the next is 48 inches. The ceiling height in each room is set at 109 inches. See “Split Levels” on page 223.

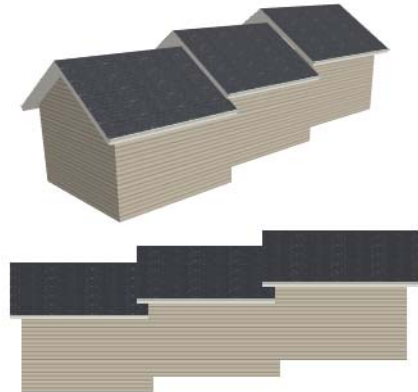

---

## Stepped Floor and Ceiling Platforms

Each floor has default floor and ceiling heights. You can, however, use the **Room Specification** dialog to specify floor and ceiling heights on a room by room basis to create stepped floors and ceilings. See “Structure Panel” on page 173.

If you require a single floor platform with a uniform height and thickness but different ceiling heights for the rooms below, specify a lowered ceiling using the **Ceiling Finish Specification** dialog. See “Lowered Ceilings” on page 170.

## Special Ceilings

By default, the program builds a flat ceiling platform on top the wall plates of a room. More varied and complex ceilings are made

using settings in the **Room Specification** dialog.

### Lowered Ceilings

You can define a lowered or dropped ceiling in a room without affecting the top height of the walls by increasing the thickness of the Ceiling Finish.

In the following illustration, the default ceiling height for the entire first floor is 120", and the room on the right has a ceiling finish lowered to 96".

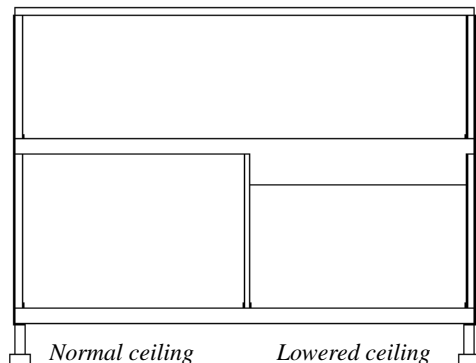

#### *To create a lowered ceiling*

1. Select the room in which you would like to specify a lowered ceiling.
2. Click the **Open Object**  edit button to open the **Room Specification** dialog.
3. On the STRUCTURE panel, increase the **Ceiling Finish** value by the amount that you would like to lower the ceiling.
4. Notice that the preview diagram represents the Finished Ceiling height (F).

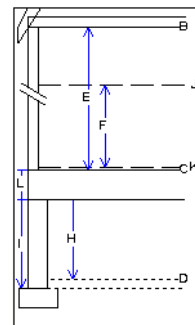

### Cathedral Ceilings

A cathedral ceiling has the same pitch as the roof and is created using the underside of the roof above the room.

#### *To create a cathedral ceiling*

1. Build a roof for your plan. See "Roofs" on page 243.

2. Select the room and open the **Room Specification** dialog. See "Room Specification Dialog" on page 172.
3. On the STRUCTURE panel, clear the checkbox for **Ceiling Over This Room**.

## Trey Ceilings

A trey ceiling is an area within a ceiling that is raised and has either vertical or sloping sides. A standard trey ceiling can be easily created by placing Soffits around the perimeter of the room. An angled trey ceiling can be created using the underside of roof planes above.

### *To create a angled trey ceiling*

1. In the **Room Specification** dialog, make sure that **Ceiling Over this Room** is checked, then specify the desired height of the walls as the **Ceiling Height**. See “Structure Panel” on page 173.
2. Make sure that **Auto Rebuild Roofs** is unchecked, then build the roof. See “Build Roof Dialog” on page 245.

3. Change the **Ceiling Height** of the room to the desired height of the flat ceiling surface in its center.

In floor plan view, dashed lines indicate where the ceiling changes from sloped to flat. These lines are located on the “Ceiling Break Lines” layer in the **Display Options** dialog. See “Display Options Dialog” on page 77.

If the roof is rebuilt after the ceiling height is adjusted upward, the new roof will be raised to match the new ceiling height and a trey ceiling will not be created.

In the following example, a hip roof is built on 8' (2400 mm) ceilings. After the roof is built, the Ceiling Height is raised to 10' (3000 mm). The resulting ceiling follows the roof pitch for 2' (600 mm), then becomes a flat ceiling.

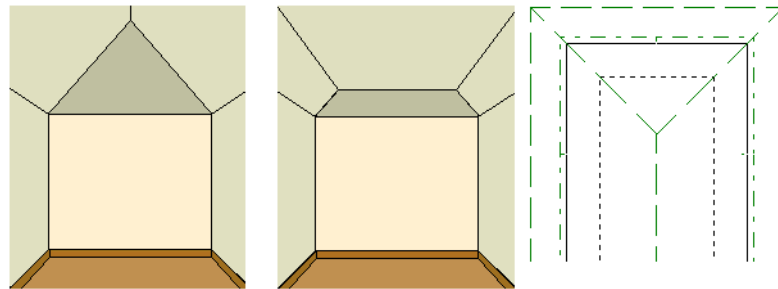

*Hip roof with cathedral ceiling over.*

*Hip roof, ceiling over, ceiling height raised.*

*Ceiling Break lines in floor plan view.*

## Cantilever Undersides

Occasionally, a room will cantilever out past an exterior wall. You can specify the surface material of the underside of a cantilever on

the **MATERIALS** panel of the **Room Specification** dialog. See “Room Specification Dialog” on page 172.

## Other Special Ceilings

**Soffits**  can be used in various ways to enhance the 3D model. Soffits' ability to follow the slope of the roof offers unlimited possibilities, such as exposed beams or trusses and coffered ceilings. See "Special Applications for Soffits" on page 380.



---

## Room Specification Dialog

 The **Room Specification** dialog controls the structural characteristics and appearance of a selected room. To open the **Room Specification** dialog, select a room and click the **Open Object** edit button. See "Selecting Rooms" on page 161.

Several of the panels in the **Room Specification** dialog are also found in the **Floor** and **Room Defaults** dialogs. See "Floor and Room Defaults" on page 160.

Some values in this dialog are dynamic. A value with **Default** checked references the **Floor Defaults** dialog. To return a value to the default, replace the check mark. See "Dynamic Defaults" on page 59.

The settings in this dialog are similar to those in the **Floor Defaults** dialog, but affect only the selected room. See "Floor Defaults Dialog" on page 220.

## General Panel

The **GENERAL** panel is not available in the **Room Defaults** dialog, and only two of the settings here are active in the **Floor Defaults**

dialog. See "Floor and Room Defaults" on page 160.

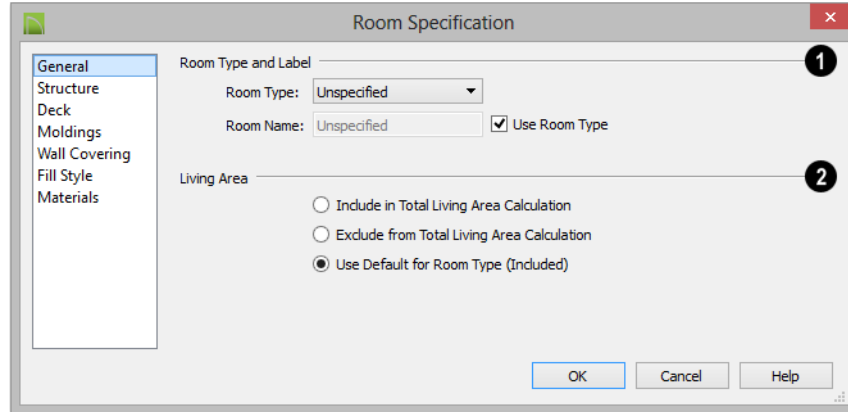

**1** The settings here control the Room Type and the appearance of the Room Label

- Select the **Room Type**. This affects some of the room’s characteristics. See “Room Types” on page 164.
- If you wish to use a custom name in the room label, uncheck **Use Room Type**, then specify the desired **Room Name** in the text field.
- Check **Show Room Label** to display the room label in floor plan view. See “Room Labels” on page 166.  
This option is unchecked automatically if you select “Unspecified” as the Room

Type, and checked automatically if you select any other Room Type

**2** Specify whether the selected room is included in the **Living Area** calculation. See “Living Area” on page 167.

- Select **Include in Total Living Area Calculation** to include the room in the Living Area regardless of its Room Type.
- Select **Exclude from Total Living Area Calculation** exclude the room from the Living Area regardless of its Room Type.
- Select **Use Default for Room Type (Included/Excluded)** to base the selected room’s inclusion in the Living Area on its Room Type. The default for the selected Room Type is stated in parentheses.

## Structure Panel

The **STRUCTURE** panel is also found in the **Floor** and **Room Defaults** dialogs and features a cross section diagram that shows the relationships between its various heights and platform thicknesses. It is meant to represent the relationships between heights

and thicknesses rather than provide a scaled drawing of the model.

Two floors can be included in the diagram: the floor that the selected room is located on, and the floor below it, if one exists.

What appears in both the diagram and in the settings to its left may be affected by the location where you clicked to select the room. For example:

- If the selected room is located above two rooms with different structural settings, the position of the pointer relative to these

two lower rooms determines which of them displays as the floor below.

- If the selected room is located below two rooms with different floor heights, its absolute and relative ceiling height settings will be disabled.

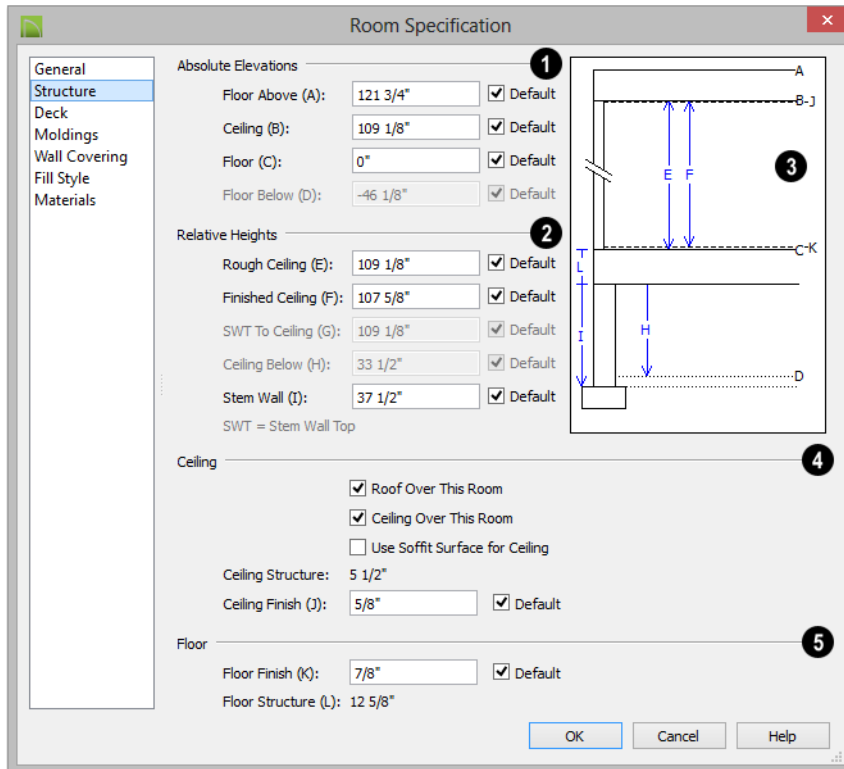

Check the **Default** box beside any height value to restore the default setting.

Note: Many of the settings on this panel are interdependent. For example, if the Ceiling Finish thickness is modified, the Finished Ceiling height will change in response.

**1 Absolute Elevations** - These height values are measured from zero, which is the default top height of the subflooring on Floor 1. See “Floor and Ceiling Heights” on page 168.

- Specify the **Floor Above** height, which is the subfloor height of the room on the floor above the selected room. If multiple

rooms with differing floor heights are present directly above, this setting will be inactive and “No Change” will display.

- Specify the **Ceiling** height of the selected room, as measured from zero to the bottom of the ceiling framing. Not available in the **Floor Defaults** dialog on Floor 0, or if multiple floor heights are specified above the selected room.
- Specify the **Floor** height, as measured from zero to the top of the subflooring.

Note: The default floor height for Floor 1 is 0. It can be modified in the Room Specification dialog, but not in the Floor 1 Defaults dialog. See “Floor and Room Defaults” on page 160.

If a room is defined directly beneath the selected room on the floor below, additional settings may be available.

- Specify the **Floor Below** height, which is the subfloor height of the room directly below where you clicked to select the currently selected room. If there are multiple rooms with differing floor heights located below, this value may change depending on where you click.
  - If the selected room is directly above a Garage and there is a foundation present, you can specify the **SWT Below** height, which is the top height of the concrete stem walls around the perimeter of the garage.
- 2 Relative Heights** - These height values are measured from surfaces within the selected room or the room below.
- Specify the **Rough Ceiling** height, as measured from the subfloor surface to the bottom of the ceiling framing. Not avail-

able if multiple floor heights are specified directly above the selected room.

- Specify the **Finished Ceiling** height, as measured from the finished floor surface to the finished ceiling surface. Not available if multiple floor heights are specified directly above the selected room.
  - Specify the distance from the **Stem Wall Top to Ceiling**. Only available when **Floor for this Room is Supplied by the Foundation ‘Room’ from the Floor Below** has been checked.
  - Specify the **Ceiling Below** height, which is the height of the ceiling of the room below, as measured from that room’s subfloor to rough ceiling surfaces. Not available when Auto Rebuild Foundation is enabled or if there is no room below the selected room. See “Rebuilding Foundations” on page 230.
  - Specify the **Stem Wall** height, which is measured from the top of the foundation wall footing to the top of the treated sill plate, if one is specified. Only available if the selected room or the room below it is defined by foundation walls.
- 3** A cross section diagram showing the relationship between the various height settings displays here for reference.
- 4** Specify the characteristics of the room’s **Ceiling**.
- If **Roof Over This Room** is checked, a roof automatically generates over the room. If unchecked, no roof generates.
  - If **Ceiling Over This Room** is checked, the room has a flat ceiling. If unchecked, the ceiling follows the underside of the roof.

- Check **Use Soffit Surface for Ceiling** to improve the 3D appearance of the transition between ceiling and eaves of exterior rooms with Ceiling Over This Room unchecked.
- The thickness of the **Ceiling Structure** displays here for reference but cannot be changed.
- Specify the thickness of the **Ceiling Finish** layer.
- 5 Specify the thickness of the **Floor Finish** layer.
- The thickness of the **Floor Structure** displays here for reference but cannot be changed.

## Deck Panel

The options on the DECK panel are only available for rooms designated as Decks. See “Decks” on page 167.

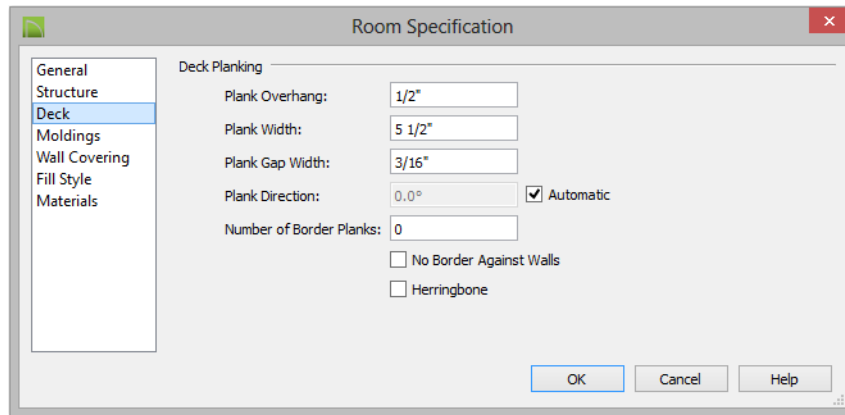

Specify the appearance of the **Deck Planking**.

- Specify how far the deck planking **Overhangs** the rim joists.
- Specify the **Plank Width** of the deck planking.
- Specify the **Plank Gap Width**, which is the distance between individual planks.
- If you want to enter a **Plank Direction**, remove the checkmark from **Automatic**. Enter the direction as degrees.
- Specify the **Number of Border Planks**. These are planks that follow the outside edge of the deck and may not be parallel with the rest of the planking. Border planks generate as long as the length of an inside edge is greater than 0". They do not generate on curved deck edges.
- Check **No Border Against Walls** to prevent border planking from being generated along any walls defining the deck.



- Check **Herringbone** to produce a herringbone pattern where the border planks meet.

## Moldings Panel

Chair rail, crown and base moldings can be assigned to a selected room on the **MOLDINGS** panel. Moldings are placed around the wall surfaces of a room and continue around the surface of any soffit that is attached to the wall at the molding height.

The settings on the **MOLDINGS** panel are similar to those found in other specification dialogs throughout the program. See “Moldings Panel” on page 306.

The settings on this panel are also similar to those found in the **Floor Defaults** dialog, but affect only the selected room instead of all rooms on the current floor.

## Wall Covering Panel

The settings on the **WALL COVERING** panel of the **Room Specification** dialog are the same as those on the same panel of the **Wall Specification** dialog. When a wall covering is assigned in the **Room Specification** dialog, it is applied to all walls in the selected

room only. See “Wall Covering Panel” on page 152.



Wall coverings can be applied to exterior rooms as well by selecting the exterior room and opening it for specification. See “Selecting Rooms” on page 161 for information about selecting exterior rooms.

## Fill Style Panel

The settings on the **FILL STYLE** panel affect the appearance of the room in floor plan view. This panel is also found in the **Floor Defaults** dialog. For more information, see “Fill Style Panel” on page 519.

## Materials Panel

The settings on this panel affect the appearance of a selected room’s walls, floor, ceiling and moldings in 3D views. See “Materials Panel” on page 420.

Default molding and ceiling and floor covering materials can be set on this panel in the **Floor Defaults** and **Room Defaults** dialogs.



# Doors

Home Designer Architectural comes with tools for creating a wide variety of interior and exterior doors. In addition, the library offers a large selection of specialty doors and doorways including hinged, sliding, pocket, bifold, and garage doors. Additional name-brand door catalogs are also available for download from our web site, [www.HomeDesignerSoftware.com](http://www.HomeDesignerSoftware.com).

## Chapter Contents

- Door Defaults
- The Door Tools
- Displaying Doors
- Editing Doors
- Changing Door Swings
- Special Doors
- Door Specification Dialog

---

## Door Defaults



Default Settings are accessed by selecting **Edit> Default Settings**.

Click the “+” next to **Doors** to show the door sub-headings. Select a subheading and click the **Edit** button to open the defaults dialog associated with your selection:

The **Door Defaults** dialogs look nearly the same as the **Door Specification** dialog. See “Door Specification Dialog” on page 189.

There are only a couple of differences:

- Since default settings are specified here, “Use Default” is not an option for some

settings as it is in the **Door Specification** dialog.

- The **Door Type** cannot be changed in the Defaults dialogs.

Because Hinged and Sliding Doors are often used in both interior and exterior applications, they have both Interior and Exterior Door Defaults.

## Interior vs Exterior Doors

Regardless of its **Door Type** or the tool used to create it, a door will be:

- An Interior Door if it is placed into a wall that separates two interior rooms;
- An Exterior Door if it is placed into a wall that separates an interior room from either

an exterior room or the building's exterior. See "Room Types" on page 164.

This rule applies to doors copied and pasted from one location to another just as it does to those created using the Door Tools.

---

## The Door Tools



To place a door, select the type you want from the **Build> Door** submenu.

Move your mouse pointer over a wall section. When a preview outline can be seen, click to place a door at that location.

The minimum initial size for doors varies by Door Type. For example, If there is room enough along the wall to fit a 12" (300 mm) wide Hinged Door, a preview outline will display and a door can be placed. Garage doors, in contrast, must initially be at least 6' (1800 mm) wide.

Doors can be placed in both straight and curved walls, as well as span across straight, collinear wall segments.

A newly created door inherits the settings in the **Door Defaults** dialog for its door type. Once created, doors can be edited in a variety of ways. See "Door Defaults" on page 179.

Doors cannot be placed in a wall specified as Invisible. See "Room Dividers and Invisible Walls" on page 127.

Once placed, any door may be changed into any other type of door in the **Door Specification** dialog. See "General Panel" on page 189.

### Hinged Doors



Select **Build> Door> Hinged Door** and click a wall where you want to

place a hinged door. Hinged doors can be placed on interior or exterior walls, and can be set up so that different door styles are placed in each. A hinged door becomes a double door when its width is four feet or greater.

The initial swing direction of a hinged door depends on the location of the mouse pointer relative to the wall when you click. The door will swing towards the side of the wall that you click nearest.

The initial hinge side of a hinged door can be set by clicking to place the door and then holding the mouse button down rather than releasing it. Move the mouse toward the end of the door that you would like the hinges to be on: as the mouse pointer nears either end, the door preview's hinge side will move to that end. You can also adjust the door's swing direction in this manner. When the swing direction and hinge side are correct, release the mouse button.

### Doorways



Choose **Build> Door> Doorway** and click a wall to place a doorway.

Doorways are simply openings without a

door and can be placed on interior or exterior walls, or in railings and fences to provide an opening. You can assign a door from the library to a doorway if you wish.

## Sliding Doors



Select **Build> Door> Sliding Door** and click on a wall where you want to place a sliding door. Sliding doors can be placed on interior or exterior walls and can be set up so that different door styles are placed in each. If placed in an exterior wall, the door is glass; if placed in an interior wall, it is a solid slab.

The initial opening side of a sliding door can be specified by moving the mouse pointer along the wall while the mouse button is still pressed.

The default sliding door dimensions are 5'-0" x 6'-8" with a 12" bottom frame and a 6" frame on the sides and top.

## Pocket Doors



Select **Build> Door> Pocket Door** and click a wall where you want to place a pocket door.

As with sliding doors, the initial opening side of a pocket door can be specified by moving the mouse pointer along the wall while the mouse button is still pressed.

The default pocket door dimensions are 2'-6" x 6'-8" high. A pocket door becomes a double pocket door if its width is four feet or greater.

## Bifold Doors



Choose **Build> Door> Bifold Door** and click a wall where you want to place a bifold door.

Like a hinged door, the initial opening side of a bifold door depends on the location of the mouse pointer relative to the wall when you click. The door will open towards the side of the wall that you click nearest.

Similarly, the initial hinge side of a sliding door can be specified by moving the mouse pointer along the wall while the mouse button is still pressed.

The default interior single bifold door is 2'-6" x 6'-8". A bifold door becomes a double bifold if its width is greater than three feet.

Bifold doors always display closed in all 3D views.

## Garage Doors



Choose **Build> Door> Garage Door** and click a wall to place a garage door.

The default garage door is 8'-0" x 7'-0" high. A garage door must be at least two feet wide.

In floor plan view, dashed lines show the size and location of the garage door when open.

Garage doors will build into a garage stem wall provided the room is designated as a garage before the door is inserted. See "Room Types" on page 164.

## The Doors & Doorways Library Catalog



The Doors & Doorways library catalog can be accessed by selecting

**View > Library Browser** and browsing to Home Designer Core Catalogs > Architectural. This catalog contains a variety of interior and exterior doors, as well as special entryways and wrapped openings.

Entryways and wrapped openings are examples of Doorways, which are wall openings that do not have doors within them.



To add a door to the Doorway, select a **Door Type** other than “Doorway” from the drop-

down list in the **Door Specification** dialog. See “General Panel” on page 189.

You can also select a custom door from the library and place it into a doorway in floor plan view or any 3D view.

**To place a library door in a doorway**

1. Go to floor plan view or any 3D view.
2. Open the Library Browser.
3. Browse or search to find a custom door style that suits your needs.
4. Select the door in the Library Browser, then click on the doorway to place the selected door within it. If a door already exists, it is replaced.
5. Continue clicking other doorways as needed.

## Displaying Doors



The display of doors and door labels is controlled in the **Display Options** dialog. See “Display Options Dialog” on page 77.

Doors can only be placed in walls, so if a wall’s layer is turned off, any doors placed in that wall will not display, either. See “Displaying Walls” on page 132.

If the “Doors” layer is turned off, doors and their casing do not display but openings in the walls where they are located are visible.

### In Floor Plan View

A door’s jamb, and swing are all represented in floor plan view. Doors in exterior walls and doors that open to exterior type rooms such as a Garage, Porch, or Deck have a

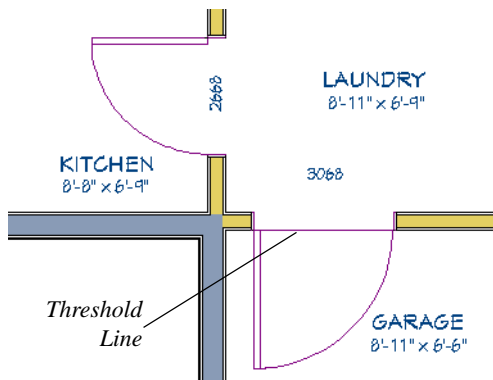

threshold line across the opening in floor plan view. See “Room Types” on page 164.

You can specify whether an exterior door has a threshold in the **Door Specification** dialog. See “Casing Panel” on page 192.



If an exterior door to a Garage room on Floor 1 extends into a Garage stem wall or curb on Floor 0, its location will be indicated on Floor 0. See “Garages” on page 233.

### In 3D Views

You can specify whether a selected door is shown open or closed in 3D views by clicking the **Show Door Open in 3D**  and **Show Door Closed in 3D**  edit buttons as well as in the **Door Specification** dialog. See “General Panel” on page 189.

If a door is set to display open in 3D, the angle of the open door can be changed using the edit handles in floor plan view. See “Using the Mouse” on page 183.

### Door Labels



Door labels display in floor plan view, centered on the doors they represent, when the “Doors, Labels” layer is turned on and use the “Default Label Style” Text Style. See “Object Labels” on page 575.

Door labels indicate Width and Height. For example:

- In Imperial plans, the label for a 3’-0” wide, 6’-8” high double hung window will read 3068.
- In metric plans, the label for a 900 mm wide, 2100 mm high double hung window will read 900x2100.

---

## Editing Doors

Before a door can be edited, it must be selected. To select a door, click it when the **Select Objects**  tool or any of the **Door Tools**  are active. Doors and/or windows can also be group selected and edited. See “Selecting Objects” on page 88.

Blocked units are made up of individual doors and windows that have been grouped together to act as one object. You can create what is essentially a blocked door unit by assigning a library door to a doorway from the library.

Select a blocked unit by clicking on it in any view. To select a door that is a component of a blocked unit, click at the location of the component in question, then click the **Select Next Object**  edit button. See “Selecting Objects” on page 88.

### In the Specification Dialog

 The most precise method of editing a door is to use the **Door Specification** dialog. Door type, size, casing, materials, and more can all be specified in this dialog. See “Door Specification Dialog” on page 189.

### Using the Mouse

In floor plan view, click either of the two end handles and drag along the wall to change the width. The label showing the size updates as the handles are dragged. Click and drag the Move handle at the center to move the door along the wall it is placed in. Use the triangular Rotate handle to adjust the door’s swing. If the door’s label displays, an additional handle is available to move it.

In 3D views, a selected door has five edit handles: the Move handle at the center and a Resize handle on each edge. Click and drag an edge handle to resize the door.

A door or window moved against an intersecting wall temporarily stops when the casing meets the intersecting wall. You can continue to drag and it resumes movement past the intersecting wall.

## Using Dimensions







Like various other objects, doors can be moved using dimensions. See “Moving Objects Using Dimensions” on page 494.

Dimensions can be set to locate the centers, sides, casing, or rough opening of wall openings, or you can choose to not locate openings at all. If you wish, you can move a dimension’s extension lines to locate non-default locations on a door after the dimension is drawn. See “Editing Extension Lines” on page 493.

## Using the Edit Tools

A selected door or doors can be edited in a variety of ways using the buttons on the edit toolbar. See “The Edit Toolbar” on page 28.

- Click the **Change Opening/Hinge Side**  edit button to change the side of the door that its hinges are on. See “Changing Door Swings” on page 185.
- Click the **Change Swing Side**  edit button to change which direction the selected door swings.

- Click the **Show Door Open in 3D**  or **Show Door Closed in 3D**  edit button to control the selected door’s appearance in 3D views. See “In 3D Views” on page 183.
- Click the **Gable Over Door/Window**  to create a gable over the selected door(s) the next time the roof is rebuilt. See “Gable/Roof Lines” on page 248.

## Centering Doors



The **Center Object** edit button allows you to center a selected door along a wall within a room or relative to a cabinet or window. See “Using Center Object” on page 111.

### *To center a door along a wall*



1. Select a door or combination of windows and doors in floor plan view.
2. Click the **Center Object**  edit button then choose from one of the following options:
  - Click near a wall inside a room to center the door along that wall in that room.
  - Click outside the house (on the exterior room) near an exterior wall to center the door along an exterior wall.

## Door Hardware

Handles, locks, and hinges can be assigned to a door in the **Door Specification** dialog. See “Hardware Panel” on page 193.



## Changing Door Swings

  Door swing direction and hinge side can be changed using the **Change Opening/Hinge Side** and **Change Swing Side** edit buttons.

The **Change Opening/Hinge Side**  edit button is available for all doors except double doors and garage doors.

The **Change Swing Side**  edit button is available for all doors except pocket doors.

### Hinged Doors

In addition to using the edit buttons, hinged doors' hinge side and swing direction can be changed using the triangular Rotate edit handle.

#### *To adjust the angle of swing:*

1. In floor plan view, select the door and grab the triangular handle.
2. Drag to change the amount of swing.

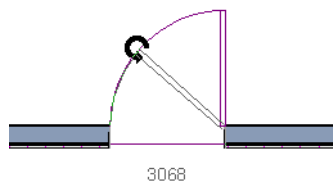

3. Release the mouse.

If you drag near the closed position, the door snaps to a closed position.

#### *To change the swing using edit handles:*

1. In floor plan view, select the door and grab the triangular edit handle.

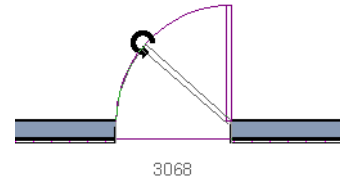

2. Drag the pointer along the path of the new arc to change the hinge side and/or swing direction.

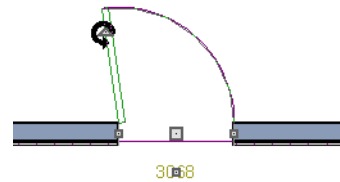

3. Release the mouse.

#### *To change the swing using edit buttons:*

1. In floor plan view, select the door.
2. To change the hinge side, click the **Change Opening/Hinge Side**  edit button.

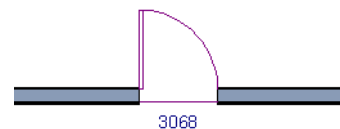
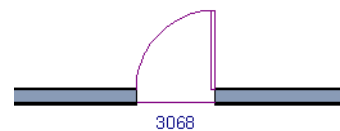

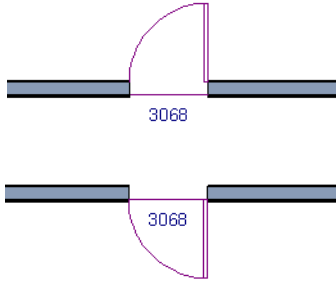

- To change the swing direction, click the **Change Swing Side**  edit button.

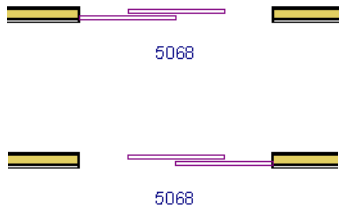

### Sliding Doors

To change the side of a sliding door that is fixed, select the sliding door then click the **Change Opening/Hinge Side**  edit button.



To flip the fixed and moving sides of the door, click the **Change Swing Side**  edit button.

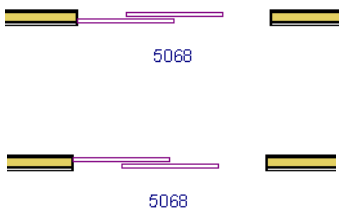

As with hinged doors, you can also change the Opening/Hinge and Swing sides of a

sliding door by clicking and dragging the triangular edit handle.

### Pocket Doors

To change the direction of a pocket door, select it and click the **Change Opening/Hinge Side**  edit button.

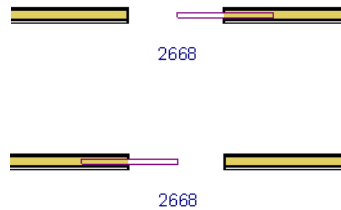

Note: There must be enough room for the entire door to fit in the opposite wall or the door does not change.

As with hinged doors, you can also change the Opening/Hinge side of a pocket door by clicking and dragging the triangular edit handle.

### Bifold Doors

To change the side of a bifold door that is fixed, select it then click the **Change Opening/Hinge Side**  edit button.

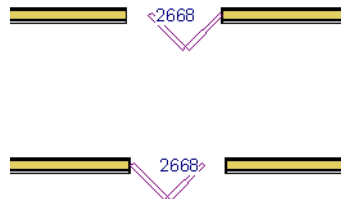

To change the hinged side of the door, click the **Change Swing Side**  edit button.

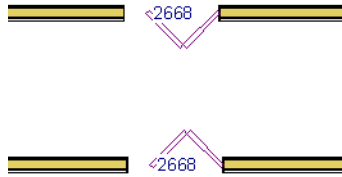

As with hinged doors, you can also change the Opening/Hinge and Swing sides of a bifold door by clicking and dragging the triangular edit handle.

## Garage Doors

To change the side of a garage door that it faces, select it and click the **Change Swing Side**  edit button.

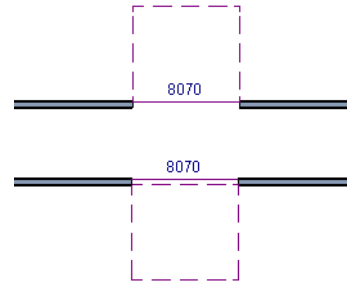

As with other door types, you can also change the Swing side of a bifold door by clicking and dragging the triangular edit handle.

---

## Special Doors

A variety of special doors and doorways can be created in Home Designer Architectural.

### Transoms Above Doors

Transom windows above doors are created the same as other stacked windows. See “Grouped Windows” on page 201.

### Wrapped Openings

Wrapped openings of various shapes are available in the **Doors & Doorways Library**.

You can also create a wrapped opening by unchecking **Use Interior Casing** and/or **Use Exterior Casing** in a Doorway’s **Door Specification** dialog. See “Casing Panel” on

page 192. If base molding is present, it will wrap around the opening.



### Openings in Railings

Use the **Doorway**  tool to open a railing for a stairway or other access.

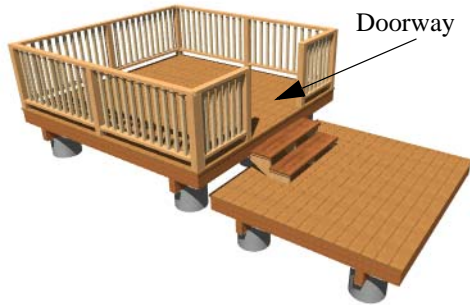

To open a railing across an entire section, resize the doorway's **Width** so that it is greater than the length of the railing in the **Door Specification** dialog. The opening resizes to the maximum width possible for that space. See "General Panel" on page 189.



To add a gate, specify the doorway's **Door Type** as a Door, then choose an appropriate gate as the **Door Style**. A selection of gates is available in the Fences & Railings library folder. See "Placing Library Objects" on page 406.

### Creating a Doorway with a Railing

When a railing is specified as **No Room Def**, it can be positioned within a **Doorway** .



### To create a doorway with railing

1. Place a **Doorway**  at the desired location in your plan.
2. Select **Build > Wall > Straight Railing** , then click and drag to draw a railing parallel to the wall with the doorway.
3. Select the railing, then use the Resize edit handles to adjust the length of the railing as needed. See "Using the Edit Handles" on page 90.
4. With the railing selected, click the **Open Object**  edit button.
5. On the **GENERAL** panel of the **Railing Specification** dialog, check **No Room Def** and click OK. See "General Panel" on page 147.
6. With the railing still selected, Ctrl + drag it into position within the doorway. See "To move an object freely" on page 109.

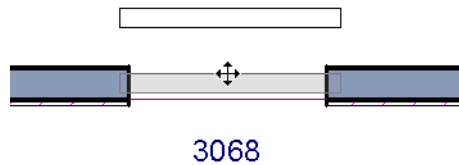

*Positioning a railing in a doorway*



### Placing a Gable Over a Door

 Click the **Gable Over Door/Window** edit button to produce a gable roof over the selected door(s) the next time automatic roofs are built. See "Gable/Roof Lines" on page 248.

You can manually edit or delete this gable line at any time. Your changes take effect

when the automatic roofs are rebuilt. This can also be used with group selected doors.

## Door Specification Dialog

To open the **Interior** or **Exterior Door Specification** dialog, select a door and click the **Open Object** edit button or double-click on a door using the **Select Objects**  or any **Door**  tool.

Whether a selected door is Interior or Exterior depends on where it is placed. See “Interior vs Exterior Doors” on page 179.

### General Panel

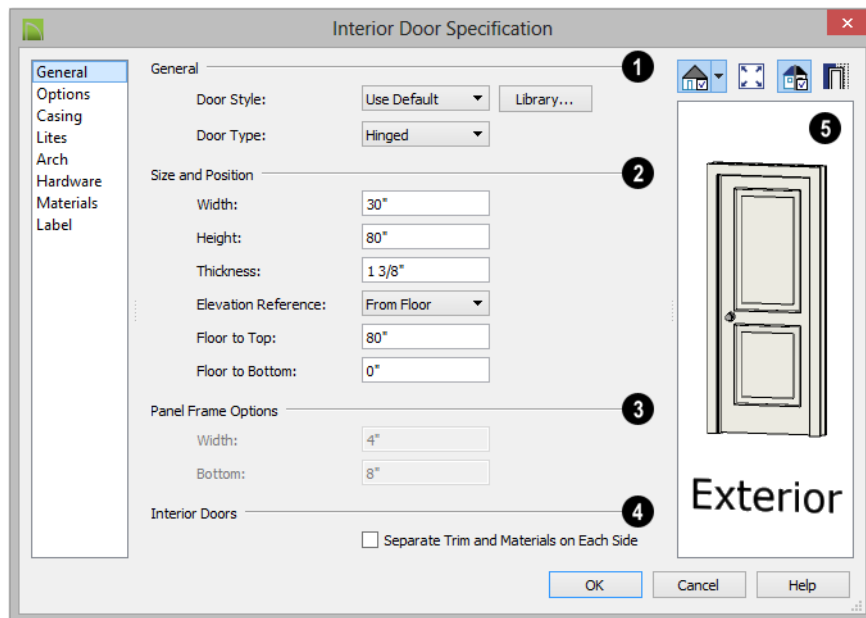

#### 1 General -

- **Door Style** - Select Slab, Glass, Panel, or Louvered from the drop-down list; select a style from the Library; or choose Use Default to use the default door style set in the **Door Defaults** dialog. See “Door Defaults” on page 179.
- Select “Library” from the drop-down list or click the **Library** button to choose a door symbol from the library. Once a library door is selected, its name is added

to the Door Style list. See “Select Library Object Dialog” on page 408.

- Specify the **Door Type** as Doorway, Hinged, Slider, Pocket, Bifold, or Garage. In the Door Defaults dialogs, the Door Type cannot be changed.
- ② Specify the **Size and Position** of the selected door.
- Specify the **Width, Height, and Thickness** of the door.
- Select the **Elevation Reference** from the drop-down list. This determines where the next two settings are measured from and also affects their labels.
- Specify the height **to Top**, measured from the selected Elevation Reference to the top of the door frame.
- Specify the height **to Bottom**, measured from the selected Elevation Reference to the bottom of the door frame.

③ **Panel Frame Options** - Specify the dimensions of the selected door’s rails and stiles. Only available for Glass, Panel, and Louvered doors.

- Specify the **Width** of the stiles and top rail.
- Specify the height of the **Bottom** rail.

④ The **Interior Doors** settings are only available when the selected door is placed in an interior wall. See “Exterior and Interior Walls” on page 125.

- Check **Separate Trim and Materials for Each Side** to specify the casing, lintels, and all materials for each side of the selected door independently. When unchecked, the two sides of the door use the same trim and materials.

⑤ A preview of the door displays on the right side of the dialog box. A label indicates which side of the door is its Interior and which is its Exterior. See “Dialog Preview Panes” on page 32.

## Options Panel

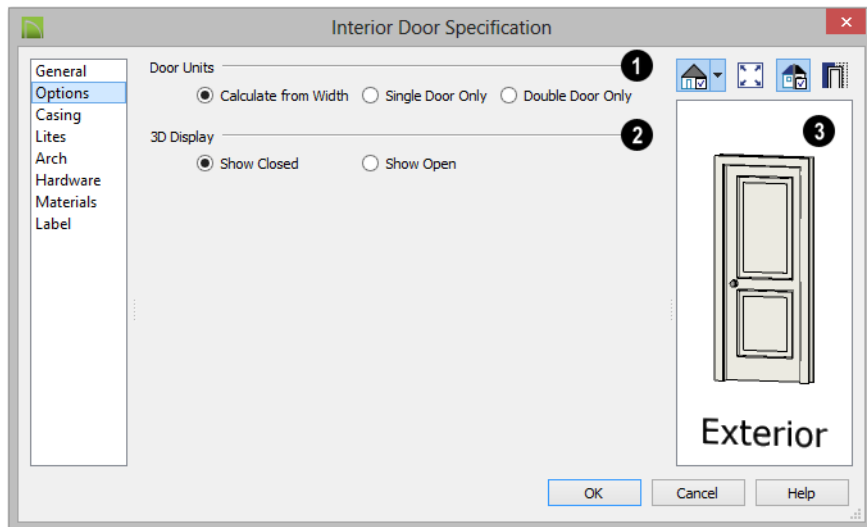

- 1 Specify the number of **Door Units** or panels that the selected door has. Not available for garage doors.
  - Select **Calculate From Width** to use the program defaults. Hinged, Pocket and Bifold doors default to **Single Door** when less than four feet (1200 mm) wide. If the width is greater than four feet, **Double Door** is the default.
  - Select **Single Door** to force the selected hinged, pocket or bifold door to be a single door, regardless of its width.
  - Select **Double Door** to force the selected hinged, pocket or bifold door to be a double door, regardless of its width.

- If a Slider door is selected, instead choose **Two, Three, or Four Panel**.

Note: The defaults for Calculate From Width are not editable.

- 2 **3D Display** - Specify whether the selected door is drawn open or closed in 3D and Elevation views.

If **Draw Open** is selected, the Swing Angle set on the GENERAL panel is used in 3D views. See “General Panel” on page 189.

- 3 A preview of the door displays on the right side of the dialog box. See “Dialog Preview Panes” on page 32.

## Casing Panel

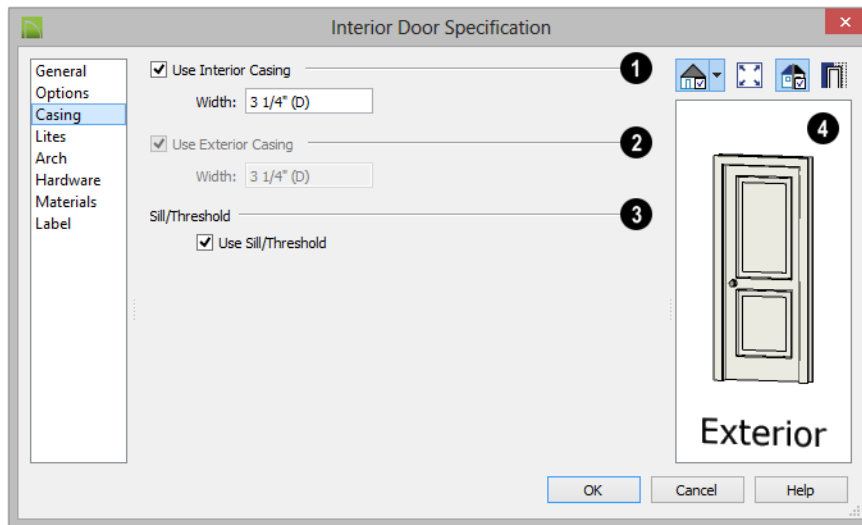

- 1 Check **Use Interior Casing**, then specify the **Width** of the casing.
- 2 Check **Use Exterior Casing**, then specify the **Width** of the casing. Not available for doors in interior walls unless **Use Exterior Trim and Materials** is checked on the **GENERAL** panel. See “General Panel” on page 189.

- 3 Uncheck **Use Sill/Threshold** to prevent a sill from being generated under the door. See “Displaying Doors” on page 182.
- 4 A preview of the door displays on the right side of the dialog box. If casing is not specified for a Doorway, the **Show Wall** option will be toggled on automatically. See “Dialog Preview Panes” on page 32.

## Lites Panel

The settings on the **LITES** panel of the **Door Specification** dialogs are only available when the selected door is specified as a Glass door on the **General Panel**. These settings are

also found on the **LITES** panel of the **Window Specification** dialog. See “Lites Panel” on page 208.

## Arch Panel

The settings on the **ARCH** panel are not available if the selected door is a Sliding, Bifold or Garage door.



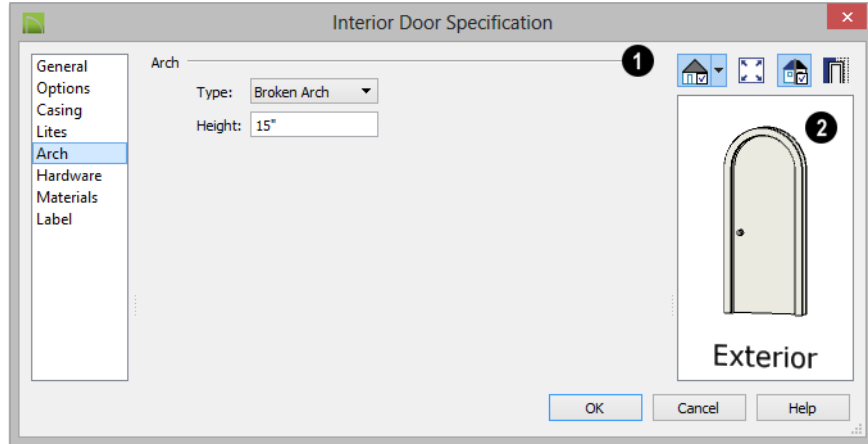

**1** Define the style and size of the **Arch**.

- Select a **Type** of arch from the drop-down list.
- Specify the **Height** of the arch, as measured from the base of the arch to the top

of the door. Not available for Round Top Arches.

- 2** A preview of the door displays on the right side of the dialog box. See “Dialog Preview Panes” on page 32.

## Hardware Panel

Many of the settings on the **HARDWARE** panel are Dynamic Defaults: if “Use Default” is selected, the setting in the **Door**

**Defaults** dialog is used. See “Dynamic Defaults” on page 59.

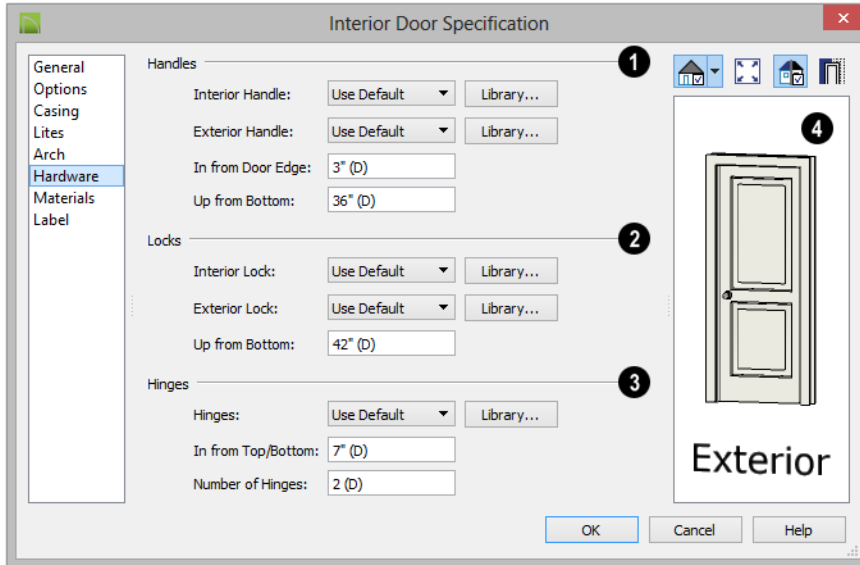

**1** Specify the **Handles** to be used on the selected door.

- Select an **Interior Handle** and/or **Exterior Handle** from the drop-down lists. Select “Library” or click the **Library** button to select a handle from the library. See “Select Library Object Dialog” on page 408.
- Specify the location of the door handles **In From Door Edge**.
- Specify the location of the door handles **Up From Bottom**.

**2** Specify the door’s interior and exterior **Locks**.

- Select an **Interior Lock** and/or **Exterior Lock** from the drop-down lists. Select “Library” or click the **Library** button to select a lock from the library.

- Specify the location of the door locks **Up From Bottom**. The locks use the same In From Door Edge value as the handles.

**3** Specify the **Hinges** to be used on the selected door.

- Select a style of **Hinges** from the drop-down list. Select “Library” or click the **Library** button to select a hinges from the library.
- Specify the distance **In From Top/Bottom** of the door to the center of the top and bottom hinges.

Note: For hinges to look right, it is best to have at least a 1/4" (6 mm) reveal for the interior, or hinge side, door casing.

- Specify the **Number of Hinges** on the selected door. Interior hinged doors and bifold doors typically have two hinges while exterior hinged doors have three.

- 4 A preview of the door displays on the right side of the dialog box. See “Dialog Preview Panes” on page 32.

### **Materials Panel**

The MATERIALS panel is available for a variety of objects throughout the program. For more information, see “Materials Panel” on page 420.

### **Label Panel**

Door labels display in floor plan view when the “Doors, Labels” is turned on and use the Text Style assigned to that layer. See “Door Labels” on page 183.

For information about the settings on this panel, see “Label Panel” on page 576.



# Windows

Home Designer Architectural can model a wide variety of windows. Fixed glass, hung, casement, sliding, awning, hopper, and louver window styles can all be created with the standard Window tool. Home Designer Architectural can create bay, box, and bow windows with a single click. In addition, the library contains many mullied window combinations.

## Chapter Contents

- Window Defaults
- The Window Tools
- Special Windows
- Grouped Windows
- Displaying Windows
- Editing Windows
- Window Specification Dialog
- Bay, Box, and Bow Windows
- Bay, Box, Bow Windows and Roofs
- Bay/Box and Bow Window Specification Dialogs

---

## Window Defaults



Default Settings can be accessed by selecting **Edit> Default Settings**. Select Window from the **Default Settings** dialog.

The settings in the **Window Defaults** dialog control the attributes of a window when it is initially placed in a plan, so you should define the type of window that will be placed most often in your model. See “Default Settings vs Preferences” on page 58.

The panels in the **Window Defaults** dialog are similar to those found in the **Window Specification** dialog. For more information,

see “Window Specification Dialog” on page 205.

### Dynamic Window Defaults

A variety of window default values are dynamic, including the **Window Type**, **Casing Specifications**, **Sash** sizes, and **Treatments**. All **Materials** are also dynamic. When a dynamic default is changed, existing windows using the default value are affected. See “Dynamic Defaults” on page 59.

---

## The Window Tools



To place a window, select **Build> Window** and choose the desired Window Tool. Move your mouse pointer over a wall section, then click to place a window in the wall at that location.

- If there is room enough along the wall to fit a 6” (150 mm) wide Standard Window, a preview of the window will display and a window can be placed.
- The Bay, Box, and Bow Window tools do not have preview outlines. If a minimum width of 30” (725 mm) cannot be accommodated at the location where you click, a warning message will display and a window unit will not be created.

Standard Windows can be placed in both straight and curved walls, as well as span across straight, collinear wall segments. In contrast, a Bay, Box, or Bow Window can only be placed in a single, straight wall.

Windows cannot be placed in a wall specified as Invisible. See “Room Dividers and Invisible Walls” on page 127.

### Standard Windows



Select **Build> Window> Window**, then click on a straight or curved wall to place a Standard Window at that location.

A Standard Window is a single window that is not a bay, box, or bow window. These special types are made up of multiple Standard Windows.

A Standard Window that is part of a special window is called a Component Window.

Standard Windows can be specified as any of a variety of window types, such as double hung, casement and awning. See “Window Specification Dialog” on page 205.

## Bay Windows

 The roof is affected by Bay, Box and Bow Windows. These windows should therefore be placed before the roof is built.

 A **Bay Window** is composed of three wall sections, each with a single component window. The two side walls are at an angle to the main wall. Select **Build> Window> Bay Window** and click on a straight wall to produce a bay window.

When initially placed, bay windows measure 2'-2" across at the front, 4'-2" across at the back, and are 1'-0" deep. The component windows are specified in the **Window Defaults** dialog and their sizes adjust to fit the available space.

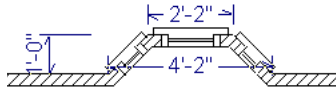

## Box Windows

 A **Box Window** is a bay window with side angles set at 90°. Select **Build> Window> Box Window** and click on a straight wall to produce a box window.

Box windows initially measure 4'-2" wide with a depth of 1'-6". The component windows are specified in the **Window Defaults** dialog and their sizes adjust to fit the available space.

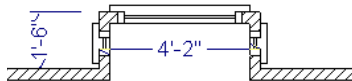

## Bow Windows

 A **Bow Window** is a group of identical wall segments that form a segmented curve. Select **Build> Window> Bow Window** and click on a straight wall to produce a 5-section bow window.

The component windows are specified in the **Window Defaults** dialog. Their sizes adjust to fit the available space.

The 5-section bow below has a 4'-10" radius centered 3'-9" inside the wall, giving an opening 5'-10" across and a depth of 11½".

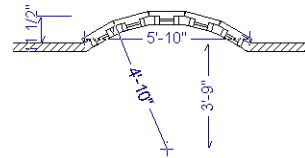

Note: Bay, box, and bow window areas are not included in the living area or in room standard area calculations. They are included in room interior area calculations.

## Pass-Through

 Select **Build> Window> Pass-Through**, then click on a straight or curved wall to place a Pass Through at that location.

A Pass-Through is simply a wall opening without a window unit placed inside. Like a window, it can have casing and a sill. It does not, however, have a sash, frame, or glass. It is one of the window **Types** available in the **Window Specification** dialog. See "General Panel" on page 205.

## Windows Library



Select **View > Library Browser**, then browse to Home Designer Core Catalogs > Architectural > Windows to access

a selection of special window units. Select the desired window, then click on a wall to place the window at that location.

---

## Special Windows

A variety of special windows can be created using multiple standard windows, the edit tools or custom symbols.

### Creating Manual Bay, Box and Bow Windows

Sometimes it is easier to draw bay, box and bow windows manually than to use the automatic tools. Bays created using walls can have more than one window per section, which is not possible using a bay window unit.

Bear in mind that moving a manually created bay, box or bow window is generally more difficult than moving a unit created with one of the **Window Tools**  since it is composed of individual walls.

### Corner Windows

To create a corner window, first create the desired window on each side of the corner. For best results, the heights, casing, and sills of both windows should be the same.

There are a number of ways to control the size of the corner post.



- Use dimensions to position the windows relative to the corner. By default, windows will stop when their interior casing bumps into the adjacent wall. See “Editing Windows” on page 203.
- To move a window all the way into a corner, check **Ignore Casing for Opening Resize**. See “General Plan Defaults Dialog” on page 60.
- To produce a minimal corner post and no siding or casing between the windows, use their Move edit handles. Click and drag each window past the exterior corner until its preview outline moves into the middle of the wall corner.

### Special Window Shapes

A selection of special shaped windows is available in the Windows Library, including arched windows and mullied units.



In addition, you can create a variety of window shapes in the **Window Specification** dialog, including:

- Arched windows. See “Arch Panel” on page 210.
- Trapezoidal windows. See “Shape Panel” on page 209.

### Placing a Gable Over a Window



Click the **Gable Over Door/Window** edit button to produce a gable roof over the selected window(s) the next time automatic roofs are built. See “Gable/Roof Lines” on page 248.

You can manually edit or delete this gable line at any time. Your changes take effect

when the automatic roofs are rebuilt. This tool can also be used with group selected windows.

### Stained Glass

A selection of solid stained glass materials is available in the Home Designer Core Catalogs> Materials> Glass library. See “Materials” on page 415.

### Vents

A selection of attic, foundation and gable vents are available in the Library Browser. See “The Library” on page 393.

Vents are placed in the same manner as regular windows and can be edited in much the same way, as well.

---

## Grouped Windows

Windows can be grouped together to create a wide variety of custom configurations. Stacked windows are easy to create in 3D views, particularly Elevation views, using their edit handles. See “Editing Windows” on page 203.



Notice how the windows and door in this example are separate, with spaces between

them. Doors and/or windows can also be organized into a unit in which there are no spaces between the windows and door units, and the casing between them is shared.

### Automatically Mullered Openings

To form a mulled group of windows and/or doors, move them close enough together so that their casings touch. Once the casings touch, the windows are mulled together with one casing between the two of them.

The sill of each window in the group must be at the same level for them to share the middle casing. The casing tops do not have to be at the same level. The casings are modeled as if they are one unit but the windows remain separate objects for dimensioning and the Materials List.

Windows can be automatically mulled to doors if the bottom of the window is at the elevation of the floor, equal to the bottom of the door.

## Mulled Units in the Library

A selection of mulled window units is available in the Windows library. To place one in your plan, select it and click on a wall in any view. See “Placing Library Objects” on page 406.

### Selecting Components of Mulled Units

To select a component of a mulled unit from the library, click at the location of the component in question, then click the **Select**

**Next Object**  edit button or press the Tab key until that individual component is selected. Only the component clicked on is selectable using this method. If you need to select a different component, click on it and repeat the process.

If there are multiple levels, it is easiest to select the components in a 3D view. When

you have selected an individual component, you can change its parameters in the **Window Specification** dialog. See “Window Specification Dialog” on page 205.

If the selected component is not itself a mulled unit and has no components above it, its **Height** and **Arch** parameters can be changed. Changing the Height causes the component top to move. The bottom remains stationary.

### Displaying Mulled Units



As with other windows, the display of mulled window units is controlled in the **Display Options** dialog. See “Displaying Objects” on page 76.

Mulled units are placed on the “Windows” layer by default and have a single label, which is on the “Windows, Labels” layer. Mulled units from the library are also included in the windows category of the Materials List. If the component objects of a mulled unit have unique moldings or materials, they will not be noted in the Materials List.

---

## Displaying Windows



The display of windows in floor plan and 3D views can be controlled in the **Display Options** dialog. See “Display Options Dialog” on page 77.

Windows can only be placed in walls, so if a wall’s layer is turned off, any windows placed in that wall will not display, either. See “Displaying Walls” on page 132.

If the “Windows” layer is not set to display, window casing and other components are not visible, but the openings in the walls where they are located can still be seen.

### In Floor Plan View

A window’s frame, glass, and sill are all represented in floor plan view. This makes some window types, notably Sliding and

Double and Triple Casement windows, distinguishable.

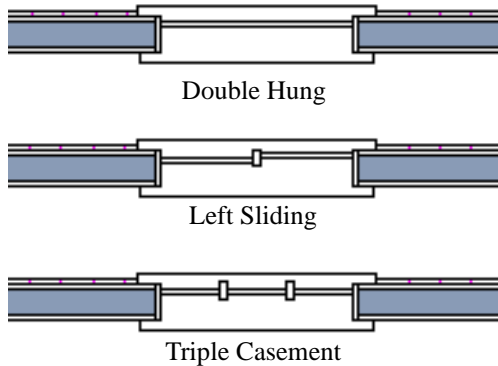

*Window types in floor plan view*

Bay, box, and bow windows have dimension lines associated with them.

- You can suppress their display by turning off the “Manual Dimensions” layer or on a unit by unit basis in the unit’s specification dialog. See “Bay/Box and Bow Window Specification Dialogs” on page 216.
- The arrow style and fill are set in the **Dimension Defaults** dialog. See “Dimension Defaults Dialog” on page 485.

## Window Labels

Window labels display in floor plan view, centered on the windows they represent, when the “Windows, Labels” layer is turned

on and use the “Default Label Style” Text Style. See “Object Labels” on page 575.

Window labels indicate Width and Height, followed by Type. For example:

- In Imperial plans, the automatic label for a 3’-0” wide, 4’-0” high double hung window will read 3040 DH.
- In metric plans, the automatic label for a 900 mm wide, 1200 mm high double hung window will read 900x1200 DH.

You can specify whether a Bay, Box or Bow Window displays a single label or displays the labels of its component windows.

- When **Suppress All Labels** is selected, individual components of Bay, Box and Bow Windows are counted in the Materials List.
- When **Show Component Labels** is selected, components of Bay, Box and Bow Windows are counted in the Materials List.
- When **Show Single Label for Entire Unit** is selected, the Bay, Box or Bow Windows has one label in floor plan view but each component is counted separately in the materials list.

These options are also available for mullied units but affect their display the materials list somewhat differently. See “Displaying Mullied Units” on page 202.

Customized labels can also be specified in the **Window Specification** dialog.

---

## Editing Windows

Before a window can be edited, it must be selected. Click on a window when the **Select**

**Objects**  tool or any of the **Window**

**Tools**  are active. Doors and/or windows can also be group-selected and edited. See “Selecting Objects” on page 88.

To select a window that is part of a blocked unit, click the component window, then click the **Select Next Object**  edit button. See “Selecting Components of Muller Units” on page 202.

Windows can be edited using their edit handles, the edit toolbar buttons, and the **Window Specification** dialog. See “Window Specification Dialog” on page 205.

When you select a window in floor plan view, the window size label displays the width followed by the height. For example, a 3036 window is 3’-0” wide by 3’-6” high.

### In the Specification Dialog

 The most precise method of editing a window is to use the **Window Specification** dialog. The window type, size, casing, materials, and more can all be specified in this dialog. See “Window Specification Dialog” on page 205.

### Using the Mouse

In floor plan view, click either of the two end handles and drag along the wall to change the width. The label showing the size updates as the window is resized.

In 3D views, a selected window has five edit handles: the Move handle at the center and a Resize handle on each edge. Click and drag an edge handle to resize the window.

A single window or a group of windows can be moved with the center edit handle.

A door or window moved against an intersecting wall temporarily stops when it is the casing distance from the intersecting wall. Enable **Ignore Casing for Opening Resize** in the **Plan Defaults** dialog to turn off this behavior. See “General Plan Defaults Dialog” on page 60.

You can continue to drag the selected window and it will resume movement past or onto the intersecting wall.

To create a corner window, drag the Move handle straight out past the wall corner, parallel to the selected window’s wall. See “Corner Windows” on page 200.

### Using Dimensions

 Like various other objects, windows can be moved using dimensions. See “Moving Objects Using Dimensions” on page 494.



Dimensions can be set to locate the centers, sides, casing, or rough opening of wall openings, or you can choose to not locate openings at all. If you wish, you can move a dimension’s extension lines to locate non-default locations on a window after the dimension is drawn. See “Editing Extension Lines” on page 493.

### Using the Edit Tools

A selected window or windows can be edited in a variety of ways using the buttons on the edit toolbar. See “The Edit Toolbar” on page 28.

- Click the **Gable Over Door/Window**  to create a gable over the selected window(s) the next time the roof is rebuilt. See “Gable/Roof Lines” on page 248.

## Window Specification Dialog

 To open the **Window Specification** dialog, select a window and click the **Open Object** edit button; or double-click the window using the **Select Objects**  or a **Window**  tool.

The settings in this dialog are similar to those in the **Window Defaults** dialog. See “Window Defaults” on page 198.

The settings in this dialog are also similar to those in the **Mulled Unit** and **Window Symbol Specification** dialogs. Although similar, a number of the options cannot be edited when either a window symbol or a mulled unit from the library is selected, and some panels are not available. See “Grouped Windows” on page 201.

### General Panel

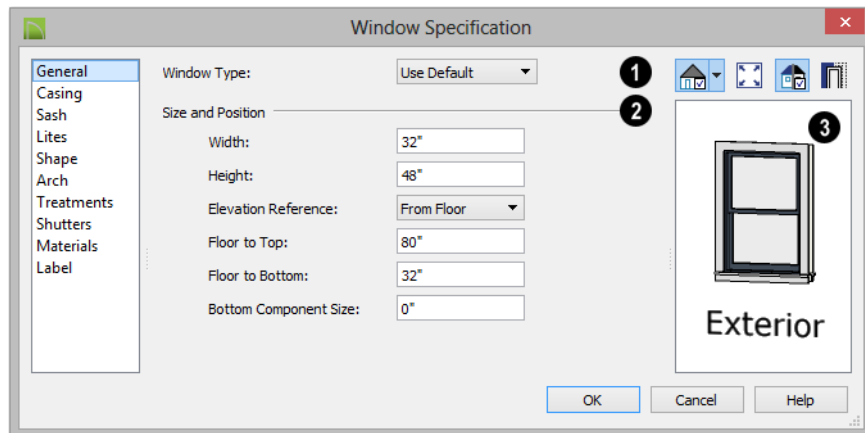

**1** **Window Type** - Select the type of window from the list. The first entry in the list is the Default type set in the **Window Defaults** dialog.

**2** Specify the **Size and Position** of the selected window.

- Specify the window’s **Width** and **Height**.
- Select the **Elevation Reference** from the drop-down list. This determines where the next two settings are measured from and also affects their setting labels.

- Specify the height **to Top**, measured from the selected Elevation Reference to the top of the window frame.
- Specify the height **to Bottom**, measured from the selected Elevation Reference to the bottom of the window frame.

Note: When either the Floor to Top or Floor to Bottom setting is modified, the other will adjust in response to prevent the window’s Height from changing.

- Specify the **Bottom Component Size** for Single Hung, Double Hung, Double Awning, Double Hopper, and Triple Hopper windows; specify the **Top/Bottom Component Size** for Triple Awning windows; or,
- Specify the **Side Component Size** for Triple Casement and Triple Sliding windows, the **Right Component Size** for Left Sliding windows, or the **Left Component Size** for Right Sliding and Double Casement windows.

A **Component Size** value of 0 creates a window with identically sized components.

**3** The **Interior Windows** settings are only present when the selected window is a Pass-Through placed in an interior wall. See “Exterior and Interior Walls” on page 125.

- Check **Separate Trim and Materials for Each Side** to specify the casing and all materials for each side of the selected Pass-Through independently. When unchecked, the two sides use the same trim and materials.

**4** A preview of the selected window displays here. A label indicates which side of the window is its Interior and which is its Exterior. See “Dialog Preview Panes” on page 32.

## Casing Panel

The CASING panel is not available in the **Window Symbol Specification** dialog.

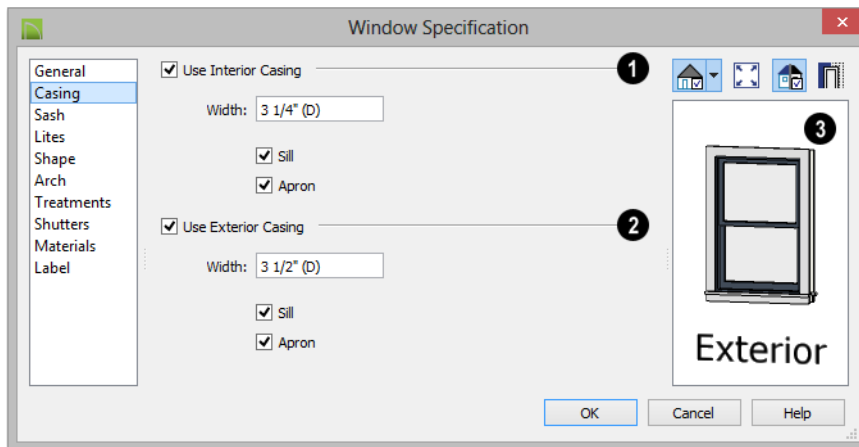

- 1** Check **Use Interior Casing**, then specify the **Width** of the casing.
- 2** Check **Use Exterior Casing**, then specify the **Width** of the casing. If the

selected window is a Pass-Through placed in an interior wall, these settings will be unavailable unless **Separate Trim and Materials on Each Side** is checked on the

GENERAL panel. See “General Panel” on page 205.

3 A preview of the selected window displays here. You may need to rotate the preview to see the casing you are

editing. If casing is not specified for a Pass-Through, the Show Wall option will be toggled on automatically. See “Dialog Preview Panes” on page 32.

## Sash Panel

The settings on the SASH panel control the size and position of the selected window’s sash. Note that increasing the Side, Middle,

Top or Bottom Width decreases the area of the glass and vice versa.

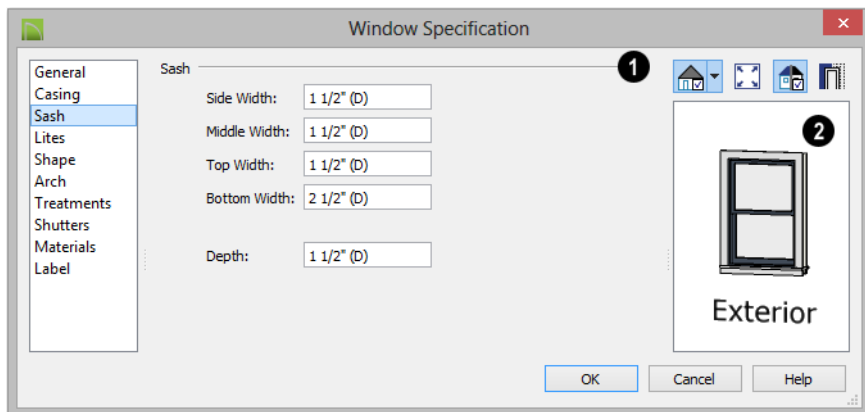

1 Specify the width and depth of the selected window’s **Sash**, which are the pieces of the window that hold the glass.

- Specify the **Side Width** of all vertical sash members: those at the window sides as well as the central members of Casement and Sliding windows. This is also the width of the top portion of the window when an arch is specified.
- Specify the **Middle** width of horizontal components between the top and bottom sash in Double Hung, Double and Triple Awning, and Double and Triple Hopper

windows. It does not affect Casement and Sliding windows.

- Specify the **Top** and **Bottom Widths**. The **Top** value is not used if the window has an arch.
- Specify the **Depth**, or thickness, of the sash stock measured from the exterior to the interior.

2 A preview of the selected window displays here. See “Dialog Preview Panes” on page 32.

## Lites Panel

The LITES panel allows you to add muntins to various window styles, and is also

available for Glass doors. See “Doors” on page 179.

There are four possible styles of muntin bars.

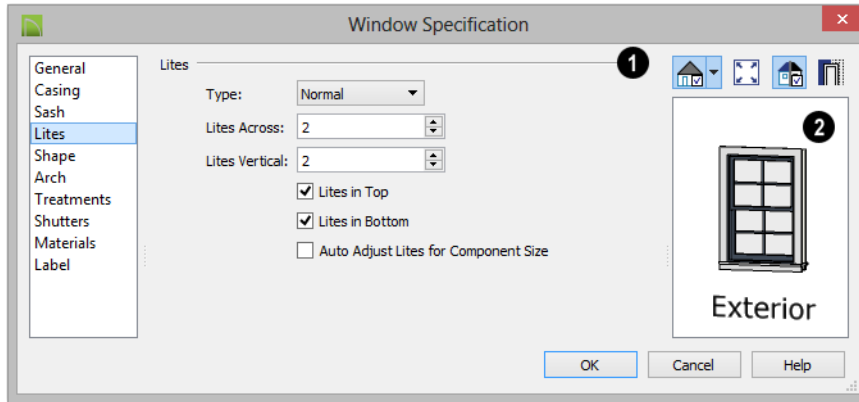

1 Specify the number, position and style of **Lites** for the selected window.

- Select a **Type**, or style, of window lite from the drop-down list.

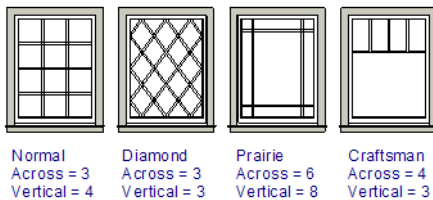

- **Normal** style is the most common, with muntins going horizontally and vertically. Colonial windows are an example of the normal style.
- **Diamond** style uses angled muntin bars to divide up the lites. French windows are an example of the diamond style.
- **Prairie** style is based on the normal style, but with all the central muntin bars

removed, leaving only the two outside muntin bars both horizontally and vertically. Typically, both Lites Across and Lites Vertical should be set between 6 and 8. Federal or Federation windows are an example of the Prairie style.

- **Craftsman** style is based on the normal style, but only the topmost horizontal muntin bar is kept with all the portions of the vertical muntin bars above it. Typically, both Lites Across and Lites Vertical should be set between 4 and 8.
- Enter the number of horizontal **Lites Across** in each sash.
- Enter the number of vertical **Lites Vertical** in each sash.
- Check or uncheck **Lites in Top** and/or **Lites in Bottom** - or **Lites in Left** and/or **Lites in Right** - to specify either one or both of the sashes to have divided lites.



- Check **Auto Adjust Lites for Component Size** to have the program produce lites that are consistent in size across all components. When this is checked, the window's lites and its specification settings may not agree; when unchecked, lites in the components may not be consistent in size.

Note: Because the fixed window in a Triple Sliding window is twice the size of the movable windows, the fixed section has a vertical muntin bar. To eliminate this, uncheck Auto Adjust Lites for Component Size..

- 2 A preview of the selected window displays here. See “Dialog Preview Panes” on page 32.

## Shape Panel

The settings on the SHAPE panel control the position of the selected window's corners, allowing you to create angled edges and mitered top corners.

If any of these settings are used to create a custom shape, the selected window will be automatically specified as “Fixed Glass” on the GENERAL panel. If the selected window

has an arch specified on the ARCH panel, it will be removed.

The SHAPE panel is not available for mullied units or window symbols from the library.

Note: The Left and Right settings on this panel refer to the window's exterior.

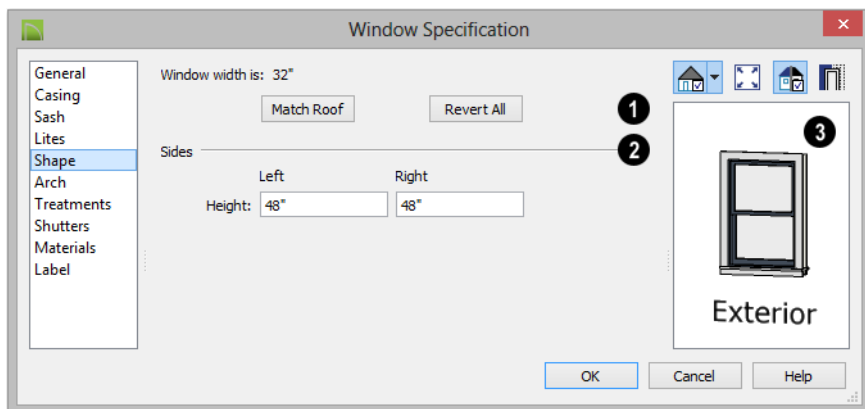

- 1 **Window Width** displays for reference. It can be changed on the General Panel.

- Click **Match Roof** to match the angle of the top of the window to the pitch of the

roof above by changing its Sides heights, below. If either Top Inside Corner box is checked, it will become unchecked.

Match Roof does not work for curved roofs, has no effect if the window is not

in a gable end wall, and is not available in the Window Defaults dialog.

- Click **Revert** to restore the window to its original shape, type and arch settings.

**2** Specify the height of the window's **Left** and **Right Sides**, as measured from the bottom of the window. By default, these settings match the window's Height.

**3** A preview of the selected window displays here. You may want to rotate the view so the window's exterior can be seen. See "Dialog Preview Panes" on page 32.

Note: The Left and Right settings on this panel refer to the window's exterior.

## Arch Panel

The ARCH panel is not available for window symbols from the library, and its settings are

not available if the selected window has been modified using the Shape Panel.

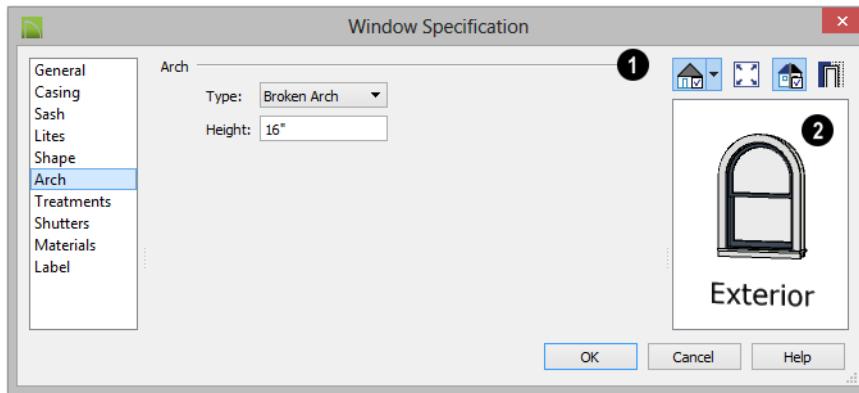

**1** Define the style and size of the **Arch**.

- Select the **Type** of arch desired from the drop-down list.

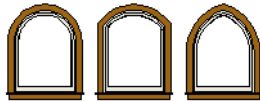

*Round Top   Broken   Gothic*

- Specify the **Height** of the arch, as measured from the top of the window to the

base of the arch. The Height can be defined for all arch types except Round Top and Octagonal Arches.

**2** A preview of the selected window displays here. You may want to rotate the view so the window's exterior can be seen. See "Dialog Preview Panes" on page 32.

Note: The Left and Right settings on this panel refer to the window's exterior.

## Treatments Panel

The settings on the TREATMENTS panel allow you to add embellishments to the interior and exterior of the selected window or mullied unit.

The TREATMENTS panel is not available for window symbols from the library.

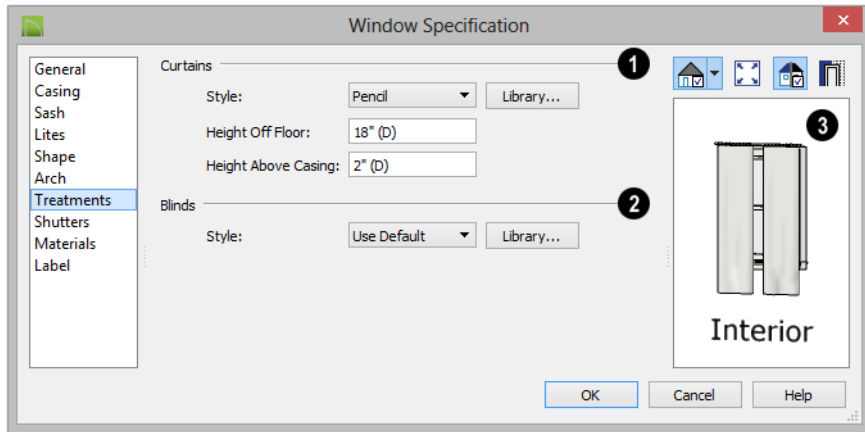

- 1 Specify **Curtains** for the selected window or mullied unit's interior side.
  - Specify a style of **Curtains** by selecting "Use Default", "None" or "Library" from the drop-down list. If a non-default library item has been selected, its name will display in the list, as well.
  - Click the **Library** button or select "Library" from the drop-down list to choose a style of curtain from the library. See "Select Library Object Dialog" on page 408.
- Specify the **Height Off Floor** of the bottom edge of the curtains.
- Specify the **Height Above Casing** of the top of curtains.
- 2 Specify a style of **Blinds** in the same manner that Curtains are chosen, above.
- 3 A preview of the selected window displays on the right. You may want to rotate the view so the window's interior or exterior can be seen, as needed. See "Dialog Preview Panes" on page 32.

## Shutters Panel

The settings on the SHUTTERS panel allow you to specify exterior shutters for the selected window or mullied unit from the library.

The SHUTTERS panel is not available for window symbols from the library.

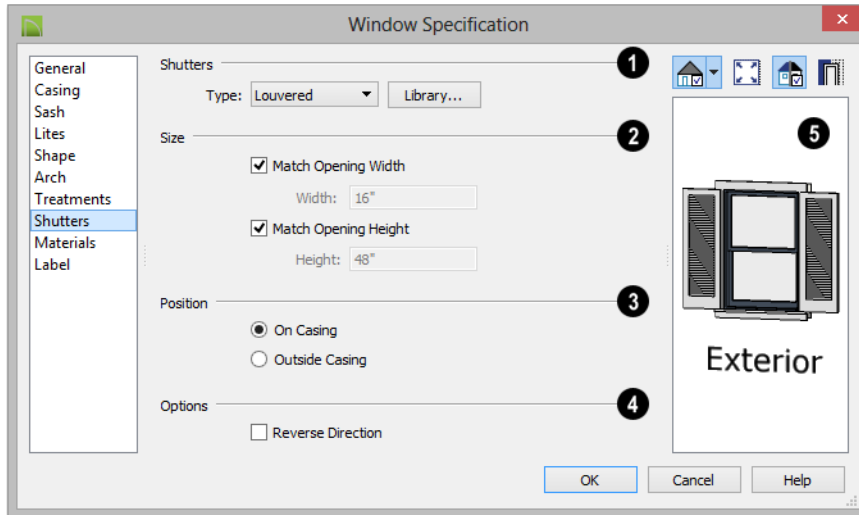

**1** Select a **Type** of **Shutters** from the drop-down list or click the **Library** button to select a style of shutters from the Library Browser. See “Select Library Object Dialog” on page 408.

- 2** Specify the **Size** of the selected shutters.
- When **Match Opening Width** is checked, each shutter’s width is exactly half that of the window, excluding casing.
  - Uncheck **Match Opening Width** to specify a **Width** in the text field. If the window is later resized, the shutters will not adjust in response.
  - When **Match Opening Height** is checked, each shutter’s height equals that of the window, excluding casing.
  - Uncheck **Match Opening Height** to specify a **Height** in the text field. If the window is later resized, the shutters will not adjust in response.

**3** Specify the **Position** of the shutters relative to the window.

- Select **On Casing** to position the shutters just outside the window frame, like functional shutters.
- Select **Outside Casing** to position shutters outside the window casing, as decorative shutters often are.

**4** Additional shutter **Options** can be specified here.

- Check **Reverse Direction** to orient the shutters so their exterior sides face outward and their interior sides face the wall. For functional shutters, this should remain unchecked.

**5** A preview of the selected window displays on the right. In order to see the shutters, you may need to rotate the preview to show the Exterior. See “Dialog Preview Panes” on page 32.

## Materials Panel

The settings on the MATERIALS panel are the same as those found on the same panel in dialogs throughout the program. See “Materials Panel” on page 420.

## Label Panel

Window labels display in floor plan view when the “Windows, Labels” layer is turned on and use the Text Style assigned to that layer. See “Window Labels” on page 203.

For more information about the settings on this panel. See “Label Panel” on page 576.

---

## Bay, Box, and Bow Windows



Bay, Box and Bow Windows are created much the way regular windows are: select a tool, then click a wall to place that window type.

Home Designer Architectural automatically builds a foundation under bay/box/bow windows placed on floor 1 unless they are raised from their original position. That section of the foundation wall is also a bay/box/bow, but without windows. If the foundation was generated before the window is placed, the foundation must be rebuilt or edited manually.

### Editing Bay, Box and Bow Windows

Bay, box and bow windows are edited similar to regular windows, with one exception: in floor plan view, a diamond-shaped Depth edit handle displays on the section. Drag this Depth handle outward to increase the depth, or inward to decrease the depth of the unit. See “Editing Windows” on page 203.

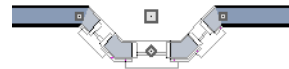

*Depth edit handle on a bay window*

Bay, box and bow windows can also be edited in their respective specification dialogs. See “Bay/Box and Bow Window Specification Dialogs” on page 216.

### Displaying Bay, Box and Bow Windows

The display of bay, box and bow windows is controlled in the **Display Options** dialog. See “Display Options Dialog” on page 77.

Like other windows, bay, box and bow windows can display labels: either a single label for the unit, or one for each component. See “Window Labels” on page 203.

Bay, box and bow window width and radius dimensions, which display in floor plan view when specified to do so in the window’s specification dialog, are placed on the “Dimensions, Manual” layer. See “Options Panel” on page 218.

## Component Windows

A component window within a bay, box or bow window can be resized like any other standard window. To select a component window, click at the location of the component in question, then click the **Select**

**Next Object**  edit button or press the Tab key.

- Only the bay or box window component that was clicked on is selected using this method. If you need to select a different component, click on it and repeat the process.
- In a bow window, all components are identical, so only one component can be selected. Changing this component changes them all.

## Resizing Components

An individual component window can be resized using the edit handles, by changing settings in the component's **Window Specification** dialog.

When a bay/box/bow window is first created, there is room for one standard trimmer on each side of each component window. When the bay as a whole is moved and resized, its components automatically resize so that a standard trimmer is still accommodated.

If a component window is resized, it retains its size if at all possible when the containing bay/box/bow window is moved or resized. If the bay is resized in such a way that the component is too large to fit even with a thinner trimmer, the component resumes its default behavior, resizing as the containing bay window is resized.

## Floors and Ceilings

When originally created, the floor and ceiling within a bay, box, or bow window are the same heights as the floor and ceiling of the room in which it is placed.



Both the top and bottom heights of these window units can be adjusted in its specification dialog or a 3D view using its edit handles to create a lowered ceiling and/or a bench seat or garden window.



When the ceiling is lowered, the top heights of the walls that define the window unit are also lowered. When a roof is built over the unit, its height will be affected, as well.

When the bottom of the window is raised to create a bench seat, the unit's walls will not

reach the ground. As a result, window units with bench seats will have no foundation beneath them when the foundation is built.

---

## Bay, Box, Bow Windows and Roofs

Several different roof styles can be specified for bay, box and bow window units in the **Bay/Box/Bow Specification** dialog. See “Bay/Box and Bow Window Specification Dialogs” on page 216.

If you change a bay, box, or bow window’s roof specification, you will need to rebuild the roofs to see the changes. See “Rebuilding Roofs” on page 245.

### Hip Roofs

By default, a hip roof is built above the unit when roofs are automatically generated. No roof directives need to be selected in the specification dialog to produce this roof.



### Use the Existing Roof

To generate a standard roof that ignores a bay, box, or bow window, check **Use Existing Roof**.

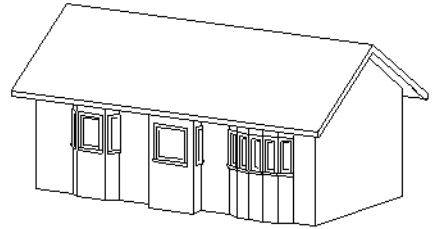

With this option the bay, box, or bow windows is tucked under the roof eave. You may find it helpful to increase the width of the eaves. See “Roof Panel” on page 246.

### Extend the Existing Roof

To have the main roof extend down over the window unit and follow the shape of the unit, select **Extend Existing Roof**.

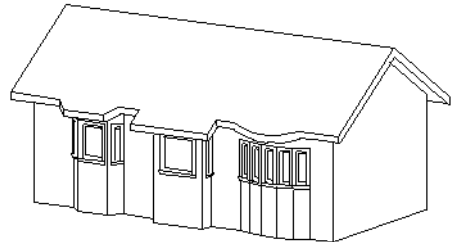

For this roof style, the ceiling heights of the window unit and the adjacent room must be the same. If you lower the ceiling of the window unit and then build the roof, a lower hip roof over the window is created. See “Floors and Ceilings” on page 214.

If a header is desired over the window unit, first build the roof, then lower the ceiling of the window unit. Do not rebuild roof planes.

### Rectangular Hip Roofs

To create a rectangular-shaped hip roof above a bay, box, or bow window, select **Rectangular Roof Over**.

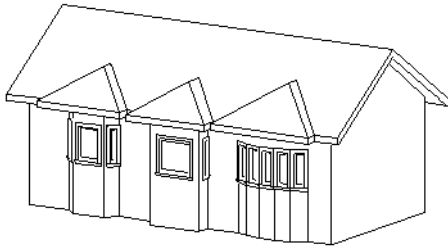

### Extend Existing Roof - Rectangular

To extend the main roof down over a window unit to create a rectangular roof over it rather

than one that follows its shape, select both **Extend Existing Roof over** and **Rectangular Roof Over**.

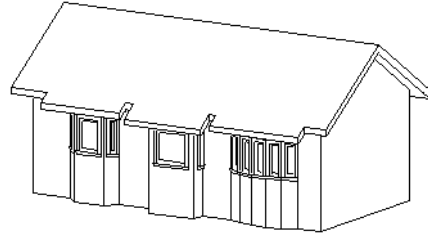

### Gable Roof

A gable roof is not one of the automatic options for the roof above a bay, box or bow window.



To create a gable roof over a normal window, use the Gable Over Door/Window edit button. See "Gable/Roof Lines" on page 248.

---

## Bay/Box and Bow Window Specification Dialogs



To open the **Bay/Box Window Specification** or the **Bow Window Specification** dialog, select a Bay, Box or Bow Window and click the **Open Object** edit button.

The options in this dialog can only be set for objects placed in a plan: Bay, Box, and Bow Windows do not have defaults dialogs.



## General Panel

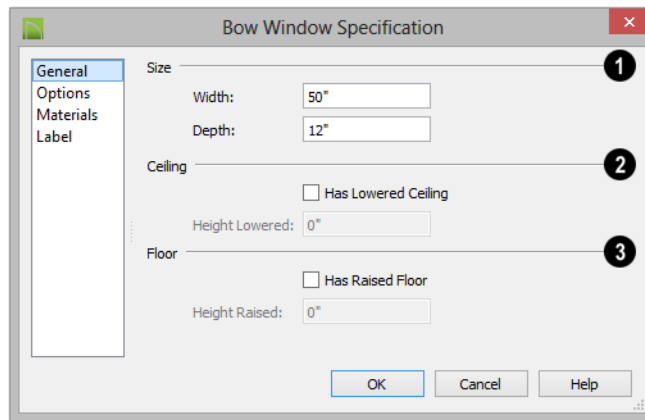

- 1 **Size** - Specify the **Width** and **Depth** of the selected Bay, Box, or Bow Window.
- 2 Specify the height and structure of the **Ceiling** within the selected window.
  - Check **Has Lowered Ceiling** to enable the settings that follow. When this is unchecked, the ceiling height and finish material within the window is the same as that for the adjacent room.
  - Specify the **Height Lowered**, which is measured from the ceiling height of the adjacent room.

Note: If the Height Lowered is 0", Has Lowered Ceiling will become unchecked when you click OK.

- 3 Specify the height and structure of the **Floor** within the selected window.
  - Check **Has Raised Floor** to enable the settings that follow. When this is unchecked, the floor height and material within the window is the same as that for the adjacent room.
  - Specify the **Height Raised**, which is the measured from the floor height of the adjacent room.

Note: If the Height Raised is 0", Has Raised Floor will become unchecked when you click OK.

## Options Panel

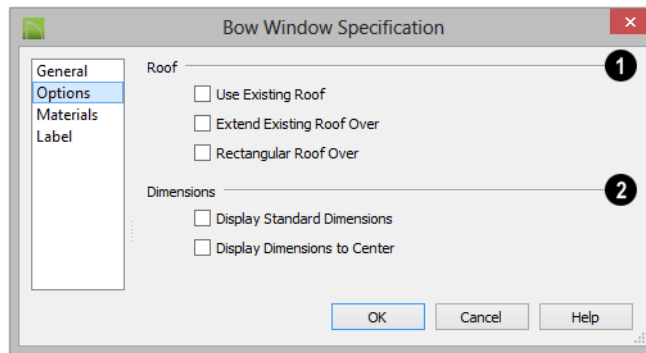

- 1** Specify the structure of the **Roof** over the selected window unit. See “Bay, Box, Bow Windows and Roofs” on page 215.

  - Check **Use Existing Roof** if the existing roof needs no changes to accommodate the bay window.
  - Check **Extend Existing Roof Over** to extend the existing roof plane to cover the bay window below.
  - Check **Rectangular Roof Over** to create a roof over the bay window that is square across the end instead of following the profile of the roof.
- 2** Specify the appearance of the selected window unit’s **Dimensions** in floor plan view.

  - Check **Display Standard Dimension** to display the automatically-produced dimensions that show the window’s width and depth.
  - Check **Display Dimensions to Center** to display a Bow Window’s radial dimension.

## Materials Panel

The settings on the MATERIALS panel are the same as those found on the same panel in dialogs throughout the program. See “Materials Panel” on page 420.

## Label Panel

Bay, Box, and Bow Window labels display in floor plan view when the “Windows, Labels” layer is turned on and use the Text Style assigned to that layer. See “Window Labels” on page 203.

For more information about the settings on this panel. See “Label Panel” on page 576.

# Multiple Floors

When a new plan file is opened in Home Designer Architectural, two floor levels are present: Floor 1 and the Attic Floor. You can add more floors whenever you like: up to 5 total. Once created, floors can also be copied and deleted.

Home Designer Architectural also supports special floors for foundations and attics. Only one foundation level and one attic can exist in a plan. Foundations are discussed in their own chapter. See “Foundations” on page 227.

## Chapter Contents

- Floor Defaults Dialog
- Floor Tools
- Adding Floors
- Displaying Floors
- Exchanging Floors
- Deleting Floors
- Split Levels
- The Current Floor
- The Attic Floor
- The Reference Floor

---

## Floor Defaults Dialog



There is a **Floor Defaults** dialog for each floor in a plan file. The defaults for the current floor can be accessed by selecting **Edit> Default Settings**. Select “Floor” from the category tree and click the **Edit** button to open the **Floor Defaults** dialog for the currently active floor. See “Default Settings vs Preferences” on page 58.

The **Floor Defaults** dialog also opens whenever you add a new floor to the plan. See “Adding Floors” on page 221.

The **Floor Defaults** dialog does not open when you build a foundation; however, the **Floor 0 Default** settings are created based on the current Foundation Defaults. See “Building a Foundation” on page 229.

The **Floor Defaults** dialog is similar to the **Room Specification** dialog, but controls the default settings for all rooms on the current floor. The settings here also control the height of individual walls as they are drawn on the floor in question. See “Room Specification Dialog” on page 172.

Note: The default floor height for Floor 1 is 0. It can be modified in the Room Specification dialog, but not in the Floor 1 Defaults dialog. See “Floor and Room Defaults” on page 160.

### Structure Panel

The settings on the **STRUCTURE** panel are similar to those in the **Room Specification** dialog. See “Structure Panel” on page 173.

### Moldings Panel

The settings on the **MOLDINGS** panel are similar to those in the **Room Specification** dialog. See “Moldings Panel” on page 306.

### Fill Style Panel

The settings on the **FILL STYLE** panel are similar to those in the specification dialogs for many objects throughout the program. See “Fill Style Panel” on page 519.

### Materials Panel

The settings on the **MATERIALS** panel are similar to those in the specification dialogs for many objects throughout the program. See “Materials Panel” on page 420.

---

## Floor Tools



Select **Build> Floor** to access the floor tools.



Select **Build> Floor> Build New Floor** to build a new floor. A new floor can be generated based upon the

perimeter of the floor below or a blank floor can be created and drawn from scratch. See “Adding Floors” on page 221.



Choose **Build> Floor> Delete Current Floor** to remove the current

floor from the plan. For more information, see “Deleting Floors” on page 223.



Choose **Build > Floor > Build Foundation** to open the **Foundation**

**Defaults** dialog and build a foundation floor. See “Building a Foundation” on page 229.



Select **Build > Floor > Delete Foundation** to remove the foundation from the plan. See “Deleting Foundations” on page 232.

## Adding Floors

When a new plan file is opened in Home Designer Architectural, two floor levels are present: Floor 1 and the Attic Floor. You can add up to 5 total living floors, as well as create a foundation below Floor 1.

Floors can be added whenever you like; and once created, they can also be copied and deleted.

Note: Home Designer Architectural allows only one floor, the foundation/basement, below the first floor. Keep this in mind when you begin an as-built or plan for a multi-story building. See “Foundations” on page 227.

### Build New Floor



New floors can be created in floor plan view as well as in 3D views, and are always added above the top living floor. To create a new floor, select **Build > Floor > Build New Floor**.

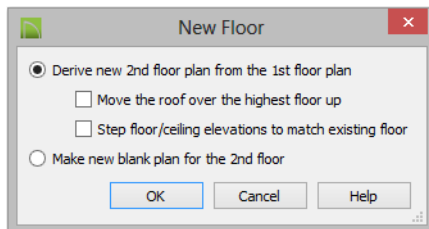

- **Derive new 2nd floor plan from the 1st floor plan** creates a new top floor with exterior walls generated directly over the exterior walls of the floor below. Wall types and roof directives associated with the walls on the floor below are duplicated; however, interior walls are not. See “Roof Panel” on page 148.
- Check **Move Highest Floor’s Roof Up** to move any roof planes displaying on the highest floor in the plan up one floor when the new floor is created. Roof planes displaying on floors other than the top floor are unaffected. This option is only available if there are roof planes built on the top floor and is not available when **Auto Rebuild Roofs** is enabled. See “Build Roof Dialog” on page 245.
- Check **Step floor/ceiling elevations to match existing floor** to maintain all ceiling heights on the existing floor by stepping floor heights on the new floor to match. Ceiling heights on the new floor also become stepped accordingly. See “Stepped Floor and Ceiling Platforms” on page 169.
- **Make new (blank) plan for the 2nd floor** creates a new top floor that is blank. This option is typically selected only if none of the exterior walls on the new

floor will be directly above the exterior walls on the floor below. If you choose this method, it may be helpful to turn on the Reference Floor when drawing walls on the new floor. See “The Reference Floor” on page 225.

When you click OK, the **Room Defaults** dialog for the newly created floor opens. Make any necessary changes to the floor structure, moldings, or materials and click OK. See “Floor Defaults Dialog” on page 220.

The new floor becomes the current floor in floor plan view. If, however, the new floor is created in a 3D view, the camera remains on its original floor and does not move.

## Adding a Foundation

To add a foundation, select **Build> Floor> Build Foundation** . See “Building a Foundation” on page 229.

---

## Displaying Floors

Home Designer Architectural allows you to view the floors in your plan in a variety of ways.



### In Floor Plan View

In floor plan view, only one floor can be active for editing at a time. This is referred to as the Current Floor. See “The Current Floor” on page 224.

In addition to the Current Floor, one other floor can be displayed for reference purposes: the Reference Floor. Objects on the Current Floor can snap to those on the Reference Floor, helping you align objects. See “The Reference Floor” on page 225.

### In 3D Views

In most 3D views, all floors in a plan are visible, from the foundation up to the attic. There are three exceptions:

- **Floor Camera**  views, which show the Current Floor only.
- **Doll House Views** , which show the Current Floor, not including its ceiling, plus any floors beneath it.
- **Interior Elevation**  views show a wall on a single floor, in a single room.

See “3D View Tools” on page 450.

---

## Exchanging Floors



Select **Build> Floor> Exchange With Floor Above** or **Exchange With Floor Below** to swap the current floor with the floor above or below.

The floor that was moved becomes the current floor at its new location. You can easily move a floor up or down several floors by using either one of these buttons repeatedly.

## Deleting Floors



Select **Build> Floor> Delete Current Floor** to remove the current floor from the plan. If there is a floor above, it becomes the current floor; if there is no floor below, the floor beneath becomes the current floor.



To delete Floor 0, select **Build> Floor> Delete Foundation**. You can

delete the foundation without actually being on Floor 0. Floor 0 cannot be deleted while **Auto Rebuild Foundation** is turned on. See “Deleting Foundations” on page 232.



When a floor is deleted, all objects on that floor are deleted with it.

## Split Levels

Both split level floor plans and split level entries can be created by controlling the floor and ceiling heights of individual rooms in a multiple story structure.

### Split Level Floor Plans

A split level, or tri-level, structure is a building where the floor level in one part of the plan is located approximately half way between the floor and ceiling levels of another part of the plan.



*Split Level Home*

#### *To create a simple split level plan*

1. Draw a simple rectangular structure divided into two separate halves by an interior wall.
2. Select one of the rooms and click the **Open Object**  edit button. See “Room Specification Dialog” on page 172.
3. Raise the **Floor Height** then press the Tab key.
4. Restore the **Relative Rough Ceiling** to the default value, then click OK.
5. Build a stem wall foundation. See “Foundations” on page 227.
  - The foundation under the room with the lower floor height will have the specified Min Stem Wall Height.
  - The foundation under the room with the raised floor will have taller stem walls.
  - Both can be edited in the **Room Specification** dialog.
6. If you add a Floor 2, note that the **Ceiling Height** in the room on Floor 1 will be reset to the default value.
  - To maintain a stepped condition on multiple floors, return to this room and

set the **Relative Rough Ceiling** back to using the default.

## Split Level Entries



A split level entry, or divided entry, is characterized by an entry door that opens onto a landing positioned half way between the basement floor and first floor levels.



*Split Level Entry*

### *To create a simple split level entry*

1. Create a plan file with a full basement at the location of the entry door. See “Basement Rooms” on page 233.

2. Go to Floor 0 and draw a stair **Landing**  at the location of the entry. See “Landings” on page 266.
3. Draw stairs upward from the basement floor to the landing.
  - The number of treads and risers in the stair section will determine the landing height.
4. Draw a second stair section from the landing upward.
5. Select the stairs and click the **Auto Stairwell**  edit button. See “Creating a Stairwell” on page 275.

Split level entries are often associated with daylight basements. See “Daylight Basements” on page 234.

For more detailed instructions, visit [www.HomeDesignerSoftware.com](http://www.HomeDesignerSoftware.com).

---

## The Current Floor

Only one floor can be active at any given time. The active floor is referred to as the **Current Floor**, and it is the only floor on which objects can be edited.

If you want to edit two different floors at the same time, you can open the plan again. This opens a second window on the current open plan that has the same editing abilities as the first. Only one of these windows can be active at any given time.

## Floor Up / Floor Down



If you are working with more than one floor, you can select **Tools> Reference Floors> Up One Floor** or **Down One Floor** to switch from one floor to another.

You can change the current floor in floor plan and 3D views. The current floor displays on the **Change Floor/Reference**  button, which can be found between the **Down One Floor** and the **Up One Floor** buttons.



Floors become available once they have been built. The Attic and foundation levels are also accessible using these tools.

## Change Floor / Reference



If there are multiple floors, select **Tools> Reference Floors> Change**

**Floor/Reference** to open the **Change Floor/Reference** dialog, where you can select both the current floor and which floor is used in the Reference Floor, as well as control the appearance of the Reference Floor.

## The Attic Floor



Home Designer Architectural automatically creates a floor above the top numbered floor level of each plan. This floor is called the Attic floor and has only one purpose: to provide a space for automatically generated Attic walls. See “Attic Walls” on page 141.

Because the Attic floor is not meant to be a living area, a warning message will display if

you try to draw walls or other objects on this floor.

In some situations, you may find it necessary to draw one or more walls on this floor; however, even if you enclose an area with walls, rooms cannot be created on the Attic floor.

If you wish to create an attic loft, bonus room, or storage area in your plan, you will need do so on a numbered floor level.

## The Reference Floor

When there is more than one floor in a model, it is often helpful to see how they relate to each other. Any floor can be shown as the **Reference Floor** along with the current floor.

When the Reference Floor Display is turned on, the floor that you were last on prior to the current floor is used as the Reference Floor and is shown in red. Objects on the Reference Floor cannot be selected or edited.

If the Reference Floor is turned on when a view is printed, it will be included in the printed output. See “Displaying Objects” on page 563.

Note: If objects on the current floor and the Reference Floor have edges that line up, the Reference Floor may be difficult to see on screen. When lines of two different colors are superimposed upon each other, discoloration may result.

## Reference Floor Display



To turn on the Reference Floor, select **Tools> Reference Floors> Reference Floor Display** or press F9 on your keyboard.

## Reference Floor Display Options



The display of objects in the Reference Floor is controlled by

selecting **Tools> Reference Floors> Reference Floor Display Options**. See “Display Options Dialog” on page 77.

## Change Floor / Reference



By default, the floor below the current floor is the Reference Floor, but any floor can be referenced using the **Change**

**Floor/Reference** dialog. To open the dialog, select **Tools> Reference Floors> Change Floor/Reference** button.

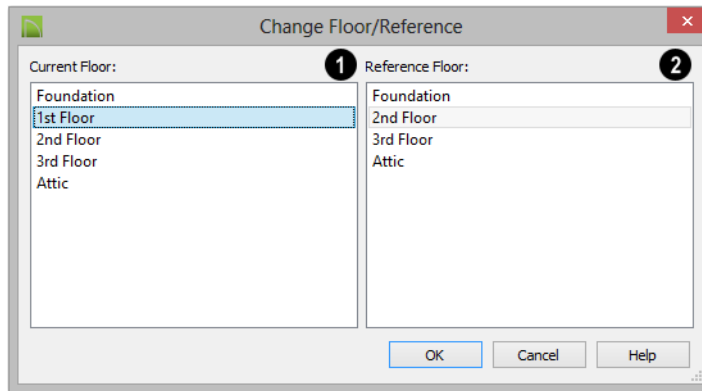

**1** The **Current Floor** is highlighted here. You can select another floor to make it the current floor.

**2** The **Reference Floor** currently used for reference is highlighted here. You can select another floor to display it instead.

## Swap Floor/Reference



If one floor is defined as the current floor and another floor is defined as the reference floor, select **Tools> Reference Floors> Swap Floor/Reference** to switch the status of the two floors.

# Foundations

There are two foundation types in Home Designer Architectural: stem walls with footings and monolithic slab. The foundation type can be specified in the **Foundation Defaults** dialog when the foundation is built on Floor 0.



Always consult registered geotechnical and civil engineers for information regarding the proper foundation for your site.

## Chapter Contents

- Foundation Defaults
- Building a Foundation
- Displaying Foundations
- Editing Foundations
- Aligning Foundation Walls
- Deleting Foundations
- Foundations and Rooms
- Foundations and the Terrain
- The Slab Tools
- Editing Slabs
- Slab Specification Dialog
- Fireplaces
- Fireplace Specification Dialog
- Library Fireplaces
- Chimneys

## Foundation Defaults



Foundation Defaults can be accessed by selecting **Edit > Default Settings**.

Select “Foundation” and click the **Edit** button to open the **Foundation Defaults** dialog.

The settings in the **Foundation Defaults** dialog are similar to those in the **Build**

**Foundation** dialog, which opens when

**Build > Floor > Build Foundation**  is selected. The primary difference is that when you click **OK** in the **Foundation Defaults** dialog, no changes are made to the model. See “Building a Foundation” on page 229.

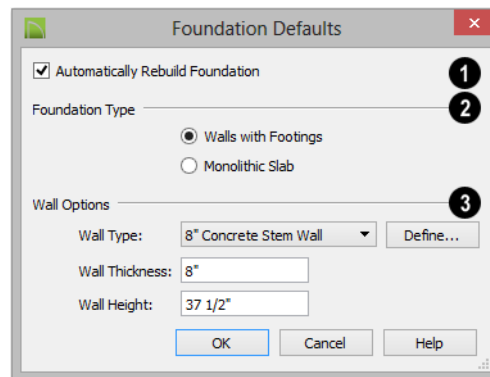

- 1 Check **Auto Rebuild Foundation** to automatically rebuild the foundation whenever changes are made to Floor 1 that affect the structure of the foundation. See “Rebuilding Foundations” on page 230.
- 2 Click the radio button beside either **Monolithic Slab** or **Walls with Footings** to specify which foundation type the program should build.
- 3 **Wall Options** - Specify characteristics of the foundation walls.
  - Select a **Wall Type** from the drop-down list. Click **Define** to open the **Wall Type Definitions** dialog and create a new wall

type. See “Wall Type Definitions Dialog” on page 144.

- **Wall Thickness** - Specify the desired thickness of the foundation walls. See “Wall Thickness” on page 137.
- **Wall Height** - Specify the desired height of the foundation walls.

If the wall height is at least 6 feet (1800 mm), a slab floor is generated above the footings and inside the foundation walls. The Wall Height includes the thickness of this slab.

If you do not want this slab, specify the “rooms” on Floor 0 as **Open Below** in the **Room Specification** dialog. See “Available Room Types” on page 164.

## Building a Foundation



Foundations can be generated automatically or drawn manually. A combination of the two methods can also be used.

Two foundation types are available: stem walls with footings and monolithic slabs. The first option is created using walls; the second creates concrete slabs with footings.

Automatically built foundations are placed on Floor 0 and are based on wall positions and floor heights on Floor 1. Foundation walls or slab footings are generated under:

- All exterior walls on Floor 1 that define a room other than a Court, Deck or Balcony room type. See “Room Definition” on page 160.
- Any interior walls on Floor 1 defining rooms with different floor heights. See “Floor and Ceiling Heights” on page 168.

At least one room must be defined on Floor 1 for a foundation to be automatically generated. If no rooms are defined on Floor 1, a blank Floor 0 is created.

There can be only one Floor 0 per plan. If your plan requires a foundation on more than one floor, you will need to draw the required foundation walls or slabs yourself.

### *To build an automatic foundation*

1. Select **Build> Floor> Build Foundation** .
2. Specify the desired foundation type and other information in the **Build Foundation** dialog. The settings in this dialog are similar to those in the Foun-

ation Defaults dialog. See “Foundation Defaults” on page 228.

3. In the **New Floor** dialog, select **Derive new Foundation plan from the 1st floor plan** and click **OK** to build a foundation based on Floor 1.

If you prefer, you can instead select **Make new (blank) plan for the Foundation** to create an empty foundation level where you can manually draw foundation walls or slabs.

In most cases, it is preferable to base Floor 0 off the first floor plan and then manually edit the foundation as needed. See “Editing Foundations” on page 230.

## Mixing Foundation Types

You can also create a foundation that combines stem walls and/or monolithic slabs.

### *To create a foundation of multiple types*

1. Begin by specifying any rooms on Floor 1 that require a slab floor as either a Garage or Slab **Room Type**. See “Foundations and Rooms” on page 232.
2. **Build Foundation** , as described above.
3. Once the foundation walls have been generated, they can be moved or deleted, and new **Foundation Walls** and/or **Slabs** can be drawn. See “Foundation Walls” on page 126 and “The Slab Tools” on page 235.

---

## Displaying Foundations



The display of foundation walls, slabs, curbs and footings is controlled in the **Display Options** dialog. See “Display Options Dialog” on page 77.

- Foundation Walls, including slab footings and Garage curbs, are placed on the “Walls, Foundation” layer.
- Footings under slab footings and Foundation Walls are placed on the “Footings” layer.
- Deck post footings are placed on the “Footings, Deck Post” layer.
- Slabs created using the **Slab Tools**  are placed on the “Slabs, Custom” layer.
- The “Foundations” layer controls the display of all objects on Floor 0 in 3D views but does not affect floor plan view.

In floor plan view, foundation walls are drawn with solid lines and footings, with dashed lines.

The appearance of foundation wall types, including line weights, colors and fill styles, is specified in the **Wall Type Definitions**

dialog. See “Wall Type Definitions Dialog” on page 144.

If a door on Floor 1 extends into a stem wall or curb defining a Garage room, its location will be indicated on Floor 0.

In 3D views, all objects on Floor 0 will only display when the “Foundation” layer is turned on.

While the display of foundation walls and their footings can be controlled independent of one another in floor plan view, in 3D views this is not the case. If a foundation wall is set to display, its footing will as well - even if the “Footings” layer is turned off. The reverse is also true - if a foundation wall’s display is turned off, so will its footing’s.

The display of monolithic slab foundations in 3D views is controlled by the “Foundation” layer. Slab footings are located on the “Walls, Foundation” layer; but if this layer is turned off, any slab footings that define a foundation room will continue to display as long as the “Foundation” layer is on.

---

## Editing Foundations

Stem wall with footings and monolithic slab foundations are both created using walls which enclose room areas.

- Foundation walls can be selected and edited much like other walls. See “Editing Walls” on page 135.

- Foundation rooms can also be selected and edited like other rooms. See Foundations and Rooms.

### Rebuilding Foundations

By default, foundations update automatically when changes are made to the structure on Floor 1. For example, if exterior walls are

moved or floor platforms are raised or lowered, the foundation will be rebuilt.

If you prefer that the foundation not rebuild automatically, you can uncheck **Auto Rebuild Foundation** in the **Foundation Defaults** dialog. See “Foundation Defaults” on page 228.

You can also rebuild an automatically generated foundation by selecting **Build>**

**Floor> Build Foundation**  from the menu.

When **Auto Rebuild Foundation** is enabled, walls cannot be edited, manually drawn or deleted on Floor 0. When the foundation is rebuilt, any manually drawn or edited walls are deleted. Similarly, rooms on Floor 0 cannot be edited while this option is enabled. If you try to draw a wall or edit a room or a wall while **Auto Rebuild Foundation** is turned on, a warning message will display.

## Changing Foundation Types

When a foundation is generated, the program creates **Floor Defaults** settings for Floor 0 based on the information in the **Build Foundation** dialog. If you specify a Monolithic Slab foundation, the default Floor Structure on Floor 1 will also be changed to a slab rather than a framed platform. See “Floor Defaults Dialog” on page 220.

If you rebuild the foundation using a different Foundation Type, it is advisable to check the floor heights of all rooms on Floor 1 - particularly Garage and Slab rooms, as well as any rooms that do not use the default floor height of 0”.



To avoid unexpected results, it is recommended that you not change the Foundation Type once the foundation is built.

## Stem Wall Height

When a foundation is created, all of Floor 0 uses the stem wall height specified in the **Foundation Defaults** dialog,

This height is measured from the bottom of floor platform of Floor 1 to top of the stem walls’ footings. If Floor 1 has multiple floor platform heights, the foundation stem walls will be stepped.

Once a foundation is created, stem wall heights can be adjusted either on a room-by-room basis or for individual walls.

### *To change a room’s stem wall height*

1. Select a room on Floor 0 and click the **Open Object**  edit button.
2. Specify the desired **Stem Wall Height** in the **Room Specification** dialog. See “General Panel” on page 172.
3. If you wish to reduce the **Stem Wall Height**, you will first need to reduce the **Ceiling Height** value by the same amount.



If adjacent rooms have stem wall heights that differ by at least 1/16 of an inch, the stem wall separating them uses the larger of these two values.

## Interior Footings

Slab foundations often have interior footings: to support posts, for example. Home Designer Architectural does not generate interior

footings automatically, but you can easily draw them using the **Slab**  tool. See “The Slab Tools” on page 235.

### *To create an interior footing*

1. Select **Build> Slab> Slab** , then click and drag to draw a slab on Floor 0. This slab will serve as a footing.
2. Select the slab and click the **Open Object**  edit button.
3. In the **Slab Specification** dialog, specify the desired **Height** and **Thickness**. See “General Panel” on page 236.
  - The **Height** should be set so that it meets the bottom surface of the monolithic slab above.
4. Use the edit handles, dimensions and/or the Reference Display to position the slab at the desired location.

---

## Aligning Foundation Walls

By default, foundation walls and slab footings will align with walls on the floor above along the outside surface of the Main Layer of both wall types. See “Wall Type Definitions” on page 142.

If there is only one layer for both the stem wall and the first floor wall above it, the exterior surfaces of the walls align. The footing is centered on the stem wall.

---

## Deleting Foundations



Select **Build> Floor> Delete Foundation** to delete the entire foundation floor.

You can also select and delete individual foundation walls and slabs by clicking the

**Delete**  edit button or pressing the Delete key. See “Deleting Objects” on page 116.

Deleting and rebuilding the foundation is often the quickest way to update the model when substantial changes are made to Floor 1 after the foundation is built.

---

## Foundations and Rooms

When a foundation plan is created, rooms included in the Living Area calculation generate a stem wall or slab foundation below them. Garage rooms generate slab foundations, but exterior rooms such as Decks, Courts and Balconies do not generate

any foundation. See “Room Types” on page 164.

Interior foundation walls are not generated unless:



- They separate the area under a Slab or Garage room from the rest of the plan;
- They define areas under rooms with different floor heights.

Note: To remove all or part of the concrete slab in the basement area, select a basement room and define it as Open Below in the Room Specification dialog.

## Garages

When a foundation is generated based on the floor plan of Floor 1, a room on the first floor specified as either a Garage or Slab type will receive a foundation with a slab floor and stem walls. If a monolithic slab foundation is generated, the room will receive a slab floor with curbs.

By default, a room on Floor 1 specified as a Garage or a Slab will be assigned a lower floor height when the foundation is built. The amount that it is lowered depends on the foundation type:

- The floor height will drop the default thickness of the floor platform for Floor 1 plus 12" (300 mm) - a total of 24 5/8" (618 mm) - in a Walls with Footings foundation.
- The floor height will drop 3 1/2" (88 mm) in a Monolithic Slab foundation.

### *To build a Garage slab with stem walls*

1. Before the foundation is generated, specify the room as a Garage or Slab.

2. Build a Wall with Footings foundation.

### *To build a Garage slab with curbs*

1. Before the foundation is generated, specify the room as a Garage or Slab.
2. Build a Monolithic Slab foundation, specifying the required Lower Garage Floor value.

## Basement Rooms

When a foundation's type is Walls with Footings and it is assigned a Minimum Wall Height of 76" (1900 mm) or greater, the resulting basement is automatically created with a 4" (100 mm) concrete slab floor, and a default Floor Finish like that on Floor 1.

Similarly, if a foundation is set up to have a Basement Ceiling Height of 72" (1800 mm) or greater when built, it is automatically given a painted drywall Ceiling Finish.

Regardless of its ceiling height, however, you can specify a ceiling finish for any room in the **Room Specification** dialog. See "Structure Panel" on page 173.

The resulting basement can be divided into separate rooms using **Interior Walls**  or any wall type you wish. If the rooms in a basement have different floor heights, it is best to separate them using walls specified as

**Foundation Walls** .

## Foundations and the Terrain

Home Designer Architectural automatically raises the structure in a plan a set distance above the terrain. See “Terrain Height vs Floor Height” on page 334.

In a plan with a foundation present, the terrain will be:

- 6” (187 mm) below the top of the stem walls in a Walls with Footings foundation.
- 8” (200 mm) below the top of the slab in a Monolithic Slab foundation.

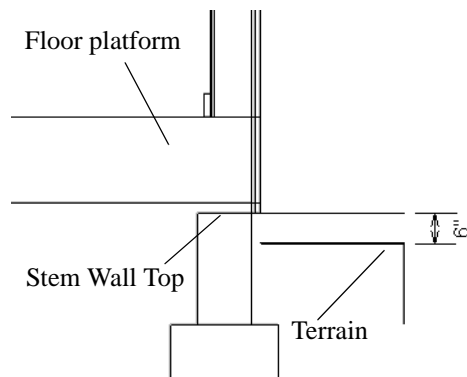

By default, the program will also create a flattened pad under the building footprint.

Not all foundations have these requirements, of course, so you can customize your foundation and terrain to suit your needs.

### Daylight Basements

Daylight basements, also referred to as look-out basements, have walls that are tall enough for basement windows to be positioned above the terrain. They are often found in split level or split entry structures.

To create a daylight basement condition, build a stem wall foundation and modify these settings in the **Terrain Specification** dialog:

- Uncheck **Auto Calculate Elevation**.
- Increase the **Building Pad Elevation**, which is the distance between the default floor height of Floor 1 and the terrain.

### Walkout Basements

Walkout basements are a type of daylight basement typically located on sloped terrain. They feature walls that are above ground at the lower end of the slope so that a door can be positioned above the terrain at that end.

To create a walkout basement, build a stem wall foundation and modify these settings in the **Terrain Specification** dialog:

- Uncheck **Flatten Pad**.
- Uncheck **Auto Calculate Elevation**.

You will also need to create sloped terrain and adjust the **Building Pad Elevation** and/or terrain data so that the terrain is at the appropriate height relative to the structure at both the high and low ends of the slope.

### Stepped Foundations

Stepped foundations are usually built on sloping terrain. A stepped foundation will be produced automatically if more than one floor height is present on Floor 1 when the foundation is built.

As with a walkout basement, you will need to build a stem wall foundation and modify

these settings in the **Terrain Specification** dialog:

- Uncheck **Flatten Pad**.
- Uncheck **Auto Calculate Elevation**.

You will also need to create sloped terrain and adjust the **Building Pad Elevation** and/

or terrain data so that the terrain is at the appropriate height relative to the structure at both the high and low ends of the slope.

You can also create a stepped foundation by editing foundation rooms. See “Stem Wall Height” on page 231.

## The Slab Tools



Select **Build> Slab** to access the Slab Tools. The Slab Tools are designed for more generic purposes than foundations and should not be substituted for a foundation plan. The settings in the **Foundation Defaults** dialog do not affect slabs created with the Slab Tools.

### Slabs



Select **Build> Slab> Slab** or **Slab With Footing**, then either click or click and drag a rectangle to draw a slab. See “Draw Polyline” on page 512.

Once created, slabs can be edited like other closed polylines. See “Editing Closed-Polyline Based Objects” on page 98.

## Editing Slabs

Slabs can be selected in 2D and 3D views and can be edited using the edit handles, the edit toolbar and the **Slab Specification** dialog. See “Slab Specification Dialog” on page 235.

“Editing Closed-Polyline Based Objects” on page 98.

### Using the Mouse

Slabs can be edited like other closed-polyline base objects in both 2D and 3D views. See

### Using the Edit Tools

One or more selected Slabs can be edited in a variety of ways using the buttons on the edit toolbar. As with most objects, Slabs can be copied, replicated, moved, deleted, etc. See “The Edit Toolbar” on page 28.

## Slab Specification Dialog



Select a Slab and click the **Open Object** edit button to open the **Slab Specification** dialog.

## General Panel

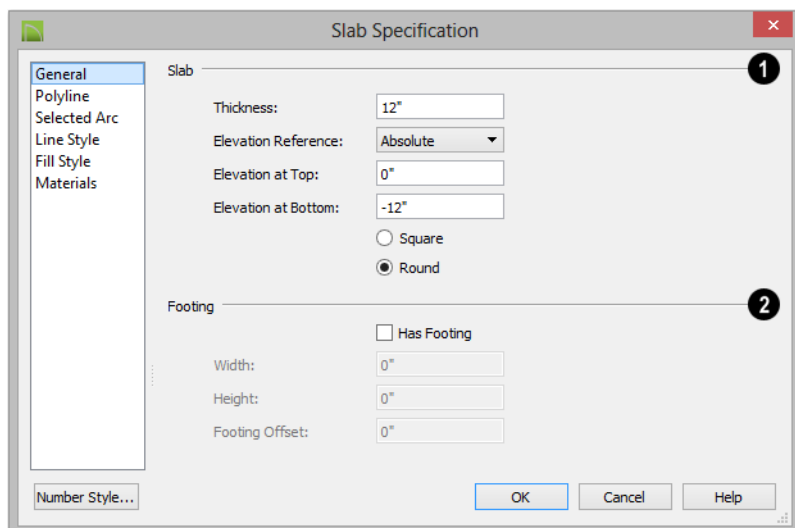

- 1 Specify the characteristics of the selected **Slab**.
  - Specify the **Thickness**, which is the measurement from the slab's top to bottom surfaces.
  - Select the **Elevation Reference**, from the drop-down list. This determines where the next two settings are measured from and also affects their setting labels.
  - Specify the slab's height **to Top**, which is of its top surface measured from the selected Elevation Reference.
  - Specify the slab's height **to Bottom**, which is the height of its bottom surface, measured from the Elevation Reference.
- 2 Specify the characteristics of the selected slab's **Footing**.
  - Check **Has Footing** if you would like the slab to have a footing around the inside of its perimeter.
  - Specify the **Height** and **Width** for the footing.
  - Specify the **Footing Offset**, which is the distance that the footing extends out past the edges of the slab. A value of 0 aligns the outside of the footing with the outside of the slab.

## Polyline Panel

The POLYLINE panel states the length of the selected slab's **Perimeter**, its enclosed **Area**, and its **Volume**. See "Polyline Panel" on page 518.

## Selected Line Panel

The SELECTED LINE panel is available when the selected edge is a line as opposed to an arc. For information about the settings on this panel, see "Polyline Specification Dialog" on page 518.

## Selected Arc Panel

The SELECTED LINE panel is available when the selected edge is an arc as opposed to a line. See “Change Line/Arc” on page 114.

## Line Style Panel

For information about the settings on this panel, see “Line Specification Dialog” on page 513.

## Fill Style Panel

The settings on the FILL STYLE panel affect the selected slab’s appearance in floor plan view. For information about these settings, see “Fill Style Panel” on page 519.

## Materials Panel

For information about the settings on this panel, see “Materials Panel” on page 420.

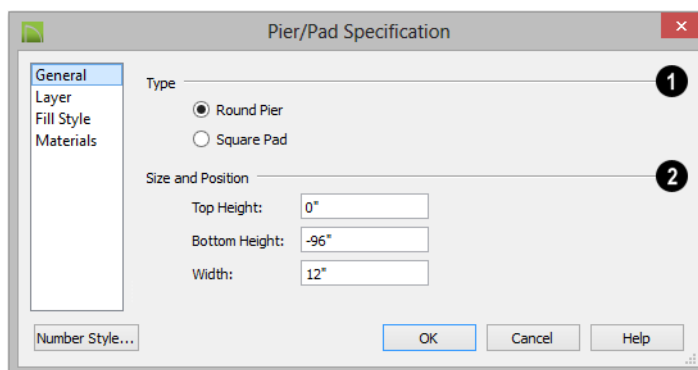

## Fireplaces



A masonry fireplace can be placed in or away from a wall by selecting **Build> Fireplace** and then clicking in the drawing area.

- If created in a wall, it is considered a wall opening and can be moved or resized like a window or door.
- If created away from a wall, it moves and resizes similar to a cabinet.

A selection of prefabricated metal fireplaces is also available from the Architectural Core Catalog. These can be framed in with standard walls. See “The Library” on page 393.

The display of fireplaces is controlled in the **Display Options** dialog. See “Display Options Dialog” on page 77.

Fireplaces are edited, moved, resized, and deleted similar other objects. See “Editing Objects” on page 87.

### Built into a Wall

To place a masonry fireplace in a wall, select **Build> Fireplace**  and click on a wall. A fireplace is created with the outside of the fireplace flush with the outside of the wall.

Fireplaces cannot be placed in a wall specified as Invisible. See “Room Dividers and Invisible Walls” on page 127.

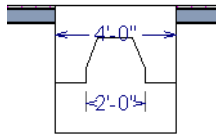

Select the fireplace to display four edit handles located along the wall.

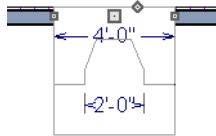

Click the diamond-shaped Depth handle and drag toward the outside of the wall. The fireplace will stop when the firebox front is flush with the inside edge of the wall.

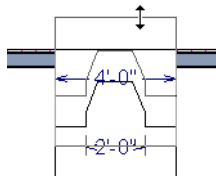

In 3D views, fireplaces placed in walls display five edit handles: a Resize handle along each edge and a Move handle at the center.

Fireplaces always face the interior when placed on an exterior wall. When placing a fireplace in an interior wall, click on the edge of the wall that you want the fireplace to face. The fireplace is created with the firebox on the same side as the wall edge you clicked on to create it.

## Freestanding

To place a free-standing masonry fireplace, select **Build > Fireplace**  and click in an open area away from a wall.

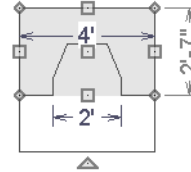

Unlike fireplaces placed in walls, free-standing fireplaces have ten edit handles when selected and may be rotated, resized, or moved in any direction, similar to the way CAD boxes can. See “Editing Box-Based Objects” on page 101.

Free-standing fireplaces can be selected and replaced with a symbol from the library by clicking the **Replace From Library**  edit button. See “Replace From Library” on page 408.

## Fireplace Foundations

When a Walls with Footings foundation is built, a fireplace foundation will be generated under any **Fireplaces**  present on Floor 1. See “Building a Foundation” on page 229.

Fireplace foundations are the same material type as the original fireplace, but do not have a firebox or a hearth. Fireplace foundations can be edited or deleted as needed. A firebox and hearth can be added in the **Fireplace Specification** dialog.

## Fireplace Specification Dialog

 Select a masonry fireplace and click the **Open Object** edit button to display the **Fireplace Specification** dialog.

Dimensions in this dialog here must be entered in whole inches. Fractions and decimals are not accepted.

### General Panel

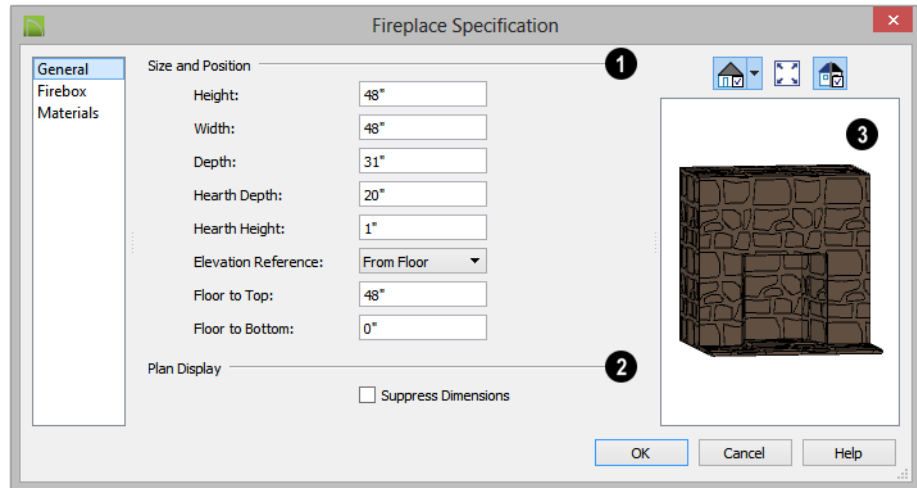

- 1 Specify the **Size and Position** of the selected fireplace and its hearth.
- Specify the **Height, Width, and Depth** of the fireplace.
- Specify the **Hearth Depth**. This is measured from the front of the fireplace out into the room. To eliminate the hearth altogether, enter a zero for this value.
- Specify the **Hearth Height**, relative to the floor in the room that the fireplace faces.
- Select the **Elevation Reference** from the drop-down list. This determines where

the next two settings are measured from and also affects their setting labels.

- Specify the height **to Top**, measured from the selected Elevation Reference.
- Specify the height **to Bottom**, measured from the selected Elevation Reference.

2 **Plan Display** - Check **Suppress Dimensions** to turn off the display of the selected fireplace's width and firebox width dimensions in floor plan view.

3 The preview of the fireplace updates as changes are made. See "Dialog Preview Panes" on page 32.

## Firebox Panel

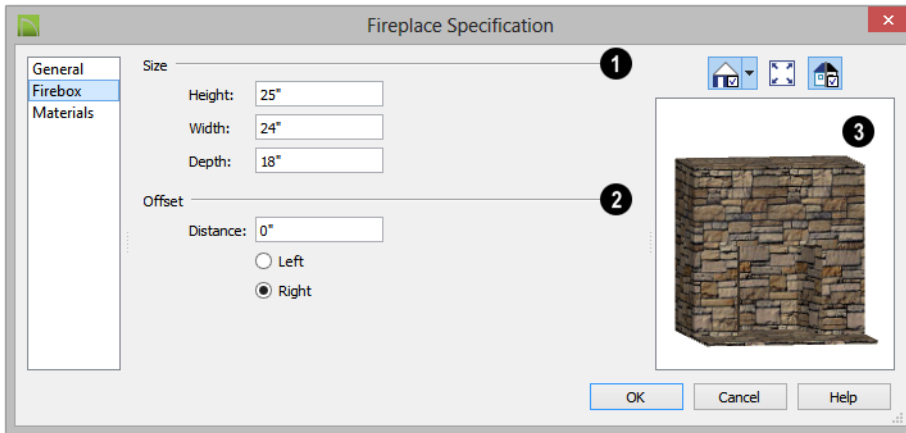

- 1 Define the **Size** of the selected fireplace's firebox.
  - Specify the firebox's **Height** and **Width**.
  - Specify the **Depth** of the firebox.
- 2 Define the firebox **Offset**, measured from the center of the fireplace.
  - Enter the offset **Distance**, which is how far the firebox is offset from the fireplace center. A value of 0 centers the firebox in the fireplace.

- **Offset to Left/Right** - Choose to offset the firebox to the left or to the right.
- 3 The preview of the fireplace updates as changes are made. See "Dialog Preview Panes" on page 32.

## Materials Panel

For information about the settings on this panel, see "Materials Panel" on page 420.

---

## Library Fireplaces

A variety of different fireplace symbols are available in library. The fireplace symbols in the Library behave just like other Library objects. See "The Library" on page 393.

### Placing a Library Fireplace

A variety of fireplace symbols are available in the library. See "Placing Library Objects" on page 406.

Flush fireplaces are designed to snap to wall surfaces.

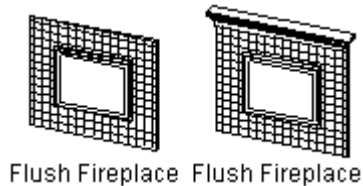



Some fireplace symbols can be enclosed by walls or positioned to project through a wall.

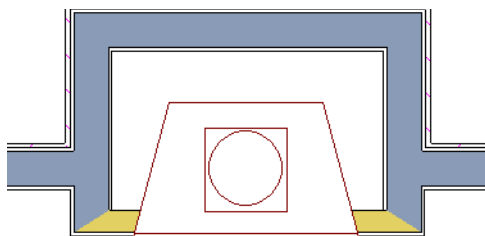

*Open Front fireplace projecting through a wall*

 Always check the manufacturer's product information for the framing and clearance requirements of the fireplace unit you plan to use, and design your plan accordingly

## Chimneys

Chimneys can be created using a variety of methods.

### Masonry Fireplace Chimneys

*To create a chimney on a masonry fireplace*

1. Select the fireplace in a 3D view.
2. Ctrl + drag the top edge of the chimney upward through all the floors and the roof until it is to the desired height. See "Unrestricted Movement" on page 109.
3. When the chimney is approximately the correct height, select the fireplace, click the **Open Object**  edit button, and type in the exact height.

### Chimney Chases and Caps

There are two ways to draw a chimney chase:

- Place a closed box Geometric Shape or Soffit over the chimney chase, resize it to match, then increase its height either in its specification dialog or in a 3D view using the same method as extending a masonry fireplace.
- Use walls to define the chimney chase as a room area, making sure these walls are aligned between floors. The chimney chase "room" on the uppermost floor should have a much higher ceiling than the other rooms on that floor and should also have no ceiling or roof. See "Room Specification Dialog" on page 172.

A selection of chimney tops is available in the library. In addition, custom chimney caps can be made using Geometric Shapes and/or Soffits. See "Other Objects" on page 379.



# Roofs

Home Designer Architectural's automatic Roof Tools allow you to draw almost any roof style.

Proficiency with the Roof Tools can only be attained through practice, but mastering these tools saves you time and effort in plan development. For information about creating specific roof styles, see "Roof Tutorial" on page 55 of the User's Guide.

## Chapter Contents

- Roof Defaults
- The Roof Tools
- Automatic Roofs
- Build Roof Dialog
- Displaying Roofs
- Editing Roofs
- Gable/Roof Lines
- Skylights
- Skylight Specification Dialog
- Dormers
- Editing Auto Dormers
- Dormer Specification Dialog
- Roof Returns and Other Details
- Roof Pitches in Degrees

## Roof Defaults



Select **Edit> Default Settings**, to open the **Default Settings** dialog for a variety of drawing tools, several of which directly affect roof generation.

### Roof Defaults Dialog

The **Build Roof** and **Roof Defaults** dialogs are nearly identical in appearance and function. The only difference is that the **Build Roof** dialog has a checkbox that allows you to automatically generate roof planes. See “Build Roof Dialog” on page 245.

### Floor and Ceiling Heights

The initial heights of floors and ceilings, which influence roof heights, are specified in the **Floor Defaults** dialog for each floor. See “Floor Defaults Dialog” on page 220.

The floor and ceiling heights in individual rooms also influence roof heights and are specified in the **Room Specification** dialog. See “Structure Panel” on page 173.



If Auto Rebuild Roofs is checked in the Build Roof dialog and you change floor or ceiling heights, wall positions or roof directives in walls, the roof rebuilds to reflect your changes. See “Rebuilding Roofs” on page 245.

### Wall Specification Dialog

By default, when a roof is built, a roof plane is generated over each exterior wall, creating a hip roof.

Any deviations from this default hip roof, such as a gable or a different pitch, can be specified in the **Wall Specification** dialog for any exterior wall. See “Roof Panel” on page 148.

### Dormer Defaults

The settings in the **Dormer Defaults** dialog determine the initial settings for automatic dormers and are much like those in the **Dormer Specification** dialog. See “Dormer Specification Dialog” on page 256.

## The Roof Tools



Select **Build> Roof** to access the Roof Tools.

### Build Roof



Select **Build> Roof> Build Roof** to open the **Build Roof** dialog, specify the settings for automatically generated roof planes, and build or rebuild a roof. See “Build Roof Dialog” on page 245.

When roofs are automatically generated, a roof plane is created over each exterior wall by default, resulting in a hip roof.

To automatically generate a roof plane using values other than the defaults or to not generate a roof plane bearing on a particular wall (as with a gable or the sides of a shed roof), you can change the settings in the **Wall Specification** dialog. See “Roof Panel” on page 148.

For more information about creating different roof styles, see “Roof Tutorial” on page 55 of the User’s Guide.

### Gable/Roof Line



Select **Build> Roof> Gable/Roof Line** to draw a gable line that generates a gable along a baseline edge when roofs are automatically generated. See “Gable/Roof Lines” on page 248.

### Skylight



Select **Build> Roof> Skylight**, then draw a rectangle over an existing roof plane to create a skylight. The skylight, sky-

light shaft, and ceiling hole (if a ceiling exists) are drawn at the same time. See “Skylights” on page 251.

### Dormer



Select **Build> Roof> Dormer** and click within an existing roof plane to place an auto floating dormer. See “Dormers” on page 254.

### Delete Roof



Select **Build> Roof> Delete Roof** to delete all roof planes in the plan. See “Deleting Roof Planes” on page 248.

## Automatic Roofs

When roofs are automatically generated, a roof plane is created over each exterior wall by default, resulting in a hip roof.

### Roof Directives in Walls

To automatically generate a roof plane using values other than the defaults or to not generate a roof plane bearing on a particular wall (as with a gable or the sides of a shed roof), you can change the settings in the **Wall Specification** dialog for that wall. See “Roof Panel” on page 148.

For more information about creating different roof styles, see “Roof Tutorial” on page 55 of the User’s Guide.

## Rebuilding Roofs

By default, whenever changes are made to wall placement, floor/ceiling heights, or roof directives in walls, the roof will update in response. If you do not want the roof to rebuild automatically, uncheck **Auto Rebuild Roofs** in the **Build Roof** dialog. See “Roof Panel” on page 246.

You can also rebuild the roof at any time to reflect the current state of the model by opening the **Build Roof** dialog and clicking **OK**.

## Build Roof Dialog



The **Build Roof** dialog is used to automatically build or rebuild roof

planes. To open the **Build Roof** dialog, select **Build > Roof > Build Roof** .

Roof planes are generated based on the positions and roof directive settings for each exterior wall in the plan. If you make changes to any of these walls, you will need to build the roof again for them to take effect. See “Roof Panel” on page 148.

Aside from a checkbox on the ROOF panel that allows you to automatically generate

roof planes, the settings in this dialog are also found in the **Roof Defaults** dialog. See “Roof Defaults” on page 244.

There are three panels in the **Build Roof** dialog:

- Roof Panel
- Materials Panel
- Roof Styles Panel

## Roof Panel

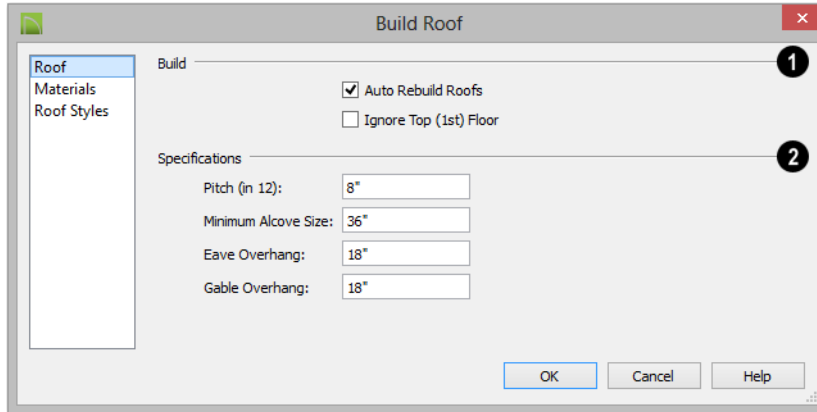

**1** The **Build** options are commands related to building and rebuilding roofs.

- If you check **Auto Rebuild Roofs**, the program automatically rebuilds the roof if you make a change that affects the roof, such as to exterior wall positions or ceiling heights.
- Check **Ignore Top Floor** to build the roof so that it bears on the walls of the floor below the top living floor in the plan. When unchecked, the roof builds so that it bears on the walls on the top floor of the plan.

**2** The **Specifications** settings affect basic roof structure.

- Enter a value to describe the **Pitch**. In plans using U.S. units of measurement, pitch is described as a ratio over 12; in metric plans, it is measured in degrees. For a conversion to degrees, see “Roof Pitches in Degrees” on page 258.
- **Minimum Alcove Size** - Specify the minimum width of an alcove (depression into an otherwise straight exterior wall). Any alcove less than the specified width is treated as though the exterior wall contin-

ues straight across. Alcoves that measure wider than this value are not roofed over; they cause a change in roof planes.

Following is an example showing this difference. If **Min Alcove** is 36", a 36" wide alcove requires a change in the roof line. Each wall of the alcove has an eave. On the right, the alcove is less than the 36" minimum, so the roof passes right over it.

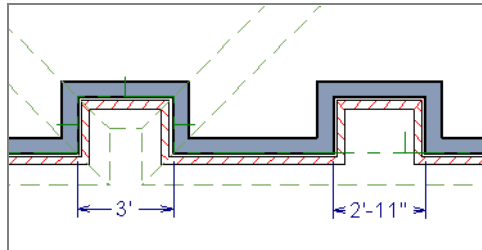

The **Roof Overhang** is measured horizontally from the exterior surface of the wall's Main Layer to the end of the top of the rafter. It does not include gutters, sheathing or siding. See "The Main Layer" on page 142.

- **Normal** is the overhang at the eaves and is always the overhang for a roof plane having the default Pitch specified above. If the pitch for a particular roof plane is

set differently, its overhang may try to maintain its fascia at the same height. Overhang can be greater for a shallower pitch, lesser for a greater pitch.

- **Gable** is the overhang dimension at gable ends or rake walls.



If the roof overhang values are not sufficient to extend past the outer layer of exterior walls, the walls may not generate correctly in 3D views..

## Materials Panel

The settings on this panel allow you to specify materials for the roof's various components. See "Materials Panel" on page 420.

## Roof Styles Panel

The ROOF STYLES panel provides links to tutorial information about creating different roof styles automatically. Click on a roof style to launch the online Help to a page with information about the roof style you selected. See "Roof Tutorial" on page 55 of the User's Guide.

## Displaying Roofs



Roof planes are drawn on the "Roof Planes" layer

You can also choose to display gutters, gable lines, and roof openings. See "Display Options Dialog" on page 77.

If the "Roof Planes" layer is turned off and **Auto Rebuild Roofs** feature is turned on, changes made to the plan that cause the roof

to rebuild will not automatically turn on the display of the roof planes. See "Rebuilding Roofs" on page 245.

## Roof Plane Labels

Roof plane labels indicating the pitch and slope direction are located on the "Roofs,

Labels” layer and can be set to display in floor plan view.

---

## Editing Roofs

Unlike most other objects in Home Designer Architectural, roof planes cannot be selected and edited. To make changes to the roof, you must edit the edit roof directives in walls and/or settings in the **Build Roof** dialog, and then rebuild. See “Rebuilding Roofs” on page 245.

An exception to this rule is the **Material Painter**  tool, which you can use to change the materials used by individual roof planes without rebuilding the roof. Bear in mind, though, that any changes made using

the **Material Painter**  will not be retained if the roof is later rebuilt. See “The Material Painter” on page 417.

### Deleting Roof Planes

There are several ways to delete roof planes.



Delete the entire roof quickly by selecting **Build> Roof> Delete Roof**.



You can also delete all roof planes at once in the **Delete Objects** dialog. See “Delete Objects Dialog” on page 116.

---

## Gable/Roof Lines



The **Gable/Roof Line** tool can be used to automatically generate a gable above the bearing wall of a hip roof plane. It is best used in situations where roof directives in walls are not possible. For example:

- If a Wall Break would be required in the same location as a door or window;
- Where a wall is not present, such as across the front of an alcove;
- Over a Bay, Box, or Bow Window.

See “Roof Directives in Walls” on page 140.



In addition, the **Gable Over Door/Window** edit button allows you to add a small Gable/Roof Line over one or more selected doors or windows the next time automatic roof planes are built.

Gable/Roof Lines display in floor plan view when the “Roofs, Gable Lines” layer is set to display and can be selected and edited much like regular CAD lines. See “Editing Line Based Objects” on page 90.

### Creating a Gable

*To create a gable using a Gable/Roof Line*

1. Select **Build> Roof> Gable/Roof Line** , then click and drag to draw a

line outside of the exterior wall that you want to create a gable over.



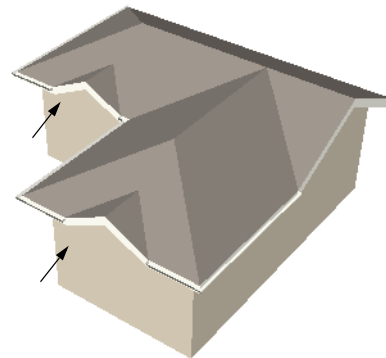
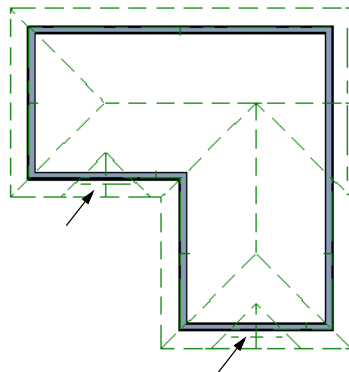

2. Position the Gable/Roof Line within 10 feet (2260 mm) of the wall's Main Layer but not touching it. See "The Main Layer" on page 142.
  - Make sure that the Gable/Roof Line is exactly parallel to the exterior wall.
3. Resize the Gable/Roof Line so that it is the length of the desired gable.

- The length of the Gable/Roof Line determines the gable width at the wall Main Layer, not at the overhang.
  - At the larger roof eave, a gable roof is wider than the gable line by twice the overhang distance.
4. Select **Build> Roof> Build Roof**  and regenerate the roof. See "Build Roof Dialog" on page 245.



*Gables produced using Gable Roof Lines*

**To use the Gable Over Door/Window tool**

1. Select one or more doors or windows.
2. Click the **Gable Over Door/Window**  edit button.
  - **Gable Over Door/Window**  is not available for openings placed in Full Gable Walls or for Bay, Box or Bow Windows. See "Bay, Box, Bow Windows and Roofs" on page 215.
3. The next time automatic roof planes are built, gables will be created over each of these doors and windows.

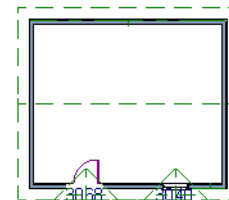



- Each gable will extend 12" (300 mm) on either side of its door or window.

- If two of these openings are within 30” (750 mm) of each other on the same wall, a single gable will be created.
  - If you move or resize the door or window(s), the associated Gable/Roof Line will not update until the roof is built again.
4. To remove a Gable Over Door/Window, select the door(s) or window(s) and click

the **Delete Gable Over Opening**  edit button. The next time the roof is built, the gable will be removed.

### Covering an Alcove

A **Gable/Roof Line**  can also be used to maintain a roof plane baseline where there is no wall below. For example, you can use it to extend a roof plane across an alcove, rather than wrap into it.

In order for a **Gable/Roof Line**  to direct the roof to extend over an alcove or other area where no wall is present, it must be aligned with the exterior walls' Main Layer.

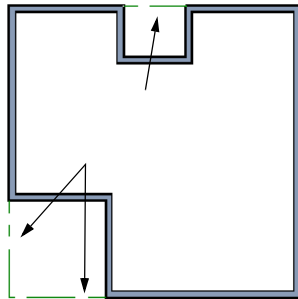

*Gable/Roof Lines drawn to extend roof planes*

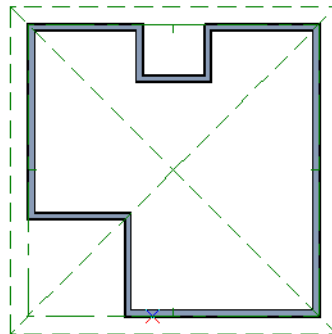

*Result, after automatic roof generation*

### Covering a Bay

A **Gable/Roof Line**  drawn across a bay causes a gable to be built above the bay when roofs are automatically generated.

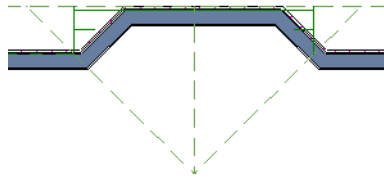

*Gable/roof line used to create a gable over a bay*

In order for the gable to be built, at least one end of the Gable/Roof Line must extend past the side walls of the bay.

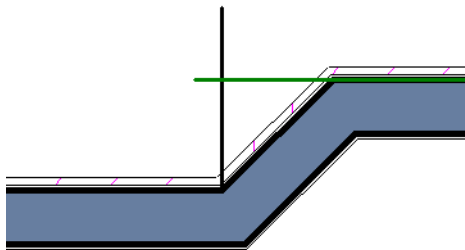

*Gable/roof line extends past end of side wall*

If the Gable/Roof Line is drawn along the outer edge of the bay's outer wall's Main Layer, the resulting gable will extend only to the eave of the larger roof. Draw the Gable/Roof Line beyond the bay's outer wall to extend out past the larger roof's eave.

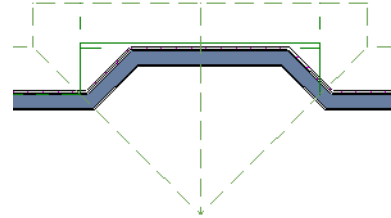

*Gable/roof line drawn beyond outer wall of bay results in gable extending to cover bay*

## Skylights



A skylight can be created by selecting **Build> Roof> Skylight** and drawing a rectangular polyline within a single roof plane. You can also simply click once within a roof plane to place a 2' x 2' skylight.

The **Skylight**  tool places a flat panel skylight into a roof hole, produces a hole in the ceiling platform below, and automatically generates the skylight shaft between these two holes.

To place a skylight in a vaulted ceiling, uncheck **Ceiling Over This Room** in the **Room Specification** dialog, draw the ceiling

planes to produce the vault and edit them as needed, and then draw the skylight. See "Structure Panel" on page 173.

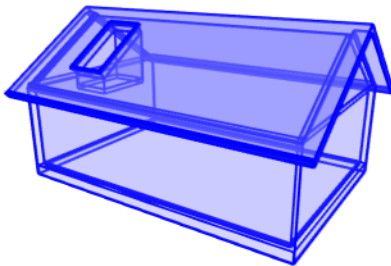
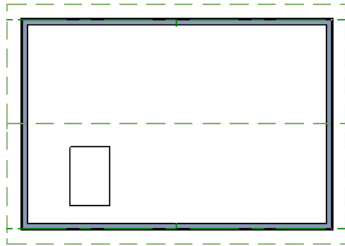

## Editing Skylights

Skylights can be edited using the edit handles, edit toolbar buttons, or the **Skylight Specification** dialog. See “Skylight Specification Dialog” on page 252.

Skylights must always be contained by a single roof plane. If the roof plane is deleted, any skylights it contains are also deleted. Aside from this restriction, skylights can be edited much like standard closed polylines. See “Editing Closed-Polyline Based Objects” on page 98.

---

## Skylight Specification Dialog



Select a skylight and click the **Open Object** edit button to open the

**Skylight Specification** dialog. See “Skylights” on page 251.

## General Panel

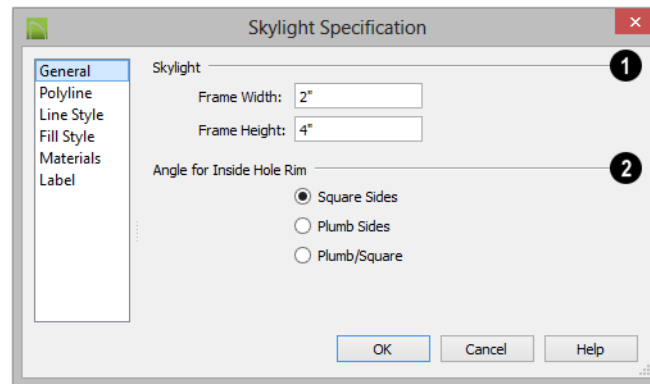

**1** Specify the **Frame Width** and **Height** of the selected skylight.

**2** **Angle for Inside Hole Rim** - Defines the shape of the skylight well where it passes through the roof plane.

- **Square Sides** - The framing for the skylight is cut square to the pitch of the roof.
- **Plumb Sides** - The framing for the skylight is plumb-cut.
- **Plumb/Square** - The bottom edge is plumb-cut, the top edge square-cut.

### Polyline Panel

The POLYLINE panel states the skylight's **Perimeter**, its **Framing Area**, and its **Projected Area**.

- The **Perimeter** is the length of the skylight's perimeter with the pitch taken into account. It does not equal the perimeter as measured in floor plan view.
- The **Framing Area** is the area of the skylight with the pitch taken into account.
- The **Projected Area** is the area of the skylight as seen in floor plan view.

### Line Style Panel

For information about the settings on this panel, see “Line Style Panel” on page 514.

### Fill Style Panel

The settings on the FILL STYLE panel control the appearance of the selected skylight in floor plan view. For information about these settings, see “Fill Style Panel” on page 519.

### Materials Panel

For information about the MATERIALS panel, see “Materials Panel” on page 420.

### Label Panel

Skylight labels display when the “Roofs, Labels” layer is turned on and use the “Default Label Style” Text Style. The Automatic Label for these objects is blank, but you can specify a custom label.

For information about the settings on this panel, see “Label Panel” on page 576.

## Dormers



Dormers can be drawn manually or placed automatically using the

**Dormer** tool.

Automatic Dormers can be placed only under certain conditions:

- Automatic Dormers can only be placed entirely within a single roof plane. They cannot extend past the eaves or ridge of this roof plane.
- Automatic Dormer side walls cannot be positioned above other walls in the plan.

If you click within a roof plane to place an automatic dormer, but click too close to an eave or the ridge, a dormer will not be created; however, its outline will. Move this outline box to a location that meets the dormer's requirements and it will be created.

### Dormer



Select **Build > Roof > Dormer** and click the roof plane where you would like to place the center of the dormer's front wall.

The bottom edges of all dormer walls are cut off by the underlying roof plane.

The images below show both the outside and inside of a typical dormer.

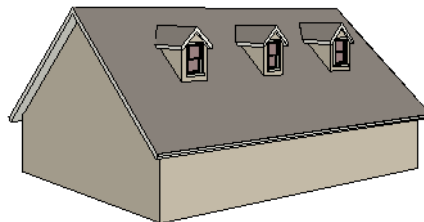

A dormer can be placed in floor plan view on the same floor that its underlying roof plane displays on, or it can be placed on the floor above. Normally, it does not matter what floor the dormer is on; but in some cases, it may need to be on the floor above so that the dormer walls do not interfere with walls or railings in the room below.

Regardless of which floor it is placed on, a dormer must always fit within a single roof plane. When placing a dormer on the floor above, you may find it helpful to turn on the

**Reference Display** . See "Reference Floor Display" on page 225.

The initial width, height, roof style and other settings of Auto Dormers are set in the **Dormer Defaults** dialog. See "Dormer Defaults" on page 244.

## Manually Drawn Dormers

Once you are familiar with Home Designer Architectural's roof tools, drawing dormers manually can be quite simple. There are several different ways to draw dormers; some methods work better in certain applications.

A variety of resources with information about drawing dormers manually is available at [www.HomeDesignerSoftware.com](http://www.HomeDesignerSoftware.com).

See, too, "Manually Drawn Dormers" on page 70 of the User's Guide.

---

## Editing Auto Dormers

Auto Dormers are a collection of objects that behave as one. When a dormer is selected, it can be edited using its edit handles, edit tools, and specification dialog. See "Dormer Specification Dialog" on page 256.

### Using the Mouse

When selected, an auto dormer displays three edit handles. The Move handle displays over the front wall and allows you to relocate the dormer. Two resize handles display on the side walls and allow you to change the width of the dormer.

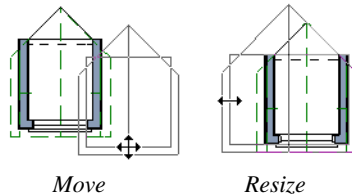

There are some things to keep in mind when editing auto dormers and auto floating dormers using the mouse.

- Dormers move at 90° angles unless the Ctrl key is pressed before moving them.
- The dormer must be contained within one underlying roof plane.

- Auto dormers cannot be moved beyond the required knee wall.

### Editing the Window

Dormer windows can be selected, edited, deleted and replaced just like other windows. See "Editing Windows" on page 203. You can place several windows in the front wall.

Unless the dormer's window has been edited or changed in the **Window Specification** dialog, when the dormer width is changed, its width changes automatically to fill the front dormer wall. If the window has been edited, its width stays fixed. If a change to the dormer makes its front wall too short to hold the window, the window reverts to auto width.

## Dormer Specification Dialog

 Select a dormer and click the **Open Object** edit button to open the **Dormer Specification** dialog.

The settings in this dialog are also found in the **Dormer Defaults** dialog, where they apply to all dormers as they are created rather than to a selected dormer.

### Roof Panel

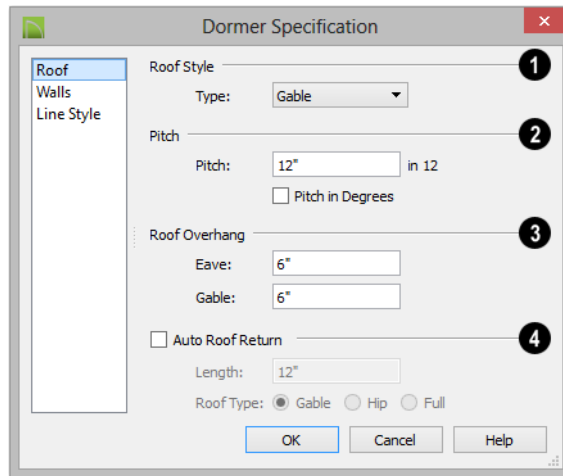

**1** Specify the selected dormer's **Roof Style**.

- Choose a roof **Type** from the drop-down list. You can choose from Hip, Gable, Shed, Gambrel, Mansard, Barrel, Curved Eave, Hip Curved Eave or Eyebrow.



*Dormer Roof Types*

**2** Describe the **Pitch** of the dormer's roof planes.

- Specify the **Pitch** of the dormer roof planes. The default dormer pitch applies to all dormer roof types except Shed, which has a default 3 in 12 pitch. For Gambrel and Mansard types, this applies to the lowest, or eave, roof planes.
- Check **Pitch in Degrees** to display the pitch in degrees; uncheck it to display the pitch in terms of rise and run. See "Roof Pitches in Degrees" on page 258.

**3** **Roof Overhang** - Specify the depth of the selected dormer's **Eave** and **Gable Overhangs**.



- 4** Check **Auto Roof Returns** to generate roof returns on the selected dormer. Roof Returns can be only specified for Gable dormers. See “Roof Returns” on page 257.

- Specify the horizontal **Length** of the roof return in inches (mm).
- Specify a **Gable, Hip, or Full** roof return.
- Specify a **Sloping** or **Flat** roof return.

## Walls Panel

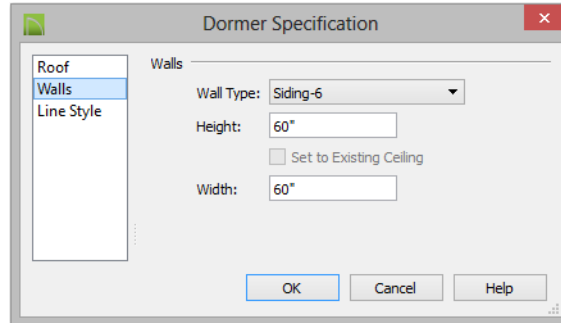

- Select a **Wall Type** for the dormer walls from the drop-down list.
- Specify the **Height** of the dormer, as measured from where the top of the underlying roof plane meets the dormer front wall exterior to the top plate of the dormer roof’s bearing walls.
- Check **Set to Existing Ceiling** to assign the ceiling height of the room behind the dormer to the dormer. Not available in the **Dormer Defaults** dialog.
- Specify the dormer’s **Width**, measured from the outside surfaces of the dormer side walls.

## Line Style Panel

For information about the settings on this panel, see “Line Style Panel” on page 514.

---

## Roof Returns and Other Details

Home Designer Architectural offers a selection of tools to add architectural details to your roof design.

### Roof Returns

A roof return is a small decorative roof plane that connects to the low side of a gable roof

overhang and extends below the upper triangular portion of the gable wall. Three styles of roof returns that can be produced.

The first two styles are called **Gable** and **Hip** returns since the return ends in a gable or hip.

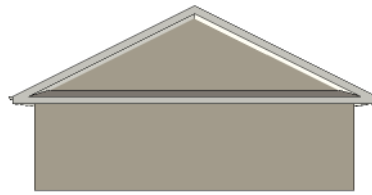
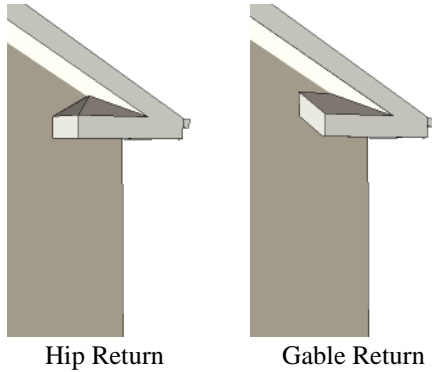

Full Return

The third is called a **Full** return because it extends under the entire gable to connect both sides and is sometimes referred to as a water table. In order for a Full return to be created, the roof planes on each side must have the same height.

Roof returns are generated automatically on a wall by wall basis using settings found in the **Wall Specification** dialog. See “Roof Panel” on page 148.

These roof return settings are also found in the **Dormer Specification** dialog for gable roof dormers and function similarly. See “Roof Panel” on page 256.

## Roof Pitches in Degrees

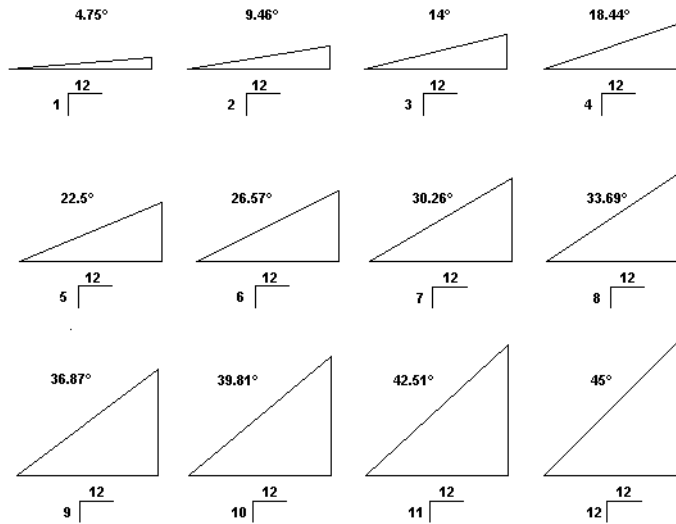

# Stairs, Ramps, and Landings

Staircases can be composed of one or more straight or curved stair sections, ramps, and landings. Stairs and ramps can be drawn, selected and edited in 2D and 3D views.

Stairwells can be created automatically or manually and can be seen in 3D views.



Local building and fire authorities must be consulted for specific stair construction codes and access requirements.

## Chapter Contents

- Stair Defaults
- The Stair Tools
- Anatomy of a Staircase
- Drawing Stairs and Ramps
- Displaying Stairs, Ramps, and Landings
- Editing Stairs and Ramps
- Merging Stair and Ramp Sections
- Landings
- Maintaining Tread Depth
- Starter Treads
- Wrapped Stairs
- Other Special Railings and Stairs
- Creating a Stairwell
- Rooms Below Staircases
- Staircase Specification Dialog
- Ramp Specification Dialog
- Stair Landing Specification Dialog

---

## Stair Defaults

The purpose of interior stairs is to provide passage from one floor platform to another, so the attributes that influence floor heights -

including ceiling heights - also influence the structure of stairs. When considering a staircase's structure, bear in mind that riser

height is directly dependent on the distance from one floor platform to another.

---

## The Stair Tools



Select **Build> Stairs** to access the Stair Tools.

### Straight Stairs



To draw a straight staircase select **Build> Stairs> Straight Stairs**, then click and drag in floor plan or a 3D view. You can also click once to place a staircase that extends from the current floor up to the next floor. See “Drawing Stairs and Ramps” on page 262.

### Click Stairs



Select **Build> Stairs> Click Stairs** to create stairs between levels on the same floor with a single click of the mouse. Click the low side, within a few feet of where the floor changes height.

- If you click on the low side of a floor platform defined by a railing, a doorway will be created in the railing, adjacent to the stairs.
- If you click on the low side of a floor platform defined by a wall, stairs will be created but a doorway will not.
- If you click at a location that is not near the edge of a floor platform, a full height staircase will be created.

### Curved Stairs



Select **Build> Stairs> Curve to Left** or **Curve to Right** and click once in floor plan view to place a curved staircase. See “Curved Stairs and Ramps” on page 262.

### Landing



Select **Build> Stairs> Landing** to draw a landing, which is a platform connecting two or more stair sections. See “Landings” on page 266.

There are two ways to create a landing using this tool:

- Click once to place a landing measuring 39” (975 mm) on each side.
- Click and drag to draw a rectangular landing sized as needed. See “Polylines” on page 518.

### Ramp



Select **Build> Stairs> Ramp** to draw a sloped ramp. By default, ramps are drawn at a 1:12 slope to a maximum height of 30” (760 mm). See “Drawing Stairs and Ramps” on page 262.

---

## Anatomy of a Staircase

Stairs, as well as ramps, are often described in terms of **rise** and **run**. Rise is typically

between 6" and 8", and the run between 10" and 12". In metric plans, rise is 177 to 190 mm, and the run is about 250 mm.

## Staircase Terminology

**Balusters** - The vertical members that run between the handrail and the treads or bottom rail.

**Bracket** - Decorative L-shaped supports on the exposed side of stairs below each tread.

**Landing** - A platform connecting two or more stair sections.

**Newels** - The end post of a stair railing located at landings and the beginnings and endings of new stair sections.

**Rise** - The height of a riser, measured from tread surface to tread surface, Also referred to as Unit Rise.

**Rise Angle** - The angle of the staircase or stair section, defined by a line drawn through the back surfaces of its treads.

**Riser** - The vertical stair member located between the treads. Risers may be solid or open. When open, the front surfaces of the stringers are considered the risers.

**Run** - The depth of a tread, measured from riser surface to riser surface. Run does not include the Tread Overhang. Also referred to as Unit Run.

**Runner** - The carpet that runs down the center of the staircase.

**Shoe** - The bottom railing, placed on the landing floor, that anchors the balusters at landings.

**Stringer** - The inclined support member of a staircase that supports the treads and risers.

**Tread** - The horizontal member of a stair that the foot is placed on.

**Tread Overhang** - The portion of a tread extending past the front surface of the riser and over the tread below. Also referred to as Nosing or Nosing Extension, it is not included in the Run or Tread Depth measurements.

**Tread Thickness** - The vertical depth of the tread material.

## Stair Structure and the Model

Stairs locate the height of the floor platform that they are drawn on and seek the next level, which may be the floor platform of the floor above or a landing. The stringers locate the subfloor of the floor platforms and maintain consistent riser height. If the stairs are long enough to reach the next level at a reasonable rise angle, their tread depth and number of treads are automatically calculated to create a staircase with consistent tread and riser dimensions along its entire length.

## Stair Sections and Subsections

In Home Designer Architectural, staircases can be composed of multiple sections and subsections. See "Merging Stair and Ramp Sections" on page 265.

- Stair sections are separated by landings.
- Subsections are considered part of the same section because they are connected to one another directly rather than separated by a landing.

## Drawing Stairs and Ramps

Stairs and ramps can be drawn in floor plan and 3D views but not in elevation views. In 3D views, these objects can only be drawn in the presence of a floor platform or terrain perimeter. See “Working in 3D” on page 464.

There are a few things to keep in mind when drawing stairs:

- Before stairs are created, make sure that the heights for both the lower and upper floors are correctly defined.
- Stairs are drawn going **UP**, so they should be drawn from the lower of the two floors they connect.
- By default, stairs adjust their riser and tread dimensions to connect two floor heights if possible. The rise and run are calculated so that the steps are consistent in size.
- Stairs drawn within 1” (25 mm) of a wall will snap to the outer surface of the wall.
- Stairs will snap to the **Reference Display** , if you have it turned on.
- If a stairwell room has been defined on the floor above, the top of the stairs can be dragged until it stops at the railing or wall defining the stairwell.
- When drawing stairs or a ramp up from the terrain, it is a good idea to make sure the terrain is up to date. See “Building the Terrain” on page 344.

### Straight Stairs and Ramps

**Straight Stairs**  can be created in three different ways:

- Click and drag in a straight line to draw stairs that are the length that you drag.
- Click once to place stairs that go from the current floor up to the height of the next floor level.
- Click once using the **Click Stairs**  tool to create stairs between rooms on the same floor with different floor heights or between exterior rooms and the terrain.

Similarly, **Ramps**  can be created by either clicking and dragging or by clicking. A ramp created with a single click will be 30” (760 mm) high, have a slope of 1:12, and be 360” (9120 mm) long.

An individual stair or ramp section must be between 6” (150 mm) and 100’ (30,000 mm) in length. If a greater length is needed, connect two sections using a landing.

### Curved Stairs and Ramps



**Curved Stairs** can be created in floor plan view by selecting **Build> Stairs> Curve to Left** or **Curve to Right**. Click to place a 90° curved stair section that can then be edited. You can continue clicking to place additional curved staircases until another tool is selected.

- In addition, you can change a straight stair section into curved stairs, or vice versa by selecting the stairs and clicking the **Change Line/Arc**  edit button. See “Change Line/Arc” on page 114.

Curved **Ramps**  can only be created by first creating a straight ramp and then

clicking the **Change Line/Arc**  edit button.

## Drawing Stairs and Ramps Downward

Stairs and ramps can be drawn from the current floor level downward; however, drawing stairs or ramps between floors in this manner is not recommended. Drawing downward should only be used to create a staircase or ramp between a porch or deck and the terrain when you require the direction arrow to say “DN” instead of “UP”.

### To draw stairs going downward

1. Select **Build> Stairs> Straight Stairs** .
2. Hold down the Alt key or the right mouse button.
3. Click and drag to create straight stairs.

When drawing stairs or ramps from a floor platform to the terrain, or vice versa, they will locate the height of the terrain as long as it is lower than the floor height. You can also create “room” outside the structure and use it to establish the bottom height of the stairs or ramp. Then, draw in an upward direction from the lower platform to the upper platform.

---

## Displaying Stairs, Ramps, and Landings



The display of stairs, ramps, and landings in all views is controlled in the **Display Options** dialog. Stairs, ramps, and landings are placed on the “Stairs & Ramps” layer. See “Displaying Objects” on page 76.

### In Floor Plan View

In floor plan view, stairs, ramps and landings display on the floor they were drawn on and are only visible from the floor above if there is a stairwell. See “Creating a Stairwell” on page 275.

Stairs and ramps have an arrow indicating the direction they run. Interior stairs and ramps have an **UP** arrow on the floor they were created on and a **DN** arrow when viewed from the floor above. See “Drawing Stairs and Ramps” on page 262.

When a staircase is selected in floor plan view, the numbers associated with each of its sections and subsections display. Stair sections are assigned a single number, while subsection numbers have two parts: a section number and subsection number separated by a hyphen.

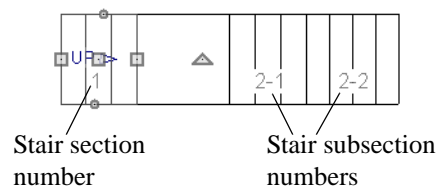

### In 3D Views

Although stairs span between two floors, they can only belong to one floor. As a result, only multi-floor views show the upper floor with the platform opening and the lower

floor with the staircase simultaneously. In **Floor Cameras** and Doll House Views,

stairwells may appear as an empty spaces. See “3D View Tools” on page 450.

---

## Editing Stairs and Ramps



Staircases and ramps can be selected and edited in floor plan view and 3D views. See “Selecting Objects” on page 88.

### Using the Mouse

When a staircase or ramp is selected, its edit handles display. These edit handles can be used to customize the object in many ways. See “Editing Objects” on page 87.

- Straight stair sections and ramps are edited like lines. They have additional edit handles for resizing the width of the section. See “Editing Line Based Objects” on page 90.
- Curved stair sections and ramps are edited like arcs and also include edit handles for resizing the stair’s width. See “Editing Arc Based Objects” on page 92.
- Ramps can be resized to a maximum top height of 30” (760 mm). If you extend a ramp’s length to greater than 360” (9120 mm), it’s slope will decrease. For a taller ramp and control over the slope, uncheck **Automatic Heights** in the **Ramp Specification** dialog and specify the values you need. See “General Panel” on page 284.
- When stair sections are merged, the edit handles display differently depending on

what subsection is currently selected. See “Merging Stair and Ramp Sections” on page 265.

- When moving merged stair or ramp sections, all merged sections move as one.
- Additional edit handles display on the first two treads of a staircase if the **Starter Tread**  edit button is clicked. See “Starter Treads” on page 272.
- Several additional edit handles display on a staircase if the **Flare/Curve Stairs**  edit button has been clicked. See “Flared Stairs and Curved Treads” on page 269.

### In the Specification Dialog



Stairs and ramps can be customized in the **Staircase and Ramp**

**Specification** dialogs. See “Staircase Specification Dialog” on page 277 and “Ramp Specification Dialog” on page 283.

### Using the Edit Tools

A selected staircase or ramp can be edited in a variety of ways using the buttons on the edit toolbar. See “The Edit Toolbar” on page 28.



## Merging Stair and Ramp Sections

Any combination of straight and curved stair sections or straight and curved ramps using **Automatic Heights** can be merged. The resulting staircase or ramp section is made up of subsections and, if there are no landings, functions as a single unit.

Stair and ramp subsections must be drawn in the same direction if they are to be merged:

- The top edge of a stair section or ramp cannot merge with the bottom edge of another section or ramp.
- Combinations of stairs drawn in the **UP** and **DOWN** directions cannot be merged.

Stair subsections merge at the center points of their upper and lower edges.

### *To merge stair or ramp sections*

1. Confirm that the stairs or ramps that you wish to merge are using **Automatic Heights**. See “General Panel” on page 278.
2. Position the sections so they are in the desired relationship to each other.
  - In order to merge stair sections correctly, they must be parallel to one another.
  - To create merged subsections that change direction, make one of the merged sections curved.
3. Select either stair or ramp section so that its edit handles display.
4. Click the Extend handle on the end to be merged and drag it to the point where the two stairs or ramps are to meet.

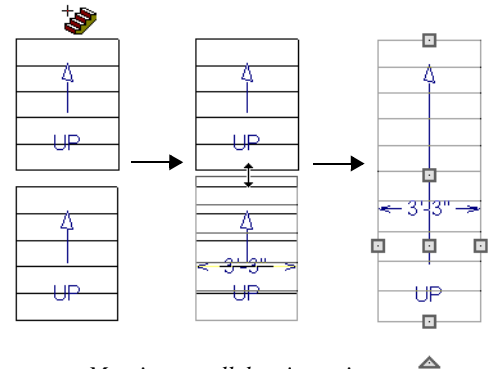

*Merging parallel stair sections*

A staircase consisting of merged subsections resembles a single stair section in floor plan view. The **UP** (or **DN**) arrows join, becoming a single direction arrow.

When a subsection is selected, the entire staircase is selected. Additional edit handles, indicating the presence of multiple subsections and allowing you to reposition the line along which they join. See “Using the Mouse” on page 264.

## Curved Subsections

Stair subsections attached at both ends by other sections do not have a free end that can be dragged into a curve. In this situation, change the middle sub-section to a curve using the **Change Line/Arc**  edit button. See “Change Line/Arc” on page 114.

### *To curve an enclosed stair subsection*

1. Draw three straight stair sections and connect them end to end.

2. Select the middle subsection.

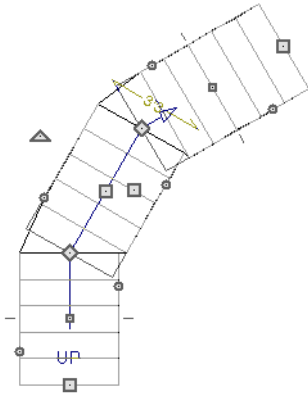

*The middle stair subsection is selected*

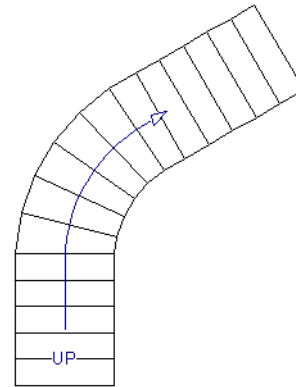

*After using Change Line/Arc*

3. Click the **Change Line/Arc**  edit button. The center section turns into a curved stair section.
4. Use the triangular Change Curve edit handle to adjust the curvature of the middle section as needed.

## Landings

Stair landings are platforms between stair sections and can be created in either of two ways:

- Using the **Landing**  tool.
- By clicking between two stair sections using the **Straight Stairs**  tool.

### *To create a landing between stair sections:*

1. Draw two stair sections going UP. They can be at any angle.
2. Click between the two sections using the **Straight Stairs**  tool to create a landing. Notice that only one direction arrow displays after the sections are joined by a landing.

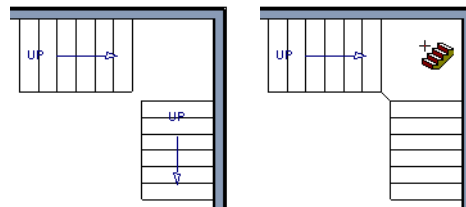

*Creating a stair landing*

Similarly, a landing can be created between two ramps by clicking between them with the

**Ramp**  tool active.

Multiple stair sections and/or ramps can be connected to one landing. For example, two or three stair sections might meet at a landing with a single stair section continuing to the next level.

To be linked by a landing, all sections must be drawn in the same **UP** direction and the top of one section should be near the bottom of the next.

Stair sections connected with a landing will move together as a single unit.

A landing formed between two stair sections having less than a 90° angle between them are created with a short edge not less than 6” (150 mm). This is because most building codes require the shortest tread to be at least 6” wide. This edge can be manually edited to less than 6” if needed.

## Editing Landings

Landings can be selected in 2D and 3D views, both individually and in groups, and edited using the edit handles, the edit toolbar, and the **Landing Specification** dialog. See “Stair Landing Specification Dialog” on page 285.

Landings derive their initial materials and railing characteristics from the stairs and/or ramps attached to them. You can assign a unique material to a landing in its specification dialog or using the **Material Painter** ; however, the railing style is always defined by the attached stairs or ramps.

By default, landings have railings on all edges. You can suppress the railing on a selected edge by clicking the **Remove**

**Railing from Selected Edge**  edit button.

To restore a selected railing, click the **Add**

**Railing to Selected Edge**  edit button.

See “Selected Edge” on page 88.

## Custom Shaped Landings

Landings can be edited like other closed polyline-based objects. You can add or remove edges, convert an edge from straight to curved, or vice versa. A curved landing creates curved railings. See “Editing Closed-Polyline Based Objects” on page 98.

You can edit the shape of a landing into a wide variety of shapes. So that the railings of stair sections connect properly to the landing railings, make sure that each stair section end is snapped to a landing edge with the same length as the stair’s width. If necessary, use the **Break Line**  tool to create a break in a landing edge if it is longer than the connecting stairs are wide. See “Break Line” on page 113.

## Landing Height

A landing’s height is controlled by the program and will adjust automatically as the stairs attached to it are modified so that the stairs maintain a consistent rise angle.

If you specify a landing’s height, that landing becomes locked and will maintain that height no matter how the stairs connected to it are adjusted.

## Unlocked Landings

By default, new landings are unlocked, which means that their height is determined by the stair or ramp sections attached to it. An unlocked landing will automatically adjust its height as necessary to maintain the same riser height and rise angle for all attached sections.

In this example, two stair sections with eight treads each are connected by a landing.

Because the sections have the same number of treads, the landing height is one half of the distance between the two connected floors.

*Unlocked landings maintain consistent riser height*

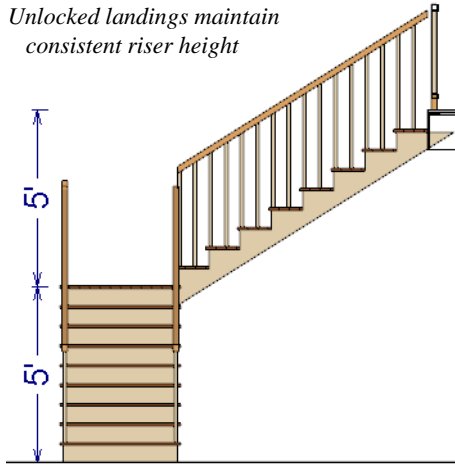

If a change is made to either stair section, the program will maintain the stairs' connection to the floors above and below, and will instead modify the height of the landing and the other stair section so that a consistent riser height is maintained.

As long as a stair or ramp system consists of a landing connecting only two stair sections, the program can easily set landing heights and produce consistent a rise angle. If more than two stair sections meet at a landing, the relationship between them becomes more complex. In this situation, you may want to define the exact height of the landing instead of letting the program define it for you.

## Locked Landings

A locked landing has a specifically defined height that does not adjust automatically when there are changes in the attached stairs. Instead, the stairs adjust to the landing.

For example, start with the same staircase used to illustrate unlocked landings, with one change: the landing height is now defined at 78 inches (1980 mm).

*Locked landings produce independent stair sections*

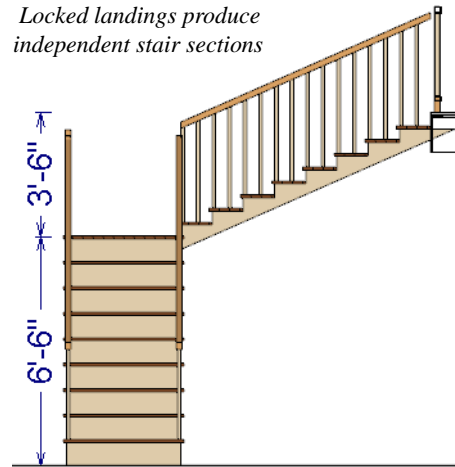

Since the landing height is now closer to the upper floor than to the lower floor, the upper stair section has a very shallow riser height and the lower section has a tall riser height.

Stair and ramp sections attached to a locked landing no longer relate to one another:

- Changes to one section do not affect the other.
- The **Staircase** and **Ramp Specification** dialogs show only the selected section and those connected to it by unlocked landings, rather than the entire system.
- Locked landings do not move when attached stair or ramp sections are moved. Only unlocked landings and the sections attached to them will move.

Locked landing can be used to break up a complex network of stairs and landings into

smaller pieces with known bottom and top heights.

### *To lock a landing*

1. Select the landing and click the **Open Object**  edit button to open the **Stair Landing Specification** dialog. See “General Panel” on page 286.
2. On the GENERAL panel, uncheck **Auto Adjust Height When Connected to Stairs**.

3. Specify the desired **Top Height** and click OK.
4. The landing moves to the specified height and all stairs that connect to that landing are redefined.

To unlock a landing, open its specification dialog, check **Auto Adjust Height When Connected to Stairs**, and click OK. The Top Height will automatically adjust to any stair or ramp sections attached to it and will try to produce a staircase with a single riser height.

---

## Maintaining Tread Depth

Most building codes require staircases to maintain a consistent tread depth.

Home Designer Architectural measures a stair section’s length and tread depth along a Walk Line located 12" (30 cm) from the right edge of the stair section. On curved stairs, it is located 12" (30 cm) from the inside edge of the curve.

When a curved stair section has **Automatic Treads** specified in the **Staircase Specification** dialog and the Walk Line is used, the number and/or width of treads in a section or subsection changes when the inner edge is moved. For this reason, it is best to finalize stair section width as early as possible.

---

## Flared Stairs and Curved Treads



Any stair section can be flared and/or its treads curved using the **Flare/ Curve Stairs** edit button.

Only exposed sides of a stair section can be flared. If one side of a stair section is against a wall or wrapped (see “Wrapped Stairs” on page 273), only the exposed end can be flared.



Flaring, curved treads, and special treads should be the last changes that you make to any stairs.

### Creating a Flared Stair

Flared stairs grow wider near one end, typically sweeping outward at the bottom. Stairs can also be flared at the top or on both ends.



### To create flared stairs

1. Create the stairs and connect them to a landing, floor platform edge, or another stair section.
2. Specify the section width, tread depth, and any other needed information.
3. Select the stairs and click the **Flare/ Curve Stairs**  edit button. New **Flare** edit handles display on all four corners of the stairs.
4. Drag one of the corner handles to flare that corner. As you drag the flare, the Status Bar shows the distance the side handle moves. This allows you to move the opposite handle the same amount.

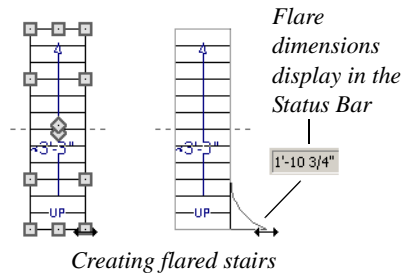

5. When you are finished editing the flare, click the **Main Edit Mode**  to restore the stairs' regular edit handles and toolbar buttons.

### Symmetrically Flared Stairs

Use the dimension information that displays in the Status Bar as a reference to create symmetric flares on both sides.

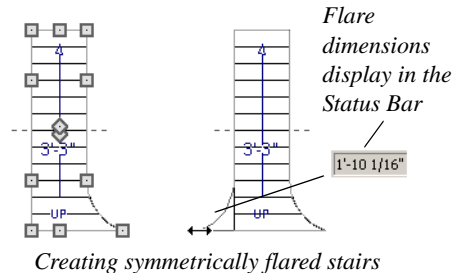

### Adjusting the Flare Radius

After a flared staircase has been created, you may want to soften the radius of the flare.

The four handles at the sides and the four handles at the corners flare the stair section when dragged outward. The two handles in the center of the section move the starting point for flaring along the stair section.

*To adjust the flare radius*

First, adjust the curvature of the flared section.

1. Select the flared stair and click the **Flare/Curve Stairs**  edit button to access the flare handles again.
2. Select the handle along the flared edge of the stair. Drag this handle outward very slightly. This forms a more gradual flare.

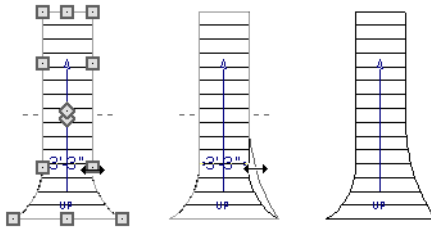

*Adjusting the flare curvature*

Then, adjust the starting point of the flare:

1. Select the flared stair and click the **Flare/Curve Stairs**  edit button to access the flare handles again.
2. This time, drag the lower of the two central handles upward. The handle above it moves with it. This moves the start point for the bottom flare from the middle of the section toward its top, making the flare even more gradual.

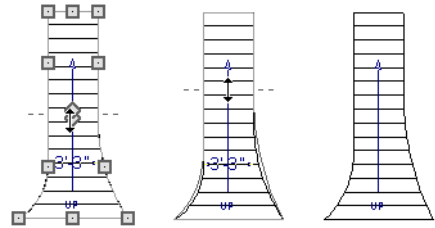

*Adjusting the flare's starting point*

**Treads Perpendicular to Flare**

Flared stairs often look best when the treads curve to meet the flared side perpendicular to the radius.

*To curve the edges of flared treads*

1. Select the flared stair and click the **Flare/Curve Stairs**  edit button to access the flare handles again.
2. Drag a corner edit handle upward one tread depth or less.

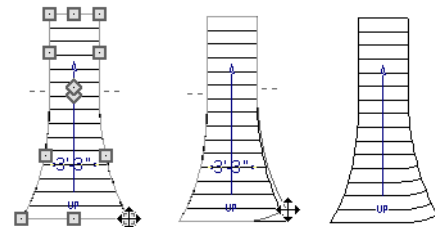

*Curving the edges of flared treads*

3. When you are finished editing the curve, click the **Main Edit Mode**  to restore the stairs' regular edit handles and toolbar buttons.

This type of tread curving works only on flared edges and concentrates the curvature at that edge.

Flared treads can also be curved using the Curve edit handle, which curves the treads more uniformly.

## Curving the Treads

When treads are curved, all treads in the section show some degree of curvature. Treads close to the curved end have a greater curve than those at the opposite end, but both ends can be curved.



### To curve stair treads

1. Select the staircase, then click the **Flare/ Curve Stairs**  edit button.
2. Drag the edit handle at the center of the bottom edge a small distance to curve the treads.

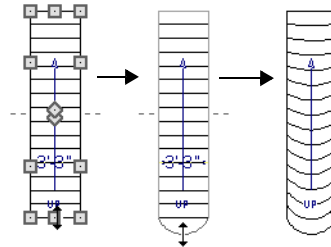

*Creating curved stair treads*

3. When you are finished editing the curve, click the **Main Edit Mode**  to restore the stairs' regular edit handles and toolbar buttons.

---

## Starter Treads



The first and second treads of a staircase can be turned into starter treads by clicking the **Starter Tread** edit button. Starter treads extend to the side of the staircase, have rounded edges and are common on traditional staircases.

A starter tread can be added only to open sides of a stair section. If one side of a stair section is against a wall or wrapped (see “Wrapped Stairs” on page 273), only the exposed tread end can become a starter tread.





**To create starter treads**

1. Click on a staircase to select it.
2. Click the **Starter Tread**  edit button. An edit handle displays on each end of both the first and second treads.

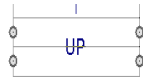

3. Drag either of the handles on the first tread outward from the stair section. If the stair section is against a wall, only one handle displays on the side opposite the wall.
4. As you drag, the ends of the tread become rounded.

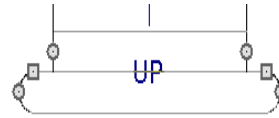

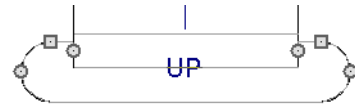

5. Two additional edit handles display on each side of the tread, along the back edge.
6. Drag either of the two square handles upward to increase the width of the rounded ends of the tread.

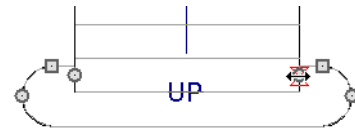

7. Drag the edit handle on the second tread outward from the stair section to create a second starter tread.



8. To make changes to existing starter treads, select the stairs, click the **Starter Tread**  edit button and repeat the above steps as needed.
9. When you are finished editing the starter treads, click the **Main Edit Mode**  to restore the stairs' regular edit handles and toolbar buttons.

## Wrapped Stairs

stairs can be wrapped around the corner of a deck or landing. Curved stairs and stairs with

multiple subsections cannot be wrapped. See “Style Panel” on page 280.

### *To wrap stairs around a deck*

1. Begin by drawing a deck. See “Decks” on page 167.
2. Use the **Click Stairs**  tool to place a stair section on each side of the corner around which you want them to wrap.
3. Move the stair sections toward the corner of the deck. When the two sections are sufficiently close to the corner, they will merge to form wrapped steps.



 You can also draw stairs down from a deck by right-clicking to draw them or by pressing the Alt key while you drag. See “To draw stairs going downward” on page 263.

### *To wrap stairs around a landing*

1. Draw two perpendicular **Straight Stair**  sections.
2. Click between them to create a landing.
3. Rotate one stair section 180°.

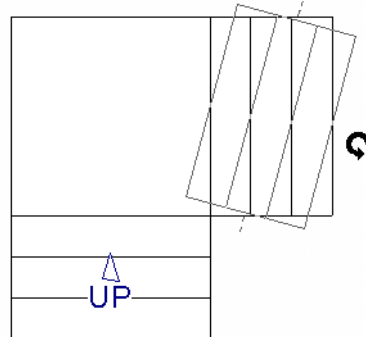

4. The stairs wrap around the corner. Notice that the Up arrow displays on the most recently edited stair section.

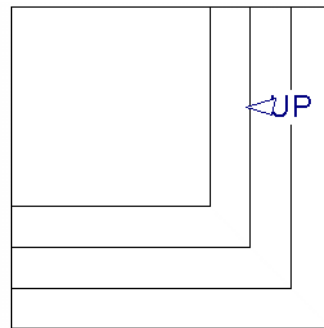

---

## Other Special Railings and Stairs

Stairs can be customized to meet a variety of needs.

### **Solid Railings**

To create a solid rail along a staircase, position a solid Railing or Half Wall  against, but not underneath, the stairs.

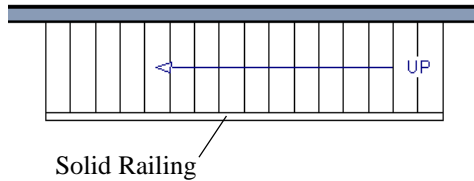

The solid railing recognizes the adjacent stairs and climbs alongside them.



If any balusters extend beyond the railing, eliminate them by unchecking **Left Railing** or **Right Railing** in the **Staircase Specification** dialog. See “Style Panel” on page 280.

---

## Creating a Stairwell

An interior staircase must be located in a stairwell, an opening to the floor above. A stairwell is an Open Below room type on the floor above. See “Room Types” on page 164.

If you create a stairwell away from other walls so the Open Below is created in the center of another room, connect a wall of the Open Below room to another wall using an invisible wall.

### Creating a Stairwell Automatically



To create a stairwell that matches the perimeter of a selected staircase, click the **Auto Stairwell** edit button. This button is only available when a living space exists above the staircase. It will not be available if the space above is Open Below or on the Attic Floor.



**Auto Stairwell**  automatically creates a room on the floor above enclosed by railings, defined as **Open Below** in the **Room Specification** dialog, and given a **Stairwell** room label. This room can be selected and edited like any other room.

### Creating a Stairwell Manually



Stairwells can also be created manually.

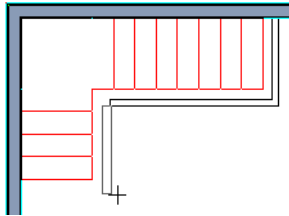

#### *To create a manual stairwell*

1. Draw a two-story building. Create the staircase on the first floor.
2. Make the second floor the **Current Floor** and the first floor the **Reference Floor**. See “The Reference Floor” on page 225.

3. Select **Tools> Reference Floors> Reference Display**  to show the Reference Floor, including the stairs.
4. On the upper floor, use the **Railing**  tool to create a room around the stairs. Use the edit handles to position the railings as needed.



5. Select the railings one at a time and move them into position.
  - When a railing is selected, its bounding box shows the location of the outer surface of the railing’s drywall layer. For best results, this outer surface (which does not display when the railing is not selected) should meet the top edge of the stairs.
  - If you prefer, you can also go **Down One Floor**  and adjust the top edge of the staircase to snap it to the surface of the railing on the floor above.
6. When the railings are positioned properly, select **Tools> Reference Floors> Reference Display**  to turn off the display of the Reference Floor.

7. Click inside the room using the **Select Objects**  tool to select it, then click the **Open Object**  edit button.
8. On the GENERAL panel of the **Room Specification** dialog, select “Open Below” from the **Room Type** list. Click **OK** to close the dialog.

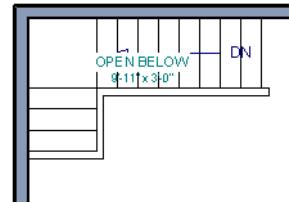



9. Place a **Doorway**  in the railing at the top step for an opening.
10. Select the doorway and define a large width in the **Door Specification** dialog. If the doorway is specified wider than the railing, its width maximizes to fit the space available.



## Rooms Below Staircases

Rooms such as closets or storage areas are commonly located beneath staircases.

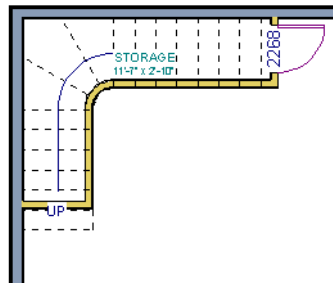

**To create a room below a staircase**

1. Draw a staircase, select it, and click the **Open Object**  edit button to open the **Staircase Specification** dialog.
  - On the **FILL STYLE** panel, select None (Transparent) so the walls and other objects under the stairs can be seen.
2. On the same floor as the staircase, draw the **Interior Walls**  under them, following their shape.
3. Reposition the walls as needed, making sure that each is entirely under the stairs.
4. The wall at the foot of the stairs should be placed no closer to the bottom than the second step.
5. Add a door and specify the Room Type.



---

## Staircase Specification Dialog

 Staircases can be defined with the greatest accuracy in the **Staircase Specification** dialog. To open this dialog, select a stair section and click the **Open Object** edit button or double-click a stair section using the **Straight Stairs**  or **Select Objects**  tool.

If a staircase is composed of multiple stair sections, the section that you clicked on to

select the staircase is the Selected Section; however, information about all the sections is available and can be edited in the dialog.



It is recommended that all floor heights, ceiling heights and platform thicknesses be established before using the Staircase Specification dialog.

## General Panel

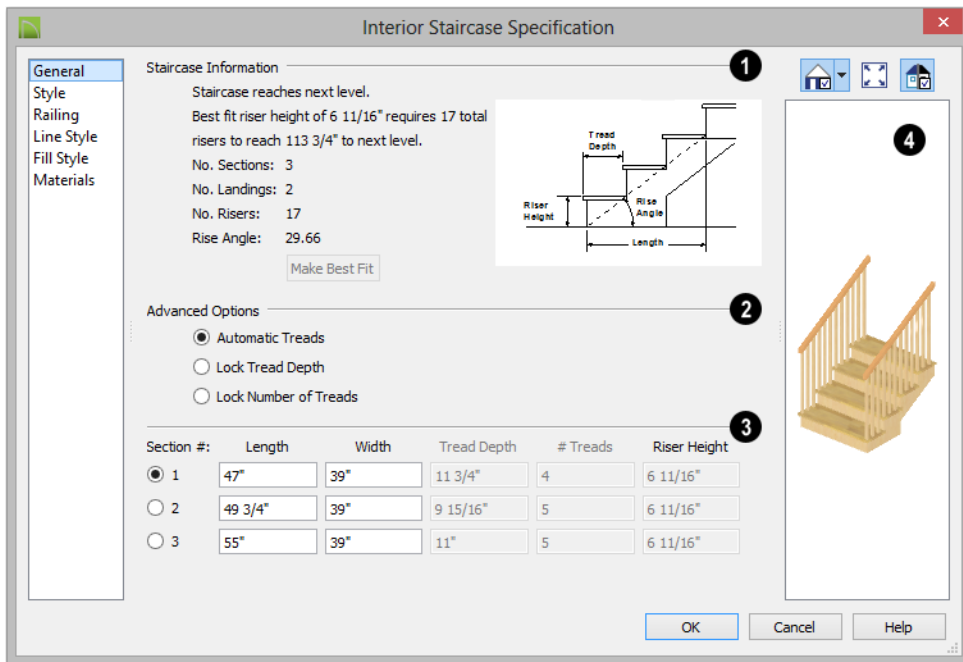

**1 Staircase Information** - Structural information about the selected staircase displays here for reference and updates as changes are made on the GENERAL panel.

- The first comment tells whether or not the staircase reaches the next level. It also indicates whether its rise angle is either steeper or more shallow than the Best Fit, described below. If **Automatic Heights** is unchecked, this comment instead says "Start and end heights are set manually".
- The second comment, **Best fit riser height of \_\_\_ requires \_\_\_ total risers to reach \_\_\_ to next level**, describes the ideal rise and run for the selected staircase. The program defines the Best Fit Riser Height as the riser height closest to 6 3/4" (168.75 mm) that allows the

selected staircase to meet the next level precisely. This comment is only active if **Automatic Heights** is checked, below.

- The total number of stair **Sections**, **Landings**, and **Risers** associated with the selected staircase also display here.
- The **Rise Angle** of the currently active stair section also displays here.
- Click the **Make Best Fit** button to add or remove risers to the Selected Section. Only available when **Automatic Heights** is checked and the staircase does not currently use the Best Fit Riser Height.

**Make Best Fit** will also extend stairs drawn in a downward direction until they reach the terrain. See "Terrain Perimeter" on page 333.

A diagram of a sample staircase's structure displays here for reference, as well.

- 2** The **Advanced Options** apply to all sections and subsections.
- Select **Automatic Treads** to have the program define the depth and number of stair treads. If the staircase has multiple sections, each may have different tread depths.
  - Select **Lock Tread Depth** to specify the Tread Depth for each stair section, below, and prevent them from changing. When Lock Tread Depth is selected and the length of the stairs is changed, the number of treads will change.
  - Select **Lock Number of Treads** to specify the number of treads in each stair section and prevent it from changing. When Lock Number of Treads is selected and the length of the stairs is changed, the tread depths will change.
  - If a staircase with multiple sections is selected, **No Change** may be an option as well. Select this to maintain the multiple sections' individual settings.

**3** The specifications for each stair section and subsection are listed and can be edited here. Up to ten items total can display.

A change in one value usually affects other values. You may need to reposition the staircase after making changes.

- The **Section Number** column identifies the Selected Section and the number of

each section of the selected staircase. The radio button to the left indicates which section or subsection is selected. See "Displaying Stairs, Ramps, and Landings" on page 263.

- Define the **Length**, or run, of each section.

When the length of a section changes, other sections and landings in the staircase unit move in response. You can specify whether the bottom or top edge of the Selected Section moves when you resize it by selecting either the Lock Bottom or Lock Top radio button, above.

- Define the **Width** of each section. If a section is connected to a landing, its width should equal the length of the landing edge that it connects to. See "Landings" on page 266.
- Specify the **Tread Depth**, or run, of each stair tread in the selected section.
- Define the number of **Treads** in a stair section or subsection.
- Define the **Riser Height**, the height of the risers in each stair section.

**4** A preview of the selected staircase displays on the right side of the panel. If the staircase includes any landings, only the section that was selected when the dialog was opened will display. See "Dialog Preview Panes" on page 32.

## Style Panel

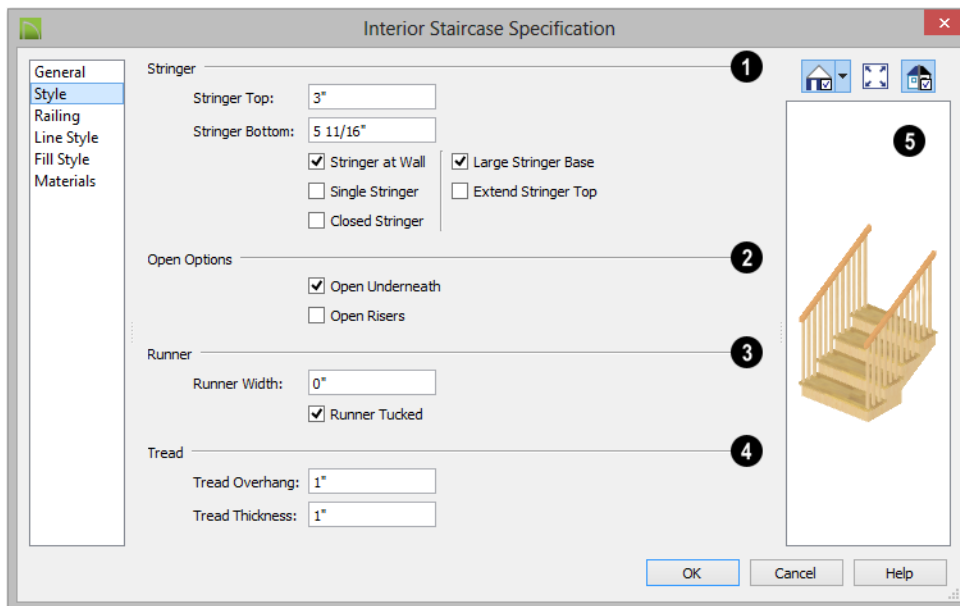

**1** Specify the attributes of the selected staircase's **Stringers**, which are the angled support members that support the treads. See "Anatomy of a Staircase" on page 260.

- Specify the height of the **Stringer Top** when **Stringer at Wall** or **Closed Stringer** is selected. This is measured from the top front corner of a tread.
- Specify the height of the **Stringer Bottom**, as measured from the bottom back corner of a tread.
- Check **Stringer at Wall** to produce a raised stringer top baseboard at the sides of the stair sections against walls. This baseboard follows the slope of the stair.

- Check **Single Stringer** to form a single 5-inch (125 mm) thick stringer in the center of the staircase. Checking **Single Stringer** automatically checks **Open Risers** and unchecks **Stringer at Wall** and **Closed Stringer**.
- Check **Closed Stringer** to raise the tops of the exposed stringers to cover the sides of the treads. If this is checked, no central stringer is applied to open riser stairs. This setting only affects those stringers that are not against a wall.
- Check **Large Stringer Base** to widen the stringers at the foot of the staircase. This is helpful when walls are created below the stairs.



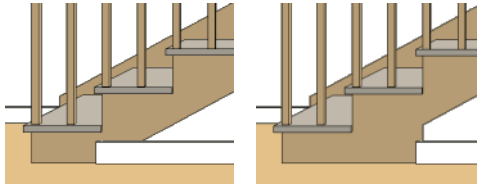

*Large Stringer Base shown at right*

- **Extend Stringer Top** is checked by default and extends a triangular portion of the stringer under the landing or platform at the top of the stairs.
- ② **The Open Options** control whether the selected stairs have open risers or an open underside. They are not available when **Single Stringer** is checked, above.
  - Uncheck **Open Underneath** to add a skirt below the staircase along the two sides. It looks like a wall in 3D, but only has a single face. Base molding does not generate along the bottom of the skirt, and doors cannot be placed in it. In most cases, the recommended way to enclose the area beneath stairs is to use walls. See “Rooms Below Staircases” on page 276.
  - Check **Open Risers** to eliminate the riser face under each tread and expose the

stringers. If **Closed Sides** is also selected, no central stringer is supplied.

- ③ Specify the attributes of the staircase’s carpet **Runner**. Only available when **Open Risers** is unchecked, above.
    - Specify the **Runner Width**. The default value of 0 does not create a runner.
    - Uncheck **Runner Tucked** to have the runner drop straight down from the tread front to the riser below. This is checked by default.
  - ④ Specify the characteristics of the staircase **Treads**. See “Anatomy of a Staircase” on page 260.
    - Specify the **Tread Overhang**, which is the distance that each tread overhangs the riser.
    - Specify the **Tread Thickness**.
- A preview of the selected staircase displays on the right side of the panel. If the staircase includes any landings, only the section that was selected when the dialog was opened will display. See “Dialog Preview Panes” on page 32.

## Railing Panel

The settings on the **RAILING** panel can also be found in the **Ramp Specification** dialog and will affect the appearance of railings on

any landings attached to the selected staircase or ramp. See “Landings” on page 266.

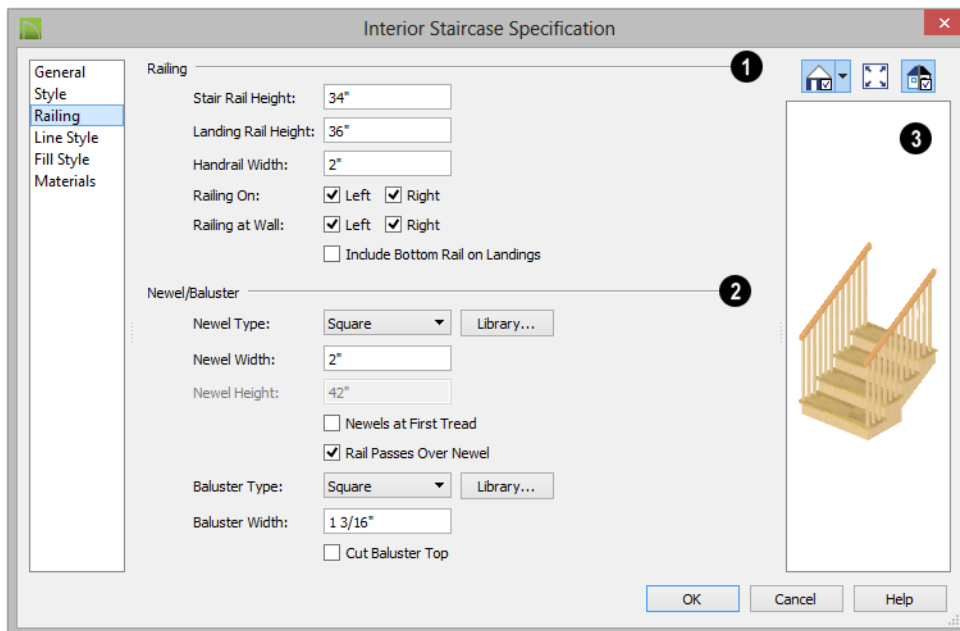

- 1 Specify how the **Railing** is applied to the selected staircase.
  - **Stair Rail Height** defines the height from tread surface directly over the riser to railing top.
  - **Landing Rail Height** defines the height of the landing rail top from the landing surface.
  - **Handrail Width** defines the horizontal width of the handrail used by the selected staircase and any attached landings.
  - **Railing On** - Select **Left** and/or **Right** to specify placement of railings on stair sections.
  - **Railing at Wall** - Select **Left** and/or **Right** to specify the placement of wall railings. Not available for ramps.
  - Check **Include Bottom Rail on Landings** to place a low rail on the landing surface that receives the balusters ends.
- 2 **Newel/Balusters** options -
  - **Newel Type** - Select **Square**, **Round**, or **Library** newels. Selecting **Library** from the drop-down list is the same as clicking the **Library** button to the right and allows selection of a newel from the library.
  - Specify the **Newel Width**, which is the width or diameter of each newel. For Library newels, this is the width at its widest point.
  - Specify the **Newel Height**, which is the height from the landing surface to the top of the newel. This is used only when **Rail passes over Newel** is unchecked.

- Check **Newels at First Tread** to place a newel where the rail starts at the base of the stairs. A newel is placed only on a side of the stairs not against a wall.
- Uncheck **Rail Passes Over Newel**, then adjust the **Newel Height** to as needed. When this is checked, the **Newel Height** setting is ignored.
- **Baluster Type** - Select **Square**, **Round**, or **Library** balusters. Selecting **Library** from the drop-down list is the same as clicking the **Library** button to the right and allows selection of a baluster from the library.
- Specify the **Baluster Width**, which is the width or diameter of each baluster. For **Library** balusters, this is the width at its widest point.
- **Cut Baluster Top** - Each tread normally has two to three balusters, growing longer toward its back. The default is to use the same baluster and cut it off at the bottom to shorten it toward the tread front. Check this box to cut the balusters at the top instead.

## Line Style Panel

The settings on the **LINE STYLE** panel are available for a variety of other objects in the program. For information about these settings, see “Line Style Panel” on page 514.

## Fill Style Panel

The settings on the **FILL STYLE** panel affect the appearance of the selected staircase in floor plan view. For information about these settings, see “Fill Style Panel” on page 519.

## Materials Panel

The settings on the **MATERIALS** panel affect the appearance of the selected staircase in 3D views and are available for a variety of objects throughout the program. For information about these settings, see “Materials Panel” on page 420.



The settings on this panel will also affect the materials applied to any landings attached to the selected staircase. See “Landings” on page 266.

---

## Ramp Specification Dialog



Ramps can be defined with the greatest accuracy using the **Ramp Specification** dialog. To open this dialog, select a ramp and click the **Open Object** edit

button or double-click a ramp section using the **Ramp**  or **Select Objects**  tool.

## General Panel

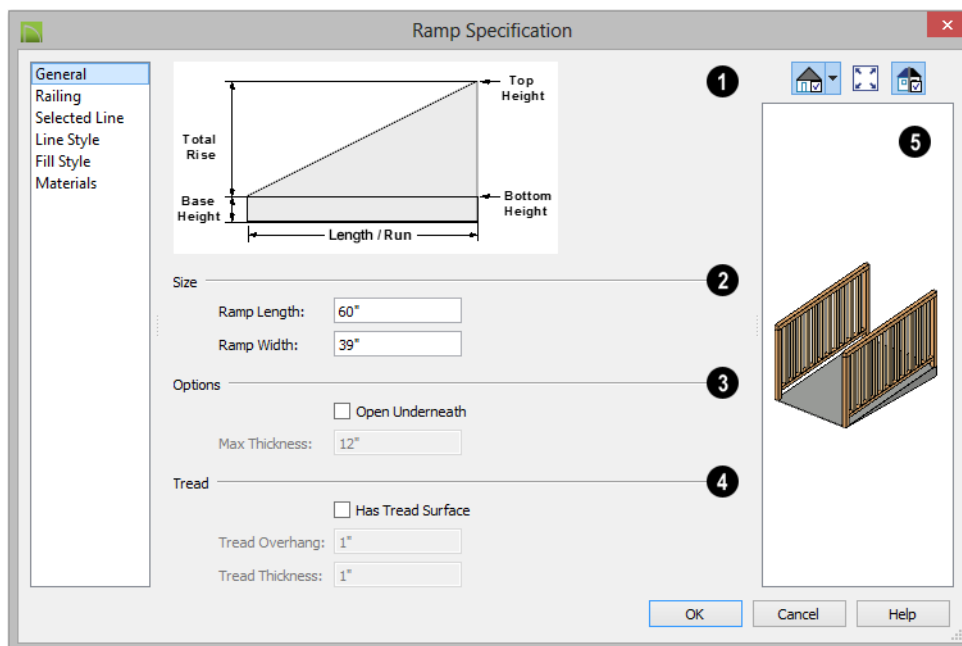

- 1 A diagram of a sample ramp's structure displays here for reference.
- 2 **Size** - Specify the **Ramp Length** and **Width**.
- 3 **Options** -
  - Check **Open Underneath** to remove the skirt around the bottom of the ramp so that it has a uniform, sloped thickness that may not reach the floor or terrain at the high end. This is unchecked by default.
  - Specify the **Max Thickness**, which is the ramp's maximum thickness. At the low end of the ramp where it meets the floor or terrain, its thickness may be less than this value.
- 4 Specify the structure of the ramp's **Tread**, which is an optional surface layer placed over the top of the ramp.
  - Check **Has Tread Surface** to apply a top tread surface to the ramp and enable the settings below.
  - Specify the **Tread Overhang**, which is the distance the tread surface extends past the ramp's edges.
  - Specify the **Tread Thickness**, which is the tread surface's vertical depth.
- 5 A preview of the selected ramp displays on the right side of the panel. If the ramp is composed of multiple sections separated by landings, only the section that was selected when the dialog was opened

will display. See “Dialog Preview Panes” on page 32.

### Railing Panel

The settings on the RAILING panel are similar to those on the same panel in the **Staircase Specification** dialog. For information about these settings, see “Railing Panel” on page 281.

### Selected Line Panel

The SELECTED LINE panel is available when the selected ramp section is straight as opposed to curved. See “Selected Edge” on page 88.

The settings on this panel are available for a variety of other objects in the program. For information about the settings on this panel, see “Line Panel” on page 513.

### Selected Arc Panel

The SELECTED ARC panel is available only when the selected ramp section has been converted to an arc. See “Change Line/Arc” on page 114.

The settings on this panel are available for a variety of other objects in the program. For

information about these settings, see “Arc Panel” on page 516.

### Line Style Panel

The settings on the LINE STYLE panel are available for a variety of other objects in the program. For information about these settings, see “Line Style Panel” on page 514.

### Fill Style Panel

The settings on the FILL STYLE panel affect the appearance of the selected ramp in floor plan view. For information about these settings, see “Fill Style Panel” on page 519.

### Materials Panel

The settings on the MATERIALS panel affect the appearance of the selected ramp in 3D views and are available for a variety of objects throughout the program. For information about these settings, see “Materials Panel” on page 420.

The settings on this panel will also affect the materials applied to any landings attached to the selected ramp. See “Landings” on page 266.

---

## Stair Landing Specification Dialog



Select a landing and click the **Open Object** edit button to open the **Stair**

**Landing Specification** dialog. See “Landings” on page 266.

## General Panel

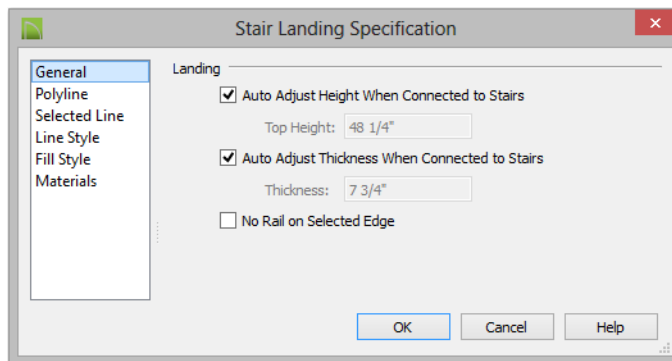

Uncheck **Auto Adjust Height When Connected to Stairs** to specify the selected landing's Top Height.

- A free-standing interior landing will have a default Top Height of 6 3/4" (169 mm) plus the thickness of the default floor finish. A free-standing exterior landing will have a default top height equal to its thickness. When this box is checked, the landing height may adjust as needed to maintain consistent riser height in all connected stair sections.
- The **Top Height** field is only active when Auto Adjust Height When Connected to Stairs is unchecked. See "Locked Landings" on page 268.

Uncheck **Auto Adjust Thickness When Connected to Stairs** to specify the selected landing's Thickness.

- A free-standing landing will have a default thickness of 6 3/4" (169 mm). When checked, the thickness is based on the riser height of the stair sections it is attached to, or the thickness of the ramps it is attached to.

- The **Thickness** field is only active when Auto Adjust Thickness When Connected to Stairs is unchecked.

Check **No Rail on Selected Edge** to suppress the railing on the selected edge of this landing. See "Selected Edge" on page 88.

## Polyline Panel

The POLYLINE panel states the length of the landing's **Perimeter**, its enclosed **Area**, and its **Volume**.

The settings on the this panel are available for a variety of other objects in the program. See "Polyline Panel" on page 518.

## Selected Line Panel

The SELECTED LINE panel is available when the selected edge is a line as opposed to an arc. See "Selected Edge" on page 88.

The settings on this panel are available for a variety of other objects in the program. See "Line Panel" on page 513.

Moving the End of a line segment moves the start of the next connected line.

## **Selected Arc Panel**

The **SELECTED ARC** panel is available only when the selected edge has been converted to an arc. See “Change Line/Arc” on page 114.

The settings on this panel are available for a variety of other objects in the program. See “Arc Panel” on page 516.

## **Line Style Panel**

The settings on the **LINE STYLE** panel are available for a variety of objects throughout the program. See “Line Style Panel” on page 514.

## **Fill Style Panel**

The settings on the **FILL STYLE** panel affect the appearance of the selected landing in floor plan view. See “Fill Style Panel” on page 519.

## **Materials Panel**

When a landing is attached to stairs or a ramp, its initial materials are derived from the stairs or ramp. When the landing is attached to a ramp, its top surface material is defined by the Landing Sides component unless the ramp is using a Tread material.

The settings on this are available for a variety of objects throughout the program. For information about these settings, see “Materials Panel” on page 420.

Labels for stair landings display in floor plan view when the “Polylines 3D, Labels” layer is turned on and use the Text Style. See “Displaying Stairs, Ramps, and Landings” on page 263.





# Electrical

The electrical plan shows the location of all electrical objects such as lights, switches, outlets, smoke detectors and vent fans. Basic wiring diagrams show which objects share circuits and the locations of the controlling switches.

Electrical objects can be displayed in 2D and 3D views. Some electrical light fixtures also add light sources to 3D views. See “Lighting” on page 472.

Usually, the electrical plan is one of the last additions to a plan since the position of most electrical objects is determined by the location of walls, cabinets and other objects.



Building requirements vary throughout the country and around the world. It is your responsibility to comply with local codes.

## Chapter Contents

- The Electrical Tools
- Auto Place Outlets
- Creating Wiring Schematics
- Electrical Library Content
- Displaying Electrical Objects
- Editing Electrical Objects
- Electrical Service Specification Dialog

## The Electrical Tools



Select **Build> Electrical** to access the Electrical Tools.

Click in floor plan view to place an electrical object. Some can only be placed against walls, some only on the ceiling or floor, and some automatically change as needed. If you click within 12" of the wall, the selected object is placed on the wall.

Once an electrical object has been placed, it can be edited in the **Electrical Service Specification** dialog. See “Electrical Service Specification Dialog” on page 295.

### Outlets



Select **Build> Electrical> 110V Outlet** to place 110 volt duplex outlets in walls or on the floor. Select **Build> Electrical> 220V Outlet** to place 220 volt outlets.

The type and height of an outlet will vary depending on where it is placed. For example:

- In rooms defined as Bath or Master Bath, Ground Fault Circuit Interrupt (GFCI) outlets are placed.



If standard outlets are placed in a room prior to defining it as a Bath, you should replace them with GFCI outlets.

- An outlet placed at the back of a base cabinet in floor plan view is positioned above the counter.
- An outlet placed at the back of a base cabinet containing a kitchen sink is

placed at the standard 11 1/2" (300 mm) above the floor.

- Outlets placed outside the building or in an exterior area such as a deck or porch are labeled WP, or Water Proof.

To take advantage of the program’s capabilities, define room types properly before placing electrical objects. See “Room Types” on page 164.

### Light Fixtures



Select **Build> Electrical> Light** to place light fixtures. All light fixtures placed in a plan can also serve as light sources in 3D views. To place a light fixture using the Light tool

- Click near a wall to place a wall-mounted fixture at that location.
- Click away from a wall to place a ceiling mounted light.
- Click outside of a room and away from a wall to place a path light.
- Some light symbols from the library can be mounted under wall cabinets, as well.

The rendering characteristics of individual lights that control how they appear in 3D views can be specified on the LIGHT DATA panel of the **Electrical Service Specification** dialog. See “Light Data Panel” on page 297.

### Switches



Select **Build> Electrical> Switch** to place electrical switches. Like outlets,

the height of switches is measured from the floor to the center of the object.

An electrical switch can be placed on either a wall or a cabinet, depending on the type of switch. A selection of each type is available in the Library Browser. See “Placing Library Objects” on page 406.



If you connect two or more switches in a circuit, they update to 3-way or 4-way switches automatically.

## Auto Place Outlets



Select **Build> Electrical> Auto Place Outlets** and click in a room tool to place outlets at regular intervals around the entire room. See “Auto Place Outlets” on page 291.

## Connect Electrical



Select **Build> Electrical> Connect Electrical**, then click and drag to draw splines that snap to electrical switches, outlets, and lights to illustrate wiring circuits. See “Creating Wiring Schematics” on page 292.

## Lighting and Electrical Library Catalogs



A selection of free-standing and ceiling-, wall- and cabinet-mounted light fixtures is available in the Library Browser at Home Designer Core Catalogs> Architectural> Lighting.

Special use outlets, switches, jacks and numerous other electrical items can be found at Home Designer Core Catalogs> Mechanical, Electrical, Plumbing> Electrical. See “The Library” on page 393.



---

## Auto Place Outlets



Select **Build> Electrical> Auto Place Outlets** and click in a room to place 110 volt outlets around the entire room, spaced so that no wall position is farther than six feet (1800mm) from the nearest outlet. 110 or 220 volt outlets are also placed behind large appliances. In addition, a light is placed above each sink.

It is important that a room’s Type be defined before **Auto Place Outlets**  is used so that outlets are placed appropriately. For example, GFCI (Ground Fault Circuit Interrupter) outlets are placed over cabinets in Kitchen, Bath and Master Bath rooms. See “Room Types” on page 164.

**Auto Place Outlets**  does not work in rooms assigned an exterior room type such as Deck. To place outlets in an exterior room, place them from the Electrical Library or use the **110V Outlets**  tool.

Railings and invisible walls are ignored by **Auto Place Outlets** . If it is used in a room defined by railings or invisible walls, outlets are automatically placed in any adjacent rooms on the other side of these wall types. See “Room Definition” on page 160.

Note: Auto Place Outlets requires that a room have a door before outlets can be placed.

Once placed, any outlet can be moved, edited, or deleted. See “Editing Electrical Objects” on page 294.

## Creating Wiring Schematics

Electrical schematics can be created in two ways. Using the **Connect Electrical**  tool is quick and easy, but if you need detailed schematics, you can create your own wiring diagrams using the CAD tools. See “CAD Objects” on page 511.

### Connect Electrical

Select **Build > Electrical > Connect Electrical**, then click and drag to draw splines that snap to electrical switches, outlets, and lights to illustrate wiring circuits. See “Splines” on page 520.

To create a new circuit or add to an existing circuit, click on a switch, outlet, or light

while the **Connect Electrical**  tool is active, drag to the next object and

release. When a Connect Electrical  spline is first drawn, it looks like an arc but actually consists of two segments that are defined by vertex points. When selected, its edit handles display at each of these vertices. If you click and drag one of these edit handles, the length, angle, and curvature of the spline will change but the other vertices will not move.

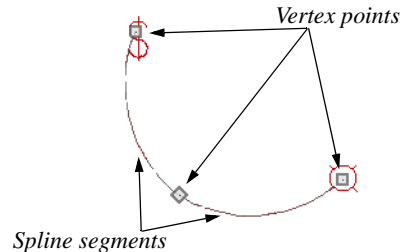

**Connect Electrical**  splines cannot be snapped to one another: they can only snap to electrical objects. Once drawn, though, additional vertices can be added and used to form complex curves. See “Editing Spline Based Objects” on page 103.

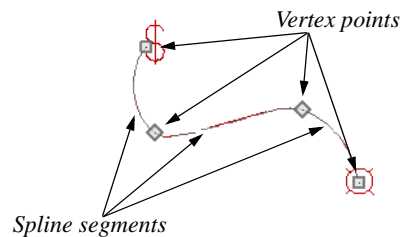

To remove a connection from a circuit, simply select and **Delete**  it. If you remove an electrical object from a circuit, any Connect Electrical splines snapped to it will also be deleted. See “Deleting Objects” on page 116.

## Three- and Four-Way Switches

Multiple switches can control an object or group of objects.

- Two switches controlling the same objects are referred to as three-way switches.

- Three switches controlling the same objects are called four-way switches.

In floor plan view, a three- or four-way switches's "way" number will automatically display in its 2D symbol.

---

## Electrical Library Content



Select **View > Library Browser** to access a variety of electrical symbols. See "The Library" on page 393.

Browse for electrical objects such as bath vent fans, an electrical panel, fluorescent lights, chandeliers, a smoke detector, thermostat, and more. Select a symbol, then click in your plan to place it on a wall, floor, or ceiling.

## Adding Electrical Content

Any electrical symbol placed into a plan can be customized and added to the User Catalog in the Library Browser. Customized settings are retained. See "Add to Library" on page 402.

---

## Displaying Electrical Objects



The display of electrical objects and connections is controlled in the **Display Options** dialog. See "Displaying Objects" on page 76.

When displayed in 3D views, light fixtures act as sources of light that help illuminate the 3D model. See "Lighting" on page 472.

Electrical symbols are placed on the "Electrical" layer, while Connect Electrical splines are drawn on the "Electrical, Connections" layer.

on and use the "Default Label Style" Text Style See "Object Labels" on page 575.

Customized labels can be specified in the **Electrical Service Specification** dialog..

Note: Some electrical objects are represented in floor plan view by a symbol that includes text. This text is not part of the object's label and does not use the Default Label Text Style.

### Electrical Labels

Electrical labels display in floor plan view when the "Electrical, Labels" layer is turned

### In the Materials List

Electrical objects, including outlets, switches, lights, and symbols from the library, are listed under the Electrical

Category in the Materials List. See “Materials Lists” on page 579.

---

## Editing Electrical Objects

Electrical objects can be selected as a group and individually in 2D and 3D and edited using the edit handles, the edit toolbar and their specification dialog. See “Electrical Service Specification Dialog” on page 295.

Light fixtures and Added Lights can be group-selected, but their light data cannot be edited unless each has the same number of light sources. See “Lighting” on page 472.

Lights can also be edited using the **Adjust Lights** dialog. See “Adjust Lights Dialog” on page 474.

### Moving Electrical Objects Using Dimensions

Electrical objects can be moved precisely using manual dimensions. See “Moving Objects Using Dimensions” on page 494. First, dimensions must be checked on the LOCATE OBJECTS panel of the **Dimension Defaults** dialog. See “Dimension Unit Defaults” on page 485.

### Using the Edit Handles

The edit handles for electrical objects vary depending on the location of the object. Wall mounted electrical objects cannot be rotated, so only the Move edit handle displays.

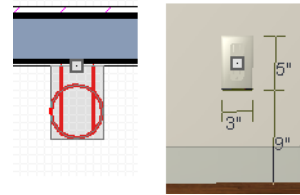

*Wall-mounted outlet in 2D and 3D views*

Electrical objects placed on floors and ceilings can be rotated.

Electrical connections edit like splines. See “Editing Spline Based Objects” on page 103.

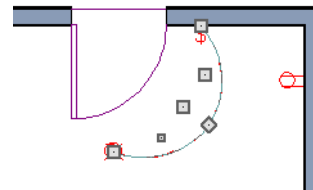

### Using the Edit Tools

A selected electrical symbol can be edited in a variety of ways using the buttons on the edit toolbar. See “The Edit Toolbar” on page 28.

### Adjusting Electrical Object Heights

When a wall-mounted electrical object is placed in floor plan view, its initial height is based on commonly used standards.

An electrical object placed on a wall in a 3D view is positioned wherever you click on the wall, regardless of the height at that point.

Once placed, a wall-mounted electrical object's height can be edited in either of two ways:

- Specify the height in the **Electrical Service Specification** dialog. See “Electrical Service Specification Dialog” on page 295.

- In 3D views, the position of an electrical object can be adjusted using its edit handles.

## Deleting Electrical Objects

An electrical object can be deleted by selecting it and clicking the **Delete**  edit button or by pressing the Delete key.

All electrical objects in a room, on a floor, or in the entire plan can also be deleted as a group using the **Delete Objects** dialog. See “Deleting Objects” on page 116.

---

## Electrical Service Specification Dialog



Select an electrical object and click the **Open Object** edit button to open the **Electrical Service Specification** dialog.

The settings in this dialog vary, depending on the type of object(s) you select.

### General Panel

The items on this panel vary, depending on the type of electrical object selected.

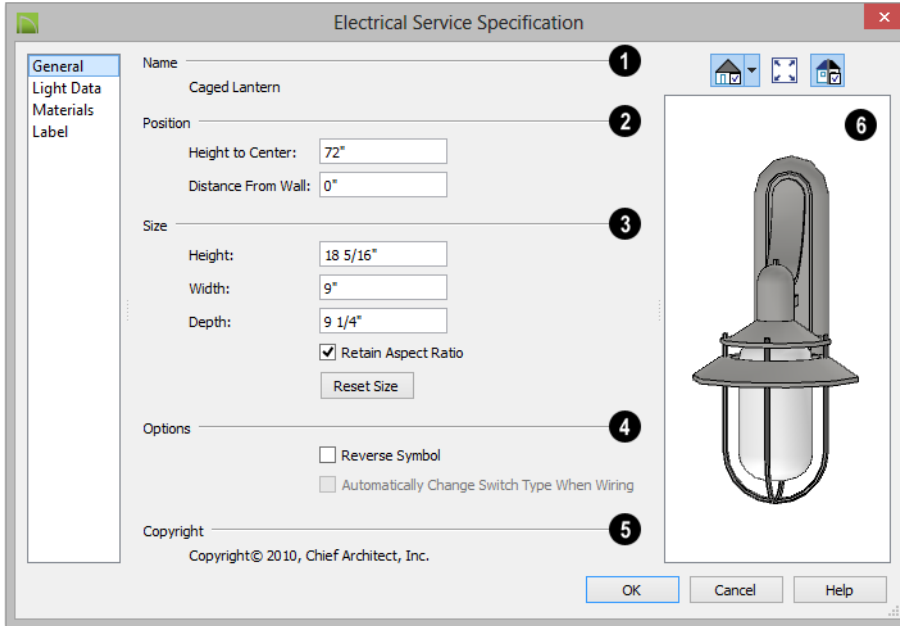

- 1 The **Name** of the selected object as used in the Library Browser and Materials List displays here.
- 2 Specify the **Position** of the selected electrical object. The options available depend on the type of object selected.
  - Specify the **Offset From Ceiling** of a ceiling outlet or ceiling mounted light. If the light is mounted to a cabinet, this value is the offset from the cabinet.
  - Specify the **Height to Center** of a switch, wall outlet or wall light.
  - Specify the **Offset From Floor** of a floor outlet or floor lamp.
  - Specify the **Distance From Wall** of a wall mounted symbol. A negative value will recess the symbol into the wall and may prevent it from being seen in 3D.

- 3 Specify the **Size** of the selected electrical symbol.
  - Specify the **Height, Width and Depth** of the selected symbol.
  - Click the **Reset** button to restore the electrical symbol's original size.
- 4 **Options** -
  - Check **Reverse Symbol** to reverse the object's appearance so that features on its left are located on its right and vice versa. Does not affect symmetrical symbols.
  - Check **Automatically Change Switch Type When Wiring** for a selected switch to become a three- or four-way switch if your wiring plan uses it as such. See "Connect Electrical" on page 292.

Switches placed from the toolbar use this



option by default; switches placed from the library do not.

- 5 Any **Copyright** information associated with the selected symbol will be stated here.

- 6 A preview of the selected object displays here. See “Dialog Preview Panes” on page 32.

## Light Data Panel

The LIGHT DATA panel is available when the selected electrical object is a light fixture. The available options vary depending on the type of light selected.

The settings on this panel are similar to those on the same panel of the **Light Specification** dialog. See “Light Specification Dialog” on page 476.

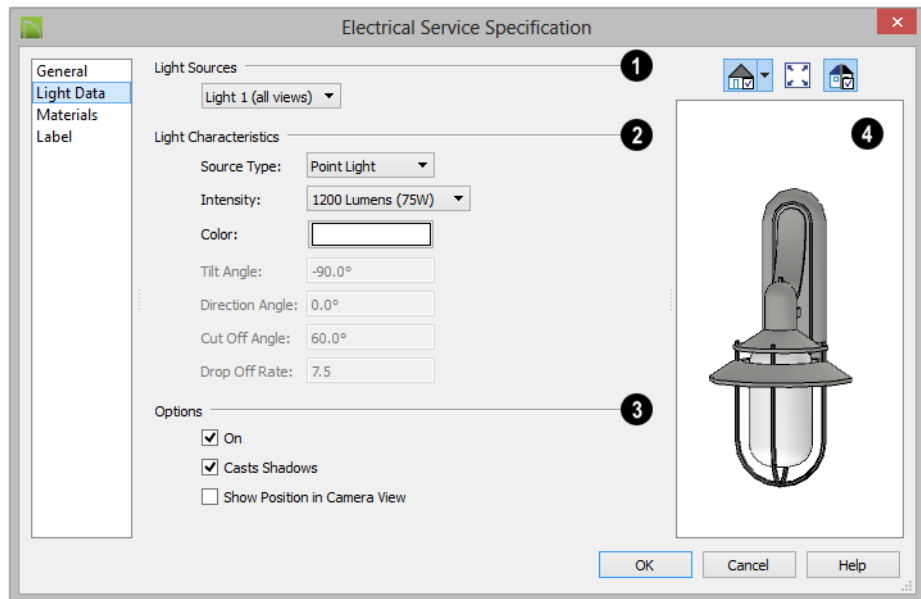

- 1 Each fixture can have multiple **Light Sources**, listed here. Not available for Added Lights. See “Lighting” on page 472.
- Select a **Light Source** assigned to the selected light fixture from the drop-down list. The selected light source can be edited using the settings on this panel.

- 2 Specify the **Light Characteristics** of the currently selected Light Source.
- Select a light **Source Type** from the drop-down list. The type selected determines what options are enabled on this panel. See “Light Types” on page 475.
  - Select an **Intensity** from the drop-down list. The available options are described

using lumens and correspond to commonly used light bulb wattages.

- Select “Custom” from the **Intensity** list to open the **Custom Light Intensity** dialog and create a custom Intensity setting. See “Custom Light Intensity Dialog” on page 299.
- Click the **Color** bar to define the color of the selected light source. Colored lights alter the appearance of textures and can be used to achieve special effects. See “Select Color Dialog” on page 438.



The default color of light is pure white, which has the least affect on the appearance of material colors and textures.

The Angle and Drop Off Rate settings below are not available when the Source Type is Point Light.

- The **Tilt Angle** controls the angle of the illumination with respect to the horizon. A value of  $-90^\circ$  points the light straight down and a value of  $90^\circ$  points it straight up.  $0^\circ$  is parallel to the horizon.
- The **Direction Angle** defines the direction of the illumination relative to the ground.  $0^\circ$  is measured horizontally pointing to the right. Positive values rotate in a counter-clockwise direction from there. Enter a value up to  $360^\circ$ . If you enter a negative value, the program adds  $360^\circ$  to it when you click OK or press the Tab key.
- The **Cut Off Angle** controls the angle of the cone of illumination for Spot Lights only. A cone angle of  $180^\circ$  creates a spot light that shines in a half sphere on one side of the light source. A small cone angle, for example  $10^\circ$ , creates a very narrow cone of light. The cut off angle should always be between  $0^\circ$  and  $180^\circ$ .
- The **Drop Off Rate** affects how fast a Spot Light’s intensity drops off from the center of the cone to the outside edge. Only available for Spot Lights.

A value of 0 produces a cone of light with the same intensity from the center to the outside edge. The default drop off value is 7.5, causes the light intensity to drop off fairly quickly.

Limitations in the OpenGL lighting model can create a jagged circle of light on a large flat surface if the Drop Off Rate value is too low. You can address this by decreasing the Maximum Triangle Size and increasing the Drop off Rate.

**3** Additional **Options** that affect how the selected light source behaves are available.

- Check **On** to use the light source in camera views, or uncheck it if you prefer that the light source not be used. See “Lighting” on page 472.
- **Casts Shadows** controls whether or not the light source casts shadows in camera views. See “Shadows” on page 470.
- Check **Show Position in Camera View** to indicate the position of a selected Point or Spot Light source in the preview pane and in 3D views that support lighting when it is turned On. This tool can be used to determine if your light source is positioned correctly. Not available for Parallel lights. See “Displaying Lights” on page 473.

- 4 A preview of the selected object displays here. The selected light source's Position in Camera View will display in the Standard Rendering Technique if the light source is On. See "Dialog Preview Panes" on page 32.

## Custom Light Intensity Dialog

Select "Custom" from the **Intensity** drop-down list on the LIGHT DATA panel to open the **Custom Light Intensity** dialog.

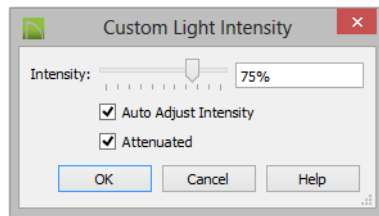

- **Intensity** - Use the slider bar or text field to control how bright the light appears in camera views.
- Check **Auto Adjust Intensity** to have the program to scale the Intensity depending on the number of lights in the room.

When unchecked, the Intensity set here is used.

- Check **Attenuated** to control how quickly a light source's intensity drops as its distance from the light source grows. When unchecked, the light does not drop off. Only Spot and Point Lights have attenuation.

## Materials Panel

The MATERIALS panel is found in the specification dialogs for a variety of objects. For more information, see "Materials Panel" on page 420.

## Label Panel

Labels for electrical fixtures display in floor plan view when the "Electrical, Labels" layer is turned on and use the "Default Label Style" Text Style. See "Electrical Labels" on page 293.

For information about the settings on this panel, see "Label Panel" on page 576.



# Trim Tools

The Trim Tools allow you to place corner boards and quoins at wall intersections that form corners.

You can also assign moldings to a variety of objects, such as rooms and cabinets, in those objects' specification dialogs. See "Specification Dialogs" on page 32.

## Chapter Contents

- Trim and Molding Defaults
- Corner Boards
- Corner Board Specification Dialog
- Quoins
- Quoin Specification Dialog
- Editing Corner Boards and Quoins
- Millwork
- Moldings Panel

## Trim and Molding Defaults



Select **Edit> Default Settings** to open the **Default Settings** dialog where you can access the defaults for a variety of drawing tools, including a number that affect trim and moldings.

- Select “Floor” and click the **Edit** button to specify the default moldings for rooms on the current floor. See “Floor Defaults” on page 160.
- Click the + beside “Door” to access the defaults for Interior and Exterior Doors. See “Door Defaults” on page 179.

- Select “Window” and click the **Edit** button to specify the default casing for windows. See “Window Defaults” on page 198.
- Click the + beside “Cabinet” to access the defaults for the Cabinet Tools, where you can specify default crown and other moldings. See “Cabinet Defaults” on page 310.

## Corner Boards



Corner boards are added to a building exterior in any view by selecting **Build> Trim> Corner Boards**.



Click at a wall corner where you want to add trim. Be sure to click where the outside wall surfaces meet. If you click where the inside surfaces meet, corner trim will be created inside the room.

You can also add Corner Boards to all exterior corners at once by selecting **Build> Trim> Auto Place Corner Boards** .

**Auto Place Corner Boards**  adds Corner Boards to outside corners only.

Note: The Auto Place Corner Boards tool does not place corner boards on manually drawn dormers or at intersections with Attic Walls. See “Attic Walls” on page 141.

Corner boards extend from the top plate down to the bottom of the floor platform of the floor on which it is placed, but do not extend to other floors. You must add corner boards to all floors of the building that you want to have corner boards.

A selected corner board or boards can be moved, but only to another wall corner or corners. In 3D views, corner boards can be lengthened or shortened using the edit handles. Corner boards can be copied, deleted and resized similar to other objects using the edit toolbar or the **Corner Board Specification** dialog.

The default material for corner boards is defined by the **Exterior Trim** entry in the

**Material Defaults** dialog. See “Material Defaults” on page 416.

## Corner Board Specification Dialog

 Select a corner board and click the **Open Object** edit button to open the **Corner Board Specification** dialog.

### General Panel

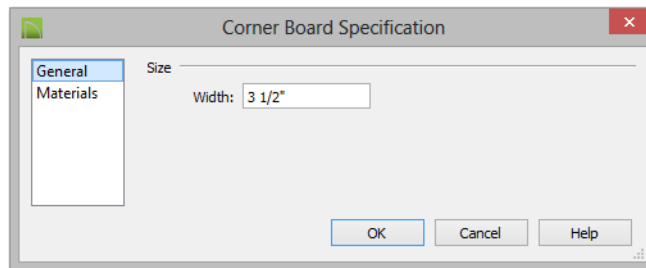

Specify the **Width** of the selected corner board.

### Materials Panel

The settings on the MATERIALS panel are available for a wide variety of objects in the program. For information about these settings, see “Materials Panel” on page 420.

## Quoins

 Select **Build> Trim> Quoins** in any view and click at a wall corner where you want to place quoins.



You can also add Quoins to all exterior corners at once by selecting **Build> Trim>**

**Auto Place Quoins** .

**Auto Place Quoins**  adds Quoins to outside corners only.

Note: The Auto Place Quoins tool does not place quoins on manually drawn dormers or at intersections with Attic Walls. See “Attic Walls” on page 141.

A selected quoin or quoins can be moved, but only to another wall corner or corners. In

3D views, quoins can be lengthened or shortened using the edit handles. Quoins can be copied, deleted and resized similar to other objects using the edit toolbar or the **Quoin Specification** dialog.

The size of quoins in floor plan view is relative on their size in 3D.

Initially, quoins use the same material as the default material of the wall surface they are placed against. This material is specified in the **Wall Type Definitions** dialog. See “Wall Specification Dialog” on page 146.

---

## Quoin Specification Dialog

 Select a quoin and click the **Open Object** edit button to open the **Quoin Specification** dialog.

### General Panel

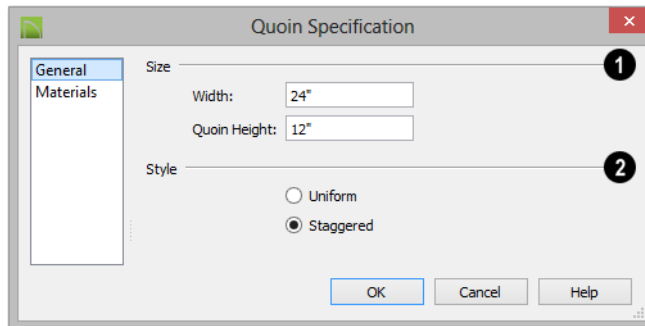

- 1 Specify the **Size** of the quoins in the selected Quoin object.
  - Specify the **Width**, which is the horizontal dimension of each quoin in the selected Quoin object. The dimension along the other wall is half this value when they are staggered or mirrored.
  - Specify the **Quoin Height** for individual quoins in the selected Quoin object.
- 2 Specify the arrangement of quoins used by the selected Quoin object.



- **Uniform** - Produce quoins that are of equal length on both sides of the corner.
- **Staggered** - Produce quoins that have one long side and one short side staggered on opposite sides of the corner.

## Materials Panel

The settings on the MATERIALS panel are available for a wide variety of objects in the program. For information about these settings, see “Materials Panel” on page 420.

---

## Editing Corner Boards and Quoins

Before a corner board or quoin can be edited, it must be selected. Click on a trim object when the **Select Objects**  tool is active. Corner boards and quoins can also be group selected and edited. See “Selecting Objects” on page 88

Corner boards and quoins can be edited using their edit handles, the edit toolbar buttons, and their specification dialogs.

### Using the Mouse

Depending on the type of view, a corner board or quoin displays a different set of edit handles when selected.

- In floor plan view, corner boards and quoins display one edit handle and can be moved from one eligible location at a wall corner to another.

- In 3D views, corner boards and quoins can be moved, lengthened, and shorted much the other line-based objects are. See “Editing Line Based Objects” on page 90.

### Using the Edit Buttons

A selected corner board or quoin can be edited in a variety of ways using the buttons on the edit toolbar. See “The Edit Toolbar” on page 28.

### Deleting Corner Trim

Corner boards and quoins can be selected individually or in groups and deleted using the **Delete**  edit button or the Delete key on the keyboard. They can also be removed using the **Delete Objects** dialog. See “Deleting Objects” on page 116.

---

## Millwork

A selection of various types of millwork including columns, corbels and finials is available in the Library Browser. See “The Library Browser” on page 394.

Most millwork items can be placed in a plan as free-standing objects. Some items - notably, newels and balusters - can be assigned to objects such as railings, stairs and ramps. See “Placing Library Objects” on page 406.

## Moldings Panel

The specification dialogs for a variety of objects in the program include a MOLDINGS panel. Objects that can have moldings assigned to them include rooms, cabinets, and custom countertops.

Select an object and click the **Open Object**  edit button to open the specification dialog for that selection.

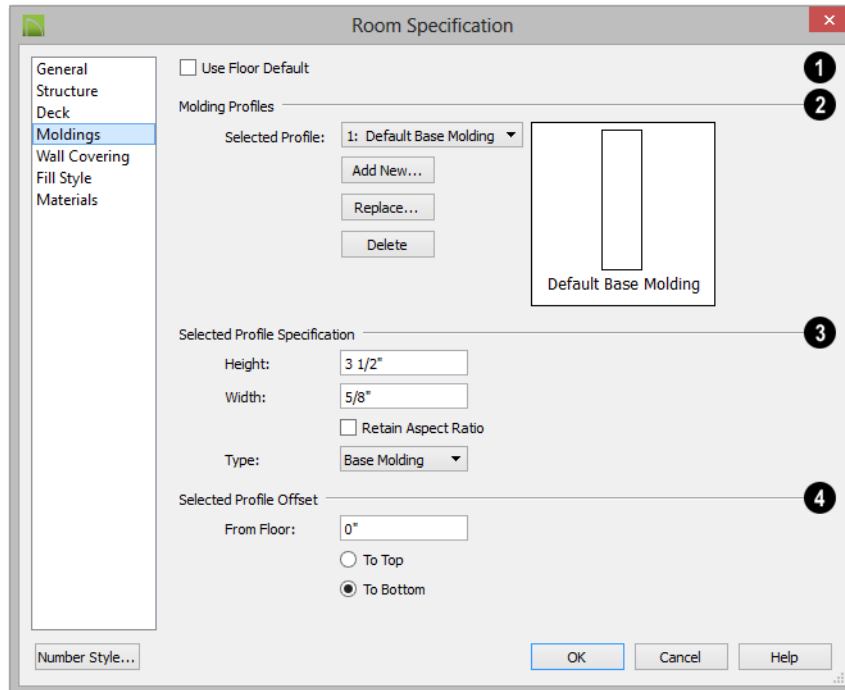

**1** Only available for rooms, uncheck **Use Floor Default** to make the settings that follow active. Check this box to use the defaults set in the **Floor Defaults** dialog for the current floor. See “Floor Defaults” on page 160.

**2** **Molding Profile** - Specify the molding profile(s) assigned to the selected object. The Default Base Molding is a basic

rectangular stock profile rather than a profile from the library.

- A drop-down list of the **Molding** profile(s) assigned to the selected object displays here. Select the name of a molding to edit it or remove it from the list.
- Click the **Add New** button to open the **Select Library Object** dialog and add a new molding profile to the list. See

“Select Library Object Dialog” on page 408.

- Click the **Replace** button to remove the selected profile and replace it with a new one from the **Select Library Object** dialog. Only available when a profile is already selected.
  - Click the **Delete** button to remove the currently selected profile from the list.
  - Choose the currently selected molding’s **Type** from the drop-down list: Base Molding, Chair Rail, or Crown Molding. Only available for rooms.
- ③ Specify **Selected Profile Size**. These settings only affect the molding profile selected above.
- Specify the **Height** of the selected molding profile.
  - Specify the selected profile’s **Width**.
  - When **Retain Aspect Ratio** is checked, if you change either the Height or Width, the other value changes to maintain their

original ratio. When this is unchecked, the two values can be edited independently.

- ④ Define the **Selected Profile Offset**, which is the offset of the selected molding relative to the object it is assigned to.
- Specify the offset **From Floor** of the selected molding profile; for objects other than rooms, specify the **Vertical** offset. A positive offset moves the molding upward and a negative offset moves the molding downward.
  - Select **To Top** to specify that the top of the molding is offset vertically from the top of the object it is applied to.
  - Select **To Bottom** to specify that the bottom of the molding is offset vertically from the bottom of the object it is applied to.



# Cabinets

With Home Designer Architectural's cabinet tools you can create base, wall, and full height cabinets as well as soffits, shelves, partitions, and custom countertops. These objects are very versatile, allowing for a wide range of customization.

A selection of cabinet door and drawer styles are available in the Library Browser.

Home Designer Architectural also has many customized cabinet symbols and cabinet groups available in the library.

## Chapter Contents

- Cabinet Defaults
- The Cabinet Tools
- Cabinet Fillers
- Placing Cabinets
- Custom Countertops
- Custom Backsplashes
- Displaying Cabinets
- Editing Cabinets
- Editing Cabinet Styles
- Special Cabinets
- Cabinet Specification Dialog
- Shelf/Partition Specification Dialog
- Custom Countertop Specification Dialog
- Custom Backsplash Specification Dialog
- Backsplash Layer Definition Dialog

## Cabinet Defaults



Access default settings for each cabinet tool by selecting **Edit> Default Settings**, then clicking the white arrow beside **Cabinets**. Select a subheading and click the **Edit** button to open the defaults dialog associated with your selection.

Each type of cabinet object has default definitions for size, style, materials and more. In fact, the default dialog for each cabinet type is similar to its corresponding specification dialog. For descriptions of these settings, see “Cabinet Specification

Dialog” on page 321, “Shelf/Partition Specification Dialog” on page 328 and “Soffit Specification Dialog” on page 382.

Custom Countertops do not have defaults dialogs. Instead, their initial settings are based on the those of other objects.

- Custom Countertops’ initial settings are based on Base Cabinet Default settings but are also influenced by the settings of cabinets beneath them. See “Custom Countertops” on page 311.

## General Cabinet Defaults

The **General Cabinet Defaults** dialog can be accessed only from the **Default Settings** dialog.

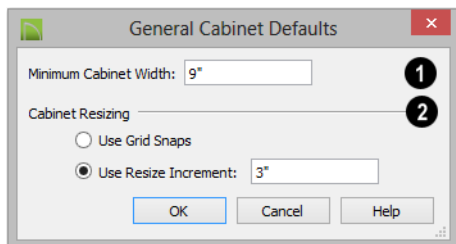

- 1 Specify the **Minimum Cabinet Width**. The minimum allowable width is 1/16 of an inch (10 mm).

- 2 Specify how **Cabinet Resizing** takes place when the edit handles are used.
  - Select **Use Grid Snaps** to resize cabinets using Snap Grid increments. See “Grid Snaps” on page 81.
  - Select **Use Resize Increment** to resize cabinets using the increment specified here.
  - Set the **Resize Increment** at which cabinets resize. The minimum allowable increment is 1/16 of an inch (10 mm).

## The Cabinet Tools



Select **Build> Cabinet** to access the Cabinet Tools.

Cabinets are easily created with a single click in floor plan view or any camera view. See “Click-to-Create” on page 82.

Typically, groups of cabinet objects are positioned closely together and arranged to form work spaces, and there are some special behaviors and techniques to be aware of. See “Placing Cabinets” on page 313.

Once created, cabinets, soffits, shelves, partitions and fillers can be selected and edited much like other box-based objects. See “Editing Cabinets” on page 317.

## Base Cabinets



Select **Build> Cabinet> Base Cabinet** and click in any view. Base cabinets can be placed directly under wall cabinets and generate a countertop and toe kick by default.

## Wall Cabinets



To place a wall cabinet, select **Build> Cabinet> Wall Cabinet** and click in any view. Wall cabinets can be placed directly over base cabinets.

## Full Height Cabinets



To place a full height cabinet, select **Build> Cabinet> Full Height** and click in any view. Full height cabinets generate a toe kick by default and cannot be placed on top of other cabinets.

## Soffits



Soffits typically fill the space between cabinet tops and the ceiling, but can also be used to create any object that can be modeled as a 3D box. To place a soffit, select **Build> Cabinet> Soffit** and click in any view.

By default, soffits use the material assigned to interior walls in the **Material Defaults** dialog. Like cabinets, soffits can have molding profiles applied to them.

For more information about using soffits for a variety of purposes, see “Other Objects” on page 379.

## Shelves



Select **Build> Cabinet> Shelf** and click in any view to create a shelf.

Create corner shelves by placing one shelf on each wall, then moving or stretching them until they touch.

Once created, shelves can be selected and edited. See “Shelf/Partition Specification Dialog” on page 328.

## Partitions



Select **Build> Cabinet> Partition** button and click in any view to create a vertical partition.

Like shelves, partitions can be selected and edited after they are placed.

Partitions can be used with shelves to create complex storage systems.

## Custom Countertops



Custom Countertops are drawn and edited just like other closed-polyline based objects. Select **Build> Cabinet> Custom Countertop**, then either click and drag a rectangle or single-click to place a 2’x2’ countertop. See “Custom Countertops” on page 314.

You can also generate a custom countertop over one or more base cabinets using the **Generate Custom Countertop**  edit tool. See “Using the Edit Tools” on page 317.

## Custom Backsplashes



Select **Build> Cabinet> Custom Backsplash** while an elevation or camera view is active, then either click and drag a rectangle or single-click on a wall surface to place a Custom Backsplash Layered Material Polyline on that wall. See “Custom Backsplashes” on page 315.

## Cabinet Library Catalog



In the Library Browser, browse to Home Designer Core Catalogs> Architectural> Cabinets to access a selection of specialty cabinets. Select the library object you want, then click in any view to place it in the plan. Once placed, library cabinets can be edited. See “The Library” on page 393.

## Cabinet Doors, Drawers, and Panels Catalog



A selection of cabinet door, drawer, and panel styles is available in Home Designer Core Catalogs> Architectural. Select an item, then click on a cabinet in your plan to place the door or drawer onto that cabinet. Doors, drawers, and panels can be assigned to a cabinet in its specification dialog, as well. Cabinet doors, drawers, and panels can also be placed as stand-alone fixtures.

## Built-In Sinks and Appliances

A variety of fixtures and appliances such as sinks, cooktops, and dishwashers can be placed into cabinets. See “Inserted Objects” on page 407.



Place fixtures and appliances into cabinets early, so that any resizing can be done while there is adequate free space.

To insert a fixture into a cabinet, select the fixture in the Library Browser, then click on a cabinet. There must be enough space in the cabinet or adjoining cabinets to contain the selected fixture.

If a sink or cooktop is inserted into a cabinet with a top Drawer or Double Drawer, its Item Type will automatically change to a False Drawer or False Double Drawer.

Once placed, an inserted fixture can be selected and edited:

- To select a fixture in a cabinet top, click on it and then click the **Select Next**  **Object** edit button. See “Select Next Object” on page 89.
- Front fixtures can only be modified or deleted in the **Cabinet Specification** dialog. See “Front Panel” on page 324.



Fixtures can be added to both the top and front of the same cabinet. It is up to you to determine which can be effectively and safely combined in the real world.

## Electrical Switches and Outlets

Electrical switches and outlets placed within the backsplash area of a base cabinet will display in front of the backsplash in 3D views when the “Electrical” layer is turned. See “The Electrical Tools” on page 290.



## Cabinet Fillers

By default, Home Designer Architectural models a continuous countertop and generates fillers automatically when cabinets of the same height are either touching or placed with 3" (75 mm) of one another.

If two cabinets meeting at a corner are separated from each other by 3" (75 mm) or less, the program will automatically generate a filler in the angle between them. A filler is used to separate the front of one of these

cabinets from the one it meets so that drawers and doors have room to operate.

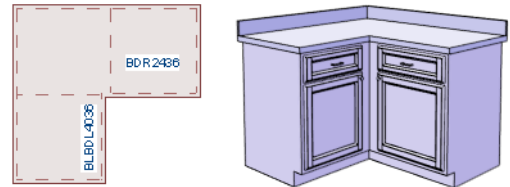

*Two base cabinets and the filler between them*

## Placing Cabinets

Cabinets are easily created with a single click in any view. See “Click-to-Create” on page 82.

When used near a wall corner, the Cabinet Tools will produce corner cabinets and soffits. See “Corner Cabinets” on page 319.

When created, cabinets are positioned relative to the floor of the room in which they are placed. Base and full height cabinets typically rest on the floor while wall cabinets are placed a set distance above the floor. See “Cabinet Defaults” on page 310.

If the ceiling height of the room does not accommodate the height of a cabinet, its **Floor to Bottom** value will be retained and its **Height** will be reduced so that it fits under the ceiling. When this happens, some front items may be removed from the cabinet if there is not enough room for them. See “Front Panel” on page 324.

Because cabinets are typically organized into groups with shared attributes, they have some special behaviors.

### Cabinet Snapping and Aligning

Cabinets have several special snapping and aligning behaviors which help you create precisely aligned cabinets quickly and easily.

- When Base and/or Full Height cabinets are within 3" of one another's sides, they will snap together. Wall cabinets snap in a similar manner, but only with other Wall cabinets.
- When Base and/or Full Height cabinets are within 3" of one another's sides and their front or back surfaces are within 3" of aligning, they will become aligned. Wall cabinets snap in a similar manner with other Wall cabinets as well as Full Height cabinets.
- When a Base and/or Full Height cabinet is placed against the back of another Base or Full Height cabinet, its back surface

will automatically face the other cabinet's back. Wall cabinets snap in a similar manner with other Wall as well as Full Height cabinets.

- When a cabinet is placed against a wall, its back and/or side will snap to the wall and, if the wall is moved, the cabinet will move with it.

When cabinets are snapped to a wall or to other cabinets, only exposed end cabinets have side counter overhangs.

Cabinet snapping and aligning occurs even when when **Object Snaps** are turned off; however, you can override this behavior by moving a cabinet into the desired position using dimensions. See "Moving Objects Using Dimensions" on page 494.

## Cabinet Merging

When cabinets of the same height and type are placed side-by-side within 3" (30 mm) of one another they will automatically merge, making any shared components such as the toe kick, countertop, backsplash, and moldings continuous. Any gap between merged cabinets will be automatically filled.

The exposed ends of merged cabinets have side counter overhangs.

Cabinets placed at different angles will also merge if they face toward one another and meet at a front corner. Cabinets that meet at a back corner will also merge provided that

they face away from one another at an angle no greater than 87°. In either case, a filler is created in the angle between the two.

If the side of a cabinet is placed within 3" (30 mm) of a wall, the countertop will extend to the wall and a filler will be created.

## Base and Wall Cabinets

Base and wall cabinets have different default heights, so they can be placed directly above or below one another without interference.

You can use **Object Snaps** to center a wall cabinet's back center point above that of a base cabinet, or vice versa. See "Click-to-Create" on page 82.

## Minimum Cabinet Size

If you try to place a cabinet into a space that is too narrow for its default size, the program will place a smaller cabinet with a width that is a multiple of the default **Resize Increment**. For example, if you try to place a 24" wide cabinet in a 20" wide space and your Resize Increment is 3", the program places an 18" cabinet. See "General Cabinet Defaults" on page 310.

If you try to place a cabinet into a space narrower than the default **Minimum Cabinet Width**, a cabinet will not be placed. If, for example, you have a space that is 8" and your Minimum Cabinet Width is 9", no cabinet is placed.

---

## Custom Countertops





Countertops are automatically generated on top of base cabinets. These default countertops are basically

components of the cabinets. They can be edited in the **Cabinet Specification** dialog but cannot be selected and modified

separately. You can instead use **Custom Countertops**, which are drawn and edited just like other closed-polyline based objects can be selected and edited independent of the cabinets beneath. See “Draw Polyline” on page 512.

Select **Build> Cabinet> Custom**

**Countertop** , then either click and drag a rectangle or single-click to place a 2’x2’ countertop. Custom Countertops can be drawn in any view except elevation views.

You can also generate a custom countertop over one or more selected base cabinets by clicking the **Generate Custom Countertop**  edit button. See “Using the Edit Tools” on page 317.

When a Custom Countertop covers any portion of a base cabinet, it overrides the default countertop.

If a sink or built-in appliance is added to the cabinet, a hole for the fixture is automatically cut in the custom countertop.

A custom countertop bases its thickness and height on the base cabinet(s) below.

- If there are multiple cabinets below, it uses the specifications for the cabinet with the greatest overall height.
- If there is no base cabinet below, its height and thickness are based on the

base cabinet defaults. See “Cabinet Defaults” on page 310.

## Editing Custom Countertops

Once created, a custom countertop can be selected in 2D and 3D views and edited like other closed-polyline based objects. See “Editing Closed-Polyline Based Objects” on page 98.



Customcountertops initially use the default countertop material set in the Base Cabinet Defaults dialog. You can specify a different material as well as the height and position in the **Custom Countertop Specification** dialog. See “Custom Countertop Specification Dialog” on page 329.

You can also specify the edge profile of a custom countertop in the **Custom Countertop Specification** dialog. See “Moldings Panel” on page 328.

---

## Custom Backsplashes



The **Custom Backsplash** tool allows you to create areas on a wall that use a different surface material than the parent wall. To create a Custom Backsplash, select **Build> Cabinet> Custom Backsplash**.

Custom Backsplashes are closed polyline-based objects that are drawn on the vertical surface of a wall. They can only be drawn, and their shapes edited, in camera and elevation views. See “Polylines” on page 518

and “Editing Closed-Polyline Based Objects” on page 98.

Custom Backsplashes are composed of a layer of backsplash material. The layer material and its thickness can be set in the **Custom Backsplash Specification** dialog. See “Custom Backsplash Specification Dialog” on page 330.

By default, Custom Backsplashes use the backsplash material and thickness specified in the **Base Cabinet Defaults** dialog. See “Cabinet Defaults” on page 310.

If any cabinets and/or appliances are present, a Custom Backsplash will:

- Seek to fill the area between any base cabinets or floor appliances against that

wall surface and any wall cabinets and/or windows above them.

- If nothing is above any base cabinets, it will fill the area between the cabinets and the ceiling; if nothing is below any wall cabinets, it will fill the area between the cabinets and the floor.
- Replace the backsplash associated with any base or wall cabinets.

By default, a Custom Backsplash will cut into the wall layers between it and its parent wall’s Main Layer and replace those layers with its own within its perimeter; it can, however, can be affixed to the wall’s surface instead if you prefer.

---

## Displaying Cabinets



The display of the various cabinet object types, labels, module lines, door opening indicators and more is controlled in the **Display Options** dialog. See “Displaying Objects” on page 76.

Cabinets are drawn so that wall cabinets, soffits and shelves are always in front of base and full height cabinets, countertops and partitions.

Objects assigned to cabinets, including doors, drawers, moldings, and hardware are located on the same layer as their parent object. They display in 3D views, but not in floor plan view.

Cabinet labels display in floor plan view when the “Cabinets, Labels” layer is turned on and use the “Default Label Style” Text Style. See “Object Labels” on page 575.

Countertops display if the “Cabinets, Countertops” layer is turned on.

By default, cabinet module lines display in floor plan view when cabinet objects of the same type are placed side by side. If you prefer that these lines not display, turn off the “Cabinets, Module Lines” layer. You can also specify whether module lines are full or partial.

You can also display cabinet front indicator arrows in floor plan view by turning on the “Cabinets, Front Indicators” layer.

## Editing Cabinets

Cabinets can be selected in 2D and 3D views and edited using the edit handles, the edit toolbar and their specification dialog.

### Using the Mouse

Cabinets can be edited like other box-based objects. See “Editing Box-Based Objects” on page 101. The edit handles that a cabinet displays when selected will vary depending on the view.

When a cabinet is selected in floor plan view or on its top surface in a 3D view, ten edit handles display: the Move handle at the center, the Rotate handle, and a Resize handle on each edge and at each corner.

In 3D views, cabinets can be selected on any surface: front, side, back or top. When the side of a cabinet is selected, five edit handles are available: the Move handle and a Resize handle on each edge.



### In the Specification Dialog



A selected cabinet can be customized in a variety of ways in its specification dialog. See “Cabinet Specification Dialog” on page 321.

### Using the Edit Tools

A cabinet or cabinets can be edited in a variety of ways using the buttons on the edit toolbar. See “The Edit Toolbar” on page 28.

### Add to Library

Cabinets can be saved in the Library Browser. Select a base, wall or full height cabinet or cabinet filler and click the **Add to Library** edit button. See “Add to Library” on page 402.

### Using Dimensions



Like various other objects, cabinets can be moved and resized using dimensions. See “Moving Objects Using Dimensions” on page 494.

Dimensions locate the sides and/or corners of cabinet boxes - not the countertop or the center. If you wish, you can move a dimension’s extension lines to locate these items in floor plan view after the dimension line is drawn. In elevation views, the heights of the toe kick, backsplash, and/or moldings can also be located in this manner. See “Editing Extension Lines” on page 493.

Temporary Dimensions will locate the wall surface nearest the selected object edge or either cabinet boxes or Custom Countertops, depending on which type of object is selected:

- If a cabinet box is selected, Temporary Dimensions will locate the nearest wall surface or another cabinet box, but not Custom or automatically generated Countertops.

- If a Custom Countertop is selected, Temporary Dimensions will locate the nearest wall surface or another Custom Countertop, but not cabinet boxes or automatically generated counters.

## Moving Walls with Cabinets Attached

When a cabinet is placed or moved against a wall, it will snap to the wall and become

attached to it. When a wall is moved, all attached cabinets move with it.

Moving a wall to an unattached cabinet will not attach the cabinet to it: the cabinet must be moved to the wall. A cabinet can also be attached to a wall when **Plan Check**  is used. See “Plan Check” on page 526.

---

## Editing Cabinet Styles

A variety of settings allow you customize the appearance of your cabinets to create styles ranging from traditional to contemporary.

If the desired style is known before cabinets are placed, you can save time by specifying that style in the **Cabinet Defaults** dialogs before you start drawing. See “Cabinet Defaults” on page 310.

### Cabinet Face Items

A variety of different face items can be added to the front of any cabinet, including doors, drawers, cutting boards, and horizontal separations. Face items can be moved, resized, as well as removed and can also be split vertically or horizontally to produce a variety of custom configurations. See “Front Panel” on page 324.

When adding, removing, or resizing face items, it is helpful to keep a few rules in mind:

- When the overall height of a cabinet or the height of a face item is changed, the height of the lowest face item that is not a

Separation is adjusted to accommodate the change.

- If you increase the height of the lowest face item, the non-Separation item directly above is adjusted; if you decrease its height, a Blank Area and Separation are created below it.

Note: To ensure that Face Item heights always equal the total cabinet front height, the program automatically adjusts the bottom Face Item as changes are made elsewhere. This means you should start editing Face Items at the top and work down.

### Doors, Drawers and Panels

Cabinet doors, drawers, and panels can be applied in either of two ways:

- In the **Cabinet Specification** dialog. See “Door/Drawer Panel” on page 326.
- Directly from the Library Browser.

Select a style in the library, then click on a cabinet to apply the selected style to that cabinet. In 3D views, click on a face item to

apply the selected library object to that item. See “Placing Library Objects” on page 406.

## Cabinet Hardware and Moldings

Cabinet handles, pulls, and hinges can be assigned in the **Cabinet Specification** dialog. See “Door/Drawer Panel” on page 326.

In 3D views, pulls and handles can also be applied directly from the Library Browser. Select a hardware item, then click on the cabinet face item to apply it to that face item. See “Inserted Objects” on page 407.

Multiple molding profiles can also be applied around the perimeter of a cabinet at any height. For example, you may want a wood edge around base cabinet countertops and a crown molding that ties together the tops of the wall cabinets and full height cabinets. See “Moldings Panel” on page 306.



*Wall cabinet with crown molding and light rail*

## Countertops and Backsplashes

The countertop thickness, overhang, and material for a selected base cabinet can be specified in the **Cabinet Specification** dialog. See “General Panel” on page 322.

Backsplashes can be applied to base cabinets as well as down from wall cabinets on the GENERAL panel of their specification dialogs.

Custom Countertops and Backsplashes can also be created independent of base or wall cabinets. See “The Cabinet Tools” on page 310.

---

## Special Cabinets

There are a number of special cabinet shapes that can be specified. Certain requirements must be met before some special cabinet shapes can be specified. If the requirements are not met, a warning message will explain what is needed. See “Cabinet Specification Dialog” on page 321.

### Standard Cabinets



Select **Build> Cabinet> Base Cabinet**  and click in floor plan view to place a standard, rectangular base cabinet.



*Standard (default) cabinet*

### Corner Cabinets

To create a corner cabinet, click as close to an inside wall corner as possible in using

either the **Base Cabinet** , **Wall Cabinet** , or **Full Height**  cabinet tool. A corner cabinet remains a corner cabinet when it is moved, edited or copied.

You can turn an existing cabinet into a corner cabinet by selecting “Corner” from the **Special** drop-down list in its specification dialog. See “General Panel” on page 322.

- Before a corner cabinet can be specified in the **Cabinet Specification** dialog, the cabinet’s Width must be greater than its Depth.
- The **Left** and the **Right Side Widths** can be set independently for corner cabinets.



*Corner cabinet with sides of equal width*

- You can specify a Diagonal Door on corner cabinets to create an angled corner cabinet. See “Front Panel” on page 324.



*Corner cabinet with diagonal door*

## End Cabinets

Open a cabinet for specification and select Left or Right End Cabinet from the **Special** drop-down list to create an end cabinet.



*Left End Cabinet*

- End Cabinets have an angled front and side.
- The cabinet width must be no greater than its depth for an end cabinet to be specified.

## Radius End Cabinets

Open a cabinet for specification and select Right or Left Radius End from the **Special** drop-down list to create a radius end cabinet.



*Radius End cabinets have a 90° arch*

As you face the cabinet, a right radius end curves to the right, and a left radius end curves to the left.

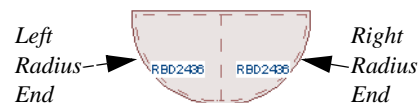

## Peninsula Radius Cabinets

Open a cabinet for specification and select Peninsula Radius from the **Special** drop-down list to create peninsula radius cabinet.





*Peninsula Radius Cabinet*

## Angled Front Cabinets

Open a cabinet for specification and select **Angled Front** from the **Special** drop-down list to create an angled front cabinet.



*Angled Front Cabinet*

- The length of the left and right side of an **Angled Front** cabinet can be defined by changing the Depth/Bow Depth value. See “General Panel” on page 322.

## Kitchen Islands

To create a kitchen island, simply place several cabinets back-to-back and/or side-to-side. Match the widths so that each cabinet back or side meets the back or side of only

one other cabinet. If this is not done, the lines separating the cabinets cannot be suppressed.

A given side of a single cabinet cannot merge with the edges of two different cabinets. The example below shows two instances of cabinets placed back-to-back. Cabinet fronts and joining surfaces are shown.

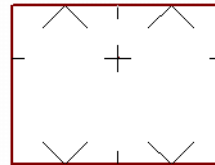

*Correct -  
Widths of front and  
back cabinets match*

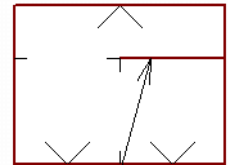

*Incorrect -  
Solid line here is not  
suppressed.*

## Blind Cabinets

Often, when two cabinets meet in a corner, one is partially hidden by the other. This partially hidden cabinet is called a “blind” cabinet. Home Designer Architectural will resize and offset the front items of the partially hidden cabinet so that they are not located in the hidden portion of the cabinet face.

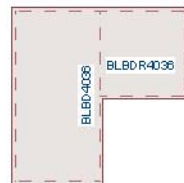

## Cabinet Specification Dialog



Select a cabinet and click the **Open Object** edit button to open the **Cabinet Specification** dialog.

The options in the **Cabinet Specification** dialogs are similar to the corresponding

**Cabinet Defaults** dialog. See “Cabinet Defaults” on page 310.

## General Panel

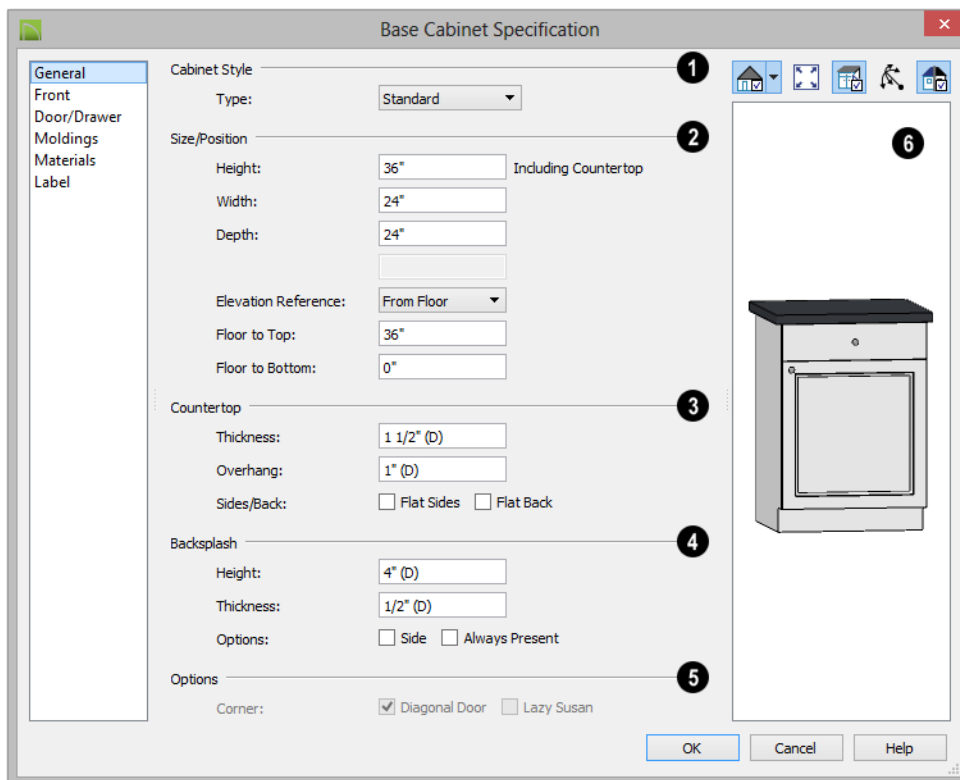

**1** A number of **Cabinet Types** are available in the drop-down list. Certain requirements must be met before some types can be specified. See “Special Cabinets” on page 319.

**2** **Size/Position** - The selected cabinet’s dimensions and position relative to the floor can be specified here. Fractional values are supported to 1/16th of an inch (1 mm).

- Specify the **Height (Including Counter)** of the cabinet box, as measured from bot-

tom to top. For base cabinets, this value includes the countertop thickness, but not the height of the backsplash.

**Note:** Height refers to the height of the entire cabinet, including countertop and toe kick. If you change the Countertop Thickness or Toe Kick Height, the cabinet’s total height is not altered. Instead, the cabinet face height and the heights of face items change in response.

- Specify the **Width** of the cabinet box, as measured across the front of the cabinet box from left to right. This does not include the countertop overhang.
  - Specify the **Depth** of the cabinet box, as measured from front to back. It does not include the thickness of overlay doors or the countertop overhang.
  - For Corner cabinets, the **Width** and **Depth** fields are instead named **Right Side Width** and **Left Side Width**.
  - For Corner cabinets, specify the **Bow Depth**. A positive number creates a bow and a negative number, an inside bow. Not available for Corner cabinets if **Diagonal** is unchecked on the Front panel. See “Front Panel” on page 324.
  - For Angled Front cabinets, specify the **Left Depth** and **Right Depth** rather than the **Depth** and **Bow Depth**.
  - Select the **Elevation Reference** from the drop-down list. This determines where the next two settings are measured from and also affects their setting labels.
  - Specify the **to Top** distance, measured from the Elevation Reference to the top of the cabinet’s countertop.
  - Specify the **to Bottom** distance, measured from the Elevation Reference to the bottom of the cabinet, including the toe kick.
- 3** Specify the dimensions and style of the **Countertop** here. Only available for base cabinets.
- Specify the countertop **Thickness**. Changing this value does not alter the cabinet height, but it does affect the height of face items. See “Front Panel” on page 324.
  - Specify the countertop **Overhang**. The Overhang is used for any side of a cabinet not against a wall or another cabinet.
  - Check **Flat Sides** to eliminate the counter overhang on the cabinet’s exposed ends.
  - Check **Flat Back** to eliminate the overhang on cabinets with an exposed back.
- 4** The dimensions and style of the **Backsplash** are specified here. Only available for base cabinets.
- Specify the backsplash **Height** and **Thickness**.
  - Check **Side** to add the backsplash to the side of the cabinet if it is against a wall or a taller cabinet. Not available for Corner cabinets.
  - Check **Always Present** to display the backsplash at all times. If unchecked, a backsplash is present only when the cabinet is against a wall.
  - Check **Backsplash to Base Below** to extend a backsplash from the selected wall cabinet down to the backsplash or countertop of the base cabinet below. Only available for wall cabinets.
- Note that while a base cabinet’s backsplash is measured from the countertop up, a wall cabinet’s backsplash extends downward.
- 5 Options -**
- Uncheck **Diagonal Door** to create double doors at right angles instead of a single diagonal door. This option is checked by default in the **Cabinet Defaults** dialog and is only available for Corner Cabinets. See “Corner Cabinets” on page 319.
  - Check **Lazy Susan** to indicate a lazy Susan in the cabinet’s label and its

appearance in floor plan view. This option does not display in 3D views.

**6** A preview of the selected cabinet displays on the right side of the panel. See “Dialog Preview Panes” on page 32.

## FRONT Panel

If you click on a cabinet face item in the preview on the right side of the dialog, the Front panel will become active and that face item will be selected.

If the selected cabinet was originally created in Chief Architect, some settings on this panel may display for reference only.

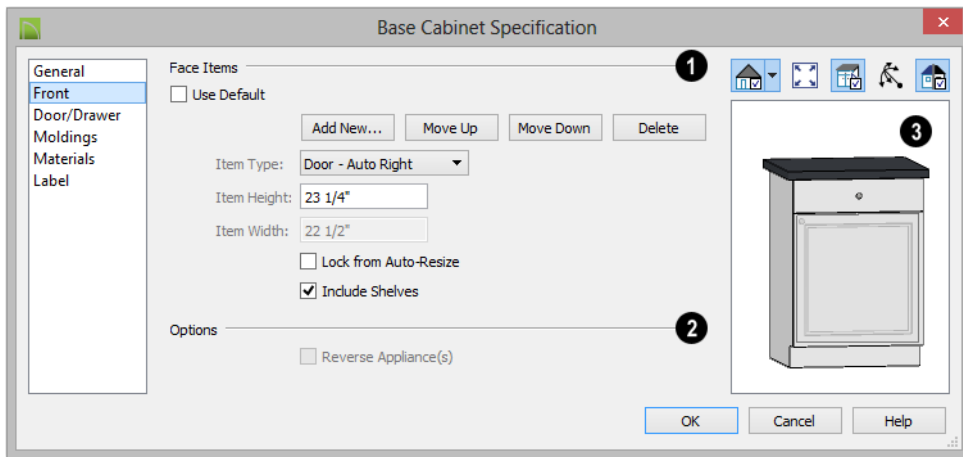

**1** Most of the **Face Items** settings are only active when a door, drawer, or other face item is selected.

- Check **Include Shelves** to include shelves in the selected “Door” or “Opening” face item.

To select a face item, click on it in the preview on the right. When a face item is selected, **Use Default** will be unchecked; it is highlighted in the list as well as in the preview; its attributes can be edited; and the list can be navigated using the arrow and number keys. The vertical frame pieces on the sides of the cabinet front are referred to as stiles and cannot be selected in the

preview. See “Cabinet Face Items” on page 318.

- A numbered tree list of face items displays here. Item numbers start at the top of the cabinet and go down the face to the bottom of the cabinet. Item 1 is usually the top face frame Separation, or rail. The selected face item is highlighted; if no item is selected, the “Vertical Layout Parent” heading will be highlighted.
- Click **Add New** to add a new face item directly below the currently selected item. When a face item is added, the height of the lowest item on the cabinet front is reduced to make room for the new item. If you click **Add New** with no

face item selected, the new item is added to the bottom of the cabinet face.

- In the **New Cabinet Face Item** dialog, define the **Item Type**, **Item Height**, and click OK. If the Item Type is “Separation”, you can check **Default** to use the default Separation Height.

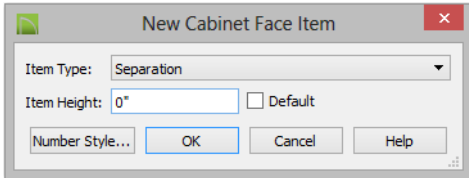

- Click **Delete** to remove the selected face item. When an Auto Left, Auto Right, Left, Right, or Double Door is deleted, it is replaced by an Opening; when other face item types are deleted, the height of the lowest item is increased to make up the difference. You can also press the Delete key on the keyboard.

 The program tries to maintain a single separation between all face items. When you add or delete a face item, separations are usually added or deleted with them.

- Click **Move Up** to move the currently selected item up one position, switching places with the item directly above.
- Click **Move Down** to move the currently selected item down one position, switching places with the item directly below.
- Choose the selected face item’s **Item Type** from the drop-down list:
- Specify the selected face item’s **Item Height**. Fractional values are supported to 1/16th of an inch (1 mm). For doors and drawers, this is the height of the

opening rather than the item front height. For best results, edit face item heights starting at the top of the cabinet and work down. See “Cabinet Face Items” on page 318.

Note: If the Height of an Appliance has been changed, entering a “d” restores its default height. See “Built-In Sinks and Appliances” on page 312.

- Check **Lock from Auto Resize** to prevent the selected face item from resizing when the cabinet is resized.
- The selected item’s **Item Width** displays here for reference only. For doors and drawers, this is the width of the opening rather than the item front width.
- Check **Include Shelves** to include shelves in the selected “Door” or “Opening” face item.

**2** Select **Reverse Appliance** to reverse any appliances inserted into the selected cabinet from left to right: for example, to change a left hand door on a built-in refrigerator to a right hand door. This option is only available for cabinets with an inserted appliance.

**3** A preview of the selected cabinet displays on the right side of the panel. See “Dialog Preview Panes” on page 32.

- Click the **Select Cabinet Face Item**  button, then click on an item on the front of the cabinet in the preview to select that item. The selected face item is highlighted in grey.
- The cabinet **Label** displays below the preview pane.

## DOOR/DRAWER Panel

The settings on the DOOR/DRAWER panel allow you to control the appearance of the

selected cabinet’s doors, drawers and hardware.

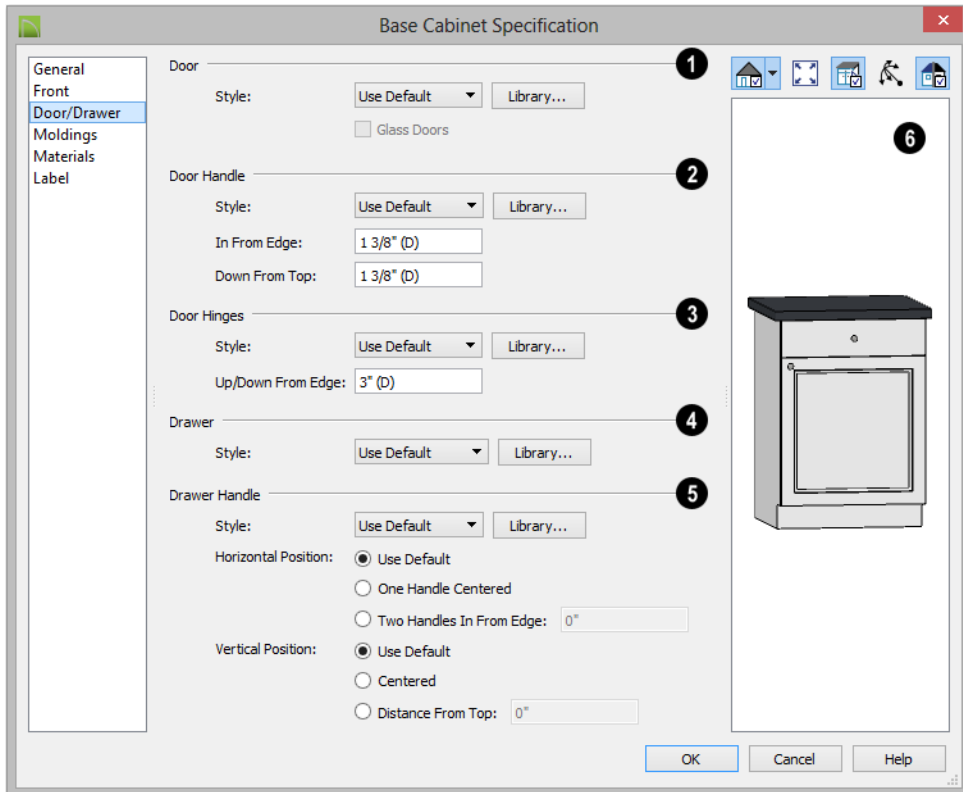

- 1 Specify the appearance of the **Doors** applied to selected cabinet.

Select a door **Style** from the drop-down list. See “Doors, Drawers and Panels” on page 318.

- Select “Use Default” to apply the door style specified in the defaults dialog for the selected cabinet’s type. See “Cabinet Defaults” on page 310.

- Select “Slab Doors” to apply a flat door front or “Framed Doors” to apply a door with a frame and flat panel front.
- Select “Library” or click the **Library** button to select a cabinet door from the library. If a library door has been previously selected, its name will display in the list. See “Select Library Object Dialog” on page 408.
- Check **Glass Doors** to use a glass material for the panel of Framed doors or for

the entire door for Slab doors. Not available when “Library” is the selected door Style.

- 2 Specify the characteristics of the selected cabinet’s **Door Handles**.
  - Select a door handle **Style** from the drop-down list or choose one from the **Library**.
  - Specify the position of the handle **In From Edge**, as measured from the edge of the door opposite the hinges.
  - Specify the height of the handle **Down From Top**, as measured from the top edge of the door. For wall cabinets, this value is measured **Up From Bottom**.
- 3 Specify the characteristics of the cabinet **Door Hinges**.
  - Select a door hinge **Style** from the drop-down list or choose one from the **Library**.
  - Specify the location of the hinges **Up/Down From Edge**, as measured from the door edge. If the cabinet door is more than 35 1/4” (880 mm) high, three hinges will be created instead of two.
- 4 Select a **Drawer Style** from the drop-down list or choose one from the **Library**. For best results, “Framed” drawers should be at least 6” (150 mm) high.
- 5 Specify the characteristics of the selected cabinet’s **Drawer Handles**.
  - Select a drawer **Handle Style** from the drop-down list or choose one from the **Library**.
  - Specify the **Horizontal Position** of the drawer handle(s): Choose **Use Default** to use the default position; **One Handle**

**Centered** for a single handle centered on the drawer face; or **Two Handles In From Edge** for two handles set in from the drawer sides by the value specified in the text field.

- Specify the **Vertical Position** of the drawer handle(s): Choose **Use Default** to use the default position, **Centered** for handle(s) centered on the drawer face, or specify the handle’s **Distance From Top**.
- 6 A preview of the selected cabinet displays on the right side of the panel. See “Dialog Preview Panes” on page 32.
  - The cabinet **Label** displays below the preview pane.

### Moldings Panel

The settings on the MOLDINGS panel allow you to assign one or more horizontal moldings around the selected cabinet. See “Editing Cabinet Styles” on page 318.

For information about the settings on this panel, see “Moldings Panel” on page 306.

### Materials Panel

The settings on the MATERIALS panel affect the appearance of the selected cabinet in 3D views. For information about these settings, see “Materials Panel” on page 420.

### Label Panel

Cabinet labels display in floor planview when the “Cabinets, Labels” layer is turned on and use the Text Style assigned to that layer.

For more information about the settings on this panel, see “Label Panel” on page 576.

## Shelf/Partition Specification Dialog



Select a shelf or partition and click the **Open Object** edit button to open the **Shelf Specification** or **Partition Specification** dialog.

The options in these specification dialogs are similar to the corresponding defaults dialogs. See “Cabinet Defaults” on page 310.

### General Panel

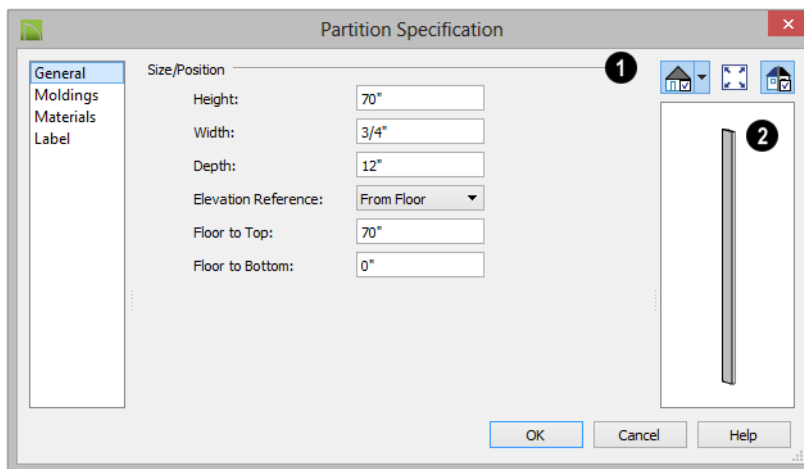

**1** **Size/Position** - Specify the **Height**, **Width**, and **Depth** of the shelf or partition.

- Select the **Elevation Reference** from the drop-down list. This determines where the next two settings are measured from and also affects their setting labels.
- Specify the **to Top** distance, measured from the Elevation Reference to the top of the shelf or partition.
- Specify the **to Bottom** distance, measured from the Elevation Reference to the bottom of the shelf or partition.

**2** A preview of the selected object displays on the right side of the panel. See “Dialog Preview Panes” on page 32.

### Moldings Panel

The settings on the **MOLDINGS** panel allow you to apply molding to the selected object. For information about these settings, see “Moldings Panel” on page 327.

### Materials Panel

The settings on the **MATERIALS** panel affect the appearance of the selected object in 3D views. For information about these settings, see “Materials Panel” on page 420.



### Label Panel

Shelf and Partition labels display in floor planview when the “Cabinets, Labels” layer is turned on and use the Text Style assigned to that layer. The Automatic Labels for

Shelves and Partitions re blank, but you can specify custom labels

For more information about the settings on this panel, see “Label Panel” on page 576.

## Custom Countertop Specification Dialog



Select a custom countertop and click the **Open Object** edit button to open

the **Custom Countertop Specification** dialog.

### General Panel

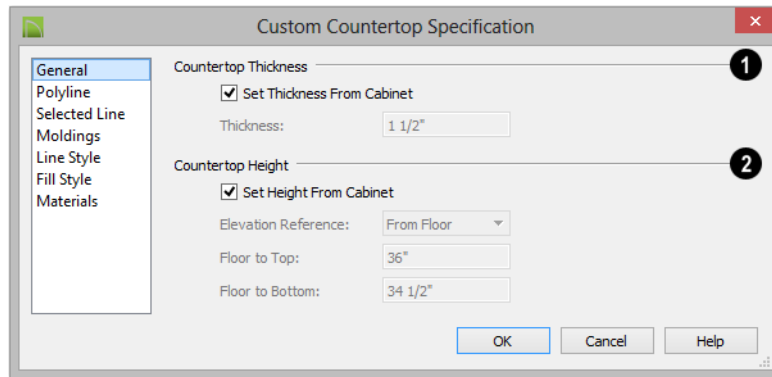

#### 1 Countertop Thickness -

- Uncheck **Set Thickness From Cabinet**, then specify the Thickness of the selected Custom Countertop below. When this is checked, the thickness is inherited from the cabinet below or from the **Base Cabinet Defaults** dialog if no cabinet is present below.

#### 2 Countertop Height -

- Uncheck **Set Height from Cabinet**, then specify the height of the selected Custom Countertop using the settings below.

When this is checked, Countertop height is determined by the cabinet below or by the default base cabinet counter thickness if no cabinet is present below.

- Select the **Elevation Reference** from the drop-down list. This determines where the next two settings are measured from and also affects their setting labels.
- Specify the height **to Top**, which is measured from the selected Elevation Reference to the top of the countertop.
- Specify the height **to Bottom**, which is measured from the selected Elevation

Reference to the bottom of the countertop.

See, too, “Selected Edge” on page 88 and “Change Line/Arc” on page 114.

### Polyline Panel

The POLYLINE panel states the length of the countertop’s **Perimeter**, its **Area**, and its **Volume**. See “Polyline Panel” on page 518.

### Selected Line/Arc Panel

The SELECTED LINE panel is available when the selected edge is a line as opposed to an arc. For more information, see “Line Panel” on page 513.

The SELECTED ARC panel is available when the selected edge has been converted to an arc. For more information, see “Arc Panel” on page 516.

### Line Style Panel

For information about the settings on this panel, see “Line Style Panel” on page 514.

### Fill Style Panel

The settings on the FILL STYLE panel affect the appearance of the selected countertop in floor plan view. For information about these settings, see “Fill Style Panel” on page 519.

### Materials Panel

The settings on the MATERIALS panel affect the appearance of the selected countertop in 3D views. For information about these settings, see “Materials Panel” on page 420.

---

## Custom Backsplash Specification Dialog



Select a Custom Backsplash and click the **Open Object** edit button to open

the **Custom Backsplash Specification** dialog.

### Structure Panel

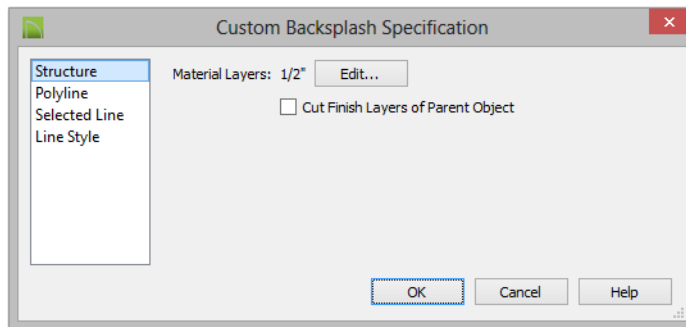

- Click the **Edit** button to open the **Backsplash Layers Definition** dialog.

See “Backsplash Layer Definition Dialog” on page 331.

- Uncheck **Cut Finish Layers of Parent Object** to fix the selected Custom Backsplash to the surface of its parent wall. When checked, it cuts into the finish layers of the wall and replaces those layers with its own within its perimeter.

### Polyline Panel

The POLYLINE panel states the length of the backsplash's **Perimeter**, its enclosed **Area**, and its **Volume**. See "Polyline Panel" on page 518.

### Selected Line/Arc Panel

The SELECTED LINE panel is available when the selected edge is a line as opposed to an arc. See "Line Panel" on page 513.

The SELECTED ARC panel is available when the selected edge has been converted into an arc. See "Arc Panel" on page 516.

See, too, "Selected Edge" on page 88 and "Change Line/Arc" on page 114.

### Line Style Panel

For information about the settings on this panel, see "Line Style Panel" on page 514.

---

## Backsplash Layer Definition Dialog

To open the **Backsplash Layer Definition** dialog, click the **Edit** button in the **Custom Backsplash Specification** dialog.

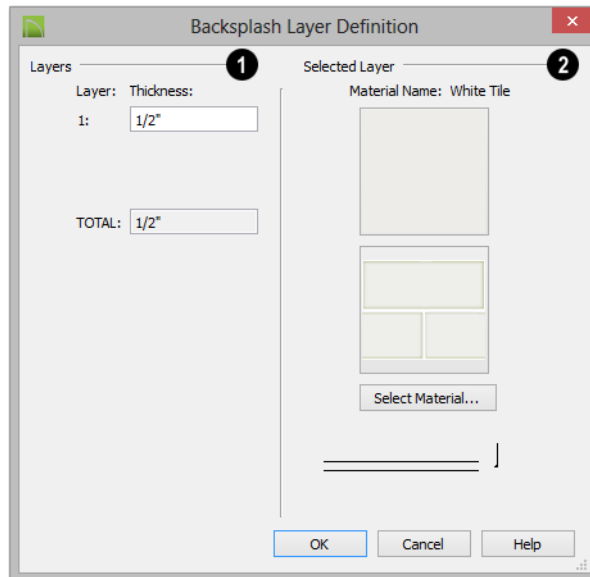

- 1 Specify the **Thickness** of the selected Custom Backsplash.
  - 2 Specify the characteristics of the Custom Backsplash's layer.
- Previews of the backsplash material displays above the **Select Material** button. Click on either preview or the button to open the **Select Library Object** dialog and select a material from the library. See "Select Library Object Dialog" on page 408.
  - A diagram of the backsplash displays below the Select Material button, indicating its appearance in floor plan view.

# Terrain

Home Designer Architectural allows you to model the terrain around a house. Begin by specifying elevation data that creates the surface contours, and then add surface features such as planting areas and water features.

You can import terrain data from a variety of sources and use this data to produce your 3D model.

Driveways, parking lots and sidewalks as well as plants and sprinklers are among the objects that can be placed in your terrain and are discussed in “Plants and Sprinklers” on

page 365 and “Roads, Driveways and Sidewalks” on page 361.

## Chapter Contents

- Terrain Perimeter
- Elevation Data Tools
- Terrain Modifier Tools
- Terrain Feature Tools
- Garden Bed Tools
- Water Feature Tools
- Stepping Stone Tools
- Terrain Wall and Curb Tools

---

## Terrain Perimeter



The Terrain Perimeter is a closed polyline defining the boundary of the terrain that generates in 3D views and of the contour lines that generate in floor plan view. Select **Terrain > Create Terrain Perimeter** to create a terrain perimeter.

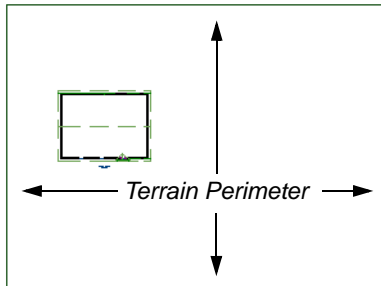

If you create a terrain perimeter in floor plan view but do not see it, select **Window > Fill**

**Window** . See “Zoom Tools” on page 442.

Once created, the terrain perimeter can be resized and edited like other polyline-based objects. See “Editing Closed-Polyline Based Objects” on page 98.

When a terrain perimeter is first created, it is completely flat and is placed at a height of 0’-0”, or sea level.



*Terrain perimeter at 0’ - 0” in a 3D view*

The terrain perimeter by itself does not have elevation data associated with it. You can use

the **Elevation Data**  and **Terrain**

**Modifier**  tools to create terrain that slopes in a wide variety of ways. If you do not create elevation data within the terrain perimeter, the terrain remains flat at an elevation of 0’ - 0”. See “Elevation Data

Tools” on page 335 and “Terrain Modifier Tools” on page 338.

## Terrain Height vs Floor Height

Home Designer Architectural always defines the default height of Floor 1 at 0’-0”. This height value is the constant by which the heights of structural elements in the program like walls, floors, and ceilings are measured. The heights of architectural object can be measured relative this absolute height, as well. See “Floor 1 Default Height” on page 160.

The default height of Floor 1 is not, however, the absolute by which terrain elevation is measured. Instead, elevation data is measured relative to sea level. This means that if you want to, you can use real-world elevation data to generate a 3D terrain model without also having to measure floor and ceiling heights from sea level. See “Importing Elevation Data” on page 355.

The program automatically positions Floor 1 a set distance above the terrain. To do this, it first finds the center point of the building footprint. Then, it determines the elevation of the terrain at that point. Finally, it adds 6” (150 mm) plus the thickness of the floor platform to this value. The resulting value, referred to as the Subfloor Height Above Terrain, is how far the default height of Floor 1 is above sea level in the current plan. See “Foundations and the Terrain” on page 233.

In a plan with a foundation present, the Subfloor Height Above Terrain distance will equal the exact terrain elevation at the building footprint center point, plus 6” (150 mm), plus the thickness of the floor platform.

- In a plan with no elevation data, the terrain is assumed to be at sea level and this Subfloor Height Above Terrain distance is 6" (150 mm) plus the thickness of the floor platform when a foundation is present.
- In a plan with flat terrain at 100' (30 m) and a foundation present, the Subfloor Height Above Terrain distance is 100' 6" (30.468 m) plus the thickness of the floor platform.

Once terrain has been built, the Subfloor Height Above Terrain distance is stated in the **Terrain Specification** dialog. You can specify a custom value to produce a daylight or walkout basement. See "General Panel" on page 346.

Note: When no foundation has been built, the distance from Floor 1 to the terrain is 12" (320 mm).

## Build Terrain



Select **Terrain > Build Terrain** to generate the terrain surface based on the provided elevation data. Build Terrain also updates the Building Pad Elevation value in the **Terrain Specification** dialog. See "Building the Terrain" on page 344.

The Terrain Perimeter has a variety of editable properties that affect the appearance of the terrain in 2D and 3D views. See "Terrain Specification Dialog" on page 345.

## Elevation Data Tools



Select **Terrain > Elevation Data** to add elevation information to your terrain.

When terrain is generated, this data is used to calculate the surface of your site and is represented by contour lines in floor plan view and a curved surface in 3D. See "Displaying Terrain" on page 343.

Elevation data can be specified using the

**Elevation Point** , **Elevation Line** , **Elevation Region**  tools.

Elevation data can also be imported. See "Importing Elevation Data" on page 355.

The elevation of each Elevation Line, Spline and Region is specified relative to sea level.

In order to create rising and/or falling terrain, multiple terrain data objects with different

elevation values must be used. If only one terrain data object is placed, the terrain will be flat regardless of the object's specified elevation.



To avoid unexpected results, do not draw Elevation Data objects with different elevation information at the same location.

## Elevation Points



An **Elevation Point** contains the absolute elevation data for one point in the terrain model. Typically, Elevation Points are imported rather than placed manually.

Home Designer Architectural requires many points to make an accurate approximation of your site. Even small sites may require over a

hundred points to generate an accurate model of the terrain if it is sloped. For the sake of illustration, the following example shows only a few elevation points.

**To place an elevation point**

1. Select **Terrain> Elevation Data> Elevation Point**  and click in floor plan view at the point where you would like to place elevation data.
2. The **Elevation Point Specification** dialog opens. Enter an elevation value and click **OK**. See “Elevation Point Specification Dialog” on page 347.
3. Click somewhere else in floor plan view and the **Elevation Point Specification** dialog opens again with the last elevation value entered.

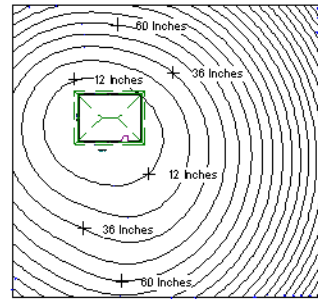

*Contour lines after terrain generation*

 Elevation Points are most effective when they are imported. When adding elevation data manually, use Elevation Lines instead. See “Importing Elevation Data” on page 355.

**Elevation Lines**

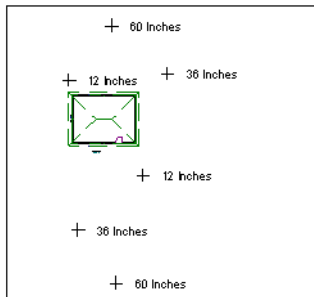

 An **Elevation Line** contains absolute elevation data for many points along a line at a constant elevation. Elevation lines can be connected to create a polyline with many straight sections. For the sake of illustration, the images in the following example show single-section elevation lines.



*Elevation Points before terrain generation*

4. Repeat steps 1, 2 and 3 to place additional elevation points with varied elevation values as needed.
5. Select **Terrain> Build Terrain** . See “Building the Terrain” on page 344.

**To draw an elevation line**

1. Select **Terrain> Elevation Data> Elevation Line** , then click and drag a line inside the Terrain Perimeter in floor plan view.
2. Click on the elevation line to select it, then click the **Open Object**  edit button.
3. At first, an elevation line is at elevation 0' - 0". In the **Elevation Line**



**Specification** dialog, specify the desired elevation and click OK. See “Elevation Line/Region Specification Dialog” on page 348.

- Repeat steps 2 and 3 to draw additional elevation lines as needed.

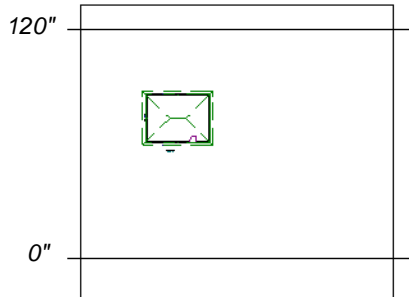

*Elevation Lines before terrain generation*

- Select **Terrain > Build Terrain** . See “Building the Terrain” on page 344.

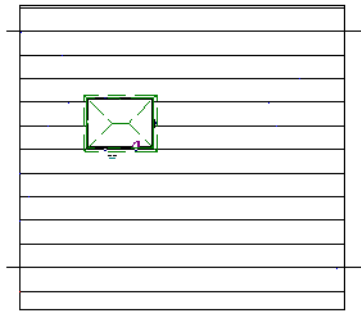

*Contour lines after terrain generation*



*Full Overview after terrain generation*



After it is drawn, an Elevation Line can be edited much the way other line-based objects can. See “Editing Line Based Objects” on page 90.

## Elevation Regions



An **Elevation Region** contains absolute elevation data for an enclosed region and is ideal for creating a flat surface in your terrain.

### *To create an elevation region*

- Select **Terrain > Elevation Data > Elevation Region** .
- There are two ways to add a Terrain Modifier to your plan:
  - Click once to place an 8' (0.6 m) square feature at that location.
  - Click and drag from end to end to draw a feature sized as needed. See “Draw Polyline” on page 512.
- Click on the region to select it, then click the **Open Object**  edit button.
- At first, an elevation line is at elevation 0' - 0". In the **Elevation Region Specification** dialog, specify the desired elevation and click OK. See “Elevation Line/Region Specification Dialog” on page 348.

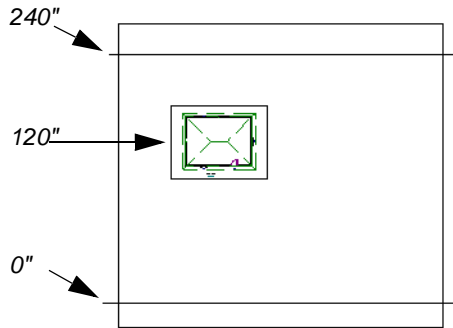

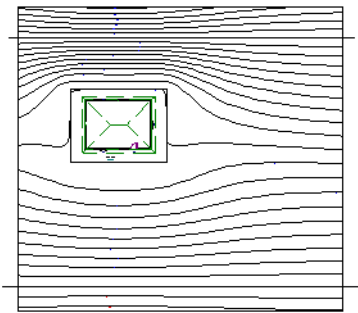

*Elevation lines create a terrain grade; an elevation region creates a building pad.*

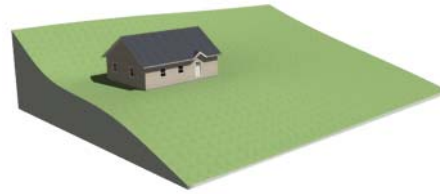

*Contour lines after terrain generation*



*Full Overview after terrain generation*

An **Elevation Region**  can also be created by drawing a closed polyline using **Elevation Lines** .

After it is drawn, an Elevation Region can be reshaped much the way other closed polyline-based objects can. See “Editing Closed-Polyline Based Objects” on page 98.



## Terrain Modifier Tools

 Select **Terrain > Modifier** to access tools that allow you to modify the existing elevation data by drawing a closed polyline. Their height is relative to the terrain surface generated from the Elevation Data provided in your plan.

The elevation data associated with a Terrain Modifier only affects the terrain within its

perimeter. The rest of the terrain is unaffected.

### Raised and Lowered Regions

  The **Raised Region** tool creates a raised area with a top surface that is flattened like a plateau but follows the surface of the terrain. The **Lowered Region**

tool creates a depression with a bottom that follows the terrain and is flattened.

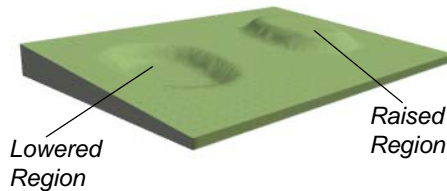

## Hills and Valleys



The **Hill** and **Valley** tools create raised and lowered areas in the terrain that come to a point rather than flattening at their highest or lowest elevations.

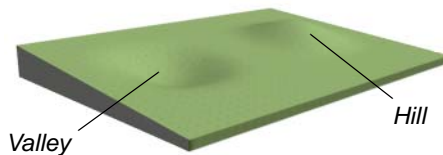

There are two ways to add a Terrain Modifier to your plan:

- Click once to place a modifier with endpoints that form a 10' (4 m) square at that location.
- Click and drag from end to end to draw a feature sized as needed. See "Draw Polyline" on page 512.

Terrain Modifiers can only be drawn when a Terrain Perimeter is present, and will only display in 3D when they are drawn within the perimeter. See "Displaying Terrain" on page 343.

Once created, Terrain Modifiers can be selected and edited in a variety of ways. See "Editing Spline Based Objects" on page 103.

---

## Terrain Feature Tools



Select **Terrain > Feature** to access tools for drawing bounded areas that follow the contours of the terrain rather than modifying them.

Terrain Features are useful for creating landscaping features because they have specified heights and materials. You can, for example, create paths and planting beds with gravel or mulch materials that stand out in a grassy Terrain Perimeter. See "Adding Terrain Features" on page 144 of the User's Guide.

In fact, **Driveways** , **Garden Beds** , **Water Features**  and **Stepping**

**Stones**  are special Terrain Features with material and height attributes already applied to them, saving you time when drawing these objects.

Terrain Features can only be drawn when a Terrain Perimeter is present, and will only display in 3D when they are drawn within the perimeter. See "Displaying Terrain" on page 343.

Terrain Features can be created in either of two ways:

- Click once to place a feature with end-points that form a 10' (4 m) square at that location.
- Click and drag from end to end to draw a feature sized as needed. See “Draw Polyline” on page 512.

Once created, Terrain Features can be edited into nearly any shape you require. See “Editing Closed-Polyline Based Objects” on page 98 and “Editing Spline Based Objects” on page 103.



Terrain Features can be drawn in 2D and 3D views.

## Rectangular Features



The **Rectangular Feature** tool can be used to create straight-sided features that can be edited into a wide variety of shapes.

Rectangular Features can also be edited like other closed polyline-based objects. See “Editing Closed-Polyline Based Objects” on page 98.

## Round Feature



The **Round Feature** tool can be used to create features with rounded edges and smoothly curved corners.

**Round Features** can be edited like other closed spline-based objects. See “Editing Spline Based Objects” on page 103.

## Kidney Shaped Features



The **Kidney Shaped Feature** tool allows you to quickly create features with curved edges, smooth corners and a right angle bend in its shape.

**Kidney Shaped Features** can be edited like other closed spline-based objects. See “Editing Spline Based Objects” on page 103.

For information about adding height and material information to Terrain Features, see “Terrain Feature Specification Dialog” on page 350.

## Terrain Holes



A **Terrain Hole** is a region that cuts a hole in the terrain.

**Terrain Holes**  are useful for manually clipping the terrain around a foundation that does not match the footprint of the first floor.

---

## Garden Bed Tools



Select **Terrain > Garden Bed** to access tools that can be used to place garden bed features in your terrain.

Garden Beds are basically **Terrain Features** with material and height attributes typical of

planting beds. See “Terrain Feature Tools” on page 339.

In addition, you can choose to distribute copies of a plant image within a Garden Bed. See “Distributed Plant Panel” on page 350.

### Polyline Garden Bed

 This tool draws a garden bed with straight sides and four right angles. See “Rectangular Features” on page 340.

### Round Garden Bed

 Use this tool to draw garden beds with rounded edges and smoothly curved corners. See “Round Feature” on page 340.

### Kidney Shaped Garden Bed

 You can draw a kidney shaped garden bed with this tool. See “Kidney Shaped Features” on page 340.

Once drawn, Garden Beds can be selected and edited just like other Terrain Features.

Specify the material and set the height of Garden Beds in the **Terrain Feature Specification** dialog. See “Terrain Feature Specification Dialog” on page 350.

## Water Feature Tools

 Select **Terrain**> **Water Feature** to access tools for drawing ponds and streams in your terrain.

Ponds are basically **Terrain Features** with material and height attributes typical of bodies of water. See “Terrain Feature Tools” on page 339.

Similarly, Streams are Terrain Curbs with a water material. See “Terrain Wall and Curb Tools” on page 342.

### Round Pond

 Use this tool to draw a pond with rounded edges. See “Round Feature” on page 340.

### Kidney Shaped Pond

 This tool draws a kidney shaped pond. See “Kidney Shaped Features” on page 340.

### Stream

 Select the **Stream** tool, then click and drag to draw a stream. Streams are drawn and edited the same way that splines are. See “Draw Spline” on page 513 and “Editing Spline Based Objects” on page 103.

Streams follow the contours of the terrain, so they may appear to flow uphill if they are not drawn correctly in the terrain. Try to draw them so that they follow a downward course for their entire length.

Once drawn, Water Features can be selected and edited just like any other Terrain Feature.

Specify the material and set the height of Water Features in their specification dialogs. See “Terrain Feature Specification Dialog” on page 350 and “Terrain Path Specification Dialog” on page 353.

---

## Stepping Stone Tools



Select **Terrain > Stepping Stone** to place a walkway made of individual stepping stones.

Stepping Stones are basically **Terrain Features** with material and height attributes typical of walking paths. See “Terrain Feature Tools” on page 339.

There are two ways to draw Stepping Stones:

- Click once to place a stepping stone with endpoints that form a 1' (300 mm) square at that location.
- Click and drag from end to end to draw a stepping stone sized as needed. See “Draw Polyline” on page 512.

### Polyline Stepping Stone



The **Polyline Stepping Stone** tool draws rectangular stepping stones. See “Rectangular Features” on page 340.

### Round Stepping Stone



The **Round Stepping Stone** tool draws stepping stones with rounded edges. See “Round Feature” on page 340.

Once drawn, Stepping Stones can be selected and edited just like any other Terrain Feature.

By default, Stepping Stones have a concrete material; however, you can specify the material and set the height of Stepping Stones in the **Terrain Feature Specification** dialog. See “Terrain Feature Specification Dialog” on page 350.

---

## Terrain Wall and Curb Tools



Select **Terrain > Terrain Wall and Curb** to draw landscaping walls and curbs that follow the contours of the terrain.

Straight and curved Terrain Walls and Curbs are drawn just as other walls are. See “Drawing Walls” on page 130.

Terrain Walls and Curbs are examples of Terrain Paths. Other examples include Sidewalks and Streams. See “Terrain Path Specification Dialog” on page 353.

### Terrain Walls



Use the **Straight Terrain Wall** tool to draw a wall that sits on top of and follows the terrain.



Use the **Spline Terrain Wall** to draw a curved terrain wall. This wall is drawn the same way as a CAD Spline. See “Draw Spline” on page 513.

Once drawn, a Terrain Wall can be like other line-based objects. See “Editing Line Based Objects” on page 90 and “Editing Spline Based Objects” on page 103.

Terrain walls are 5' (1500 mm) high and concrete by default, but you can specify the

material, height and more in the **Terrain Path Specification**. See “Terrain Path Specification Dialog” on page 353.

## Retaining Walls



Use the **Straight Retaining Wall** tool to draw a straight wall that holds back sloped terrain.



Use the **Curved Retaining Wall** tool to draw a curved retaining wall.

A Retaining Wall’s height is determined by the elevation of the terrain on each side. By default, the height of the wall matches the terrain on the high side of the break and the bottom matches the low side. If you insert a Retaining Wall into flat terrain, it looks like a concrete strip in 3D views.

Once drawn, a Retaining Wall can be edited much like other walls. See “Editing Walls” on page 135.

## Terrain Curbs

Terrain Curbs are useful for creating curbs around planting beds and along paths, driveways and roads.



Use the **Straight Terrain Curb** tool to draw a straight landscaping curb.



Use the **Spline Terrain Curb** tool to draw a curved landscaping curb. This curb is drawn the same way as a CAD Spline. See “Draw Spline” on page 513.

Once drawn, a Terrain Curb can be like other line-based objects. See “Editing Line Based Objects” on page 90 and “Editing Spline Based Objects” on page 103.

You can specify the height of straight and spline terrain curbs on the **GENERAL** panel of the **Terrain Path Specification**. See “Terrain Path Specification Dialog” on page 353.



You can also add Fencing to your terrain, complete with gates from the Doors Library. See “Fencing Tools” on page 125.

---

## Terrain Objects in the Library



The Library Browser contains a variety of objects that can be placed in a plan’s terrain, including plants, exterior

fixtures, accessories and roadway objects. See “The Library Browser” on page 394.

---

## Displaying Terrain



The display of terrain objects in 2D and 3D views is controlled in the **Display Options** dialog. See “Display Options Dialog” on page 77.

You can customize appearance of Terrain Features, Roads and other terrain objects in floor plan view by changing their line and fill styles.

Plant images are represented in floor plan view by 2D CAD symbols. You can select a plant's symbol in the **Plant Image Specification** dialog. See "Image Panel" on page 370.

When elevation data has been drawn or imported into a plan, contour lines will display in floor plan view. See "Elevation Data Tools" on page 335.

### In 3D Views

In order for objects such as Terrain Features and Roads to be visible in 3D views, they must be drawn within the Terrain Perimeter. Any portions of these objects drawn outside of the Terrain Perimeter will not be seen in 3D views. See "Terrain Feature Tools" on page 339.

A variety of tools are available to help you adjust the perspective of your 3D views. See "Editing 3D Views" on page 461.

### Building the Terrain



When terrain is generated, Home Designer Architectural gathers all elevation data that has been added to the model and creates a terrain surface. The

program interpolates the data to produce smooth contours.

A terrain perimeter with no additional elevation data drawn within it generates terrain that is flat at the elevation 0' - 0", or sea level.

The terrain is automatically built before a 3D view is generated. This process takes a variable amount of time, depending on the amount of elevation data and number of terrain features in the plan. The **Building Terrain** progress dialog displays as terrain is generated, sometimes only briefly, indicating the progress.

### Terrain and 3D Drawing Time

Terrain is typically large with many surfaces, which often increases the drawing time of 3D views. The time required is affected by the amount of elevation data and number of terrain features present.

Lights and symbols can be placed outdoors and included in 3D views when the terrain is generated. These objects can also contribute to the time needed to generate 3D views. See "Rendering Tips" on page 470.

---

## Editing Terrain Objects

Before a terrain object can be edited, it must be selected. All terrain objects can be selected in floor plan view. In addition, the Terrain Perimeter and Terrain Features can be selected in 3D views. See "Selecting Objects" on page 88.

A selected terrain object can be edited using its edit handles, edit tools and specification

dialog. See "Specification Dialogs" on page 32.

Any time elevation data is changed, the terrain must be regenerated. This occurs automatically when a 3D view is created. It can also be done manually by selecting

**Terrain > Build Terrain**



## Using the Edit Handles

- The shape of the Terrain Perimeter can be edited like other polyline-based objects. See “Editing Closed-Polyline Based Objects” on page 98.
- Elevation Points can be moved in floor plan view using the Move edit handle.
- **Elevation Lines** are edited like other line-based objects. See “Editing Line Based Objects” on page 90 and “Editing Closed-Polyline Based Objects” on page 98.
- The shape of a **Raised Region, Lowered Region, Hill,** and **Valley** can be edited like a spline. See “Editing Spline Based Objects” on page 103.
- Terrain Features are edited like other spline- and polyline-based objects. See “Editing Closed-Polyline Based Objects” on page 98 and “Editing Spline Based Objects” on page 103.



## Using the Edit Tools

A selected terrain object can be edited in a variety of ways using the buttons on the edit toolbar. The edit tools available for a terrain object depends on the type of terrain object selected. See “The Edit Toolbar” on page 28.

Note: If you copy terrain objects from one plan to another, you cannot view the pasted objects in 3D unless a Terrain Perimeter exists.

## Moving Terrain Objects Using Dimensions

If dimensions display when a terrain object is selected, the object can be moved using the them. For more information see “Moving Objects Using Dimensions” on page 494.



---

## Terrain Specification Dialog



The **Terrain Specification** dialog controls how your terrain is modeled, as well as its appearance.

The **Terrain Specification** dialog can be accessed in any of two ways:

- Select the Terrain Perimeter and click the **Open Object**  edit button.
- Double-click the Terrain Perimeter using the **Select Objects**  tool.

## General Panel

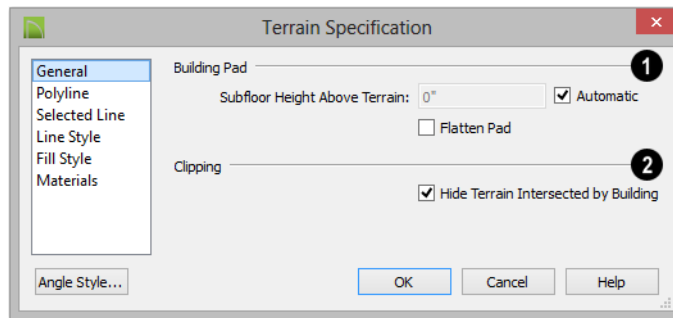

- 1 Specify how the **Building Pad** is generated beneath the structure. See “Foundations and the Terrain” on page 233.
  - To specify the distance between Floor 1 and the terrain at the building footprint center, uncheck **Automatic** and enter a value in the **Subfloor Height Above Terrain** field.
  - Check **Automatic** to have Home Designer Architectural automatically lower the terrain relative to the first floor. See “Terrain Height vs Floor Height” on page 334.
  - Check **Flatten Pad** to flatten the area beneath the building. To create a walkout basement, uncheck this box.
- 2 **Clipping** - Check **Hide Terrain Intersected by Building** to cut out the portion of the terrain that is intersected by the first floor footprint. Checking this box prevents the generation of contour lines inside the house.

### Polyline Panel

The POLYLINE panel states the length of the Terrain Perimeter’s **Perimeter**, its enclosed **Area**, and its **Volume**.

The settings on the this panel are available for a variety of other objects in the program. For information about these settings, see “Polyline Panel” on page 518.

### Selected Line Panel

The SELECTED LINE panel is available when the selected edge of the Terrain Perimeter is a line as opposed to an arc. See “Selected Edge” on page 88.

The settings on this panel are available for a variety of other objects in the program. For information about these settings, see “Line Panel” on page 513.

### Selected Arc Panel

The SELECTED ARC panel is available when the selected segment of the polyline is an arc as opposed to a line. See “Change Line/Arc” on page 114.

The settings on this panel are available for a variety of other objects in the program. For information about these settings, see “Arc Panel” on page 516.

## Line Style Panel

The settings on the LINE STYLE panel are available for a variety of other objects in the program. For information about these settings, see “Line Style Panel” on page 514.

## Fill Style Panel

The settings on the FILL STYLE panel affect the appearance of the Terrain Perimeter in

floor plan view. For information about these settings, see “Fill Style Panel” on page 519.

## Materials Panel

The settings on the MATERIALS panel let you specify the terrain surface and terrain skirt materials used in 3D views. These materials are not calculated in the Materials List. See “Materials Panel” on page 420.

---

## Elevation Point Specification Dialog

 To open the **Elevation Point Specification** dialog, select an elevation point and click the **Open Object** edit button, or double-click on an Elevation Point

using the **Select Objects**  tool.

Use the **Elevation Point Specification** dialog to define the selected elevation point and control its appearance in floor plan view.

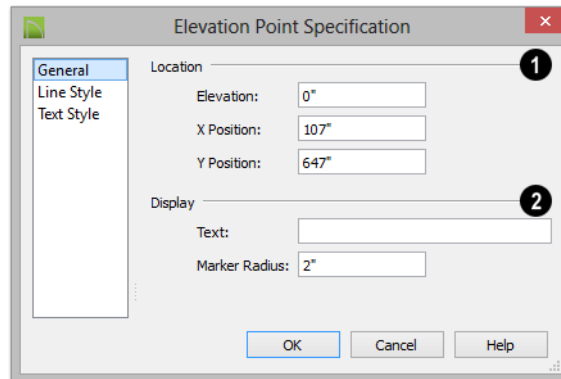

**1 Location** - Specify the exact location of the elevation point.

- Specify the **Elevation** of the selected Elevation Point.
- **X Coordinate** - Enter the x coordinate of the elevation point.
- **Y Coordinate** - Enter the y coordinate of the elevation point.

**2 Display** -

- In the **Text** field, type any notes that you would like to display beside the selected Elevation Point in floor plan view. You can also enter a pound (#) sign to display the point’s elevation value.

- Enter the **Marker Radius**, which is size of the point marker, measured from the center to an edge.

## Line Style Panel

The settings on the LINE STYLE panel are available for a variety of other objects in the

program. For information about these settings, see “Line Style Panel” on page 514.

## Text Style Panel

The settings on the TEXT STYLE panel control the appearance of the selected Elevation Point’s text. For more information, see “Text Style Panel” on page 509.

# Elevation Line/Region Specification Dialog



To open the **Elevation Line** or **Elevation Region Specification** dialog, select one or more Elevation Line, or a polyline composed of elevation Lines, or an Elevation Region and click the **Open Object** edit button. You can also double-click an

Elevation Line using the **Select Objects**  tool.

The **Elevation Line Specification** dialog is used to define the selected Elevation Line and controls its appearance in floor plan view.

The settings in this dialog are the same as those in the **Elevation Region Specification** dialog. See “Elevation Regions” on page 337.

## Elevation Panel

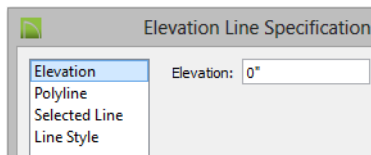

- Specify the **Elevation** of the selected Elevation Line, Spline, or Polyline.

## Polyline Panel

The POLYLINE panel states the **Length** of an open polyline or the **Perimeter** of a closed polyline. If multiple Elevation Line segments form a closed Elevation Region, its Area will be calculated. Elevation Lines do not have a thickness, so they have no Volume.

## Selected Line Panel

The SELECTED LINE panel is available when the selected object or segment is a line as opposed to one that has been converted to an arc. See “Selected Edge” on page 88.

The settings on this panel are available for a variety of other objects in the program. For information about these settings, see “Line Panel” on page 513.

## Selected Arc Panel

The SELECTED ARC panel is available when the selected object or segment is an arc as opposed to a line.

The settings on this panel are available for a variety of other objects in the program. For information about these settings, see “Arc Panel” on page 516.

## Line Style Panel

The settings on the LINE STYLE panel are available for a variety of other objects in the

program. For information about these settings, see “Line Style Panel” on page 514.

---

## Hill / Valley Specification Dialog



The **Hill/Valley Specification** defines the selected Hill or Valley and controls its appearance in floor plan view.

To open the **Hill/Valley Specification** dialog, select a Hill or Valley and click the **Open Object** edit button, or double-click the region(s) using the **Select Objects**  tool.

### Hill / Valley Panel

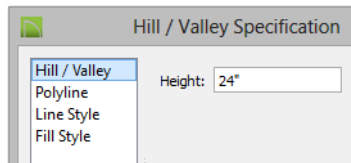

- Enter a **Height** for the selected Hill or Valley. This height is relative to the terrain surface that is generated from the Elevation Data in your plan. See “Terrain Modifier Tools” on page 338.

## Polyline Panel

The POLYLINE panel states the length of the hill or valley’s **Perimeter** and its enclosed **Area**. Hills and Valleys do not have a volume measurement.

## Line Style Panel

The settings on the LINE STYLE panel are available for a variety of other objects in the program. For information about these settings, see “Line Style Panel” on page 514.

## Fill Style Panel

The settings on the FILL STYLE panel affect the appearance of the selected object in floor plan view. For information about these settings, see “Fill Style Panel” on page 519.

---

## Raised / Lowered Region Specification Dialog



To open the **Raised/Lowered Region Specification** dialog, select a raised or lowered region and click the **Open Object** edit button, or double-click the region(s) using the **Select Objects**  tool.

The **Raised / Lowered Region Specification** dialog is similar to the **Hill / Valley Specification** dialog. See “Hill / Valley Specification Dialog” on page 349.

## Terrain Feature Specification Dialog

To open the **Terrain Feature Specification** dialog, select a Terrain Feature and click the **Open Object** edit button, or double-click the Terrain Feature using the **Select Objects**  tool.

Most of the panels in this dialog are similar to those for a variety of other objects in the

program, including Water Features, Stepping Stones, Driveways, and Parking Lots.

Garden Beds are also a type of Terrain Feature and have an additional Distributed Plant panel in their specification dialog.

Garden Beds also have a preview pane on the right side of their specification dialog.

### General Panel

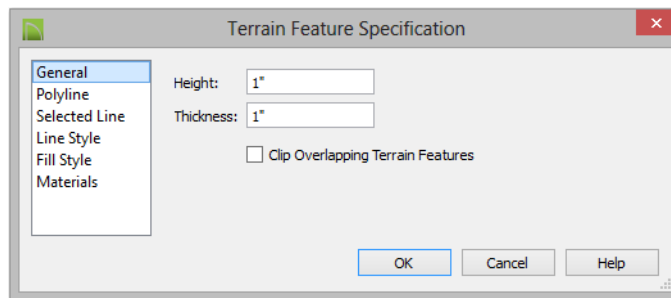

- Specify the top **Height** of the Terrain Feature, relative to the terrain surface, using a positive or negative number.
  - Specify the feature's **Thickness**.
  - Check **Clip Overlapping Terrain Features** to suppress the 3D display of any part of the selected Terrain Feature intersected by other Terrain Features with a lower Height value. Clipping is useful for creating features that contain other features such as planters or swimming pools.
- If a feature's height above the terrain is greater than its thickness, the program will fill in the resulting gap.

### Distributed Plant Panel

This panel is only available when the selected Terrain Feature is a Garden Bed. See "Garden Bed Tools" on page 340.

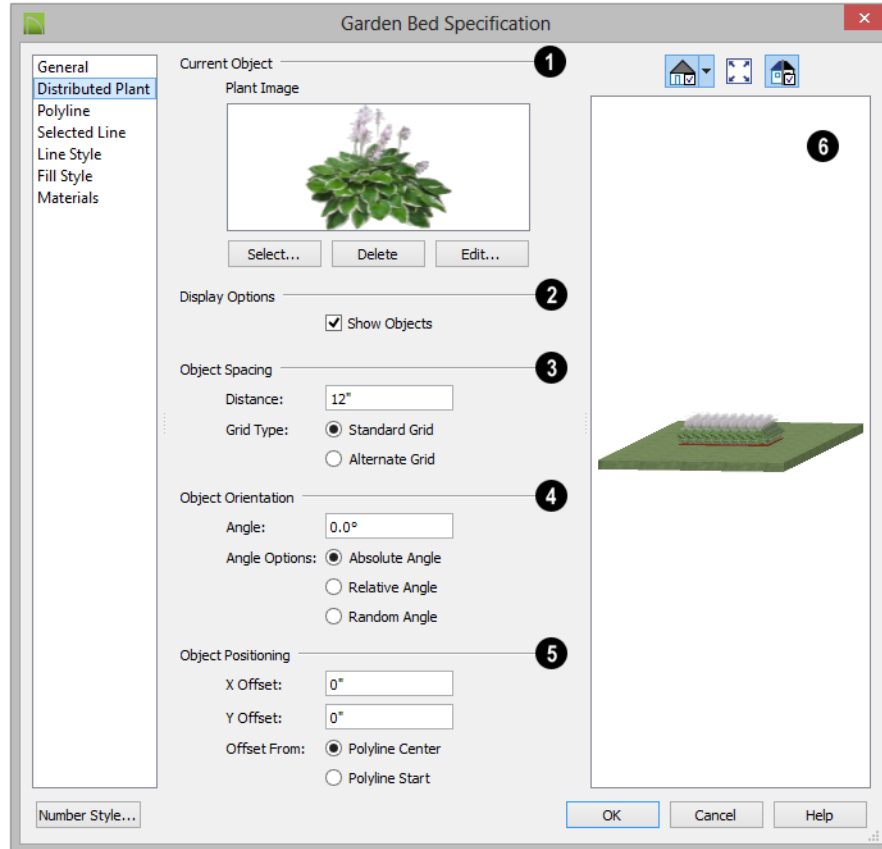

**1** Specify the **Current Object** assigned to the selected garden bed. When an object is assigned, its name and a preview of a single instance of it display here.

- Click the **Select** button to choose an object from the library. See “Select Library Object Dialog” on page 408.
- Click the **Delete** button to unassign the Current Object from the selected garden bed.
- Click the **Edit** button to open the Current Object’s specification dialog. Changes

made here affect all objects generated within the garden bed. See “Specification Dialogs” on page 32.

**2 Display Options -**

- Check **Show Objects** to display the distributed objects in floor plan view.
- Check **Show Region** to display the edges of the garden bed in floor plan view.

**3 Object Spacing -** Specify how the objects in the garden bed are spaced.

- Specify the **Distance** between the objects in the garden bed, as measured from their center points.
- Select **Standard Grid** to position the objects in rows and columns based on the standard X/Y grid in the program.
- Select **Alternate Grid** to position the objects in rows and columns based on the shape of the garden bed.

**4 Object Orientation** - Specify how or if the objects in the garden bed are rotated. These settings do not affect the garden bed itself or its edges.

- Specify the **Angle** that the distributed objects should be placed at.
- Select **Absolute Angle** to rotate the objects to the specified Angle as measured from an imaginary horizontal line drawn from the origin towards the right.
- Select **Relative Angle** to rotate the objects relative to the angle of the region's first edge or, if that edge is curved, to the angle of its chord. The first edge is typically located at the top of the garden bed when it is first created; however, this can change as the bed is edited.
- Select **Random Angle** to rotate the objects in the region at a variety of random angles.

**5 Object Positioning** - Specify the positioning of the distributed objects relative to a point of origin within the garden bed.

- Specify the **X Offset**, the horizontal distance in floor plan view from the garden bed's specified point of origin.

- Specify the **Y Offset**, the vertical distance in floor plan view from the garden bed's specified point of origin.
- Select **From Polyline Center** to measure the offset from the garden bed's center point.
- Select **Polyline Start** to measure the offset from the garden bed's start point. This start point is typically located at the top left of the garden bed when it is first created; however, this can change as the garden bed is edited.

**6** A preview of the garden bed displays on the right side of the dialog box. See "Dialog Preview Panes" on page 32.

### Polyline Panel

The POLYLINE panel states the length of the garden bed's **Perimeter**, its enclosed **Area**, and its **Volume**.

### Selected Line Panel

The SELECTED LINE panel is available when the selected edge of the polyline is a line as opposed to an arc. See "Selected Edge" on page 88.

The settings on this panel are available for a variety of other objects in the program. For information about these settings, see "Line Panel" on page 513.

### Selected Arc Panel

The SELECTED ARC panel is available when the selected segment of the polyline is an arc as opposed to a line. See "Change Line/Arc" on page 114.

The settings on this panel are available for a variety of other objects in the program. For



information about these settings, see “Arc Panel” on page 516.

### Line Style Panel

The settings on the LINE STYLE panel are available for a variety of other objects in the program. For information about these settings, see “Line Style Panel” on page 514.

### Fill Style Panel

The settings on the FILL STYLE panel affect the appearance of the selected object in floor plan view. For information about these settings, see “Fill Style Panel” on page 519.

### Materials Panel

The settings on the MATERIALS panel affect the appearance of the selected object in 3D views. See “Materials Panel” on page 420.

## Garden Bed Specification Dialog



To open the **Garden Bed Specification** dialog, select a Garden Bed and click the **Open Object** edit button or double-click the Garden Bed using the **Select Objects**  tool.

Because a Garden Bed is a type of Terrain Feature, the settings in this dialog are essentially the same as those in the **Terrain Feature Specification** dialog. See “Terrain Feature Specification Dialog” on page 350.

## Terrain Path Specification Dialog



To open the **Terrain Path Specification** dialog, select a Sidewalk, Stream, Terrain Wall or Terrain Curb and click the **Open Object** edit button

or double-click the terrain path using the **Select Objects**  tool.

Most of the panels in this dialog are similar to those for a variety of other objects in the program.

## General Panel

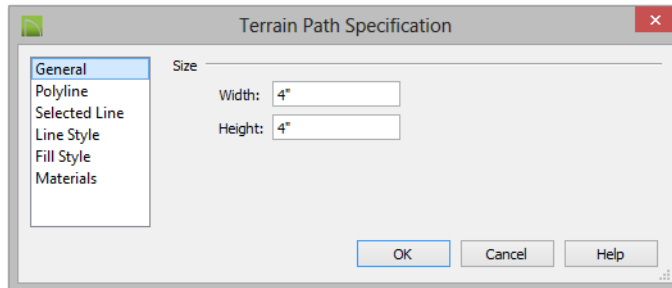

**Size** - Enter the **Width** of the object and the **Height** above the terrain. If the Height value is a negative number, the object sinks into the terrain.

### Polyline Panel

The POLYLINE panel states the length of the Terrain Path's **Perimeter**, its enclosed **Area**, and its **Volume**.

### Selected Line Panel

The SELECTED LINE panel is available when the selected edge of the Terrain Perimeter is a line as opposed to an arc. See "Selected Edge" on page 88.

The settings on this panel are available for a variety of other objects in the program. For information about these settings, see "Line Panel" on page 513.

### Selected Arc Panel

The SELECTED ARC panel is available when the selected segment of the polyline is an arc as opposed to a line. See "Break Line" on page 113.

The settings on this panel are available for a variety of other objects in the program. For information about these settings, see "Arc Panel" on page 516.

### Line Style Panel

The settings on the LINE STYLE panel are available for a variety of other objects in the program. For information about these settings, see "Line Style Panel" on page 514.

### Fill Style Panel

The settings on the FILL STYLE panel affect the appearance of the selected object in floor plan view. For information about these settings, see "Fill Style Panel" on page 519.

### Materials Panel

The settings on the MATERIALS panel affect the appearance of the selected object in 3D views. See "Materials Panel" on page 420.

---

## Importing Elevation Data

Elevation data can be added to a plan using the tools and techniques described in this chapter or it can be imported from a file.

Home Designer Architectural can import elevation data saved in GPS Exchange (.gpx) and a variety of text file formats (.txt, .csv, .prn, .xyz, .auf and .nez). If your terrain data is not saved in one of these file formats, there are third party programs available that can convert to these formats.

### Text Files

Elevation data can be saved in text files as x, y, and z coordinates where x and y define the location of a point on a Cartesian grid, and z defines the elevation for that point. Each data point must be on a separate line in the text file.

Importable text files can come from surveyors, other software programs, or you can create your own using a GPS system.

Elevation data saved in text files can be imported using the **Import Terrain Assistant**.

### GPS Exchange Files

Elevation data in standard format .gpx files created using a GPS system can also be imported using the **Import GPS Data Assistant**. See “Import GPS Data Assistant” on page 357.

GPS data may include three types of points - Way, Track, and Route. Home Designer Architectural can only import a .gpx file if it includes one or more Way Points, and cannot use Route Points at all. If a .gpx file does not include any Way Points, it will not be imported, and if it includes any Route Points, they will be ignored.

Home Designer Architectural supports the import of data in standard .gpx files that adhere to the GPX 1.1 Schema. Files that do not follow this standard cannot be imported.

---

## Import Terrain Assistant



The **Import Terrain Assistant** allows you to import elevation data saved in text (.txt) file format into a plan.

Each data point in this format has information about its X-axis (East to West location), Y-axis (North to South location), and Z-axis (elevation). It might also have a brief

description. In order to import elevation data from a text file, you need to know how the data in the file is organized.

To launch the **Import Terrain Assistant**, select **File> Import> Terrain Data** . Click **Next**.

## Select File

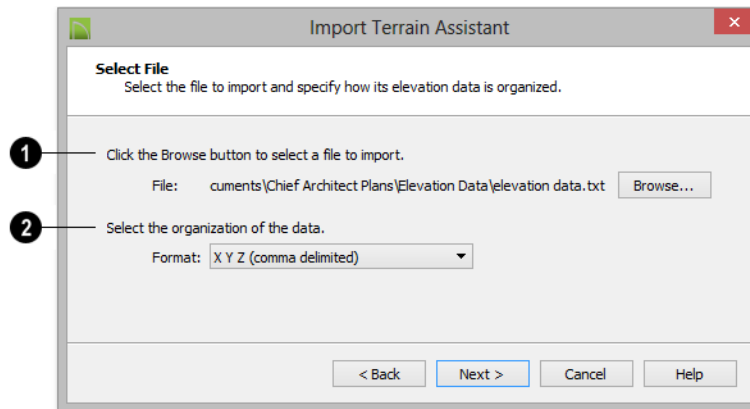

### 1 Select a file to import.

- Click the **Browse** button to locate a file on your computer. See “Importing Files” on page 51.
- If a file has been selected, its full path-name displays here for reference; if a file has not been selected, the directory of the last file imported displays. If the path-name is not that of a valid **.txt** file, this text will display in red.

### 2 Select the organization of the data.

Elevation information can be organized in one of six different ways, and can be separated by either a comma (comma delimited) or a space (space delimited).

- **XYZ** - Information in this format begins with the X coordinate, followed by the Y coordinate and the Z coordinate.

- **#XYZ** - Information in this format begins with a number that belongs to each data point followed by the X coordinate, the Y coordinate, and the Z coordinate.
- **#XYZ Description** - Information in this format begins with a number that belongs to each data point followed by the X coordinate, the Y coordinate, the Z coordinate, and a description.
- **YXZ** - Information in this format begins with the Y coordinate followed by the X coordinate and the Z coordinate.
- **#YXZ** - Information in this format begins with a number that belongs to each data point followed by the Y coordinate, the X coordinate, and the Z coordinate.
- **#YXZ Description** - Information in this format begins with a number that belongs to each data point followed by the Y coordinate, the X coordinate, the Z coordinate, and a description.

Click **Next** to continue.

### Scale Data

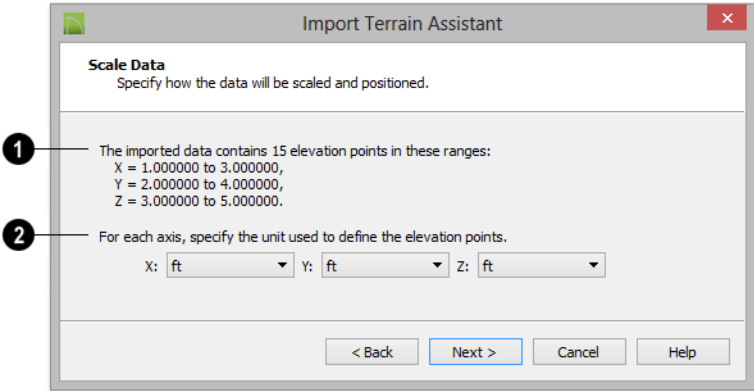

1 The total number of data points to be imported and the ranges of their coordinates are described here.

2 Select the **Units** of measurement used for each axis.  
Click **Next** to finish.

## Import GPS Data Assistant

 The **Import GPS Data Assistant** allows you to import terrain data from the standard **.gpx** file format. See “GPS Exchange Files” on page 355.

Select **File> Import> GPS Data** to open the **Import GPS Data Assistant**, then click **Next** to continue.

 Due to the lack of accuracy in some GPS systems, exact distances using the Import GPS Data Assistant are not guaranteed.

## Select File

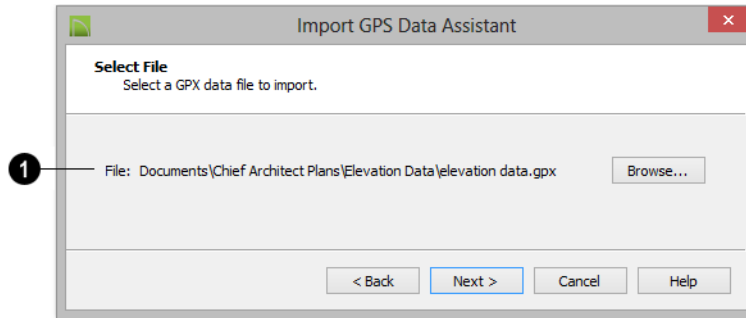

### 1 Select a file to import.

- Click the **Browse** button to locate a **.gpx** file on your computer. See “Importing Files” on page 51.
- If a file has been selected, its full path-name displays here for reference; if a file has not been selected, the directory of the

last file imported displays. If the path-name is not that of a valid **.gpx** file, this text will display in red.

Note: Not all GPS programs use the standard .gpx file format; however, only files using the standard format can be imported.

Click **Next** to continue.

## Import Data As

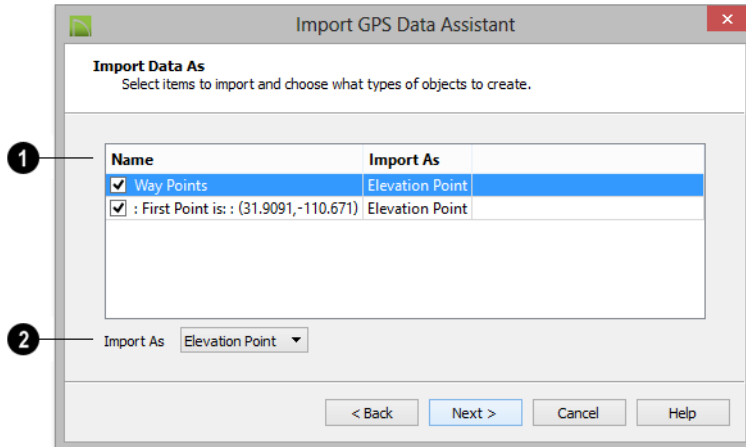

### 1 Specify which items you want to import by checking the box to the left of the

**Name**. Items with unchecked boxes are not imported.

- 2 Specify what you would like the selected item to **Import As** from the drop-down list.
- Only Way Points have elevation data associated with them. To import this data, import them as “Elevation Points”.
  - Select “Marker” to import either Way Points or Track Points as location markers. Markers have no elevation data associated with them.
  - Select “Polyline” to create an open CAD polyline based on the position of Way Points or Track Points. The points themselves are not imported. Polylines have no elevation data associated with them.

- Select “Terrain Perimeter” to create a closed Terrain Perimeter polyline based on the position of either Way Points or Track Points. The points themselves are not imported. A Terrain Perimeter has no elevation data associated with it. See “Terrain Perimeter” on page 333.



Way Points are typically imported as “Elevation Data”, while Track Points are imported as “Markers”, “Polylines”, or “Terrain Perimeter”.

Click **Next** to finish.

If you do not see the imported terrain, select **Window> Fill Window** .





# Roads, Driveways and Sidewalks

Roads and sidewalks are modeled in 3D like other terrain objects in Home Designer Architectural. Because they have much in common with terrain objects and rely upon terrain data to be viewed in 3D, it is helpful

to be familiar with terrain modeling before using these tools. See “Terrain” on page 333.

## Chapter Contents

- Road, Driveway and Sidewalk Tools

---

## Road, Driveway and Sidewalk Tools



Road objects can be drawn in floor plan view, camera views and overviews, but only when a Terrain Perimeter exists in the plan. See “Terrain Perimeter” on page 333.

Road objects created with the Road Tools have a consistent width that can be defined in their specification dialogs. See “Road Specification Dialog” on page 363, “Terrain Feature Specification Dialog” on page 350, and “Terrain Path Specification Dialog” on page 353.

Driveways and Parking Lots are actually Terrain Features. See “Terrain Feature Tools” on page 339. They are drawn as rectangles but can be edited to any shape. See “Editing Closed-Polyline Based Objects” on page 98.

Roads and sidewalks are flat along their widths, which makes it easy to create roads on sloping terrain. Driveways and Parking Lots follow the contours of the terrain rather than cut into them.

Once road objects have been placed, they can be edited individually or as a group. See “Editing Road Objects” on page 363.

## Straight Road



To place a road without any curves, select **Terrain> Road> Straight Road** and click and drag to draw a line in floor plan view. The ends of multiple road sections can be connected together.

Roads are edited along their center line like CAD lines and polylines. See “Editing Line Based Objects” on page 90.

## Spline Road



Use **Terrain> Road> Spline Road** to draw a curved road. Spline roads are drawn and edited like CAD splines. See “Draw Spline” on page 513.

## Straight Sidewalk



To create a sidewalk with no curves, select **Terrain> Road and Sidewalk> Straight Sidewalk**, then click and drag from end to end to draw a line. The ends of multiple sidewalk sections can be connected together.

Sidewalks are edited along their center line like line- and polyline- based objects. See “Editing Line Based Objects” on page 90.

Sidewalks can be edited in their specification dialog. See “Terrain Path Specification Dialog” on page 353.

## Spline Sidewalk



Use the **Spline Sidewalk** tool to create a curved sidewalk. Select **Terrain> Sidewalk> Spline Sidewalk**. Spline roads are drawn and edited like CAD splines. See “Draw Spline” on page 513.

## Driveway Area



A **Driveway Area** is a terrain feature with a concrete material assignment. To create a driveway, select **Terrain> Road and Sidewalk> Driveway Area**, then click and drag from corner to corner to draw a rectangle. See “Draw Polyline” on page 512.

Height, thickness and material information can be specified in a driveway’s specification dialog. See “Terrain Feature Specification Dialog” on page 350.

Driveways can be edited like other closed polylines. See “Editing Closed-Polyline Based Objects” on page 98.

## Parking Lot



A **Parking Lot** is a terrain feature with an asphalt material assignment. To place a parking lot, select **Terrain> Road and Sidewalk> Parking Lot**, then click and drag from corner to corner to draw a rectangle. See “Draw Polyline” on page 512.

Height, thickness and material information can be specified in a parking lot’s specification dialog. See “Terrain Feature Specification Dialog” on page 350.

---

## Displaying Road Objects

 Roads and sidewalks display in floor plan and 3D views based on the settings in the **Display Options** dialog. See “Layers” on page 75.

### In 3D Views

In order for Road objects to be visible in 3D views, they must be drawn within the Terrain Perimeter. Any portions of these objects

drawn outside of the Terrain Perimeter will not be seen in 3D views.

By default, the terrain rebuilds automatically when road objects are added, removed or edited. If it does not, you can select **Terrain**>

**Build Terrain** . See “Terrain Perimeter” on page 333.





---



## Editing Road Objects

Road objects can be selected in 2D and 3D views and edited using the edit handles, the edit toolbar and their specification dialogs.

### Using the Mouse

The edit handles available for a selected road object depend on the type of object selected.

- **Straight Roads**  and **Straight Sidewalks**  are edited along their centerline like a line or open polyline. See “Editing Line Based Objects” on page 90.
- **Spline Roads**  and **Spline Sidewalks**  are edited along their centerline like CAD splines. See “Draw Spline” on page 513.

- **Driveway Areas**  and **Parking Lots**  are edited like other closed polyline based objects. See “Editing Closed-Polyline Based Objects” on page 98.

### In the Specification Dialog

 Road objects can be customized in their specification dialogs. See “Road Specification Dialog” on page 363, “Terrain Feature Specification Dialog” on page 350, and “Terrain Path Specification Dialog” on page 353.

### Using the Edit Tools

A selected road object can be edited in a variety of ways using the buttons on the edit toolbar. See “The Edit Toolbar” on page 28.

---

## Road Specification Dialog

 To open the **Road Specification** dialog, select a Straight Road or

Spline Road and click the **Open Object** edit button.

Many of the settings in this dialog are similar to those in the **Terrain Path Specification**

dialog. See “Terrain Path Specification Dialog” on page 353.

## General Panel

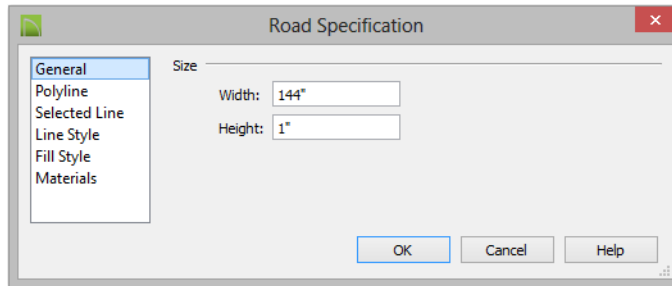

**Size** - Specify the **Width** and **Height** of the road relative to the terrain.

## Polyline Panel

The POLYLINE panel states the length of the road’s **Perimeter**, its **Area** and its **Volume**. For more information, see “Polyline Panel” on page 518.

## Selected Line/Arc Panel

The SELECTED LINE panel is available when a Straight Road is selected. For more information, see “Line Panel” on page 513.

The SELECTED ARC panel is available when the curved segment of a Straight Road is selected. See “Arc Panel” on page 516.

## Line Style Panel

This panel is the same as the LINE STYLE panel in many other specification dialogs. See “Line Style Panel” on page 514.

## Fill Style Panel

The settings on the FILL STYLE panel affect the appearance of the selected object in floor plan view. For information about these settings, see “Fill Style Panel” on page 519.

## Materials Panel

The settings on the MATERIALS panel affect the appearance of the selected object in 3D views. For information about these settings, see “Materials Panel” on page 420.

The material selected here is not calculated in the Materials List. See “Materials Lists” on page 579.

# Plants and Sprinklers

The Plant Tools and sprinklers from the Library Browser allow you to create planting designs and irrigation systems in your terrain.

The Terrain Tools are discussed in their own chapter. See “Terrain” on page 333.

## **Chapter Contents**

- Plant Tools
- Plant Chooser Dialog
- Hardiness Zones
- Plant Image Specification Dialog
- Sprinkler Tools
- Sprinkler Specification Dialog
- Plant Schedules
- Schedule Columns and Numbering
- Plant Schedule Specification Dialog

## Plant Tools



Select **Terrain> Plant** to add plants to your landscaping plan. Plants can also be placed in a plan directly from the library. See “Placing Library Objects” on page 406.

Plant objects are actually images, which provide realism while avoiding high 3D surface count. Once created, plant images can be selected and edited much like other image objects. See “Editing Images” on page 532.



Select **Terrain> Plant> Plant Chooser** to open the **Plant Chooser** dialog and find plants based on their characteristics and requirements. See “Plant Chooser Dialog” on page 367.



Select **Terrain> Plant> Create Plant Image** to create a plant image. Once a plant image is created, it can be added to the library for future use. See “Creating Images” on page 530.



Select **Terrain> Plant> Grow All Plants** to open the **Grow Plants** dialog.

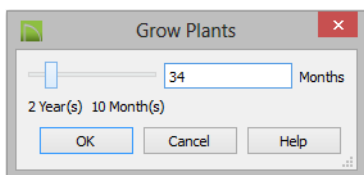

Click and drag the slider bar and select a growth period from zero to twenty years. This only works for plants that have a mature height and mature age specified in the **Plant Image Specification** dialog. See “Plant Information Panel” on page 371.



Select **Terrain> Plant> Show Hardiness Zones** to access regional climate zone maps. See “Hardiness Zones” on page 369.



Select **Terrain> Plant> Plant Schedule**, then click to create a plant schedule. See “Plant Schedules” on page 374.

## Garden Beds



Garden Beds are special **Terrain Features** with material and height attributes typical of planting beds. In addition, you can choose to distribute copies of a plant image within a Garden Bed. See “Garden Bed Tools” on page 340.

## Plants Library Catalogs



In the Library Browser, browse to Home Designer Core Catalogs> Plants to access a selection of plant images. Select the library object you want, then click in any view to place it in the plan. See “The Library” on page 393.

A selection of Bonus Catalogs of plants is also available for download. See “Home Designer Bonus Catalogs” on page 399.

In addition, you can add single plants and blocked groups of plants to the library. See “Adding Library Content” on page 402 and “Architectural Blocks” on page 387.

## Plant Schedules



The **Plant Schedule** tool allows you to create customizable plant schedules. See “Plant Schedules” on page

## Plant Chooser Dialog



Select **Terrain> Plant> Plant Chooser** to open the **Plant Chooser** dialog or click the **Plant Chooser** button at the bottom of the Library Browser window.

Use the **Plant Chooser** to search the library for plant images and symbols that meet your

search parameters. You can search using any or all of the options in this dialog.

The search parameters in the **Plant Chooser** dialog correspond to the settings on the Plant Information panel of the **Plant Image Specification** dialog. See “Plant Information Panel” on page 371.

The screenshot shows the Plant Chooser dialog box with the following fields and options:

- 1** Name: Common Name: cilantro, Variety Name: [empty], Scientific Name: [empty], Pronunciation: [empty]
- 2** Type:  Annual,  Perennial/Biennial,  Tree,  Shrub,  Bulb,  Cactus/Succulent
- 3** Sub-Type:  Fruit,  Vegetable,  Herb,  Nut,  Turf,  Ornamental Grass,  Evergreen,  Deciduous,  Houseplant,  Groundcover,  Climber,  Aquatic
- 4** Needs: Sun: [Sun icons], Water: [Water icons], Soil pH: [pH icons], Hardiness Zone from: Unknown, to: 15, View Map...
- 5** Flowers and Foliage: Flower Color: [Color icons], Bloom Time: [Time icons], Leaf Color: [Color icons]
- 6** Height: From: 0"-12", To: 24+, Height at Maturity: 0", Starting Age: 0 months, Age at Maturity: 0 months
- 7** Special Characteristics:  Easy To Grow,  Fast Growing,  Self-Sowing,  Container,  Fragrant,  Attracts Birds & Butterflies,  Deer Resistant,  Winter Interest,  Cut Flowers,  US Native/Wildflower,  Fall Color,  Attractive Foliage
- 8** Object Type:  3D Plants,  Plant Images,  Both
- 9** Search button
- 10** Number Of Items: 0,  Common Name,  Scientific Name, List of results: Cilantro, Coriander, Chinese Parsley
- 11** View Item button

- 1 Type the **Name** of a plant that you would like to find.
- Specify the plant's **Common Name, Scientific Name**, or its **Variety Name**.
- A **Pronunciation** field is also provided. In the Plant Image Specification dialog, it is populated with a phonetic pronunciation guide for the plant's scientific name.
- 2 Check one or more boxes to indicate selected plant **Type** to search for.
- 3 Check one or more boxes to specify the selected **Sub-Type** to search for.
- 4 Specify the plant **Needs** to search for. These include the **Sun, Water, Soil pH**, and **Hardiness Zone** range. See "Hardiness Zones" on page 369.
- 5 **Flowers and Foliage** -
  - Specify the **Flower Color** to search for. Multiple colors can be selected.
  - Specify the **Leaf Color** to search for. Multiple colors can be selected.
  - Specify the **Bloom Time** to search for, which is the season when the plant produces flowers.
- 6 Specify the plant **Height** at maturity to search for. This is used with the Grow Plants feature. See "Plant Tools" on page 366.
  - An average mature height range can be entered using the **From** and **To** drop-down lists.
  - A specific **Height at Maturity** to search for can be entered in the text field.
  - A specific **Starting Age**, in months, can be entered in the text field.
  - A specific **Age at Maturity**, in months, can be entered in the text field.
- 7 Check one or more boxes to search for plants with **Special Characteristics**.
- 8 Select which types of plant **Object Type** to search for. 3D Plants are symbol objects, while Plant Images are two dimensional images.
- 9 Click the **Search** button at the bottom of the dialog to search for plants that meet your search criteria. The search results display to the right.
- 10 Your search results display here.
  - The **Number of Items** that match your search criteria is stated.
  - Specify whether you want the search results to use the **Common Name** or **Scientific Name**.
  - Click on the name of a plant in the list to see its location in the Library Browser.
- 11 Click the **View Item** button to see more information about the selected plant in the **Plant Information** dialog. See "Plant Image Specification Dialog" on page 369.



## Hardiness Zones



Select **Terrain> Plant> Show Hardiness Zones** to view a selection of regional **Hardiness Zone Maps**. Click the drop-down list at the top left to select various regions.

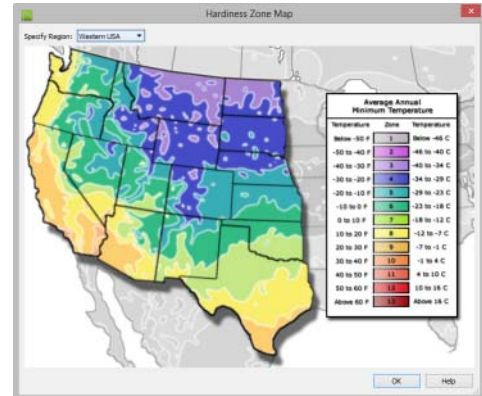

## Plant Image Specification Dialog



Select a plant in a floor plan or 3D view and click the **Open Object** edit button to open the **Plant Image Specification** dialog.

This dialog can also be accessed by selecting

**Terrain> Plant> Create Plant Image** .

The Plant Information and Plant Description panels are also found in the **Plant Information** dialog, which can be accessed from the **Plant Chooser** dialog. See “Plant Chooser Dialog” on page 367.

## Image Panel

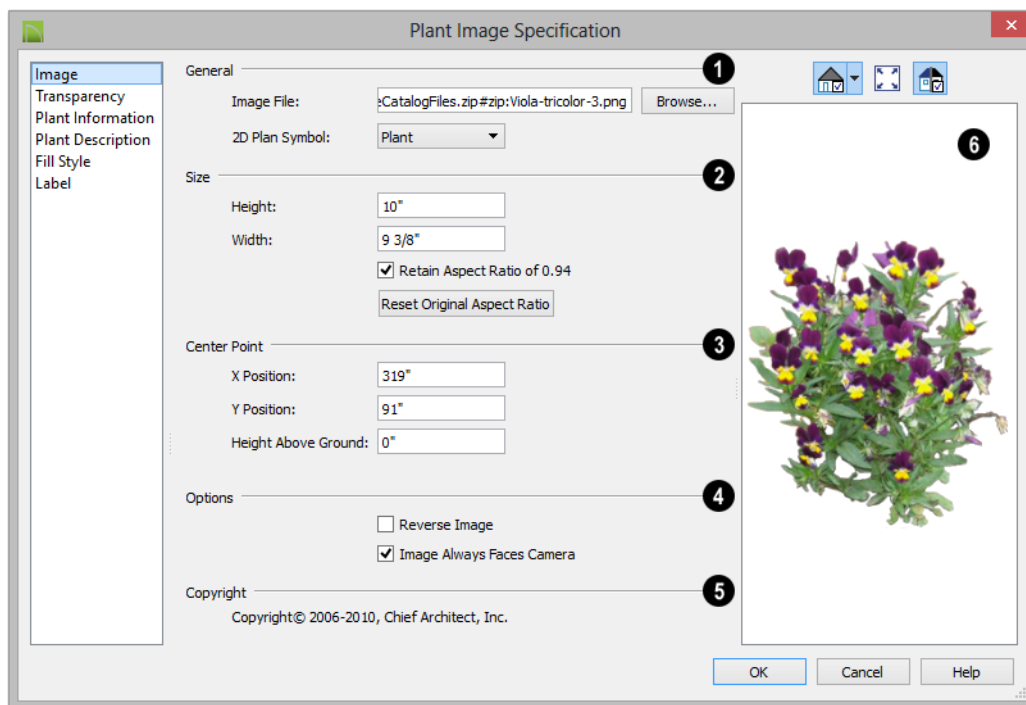

### 1 General -

- The path and name of the selected plant's **Image File** displays here.
- Click **Browse** to specify the saved location on your computer of the image that represents the plant in 3D views.
- A number of **2D Plant Symbols** are available to represent the image in floor plan view. Select one from the drop-down list.

### 2 Specify the **Size** of the plant image, as seen in 3D views.

- Enter a **Height** for the image.
- Enter a **Width** for the image.

- When **Retain Aspect Ratio of** is checked, if you change either the Height or Width, the other value changes to maintain this ratio. If this is unchecked and you resize the plant image, it may become distorted.
- Click **Reset Original Aspect Ratio of** to reset the image's original aspect ratio and remove any distortion caused by resizing.

### 3 Specify the location of the selected plant image's **Center Point**.

- Position the selected plant image in reference to the plan coordinates by specifying its **X Coordinate** and **Y Coordinate**.
- Specify the selected plant image's **Height Above Ground**.

**4** Options -

- Check **Reverse Image** to reflect the appearance of the image about an imaginary vertical line through its center.
- Check **Do not rotate in 3D view** to prevent the plant image from rotating with the camera.

**5** If the selected plant image has been copyrighted, its **Copyright Information** displays here.

**6** A preview of the selected sprinkler symbol displays here. The Glass House Rendering Technique is not available for plant images. See “Dialog Preview Panes” on page 32.

### Transparency Panel

The settings on the Transparency panel of this dialog are similar to those on the same panel of the **Image Specification** dialog. For

more information, see “Transparency Panel” on page 534.

### Plant Information Panel

The settings on the Plant Information panel correspond to the search parameters in the **Plant Chooser**. See “Plant Chooser Dialog” on page 367.

## Plant Description Panel

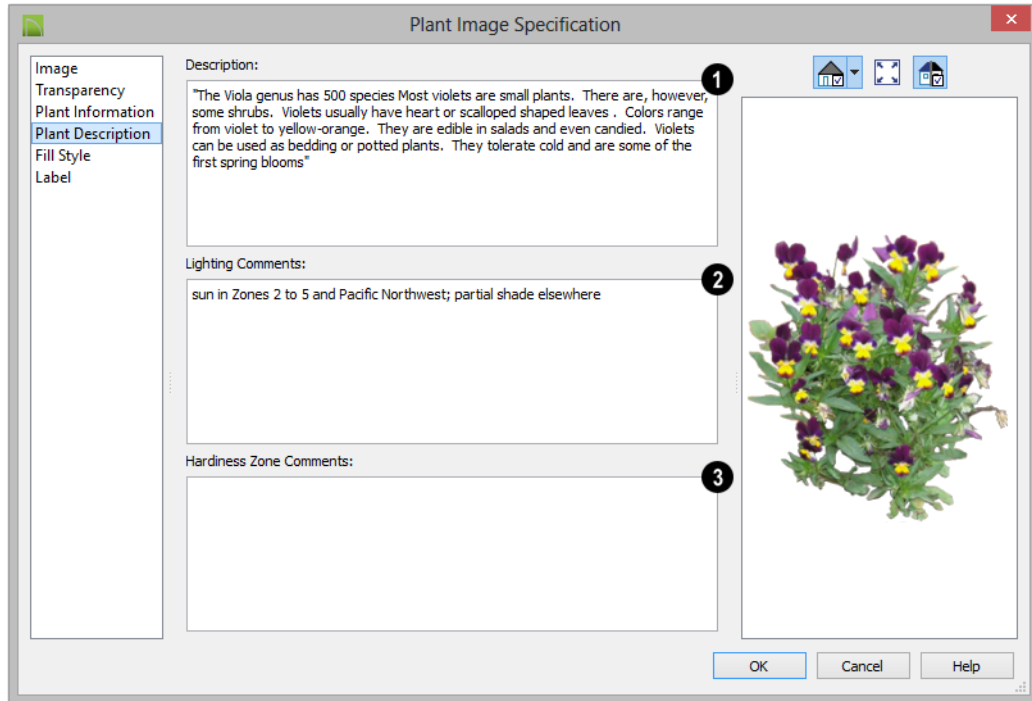

- 1 A detailed **Description** of the plant displays in this text field.
- 2 Information in the **Lighting Comments** fields describes the plant's light requirements.
- 3 **Hardiness Zone Comments** are given here. See "Hardiness Zones" on page 369.

### Fill Style Panel

The Fill Style panel controls the appearance of the selected plant's 2D Plant Symbol in floor plan view. By default, plant images' fill style is None (Transparent). For

information about the settings on this panel, see "Fill Style Panel" on page 519.

If the plant's 2D Plan Symbol does not form a closed shape, the settings on the Fill Style panel will have no effect on the appearance of the plant in floor plan view.

### Label Panel

Plant labels display in floor plan view when the "Plants, Labels" layer is turned on and use the Text Style assigned to that layer. See "Object Labels" on page 575.

For information about the settings on this panel, see "Label Panel" on page 576.

## Sprinkler Tools

 Use the **Sprinkler Tools** to design a sprinkler system in your plan.

 Select **Terrain> Sprinkler> Sprinkler Head** to open the **Select Library Object** dialog. Browse to a sprinkler type in the library, click OK, then click in the drawing area to place as many as you need. Once drawn, sprinkler heads can be selected and edited. See “Sprinkler Specification Dialog” on page 373.

 Select **Terrain> Sprinkler> Sprinkler Line** to draw sprinkler lines in your plan. Sprinkler lines are 2D objects and are drawn and edited much like CAD Lines. See “Draw Lines” on page 511.

 Select **Terrain> Sprinkler> Sprinkler Spline** to draw curved sprinkler lines in your plan. Sprinkler splines are 2D objects and are drawn and edited like CAD Splines. See “Draw Spline” on page 513.

### Displaying Sprinklers

The display of Sprinkler Heads, Lines and Splines can be controlled in the **Display Options** dialog. See “Displaying Objects” on page 76.

In floor plan view, Sprinkler Head symbols indicate the spray angle.

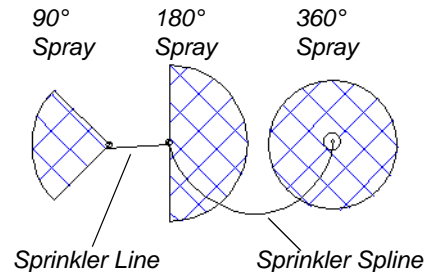

Sprinkler head display in 3D views; however, Sprinkler Lines and Splines do not.

Sprinkler Heads are counted in the Materials List, as is the total length of Sprinkler Lines and Splines. See “Materials Lists” on page 579.



### Editing Sprinklers

Sprinklers can be edited much the way other objects from the library can: using their edit handles, edit tools, and in their specification dialog. See “Editing Library Objects” on page 410.



The elevation of a sprinkler can be edited in elevation views.

## Sprinkler Specification Dialog

 To open the **Sprinkler Specification** dialog, select a sprinkler and click the **Open Object** edit button. You can also double-click the sprinkler using the **Select Objects**  tool.

This dialog an example of a **Symbol Object Specification** dialog. See “Symbol Object Specification Dialogs” on page 411.

## Plant Schedules



A Plant Schedule is a table that lists all of the plants in your plan and can include a variety of information about them, including quantities, common and scientific names, and growing needs. Schedules are dynamically linked to the plants in your plan and update as they are created, deleted, moved, or modified.

In floor plan view, select **Terrain> Plant>**

**Plant Schedule** , then click anywhere in the view to place a schedule at that location. You can continue clicking to place additional copies of the schedule. See “Click-to-Create” on page 82.

Schedules can be edited using the edit handles, the edit toolbar buttons, or the **Schedule Specification** dialog.

### Using the Edit Handles

A selected schedule has edit handles similar to those of a CAD box. See “Editing Box-Based Objects” on page 101.

In addition, schedules have edit handles that let you control column widths:

*Resize Column*

Plant Schedule		
Number	Qty	Common Names
P01	1	Mint
P02	1	Lavender
P04	1	Thyme



**Resize Column** edit handles are located in the Title row, centered on the grid lines that divide the columns, and can be dragged left or right. If a column is resized sufficiently small, the text within will wrap to multiple rows.

### In the Specification Dialog



The appearance and other attributes of schedules can be modified in the **Schedule Specification** dialog. See “Plant Schedule Specification Dialog” on page 375.

You can control how plants are listed in a schedule by specifying which Columns to Include in the schedule.

### Using the Edit Tools

A selected schedule or schedules can be edited in a variety of ways using the buttons on the edit toolbar. See “The Edit Toolbar” on page 28.

## Schedule Columns and Numbering

Every Plant Schedule has a selection of **Columns to Include** in of its **Schedule Specification** dialog.

### Columns and Quantity

It is important to remember that the number of columns you choose to include in a

schedule influences the number of separate line items that will be listed in the schedule. For example:

- If you were to uncheck “Common Names” and “Scientific Names” in the **Plant Schedule Specification** dialog, and then check “Flower Color”, the resulting schedule would list all red flowers in one line item, regardless of their species.
- If you have three paper birch trees in your plan and do not include columns that refer to the trees’ age, such as the Starting Age column, then the three trees will be listed in the same line item - even though one is young, one medium, and one adult.

### Schedule Numbering

Schedule numbering is dependent on the order in which objects are placed in the plan, as well as the floor they are on.

- Any objects present in your plan before a schedule is created will be listed first in

ascending alphanumeric order, according to their Label information.

- A new, unique objects placed in the plan after the schedule is created will be added to the bottom of the schedule in the order that they are placed, regardless of its Label information.

When an object is edited, its schedule number may or may not change:

- If an object with a Quantity of 1 in the schedule is edited, its position in the schedule will not change.
- If a group of objects listed on the same row in a schedule are edited simultaneously, their position will not change.
- If an object listed on the same row in a schedule with other similar objects is edited so that it is no longer similar enough to share the same row, it will move to the bottom of the schedule. See “Columns and Quantity” on page 374.

---

## Plant Schedule Specification Dialog



Plant Schedules can be edited in the **Plant Schedule Specification** dialog. To open this dialog, either select a plant schedule and click the **Open Object** edit

button or double-click the schedule using the **Select Objects**  tool.

## General Panel

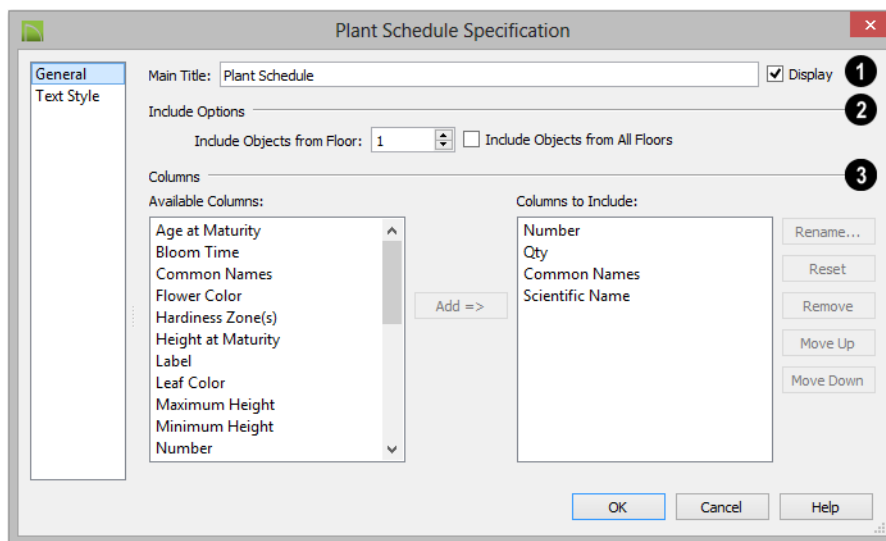

- 1 Specify a **Main Title** for the selected schedule.
  - Check **Display** to include the Main Title at the top of the schedule.
- 2 **Include Options** -
  - **Include Objects from Floor** - By default, only plants located on the floor that the selected schedule was created on will be included in it. You can specify a different floor to include objects from if you wish.
  - To create a schedule of plants on all floors, check **Include Objects from All Floors**.
- 3 Specify which **Columns** are included in the selected schedule. See “Columns and Quantity” on page 374.
  - An alphabetical list of all **Available Columns** displays on the left.
  - Select one or more names in the list, then click the **Add** button to add them to the Columns to Include list on the right. See “Shift and Ctrl Select” on page 89.
  - You can also double-click on an item in the list to add it to the Columns to Include list on the right.
  - A list of the **Columns to Include** in the selected schedule displays on the right. The top-to bottom order in this list corresponds to the columns’ left-to-right order in the schedule. At least one column must be included to create a schedule.
  - Select or double-click on an item in the list and click the **Rename** button to specify a new name.
  - Click the **Reset** button to restore the default names for all Columns to Include in the current schedule.



- Select one or more items in the list, then click the **Remove** button to remove those items from the list.
- Select one item in the list and click the **Move Up** button to adjust its position upward in the list.
- Select one item in the list and click the **Move Down** button to adjust its position downward in the list.

### **Text Style Panel**

The settings on this panel control the appearance of the selected schedule's text. For more information, see "Text Style Panel" on page 509.



# Other Objects

Home Designer Architectural has additional objects that can be used to customize your design.

## Chapter Contents

- General Shapes
- Soffits
- Special Applications for Soffits
- Soffit Specification Dialog

---

## General Shapes



Items in the Home Designer Core Catalogs> Shapes library catalog allow you to create a variety of custom objects using basic geometric shapes. These shapes can be used individually or

combined to create a wide variety of custom objects.

General Shape objects are placed and edited much like other library objects. See “Editing Box-Based Objects” on page 101.

---

## Soffits



Soffits typically fill the space between the tops of wall cabinets and the ceiling, but they are very versatile and can be used to create almost any other object that can be modeled as a 3D box. Select **Build> Cabinet> Soffit** to activate this tool.

## Soffit Defaults

The default settings for soffits are set in the **Soffit Defaults** dialog. The settings in this dialog are similar to those in the **Soffit Specification** dialog. See “Soffit Specification Dialog” on page 382.

For best results when placing soffits above wall cabinets:

- The default soffit should be the same width as and 1" (20mm) deeper than the default wall cabinet. See "Cabinet Defaults" on page 310.
- The default soffit **Floor to Bottom** value should equal the sum of the default wall cabinet's Floor to Bottom value plus its Height. See "General Panel" on page 383.
- The default soffit **Height** should be equal to or greater than the space between the ceiling and the top of the wall cabinets.

If the sum of the default soffit's Floor to Bottom value and Height is larger than the ceiling height of the room in which a soffit is placed, the Floor to Bottom value will be retained and its Height will be adjusted so that it fits under the ceiling.

The maximum soffit width is 250 feet (48m), and the minimum width is 1/16" (1 mm).

Once a soffit is placed in a plan, you can change its size and position to meet a variety of needs.

## Placing Soffits

Soffits can be created in both 2D and 3D views by simply clicking with the **Soffit**  tool active. See "Click-to-Create" on page 82.

They can be assigned materials that are calculated in the Materials List, but by default they use the material assigned to the default wall. See "Wall Defaults" on page 120.

When positioned against a wall in a room, soffits will display any moldings present in that room that are at the same height as the soffit. See "Moldings Panel" on page 177.

Like cabinets, soffits can also have custom molding profiles specified. See "Moldings Panel" on page 327.

To create a corner soffit, click as close to an inside wall corner as possible. A corner soffit retains its shape when it is moved, edited, or copied.

When a soffit is created, it is placed on the "Cabinets, Soffits" layer. See "Displaying Objects" on page 76.

---

## Special Applications for Soffits

Nearly any object with straight, flat sides can be represented by one or more Soffits. They can be resized to as small as 1/16" (1mm) per side, or as large as 250 feet (48m).

Soffits can have materials applied to them to represent simple mirrors, beams in exposed ceilings, posts, chimneys and so on. Following are some additional examples.

### Roof Beams and Coffered Ceilings

Sloped soffits can be used to represent beams or rafters that follow the pitch of the roof in rooms with cathedral ceilings. See "Sloped Soffits" on page 384.



Soffits can also be used to create coffered ceilings. They will display any moldings assigned to the room it is in that are at its height. In addition, you can assign moldings directly to a soffit in its specification dialog. See “Moldings Panel” on page 384.



### Accent Tiles

A material such as ceramic tile can be assigned to one or more soffits applied to the walls above tubs or in showers.



### Masonry Veneer

As an alternative to a pony wall, you can use a soffit to create a brick or stone veneer over part of a wall. Specify a soffit depth equal to the masonry material to be used.

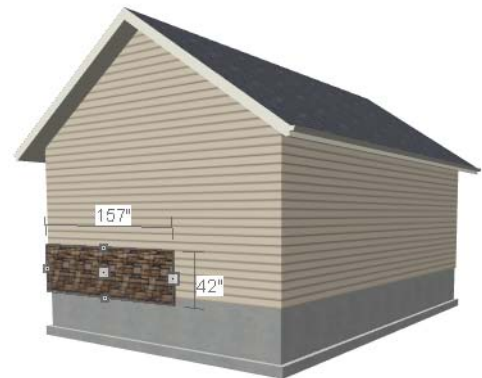

Soffits automatically stop at the floor platform when moved downward or at the ceiling platform when moved upward - even when the soffit is not located in a room. To move or resize a soffit through a floor or ceiling platform, select it and hold the Ctrl

key down while dragging its edit handles. See “Unrestricted Movement” on page 109.

## Calculating Materials on Soffits

By default, soffit materials are not calculated in the Materials List. In order for a soffit’s material to be counted, it must be edited so that it is not using the default material. See “Material Defaults” on page 416.

The number of bricks, tiles, shingles, shakes or other materials applied to a soffit is calculated using the following rules:

- If the soffit depth is less than the larger of 4 inches (10 mm) or 1 ½ times the material thickness, then only the front area of the soffit is used. Thus if a soffit is 48"x48"x4" thick, and the Dark Red brick material is used (3"x 8" with 3/8" mortar joint) the front of the soffit is 48"x48"=2304 square inches. Including the mortar joint, each brick requires 3 3/8" x 8 3/8" = 28.26 square inches. 2304 sq. in. divided by 28.26 sq. in. per brick gives 81.5 bricks.
- If the soffit depth is greater than both 4 inches (10 mm) and 1 ½ times the material thickness, then the surface areas of

the soffit back, sides and top are used in addition to the front, if these surfaces are not attached to a wall or other soffit.

However, only those portions of the sides, top and bottom remaining after subtracting twice the material thickness are used. So, for Dark Red brick, which has a depth of 4", the sides, top and bottom surface areas cannot contribute to the brick count unless the soffit depth is greater than 8 inches.

- If surface materials such as brick are applied to a large soffit, the soffit center is assumed to be hollow, with only a single layer of the material applied to each applicable face.
- For shingles and shakes, the overlap amount should be subtracted from the height, as opposed to brick or tile, where the joint width is added to the size.
- For materials in the area category, the soffit area calculation above is used, with the material thickness treated as zero.
- For materials in the volume, concrete or earth categories, the true volume of the soffit is used.

---

## Soffit Specification Dialog



To open the **Soffit Specification** dialog, select the soffit and click the **Open Object** edit button or double-click on a soffit using the **Soffit**  tool.

The settings in this dialog are similar to those in the **Soffit Defaults** dialog, but affect only the selected object(s).

### General Panel

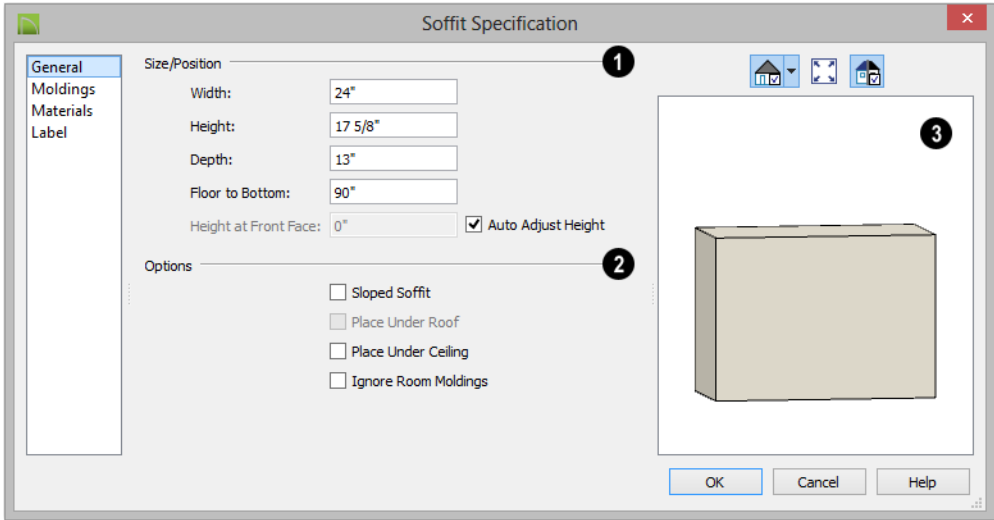

- 1** Define the **Size** and **Position** of the selected soffit relative to the floor or terrain.

  - Specify the **Width** of the soffit.
  - Define the vertical **Height** of the soffit.
  - **Depth** - Define the distance between the front and the back of the soffit. When selected in floor plan view, the front of a soffit has a “V,” and the back of the soffit has a triangular rotation handle.
  - If the selected soffit is a corner soffit, the **Width** controls its left side width, and **Depth** controls its right side width.
  - **Floor to Bottom** - Specify the distance from the bottom of the soffit to the floor. This is sometimes more easily done by positioning the soffit in a 3D view.
  - **Height at Front** applies to sloped soffits and becomes enabled when Sloped Soffit is checked. See “Sloped Soffits” on page 384.
- When the selected soffit is outside a room and **Auto Adjust Height** is checked, its **Floor to Bottom** height is measured relative to the terrain height. When this is unchecked, the **Floor to Bottom** height is measured from the default floor height of Floor 1. See “Terrain Height vs Floor Height” on page 334 of the Reference Manual.
- 2** **Options** - Specify a sloped soffit and/or position relative to the roof or ceiling.

  - Check **Sloped Soffit** to slope the soffit vertically from the back up towards the front. When you specify a soffit as sloped, the options on the GENERAL panel change. See “Sloped Soffits” on page 384.
  - Check **Place Under Roof** to have the soffit’s slope follow that of the roof. The soffit moves up and the top of the soffit is in the same plane as the roof, at the same pitch as the roof. Be sure to place the

front of the soffit toward the high side of the roof. Only available when **Sloped Soffit** is checked. Not available in the **Soffit Defaults** dialog.

- Check **Place Under Ceiling** to move the soffit vertically until the top contacts the ceiling plane. Not available in the **Soffit Defaults** dialog.

Check **Ignore Room Moldings** to prevent the selected soffit from displaying moldings assigned to the room that it is placed in. See “Special Applications for Soffits” on page 380.

- 3 A preview of the soffit displays on the right side of the dialog box. See “Dialog Preview Panes” on page 32.

## Moldings Panel

For information about the settings on this panel, see “Moldings Panel” on page 327.

## Sloped Soffits

When a soffit is specified as a sloped soffit, the options on the **GENERAL** panel of the **Soffit Specification** dialog change.

## Materials Panel

Soffits are not calculated in the Materials List unless a non-default material is specified. See “Calculating Materials on Soffits” on page 382.

For information about the settings on this panel, see “Materials Panel” on page 420.

## Label Panel

Soffit labels display in floor plan view when the “Cabinets, Labels” layer is turned on and use the Text Style assigned to that layer. The Automatic Label for Soffits is blank, but you can specify a custom label.

For more information about the settings on this panel, see “Label Panel” on page 576.



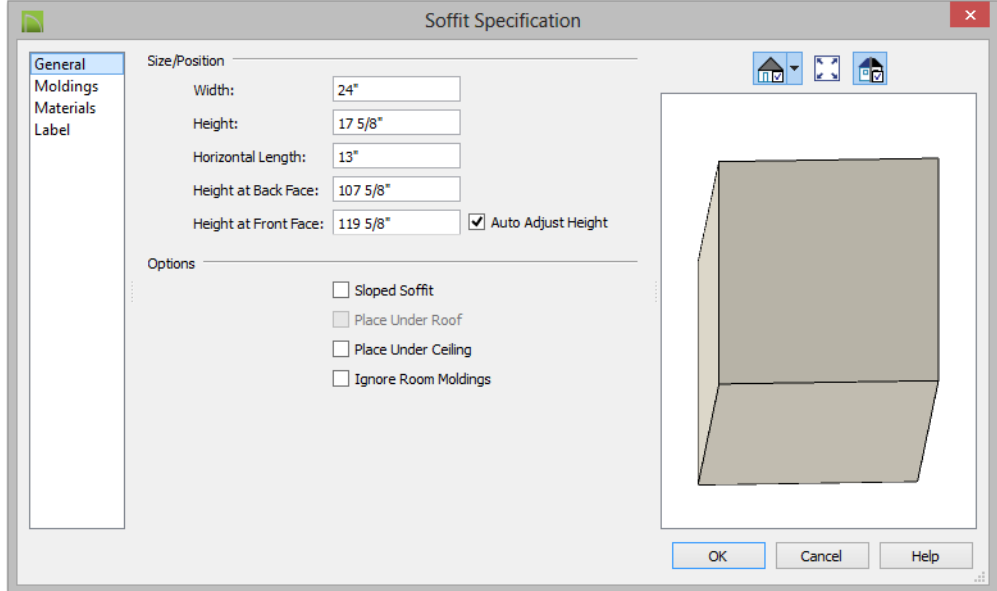

- **Width** is measured left to right across the soffit, parallel to the front of the soffit.
  - **Thickness** is measured perpendicular to the slope of the soffit.
  - **Horizontal Length** is measured from back to front in floor plan view. Since the soffit is sloped, this measurement is not the actual length of the soffit. It cannot, for example, be used to determine the length of a sloped beam.
- Both the front and back heights of a sloped soffit must be defined.
- **Height at Back** is measured from the finished floor to the lowest point at the back of the soffit.
  - **Height at Front** is measured from the finished floor to the underside of the soffit at the upper end.



# Architectural Blocks

A selection of pre-arranged rooms library catalogs is available for download. These pre-arranged rooms are a collection of fixtures, furnishings and accessories that are grouped together so that they can be placed and moved as a single object. See “Downloading Library Content” on page 400.

3D objects that are grouped together like this are referred to as Architectural Blocks. Although blocked together, these objects

retain many of their own attributes, such as materials.

Architectural blocks can also be exploded so that the individual sub-objects become independent of one another.

## Chapter Contents

- Creating Architectural Blocks
- Displaying Architectural Blocks
- Editing Architectural Blocks
- Architectural Block Specification Dialog

---

## Creating Architectural Blocks



An architectural block is created by group-selecting multiple architectural objects and then clicking the **Make Architectural Block** edit button. Architectural blocks can be created in any view.

The following is a list of objects that can be included in architectural blocks:

- Cabinets (Base, Wall, Full Height)
- Custom Countertops
- Soffits, Shelves, Partitions
- Fixture and Furniture symbols

- Hardware symbols
- Millwork symbols
- Geometric Shapes
- Electrical objects
- Images

- Slabs and Foundation Slabs
- Roads, Driveways, Sidewalks
- Terrain Features and Terrain Modifiers

Once blocked, the set of blocked objects is contained in a bounding box, indicating that they are now an architectural block.

## Displaying Architectural Blocks



As with individual objects, the display of architectural blocks is controlled in the **Display Options** dialog. See “Displaying Objects” on page 76.

- If an architectural block is composed of objects that are on the same layer, the block will be placed on that layer, as well.
- If an architectural block is composed of objects on different layers, the block will be placed on the “Architectural Blocks” layer.

### In Floor Plan View

You can control the appearance of the bounding box by changing the display properties of the architectural block’s layer or you can turn off its display in the **Architectural Block Specification** dialog. See “General Panel” on page 390.

You can select an architectural block and click the **Move to Front of Group**  edit button to make that block display in front of other objects in the same drawing group, including cabinets and some library symbols. See “Move to Front of Group” on page 108.

### Architectural Block Labels

Architectural blocks can display labels for both the block and any component objects that have labels in floor plan view. Labels for architectural blocks are placed on the “Architectural Blocks, Labels” layer and use the Text Style assigned to that layer. See “Object Labels” on page 575.

The label for an architectural block can be generated automatically, user-specified, or suppressed. See “Label Panel” on page 576.

## Editing Architectural Blocks

Architectural blocks can be selected and edited in 2D and 3D views. See “Selecting Objects” on page 88.

**Note:** Moving an architectural block in 3D view regenerates the view. If the architectural block contains terrain objects, the terrain is rebuilt.

Once selected, an architectural block can be edited using its edit handles, edit toolbar buttons, and specification dialog. See “Architectural Block Specification Dialog” on page 390.

### Using the Edit Handles

A selected architectural block displays a Move handle and a Rotate handle.

Architectural blocks cannot be resized, but the individual objects in the block can be.

### In the Specification Dialog



Architectural blocks can be edited in their specification dialog.

## Using the Edit Tools

A selected architectural block or blocks can be edited in a variety of ways using the buttons on the edit toolbar. See “The Edit Toolbar” on page 28.

## Editing Sub-Objects

The individual objects included in an architectural block can also be selected and edited. See “To select a sub-object” on page 391.

## Explode Architectural Block



You can break an architectural block to make its objects independent.

Select the architectural block and click the **Explode Architectural Block** edit button.

Note: If you open a plan created in another version of Home Designer and an architectural block includes an object that you cannot create in your version of the software, you cannot unblock it or edit its components.

## Adding Architectural Blocks to the Library



You can create your own architectural blocks and save them in the library. See “Add to Library” on page 402.

---

## Architectural Block Specification Dialog

The **Architectural Block Specification** dialog controls the way architectural blocks display in floor plan view and in materials lists.

Select an architectural block and click the **Open Object**  edit button to open this dialog.

### General Panel

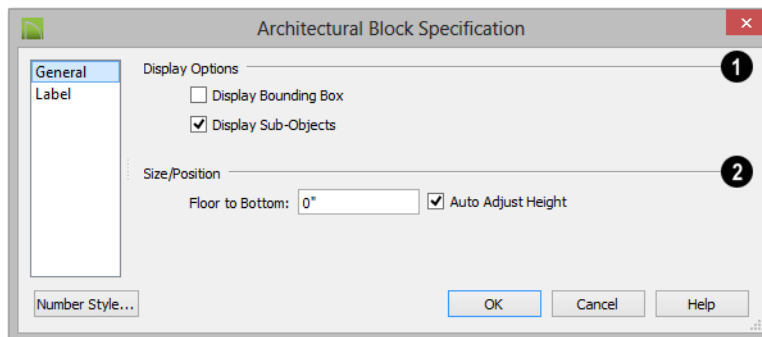

**1** The **Display Options** control the appearance of the selected architectural

block in floor plan view. See “Displaying Architectural Blocks” on page 389.

- Check **Display Bounding Box** to show the bounding box of the objects in the architectural block.
  - Uncheck **Display Sub-Objects** to suppress the display of the sub-objects and display only the bounding box. If Display Bounding Box is unchecked, it will become checked.
- 2** Specify the selected architectural block's **Size/Position** relative to the floor or terrain. Not available if the selected block includes any objects that do not have these settings in their specification dialogs.
- Select the Elevation Reference from the drop-down list. This determines where the next two settings are measured from and also affects their setting labels.
  - Specify the height **to Top**, measured from the selected Elevation Reference to the top of the architectural block.
  - Specify the height **to Bottom**, measured from the selected Elevation Reference to the bottom of the architectural block.

## Label Panel

Labels for Architectural Blocks display in floor plan view when the “Architectural Blocks, Labels” layer is turned on and use the Text Style assigned to that layer. See “Architectural Block Labels” on page 389.

The LABEL panel is available for a variety of different objects. For more information, see “Label Panel” on page 576.

---



## Architectural Blocks and Sub-Objects

An architectural block is composed of a group of sub-objects that have been blocked together. For example, a kitchen island architectural block may consist of cabinets, appliances, a custom countertop, and other accessories.



Each of the sub-objects in an architectural block may contain additional parts called components. The cabinets in a kitchen island, for example, may contain handles, hinges, and drawer glide.

### Sub-Objects

Certain attributes of an architectural block can be edited at the sub-object level. A sub-object can be edited by accessing its specification dialog in either of two ways:

- Explode the architectural block, select the sub-object, and click the **Open Object**  edit button.
- Select the sub-object while it is part of the architectural block and click the **Open Object**  edit button. Some attributes may not be editable while the object is part of a block. See “Editing Architectural Blocks” on page 389.

#### *To select a sub-object*

1. Click the **Select Objects**  button, then click on the sub-object that you would like to edit.
2. With the architectural block selected, click the **Select Next Object**  edit button or press the Tab key.

The selection switches to the individual object and it can be edited using its edit handles, edit toolbar and specification dialog.

The options for editing a sub-object may be more restricted than if the object were

independent. If more extensive editing is required, the architectural block must be exploded.



# The Library

Home Designer Architectural's library offers thousands of symbols, materials, and images that can enhance any plan.

New library catalogs and enhancements are made available by Chief Architect on a continuing basis and are available for download for the current program version.

You can also customize items from the library or import new items from outside the program and then save them in the library for future use.



## Chapter Contents

- The Library Browser
- Searching the Library
- Library Content
- Downloading Library Content
- Importing Library Catalogs
- Adding Library Content
- Organizing the Library
- Exporting Library Catalogs
- Placing Library Objects
- Select Library Object Dialog
- Replace From Library
- Displaying Library Objects
- Editing Library Objects
- Symbol Object Specification Dialogs

## The Library Browser

 The Home Designer Architectural Library Browser allows you to manage the contents of the library as well as add library content to your drawings.

### To open the Library Browser:

- Select **View > Library Browser** .
- Click the **Library Browser** button .
- Press **Ctrl + L** on your keyboard.

By default, the Library Browser is docked to the right side of the program window, but can be undocked or docked to another side. See “Docking the Library Browser” on page 397.

The Library Browser has four sections:

- The search options at the top.
- The Directory and Search Results Pane.
- The Selection Pane.
- The Preview Pane.

To adjust the height or width of a section, place the pointer over the split bar you want to move. When the double-headed arrow  $\leftrightarrow$  displays, click and drag.



You can control the configuration of the Library Browser panes in the Preferences dialog. See “Library Browser Panel” on page 64.

You can work on your drawing with the Library Browser open. To close the Browser, click the Close  button or double-click on an object in the Selection Pane.

The library directory is presented in a tree list with five categories: Home Designer Core

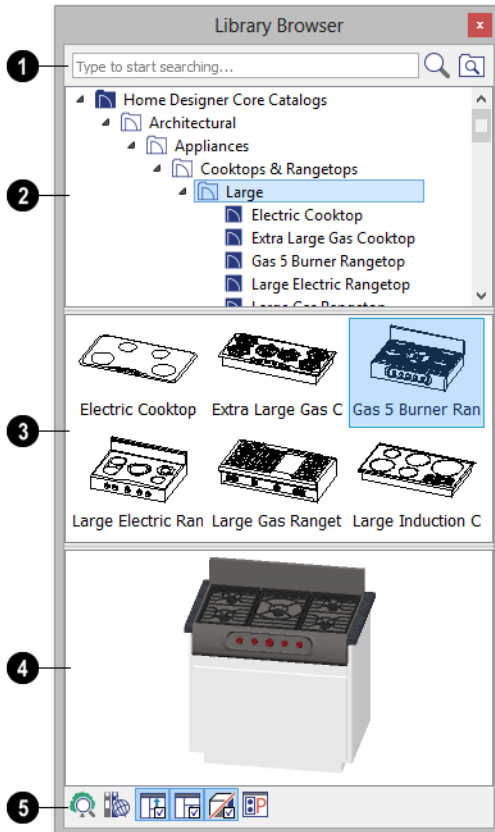

Catalogs, Home Designer Bonus Catalogs, Manufacturer Catalogs, User Catalog and Trash. See “Library Content” on page 398.



**1** Search the library using keywords and optional search filters. See “Searching the Library” on page 397.

- Begin typing in the text field to search for library items. As you type, search results will display in the Directory Pane.
- Right-click on an item in the Search Results list and select **Show in Browser**

to view the item's location in the Directory list.

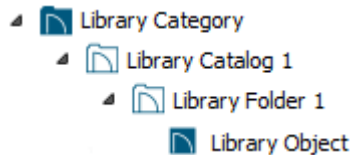

- Click the **Browse**  button to stop searching and restore the Directory list.
- Click the **Search**  button to display the search results for your search entry.
- Click the **Search Filtering Options**  button to customize your search parameters. If the Library Browser is resized so that it is narrow, this button will be replaced by two arrows.

- 2** The library **Directory** and **Search Results** display here. The basic structure of the directory tree is:



Library items are always placed in alphabetical order within their hierarchy.

The Library Browser includes a Trash bin, where deleted items are moved until you choose to Empty Trash. See “Deleting Library Items” on page 405.

Navigate the Directory Pane using the mouse. Click the gray Expand arrow  beside a catalog or folder to display its contents. Once expanded, you can click the black Collapse arrow  to close it again. You can also browse the list using the arrow keys on your keyboard.

Click on an item to select it. Preview images display in the Selection and Preview Panes and basic information about it also displays

in the program's Status Bar. See “The Status Bar” on page 33.

- 3** The **Selection Pane** shows a thumbnail image of the item selected in the Directory Pane.

When an item is selected in the Directory Pane, a basic line-based representation of the item displays in the Selection Pane.

- If the selected item is a single object, a preview of that object displays in the Preview Pane. You can move your cursor into the drawing area to place the item. See “Placing Library Objects” on page 406.
- If the selected item is a folder, a thumbnail image displays, representing each item inside. Move your pointer over an item in this pane to see a Tool Tip with the item's name. Click on a folder in the Selection Pane to display its contents here and make it the item selected in the Directory Pane.
- Some folders may have too many items to display useful thumbnails for each; when this is the case, they do not display.

Click the **Show/Hide Selection Pane**  button to toggle the Selection Pane on and off.

- 4** When an individual item is selected in either the Directory or Selection Pane, an image of it displays in the **Preview Pane**. If the item is designed to be inserted into another object such as a cabinet, that parent object will also display in the preview.

You can click the **Toggle Preview Display**  button at the bottom of the browser

window to switch between preview images in Standard Render and Vector View styles.

If the selected object is a 3D symbol, you can rotate and zoom in or out on the Preview using the mouse.

If you have rotated a view in the Preview Pane, you can restore the default angle either by clicking in the Selection Pane or by right-clicking on the Preview Pane and selecting **Reset Preview**.

Click the **Show/Hide Preview Pane**  button to toggle the Preview Pane on and off.

**5** The toolbar at the bottom of the browser aids in searching, displaying panes, and managing library content.

 Click the **Plant Chooser** button to open the **Plant Chooser** dialog. See “Plant Chooser Dialog” on page 367.

 Click the **Get Additional Online Content** button to launch your default web browser to the Home Designer Architectural web site, where additional library content is available for download.

 Click the **Show/Hide Selection Pane** button to toggle the Selection Pane on and off.

 Click the **Show/Hide Preview Pane** button to toggle the Preview Pane on and off.

 Click the **Toggle Preview Display** button to switch between high and low detail images of a selected library object in the Preview Pane.

 Click the **Preferences** button at the bottom of the Library Browser to open the **Preferences** dialog, where display

properties for the Library Browser can be controlled. See “Library Browser Panel” on page 64.

## Using the Contextual Menus

A number of important library functions can be accessed using the contextual menus. Right-click on an item in the Library Browser to open a contextual menu displaying options related to that item. See Contextual Menus.

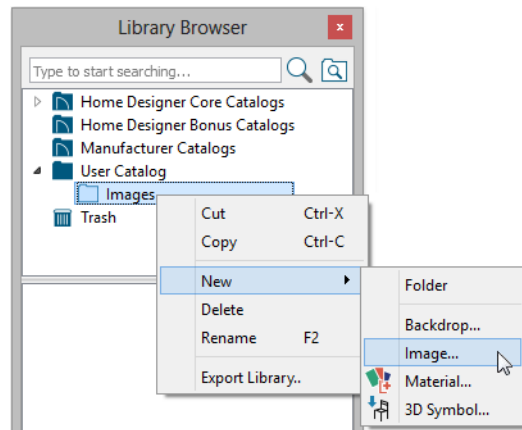

The options in the contextual menu vary depending on the item selected, but may include:

- Cut/Copy/Paste
- Paste Shortcut
- New
- Rename
- Delete
- Export Library
- Open Object
- Reset Preview
- Expand All/Collapse All

- Show in Browser

## Keyboard Commands

The Library Browser can be navigated using the arrow keys on your keyboard.

- The right and left arrow keys expand and collapse folders.
- The up and down keys change which library object is currently selected.
- Select an item and press F2 to rename it.
- Select an item and press the Delete key to delete it.

## Expand/Collapse All

When a library category or folder is selected in the Directory Pane, **Expand All** and **Collapse All** are available in the contextual menu, allowing you to expand or contract its contents in the tree view.

## Docking the Library Browser

Initially, the Library Browser side window is docked to the right side of the main Home



Designer Architectural program window. To undock it, click and drag its title bar towards the center of the program window. Once undocked, it can be moved and redocked in the same manner. See “Side Windows” on page 27.

When moved to the top, bottom, or side of the program window, it automatically docks in a vertical or horizontal orientation, depending on its location. You can prevent the Library Browser from docking by holding down the **Ctrl** key while dragging it.

To return the Library Browser to its original position and size, click the **Restore Position/Size** button in the **Preferences** dialog. See “Reset Options Panel” on page 69.

## Closing the Library Browser

The Library Browser can be closed in either of two ways:



- Click the **Close**  button at the top right corner of the browser window.
- Select **View > Library Browser** .

---

## Searching the Library

The Library Browser filtering options let you focus your searches to meet parameters that you define.

### *To search the Library Browser*

1. Select **View > Library Browser**  and click in the Search field at the top of the Library Browser.
2. Begin typing a keyword to search for. As you type, the search results will populate in the Directory Pane below.
3. You can click the **Clear**  button on the right side of the Search field to remove anything typed in this field.
4. If you move your mouse pointer over the Search field, a Tool Tip will state the number of results of your search.

5. Right-click on an item in the Search Results list and select **Show in Browser** to view the item's location in the Directory list.

Substrings are not included. For example, searching for "windows" will not produce "window" as a search result. On the other hand, searching for "window" will produce "windows" as a search result.

### *To search using custom filters*

1. Click the **Turn on search filtering options**  button.
  - Check **Keyword** to match the entered search keyword with an object's search attributes.
  - Check **Entire Word** to match the entire keyword or words with the complete name of the object.
  - Check **Folders** to include library folders in your search.

2. Click the arrow beside **Type**, **Style**, or **Manufacturer** to expand that category.
  - Check the box beside one or more **Type** of library item that you want to include in your search.
  - Check the box beside one or more architectural or design **Style** to include items of that style in your search.
  - Check the box beside one or more **Manufacturer** to include in your search. Manufacturer catalogs that were imported during the current program session will not be listed here until you exit out of and restart Home Designer Architectural.



To save time, check the box beside Type, Style, or Manufacturer to select all of the options in that category at once; uncheck the box to deselect all of the options.

3. Type a keyword in the **Search** field. The results will be filtered to match your selected filtering options.

---

## Library Content

The Home Designer Architectural library has five categories: Home Designer Core Catalogs, Home Designer Bonus Catalogs, Manufacturer Catalogs, User Catalog and Trash. See Getting Started Guide, "Deleting Library Items" on page 405.

### Home Designer Core Catalogs

The Home Designer Core Catalogs category contains a wide selection of 3D symbols, images, and materials. When you install the

program from DVD, this library content will also be installed; if you download the software, you will be able to download the Core Catalogs separately, after the program is installed.

When you launch the program for the first time, it will ask if you want to download the Core Catalogs. Click Yes to begin the download. If you click No, you can download at any time by selecting **Library> Install Core Content** from the menu.

## Home Designer Bonus Catalogs

Chief Architect regularly posts new library catalogs available for download. Select **Library> Get Additional Content**

**Online**  from the menu to access the bonus catalogs and content.

Most Bonus Catalogs can be purchased for a nominal fee, while others are available free of charge. In addition, some Bonus Catalogs are only available to Chief Architect Support and Software Assurance program members.

## Manufacturer Catalogs

A variety of name brand library catalogs is available for download on the Home Designer web site with content ranging from materials to fixtures.

Select **Library> Get Additional Content**

**Online**  to access these Manufacturer Catalogs.

As with the Bonus Catalogs, some Manufacturer Catalogs are available free of charge while others can be purchased, and some are available for Support and Software Assurance members only.

Note: Support and Software Assurance is an optional program for holders of Chief Architect Premier and Chief Architect Interiors software licenses and is not available for Home Designer licenses.

## The User Catalog

The User Catalog is the location for items that you add to the library either from a

drawing or by importing. See “Adding Library Content” on page 402.

You can create and organize custom library folders and imported items such as symbols, images, backdrops, and materials. See “Organizing the Library” on page 403.

## Updating Library Catalogs

The Home Designer Core Catalogs, Bonus Catalogs, and Manufacturer Catalogs are updated periodically to include new and improved content. You can update your installed catalogs to include the latest content by selecting **Library> Update Library Catalogs** at any time.

The program will gather information about the content in each of these three categories, and then download and replace any content that is not up to date, and you may see a progress indicator at the bottom of the Library Browser while it is doing so. See “Download Progress” on page 400.

## Backing up Library Content

The Home Designer Architectural User Catalog File, `User_Library.calib`, is located in the Home Designer Architectural 2017 Data folder. See “Home Designer Architectural Data” on page 43.

The best way to back up your custom library content is to export the items in your User Catalog, as this will ensure that the textures used by custom materials or imported symbols are not lost. See “Backing Up Your Files” on page 48.

Exported libraries use the **.calibz** file format: a zipped file type that can include textures and images along with other library data.

### *To back up your custom library content*

1. Launch Home Designer Architectural and select **View> Library Browser**  from the menu.
2. Right-click on a folder or item in the User Catalog.
3. Select **Export Library** from the contextual menu.
4. The **Export Library Data** dialog is a typical Save dialog. See “Exporting Files” on page 47.
  - Notice that the file type in the Save as type field is “Library File with Textures/Images (\*.calibz)”.

---

## Downloading Library Content

The Home Designer Core Catalogs, Home Designer Bonus Catalogs, Manufacturer Catalogs are all available for internet download.

### Core Catalogs

When you launch Home Designer Architectural for the first time, you will be asked if you want to download the Core Catalogs. Click Yes to begin the download.

If you click No, you can download at any time by selecting **Library> Install Core Content** from the menu.

### Bonus and Manufacturer Catalogs

Bonus and Manufacturer Catalogs can be downloaded from our web site, [www.homedesignersoftware.com](http://www.homedesignersoftware.com). Select **Library> Get Additional Content**

**Online**  to launch your default internet browser to our Content Resources page.

### Download Progress

When library content is downloading, a green progress bar will display at the bottom

of the Library Browser. If you choose to download the Core Catalogs while the library is not open, the Browser will open so the progress indicator can display.

Click on the progress bar to display the name of the current file being downloaded, the total amount of data to be downloaded in KB, and the amount downloaded so far.

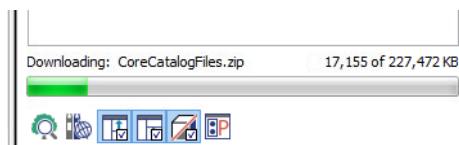

### Pausing and Resuming

Library downloads can only take place while Home Designer Architectural is running. If you close the program while a download is in progress, a dialog will confirm whether you wish to stop the download.

- Click **Stop Download and Close Program** to stop the download and close the program.
- Click **Cancel** to leave the program open and continue downloading.



Most catalogs are composed of a single file. If you stop the download midway, none of the downloaded data will be retained.

The Core Catalogs, on the other hand, contain a large volume of data saved in multiple files. If you close the program and stop the Core Catalogs download midway, only data associated with the file currently being downloaded will be lost. You can resume the download beginning with that file

at a later time by selecting **Library> Install Core Content**.

## Download Errors

If any problems occur during the library download process, a dialog box will notify you at the end of the download. Click **Retry Download** to repeat the download and correct any errors or click **Cancel** to discard the downloaded catalog.

---

## Importing Library Catalogs

Home Designer Architectural library files have two different file extensions: **.calib** and **.calibz**. Both files can include any combination of Home Designer Architectural library items; in addition, **.calibz** files are able to save data associated with textures and images. Both file types can be imported into the Home Designer Architectural library.

There are several ways to import a **.calib** or **.calibz** file into the program library:

- Double-click on the file in an operating system window while a plan file is open.
- Drag the file from an operating system window and drop it into the Home Designer Architectural program window.
- Select **Library> Import Library** from the program menu.

Note: Library files cannot be imported if no plan file is open, or when a Materials List window is active.

### *To import library files into the library*

1. Select **Library> Import Library** to display the **Import Library Data** dialog.

2. Browse to the **.calib** or **.calibz** file that you want to import and select the files so that its name displays in the **File Name** field.
3. Click the **Open** button.
4. A progress bar will display, telling you the progress of each library data file as it is imported. Once imported, each file will be located in the User Catalog.

When a **.calib** or **.calibz** file is imported into the program, its contents are automatically placed in the User Catalog. Any images or textures saved in a **.calibz** file will be copied into the Home Designer Architectural 2017 Data\ Images and Textures folders for backup purposes. The program will only reference these copies if it cannot locate the files in their original locations. See “Home Designer Architectural Data” on page 43.

## Legacy Library Conversion

You can import **.calib** and **.calibz** files created in Home Designer versions 2012, 10, or 9 for use in version 2017 at any time. See “Exporting Library Catalogs” on page 406.

Note: Library content exported from Home Designer Architectural 10 will not include catalog names. Any subscribed content from version 10 that has not been downloaded will not be included, either.

In addition, legacy **.alb** files created in Home Designer versions 8.0 and prior can be converted for use in version 2017.

### *To convert legacy library files*

1. Select **Library > Convert Legacy (.alb) Library Files**.

2. In the **Select a Legacy Library File Folder** dialog, select an **.alb** file that you want to bring in to Home Designer Architectural 2017.
3. The selected file's name will display in the **File name:** field.
4. Click the **Open** button to import the prior version third party **.alb** file into the User Catalog.
5. Organize the imported content to suit your needs. See "Organizing the Library" on page 403.

---

## Adding Library Content

In addition to downloading Home Designer Architectural Content and importing entire catalogs into the library, you can also add a variety of individual objects to the library.

### **Add to Library**

Nearly any object imported into a plan or placed from the Library Browser can be added to the User Catalog in the library.

- Check **Add to Library** in the **Import 3D Symbol** dialog. See "Importing 3D Symbols" on page 556.
- Select an object in your plan and click the **Add to Library**  edit button.

A few objects cannot be added to the library: notably terrain objects, CAD objects, imported pictures, metafiles, and PDF files.

Any object created using a drawing tool in Home Designer Architectural will automatically be added to the User Catalog using the

name of that tool, whereas a symbol will automatically use the Symbol Name. See "Native Objects vs Symbols" on page 410.

Once added to the library, objects in the User Catalog can be renamed. See "Renaming Library Items" on page 404.

### **Adding Materials and Images**

New materials, images, and plant images can be created in the User Catalog. Right-click on the User Catalog or a folder within it, select **New >** from the contextual menu, then select the type of item you wish to create from the submenu.

Home Designer Architectural can use materials and images in a variety of file formats and provides several means of adding new material and image files to the library. For more information, see "Creating Materials" on page 424 and "To create an image in the Library Browser" on page 531.

## Adding New Backdrops

A backdrop is an image, typically of an exterior view, that displays in the background of 3D views to help place the model into a realistic setting and add a sense of perspective. See “3D Backdrops” on page 542.



A new backdrop image can be created using a variety of graphic file formats and can be imported into Home Designer Architectural in several ways:

- Select **File> Import> Backdrop**  to open the **Import Backdrop File** dialog, which is similar to the **Import Picture File** dialog. See “Importing Pictures” on page 536.
- Right-click on the User Catalog and select **New> Backdrop** from the contextual menu.
- Copy and paste an image into Home Designer Architectural. See “Copying and Pasting Objects” on page 83.

## Creating a Customized Library Item

You can customize an existing library object and save your changes for future use by first copying the item into an unlocked library.

### *To customize a library object*

1. Right-click on a library item and select **Copy**  from the contextual menu.
2. Browse to the User Catalog or a folder within it and right-click on it.
3. Select **Paste** from the contextual menu to make a copy of the library item in this new location.
4. Right-click on the copied item and select **Open**  from the menu.
5. The item’s specification dialog opens, and you can make any changes that you wish to the item.
6. Make any needed changes to the item, then click OK. Your changes will be saved with this item for use in any plan.

---

## Organizing the Library

Library folders and objects can be copied, pasted, moved, and deleted: allowing you to organize your User Catalog to best suit your work style and needs.

### Adding New Folders

New folders can be added to the User Catalog or to any folder located within it. To add a new folder, right-click on User Catalog or one of its sub-folders and select **New> Folder** from the contextual menu.

The new folder is created inside the library item you right-clicked on and is initially named “Untitled”. Type a short, descriptive name and press Enter.

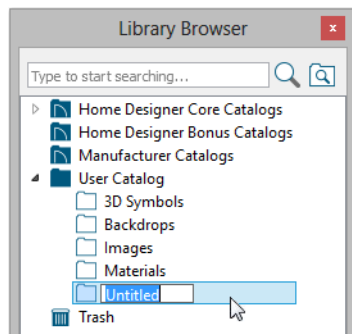

## Selecting Library Items

To select a library object, folder, or category, simply click on it.

When an item is selected, preview images display in the Selection and Preview Panes and basic information about it also displays in the program's Status Bar. See "The Status Bar" on page 33.

A selected library item can be modified in a number of ways to help meet your organizational needs.

## Renaming Library Items

Only folders and objects in the User Catalog can be renamed. There are several ways to do this from the tree list:

- Right-click on the item, select **Rename** from the contextual menu, and type a new name.
- Click once on the item, press F2 on your keyboard and type a new name.
- Click once on the item, pause for a moment, then click a second time and type a new name.

Library names are case-sensitive and can contain up to 63 characters. While you can

have more than one library item that uses the same name, it is best to use short, descriptive and unique names.

## Moving Library Items

Folders and objects in the User Catalog can be moved to new locations within the User Catalog. Folders and library objects are always organized alphabetically within each hierarchy.

To move an item to a different location, select it in the tree list, then click and drag it to the new location in the list. Directories and folders able to accept new content highlight as your mouse pointer moves over them. Release the mouse button to relocate the selected library item in the highlighted location.

You can also cut a library item from one location and paste it in another. When an item is cut, it is removed from its current location and saved to the system clipboard. To cut an item:

- Right-click on it and select **Cut** from the contextual menu.
- Click on the library item and press Ctrl + X on your keyboard.

To **Paste** the item, click on a library catalog or folder in the Library Browser tree view and either:

- Right-click on the new location and select **Paste** from the contextual menu.
- Press Ctrl + V on your keyboard.

## Copying Library Items

All library folders and library objects can be copied and pasted to new locations in the User Catalog.

There are two ways to copy a library item to the system clipboard:

- Right-click on it and select **Copy** from the contextual menu.
- Click on the library item and press Ctrl + C on your keyboard.

To **Paste** the item, click on a library catalog or folder in the Library Browser tree view and either:

- Right-click on the new location and select **Paste** from the contextual menu.
- Press Ctrl + V on your keyboard.

When a library item is copied and pasted, the new item that results is independent of the original item. If you make changes to it, the original item is unaffected. Similarly, changes to the original item do not affect the copy.

## Library Shortcuts

In addition to copying and pasting to create new, independent library items, you can copy and paste to create Library Shortcuts. Library Shortcuts are not independent items - they are linked to the original item and are affected if changes are made to the original.

Library Shortcuts are advantageous because you can place a given library item in multiple locations to suit your organizational style without increasing the size of the library database and without having to maintain multiple copies of the same item.

To create a Library Shortcut, copy a library item to the system clipboard. Then, right-click on the location where you would like to create a copy and select **Paste Shortcut** from the contextual menu. Library Shortcuts use

the same name as their source item but use the Library Shortcut  icon.

To locate a Library Shortcut's source item, right-click on it in the tree list and select **Locate Shortcut Source**

If you move or delete an item from the library, any shortcuts to it will not be updated or removed. If you try to use a “hanging” shortcut, a message about its status will display in the library preview panes.

## Deleting Library Items

The five installed library categories: Home Designer Core Catalogs, Home Designer Bonus Catalogs, Manufacturer Catalogs, User Catalog, and Trash cannot be deleted.

Catalog level folders in all categories can be deleted; however, individual subfolders and objects can only be deleted out of the User Catalog.

Items in the library that are eligible for deletion can be deleted in either of two ways:

- Right-click on it and choose **Delete** from the contextual menu.
- Select it and press the **Delete** key on your keyboard.

When items from the User Catalog are deleted, they are moved to the Library

Browser Trash . Items in the Trash can be retrieved by clicking and dragging them into any location in the User Catalog.

To empty the Trash , right-click on it and select **Empty Trash** from the contextual menu.

Depending on how much content is in the Trash, emptying it can be time consuming.

You can click the **Cancel** button to end the process if you wish.



The Empty Trash command is both immediate and permanent. It cannot be undone, so use care when using it. You should back up all your library files regularly. See “Backing up Library Content” on page 399.

---

## Exporting Library Catalogs

Exporting library files allows you to:

- Back up your custom library content.
- Transfer library content between computers.

Exporting is often preferable to simply copying library files because it allows you to include images and textures in the exported library.

### *To export content from the library*

1. Locate an object, folder, or catalog that you want to export, right click on it, and select **Export Library**.
2. In the **Export Library Data** dialog.

- Choose the appropriate **Save in:** location for your exported library file.
- Type a short, descriptive name for your library file in the **File Name** field.
- Click the **Save as type:** drop down list and select whether or not you want the library to include Textures/Images.



If any of the items being exported are images or use textures, be sure to select the .calibz file type.

- Click **Save**.
3. Your exported library file can now be copied to a network location or storage device in an operating system window.

---

## Placing Library Objects

Library objects are subject to placement restrictions based upon typical real-life placement. Most library objects require sufficient free space at the location where they are placed, for example, and some library objects have additional requirements.

Library windows and doors, for example, must be placed in a wall just like standard windows and doors, and some fixtures are designed to be placed in cabinets.

Library symbols have placement restrictions that are determined when the symbol is created but can be changed later. See “Native Objects vs Symbols” on page 410 and “Symbol Specification Dialog” on page 1189.

If a warning message displays when placing a library object, it will indicate where the object can be placed.

There are three main categories of items available in the Library Browser:

- Stand-alone objects that can be placed directly into a plan. Examples include cabinet modules, furnishings and images.
- 3D objects designed to be inserted into another 3D object. Examples include cabinet fixtures, windows and doors. Some items, such as cabinet doors and fixtures and fence panels, can be inserted into another object or placed as stand-alone objects.
- Materials, which cannot stand alone and must be assigned or applied to another object.

### Stand-Alone Objects

Most library categories contain objects that can be selected in the Library Browser and placed directly in a 2D or 3D view.

- Most stand-alone objects are designed to rest on the floor or terrain.
- Some objects will rest on top of a cabinet, shelf, furniture or roof plane object if one is located at the point where they are first placed.
- A few objects, notably some light fixtures, will mount on the bottom of a wall cabinet or on the ceiling.
- In addition, some objects will attach to a wall if one is nearby.

#### *To place a stand alone library object*

1. Click on an object in the tree view or Selection Pane of the Library Browser to select it for placement. See “The Library Browser” on page 394.

2. Move your mouse pointer into the view area and notice that it displays an icon indicating the type of object selected instead of an arrow.
3. Click to place the selected object at that location.
4. Continue clicking to place as many instances of the selected object as needed. When you are finished, click the **Select Objects**  button.

Once a stand-alone object has been placed, it can be edited in a variety of ways. See “Editing Library Objects” on page 410.

### Inserted Objects

Some objects cannot stand alone and must be placed into other objects in a plan. For example, doors and windows must be inserted into a wall, while some appliances and plumbing fixtures are designed be placed inside a base cabinet. See “Doors” on page 179, “Windows” on page 197 and “Cabinets” on page 309.

An inserted object can only display in a 2D or 3D view if the object that contains it is set to display. This is the case even if the inserted object’s layer is turned on. See “Displaying Library Objects” on page 409.

#### *To insert a library object*

1. Click on an object in the tree view or Selection Pane of the Library Browser to select it for placement. See “The Library Browser” on page 394.
2. Move your pointer into the drawing area.

3. Click on the object into which you wish to insert the selected library item. The library item is inserted into the object.
4. Continue clicking to place as many instances of the selected item as needed. When you are finished, click the **Select Objects**  button.

## Assigned Items

Some library items, such as moldings and materials, are not objects in themselves but can be applied to objects in a variety of ways.

- Using the specification dialog of the containing object. See “Select Library Object Dialog” on page 408.
- By selecting the item in the library and then clicking on the containing object in floor plan view.
- Materials can be assigned to objects directly from the library in 3D views or by selecting the material and then clicking on an object’s surface. See “The Material Painter” on page 417.

---

## Select Library Object Dialog

The **Select Library Object** dialog is a modal version of the Library Browser that is accessible from object specification dialogs. See “Specification Dialogs” on page 32.

The **Select Library Object** dialog only displays categories of items that are related to the selected object. For example, if the dialog is accessed from the GENERAL panel of the **Door Specification** dialog, only door symbols will be listed:

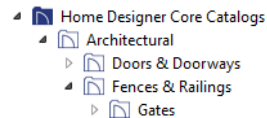

The **Select Library Object** dialog is similar to the LIBRARY MATERIALS panel of the **Select Material** dialog. See “Select Material Dialog” on page 422.

---

## Replace From Library



The **Replace From Library** edit button is available for nearly any object that can be added to the library and can be used in 2D and 3D views. Click this

button to open the **Replace From Library** dialog and replace the selected object, and others like it if you choose, with an object of the same type from the library.



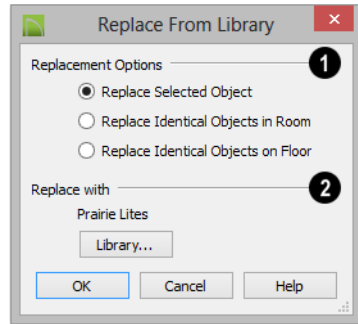



- 1 Select one of the **Replacement Options**.
  - Select **Replace Selected Object** to replace only the currently selected object.
  - Select **Replace Identical Objects in Room** to replace all objects that are in the same room as, and are identical to, the currently selected object. Not available for doors or windows.

- Select **Replace Identical Objects on Floor** to replace all objects that are on the same floor as, and are identical to, the currently selected object.

- 2 Click the **Library** button to open the **Select Library Object** dialog and select an object to use as a replacement. The name of the object that is currently selected as a replacement displays above.

**Replace From Library**  cannot be used to replace a selected cabinet with a cabinet of a larger size. In addition, it is not available for backdrops and items assigned to other objects, such as materials.

 If the Replace from Library edit tool is used to replace an electrical object, any Connect Electrical splines attached to it will be deleted. See “Connect Electrical” on page 292.

## Displaying Library Objects

The display options available for library objects depend on the type of object in question, as well as the view.

If the display of an object is turned off in a 2D or 3D view, any objects inserted into it will not display in that view, either - even if the inserted object’s layer is turned on. See “Inserted Objects” on page 407.

### In Floor Plan View

All library objects except materials, doors and drawers applied to cabinets, and backdrops can display in floor plan view. Library objects are represented in floor plan view by 2D symbols that resemble the size

and shape of the object when viewed from above.

As with other architectural objects, the display of library objects is controlled by layer in the **Display Options** dialog. Each library category has its own layer. See “Display Options Dialog” on page 77.

### Object Labels

Fixtures, Furnishings, Geometric Shapes, Hardware, Millwork and Plants can display labels in floor plan view when the appropriate layer is set to display in the **Display Options** dialog. For example, fixture labels are placed on the “Fixtures,

Labels” layer. See “Object Labels” on page 575.

You can specify a custom label for many library objects in the **Symbol Object Specification** dialog. See “Symbol Object Specification Dialogs” on page 411.

### In 3D Views

All library objects can display in 3D views.

By default, images rotate to face the camera in 3D views. For information about turning off image rotation, see “Image Specification Dialog” on page 532.

Doors, windows and cabinets from the library may also display opening indicators in Vector Views when the “Opening Indicators” layer is turned on. See “Displaying Objects” on page 76.

---

## Editing Library Objects

Like native Home Designer Architectural objects, library objects can be customized to suit your design needs. There are three approaches to editing library objects:



- Select an object in the User Catalog, edit it using any of the options in its contextual menu, and your changes will be reflected when you next place this library object in a drawing.
- Place an object in a drawing and then edit it using the various edit tools available for it. This will not affect the original object still saved in the library.
- Place an object in a drawing, edit it using the available edit tools, and then add it back to the library for future use. This will not replace the original object still saved in the library. See “Add to Library” on page 402.

Library objects placed in a drawing can be selected individually or as a group, like other objects in Home Designer Architectural. See “Selecting Objects” on page 88.

Once selected, library objects can be edited in a variety of ways using dimensions, the

edit handles, the edit toolbar buttons and the specification dialog. See “Symbol Object Specification Dialogs” on page 411.

### Native Objects vs Symbols

In Home Designer Architectural, objects created using the program’s standard tools, such as the **Door Tools**  and **Cabinet Tools** , are referred to as native objects.

On the other hand, objects placed from the library, such as fixtures and furnishings, are symbols. Symbols are typically more limited than native objects in how they can be edited.

In addition to the symbols available in the library, you can import additional symbols into the program from 3D **.obj**, **.3ds** or **.skp** files. See “Importing 3D Symbols” on page 556.

Any changes made to objects like fixtures and furniture will not be reflected in their Materials List Description, although they may be seen in other columns, such as Size. See “Materials Lists” on page 579.

## Using Edit Handles

Most library symbols are box-based objects and can be edited as such once placed in a drawing. See “Editing Box-Based Objects” on page 101. Depending on the type of view and the surface selected, the edit handles a symbol displays will vary.

When a furnishing or fixture symbol is selected in floor plan view or on the top surface in a 3D view, up to ten edit handles display. They are the Move handle at the center, the Rotate handle just outside the front indicator (a V) and a Resize handle on each edge and at each corner.

When a symbol is selected on a side in a 3D view, it displays five edit handles: the Move handle and a Resize handle on each edge.

The labels of library cabinets, electrical, furnishings and fixtures, when displayed, have a separate Move edit handle that displays when the object is selected.

Fixtures and furniture placed in a plan are subject to bumping/pushing behavior when moved. See “Bumping/Pushing” on page 109.

## Deleting Built-in Fixtures and Appliances

A fixture installed into the front of a cabinet becomes a cabinet face item, like a door or drawer. It can be resized or deleted like other face items in the **Cabinet Specification** dialog. See “Front Panel” on page 324.

---

## Symbol Object Specification Dialogs



The **Fixture, Furniture, Geometric Shape, Hardware, Millwork,** and **Sprinkler Specification** dialogs all feature the same options. The actual name of the dialog is determined by the type of object that is currently selected.

For example, selecting a library object placed from the Interiors Core Catalog and clicking the **Open Object**  edit button opens the **Furniture Specification** dialog.

## General Panel

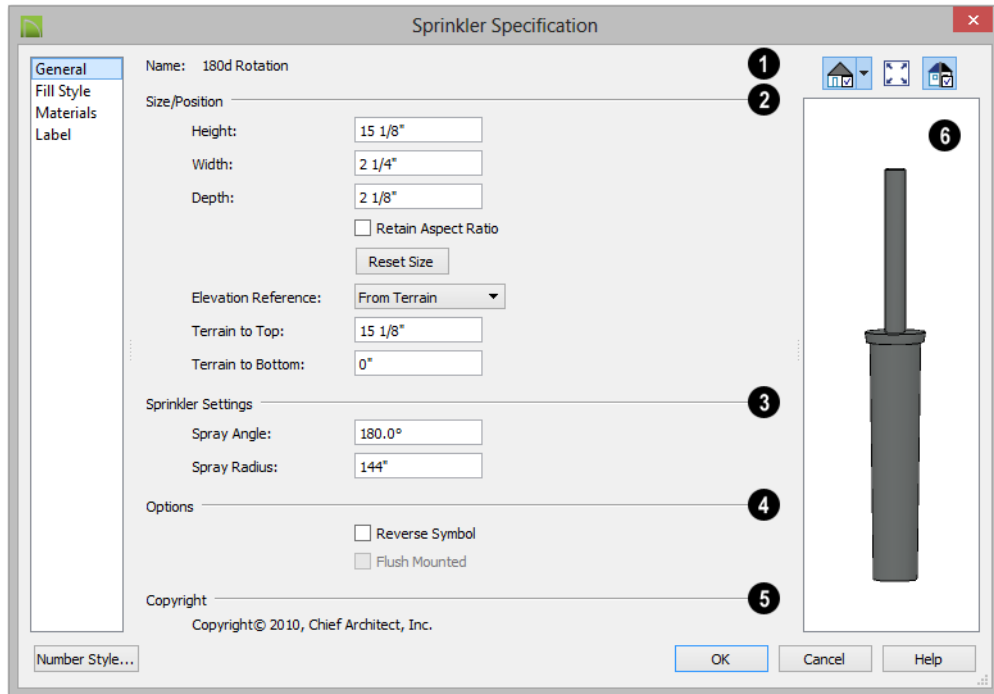

1 The **Name** of the selected symbol object displays here.

2 **Size/Position -**

- Specify the **Height, Width, and Depth** of the object.
- Check **Retain Aspect Ratio** to maintain the ratio between the object’s Height, Width, and Depth when it is resized in the specification dialog. Does not affect the behavior of the object’s edit handles.
- Click **Reset Size** to reset the symbol’s original, unmodified size. The Floor to Bottom value, below, is not affected by this button.

- Select the **Elevation Reference** from the drop-down list. This determines where the next two settings are measured from and also affects their setting labels.

- Specify the height **to Top**, measured from the selected Elevation Reference to the top of the object.
- Specify the height **to Bottom**, measured from the selected Elevation Reference to the bottom of the object.

3 The **Sprinkler Settings** are only available if the selected object is a sprinkler. See “Sprinkler Tools” on page 373.

- Specify the **Spray Angle**, which is the angle within which the sprinkler sprays.

An angle of 360° sprays in a complete circle.

- Specify the **Spray Radius**, which is the distance from the sprinkler head that the spray reaches.

#### 4 Options -

Check **Reverse Symbol** to reverse the object's appearance, so that features on its left are positioned on its right, and vice versa. This turns a right-hand refrigerator, for example, into a left-hand refrigerator. This option has no effect on objects that are symmetrical.

- Check **Flush Mounted** to specify that the selected object follow the pitch of either the ceiling or roof. Only available when "From Ceiling" or "From Roof" is selected as the Elevation Reference, above.

5 If the selected object has a **Copyright**, information about it displays here.

6 A preview of the selected library object displays here and updates with changes. If the selected symbol is inserted into another object, such as an appliance in a cabinet, the parent object will also display. See "Dialog Preview Panes" on page 32.

## Fill Style Panel

The FILL STYLE panel is available when the selected object is a sprinkler and controls how the area within its spray radius displays in floor plan view. It is similar to the FILL STYLE panel found in many dialogs. See "Fill Style Panel" on page 519.

## Materials Panel

For information about the settings on this tab, see "Materials Panel" on page 420.

## Label Panel

A variety of library objects can display labels in floor plan view. Labels use the Text Style assigned to the layer they are on.

For information about the settings on this tab, see "Label Panel" on page 576.

## Manufacturer Panel

If the selected symbol or material is from a Manufacturer's catalog, the MANUFACTURER panel lists contact information about the manufacturer. See "Manufacturer Catalogs" on page 399.



# Materials

The objects used in Home Designer Architectural have a variety of 3D properties. These objects - walls, windows, doors, cabinets, roof planes, lot perimeters, etc. - can have materials assigned to them so that they look realistic in 3D views. These materials can also be used to generate materials lists that can help with cost estimations.

Designing with objects that look correct in 3D and calculate properly in the Materials List requires that you use realistic material definitions and apply them appropriately to objects in your plan.

Home Designer Architectural comes with many materials that are ready for use. From siding, roofing, flooring, masonry, tile, and paneling, to grass, water, and wood materials, Home Designer Architectural has materials for every application, inside and out. If you cannot find a material that suits your needs, you can customize the materials provided or create your own.



Redefining only the visual properties of a material may create unexpected results. For example, changing the image of a brick material to represent siding does not cause the material to be considered as siding during material calculations.

## Chapter Contents

- About Materials
- Material Defaults
- The Material Painter
- Materials Panel
- Select Material Dialog
- Viewing Materials
- Editing Materials
- Creating Materials
- Mapping Patterns and Textures
- Material Types
- Define Material Dialog
- Select Color Dialog

---

## About Materials

The materials that are assigned to objects in Home Designer Architectural perform two important roles:

- They determine what the surfaces of objects look like in 3D views.
- They influence how objects are calculated in the Materials List. See “Materials Lists” on page 579.

Materials are stored in the Materials library in the Library Browser and can be applied to objects in either of two ways:

- Using the **Material Painter** .
- In an object’s specification dialog. See “Materials Panel” on page 420.

### Patterns and Textures

In Home Designer Architectural, materials have two attributes that determine what they look like in 3D views: Textures and Patterns.

- Textures are created using special image files that tile seamlessly when applied to surfaces and are visible in most Render-

ing Techniques. See “In Rendered Views” on page 454.

- Patterns are composed of CAD lines and are seen in Technical Illustration and Vector Views. See “Rendering Techniques” on page 478.

Unlike textures, patterns are associated with a Type that determines if and how materials are calculated in the Materials List.

### Material Types

Every material is classified by Type, which defines how the material is calculated in the Materials List. Not every Type is calculated in the Materials List; however, most determine whether a material is counted by piece, area, volume and so on. See “Material Types” on page 427.

Some Types are associated with patterns. Only Home Designer Architectural Pattern Types are figured in the Materials List. If a **.pat** file is selected, the pattern type is listed as Custom. See “Pattern Panel” on page 432.

---

## Material Defaults



Most objects in the program have defaults dialogs which allow you to set up a variety of attributes, including materials, before the objects are created. These defaults dialogs are accessed by selecting **Edit > Default Settings**. See “Preferences and Default Settings” on page 57.

Material defaults are dynamic, which means that if you change a particular material in a defaults dialog, all objects of that type that are set to use that default will automatically update to use the new material. See “Dynamic Defaults” on page 59.

Default materials can be identified on the MATERIALS panel of an object’s specification dialog. When a component is selected in the



tree list, a default material's name will be preceded by the word "Default:". See "Materials Panel" on page 420.

## Material Defaults Dialog

Select **Edit > Default Settings**  from the menu, select "Materials", and click the **Edit** button to open the **Material Defaults** dialog.

The **Material Defaults** dialog serves two purposes. It allows you to:

- Set the default materials for objects that do not have a defaults dialog. Fireplaces and furnishings from the library are examples of objects that do not have a defaults dialog.
- Set the initial materials that can then populate a variety of defaults dialogs for objects that do have them. **Door, Window, and Cabinet Defaults** are examples of defaults dialogs that can draw their material assignments from the **Material Defaults** dialog.

Because material defaults are Dynamic Defaults, you can use the **Material Defaults** dialog to apply a material to multiple objects that share similar components. For example:

- The "Room Moldings" Material Default applies to the base, crown, and chair rail moldings that can be assigned to rooms, as well as to interior door and window casing. If you change this Material Default, all of these objects in the plan can be affected.

- The "Cabinet", "Cabinet Door/Drawer", "Countertop", and "Hardware" Material Defaults can be used in your **Cabinet Defaults** dialogs to ensure that all cabinets use the same materials.

The settings here are similar to those on the MATERIALS panel found in object specification dialogs throughout the program. See "Materials Panel" on page 420.

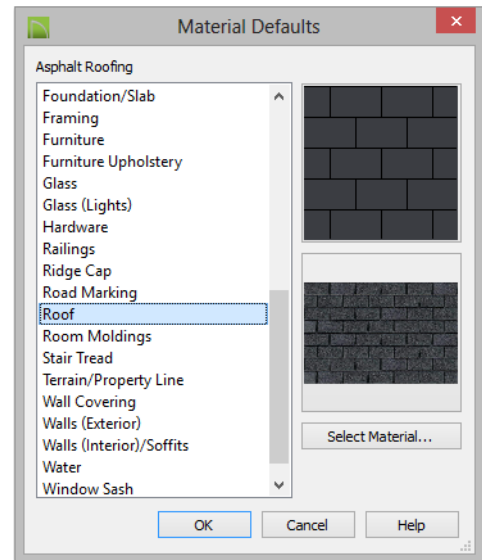

- Select a category from the scrollable list.
- Click the **Select Material** button or material preview box to open the **Select Material** dialog. See "Select Material Dialog" on page 422.

## The Material Painter







Select **3D > Material Painter** to access the **Material Painter Tools**,

which are used to apply materials to object surfaces in 3D views. The **Material Painter**

tool can also be activated by selecting a material in the library while a 3D view is active. The Material Painter tools are not available in Glass House views. See “Glass House” on page 478.

## Material Painter Modes

There are five Material Painter Modes. Each mode specifies how broadly or narrowly the selected material will be applied to surfaces in your plan.

- The **Material Painter Component Mode**  is the default mode and applies the selected material to an object component. For most types of objects, using this tool is the same as opening an object’s specification dialog and changing the material of one of its components on the MATERIALS panel. See “Materials Panel” on page 420.
- The **Material Painter Object Mode**  applies a material to all components of an object that share the same material assignment.
- The **Material Painter Room Mode**  applies a material to all the objects in the room that currently have the same material. For example, if you apply a material to a dining room chair, this mode applies the material to all other objects in the room with the same original material, such as other chairs and the dining table.
- The **Material Painter Floor Mode**  applies the selected material to all surfaces on the floor that currently have the same material. For example, if you apply a material to the kitchen countertops using this mode, the bathroom counter-

tops on the same floor also have the material applied.

- The **Material Painter Plan Mode**  applies the selected material to all surfaces in the entire plan that currently have the same material. For example, if you have the same carpet on all floors in a plan, applying a selected material while this mode is active will change all carpet on all floors.

When the **Material Painter**  tool is active, the Material Painter Mode toolbar buttons display in the edit toolbar, allowing you to quickly change modes.



You can also specify the active mode by selecting **3D> Material Painter**. A check displays next to the active mode in the submenu.

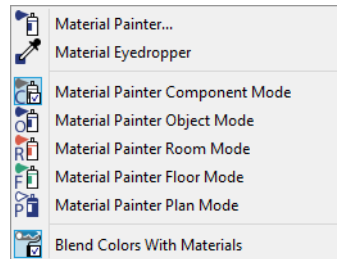



## Blend Colors With Materials







 In addition to the Material Painter Modes, the **Blend Colors With Materials** option allows you to apply a solid color to a surface displaying a pattern and blend the two.

**Blend Colors With Materials**  works in all five Material Painter Modes. See “Blending Materials” on page 424.

### *To use the Material Painter tool*



1. Create a 3D view in which the patterned material is visible.
2. Select **3D> Material Painter> Material Painter** .
3. Select a solid color material from the **Select Library Object** dialog. See “Select Library Object Dialog” on page 408.
  - Check **Use Default Material** at the bottom left of the dialog to apply the default material to any object that has a defaults dialog. See “Material Defaults” on page 416.
4. Select a Material Painter Mode from the edit toolbar, which displays on the left side of the program window when the Material Painter is enabled.
5. Click the **Blend Colors With Textures**  edit button to turn this feature on or off depending on your needs.
6. Note that the name of the material being painted displays on the left side of the Status Bar at the bottom of the program window. See “The Status Bar” on page 33.
  - Move your pointer over a surface in the 3D view. The Status Bar now states both the material being painted and the current material on the target surface.
7. Click on the surface to apply the selected material to that surface. The material is applied to surfaces in the

model based on the active Material Painter Mode.



- When both the **Material Painter**  and **Blend Colors With Textures** are active, the cursor displays a paint roller icon .
  - When the **Material Painter**  is active and **Blend Colors With Textures**  is not, the cursor displays a spray can icon .
8. If either the **Component**  or **Object Mode**  is active, you can continue to click on surfaces to apply the selected material. When you are finished, select a different tool.

## Material Painter and Walls

Painting walls is an obvious use for the **Material Painter** ; however, it is important to note that the Material Painter Modes affect walls and rooms somewhat differently than they do other objects: particularly if a wall defines multiple rooms on the side that is being painted.

- **Component**  and **Object Modes**  only paint the section of the wall that defines the room located where you click to apply a new material. Sections of the same wall that define other rooms are unaffected.
- **Room Mode**  applies the material to all walls and solid railings that define the room where you click provided that they have the same original surface material as the one being painted. Any other objects

in the room with that original material are also affected, but railings are not unless they are specified as Solid.

- **Floor**  and **Plan Modes**  apply the material to all walls, all railings, and any other objects with the same original surface material as the one being painted: either on the current floor, or throughout the plan.

Note: Wall materials applied using the Material Painter tool are not calculated in the Materials List.

### Material Eyedropper



The **Material Eyedropper** tool allows you to load the material

assigned to an existing object and apply that material to other objects.

In a 3D view, select **3D> Material Painter>**

**Material Eyedropper**  and then move your mouse pointer over a surface in the view. The name of the material on that surface is stated on the left side of the Status Bar. Click on the surface to load its material assignment. The pointer then changes to indicate that the material is ready to be applied to another object using the **Material**

**Painter**  tool. Depending on the currently active **Material Painter Mode**, you can continue to apply the material to the surfaces of other objects.

---

## Materials Panel

The specification dialogs for most objects include a MATERIALS panel. Select an object and click the **Open Object**  edit button to open the specification dialog for that selection.

On the MATERIALS panel, you can specify material assignments for the components that make up that object. When a new material is

assigned, the appearance of the preview image on the right side of the dialog updates.

If the selected object is using a material that is missing its texture, a Caution  symbol will display next to the Materials panel name in the list on the left side of the object's specification dialog. See "Referenced Files" on page 52.

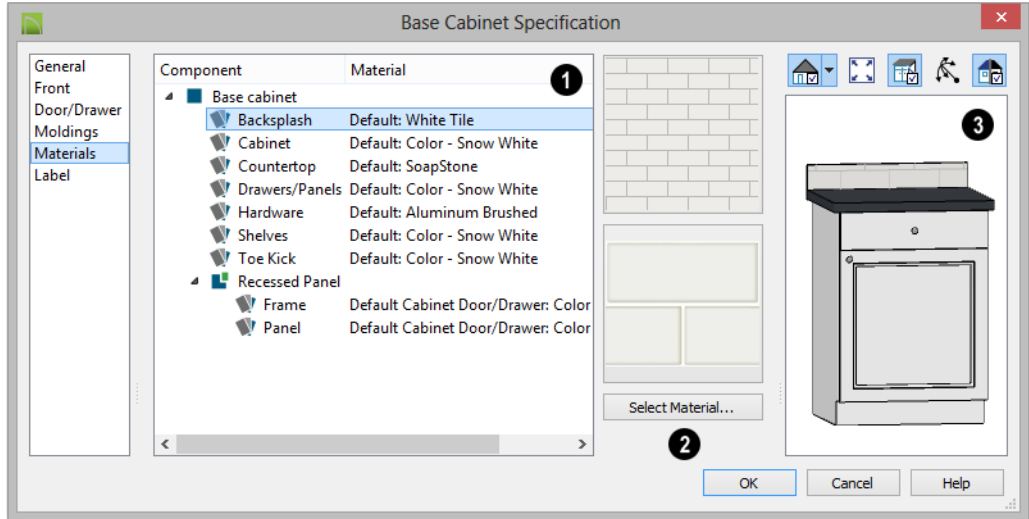

**1** The tree list on the left side of the panel lists the components of the selected object that can be assigned unique materials, along with the names of those materials and whether or not the default materials is used. Some objects may have only one component while more complex objects may have many. In addition, some components contain additional sub-components, which display separately in the components tree list.

- Click on a component in the tree list to select it and assign a new material to it.
- The selected component's Material is stated in the list, to the right of the component name. If the component is using the default material, the name will be preceded by the word "Default:". If it is using a Material Default, it will be preceded by the word "Default" followed by the name of an object type. See "Material Defaults" on page 416.

Note: If the selected object is a wall or a room modified using the Material Painter, a component's Material may be described as "No Change". See "Material Painter and Walls" on page 419.

**2** The box to the right of the tree list displays a preview of the material assigned to the selected component. If "No Texture" displays in the preview window, the material has no texture assigned to it; if a Caution  symbol and the words, "Texture Missing" display, the texture file could not be found on the system.

- Click **Select Material** to open the **Select Material** dialog. Choose a material and click **OK** to assign that material to the selected component. See "Select Material Dialog" on page 422.

**3** A preview of the selected object displays on the right side of the panel. To view material textures, select **Standard**

as the View Type. See “Dialog Preview Panes” on page 32.

---

## Select Material Dialog

The **Select Material** dialog allows you to select a material to apply to one or more objects and is opened by clicking the **Select Material** button on the MATERIALS panel of most specification dialogs or by using the **Material Painter** . See “Materials Panel”

on page 420 and “The Material Painter” on page 417.

Most of the time, the **Select Material** dialog has a single panel; however, if a component of a library symbol is selected in an object specification dialog, two panels will be present.

### Library Materials Panel

The LIBRARY MATERIALS panel is a modal version of the Library Browser that lists only materials. See “The Library Browser” on page 394.

The settings on this panel are also found in the **Select Library Object** dialog. See “Select Library Object Dialog” on page 408.

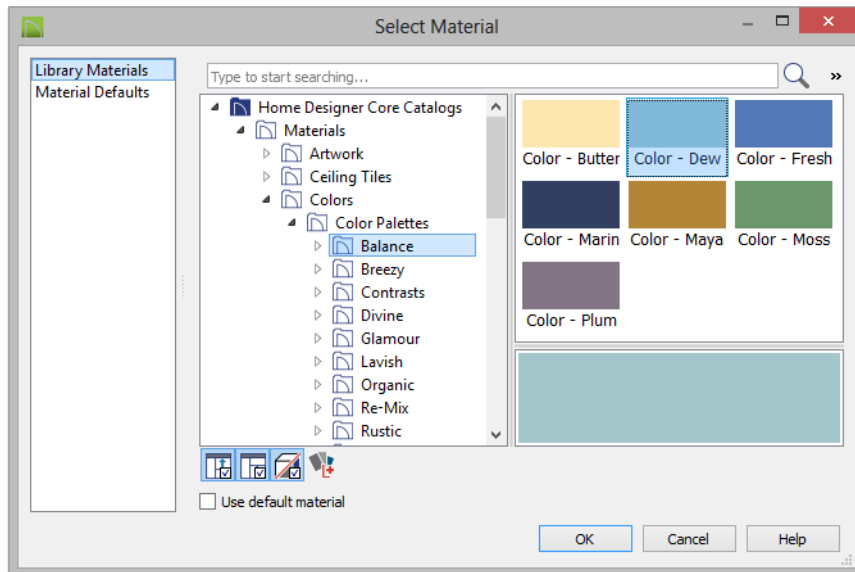

The LIBRARY MATERIALS panel has most of the functionality that the Library Browser

has: including the search, the toggleable, resizable Preview and Selection Panes, and the **Toggle Preview Display**  button.

- To locate a material, either search using keywords or browse the tree list. See “Searching the Library” on page 397.
- To apply a material to an object, either click on the material and click **OK** or double-click on the item in the Selection Pane.
- Click the **Add New Material**  button to open the **Define Material** dialog and create a new material saved in the user Catalog. See “Define Material Dialog” on page 429.

- Check **Use default material** to apply the default material to the selected object, if one exists. See “Material Defaults” on page 416.

### Material Defaults Panel

The MATERIAL DEFAULTS panel will only be present if the **Select Material** dialog was accessed via an object specification dialog where a component of a library symbol was selected.

Rather than apply a specific material to the selected component, you can dynamically associate it with a Material Default category. See “Material Defaults” on page 416.

---

## Viewing Materials

Textures display in most Rendering Techniques, while patterns display in Technical Illustration and Vector Views. See “Displaying 3D Views” on page 453.

In Technical Illustration and Vector Views, you can turn the display of material patterns on and off by selecting **3D> Toggle Patterns**

. See “Rendering Techniques” on page 478.

When most other Rendering Techniques are used, you can turn the display of textures on and off by selecting **3D> Camera View**

**Options> Toggle Textures** .

---

## Editing Materials

Much like objects, materials in Home Designer Architectural can be edited so that they better suit your design needs. There are two approaches to material editing:

- Select a material in an unlocked library in the Library Browser, edit it, and your changes will be used when you next use the material in any plan. Changes made in

this manner do not affect materials already in use in a plan.

- Apply a material to an object in a plan and then edit that applied material using the **Adjust Material Definition**  tool. Changes made in this way will affect any instances of that material in the current plan only.

Editing the material applied to an object is not the same as applying a different material to that object. See “The Material Painter” on page 417.

## Library Browser

Right-click on a material in an unlocked library and select **Open** from the contextual menu to open the **Define Material** dialog for that material. See “Define Material Dialog” on page 429.

## Adjust Material Definition



The **Adjust Material Definition** tool is useful for changing plan materials directly from a 3D view.

Select **3D> Materials> Adjust Material**

**Definition**  and then click any surface in a 3D view to modify the material currently assigned to that surface in the **Define Material** dialog. See “Define Material Dialog” on page 429.

Changing a material definition with this tool affects all objects in the current plan that are using that material but does not affect any materials saved in the library or materials used in other plans. See “Adding Library Content” on page 402.

---

## Creating Materials

Home Designer Architectural provides a wide variety of materials - including numerous name brand material catalogs - that are ready to download and use. If you cannot find a suitable material, you can edit an existing material or create a new one. See “Editing Materials” on page 423.

Note: Adding a material to a plan is not the same as adding it to the library. If you want a new material to be available for use in other plans, create it in the Library Browser.

## In the Library Browser

Materials can be created in the Library Browser, making them available for use in any plan. See “Adding Library Content” on page 402.

In the directory pane of the Library Browser, right-click on an unlocked folder and select **New> Material**  from the contextual menu. See “Using the Contextual Menus” on page 396.

The **Define Material** dialog opens, allowing you to specify the new material’s attributes. See “Define Material Dialog” on page 429.

## Blending Materials



In 3D views, you can create a new material by blending a solid color such as a paint color with a textured material. Select **3D> Material Painter> Blend Colors With Materials** to toggle this feature on or off. See “Blend Colors With Materials” on page 418.



The result is a new material that is saved in the current plan.

Materials created using the **Blend Colors With Materials**  tool are given the name of the patterned/textured material with the

extension "--PAINTED:" followed by the name of the solid color material.

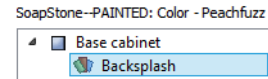

---

## Mapping Patterns and Textures

Materials have two attributes that determine what they look like in 3D views: patterns and textures. See “About Materials” on page 416.

Both patterns and textures have points of origin, which determine where the pattern or texture begins on an X/Y axis. By default, this origin is 0,0; however, you can specify a different origin in the **Define Material** dialog.

- The origin of a texture can be set either globally or independently for each object.

By default, texture mapping is per object. See “Texture Panel” on page 434.

- The origin of a pattern is always per object. See “Pattern Panel” on page 432.

If a texture is set to map globally, it may not look right on some surfaces in 3D views. If this is the case and you do not wish to map the texture independently on each object, you can create a copy of the material for each surface that requires modification and specify its texture’s origin.

### Determining the Origin

Before a new origin can be specified, the display of coordinates in the Status Bar should be enabled. See “The Status Bar” on page 33.

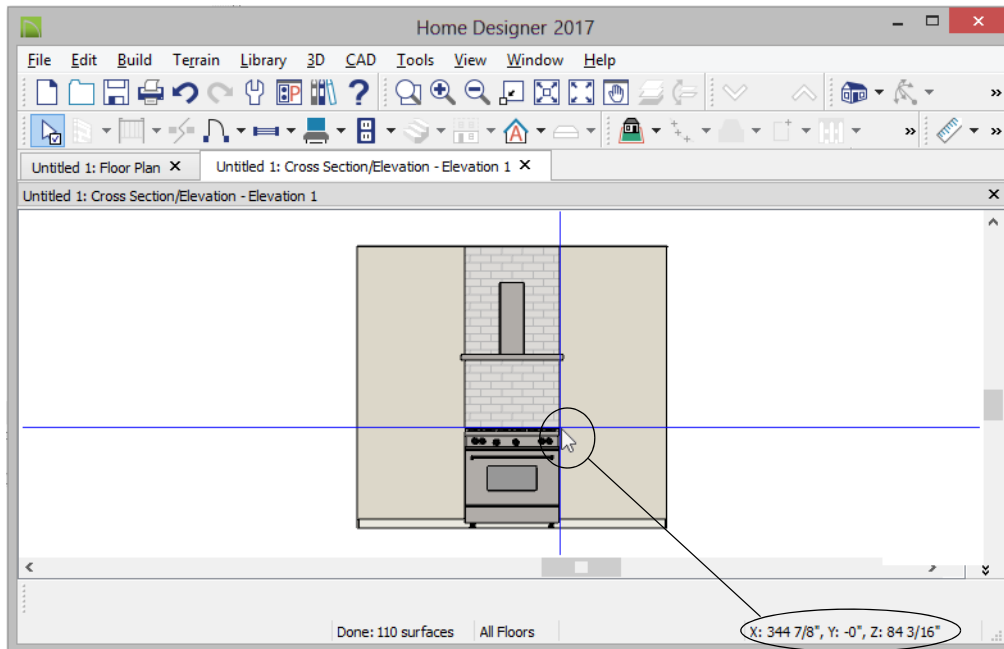

*The pointer's current coordinates display in the Status Bar*

To determine origin coordinates on the horizontal plane, place your cursor over the origin location in floor plan view. When the pointer is in the position you want to establish as the material origin, take note of the coordinates that display in the Status Bar.

To determine origin coordinates on the vertical plane, place your cursor over the origin location in a cross section/elevation view.

Once you have taken note of the new origin coordinates, enter them on either the **PATTERN** or **TEXTURE** panel of the **Define Material** dialog. See “Define Material Dialog” on page 429.

A texture or pattern origin is a property of the material rather than of the object that the

material is assigned to. When an object is moved, the pattern or texture maintains its absolute position and may not look right. It is a good idea to assign pattern or texture origins only after the position of the object has been finalized.

 If you have multiple objects using the same material, they all share the same origin. Duplicate materials can be created if you want different origins specified for the same texture or pattern.

### Stretch to Fit

Some special textures, often used for artwork, stretch across any surfaces that they are applied to. Materials that behave this way

are specified as **Stretch to Fit** in the **Define Material** dialog.

To display an artwork texture, first place a wall or desk frame in your plan. A selection of both are available in the library. See “Placing Library Objects” on page 406.

Next, simply apply a material specified as **Stretch to Fit** to the center portion of the frame. See “The Material Painter” on page 417.

For more information about creating and using custom materials, see “Materials Tutorial” on page 115 of the User’s Guide.

## Material Types

Every material is classified by **Type** in the **Define Material** dialog. See “General Panel” on page 430. The Type defines how the material is calculated in the Materials List when it is applied to structural components like wall, floor and ceiling, or roof layers; slabs; or to generic objects like Primitives.

Some but not all Types are associated with patterns that display in some Rendering Techniques. See “Patterns and Textures” on page 416.

Note that not every material Type is calculated in the Materials List.

Following are the available Material Types and their characteristics:

Type	Pattern	Options	Materials List
Framing	None	n/a	Calculates stick framing quantities when assigned to a layer in a wall type definition.
Brick	Typical staggered running bond brick course.	Height, Length, Depth and Mortar Width.	Calculates the number of units based on the total surface area. For a masonry wall with two layers of brick, create a wall type with two layers to get the right count. This Type can be specified for anything using this style of layout, such as plywood with staggered joints.
Strip	Parallel lines.	Height, Grouping, and Overlap Amount.	Calculates lineal footage based on the surface area and the height of the strip minus the Overlap amount. Grouping can be used to model a material that has a repeating pattern across its width.

Type	Pattern	Options	Materials List
Sheet	None	n/a	Calculates the number of sheets required to cover the surface area.
Gap	None	n/a	Gap materials create a space between materials. This is equivalent to defining no material at all and is not calculated in the Materials List.
Area	None	n/a	Calculates the total surface area.
Volume	None	n/a	Calculates cubic feet (meters).
Concrete	None	n/a	Calculates cubic yards (meters).
Tile	Grid	Height, Width, Thickness, and Joint Width.	Calculates the number of units required to cover the surface area.
Shingles	Rows of staggered rectangles.	Height, Width, Thickness, and Overlap Amount.	Calculates the number of shingles required to cover the surface area.
Flooring	None	n/a	Calculates the total surface area.
Shakes	Staggered rows of uneven rectangles.	Height, Width, Thickness, and Overlap Amount.	Calculates the number of shingles required to cover the surface area.
Herringbone	Herringbone.	Height, Length, Depth and Mortar Width. Height and Length are restricted to a 2:1 ratio.	Calculates the number of units required to cover the surface area.
Octagon	Octagons and small squares.	Height, Length, Depth and Mortar Width. Height and Length refer to the small square edges and are restricted to a 1:1 ratio.	Calculates the number of units required to cover the surface area. Units are composed of one octagon and four squares.
Hexagon	Hexagon	Height, Length, Depth and Mortar Width. Height and Length are restricted to a 1:1 ratio..	Calculates the number of units required to cover the surface area.
Parquet	Square parquet units	Size.	Calculates the required number of parquet units to cover the surface area.

Type	Pattern	Options	Materials List
Textured	Similar to a Sand fill style.	Spacing.	The Materials List does not calculate this material Type.
Earth	Alternating hatch pattern similar to Parquet.	Size.	The Materials List does not calculate this material Type.
Stars	Six sided stars.	Size.	The Materials List does not calculate this material Type.
Custom	Multiple options	Depends on the selected pattern.	Calculates the surface area. If you select Use Custom Pattern File, the Material Type will be Custom regardless of the selected pattern.

## Define Material Dialog

The **Define Material** dialog allows you to adjust how materials look in 3D views and can be accessed in a number of ways:

- Use the **Adjust Material Definition**  tool. See “Adjust Material Definition” on page 424.
- Right-click on a material in an unlocked library in the Library Browser and select **Open** from the contextual menu. See

“Using the Contextual Menus” on page 396.

- You can also right-click on an unlocked library and select **New> Material**.

If you access the **Define Material** dialog through a menu or specification dialog, your edits affect that material wherever it is found in the current plan. Other objects in that plan that use that material are also affected, but objects outside the current plan are not.

## General Panel

The options on the GENERAL panel will vary depending on the selected material Type. See “Material Types” on page 427.

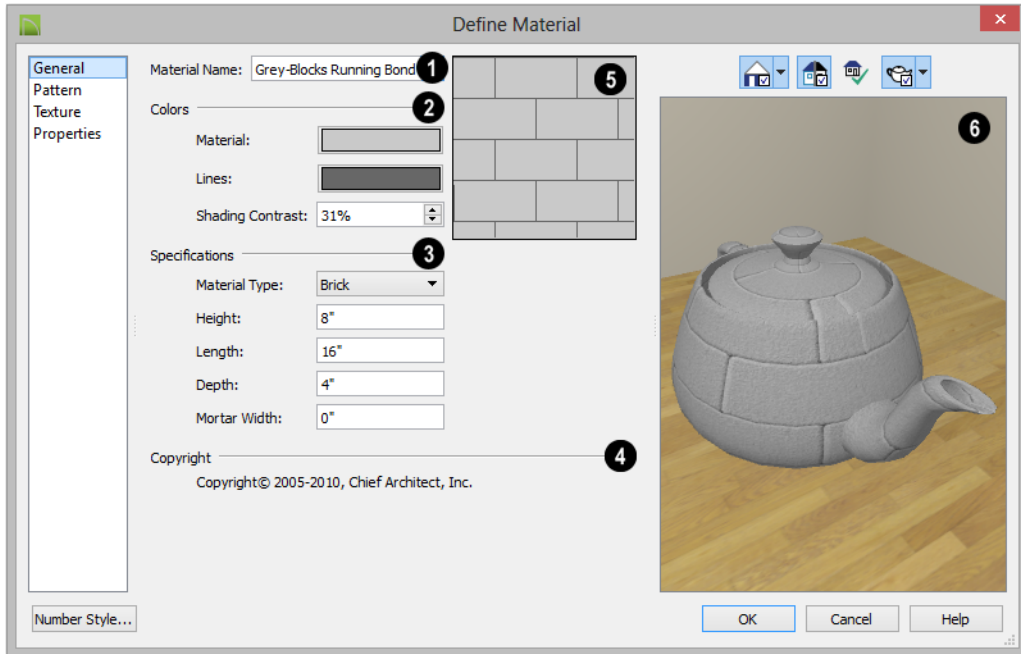

**1** The **Material Name** displays here. You can type a different name if you wish. Renaming the material does not create a new material: it redefines the existing material. See “Creating Materials” on page 424.

**2** Specify the **Colors** used to represent the material’s pattern in Vector Views. Click a color box to open the **Select Color** dialog and select a color. See “Select Color Dialog” on page 438.

- The **Material** color displays in Vector Views. It is also used in Rendering Techniques that use textures when **Toggle**

**Textures**  is off, or if a material has no texture specified. See “In Vector Views” on page 454.

- The color of the **Pattern Lines**, which display in Vector Views, displays here.
- Specify the **Shading Contrast**, which is the amount of contrast between surfaces at different angles to each other in Vector Views.

The following shows a curved wall with three different Shading Contrasts (created in a separate graphics program). Notice how the lowest contrast at the top appears almost flat.

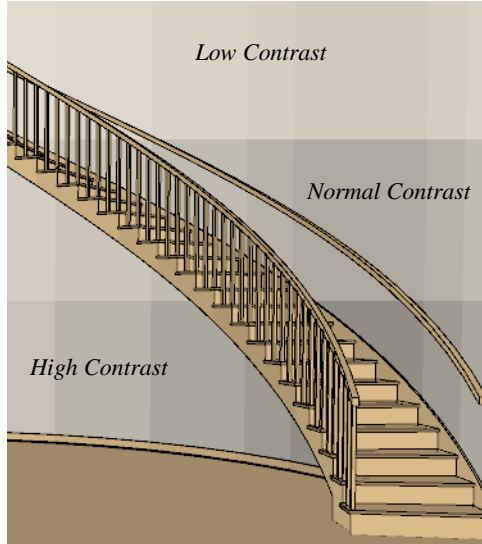

### 3 Specifications -

- Select a material **Type** from the drop-down list. The selected Type defines how - or whether - the material is calculated in the Materials List and may also be associated with a pattern. See “Material Types” on page 427.

Depending on the Type selected, additional settings may become available. Unless otherwise noted, these settings affect both the appearance of the material in Vector Views and how it is counted in the Materials List:

- Specify the material’s **Height**. This value is restricted to a ratio of the Length for Parquet, Octagon, and Hexagon material Types. When applied to a Strip, Shingles, or Shakes Type, the **Height - Overlap Amount = Exposure** of the material.
- Specify a Framing material’s **Spacing OC**. This value controls the spacing of

wall studs only. See “Wall Framing” on page 540.

- Specify the material’s **Length**. This value is restricted to a ratio of the Height for Parquet, Octagon, and Hexagon material Types.
- Specify the **Thickness** of a material Type such as Tile. Thickness does not typically affect the appearance of the material in Vector Views, but is used for Materials List calculations.

Note: With the exception of wall framing, when a material is assigned to a wall type layer, floor or ceiling structure or finish layer, or to a structural roofing layer, the Thickness value set here is not used for materials list calculations.

- Specify the **Depth** of a Brick material. Depth does not typically affect the material’s appearance in Vector Views, but is used for Materials List calculations.
- Some patterns are defined by relative **Size**. The number does not have any units: it is more like a scaling factor. Material Types with a Size setting are not calculated in the Materials List.
- Specify the **Joint Width**, which is the grout width between pieces of Tile. This affects the size of tiles in Vector Views but not the size of the pattern lines.
- Specify the **Mortar Width** for a Brick or Block material. This affects the size of bricks and blocks in Vector Views but not the size of the pattern lines.
- Specify the **Overlap Amount**, which is the amount that a Strip, Shingles, or Shakes material overlaps itself. The **Height - Overlap Amount = Exposure** of the material.

- **Grouping** is used to describe the repeat of the pattern across the width of a Strip material. A 13" wide Strip with an Overlap Amt of 1" and a Grouping of 3 calculates materials based on a 12" coverage and a repeat line pattern of 4".
- 4 If the material has a **Copyright**, information about it will display here.
  - 5 A preview of the material's pattern displays in the square pane. It updates as you change the material definition.
  - 6 A preview of the material applied to an object displays here and updates as changes are made to the material definition. Various options allow you to view different aspects of the material's attributes:
- Display the material in Standard rendering or Vector View.
  - Zoom and orbit the object in the view.
  - Toggle Color on or off.
  - Click the **Restore Original View**  button to reset the material preview to its original perspective.
  - Select a Cube, Sphere, or Teapot shape.

Unlike other dialog previews, the Rendering Technique and object shape selected in this dialog's preview are remembered during the current program session. See "Dialog Preview Panes" on page 32.

## Pattern Panel

Patterns are used to represent materials in Technical Illustration and Vector Views.

Pattern Types also affect the Materials List. See "Patterns and Textures" on page 416.



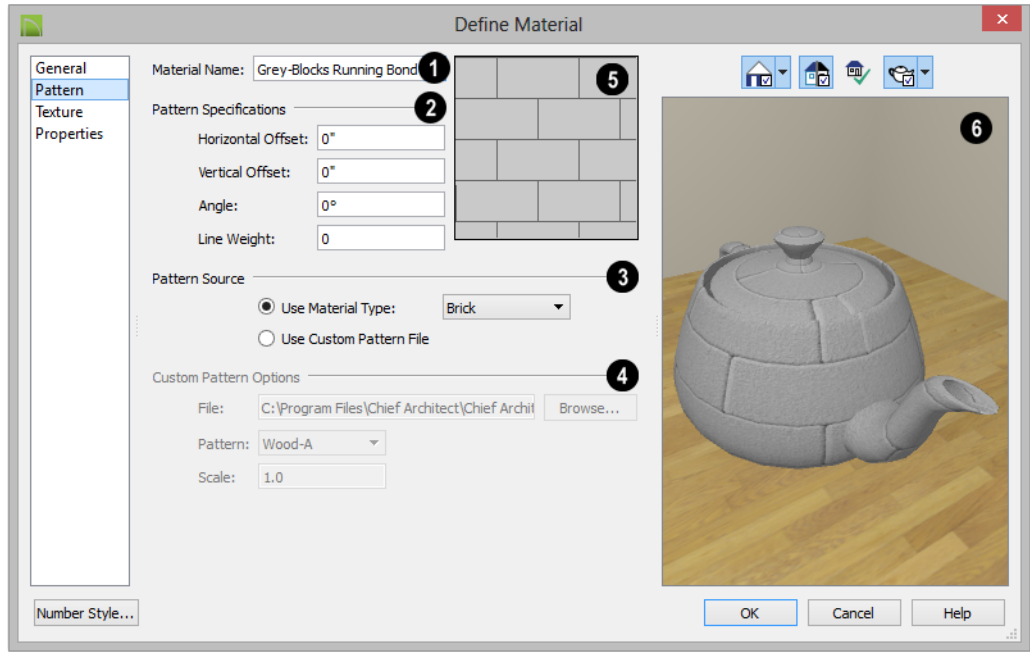

- 1 The **Material Name** displays here. You can type a different name if you wish. Renaming the material does not create a new material: it redefines the existing material.
- 2 **Pattern Specifications** -
  - Specify the **Horizontal** and **Vertical Offsets**, if needed, so the pattern displays correctly on surfaces in Vector Views. See “Mapping Patterns and Textures” on page 425.
  - Specify the **Pattern Angle**, in degrees measured counterclockwise.
  - Specify the **Line Weight**, which is the thickness of the pattern lines.
- 3 Specify the selected material’s **Pattern Source**, which affects both how the material looks in Vector Views and how it is

calculated in the Materials List. See “Material Types” on page 427.

- Select **Use Material Type** to base the material’s pattern on the selected Type, then select a Type from the drop-down list. This drop-down is also found on the GENERAL panel.
- Select **Use Custom Pattern File** to specify a Custom pattern and enable the options below. When a Custom pattern is used, the material will be counted as an Area type in the Materials List.
- 4 The **Custom Pattern Options** are available when Use Custom Pattern File is selected, above.
  - The **File** pathname of the selected **.pat** pattern file displays here.

- Click the **Browse** to open the **Custom Pattern File** dialog and select a pattern file. This dialog is a typical Open dialog, and opens to the Patterns folder in the program installation directory.
- Select a **Pattern** from the drop-down list. The items available depend on the **.pat** file selected above.
- Specify the pattern's **Scale**. If the pattern appears black in the square preview pane, this value should be increased.

**5** A preview of the material's pattern displays in the square pane. It updates as you change the material definition.

**6** A preview of the material applied to an object displays here and updates as changes are made to the material definition. Various options allow you to view different aspects of the material's attributes:

- Display the material in Standard rendering or Vector View.
- Zoom and orbit the object in the view.
- Toggle Color on or off.
- Click the **Restore Original View**  button to reset the material preview to its original perspective.
- Select a Cube, Sphere, or Teapot shape.

## Texture Panel

In most Rendering Techniques, materials are represented by textures. See "Rendering Techniques" on page 478.

Transparency information may be contained on the alpha channel of a texture; if so, it is used in rendered views.

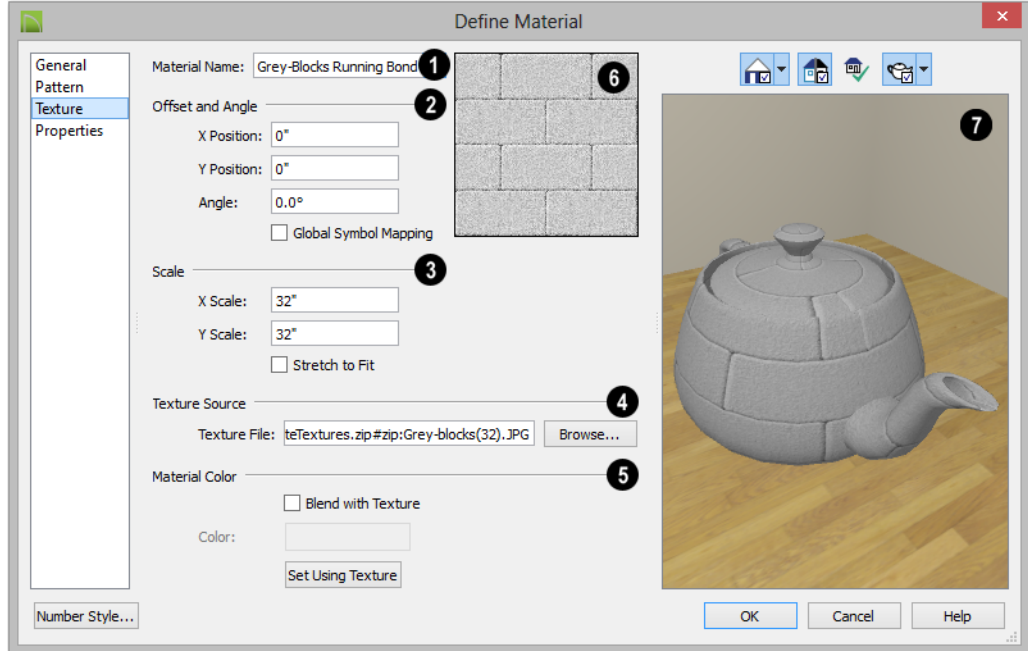

**1** The **Material Name** displays here. You can type a different name if you wish. Renaming the material does not create a new material: it redefines the existing material.

## **2** Offset and Angle -

- Specify the **X** and **Y Positions** of the texture, if needed, so the texture displays correctly on surfaces in rendered views. See “Mapping Patterns and Textures” on page 425.
- Specify the **Angle** of the texture on the surfaces of objects, in degrees.
- Check **Global Symbol Mapping** to map the texture using the same origin on all objects. When unchecked, the origin is

defined individually for each object. See “Mapping Patterns and Textures” on page 425.

## **3** Specify the **Scale** of the selected material’s texture.

- Adjust the **X Scale** and **Y Scale**, or height and width, of the selected texture.

If a rendered surface is larger than the area described by the Scale, the surface has “tiles” of the texture image. If it is smaller, only a portion of the texture is shown.

- Check **Stretch to Fit** to stretch the texture image to cover each surface it is applied to. Stretch to Fit is typically used for artwork or photography in a frame.

Note: Changing the scale or selecting Stretch to Fit can cause textures to appear distorted if applied to a surface with a different aspect ratio than the original texture image.

- 4 **Texture Source** - Displays the path and file name of the selected texture.
- Click the **Browse** button to browse to a texture file saved on your computer. Supported file formats are **.jpg, .bmp, .png, .gif, .tif, .pcx, .tga**. See “Creating Materials” on page 424.
- 5 Specify the characteristics of the **Material Color**. This can also be set on the GENERAL panel. See “General Panel” on page 430.
- Check **Blend with Texture** to apply the Material Color over the material’s texture.

When a new material is created using the **Blend Colors With Materials**  tool, the resulting material has this box checked. See “Blend Colors With Materials” on page 418.

- Click the **Color** button to specify the Material Color.
- Click the **Set Material Color Using Texture** button to use the predominant color of the material’s texture. See “Patterns and Textures” on page 416.

6 A preview of the material’s texture displays in the square pane. It updates as you change the material definition.

7 A preview of the material applied to an object displays here and updates as changes are made to the material definition. Various options allow you to view different aspects of the material’s attributes:

- Display the material in Standard rendering or Vector View.
- Zoom and orbit the object in the view.
- Toggle Color on or off.
- Click the **Restore Original View**  button to reset the material preview to its original perspective.
- Select a Cube, Sphere, or Teapot shape.

## Properties Panel

The PROPERTIES panel controls how the material appears in most rendered 3D views.

A material’s rendered appearance is also affected by the Render settings in the **Preferences** dialog and the lights that have

been placed in the model. See “Light Types” on page 475.

For special lighting effects on an object, use at least one point or spot light.

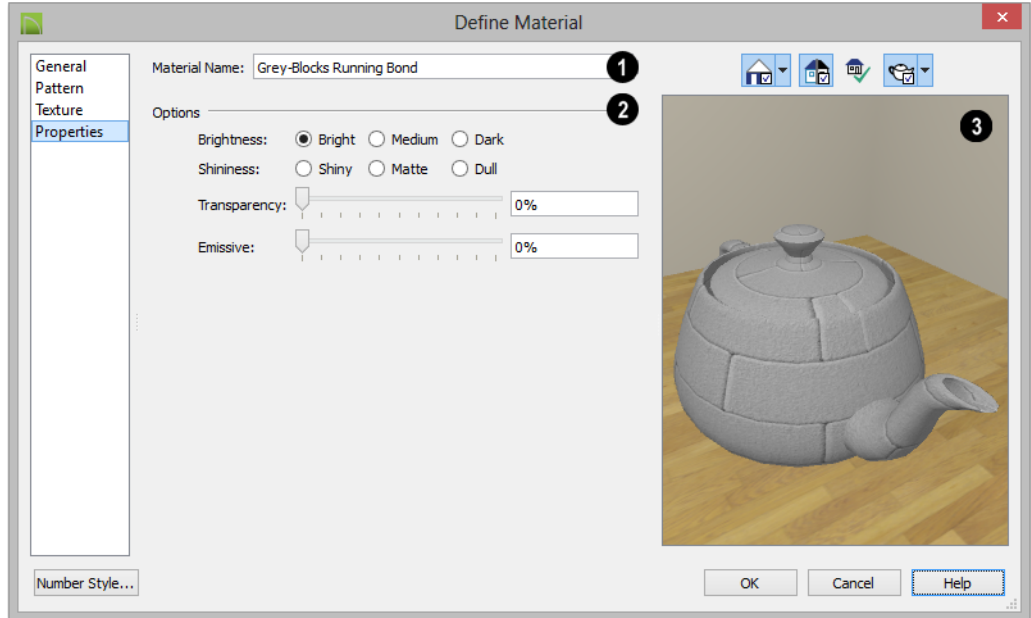

1 The **Material Name** displays here. You can type a different name if you wish. Renaming the material does not create a new material: it redefines the existing material.

## 2 Options

- **Brightness** controls how bright the material appears. It can be used to get the desired appearance relative to other materials being used.
- **Shininess** controls the sheen of the material when it is rendered with a point or spot light source on it. Shiny materials appear to have a bright white spot on them which simulates reflection of light.
- **Transparency** - Use the slider bar or text field to control the materials transparency. A value of 0 is completely opaque and a value of 100 is completely transparent.

Specifying materials with transparency can slow down rendering speed in some situations.

- **Emissive** - Use the slider bar or text field to control how bright a material appears independent of the lighting in the scene. It can be used to simulate surfaces that are glowing with their own light, such as the glass on a light fixture.

3 A preview of the material applied to an object displays here and updates as changes are made to the material definition. Various options allow you to view different aspects of the material's attributes:

- Display the material in Standard rendering or Vector View.
- Zoom and orbit the object in the view.
- Toggle **Color** on or off.

- Click the **Restore Original View**  button to reset the material preview to its original perspective.
- Select an object shape: Cube, Sphere, or Teapot.

## Manufacturer Panel

If the selected material was copied from the Manufacturer library category, the MANUFACTURER panel lists contact information. See “Manufacturer Catalogs” on page 399.

## Select Color Dialog

The **Select Color** dialog can be opened by clicking on the color bar that can be found in many dialogs throughout the Windows

version of the program. In the Mac version, the standard **Colors** dialog, or Color Picker, is used.

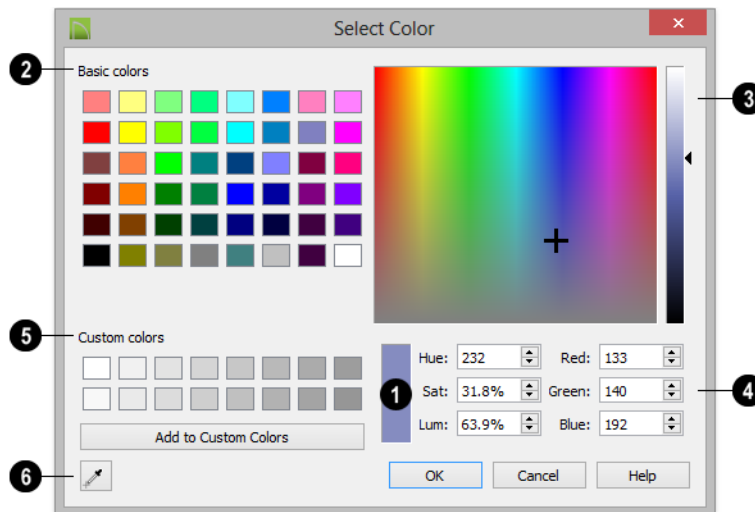

- 1 The currently selected color displays in the rectangle at the lower center of the dialog. There are a number of ways to select a color in this dialog:
  - 2 Click in any one of the **Basic colors** boxes to select it.
  - 3 Click anywhere in the color spectrum area to select a color.
- The location of the selected color is identified by a crosshairs and its Hue, Satur-

- tion, and RGB values will display below and update as you click.
- Click anywhere in the vertical bar or drag the arrow to adjust the selected color’s Luminosity and RGB values.
- 4 Define the selected color by specifying its **Hue**, **Saturation**, and **Luminosity** (HSL) or its **Red**, **Green**, and **Blue** (RGB) values.

- 5 Click in one of the **Custom colors** boxes to either select it as the new color or to specify it as the box for a new custom color to be defined.
  - Click the **Add to Custom Colors** to add the currently selected color to the Custom Colors group.
- 6 Click the **Color Chooser Eyedropper**, then click anywhere on your monitor to select the color displaying at that location.



You can select a color from any program window. Before opening the Color Chooser dialog, make sure the desired color can be seen onscreen by tiling Home Designer Architectural and the other program window.

Click OK to apply the currently selected color to the object's line or fill style, or to the material's pattern color.





# Window and View Tools

The View and Window Tools let you control how views of your drawing are shown on screen, as well as toggle useful drawing aides on and off.

There is no limit to the number of plan files that can be open. The name of the file and the type of view displays at the top of each view window in its title bar. If the view is saved, its name also displays.

## Chapter Contents

- View Tools
- Zoom Tools
- Undo Zoom
- Fill Window
- Panning the Display
- Working in Multiple Views
- Closing Views

## View Tools

The **View Tools** allow you to open and close the program's side windows, as well as toggle a variety of references and drawing aides. Select the **View** menu to access these tools.



**Refresh Display** redraws the current window to clean up extra lines, show missing items, and correct random on-screen effects caused by changes to the model. See "Refresh Display" on page 108.



**Library Browser** opens and closes the Library Browser side window. See "The Library" on page 393.

**Tool Palette** opens and closes the Tool Palette, which will display related tools. See "Child Tool Palette" on page 72.



**Scrollbars** displays and suppresses scrollbars on view windows. See "View Windows" on page 27.



**Color** toggles the display of color in the current view. See "Color On/Off" on page 107.





**Reference Grid** toggles the display of the Reference Grid in all views in the current plan or layout file. See "Grid Snaps" on page 81.

## Zoom Tools



**Zoom** is used to magnify any given area on the plan or 3D view. Select **Window > Zoom**, then click and drag a marquee around an area on screen. When you release the mouse, the selected area expands to fill the screen.

Note that in 3D views, using **Zoom**  does not reposition the camera. This can lead to inconsistencies between a camera's position and what is actually shown in the view if other methods of zooming are used later. See "Repositioning Cameras" on page 455.

When the zoom is complete, whatever tool was active prior to selecting the **Zoom**  tool automatically becomes active again. If another zoom is needed, click the **Zoom**  tool again.



**Zoom In** - Click to zoom in towards the screen center by a factor of two.



**Zoom Out** - Click to zoom out from the screen center by a factor of two.



**Undo Zoom** - Reverse the last zoom operation.



**Fill Window** - Fits all visible items on screen.



**Fill Window Building Only** - Fits all walls and railings on the current floor on screen.

## Zooming With the Mouse Wheel



Use the mouse wheel to zoom in and out in all view windows. Scrolling the mouse wheel one click up or down zooms in or out, centering on the

location of your pointer and changing the zoom by about 10%.

By default, zooming in 3D views changes the camera's position. See **“Mouse Scroll Wheel and Trackpad” on page 456.**

Note: Depending on the configuration of your mouse, it may be necessary to hold down the Ctrl key while turning the mouse wheel. If zooming in and out are not working correctly, contact the manufacturer of your mouse and mouse driver for their assistance.

## Undo Zoom



Select **Window > Undo Zoom** to reverse the last zoom operation.

Note: Undo and Redo do not affect zoom.

**Zoom** and **Undo Zoom** are also

available through the contextual menu. See “Contextual Menus” on page 29.

## Fill Window



In floor plan view or an Elevation view, select **Window > Fill Window** or press the **F6** key to view nearly everything on screen that is visible, including the Reference Display. CAD Points are the only objects that are not included when Fill Window is used.

If you are zoomed in so that only a portion of the drawing displays on screen, selecting **Fill**

**Window** zooms out so that the entire view fits on the screen. If you are zoomed out so that the entire drawing is smaller than the screen, selecting **Fill Window** zooms in until the drawing fills the screen.

When the drawing sheet is shown, **Fill Window** zooms to the sheet borders.

### Fill Window Building Only



**Window > Fill Window Building Only** is similar to **Fill Window**, but zooms in or out so that all walls and railings in the view fill the current window. Other objects are ignored.

### In 3D Views

In 3D views, **Fill Window** and **Fill Window Building Only** adjust the camera's Field of View is adjusted so that all surfaces in the 3D view are included.

## Panning the Display

There are four ways to pan the display

without changing the zoom factor.

## Using the Scroll Bars

One method is to use the scroll bars on the right and bottom edges of the window.

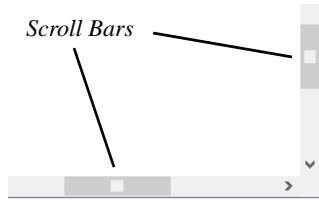

- Drag the square button in the bar itself in order to pan a larger distance.
- Click the end arrow keys on the scroll bars to shift the display in 12" increments.
- The 12" increment is defined in the **Plan Defaults** dialog under **Inches Scrolled by Arrow Key**. See “General Plan Defaults Dialog” on page 60.

## Using the Arrow Keys

In floor plan view, the arrow keys on the keyboard work exactly like clicking the arrow buttons on the scroll bar. They shift the display according to the number of inches defined in the **Plan Defaults** dialog.

## Using the Mouse

If you have a wheel mouse, you can pan the display by pressing the middle mouse button,

or wheel, and moving the mouse in the direction you would like to pan. When the middle mouse button is held down, the pointer changes to a hand  icon.

In the Mac version of Home Designer Architectural, you can pan using the left mouse button and Command key.

Mouse drivers sometimes have other functions assigned to the wheel and buttons. These override the Home Designer Architectural setting.



## Using a Mac Trackpad

In the Mac version of Home Designer Architectural, you can two finger drag to pan the display. See “Using a Trackpad” on page 26.

## Using the Pan Window Tool



The **Pan Window** tool works much like the mouse wheel method.

Select **Window > Pan Window** . The pointer changes to a hand  icon. Click and drag to pan the window. The program reverts to the previously active tool when you release the mouse button.

---

## Working in Multiple Views

There is no limit to the number of plan files that can be open, nor is there a limit to the number of plan view windows that can be open. The name of the file and the type of

view is stated at the top of each view window in its title bar as well as in its tab. If the view is saved, its name displays instead of the view type.

By default, Home Designer Architectural uses a tabbed document interface, which means that when more than one view window is open in the program window, each open window will have a tab that displays in a row above the currently active view.

- Each tab states the name of file and either the name of the view or the view type. Click on a tab to make it the active view.
- If there is not enough room in the program window to display all tabs, left and right arrow buttons allow you to scroll through the tabs.

- Tabs can be reordered by clicking and dragging.

There is no limit to the number of 3D view windows that you can have open at a given time; bear in mind, though, that each window demands use of your computer's resources and that you may see poor performance if too many views are open. See "3D Views" on page 447.

There are several ways to close a view window. See "Closing Views and Files" on page 54.

## Tiling Views



As an alternative to tabbed views, windows can instead be tiled. Tiling allows you to display multiple views in a single Home Designer Architectural

window so you can see the results of changes in floor plan view in 3D or vice versa. It can also be useful for copying objects from one plan to another.



*Floor plan view and a camera view Tiled Vertically*

There are several ways to create tiled views:

- Click and drag a view window's title bar or tab into the part of the drawing area that you would like it to be. When a highlighted space is created, release the mouse button.
- Select **Window > Tile Horizontally**  to display views in a horizontal orientation, one above the other.

- Select **Window> Tile Vertically**  or press Shift + F6 on the keyboard to display views in a vertical, side by side, orientation.

Views are tiled left to right or top to bottom in the order in which they were last active: the most recent view is on the left or at the top, while least recent is on the right or on the bottom.



- To activate a view, click on its title bar or anywhere in the view window. Note that any changes you make in the active window are reflected in other views as well.
- To end window tiling, select **Window> Tab Windows**. You can also end tiling by double-clicking on the title bar of the program window.

## Multiple Program Windows

To create a second program window, click and drag the title bar or tab of a view window completely out of the current program window: for example, onto a second monitor. A second Home Designer Architectural program window will be created with its own menu and toolbars.

## Swapping Views

There are a number of ways to switch between open view windows:

- Click on a view window's tab.
- Select **Window> Select Next Tab**  or **Window> Select Previous Tab**  to cycle through all open views in the order you prefer.
- In Windows, press the Ctrl + Tab (Next Window) or Ctrl + Shift + Tab (Previous Window) keys to cycle through all open views.
- On a Mac, press the Ctrl + } (Next Window) or Ctrl + Shift + { (Previous Window) keys to cycle through all open views.
- A list of all the views currently open is located at the bottom of the Window menu. Each view is identified by its name and what type of view it is. A checkmark is beside the view that is currently active. Select one to go directly to that view.

If more than eight view windows are open, **More Windows** will be the last item in the Window menu. Select this option to open the **Select Window** dialog:

Select the name of a view in the list and click **OK** to make it the active view.

---

## Closing Views

If a view is still needed, swap to a different view without closing the current views. If, however, a view is no longer needed, it can

be closed. See “Closing Views and Files” on page 54.

# 3D Views

Little preparation is needed to create a 3D view of a model: simply click a button to create an overview or click and drag to create a camera or elevation view.

To improve the quality of the rendering and create a custom look, you can adjust lighting and edit the materials used in the plan. You can create Final views that are even more realistic. See “3D Rendering” on page 469.

Many objects can be placed and edited in 3D views, and any camera view or overview can be saved or even used to record a walkthrough. See “Pictures, Images, and Walkthroughs” on page 529.

## Chapter Contents

- OpenGL and Hardware
- Backdrop Dialog
- 3D View Tools
- Creating Camera Views
- Creating Overviews
- Elevation Views
- Displaying 3D Views
- Repositioning Cameras
- Editing 3D Views
- Cross Section Slider
- Working in 3D
- Saving and Printing 3D Views
- Camera Specification Dialog

## OpenGL and Hardware

Home Designer Architectural features an easy to use rendering engine that makes use of OpenGL rendering technology, which has good hardware support on most video cards.

To take full advantage of the rendering capabilities of Home Designer Architectural, a graphics card or chipset that supports OpenGL 2.1 or higher hardware acceleration is required.

---

## Types of 3D Views

There are three categories of 3D views in Home Designer Architectural: camera views, overviews and elevation views. Each of these view types can be generated using a variety of rendering techniques. See “Rendering Techniques” on page 478.

Most rendered views represent materials using textures. Surface edge lines are not

drawn and lighting is modeled, creating results that range from a photorealistic appearance to artistic painting styles.

Vector Views are non-photorealistic views in which objects are drawn using surface edge lines, or vectors. Lighting is not calculated, and materials are represented using solid colors.

---

## Backdrop Dialog



Select **3D > 3D Backdrop** from the menu to open the **3D Backdrop** dialog. This dialog allows you to specify a

solid color or picture file of your choice to use as a background for 3D views. See “3D Backdrops” on page 542.



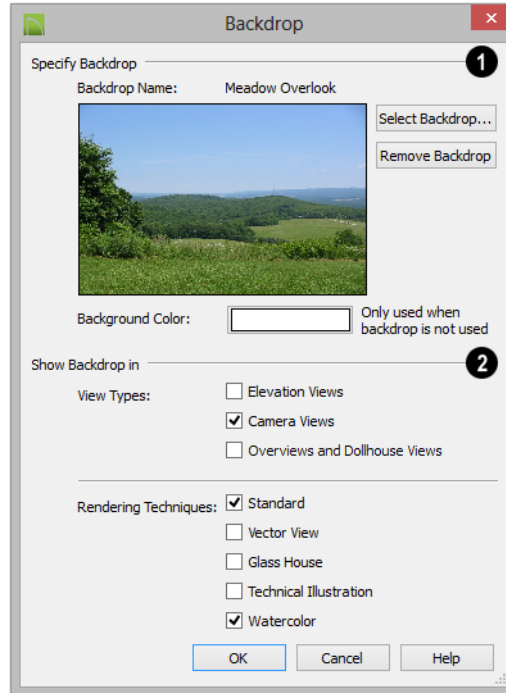

- 1 **Specify Backdrop** -A preview of the selected backdrop image is shown here.
- **Backdrop Name** - The name of the selected backdrop image displays for reference.
  - Click **Select Backdrop** to choose a backdrop image from the library. See “Select Library Object Dialog” on page 408.
  - Click **Remove Backdrop** to use a solid color instead of a backdrop image in all 3D views, then specify the color below.
  - Click the Color bar to select the **Background Color** that displays when a backdrop image is not being used. See “Select Color Dialog” on page 438.

The **Background Color** is used in all views except Vector Views, which instead use the

Background Color set in the **Preferences** dialog. See “Colors Panel” on page 63.

- 2 The **Show Backdrop in** options let you specify the conditions under which the selected backdrop image displays.
  - Specify in which **View Types** a backdrop image is used. By default, only Camera Views are set to use a backdrop. See “3D View Tools” on page 450.
  - Specify in which **Rendering Techniques** a backdrop image is used. See “Rendering Techniques” on page 478.

## 3D View Tools

Select **3D > Create Camera View** to display the Camera View Tools.

### Camera Views



The **Full Camera** tool creates multi-floor views of the 3D model. It can be used to create interior and exterior perspectives, and is good for displaying cathedral ceilings, roofs, lofts, stairwell openings, and other variation in floor and ceiling levels.



The **Floor Camera** tool creates perspective views of the current floor only. Nothing above the ceiling surface is generated, and neither is anything below the floor.

### Overviews



The **Full Overview** tool creates views of the entire model including all floors, ceilings, and the roof.



The **Doll House View** tool creates views of the current floor with the ceiling removed and all floors beneath it visible.



The **Framing Overview** tool creates views of the framing in the model. See “Framing Overview” on page 452.

### Elevation Views



The **Wall Elevation** tool creates views similar to the traditional, orthographic views often used in drafting. They are scaled and can be fully annotated. See “Elevation Views” on page 452.

- When an interior view is created, an elevation of a wall on a single floor and in a single room is shown.
- When an exterior view is created, the entire model is shown.

---

## Creating Camera Views

All Camera views are created using the same method.

### *To create a camera view*

1. In floor plan view, select the desired camera tool. The mouse pointer displays the camera  icon.
2. Click and drag a line to define the view direction.

- Where your line begins is the camera’s position.
- The line that you drag defines the direction the camera is pointed.
- The end of the line is the focal point of the view, the point the camera rotates around.
- By default, the field of view is 45°, which is similar to what the human eye sees or a 50mm camera lens.

## Camera Height

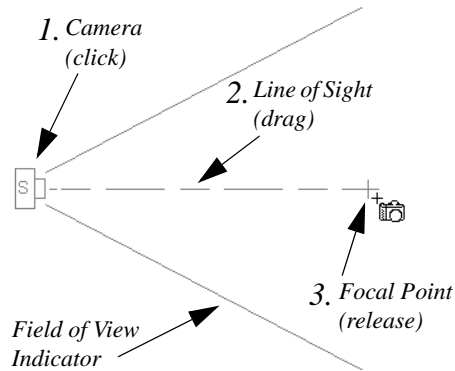

3. When you release the mouse button, a view generates in a new window.
4. Return to the floor plan view. A camera symbol now displays in floor plan view. See “Working in Multiple Views” on page 444.

By default, Cameras are created at a height of 60” (1500 mm). Where this height is measured from depends on the location of the camera:

- If the camera is inside of a room, it is measured from that room’s subfloor.
- If the camera is outside of a room but inside of the Terrain Perimeter, it is measured from the terrain at the location of the camera.
- If the camera is located in neither a room nor within the Terrain Perimeter, it is measured from the default height of the subfloor for the current floor.

Once created, a camera’s height can be modified in its **Camera Specification** dialog. See “Camera Specification Dialog” on page 467.

---

## Creating Overviews

Overviews generate as soon as you select the tool and are always created at the same angle. The focal point is always located at the center of the model; however, the position of the camera will vary depending on the size of the 3D model. The larger or more spread out the model, the further away the camera will be from the focal point so that the entire model can be seen in the view.

Once generated, an overview window’s title bar indicates its view type and a camera symbol representing the overview displays in floor plan view. The overview ‘camera’ can be edited much like regular camera views can. See “Editing 3D Views” on page 461.

### Full Overview



Select **3D> Create Camera View> Perspective Full Overview** to

generate an exterior view of the entire model.



### Doll House View



Select **3D> Create Camera View> Doll House View** to create a view of

the current floor with the ceiling removed and all floors beneath it visible.

Doll House Views are an effective tool for illustrating traffic flow and the relationships between spaces.



To see a different floor, select **Tools>**

**Reference Floors> Up One Floor**  or

**Down One Floor** . You can also return to

floor plan view and make another floor current before generating the Doll House View.

## Framing Overview



Select **3D> Create Camera View>**

**Framing Overview** to create a view of the entire model, displaying only framing and the foundation.

Select **3D> Create Camera View>**

**Framing Overview** to create a view of the entire model, displaying only framing and the foundation.



Framing overviews include all floor, wall, and roof framing as well as foundations.

---



## Elevation Views



The **Elevation** tool produces views in which all lines and dimensions are their true lengths, regardless of their distance from the camera.

Elevation views are the only 3D views that can be enhanced with the 2D CAD tools. They can be fully annotated and dimensioned and then printed to scale.

### *To create an Elevation view*

1. Select the **Elevation**  tool. The pointer changes to a  with crosshairs marking the position of the pointer.
  - Click in the building's interior to create an elevation of a wall on a single floor and in a single room.
  - Click outside of the building to create a view of the entire model.
2. Click and drag a line in floor plan view.
  - A Camera symbol displays where you click.

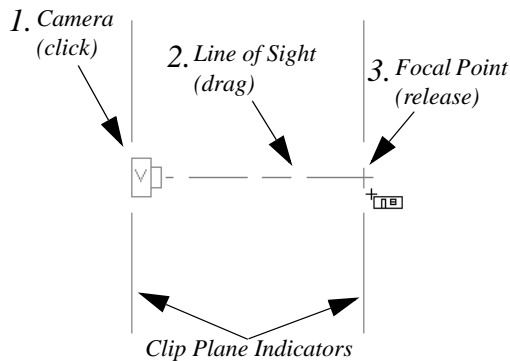

3. Drag in the direction of the Line of Sight to draw a camera arrow.
  - Always drag the camera arrow perpendicular to the wall to be viewed.
4. When you release the mouse button, the view generates in a new window.

If the Line of Sight does not cut through a 3D object, such as a window shown in elevation, the object retains its 3D definition and can be selected, moved, stretched, or otherwise modified in the view. The 3D model is updated in all views.

## Detailing Elevation Views



CAD objects, including Text and Dimensions, can be created in Elevation views. These objects are superimposed on the view and have no effect on the 3D model itself. If CAD objects have been added to an Elevation view, the program will prompt you to save the view before closing the window. This information is then stored in the view.

## Displaying 3D Views

A variety of tools and settings allow you to control the appearance of your 3D views. There are also numerous ways to adjust the position, focal point and field of view of a 3D view. See “Editing 3D Views” on page 461.

The name of the current plan file and the type of view displays at the top of each view window in its title bar. If a 3D view is saved, its name also displays.

There is no limit to the number of 3D view windows that you can have open at a given time; bear in mind, though, that each window demands use of your computer’s resources and that you may see poor performance if too many views are open. See “Working in Multiple Views” on page 444.

## Display Options



Which objects display in a 3D view is controlled in the **Display Options** dialog. See “Display Options Dialog” on page 77.

Different view types use different layer sets when they are created. See “Layer Sets” on page 76.

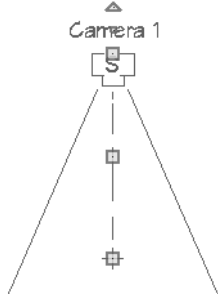

## In Floor Plan View

Cameras are represented in floor plan view by symbols that indicate the camera’s position, field of view and focal point.



You can also display camera symbols for saved cameras when the “Cameras” layer is turned on. See “Layers” on page 75.

The symbols for Elevation views and Full Overviews display on all floors, while those for Full and Floor Cameras and Doll House Views display only on the floor where the view was created. See “Creating Camera Views” on page 450.

You can move a camera to a different floor by clicking the **Up One Floor**  or **Down One Floor**  button while the camera view is active. Note that this may affect what is seen in the view as well as its display in floor plan view. See “Floor Up / Floor Down” on page 224.







Both saved and unsaved active cameras can have labels indicating the camera number or its name. Camera labels are located on the “Cameras, Labels” layer.

Camera labels are numbered sequentially in each plan in the order they were created.

Camera symbols are an on-screen reference: they do not print unless **Print Image** is used.

## In Rendered Views

There are a number of factors that contribute to the appearance of rendered 3D views:

- Select **3D> Toggle Textures**  in a 3D view to turn off the display of material textures. See “About Materials” on page 416. Not available in Glass House, Technical Illustration or Vector Views.
- Select **View> Color**  to toggle between color and greyscale in 3D views. See “Color On/Off” on page 107.
- Select **3D> Lighting> Adjust Lights**  to open the **Adjust Lights** dialog and edit the light sources in the current plan. See “Adjust Lights Dialog” on page 474.
- Select **3D> Lighting> Toggle Sunlight**  to turn on and off the light source that represents the sun. This feature can be used to simulate day vs. night exterior views. User defined exterior lights are turned off in day views and turned on in night views. See “Generic Sunlight” on page 473.
- Select **3D> Final View**  or **Final View with Shadows**  to regenerate the 3D view with improved quality and/or shadows. See “Previews vs Final Views” on page 471.

## In Vector Views

There are also a number of factors that affect the appearance of 3D Vector Views:

- Select **3D> Toggle Patterns**  in a Technical Illustration or Vector View to turn on or off the display of the “Patterns, 3D Views” layer, which controls the dis-

play of material pattern lines. See “Layers” on page 75.

- Select **View> Color**  to toggle between color and black and white to control the display line and fill colors. See “Color On/Off” on page 107.

### 3D Backdrops

A backdrop is an image, usually of an exterior view, that displays in the background of 3D views to help place the model into a realistic setting and add a sense of perspective. If a backdrop is not specified, Home Designer Architectural applies a background color. See “3D Backdrops” on page 542.

### Delete 3D Surface



The individual surfaces that make up objects can be temporarily removed from any 3D view by selecting **3D> Delete Surface** and then clicking on a surface. When the pointer is over a surface, that surface will become highlighted.

Surfaces removed in one view are removed in all 3D views, but are not permanently removed from the model. Continue clicking surfaces to remove them, then select another tool when you are finished.

Surfaces in 3D views are composed of multiple triangles. Hold the Alt key while clicking to delete one triangular face at a time rather than all triangles forming a surface.

To restore the most recently deleted surface, select **3D> Delete Surface**  or click the toolbar button.

There are several ways to restore all deleted surfaces:

- Select **Build> Floor> Rebuild Walls/Floors/Ceilings**,
- Exit the 3D view and reopen it.
- Generate a new 3D view.

### Rebuild 3D



Select **3D> Rebuild 3D** to regenerate all 3D data associated with the current plan. All open views will remain open.

---

## Repositioning Cameras

Once a 3D view is created, there are many ways to manipulate the camera location and the direction of its line of site using the mouse, the keyboard, and the menus.



When the keyboard or menu commands are used to move or rotate a camera, the adjustments occur in regular increments. The size of these increments is specified in the **Camera Specification** dialog:

- The **Incremental Move Distance** controls Panning movement and forward and backward Dolly movement.
- The **Incremental Rotate Angle** controls Orbit movement, Tilt movement, and side to side Dolly movement.

See “Camera Specification Dialog” on page 467.

Each time you move the camera, the view is updated. If you are using either the toolbar or keyboard to move the camera, you can hold down the Shift key, suppressing the redraw of the view until the Shift key is released and allowing you to move multiple increments more quickly.

 Press Ctrl + Alt + S while in a camera view or overview to spin the view. Press Esc to stop the spinning.

You can also move a camera to a different floor by clicking the **Up One Floor**  or **Down One Floor**  button while the camera view is active. Note that this may affect what is seen in the view as well as its display in floor plan view. See “Floor Up / Floor Down” on page 224.

## Mouse Scroll Wheel and Trackpad

3D views can be panned and zoomed when any tool is active using the mouse scroll wheel or trackpad gestures. See “Using a Trackpad” on page 26.

The program adjusts the speed of these actions depending on characteristics of the camera:

- Zoom speed depends on how close the camera is to the object located behind the mouse pointer. When the target object is far from the camera, zooming is faster; as the camera gets closer to the target, zooming slows.
- Panning speed depends on the length of the camera’s Line of Sight. In general, it is likely to be faster in an exterior view of a large model, slower in an interior view of a small room. See “Creating Camera Views” on page 450.

By default, panning and zooming adjusts the position and direction of the camera. It does not, however, adjust the distances at which surfaces are clipped. This means that if you zoom in closely on an object, some of its surfaces may be removed from the view. One

way to avoid this is to lower the camera’s **Clip Surfaces Within** value in the **Camera Specification** dialog. See “Camera Specification Dialog” on page 467.

Another way to avoid this is using **Perspective Crop Mode** .

When **Perspective Crop Mode**  is active, panning and zooming do not adjust the position of the camera. As such, using it can result in inconsistencies between a camera’s position and what is actually shown in the view. For this reason, it should only be used to zoom in closely on small objects or details.

### *To use Perspective Crop Mode*

1. Zoom in on an object that you would like to examine closely.
2. If any of its surfaces disappear, zoom out until they are restored.
3. Select **3D> Camera View Options> Perspective Crop Mode** .



4. Zoom in on the object, but try to limit any panning or other changes to the camera's perspective.

 Once Perspective Crop Mode has been enabled in a camera view, it should remain toggled on and navigation in that view should be limited.

### 3Dconnexion® 3D Mice

3Dconnexion®'s 3D mice can be used to navigate in all views - including camera views and overviews.

In the Windows version of Chief Architect, pre-programmed view direction hotkeys are supported on devices with buttons for that purpose. OS X does not provide mapping support to the view direction commands; however, you can create custom hotkeys for the commands in Chief Architect and then

program your 3D mouse to use those hotkeys. See Hotkeys.

You can specify whether navigation is centered about the camera or its focal point in the **Preferences** dialog. See “Render Panel” on page 66.

Note that rolling is not supported in Chief Architect and that 3D mice cannot be used to move the mouse pointer. For details about using your 3D Connexion® mouse, refer to its documentation.





### Move Camera with Mouse



An active camera's position can be edited using the mouse. Select **3D> Move Camera With Mouse** to access the

Move Camera with Mouse modes. These tools are not available in Elevation views.

	Hotkey	Description
	Alt + O	<b>Mouse-Orbit Camera</b> lets you move the mouse to rotate the camera around its focal point. The camera's position and direction both change.  To continuously rotate the camera around its focal point, click in the 3D view, drag the mouse, and release the mouse button to “throw” the view. Click again in the view to stop it from rotating.
	Alt + middle mouse button	To temporarily activate <b>Mouse-Orbit Camera</b> , hold down the Alt key and then click and drag using the middle mouse button. When the Alt key and middle mouse button are released, whatever tool was previously in use will still be active.

	Hotkey	Description
	Alt + P	<b>Mouse-Pan Camera</b> lets you move the camera up, down, left and right using the mouse. The camera's position changes, but its direction does not.
	Alt + D	<b>Mouse-Dolly Camera</b> lets you move the camera forward and backward by moving mouse up and down. Move the mouse left or right to rotate the camera side to side.
	Alt + T	<b>Mouse-Tilt Camera</b> lets you move the mouse to tilt the camera in any direction while staying in the same location.
		<b>3D Center Camera on Point</b> lets you focus the camera at a particular point in the scene. This changes the camera's direction and focal point, but not its position. To use the <b>3D Center</b> tool, activate the tool and then click on any object in the scene.
	Z	<b>3D Focus on Object</b> lets you focus the camera on a specific object. This changes the camera's position, direction, focal point, and the length of its line of sight. To use the <b>3D Center</b> tool, activate the tool and then click on any object in the scene.

## Move Camera with Keyboard

An active camera's position can be changed using the Arrow keys on your keyboard.

**Select 3D> Move Camera with Keyboard** to access the Move Camera with Keyboard modes. These modes are not available in Elevation views.

These modes use the **Incremental Move Distance** and **Incremental Rotate Angle** set in the active 3D view's **Camera Specification** dialog.







- **Keyboard-Orbit Camera** lets you use the keyboard to rotate the camera around the focal point. The camera's position and direction both change.
- **Keyboard-Pan Camera** lets you move the camera up, down, right, and left using the keyboard. The camera's position changes, but its direction does not.
- **Keyboard-Dolly Camera** lets you move the camera forward and back using the Up and Down Arrow keys, and rotate side to side using the Left and Right keys.
- **Keyboard-Tilt Camera** lets you use the Arrow keys to tilt the camera up, down, or side to side to change the focal point. The camera's direction changes, but its position does not.

## Move Camera Tools



Select **3D> Move Camera** in a 3D view to access these tools. These tools change the active camera's position, but not its direction and are not available in Elevation views.

These tools use the **Incremental Move Distance** set in the active 3D view's **Camera Specification** dialog.

	Hotkey	Description
	F	<b>Move Camera Forward</b> moves the camera and its focal point forward.
	B	<b>Move Camera Back</b> moves the camera and the focal point back.
	L	<b>Move Camera Left</b> moves the camera and the focal point to the left in a line perpendicular to the line of sight.
	R	<b>Move Camera Right</b> moves the camera and the focal point to the right in a line perpendicular to the line of sight.
	U	<b>Move Camera Up</b> moves the camera and the focal point up.
	D	<b>Move Camera Down</b> moves the camera and the focal point down.

## Orbit Camera Tools







Select **3D> Orbit Camera** in a 3D view to access these tools. Orbiting the camera rotates it about the focal point using the **Incremental Rotate Angle** set in

the active view's **Camera Specification** dialog.

These tools are not available in Elevation views.

	Hotkey	Description
	I	<b>Move Camera In</b> moves the camera closer to the focal point along the line of sight. The camera cannot move past the focal point using this tool.

	Hotkey	Description
	O	<b>Move Camera Out</b> moves the camera away from the focal point along the line of sight.
		<b>Orbit Camera Upward</b> rotates the camera up about the focal point. The camera cannot rotate past a vertical line looking straight down on the focal point.
		<b>Orbit Camera Downward</b> rotates the camera down about the focal point. The camera cannot rotate past a vertical line looking straight up at the focal point.
		<b>Orbit Camera Left</b> rotates the camera to the left about the focal point.
		<b>Orbit Camera Right</b> rotates the camera to the right about the focal point.





### Tilt Camera Tools



Select **3D> Tilt Camera** to access these tools. Tilting keeps the camera in one place and pivots the camera about its vertical or horizontal axis. This movement uses the **Incremental Rotate Angle** set in the active view's **Camera Specification**



dialog and is similar to tilting your head up and down or turning it side-to-side.





These tools are not available in Elevation views.

	Hotkey	Description
		<b>Tilt Camera Upward</b> tilts the camera up while keeping it in the same location. The camera cannot tilt beyond the vertical position.
		<b>Tilt Camera Downward</b> tilts the camera down while keeping it in the same location. The camera cannot tilt beyond the vertical position.
		<b>Turn Camera Left</b> turns the camera to the left while staying in the same location.
		<b>Turn Camera Right</b> turns the camera to the right while staying in the same location.

## View Direction Tools

 The **View Direction Tools** allow you to view the model from a specific direction in a camera view, overview, or Elevation view. While one of these views is active, select **3D> View Direction** to access these tools.

	Description
	<b>Front View</b> creates a front view of the model.
	<b>Back View</b> creates a back view of the model.

	Description
	<b>Top View</b> creates a top view of the model.
	<b>Bottom View</b> creates a bottom view of the model.
	<b>Left Side View</b> create a left side view of the model.
	<b>Right Side View</b> create a right side view of the model.
	<b>Restore Original View</b> restores the original view position.

## Editing 3D Views

In addition to its position and direction, there are other ways to modify a 3D view.

### In the Specification Dialog

 You can make adjustments to a camera view or overview in the **Camera Specification** dialog. This dialog is particularly helpful for making fine adjustments to the camera's position, appearance, and other attributes. See "Camera Specification Dialog" on page 467.

 Tile a 3D view and the floor plan view and use the camera movement tools to see how they affect the camera. See "Tiling Views" on page 445.

### Using the Edit Handles

Return to floor plan view without closing the 3D view. See "Working in Multiple Views" on page 444.

Using the **Select Objects**  tool, select the camera object. When a camera symbol is selected it displays four edit handles.

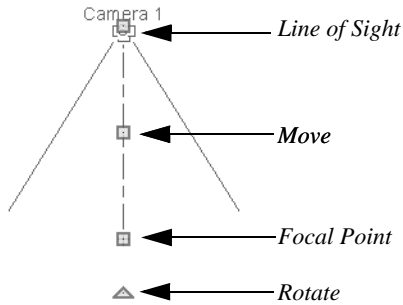

- Drag the **Line of Sight** handle to change the camera angle without moving the focal point.
- Drag the **Move** handle to relocate the camera while maintaining its relative angle.
- Drag the **Focal Point** handle to reposition the focal point and change the line of sight without moving the camera.
- Drag the **Rotate** handle to rotate the camera's line of sight about its center.

The 3D view corresponding to the camera symbol reflects changes made to the symbol in floor plan view.

Multiple camera symbols can be selected; however, their editing options are limited to being moved, rotated, and deleted.

### Using the Contextual Menu

In a 3D view, right-click in an empty space in which the backdrop or background color

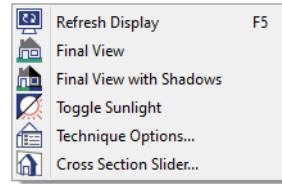

displays to access the contextual menu. See “Contextual Menus” on page 29.



- In Vector Views, the options are a selection of commonly used commands from the File, Edit, Tools and Window menus.
- In rendered views, the options are a selection of tools and toggles specific to rendered views.

### Up One Floor/Down One Floor

You can move a camera to a different floor. While the camera view is active, select **Tools > Reference Floors > Up One**

**Floor**  or **Down One Floor** . Note that this may affect what is seen in the view as well as its display in floor plan view. See “In Floor Plan View” on page 453.



The position and movement of a camera is affected by its location within the model. When the camera is outside a building, its height is relative to the terrain and follows the terrain as it is moved. When inside a building, the camera height is relative to the floor of the room it is drawn in.

If the camera is on an upper floor and you move the camera outside of the building, the camera remains at the same height relative to the floor it was created on.

## Zooming

 The **Zoom Tools** are available in all 3D views. See “Zoom Tools” on page 442.

Selecting **Window> Zoom In** , **Zoom**

**Out**  or **Fill Window**  does not change the camera’s location or field of view.

Instead, the extents of the view are expanded or cropped.

## Field of View

The **Field of View** refers to a camera’s field of vision. A wider field of view makes the focal point appear further away, as more of

the image is included in the same view window.

In floor plan view, the angled lines of a camera symbol indicate its field of view.

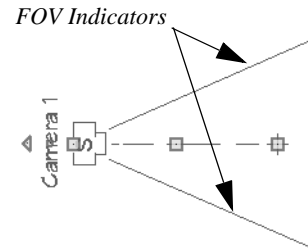

A camera’s field of view can be adjusted in the **Camera Specification** dialog. See “Camera Specification Dialog” on page 467.

---

## Cross Section Slider

 Select **3D> Cross Section Slider** when a camera view or overview is active to open the **Cross Section Slider** dialog.

Note: The Cross Section Slider is not available when the Vector View Rendering Technique is used. See “Rendering Techniques” on page 478.

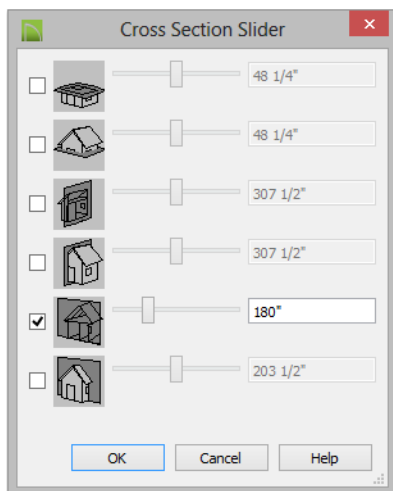

### *To use the Cross Section Slider*

1. Check the box beside a cross section cutting plane to select it and make its Position slider and text box active.
2. Move the Position slider to adjust the position of the cutting plane.
  - The cutting plane Position is measured from the edge of the model that is cut first by the selected cutting plane.
3. Repeat steps 1-3 to use additional cutting planes if you wish.
4. Click **OK** to close the dialog. If the active camera is saved, its Cross Section Slider settings will also be retained. See “Saving 3D Views” on page 466.

---

## Working in 3D

A variety of tools are available in 3D views that allow you to edit your 3D model. You can also use the Dimension, Text, and CAD Tools to add annotation to Elevation views.

### Creating Objects in 3D Views

You can place windows, doors, and most library objects directly into 3D views. To do this, select the appropriate tool and click in

the 3D view. You can then edit the object’s size and placement.

When created in 3D, most objects must be placed against a wall, on a floor platform, or within the Terrain Perimeter.

You can also click and drag to draw some objects such as terrain features and road, in camera views and overviews views.



## Selecting and Editing Objects in 3D Views

Most objects can be selected and edited in 3D views. Select **Edit> Select Objects**  and click on the surface of an object to select it. Once selected, objects can be edited using their edit handles, buttons on the edit toolbar, and the object's specification dialog. See "Editing Objects" on page 87.

When you select an object, edit handles and a handle surface display. The handle surface is a rectangle around the perimeter of the object that indicates the overall height and width of the selected surface. The edit handles that display depend on the type of object selected. Walls, for example, display two resize edit handles when selected while a slab displays ten handles, allowing you to move, resize and reshape it.

Note: If the wall height of the Exterior Room is adjusted in a 3D view, the default Floor or Ceiling Height of the entire floor is changed. See "Floor and Room Defaults" on page 160.

All moving or resizing is in the plane of the handle surface. You cannot move an object directly towards or away from the camera, for example, because that surface plane cannot be seen in the view.

By default, object movement is restricted to one inch or 10 mm increments. See "Grid Snaps" on page 81.

Unrestricted positioning can also be enabled by holding down the Ctrl key while moving or resizing an object. See "Unrestricted Movement" on page 109.

Temporary dimension lines display when many objects are selected to help you resize the object and determine its height. These are sometimes easier to see when the color is toggled off. See "Color On/Off" on page 107.

Because Elevation views are orthogonal and display objects at their actual dimensions, they are sometimes more suitable for editing objects than camera views or overviews. See "Elevation Views" on page 452.

When several 3D views are open, changes made in the plan automatically rebuild the model in all views. Because of this, it is typically faster to make changes to your plan with as few windows open as possible.

## Editing Materials in 3D Views



Select **3D> Materials> Adjust Material Definition**, then click on a surface in the 3D view to open the **Define Material** dialog for that material. See "Adjust Material Definition" on page 424.



Select **3D> Material Painter** to apply materials to surfaces in the view using the Material Painter Tools. See "The Material Painter" on page 417.



Select **3D> Material Painter> Material Eyedropper** to apply the material on a surface in the view to other surfaces in the view. See "Material Eyedropper" on page 420.

## Rebuild 3D



As changes are made to your plan, a 3D view automatically updates to reflect any changes visible in the view. If you find that a view is not updating as expected,

select **3D> Rebuild 3D** to rebuild the entire 3D model.

## Annotating 3D Views

The Manual Dimension tool, Text Tools, and CAD Tools are available in Elevation views,

allowing you to add technical information, call attention to details, and other tasks in these views. See “Detailing Elevation Views” on page 453.

---

## Saving and Printing 3D Views

3D camera views, overviews and Elevation views can be saved with the plan in which they are created, exported and saved as image files, as well as printed.

### Saving 3D Views



Select **3D> Save Active Camera** to save the current camera in the plan.



You can also save a camera view by checking the **Saved** box in the **Camera Specification** dialog. See “Camera Specification Dialog” on page 467.

Saved cameras can be closed and re-opened for later use, and retain their Cross Section Slider, Shadows, and Rendering Technique settings. See “Cross Section Slider” on page 463, “Adjust Sunlight Dialog” on page 477, “Shadows” on page 470, and “Rendering Techniques” on page 478.

In addition, if CAD or Text objects are drawn in an Elevation view, you will be prompted to save the view when you close it. Any CAD or Text objects added to an Elevation view are saved with the view as part of the plan file.

### Activating Saved Views

There are three ways to open a saved 3D view:

- Select the camera symbol in floor plan view and click the **Open View**  edit button.
- Double-click the camera symbol using the **Select Objects**  tool.
- Right-click on it and select **Open View** from the contextual menu.

Unsaved cameras that are open in another view window can also be activated using the **Open View**  edit button.

If you open a saved camera view and then modify its location or direction using any of the tools available in that view, the program will confirm whether you want to re-save the camera using these new settings when you close it. See “Repositioning Cameras” on page 455.

### Exporting 3D Views



All 3D views can be exported and saved as .bmp, .jpg, .png, or .tif files. Select **File> Export> Picture** to save the current screen image as an image file. See “To export a picture” on page 536.

In addition, Vector Views can be exported and saved as .emf files. See “Metafiles” on page 537.

Once saved, a picture can be opened and converted into many other formats using a graphics program.

## Printing 3D Views



Since all 3D views other than Vector Views are created using pixels instead of lines, **File>Print>Print Image** must be used when printing. **Print Image** is a special

Home Designer Architectural function that prints the screen in picture format. The entire view prints, including images such as plants and textures.

The quality of your print image is affected by your current window size and screen resolution. To maximize the quality of your printed image, generate it in full screen size and use the maximum screen resolution.

## Camera Specification Dialog



The **Camera Specification** dialog can be accessed in floor plan view by selecting a camera symbol and clicking the **Open Object** edit button. See “In Floor Plan View” on page 453.

This dialog can also be accessed while a camera view or overview is active by selecting **3D>Edit Active Camera** .

The selected view’s specific type is indicated in the dialog’s title bar: the specification dialog for a **Full Camera** , for example, is named **Full Camera Specification**.

Note: Elevation views do not have a specification dialog. See “Elevation Views” on page 450.

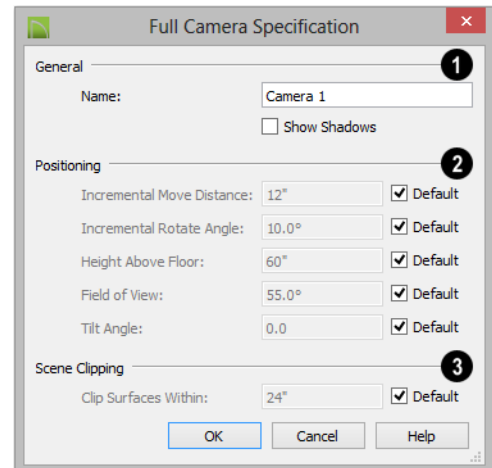

To change a setting, first uncheck **Default**, then type a new value in the text field.

- 1 Specify the **Name** that displays in the camera label in floor plan view.
- Check **Show Shadows** to turn on shadows in the selected camera view. When unchecked, shadows are not generated. See “Shadows” on page 470.
- 2 The **Positioning** settings determine the position and orientation of the camera. See “Repositioning Cameras” on page 455.

- The **Incremental Move Distance** controls how far the camera moves each time you Pan in any direction or Dolly forwards or backward. For interior views a small number is good, but for exterior you may want a larger increment.
- The **Incremental Rotate Angle** defines how many degrees the camera rotates each time you Tilt, Orbit, or Dolly side to side. A setting of 90° would make one full rotation in four moves.
- The **Height Above Floor** defines the height that the camera is above the floor level for the current floor. See “Camera Height” on page 451.
- The **Field of View** defines the camera’s field of vision in angular degrees. See “Field of View” on page 463.



You can increase a camera’s Field of View when the view is active by pressing the W key, or decrease the Field of View by pressing the N key.

- The **Tilt Angle** determines the vertical angle that the camera is tilted. The camera maintains its focal point and position in floor plan view, but if the camera is tilted, the focal point is above or below the current camera height.
- ③ The **Scene Clipping** settings control the extents of the camera view.
- **Clip Surfaces Within** - Objects located within this distance from the camera do not display in the view. Decrease this value to display objects located very close to the camera; increase it to improve the appearance of some surfaces in Overview cameras with very large extents.

# 3D Rendering

There are a variety of tools available to create 3D views of a model: simply click a button to create an overview, or click and drag to create a camera or elevation view. See “3D Views” on page 447.

To improve the quality of the rendering and create a custom look, you can adjust lighting, edit the materials used in the plan, choose from several rendering techniques and fine-tune 3D view quality settings. From most 3D views, you can create Final views of even higher quality.

## Chapter Contents

- Rendering Tips
- Lighting
- Displaying Lights
- Light Types
- Light Specification Dialog
- Adjust Sunlight Dialog
- Rendering Techniques
- Rendering Technique Options
- Speeding up 3D View Generation

## Rendering Tips

There are a variety of factors which affect the appearance and quality of rendered 3D views. You can use these tools and settings to achieve renderings that meet your needs.

### Lighting

Lighting is extremely important in most 3D renderings. Lighting controls the visibility of objects in a view, affects the appearance of surfaces, and influences the appearances of colors and textures on those surfaces. Even small changes to light intensity, direction and color can have a large impact on image quality. See “Lighting” on page 472.



### Shadows

Like lighting, shadows have an important effect on image quality. Shadows can be generated in any type of camera view using any Rendering Technique aside from Vector View and Glass House. See “Rendering Techniques” on page 478.

There are two ways to generate shadows in Home Designer Architectural: standard and legacy shadows. Standard shadows generate more quickly than legacy shadows but are of lower quality, while legacy shadows are slower but generally of higher quality.

**Legacy Shadows** can be enabled or disabled in the **Preferences**  dialog and will be enabled automatically if your video card does not support standard shadows. See “Render Panel” on page 66.

Because they can be time-consuming, by default shadows are only generated in **Final**

**Views with Shadows** . You can, however, select **3D> Lighting> Toggle Shadows**  in a camera view to turn shadows on or off.

Shadows are affected by the number of light sources in a plan, as well as what Rendering Technique is in use. In order for a light source to cast shadows, it must be On in the current view and have **Cast Shadows** checked in its specification dialog. See “Light Data Panel” on page 297.

When standard shadows are enabled, sunlight can shine through windows into interior rooms. See “Generic Sunlight” on page 473.

### Reflections

Reflections are another aspect of lighting that can increase a 3D view’s realism. When a flat surface is assigned a Mirror material, it can display the reflections of other objects in the scene.

Note that a Mirror surface cannot display the reflection of another mirror. When one mirror can be seen in another, its material is shown rather than a reflection.

Reflections only generate in Perspective 3D views using the Standard Rendering Technique and can slow down 3D view generation and responsiveness considerably and are turned off by default in rendered Previews. They can be turned on and off for both Previews and Final Views in the **Preferences** dialog. See “Render Panel” on page 66.

## Material Textures

Textures are graphic files that represent contoured surfaces of objects such as carpet, bricks, tile, and wood in 3D views. Textures are assigned to materials which in turn are assigned to objects. See “Patterns and Textures” on page 416.

The display of materials in 3D views is controlled by settings in the **Define Material** dialog. See “Define Material Dialog” on page 429.

Brightness, shininess and transparency control how light sources affect the display of surfaces in 3D views. See “Lighting” on page 472.

If no texture is selected for a material or if the display of textures is turned off, affected surfaces are a solid color instead.

## Images

Images are very important for the appearance of 3D views. Images are picture files that represent individual objects such as trees, flowers, and vehicles. See “Placing Images” on page 530.



## Backdrops



A backdrop is an image, usually of an exterior view, that displays in the background of 3D views to help place the model into a realistic setting and add a sense of perspective. If a backdrop is not specified, Home Designer Architectural applies a background color. See “3D Backdrops” on page 542.

## Previews vs Final Views

When a rendered 3D view is first created, it uses quality settings that allow the view to generate quickly but with reasonable quality.

Final Views produce much higher quality images that are more suitable for printing or saving as graphics files. Final Views often take significantly longer to generate than Previews, so the 3D view reverts back to the Preview settings as soon as anything is changed within the view.

When you have finished making adjustments in the 3D view, select **3D> Final View**  or **Final View with Shadows** .

**Final View**  and **Final View with Shadows**  are not available in Vector Views. See “Rendering Techniques” on page 478.

## Halt Generation with Esc Key

Using the Esc key, you can interrupt the modeling process at any point and display the incomplete model “as is.” This is particularly helpful when you just need to reorient a model on the screen for a specific angle or view.

The Esc option allows you to place the view quickly, then press the F5 function key to refresh the display with all 3D faces intact.

## Lighting

In 3D views, lighting is calculated on a room-by-room basis; only the light sources in the room containing the camera are used.

When the camera is outside a building, the program normally uses sunlight for lighting calculations and turns off all other light sources. You can turn the sunlight off and use all the other exterior lights to simulate night time views.

The maximum number of light sources that can be turned on in a view at the same time is determined by your video card. If your video card's maximum number of lights is eight, the program only uses the eight light sources closest to the camera's position. You can manually turn on and off individual lights in order to get the desired lighting effects. See "Displaying Lights" on page 473.

Each individual light source has a set of properties, such as intensity and color, that can be defined. See "Light Data Panel" on page 477.

There are four ways to create light sources for 3Dviews:

- Default Interior Light
- Light Fixtures
- Added Lights
- Generic Sunlight

### Default Interior Light

If you create an interior 3D view of a room and no lights have been placed there, the program creates a Default Light source within that room. The Default interior light acts like a central point light source.

The Default Light cannot be adjusted in any way. If you want to control the light in an interior 3D view, you must add a light to the room that you are rendering by placing a lighting fixture or by adding a light source using **3D> Lighting> Add Lights** .

### Light Fixtures

An electric symbol that represents a Light Fixture has a light source associated with it. Properties for the light source such as color and intensity can be modified in the fixture's specification dialog. See "Electrical Service Specification Dialog" on page 295.

### Added Lights



In floor plan view, select **3D> Lighting> Add Lights** to quickly add a light source to a plan. Added Lights and their labels are placed on the "Light Sources" and "Light Sources, Labels" layers.

Added lights only act as light sources in plan files that have at least one room defined. They display 2D symbols in floor plan view but do not display as objects in 3D views.

While Added Lights do not display as objects in 3D, you can specify that an Added Light's position be represented by a cross hairs in rendered views that use lighting. See "Light Data Panel" on page 297.

Added lights can be placed into objects that normally do not generate light, such as a TV.

There are three types of added light sources:

- Parallel Light sources
- Point Light sources



- Spot Light sources

See “Light Types” on page 475.

## Generic Sunlight

When you create a 3D view, the program creates a **Generic Sun**. The Generic Sun acts like a parallel light source but its position is not based on any real world locations.

When standard shadows are enabled, sunlight can shine through windows into interior rooms. See “Shadows” on page 470.

The Generic Sun’s intensity, color, and angle can be modified in the **Adjust Sunlight** dialog. In addition, you can specify that it follow the camera in 3D views so surfaces are always illuminated. See “Adjust Sunlight Dialog” on page 477.

Select **3D> Lighting> Toggle Sunlight**  turn the Generic Sun on or off to simulate either daytime or nighttime exterior lighting.

## Displaying Lights



The display of light fixtures and Added Lights in floor plan and 3D views is controlled in the **Display Options** dialog. See “Display Options Dialog” on page 77.

In addition, they can serve as sources of light in rendered 3D views. They can be turned on and off, as well as set to cast shadows.

### In Floor Plan View

Light fixtures are placed on the “Electrical” layer, and Added Lights, on the “Light Sources” layer. See “Displaying Objects” on page 76.

In floor plan view, both light fixtures and Added Lights can display labels when the “Electrical, Labels” and/or “Light Sources, Labels” layers are turned on.

An Added Light’s label in floor plan view indicates which of these attributes the light has:

- R - Used in Standard rendered views.

- S - Casts shadows.
- No letters - Light is not turned on.





*A Point Light that casts shadows in Standard rendered views*

### In 3D Views

Both light fixtures and Added Lights can serve as sources of light in rendered views.

#### *To turn a light on or off*

There are several ways to turn a light fixture or Added Light on or off:

- Select one or more fixtures or Added Lights and click the **Turn Light(s) Off in 3D**  or **Turn Light(s) On in 3D**  edit button.

- Uncheck **On** in the object's specification dialog. See "Light Data Panel" on page 297.
- Clear the **On/Off** checkbox in the **Adjust Lights** dialog.

Added Lights are not associated with a 3D fixture, but you can specify that any light source's location be represented in rendered 3D views using a cross hairs. See "Light Data Panel" on page 297.

Light source position indicators will only display when the light is in use in the current 3D view. That is, it must be:

- Turned on.
- One of the light sources in use per your video card's limitations.
- Either located in a room or in a view with Sunlight toggled off.

Sunlight will shine through windows into interior rooms when shadows are enabled. See "Shadows" on page 470.

## Adjust Lights Dialog



Light sources in the current plan - including light fixtures and Added Lights - can be accessed and edited using the **Adjust Lights** dialog. Select **3D> Lighting>**

**Adjust Lights** to open this dialog in floor plan or any 3D view.

The **Adjust Lights** dialog is an efficient way to control which lights are turned on in 3D views.

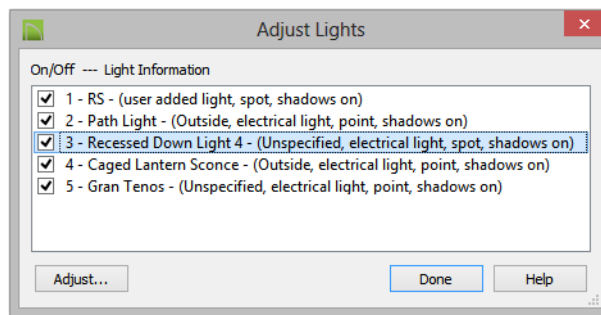

All lights in the current plan are listed here using the same names as their labels. Additional information about each light follows in parentheses.

- Check the box beside a light's name to turn it on or uncheck the box to turn it off.
- To adjust the properties of a light in the list, double-click on its name or select it and click the **Adjust** button. Make

changes to the light in its specification dialog and click **OK**. For more information, see "Adjust Sunlight Dialog" on page 477, "Light Specification Dialog" on page 476 or "Electrical Service Specification Dialog" on page 295.

Multiple lights can be selected by holding down the Shift key. If multiple lights are selected, clicking the Adjust button opens the

**Light Data** dialog, which is similar to the LIGHT DATA panel of a single object's specification dialog.

If you are in a 3D view that displays lighting, the view will regenerate based on the new light settings.

The Generic Sun is not listed in this dialog. See "Generic Sunlight" on page 473.

---

## Light Types

There are three types of light source, each of which generates light in a different way and allows you to create a variety of lighting effects:

- Parallel Light sources
- Point Light sources
- Spot Light sources

Parallel, Point, and Spot lights can be specified for electrical light fixtures in the **Electrical Service Specification** dialog. See "Light Data Panel" on page 297.



In addition, these three light types can be placed in a plan as **Added Lights**, which are light sources that are not associated with a fixture. As with light fixtures, the lighting properties of Added Lights can be specified in their specification dialog. See "Light Specification Dialog" on page 476.

### Parallel Lights



A **Parallel Light** has a direction but no position. The light appears to illuminate all objects with equal intensity, as if it were at an infinite distance from the object. A Parallel Light source is commonly used to simulate distant light sources, such as the sun and works best when placed on the exterior of a structure.

### To add a Parallel Light

1. In floor plan view, select **3D> Lighting> Add Lights** .
2. Click and drag in floor plan view two or more plan feet (600 mm) in any direction.
3. When you have dragged a sufficient distance, the light preview will change to a parallel light icon.
4. When you release the mouse, a parallel light pointing in the direction that you dragged is created.

### Point Lights



Like a bare light bulb, a **Point Light** radiates light equally in all directions from its origin. Point lights are a realistic representation of non-directional electric lighting.

If no user defined light exists, Home Designer Architectural creates a Point Light source to represent a light within a room. Any light source, except a Sun Angle, can be changed into a Point Light.

### To create a Point Light source

1. In floor plan view, select **3D> Lighting> Add Lights** .

- Click in floor plan view. Do not drag the pointer when you click the screen, or you will create a spot or parallel light.

## Spot Lights



A **Spot Light** focuses the light in a specified direction. The location, tilt angle, intensity, and more can be specified in a Spot Light's specification dialog.

### To create a Spot Light source

- In floor plan view, select **3D> Lighting> Add Lights** .
- Click and drag in floor plan view no more than two plan feet (600 mm) in any direction.

- As you drag, the light preview will look like a Spot Light icon. If you drag too far, it will change to a Parallel Light icon.
- When you release the mouse, a Spot Light pointing in the direction that you dragged is created.

You can also use a Spot Light's edit handles in floor plan view to move it, as well as change its direction and Cut Off Angle.

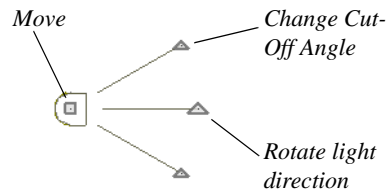

## Light Specification Dialog



Select one or more Parallel, Point or Spot Lights and click the **Open Object** edit button to open the **Light Specification** dialog.

You can also select **3D> Lighting> Adjust Lights**  to access a list of the light sources present in the current plan and open the specification dialog for any of them. See "Adjust Lights Dialog" on page 474.

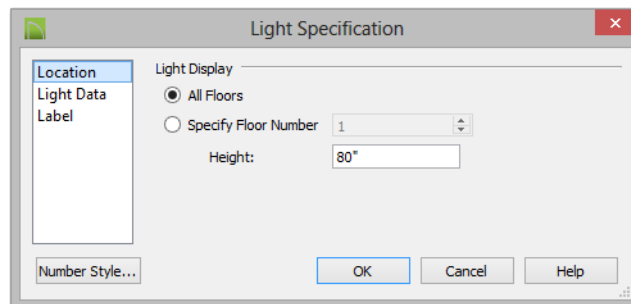

Note: The floor or floors that an Added Light displays on in floor plan view is totally independent of where it displays in 3D.

## Light Data Panel

The settings on this panel are also found on the same panel of the **Electrical Service Specification** dialog. See “Light Data Panel” on page 297.

Depending on the type of light selected, the options available here may vary.

## Adjust Sunlight Dialog

 The **Adjust Sunlight** dialog allows you to control the intensity, direction and color of the Generic Sun light source in the currently active 3D view in the currently active view. See “Generic Sunlight” on page 473.

To open this dialog, select **3D > Lighting >**

**Adjust Sunlight**  while a 3D view is active.

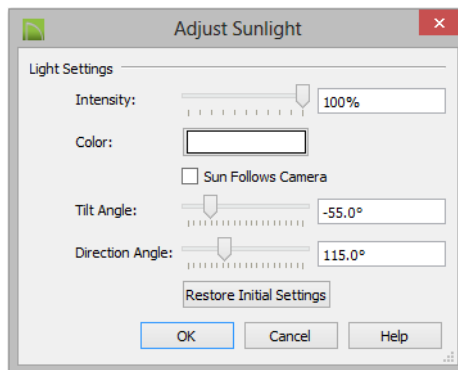

- Use the **Intensity** slider bar or text field to control how bright the Generic Sun light appears.
- Click the **Color** bar to define the color of the light being modeled. Colored sunlight may be used to achieve special lighting

effects, but may alter the appearance of your material colors and textures.

- Check **Sunlight Follows Camera** to adjust the position of the Generic Sun so that it is always behind the camera, illuminating surfaces in the view. When this is checked, the Tilt and Direction Angle settings that follow are disabled.
- Specify the **Tilt Angle**, which is the angle of the sunlight with respect to the horizon. A value of 90° means that the light points straight up, while a value of -90° means that the light points straight down. 0° is parallel to the horizon.
- Specify the **Direction Angle**, which is the direction that the sunlight points toward. 0° is measured horizontally on screen, pointing to the right. Positive values rotate in a counter-clockwise direction from there, while negative values rotate clockwise.
- Click the **Reset to Defaults** button to restore the original Generic Sun settings.

By default, the Generic Sun light color is pure white, which has the least effect on the appearance of material colors and textures. See “Materials” on page 415.

## Rendering Techniques



Any camera view elevation view, or overview can be generated using one of several Rendering Techniques to produce views for a range of different purposes.

When a 3D view is active, select **3D> Rendering Techniques** to access these tools.

Once a view is created, the effects of the selected rendering technique can be adjusted in the **Rendering Technique Options** dialog. See “Rendering Technique Options” on page 479.

If a camera view is saved, its Rendering Technique settings are saved, as well. See “Saving and Printing 3D Views” on page 466.

### Standard Rendering



**Standard** rendering is a photo-realistic technique that represents materials using textures, models lighting, and can also display shadows. Surface edge lines are not drawn and no special colors or effects are applied. Lighting is limited to the room containing the camera and the capabilities of your video card.



In floor plan view, the camera symbol for a view using the **Standard** technique displays an S

in its center. See “Displaying 3D Views” on page 453.

### Vector View



In Vector Views, surface edge lines are drawn and pattern lines and colors are used to represent materials. Textures, lighting, and shadows are not used, and special colors and effects are not applied.

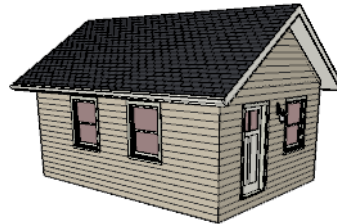

In floor plan view, the camera symbol for a view using the **Vector View** technique displays a V in its center.

### Glass House

**Glass House** rendering uses different shades of a single color to display the model with surface edge lines and semi-transparent surfaces. Lighting and shadows are not modeled, and materials are not represented, so neither pattern lines nor textures are used.

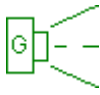

 In floor plan view, the camera symbol for a view using the **Glass House** technique displays a G in its center.

### Technical Illustration

 **Technical Illustration** rendering draws surface edge and pattern lines, and uses shades of two colors, Warm and Cool. The warm shade is applied to surfaces that face the light source in the view, and the cool shade, to surfaces that face away from it.

Only one light source is used: the light with the highest Intensity found in the room containing the camera. In exterior views, this light is always the Generic Sun. If no lights are on, a fallback light is used. Lighting is modeled as non-photorealistic, stylized highlights and shadows are supported. See “Lighting” on page 472.

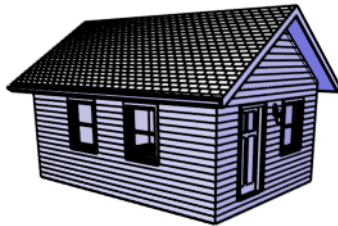

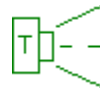
 In floor plan view, the camera symbol for a view using the **Technical Illustration** technique displays a T in its center.

### Watercolor

 Watercolor rendering approximates the effects of watercolor painting such as pigment pooling and flow. It uses textures to represent materials and models lighting and shadows.

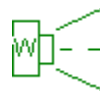

 In floor plan view, the camera symbol for a view using the **Watercolor** technique displays a W in its center.

Note: In some plans, the Watercolor techniques may take a considerable amount of time. You can press the Esc key to cancel the rendering.

---

## Rendering Technique Options

 The settings in the **Rendering Technique Options** dialog allow you to control the specific effects of each rendering technique on an active 3D view. To access this dialog, create a camera view, elevation view, or overview and select **3D> Rendering Techniques> Technique Options**.

In the **Rendering Technique Options** dialog, select a technique from the list on the left to make its options active on the right. When this dialog is first opened, the technique currently used by the view is selected.

As changes are made in the **Rendering Technique Options** dialog, the 3D view automatically updates to reflect those changes for all techniques except Watercolor. To update views using these techniques,

which take more time to draw than the others, click the **Update** button in the dialog.

When a 3D view is saved, its Rendering Technique Options settings are saved, as well. See “Saving 3D Views” on page 466.

### Standard Panel



The active 3D view immediately updates to reflect any changes made to the Rendering Technique Options for Standard renderings. here are a variety of

other tools that affect the appearance of Standard rendered views, as well. See “Displaying 3D Views” on page 453.

### Vector View Panel



.There are no Rendering Technique Options for Vector View rendering.

There are, however, a variety of other tools that affect the appearance of Vector Views. See “Displaying 3D Views” on page 453.

### Glass House Panel



The active 3D view immediately updates to reflect any changes made to

the Rendering Technique Options settings for Glass House renderings.

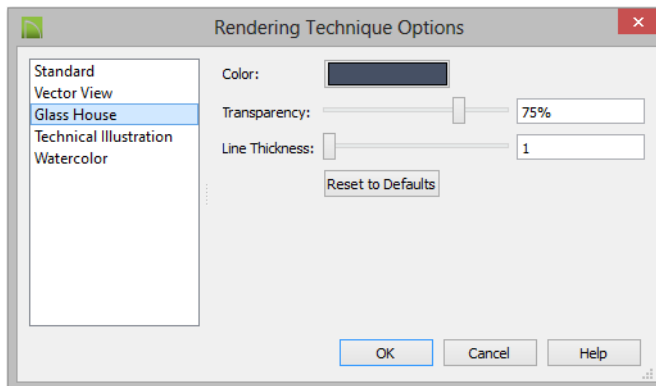

- Click the **Color** bar to select a color for the semi-transparent surfaces and lines in a Glass House view. See “Select Color Dialog” on page 438.
- Specify the **Transparency** of the surfaces in Glass House view. For example, to create a wireframe line drawing of your structure, turn transparency to full and minimize line thickness.



- Specify the **Line Thickness** of surface lines in Glass House view.
- Click **Reset to Defaults** to restore the default settings used when the Glass House technique was first enabled.

## Technical Illustration Panel



The active 3D view immediately updates to reflect any changes made to

the Rendering Technique Options settings for Technical Illustration renderings.

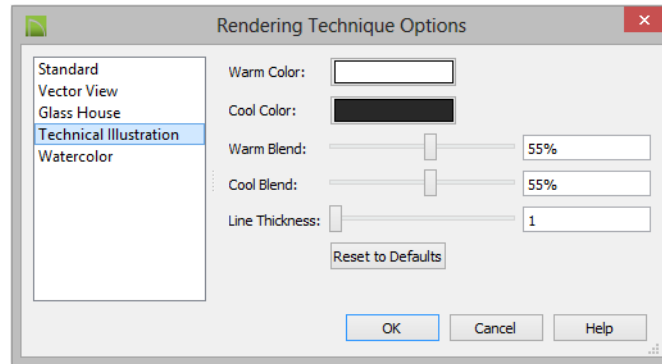

- Click the **Color** bar to select a **Warm Color** for surfaces that face the light source and a **Cool Color** for surfaces that face away from the light. See “Select Color Dialog” on page 438.
- Specify the **Warm Blend**, which is the degree to which the selected Warm Color is blended with original colors on well-lit surfaces in the view.
- Specify the **Cool Blend**, which is the degree to which the selected Cool Color is blended with original colors on shaded surfaces in the view.
- Specify the **Line Thickness** of all surface edge and pattern lines in the view.
- Click **Reset to Defaults** to restore the default settings used when the Technical Illustration technique was first enabled.

## Watercolor Panel



In order for the active 3D view to reflect changes made to the Rendering

Technique Options settings for Watercolor renderings,

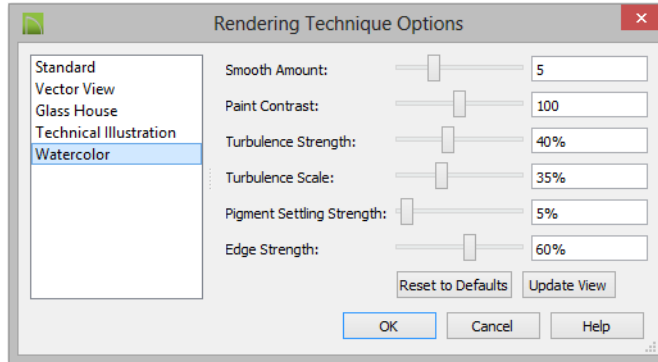

- Specify the **Smooth Amount**, which is the degree to which details are removed from the original view.
- Specify the **Paint Contrast**, which determines the extent to which variations in pigment color are used.
- Specify the **Turbulence Strength**, which produces “pooling”, or variations in the strength of pigment colors.
- Specify the **Turbulence Scale**, which controls the size of the areas of pooling.
- Specify the **Pigment Settling Strength**, which creates the appearance of pigment settling into low areas in paper.
- Specify the **Edge Strength**, which is how well-defined surface edge lines are.
- Click **Reset to Defaults** to restore the default settings used when the Watercolor technique was first enabled in this view.
- Click **Update View** to apply these settings to the active 3D view.

## Speeding up 3D View Generation

When you have a large, complex model with a lot of detail, it may take some time to generate a 3D view of everything in the model. During this process, progress information may display in the Status Bar and in a message window.

There are several ways to speed up the generation time of views.

### Halt Generation with Esc Key

In a large, complex model, repositioning the camera can be time-consuming. You can

speed up this process using the Esc key. When you press the Esc key, the modeling process is interrupted and the view is displayed “as is”. Then, press the F5 key to refresh the display.

### Turn Off Layers



The display of objects in 3D views can be turned on or off in the **Display Options** dialog. Turning off unneeded layers in 3D views can speed up 3D view

generation time. See “Display Options Dialog” on page 77.

balance rendering quality and generation time. See “Render Panel” on page 66.

## Rendering Preferences



In the **Preferences** dialog, there are a number of settings that you can use to



# Dimensions

Home Designer Architectural provides a variety of dimensioning tools for measuring walls, doors, windows, and many other objects.

Dimensions can be used to accurately position objects relative to other objects. In addition, dimension lines and extensions can be selected and customized.

## Chapter Contents

- Dimension Unit Defaults
- Dimension Defaults Dialog
- The Dimension Tools
- Displaying Dimension Lines
- Editing Dimension Lines
- Editing Extension Lines
- Moving Objects Using Dimensions
- Dimension Line Specification Dialog

---

## Dimension Unit Defaults

All plan files save measurements in either Imperial or metric units. The type of unit used is determined when the file is first

created and cannot be changed later. See “Creating a New Plan” on page 44.

---

## Dimension Defaults Dialog



Select **Edit > Default Settings**, select “Dimension”, and click the **Edit** button to open the **Dimension Defaults** dialog.

The settings in this dialog are dynamic defaults, which means that any changes

made here may affect existing dimension lines in the drawing that are using default values. See “Dynamic Defaults” on page 59.

## Setup Panel

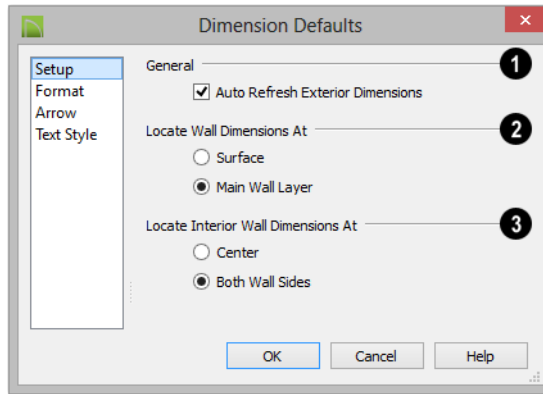

**1** Uncheck **Auto Refresh Exterior Dimensions** to prevent Auto Exterior Dimensions from being regenerated as changes are made to the plan. When checked, Auto Exterior Dimensions will be created when walls enclose a room area and will refresh whenever walls, doors, or windows are added or moved. See “Auto Exterior Dimensions” on page 489.

**2** Specify how Manual and Auto Exterior Dimension lines locate both interior and exterior walls.

- Select **Surfaces** to have dimensions locate the outer surfaces of walls.

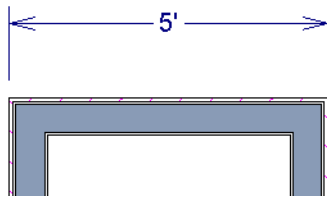

*Dimensions locating wall Surfaces*

- Select **Main Wall Layer** to have dimensions locate the structural Main Layer of

exterior walls. See “Wall Type Definitions” on page 142.

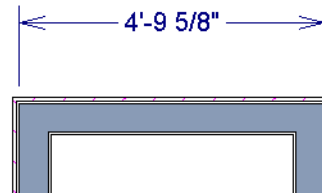

*Dimensions locating walls' Main Wall Layers*

**3** Specify how Manual and Auto Exterior Dimension lines locate interior walls.

- Select **Centers** to have exterior dimensions locate the centers of interior walls.

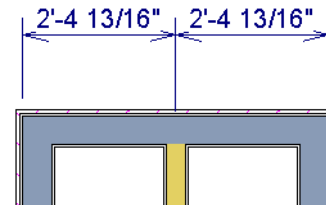

*Dimensions locating an intersecting wall's center*

- Select **Both Wall Sides** to have dimensions locate both sides of interior walls. Either the wall Surfaces or both sides of the Main Wall Layers will be located, depending on your selection above.

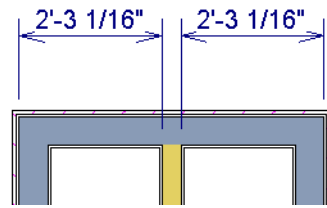

*Dimensions locating an interior wall's Main Wall Layer*

You can always change the object or surface that a dimension locates after it has been created. See “Editing Extension Lines” on page 493.

## Format Panel

The settings on the **FORMAT** panel allow you to specify the units, degree of accuracy, and position of dimension numbers.

The settings on this panel also control the format of numbers indicating object length in the Status Bar. See “The Status Bar” on page 33.

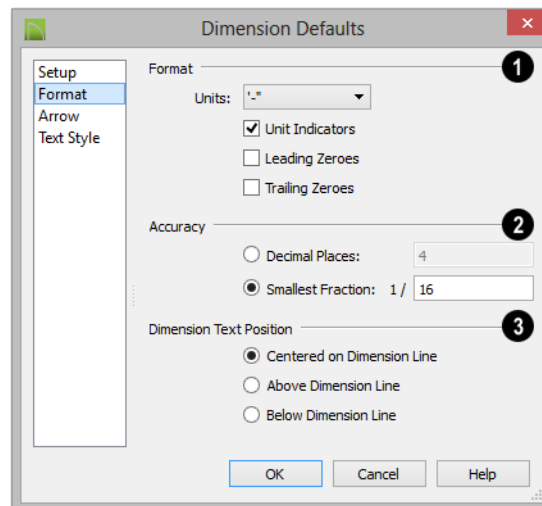

- 1 Specify the numbering **Format** for dimension numbers.

- Select the **Units** of measurement to be used by dimensions from the drop-down list.

- Check **Unit Indicators** to display the unit of measurement along with the dimension number.
  - Check **Leading Zeros** to include the zero before a decimal less than 1 or to display 0' or 0" when the ft-in or '-'" unit formats is used.
  - Check **Trailing Zeros** to display trailing zeros at the end of decimal values. When the ft-in or '-'" unit format is used and fractional inches are specified, 0" will be included.
- 2 Specify the degree of **Accuracy** used by dimension numbers.
    - Select the **Decimal Places** radio button for dimension numbers in decimal format. In the text field, specify the number of decimal places to use, from 0 to 20. If 0 is used, no decimal places are used.
    - Select the **Smallest Fraction** radio button for dimension numbers using whole numbers and fractions. In the text field, specify the largest denominator to use, from 1 to 128. If 1 is entered, whole numbers are used.
  - 3 Specify the **Dimension Text Position**, which is the location of dimension numbers relative to the dimension line.

- **Center** primary dimension numbers on the dimension line. If two formats are used, the primary format is placed above the line and the secondary format, beneath it.
- Position dimension numbers **Above Line**.
- Position dimension numbers **Below Line**.

### Arrow Panel

For information about the ARROW panel, see "Arrow Panel" on page 515.

### Text Style Panel

The settings on the TEXT STYLE panel control the size, font and other attributes of automatic, manually drawn, and temporary dimension line labels. See "Dimension Labels" on page 491.

For information about the settings on this panel, see "Text Style Panel" on page 509.

Temporary dimension labels always use the color assigned to their layer - not the color specified in the **Dimension Defaults** dialog.

## The Dimension Tools



Select **CAD> Dimensions** to access the Dimension Tools. Manually drawn dimensions are created by clicking and dragging like other line-based objects and can be drawn in floor plan view and Elevation views.

The zoom factor of the current view affects whether objects drawn close together are dimensioned or not. If you try to dimension an array of objects but the dimension line locates only the first and last objects along its path, **Zoom**  in on the objects and try again. Similarly, if you want to dimension



between two objects but the dimension locates unwanted objects between them,

**Zoom**  out. See “Zoom Tools” on page 442.

Once created, both manually drawn and automatically generated dimension lines can be selected and edited. See “Editing Dimension Lines” on page 491.

## Manual Dimensions



To display the distance between two objects, select **CAD> Dimensions> Manual Dimension** and drag a dimension line near or through the objects.

Manual Dimensions locate walls as specified in the **Dimension Defaults** dialog. See “Dimension Defaults Dialog” on page 485.

## End-to-End Dimensions



Use the **End-to-End Dimension** tool to dimension between any two defined objects in floor plan view and Elevation views.

Select **CAD> Dimensions> End-to-End**

**Dimension** , then click and drag the dimension from the first object to the second object. The dimension line snaps to each object, ignoring any other objects located between either end.

## Interior Dimensions



Draw **Interior Dimension** lines parallel to walls in floor plan view to create interior dimensions.

The **Interior Dimension**  tool locates interior wall surfaces only. It does not

dimension between layer surfaces in the same wall, and it does not locate walls unless it actually intersects them.

## Auto Exterior Dimensions



The **Auto Exterior Dimension** tool generates dimensions around a plan's exterior in floor plan view. These dimension lines locate walls as specified in the **Dimension Defaults** dialog. See “Dimension Defaults Dialog” on page 485.



Auto Exterior Dimensions do not generate properly if there is a gap in the exterior walls or if they do not connect properly.

If you edit an **Auto Exterior Dimension**  line, it will be converted to a manual dimension, so if Auto Exterior Dimensions are later regenerated, your changes will not be lost.

There are a maximum of three rows of automatically generated dimensions per exterior wall direction. The innermost dimension line locates exterior walls, interior walls, and all openings in exterior walls. The second dimension line locates exterior and interior walls. The outermost dimension line is the overall exterior dimension.

## Auto Interior Dimensions



The **Auto Interior Dimensions** tool creates a set of interior dimensions in each room that measures each wall on the current floor. It can be used in floor plan view in either of two ways:

- Select one or more rooms and click the **Auto Interior Dimensions**  edit tool to generate interior dimensions that mea-

sure each wall defining the selected room(s).

- Select **CAD > Dimensions > Auto Interior Dimensions**  to generate a set of interior dimensions in every room on the current floor.

**Auto Interior Dimensions**  lines are generated inside of the rooms they measure and do not recognize the **No Locate** setting for walls. If a wall is specified as No Locate, Auto Interior Dimensions will locate it anyway. See “No Locate” on page 135.

## Temporary Dimensions



Temporary Dimensions display when an object is selected and show the distance between the object’s selected edge and other objects. Select **View > Temporary Dimensions** to turn on or off the display of temporary dimensions. This toggle affects all views and is saved between launches of Home Designer Architectural.

As with other dimension lines, Temporary Dimensions only locate objects that are parallel or nearly parallel to one another. They will also locate the endpoints of CAD lines and the corners of objects located past the end of the selected edge, within 4 feet (1200 mm) of the point where you click to select the object.

A temporary dimension will not display when an object is selected if a dimension line is already present that shows the same information.

## Tape Measure



Use the **Tape Measure** tool to draw a temporary dimension line between any two points in the drawing area. The tool will place temporary markers at the start and end points of the dimension line. These points and the line both disappear when you release the mouse button. If an object is located by the temporary line, you can snap to it.

---

## Displaying Dimension Lines

The display of dimension lines is controlled in the **Display Options** dialog. See “Displaying Objects” on page 76.

Dimension lines created by any of the dimension tools share the same components.

- **Dimension Lines** run parallel with the distance being measured.
- **Extension Lines** are perpendicular to dimension lines, indicating what they locate. If a dimension line locates more than two objects, extension lines divide the dimension line into segments.
- **Arrowheads** display at the intersections of dimension and extension lines.
- **Dimension Labels** display at the midpoint of dimension line segments and indicate the distance that each segment measures.

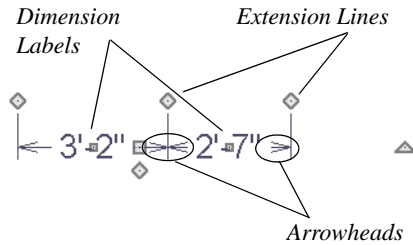

If a manual dimension line is on a layer that is turned off and you select an object located by that dimension line, it will display for reference using the Selection Line color specified in the **Preferences** dialog. See “Colors Panel” on page 63. This will happen only if **Temporary Dimensions**  are turned on. See “Temporary Dimensions” on page 490.

## Dimension Labels

Manually drawn, automatic, and temporary dimension labels use the Text Style specified in the **Dimension Defaults** dialog. Unlike many objects that use Text Styles, by default dimensions use a Text Style specified in the defaults dialog rather than the Text Style assigned to their layer. See “Text Style Panel” on page 488.

## Dimension Arrowheads

You can specify the style, color and size of dimension arrows in the **Dimension Defaults** and **Dimension Line Specification** dialogs. See “Arrow Panel” on page 515.

The arrow at the end of a dimension line will not display if it is close enough to another dimension arrow that the two will overlap. A typical example of this is where two sections of an Interior Dimension locate two sides of an interior wall.

---

## Editing Dimension Lines

With the exception of Temporary Dimensions, dimension lines can be selected and edited using the mouse, the edit toolbar buttons, and the **Dimension Line Specification** dialog. See “Dimension Line Specification Dialog” on page 496.



If an Auto Exterior Dimension line is edited, it will no longer be considered an automatic dimension line and will not be deleted and

replaced the next time the **Auto Exterior Dimensions**  tool is used.

## Using the Mouse

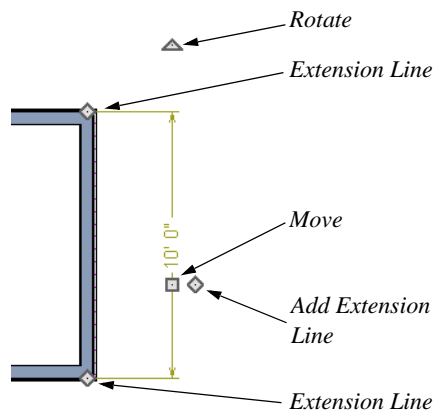
When a dimension line is selected, its edit handles can be seen. There are four types of dimension line edit handles. More than one of some types display, depending on how many extension lines are present.



- The **Extension Line** handles mark the location being dimensioned and are used to move or delete extension lines. See “Moving Extension Lines” on page 493.
- The **Add Extension Line** handle displays to the side of the Move handle and is used to add extension lines to the dimension line. Dimension lines do not extend unless an object can be located. See “Adding Extension Lines” on page 493.
- The small, square **Move Dimension Label** handle is located at the center of the selected label. Use this handle to move the dimension number for each dimension line section. The pointer changes to a four-headed arrow  when moved over this handle.
- The **Move** handle is located where you clicked to select the dimension line and is used to move the entire dimension line, including any subsections, perpendicular to itself. Extension lines are resized as appropriate. The pointer changes to a two-headed arrow  when moved over this handle.

- The **Rotate** handle is located one plan foot past the end of the dimension line and is used to rotate the dimension line.

## Using the Edit Tools

Dimension lines can be repositioned, copied, and deleted using the edit toolbar buttons just like other objects in the program can. See “The Edit Toolbar” on page 28.

## Dimension Number Size

The initial size of dimension numbers is specified in the **Dimension Defaults** dialog. See “Dimension Defaults Dialog” on page 485.

You can specify number height for individual dimension lines in the **Dimension Line Specification** dialog. See “Dimension Panel” on page 496.

As with text and other objects, dimension number size is subject to scaling when or printed.

## Copying and Pasting Dimension Lines

Dimension lines can be copied and pasted into any view type that supports dimensions. If a dimension line is copied independent of the objects it originally locates, the pasted dimension line will locate point markers.

## Deleting Dimension Lines

There are several ways to delete dimension lines.

You can select any manual or automatic dimension line or group of dimension lines, then press the Delete key or click the

**Delete**  edit button. See “Deleting Objects” on page 116.

The **Delete Objects** dialog allows you to delete all manually drawn and/or automatic dimension lines at once. See “Delete Objects Dialog” on page 116.

Individual dimension line segments located between extension lines can also be deleted. If a segment is located between two other

segments along the same dimension line, that dimension will be broken in two.

***To delete a portion of a dimension line***

1. Select any **Dimension Tool** aside from Auto Exterior Dimensions.
2. Manually draw a dimension line over the segment that you wish to remove, dragging from extension line to extension line.

## Editing Extension Lines

Extension lines can be added, edited, and deleted using the mouse.

### Adding Extension Lines

***To add an extension line***

1. Select the dimension line.
2. Click the diamond-shaped Add Extension Line edit handle which displays near the Move edit handle. The pointer changes to a two-headed arrow ↔.
3. Drag the handle to the object that you want to locate with a new extension handle. This example adds an extension line to the window edge.

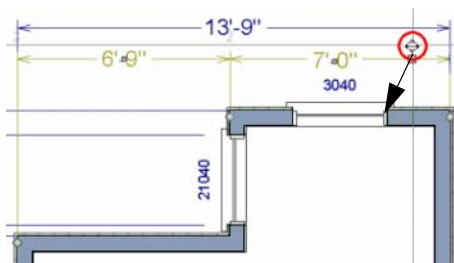

4. Release the mouse button to add an extension line.

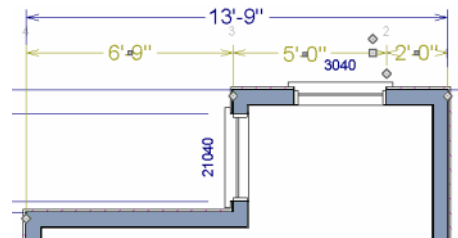

### Moving Extension Lines

Extension lines can be moved to locate the centers, sides, or surfaces of most objects. In this example an extension line is moved from the windows edge to the center.

***To move an extension line***

1. Select the dimension line it is connected to, not the extension line itself.
2. Click the Extension Line edit handle. The pointer changes to a two-headed arrow ↔.

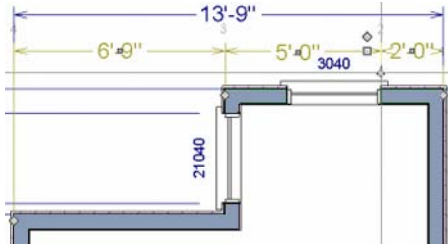

3. Drag the handle to a new location. The extension line snaps to possible marks as the handle is moved.
4. Release the mouse button at the new location.

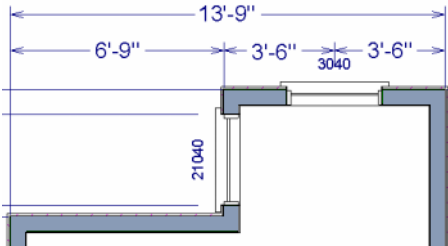

 Not all library symbols can be located by a dimension line as it is drawn. Once a dimension is drawn, however, you can move or add an extension line to locate the library object.

## Deleting Extension Lines

When an extension line is deleted, the remaining dimensions update. If a dimension line has only two extension lines, they cannot be deleted.

### *To remove an extension line*

1. Select the dimension line it is connected to, not the extension line itself.
2. Click the Extension Line edit handle.

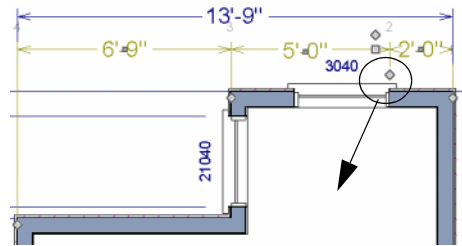

3. Drag it perpendicular to the direction of the arrows, away from any dimensionable object, and release the button when the extension line disappears.

## Moving Objects Using Dimensions

Most objects can be moved by changing an automatic, manual, or temporary dimension value that locates it. This technique can be applied in nearly any situation where dimensions are present. See “Moving Objects” on page 109.

In addition, some objects can be resized using dimensions. See “Resizing Objects” on page 112.

Your pointer indicates which dimensions can be used to relocate the selected object by changing to a pointing hand icon.

Another way to tell is to select an object and drag it in the desired direction. As you drag,

note which dimensions update. These dimensions are the dimensions that can be used to move that object.

**To move an object using dimensions**

1. Select the object and click on a dimension line that locates it. An inline text field opens at the location where you clicked.
  - The actual distance displays in the text field.
  - If the dimension is locating two different objects and the selected object is polyline-based, the **Move Edge** and **Move Entire Object** buttons display to the right of the text field.

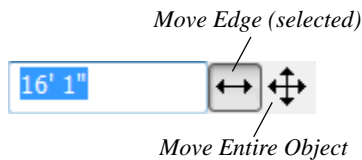

- If the dimension describes a selected wall's length, additional buttons display to the right. See "Using Dimensions" on page 136.

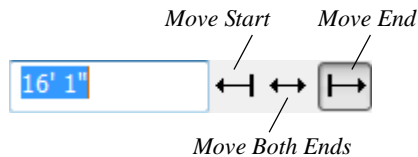

2. Click the **Move** button of your choice.
3. Enter a new value in text field.
  - To use a different unit, include its indicator after the value. To move the selected object past a second object, to its opposite side, enter a negative value.

- Basic math operations can also be performed in the inline text box, just as they can in dialogs. See "Math Operations in Dialogs" on page 31.
4. The selected object moves or resizes when you press the Enter key or click outside of the text field.

A variety of polyline- and box-based objects can also be resized using dimensions.

**To resize an object using dimensions**

1. Select the object along the edge that you would like to move. See "Selected Edge" on page 88.
2. Click on a dimension line that indicates its distance from the object's opposite side.
3. In the inline text field, enter a value.
4. Click **Move edge** to move the selected edge only.
5. The selected edge moves, resizing the object, when you press the Enter key.

 You can cancel a move or resize operation using dimensions at any time by pressing the Esc key.

**Resizing a House Using Exterior Dimensions**



When resizing a house using dimensions, it is important to work your way around the house in one direction. Relocate one wall at a time in succession so that you do not redefine the same dimension more than once.

For more information, see "Measuring Walls" on page 134.

---

## Dimension Line Specification Dialog



To open the **Dimension Line Specification** dialog, double-click a dimension line using the **Select Objects**  or **Manual Dimension**  tool, or select a

dimension line and click the **Open Object** edit button.

The settings in this dialog are dynamic defaults. See “Dimension Defaults Dialog” on page 485.

### Dimension Panel

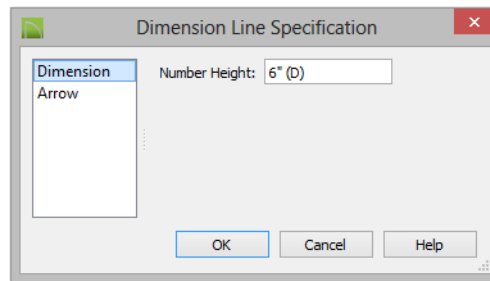

Specify the **Number Height** for the selected dimension. Type “d” in the box to reset the number size to the default.

### Arrow Panel

For information about the settings on this panel, see “Arrow Panel” on page 515.



# Text

Text is an ideal way to draw attention to special details of your drawings. Text can be added in floor plan view and Elevation views.

Text lines with arrow can be attached to text objects, allowing you to direct attention to specific plan details.

## Chapter Contents

- Text Defaults
- Fonts and Alphabets
- The Text Tools
- Creating Text
- Displaying Text
- Rich Text Specification Dialog
- Text Specification Dialog
- Editing Text
- Copying and Pasting Text
- Text Arrows
- Text Styles

---

## Text Defaults



Text Defaults can be accessed by selecting **Edit> Default Settings** in any view in which text can be created. See “Default Settings vs Preferences” on page 58.

The default settings for Rich Text determine what these objects look like when they are first created. Text Style Defaults determine the appearance of text associated with things like dimensions and object labels.

## Text Style Defaults

Select “Text Style” from the list in the **Default Settings** dialog and click the **Edit** button to open the **Saved Text Style Defaults** dialog.

The **Text Style Defaults** dialog allows you to specify the attributes of the various Text Styles in use in the current file. See “Text Styles” on page 507.



## Rich Text Defaults

The **Rich Text Defaults** dialog is similar to the **Rich Text Specification** dialog. See “Rich Text Specification Dialog” on page 500.

**Text Lines with Arrows**  use the same default layer as Rich Text, so by default they have the same color, line weight and line style. See “Layers” on page 75.

## Arrow Defaults

The settings in the **Arrow Defaults** dialog determine the initial settings for arrows

drawn using the **Text Line with Arrow**  and **Line With Arrow**  tools. These settings also determine the initial appearance of arrows when they are added to CAD lines, arcs, and polylines.

The **Arrow Defaults** dialog looks almost the same as the ARROW panel of the **Line/Polyline Specification** dialog. See “Arrow Panel” on page 515



Avoid typing any text in the Rich Text Defaults dialog unless you want it to be present in all text objects you create.

---

## Fonts and Alphabets

Home Designer Architectural allows you to use any font found in your computer’s Fonts directory.

For best printed results, using true-type or open-type fonts is recommended.

### Blueprint Fonts

Three architectural fonts: Chief Blueprint, City Blueprint, and Country Blueprint are installed in the Windows Fonts directory when Home Designer Architectural is installed.

Chief Blueprint  
City Blueprint  
Country Blueprint

On Mac systems, these fonts are embedded with the Home Designer Architectural installation but not installed on the system.

As such, they are available for use in Home Designer Architectural but not in other programs.

### International Alphabets

The **Rich Text**  tool supports unicode alphabets and characters. In order to use a unicode alphabet or characters, the appropriate language support must be installed on your computer.

Special characters can be added to any **Rich Text**  object by:

- Copying and pasting the character from another application;
- Copying and pasting the character from the Windows Character Map;
- Using the Mac Character Viewer;
- Typing the keystroke associated with the character.

See “Copying and Pasting Text” on page 505.

## Missing Fonts

If you open a plan file that uses a font that is not installed on the current computer, the program will give you an opportunity to replace it in the **Replace Fonts** dialog.

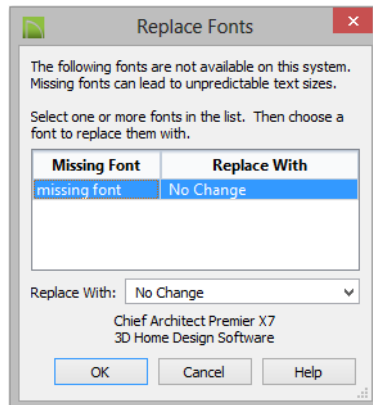

The table lists all missing fonts and how they will be replaced.

- Click on a font name in the list to select it. Use the Shift or Ctrl key to select multiple fonts. See “Shift and Ctrl Select” on page 89.
- Select a replacement font from the **Replace With** drop-down list, or leave “No Change” as the selection to maintain the file’s association with the missing fonts.
- A preview of the selected font displays below the **Replace Width** list.

If you do not plan to return the file to the computer where it was created, you may want to replace missing fonts with the fonts you normally use. On the other hand, if you do intend to return the file, you may prefer to not replace any missing fonts.

---

## The Text Tools

 Select **CAD> Text** to access the **Text Tools**. These tools are available in floor plan view and Elevation views.

 The **Rich Text** tool is used to create text objects.

 The **Text Line with Arrow** tool is used to connect text and another object with an arrow. See “Text Arrows” on page 506.

 The **Text with Arrow** tool places a Rich Text object with an arrow attached.



---

## Creating Text

Text can be created in floor plan view and Elevation views.

Once created, text can be selected and edited in a variety of ways. See “Editing Text” on page 504.

### To create Rich Text

1. Select **CAD> Text> Rich Text** .
2. Type or paste the desired text into the Text Field.
3. Use the options to change the font, style and size of any portion of the text.
4. When you are finished, simply click outside of the Text Field to close it and the Edit Bar. The **Rich Text**  tool remains active, so you can click and

drag to create additional Text objects if you wish.

Note: If you do not type anything in the Text Field, a text object will not be created when you click outside of it.

You can also create lines with arrows connecting the text that you create to items in the drawing. See “Text Arrows” on page 506.



## Displaying Text

As with other types of objects, the display of Text objects is controlled in the **Display Options** dialog. All Text objects, including Text Lines with Arrows, are located on the “Text” layer. See “Display Options Dialog” on page 77.

Text objects can only be displayed in views where text can be created.

The display attributes of each individual text object can be controlled independent of the layer it is placed on. See “Rich Text Specification Dialog” on page 500.

## Rich Text Specification Dialog

 The **Rich Text Specification** dialog opens if you select the **Rich Text**  tool and then click once in the drawing area. You can also open this dialog by selecting a **Rich Text**  object, then clicking the **Open Object** edit button.

The **Rich Text Specification** dialog is similar to the **Rich Text Defaults** dialog but affects the selected text rather than all subsequently created text objects. See “Text Defaults” on page 497.

## Text Panel

The settings on the TEXT panel allow you to type the selected Rich Text object’s content and control many aspects of its appearance, including its font, size, color and style.

You can specify the appearance of the text before typing, and can also select and change the attributes of all or portions of the text content after it is typed. To change text that already exists, simply highlight it using the



mouse and/or the Shift + arrow keys and then make any needed changes to its attributes.

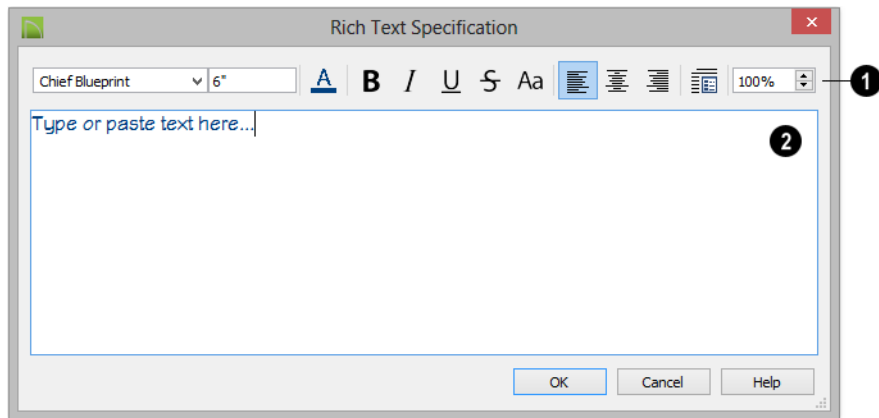







Note: If you do not type anything in the text field on this panel when creating a new object, no object will be created when you click OK. On the other hand, if you remove the text from an existing object and click OK, an empty text box will result.



1 Use the options on the Edit Bar, which displays above the Text Entry field, to change the font, size, and style of the text.

Select the desired options before typing to affect the text as it is typed, or select some or all of the text and then specify which options to apply to it.

- Select a **Font** from the drop-down list.
- Specify the **Text Size** in drawing units.
- Click the **Color**  button to specify the color of the selected or subsequently typed text. See “Select Color Dialog” on page 438.
- Click the **Bold**  button to specify the selected text as bold.

- Click the **Italic**  button to specify the selected text as italic.
- Click the **Underline**  button to specify the selected text as underlined.
- Click the **Strikethrough**  button to specify the selected text as stricken-through.
- Click the **Uppercase**  button to display the selected text in all capital letters.
- Click the **Align Left** , **Align Center** , or **Align Right**  button to specify the how text is aligned.
- Click the **Paragraph Options**  button to specify the selected paragraph’s align-

- ment, spacing and bullets or numbering in the **Paragraph Options** dialog.
- Specify the **Zoom** factor of the selected text by typing a percentage value in the text field or clicking the up/down arrows. This setting only affects the text as it appears in this dialog.

Note: Some fonts cannot be drawn at certain zoom factors. When this is the case, the appearance of the text will not change.

- 2 Type or paste text in the Text Entry field. See “Copy, Cut and Paste” on page 505.
- Right-click in the Text Entry field to access a contextual menu from which you can select Undo, Redo, Cut, Copy, Paste and Select All. See “Contextual Menus” on page 29.
  - To edit text in the entry field, click and drag to highlight any portion of it and then use the tools on the Edit Bar as needed.

### Paragraph Options Dialog

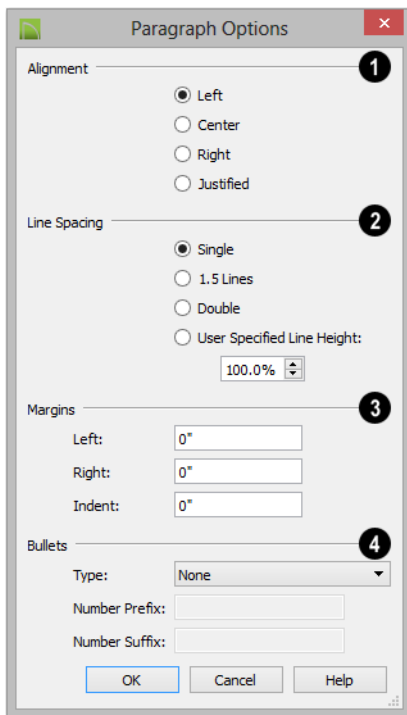

- 1 Specify the **Alignment** of the selected paragraph(s). See “Aligning Text” on page 505.

- 2 Specify the **Line Spacing** of the selected paragraph(s).
- Click the radio button beside **Single**, **1.5 Lines**, **Double** or **User Specified**.
  - If you select **User Specified Line Height**, type the desired height for each line of text in the selected paragraph(s). For best results, this value should be at least as much as the largest character size used in the selected paragraph(s).
- 3 Specify the appearance of the side **Margins** of the selected paragraph(s), as measured in from edges of the text box. Only positive Margin values can be used.
- Specify the **Indent**, which is measured from the left side margin. A negative value can be used if a left Margin has been specified.
- 4 Specify the appearance of **Bullets** and numbering in the selected paragraph(s).
- Select the desired bullet, numbered, or lettered **Type** from the drop-down list.
  - Specify the **Number Prefix**, which are any characters that you would like to dis-

play before the selected paragraph's number or letter. Does not affect paragraphs using circle or square bullets.

- Specify the **Number Suffix**, which are any characters that you would like to dis-

play after the selected paragraph's number or letter and before its actual text.

Does not affect paragraphs using circle or square bullets.

## Text Specification Dialog

The **Text Specification** dialog opens if you select a Room Label or a simple **Text** object in a legacy plan file created in Version 8 or prior and click the **Open Object** edit button. See “Compatibility with Other Programs” on page 42.

Settings in the **Text Specification** dialog can also be found in other dialogs in the program, including the **Room Label Specification** and the **Dimension Defaults** dialogs.

### Text Panel

The settings on the **TEXT** panel allow you to type the selected Text object's content. Text

cannot be added to a selected Room Label, however.

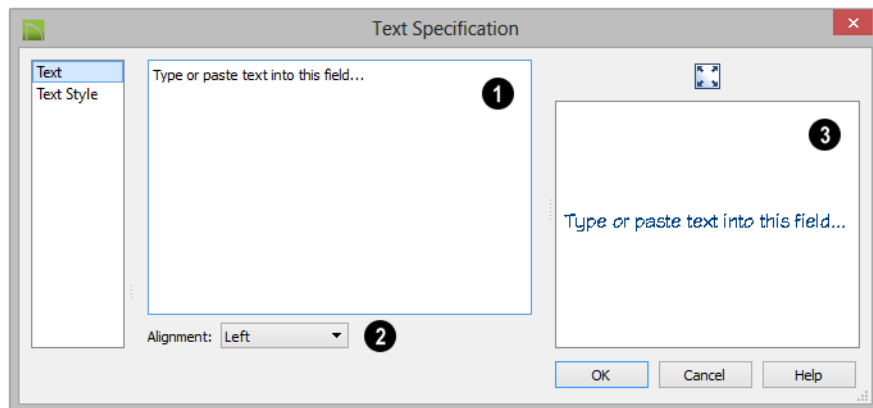

**1** Enter text in the **Text Entry** field. This field is not available if the selected object is a Room Label. See “Room Labels” on page 166.

**2** Select an **Alignment** option from the drop-down list to apply to the text.

**3** A preview of the selected text object displays on the right. Not available for Room Labels. See “Dialog Preview Panes” on page 32.

## Text Style Panel

The TEXT STYLE panel is available for a variety of objects in the program and control

the appearance of the selected object's text. See "Text Style Panel" on page 509.

## Editing Text



Once created, **Rich Text**  objects can be selected individually or as a group and edited using the edit handles and the edit toolbar. Individual text objects can also be edited in the **Rich Text Specification** dialog. See "Rich Text Specification Dialog" on page 500.

### Editing Text Attributes

Most text attributes, including the font, size, style, and the content itself, are edited in the **Rich Text Specification** dialog.

In order to edit the attributes of an existing **Rich Text**  object, you must select some or all of the text before making changes. See "Text Panel" on page 500.

#### To edit Rich Text attributes

1. Select a **Rich Text**  object and click the **Open Object**  edit button.
2. On the TEXT panel of the **Rich Text Specification** dialog, click and drag to select some or all of the text typed into the Text field.

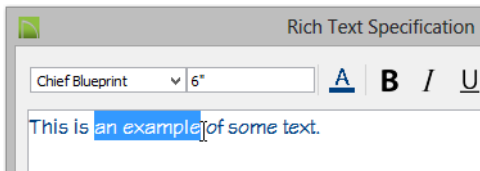

3. With some or all of the text selected, change any of the attributes available along the top of the panel, including the font, size, color, and style.

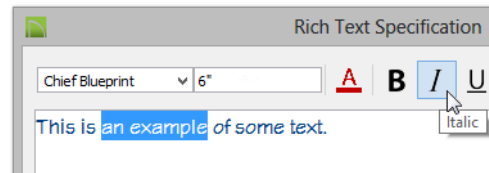

4. As changes are made, the selected text updates. Only the selected text is modified.

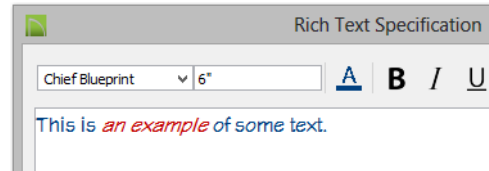

### Using the Mouse

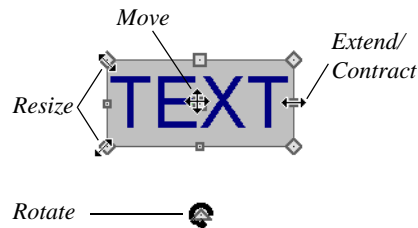

A selected **Rich Text**  object has the same edit handles as other box-based objects. See "Editing Box-Based Objects" on page 101.





As a text box's width is made narrower or wider using an edit handle, its height may increase or decrease so that none of the text becomes hidden. The opposite is not true, however: a text box's height cannot be resized smaller than the height of the rows of text it currently contains.

## Using the Edit Tools

A selected **Rich Text**  or **Text**  object can be edited in a variety of ways using the buttons on the edit toolbar. See “The Edit Toolbar” on page 28.

## Resizing Text





The default character height of **Rich Text**  objects can be specified as can the character height for individual objects, in their specification dialogs. See “Text Defaults” on page 497.

## Scaling Text

As with the size of other objects, text size is subject to the current drawing scale specified in the **Page Setup** dialog. See “Drawing Sheet Setup Dialog” on page 563.

## Aligning Text

Text can be aligned in a couple of ways.

- The text content of a text object can be aligned to the left, right, center or justified in the **Rich Text Specification** dialog. See “Text Panel” on page 500.
- The text content of a text object can be also be aligned by clicking the **Align Left** , **Align Right** , **Center** , or **Justify**  edit button.

A variety of other alignment methods are also available. See “Aligning Objects” on page 110.

## Copy, Cut and Paste

Copy, Cut and Paste of text into and out of the **Rich Text Specification** dialog can be accomplished using keyboard hotkeys:

- Press Ctrl + X to Cut the selected text and save it to the system clipboard.
- Press Ctrl + C to Copy the selected text and copy it to the system clipboard.
- Press Ctrl + V to paste your last cut or copied selection in a new text object.

For more, see “Copying and Pasting Objects” on page 83.

Copy, Cut and Paste use the system clipboard, making it possible to transfer text between text objects, between Home Designer Architectural files, from a plan into another application, or vice versa.

---

## Copying and Pasting Text

The Copy, Cut and Paste commands use the system clipboard, making it possible to transfer text between text objects, between Home Designer Architectural files, from a

plan into another application such as a text editor or spreadsheet program, or vice versa. See “Copying and Pasting Objects” on page 83.

All or selected portions of the Materials List can also be copied and pasted into a text object, as well as into a word processing or spreadsheet program. See “Materials Lists” on page 579.

Cut, Copy, and Paste can also be accessed from the Edit menu of many applications, including Home Designer Architectural. These menu commands are not available when the text specification dialogs are open, but you can use the associated hotkeys.

#### *To Copy, Cut and Paste text*

1. On the TEXT panel of either text specification dialog or in another program altogether, highlight the text you wish to cut, copy or paste.
2. Press Ctrl + X to **Cut** the selected text out of its original location and save it to the system clipboard.
3. Press Ctrl + C to **Copy** the selected text to the system clipboard without removing it from its original location.
4. Open the text object or a file in another application and click to place your cursor in the Text field, writing area, or spreadsheet cell.

5. Press Ctrl + V to **Paste** the copied text at the location of your cursor.

Bear in mind that when text is copied and pasted, its formatting is not always retained. The results depend on the program or type of text object in which the content was created as well as the type of text object into which it is pasted.

### **Pasting into Rich Text**



Text pasted into a **Rich Text** object from another source will retain most - but not necessarily all - of its custom formatting. If a line of text is sufficiently long, however, it may be wrapped automatically when pasted into Rich Text.

Text pasted into a **Rich Text**  object from a spreadsheet program retains basic column and row information. Column width cannot be adjusted; however, as you add or remove text from a cell, row height will increase or decrease to accommodate your changes.

The background colors of two or more cells copied from a spreadsheet application will be retained if pasted in to **Rich Text** ; however, once pasted background color cannot be edited.

---

## **Text Arrows**

Text arrows, which are simply CAD lines with arrows drawn on the “Text” layer, can be used to connect text objects to details of interest in your drawing. See “Draw Lines” on page 511.

Text arrows can be snapped together to form open or closed polylines. If two lines with

arrows meet within the bounding box of a text object, however, they will not join. This allows you to attach multiple, separate text arrows to a single text object. See “Editing Line Based Objects” on page 90.

Lines with arrows can be independent or attached to other objects. If an attached

object is moved, the end of the Line with Arrow will move, as well. Arrows attach to closed polyline-based objects along their edges, but can attach to Text or an architectural object anywhere within its bounding box in floor plan view.

If an arrow is attached to text or another object, deleting either the text or the object will also delete the arrow.

### Text with Arrow

 The **Text with Arrow** tool places a text object with an arrow already attached. This arrow can be selected and edited like any other arrow.

### Text Line with Arrow

 **Text Lines with Arrow** can be attached to text, CAD and architectural objects by selecting **CAD>**

**Text> Text Line with Arrow**  and then clicking and dragging to draw a line. There is no limit to the number of text lines with arrows that can be attached to an object.

The endpoints of **Text Lines with**

**Arrows**  can be joined to form polylines with corners that can be adjusted using the edit handles. See “Polylines” on page 518.

A **Text Line with Arrow**  behaves like a **Line With Arrow**  with one exception:

Text Lines with Arrow are initially placed on the “Text” layer, not the “CAD, Default”. See “Layers” on page 75.

### Auto Position Arrows

Auto Positioning helps prevent a **Text Line with Arrow**  from crossing over the text object it is attached to by snapping the end of the line to the midpoint of the text box’s nearest edge. If the text object or the line’s arrowhead is moved, the location of the tail end will update as needed so that it snaps to the nearest edge’s midpoint. This behavior only occurs when the end of a line with arrow is snapped an Auto Position location: if it is snapped to a different point on the text, the tail end will not move.

The following image illustrates the behavior of Auto Positioning. When the head of the line with arrow is moved, the tail of the arrow snaps to different Auto Position locations on the text object, maintaining its connection.

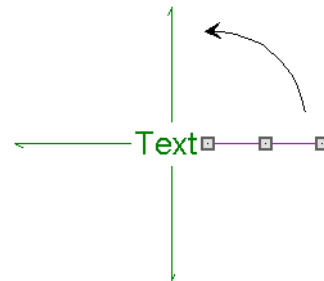

---

## Text Styles

In Home Designer Architectural, a Text Style is a set of attributes assigned to any object

that displays text, such as Dimensions, Plant Schedules, and object labels.

Note: Because of its ability to use multiple attributes in the same object, Rich Text does not use Text Styles. See “Rich Text Specification Dialog” on page 500.

There are three Text Styles in Home Designer Architectural. You can edit these Text Styles to suit your needs in the **Text Style Defaults** dialog

- The Default Label Style affects the appearance of labels for objects such as doors and windows;
- The Default Text Style controls the appearance of Plant Schedules, legacy Text objects, and dimension line labels, unless specified otherwise.
- The Default Room Style controls the appearance of room labels.

### Text Style Defaults



Select **Edit > Default Settings**, click on “Text Styles” and click **Edit** to open the **Text Style Defaults** dialog. The **Saved Text Style Defaults** dialog will open, allowing you to select which Saved Text Style Defaults you would like to edit.

### Saved Text Style Dialog

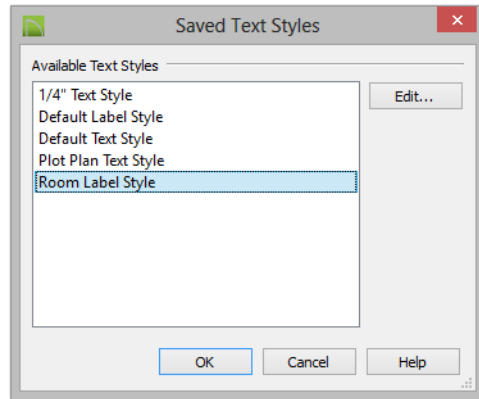

- Select the **Name** of one of them from the drop-down list. This is the currently selected Text Style.
- Click the **Edit** button to open the defaults dialog for the selected Text Style so that you can edit it.
- Click **OK** to close the **Saved Text Style Defaults** dialog and save any changes you made in the defaults dialog.
- Click **Cancel** to close the **Saved Text Style Defaults** dialog without saving any changes that you may have made in the defaults dialog.

The settings in the **Text Style Defaults** dialog are similar to those on the TEXT STYLE panel of object specification dialogs in the program but affect all objects using that style rather than an individual selected object.

## Text Style Panel

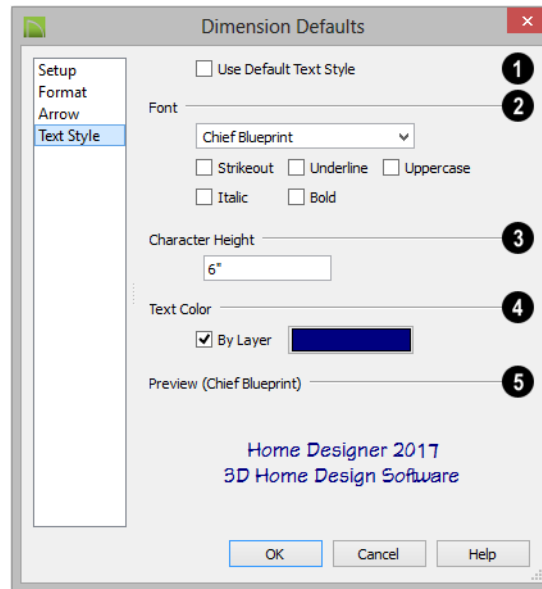

1 Check **Use Default Text Style** to use the default style for the selected object type, or uncheck this box to enable the settings below and define a custom style.

The settings that follow are only editable when **Use Default Text Style** is unchecked. When it is checked, information about the Text Style that is assigned to the selected object displays for reference.

- 2 Specify the attributes of the selected Text Style's **Font**.
- Select a font from the drop-down list.
  - The text styles **Bold**, **Underline**, **Italic**, **Strikeout**, and **Uppercase** are available. Check any of the boxes to apply that style.
- 3 Specify the **Character Height** of text using the selected Text Style.

- Enter the **Character Height** in drawing units. This height is subject to the current drawing scale.

4 Specify the selected Text Style's **Text Color**. When **Use Custom Text Style** is not selected above, a Text Color does not display here for reference.

- When **By Layer** is checked, text uses the line color assigned to the layer that the object it is assigned to is located on. See "Displaying Objects" on page 76.
- Uncheck **By Layer**, then click the **Color** bar to select a different color. See "Select Color Dialog" on page 438.

5 A preview of the Text Style currently assigned to the selected object displays here.



# CAD Objects

The CAD Tools are used to add information to 2D views of your model. CAD objects do not affect 3D objects or display in camera views or overviews, but they can be used to add details to floor plan view and elevation views.

CAD objects are edited much like other objects in Home Designer Architectural. See “Editing Objects” on page 87.

## Chapter Contents

- The CAD Drawing Tools
- Line Specification Dialog
- Arc Specification Dialog
- CAD Circle/Oval/Ellipse Specification Dialog
- Polylines
- Polyline Specification Dialog
- Box Specification Dialog
- Splines
- Displaying CAD Objects

---

## The CAD Drawing Tools





The CAD drawing tools can be accessed by selecting the **CAD** menu or by clicking the **CAD Tools** button.

### Draw Lines



Select **CAD> Draw Line** or **CAD> Draw Line With Arrow** to draw lines with or without arrows.

### *To draw a line or line with arrow*

1. Select **CAD> Draw Line**  or **Draw Line With Arrow** .
2. Click and drag in the drawing area to draw a line.
3. Continue drawing lines as needed, then select another tool when you are finished.

Once a line is created, it can be edited. You can snap the ends of lines together to form polylines. See “Editing Line Based Objects” on page 90 and “Line Specification Dialog” on page 513.

## Draw Arc

 Select **CAD > Draw Arc** to draw an arc.

### *To draw an arc*

1. Select **CAD> Arcs> Draw Arc** , then click at the arc’s start point.
2. Move the pointer along the desired curve while dragging to curve the arc.
3. Release the mouse button at the end point to complete the arc.

Once an arc is created, it can be edited. See “Editing Arc Based Objects” on page 92 and “Arc Specification Dialog” on page 515.

You can snap the ends of arcs together with other arcs or with lines to form polylines. See “Polylines” on page 518.

## Draw Polyline

 Select **CAD > Draw Polyline** to draw a rectangular polyline in either of two ways:

- Click in the drawing area to place a 24” x 24” square polyline at that location.
- Click and drag from corner to corner to draw a rectangle of any size.

Once drawn, a rectangular polyline can be edited into any shape. See “Editing Closed-Polyline Based Objects” on page 98 and “Polyline Specification Dialog” on page 518.

## Draw Box

 Select **CAD > Draw Box** to draw a box.

CAD boxes are drawn from corner to corner, forming a rectangle that can then be edited. Unlike a polyline, a box always has four 90° corners. See “Editing Box-Based Objects” on page 101 and “Box Specification Dialog” on page 520.

## Draw Circle

 Select **CAD > Draw Circle** to draw a circle.

Draw a **Circle**  by dragging across the diameter, in any direction.

If a small circle is needed, draw a larger circle and then resize it. See “Editing Circles, Ovals and Ellipses” on page 105 and “CAD Circle/Oval/Ellipse Specification Dialog” on page 517.

## Draw Oval

 Select **CAD > Draw Oval** to draw an oval, which is a four-arc approximation of an ellipse.

Draw an oval, by clicking and dragging at an angle to define its maximum height and width.

Once an oval is created, it can be edited. See “Editing Circles, Ovals and Ellipses” on page 105 and “CAD Circle/Oval/Ellipse Specification Dialog” on page 517.

## Draw Ellipse

 An **Ellipse** is a set of points with a constant combined distance from two



points called foci. An ellipse looks like a stretched circle, or a circular surface viewed at an angle.

To draw an ellipse, select **CAD> Draw**

**Ellipse**  and drag at an angle to define its maximum height and width.

Once an ellipse is created, it can be edited. See “Editing Circles, Ovals and Ellipses” on page 105 and “CAD Circle/Oval/Ellipse Specification Dialog” on page 517.

### Draw Spline



A Spline is a curve that passes smoothly through a set of points. Select **CAD> Draw Spline** to draw connected line segments that form a spline. See “Splines” on page 520.

Once created, a spline can be selected and edited. See “Editing Spline Based Objects” on page 103 and “Polyline Specification Dialog” on page 518.

### Dimension Tools



Select **CAD> Dimensions** to access the Dimension Tools. The **Dimension Tools** can be used with CAD and architectural objects and are discussed in their own chapter. See “Dimensions” on page 485.

### Text Tools



Select **CAD> Text** to access the Text Tools. The Text Tools are discussed in their own chapter. See “Text” on page 497.

---

## Line Specification Dialog



Select a CAD Line, Line With Arrow, or Text Line With Arrow and click the **Open Object** edit button to open the **Line Specification** dialog.

The settings on the panels in this dialog are found in the specification and defaults dialogs for a variety of different objects in the program.

### Line Panel

The information on the LINE panel of the **Line Specification** dialog is similar to that

found on the SELECTED LINE panels of various specification dialogs in the program.

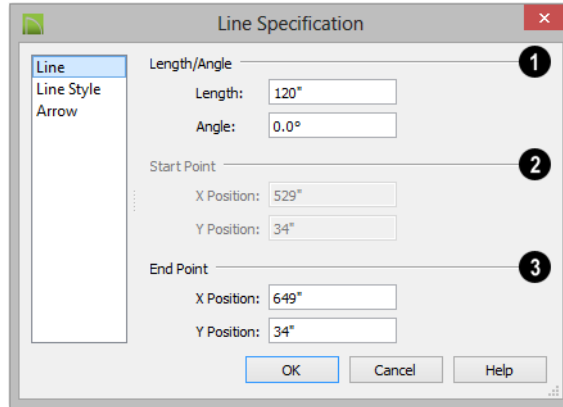

- 1 Specify the **Length** and **Angle** of the selected line.
- 2 The **X** and **Y Position** coordinates of the selected line's **Start Point** display for reference but cannot be changed here.

The Start Point can be changed using the line's edit handles, however. See "Editing Line Based Objects" on page 90.

- 3 Specify the **X** and **Y Position** of the selected line's **End Point**.

## Line Style Panel

The LINE STYLE panel is found in the specification dialogs for many different objects. The settings here control the

appearance of the lines and/or arcs that make up an object. Depending on the type of object selected, some settings may not be available.

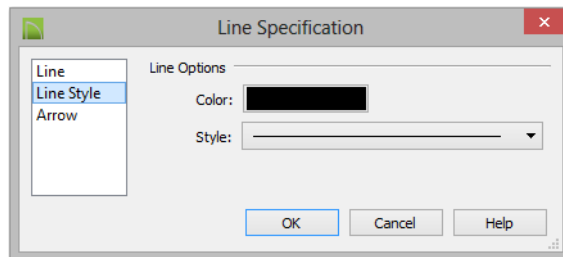

- Click the **Line Color** box to specify a new line color. See "Select Color Dialog" on page 438.
- Click the **Line Style** drop-down list to select from a variety of available line styles.

An additional **Display Options** setting is available in the **Picture File**, **Metafile**, and **PDF File Box Specification** dialogs. See "Pictures, Images, and Walkthroughs" on page 529.

- Check **Show Outline** to display the selected object's border polyline.

## Arrow Panel

The ARROW panel is available for any line, arc, open polyline, or spline that can have an arrow: including dimension lines. The defaults for arrows are set in the **Arrow Defaults** dialog. See “Dimension Defaults Dialog” on page 485.

Lines with arrows can be attached to other objects. They attach to a closed polyline-

based object along its edges, but can attach to an architectural object anywhere within its 2D symbol in floor plan view. If an arrow is attached to another object, deleting that object will also delete the arrow.

Closed polylines, Sprinkler Lines and Electrical connections are examples of objects that cannot have arrows.

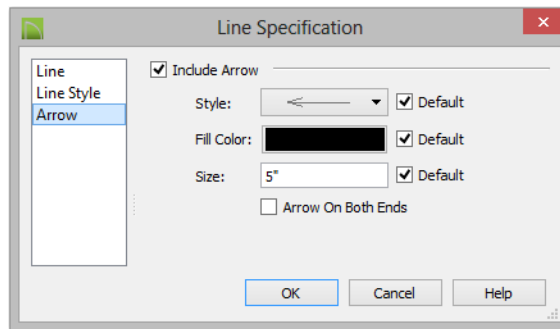

- Check **Include Arrow** to create an arrowhead at the end of the selected line, arc, or open polyline.
- Select an arrowhead **Style** from the drop-down list.
- Click the **Fill Color** box to select a color for the arrowhead to be used if a solid Style is selected. See “Select Color Dialog” on page 438.
- Specify the arrowhead’s **Size**.
- Check the box beside **Arrow On Both Ends** to create a two-headed arrow.
- Place a check in any of the **Default** boxes to restore that setting to the default.

---

## Arc Specification Dialog



Select an arc and click the **Open Object** edit button to open the **Arc Specification** dialog.

The settings on the ARC panel are also found on the SELECTED ARC panels for many objects.

## Arc Panel

1 These settings define the **Arc**. Some values are listed for reference only and cannot be directly changed here. They can, however, be changed using the edit handles and edit tools. See “Editing Arc Based Objects” on page 92.

- The **Center X and Center Y Points** are the X and Y coordinates of the center of the arc and display for reference. They may update as changes are made to other settings in this dialog.

- **Radius** - Specify the distance between the center of the arc and the arc surface.
- **Start Angle** - The angle of a line drawn from the arc center to the arc start points. This displays for reference only but may update as changes are made to other settings in this dialog.
- **End Angle** - Specify the angle of a line drawn from the arc center to the arc end.
- **Arc Angle** - Specify the angle between the center of the arc and each end.

- **Arc Length** - Specify the length of the arc along its curve.
  - Uncheck **Automatic Facet Angle** to specify the **Facet Angle**, which is the angle at which the surfaces of a curved 3D object are broken in 3D views. The default value is 7.5°; a smaller value produces a smoother curve while a larger value may generate more quickly in 3D views. These settings are only available on the **SELECTED ARC** panel for some CAD-based architectural objects such as Slabs. See “Architectural vs CAD Objects” on page 80.
- 2 **Start Point** - Specify information about the starting point of the selected arc.
    - The **Start X** and **Start Y Position** coordinates display for reference. They may update as changes are made to other settings in this dialog.
    - **Start Direction** - Specify the angle of a tangent line at the start of the arc.
  - 3 **End Point** - Specify information about the end point of the selected arc.
    - **End X** - Specify the X coordinate for the end of the arc.
    - **End Y** - Specify the Y coordinate for the end of the arc.
    - **End Direction** - The the angle of a tangent line at the end of the arc displays for reference. This displays for reference only but may update as changes are made to other settings in this dialog.
  - 4 Define the selected arc’s **Chord**, which is the straight line between its start and end points.
    - **Chord Length** - The straight line distance between the two ends of the arc.
    - **Chord Angle** - Specify the angle of the chord.

### Line Style Panel

For information about the **LINE STYLE** panel, see “Line Style Panel” on page 514.

### Arrow Panel

For information about the **ARROW** panel, see “Arrow Panel” on page 515.

## CAD Circle/Oval/Ellipse Specification Dialog



Select a circle, oval or ellipse and click the **Open Object** edit button to open the **CAD Circle**, **Oval** or **Ellipse Specification** dialog.

### Line Style Panel

For information about the **LINE STYLE** panel, see “Line Style Panel” on page 514.

### Fill Style Panel

For information about the **FILL STYLE** panel, see “Fill Style Panel” on page 519.

## Polylines

 A polyline consists of two or more line and/or arc segments that are attached at their endpoints. Select **CAD>CAD> Rectangular Polyline**, then click and drag from corner to corner to create a rectangular-shaped, closed polyline. A closed polyline measuring 2' x 2' (600 mm x 600 mm) can also be created by clicking once while the **Rectangular Polyline** tool is active.

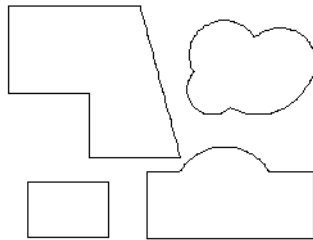

*Closed Polylines*

Polylines can be copied, moved, reshaped, or resized as a single unit.

You can also create a polyline by drawing lines and/or arcs end-to-end, allowing the end of each new object to snap to the end of the previous one.

Line- and arc-based objects will only snap together to form a polyline if they are on the same layer and share identical attributes such as color, line style, and arrow specifications. If one end of the polyline is connected to the other, it becomes a closed polyline.

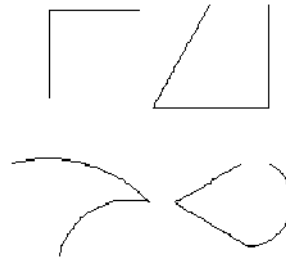

*Open Polylines*

Once created, polylines can be edited in a variety of ways. See “Editing Open Polyline Based Objects” on page 95 and “Editing Closed-Polyline Based Objects” on page 98.

## Polyline Specification Dialog

 Select an open polyline, closed polyline, spline, Sprinkler polyline, or Electrical connection and click the **Open Object** edit button to open the **Polyline Specification** dialog.

### Polyline Panel

The POLYLINE panel is found in the specification dialogs for a variety of objects throughout the program. It states:

- The **Length** of an open polyline-based object;
- The **Perimeter** of a closed polyline-based object;

- The **Area** of a closed polyline-based object;
- The **Volume** of a closed polyline-based object.

If the polyline is not closed, the Area and Volume are described as “Not closed”. The Volume of a 2D polyline will always be 0, even if it is closed.

### Selected Line Panel

The SELECTED LINE panel is available when the selected edge of the polyline is a line as opposed to an arc and is not available if the selected object is a spline. See “Editing Line Based Objects” on page 90.

Moving the End of a line segment moves the start of the next connected line, if there is one.

This panel is similar to the LINE panel of the **Line Specification** dialog. See “Line Panel” on page 513.

### Selected Arc Panel

The SELECTED ARC panel is available when the selected segment of the polyline is an arc as opposed to a line. It is not available if the selected object is a spline.

This panel is similar to the ARC panel of the **Arc Specification** dialog. See “Arc Panel” on page 516.

### Line Style Panel

This panel is similar to the LINE STYLE panel in the **Line Specification** dialog. See “Line Style Panel” on page 514.

### Fill Style Panel

The information on the FILL STYLE panel for closed polylines is similar to that for many other objects in the program, including closed CAD shapes and a variety of architectural objects.

The FILL STYLE panel is not available for Sprinkler Lines or Electrical Connections as these tools cannot be used to form closed shapes.

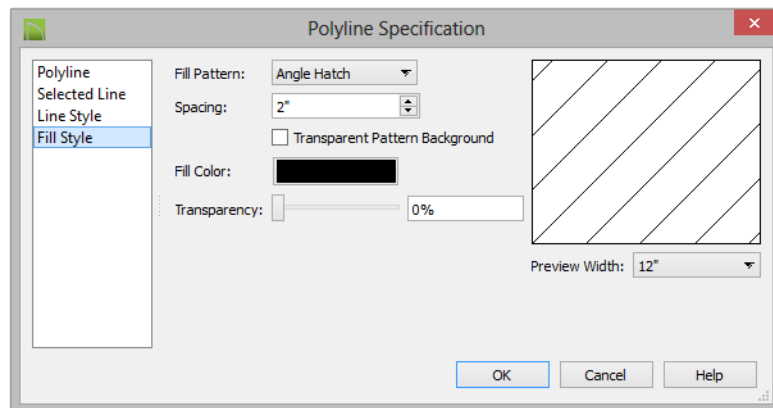

Specify the characteristics of the selected object's fill **Pattern**. When "None" is the selected pattern Type, the rest of these settings are disabled.

- Choose a pattern **Type** from the drop-down list.
- Specify the **Spacing** of the selected fill pattern. Not available for "Solid" fill.
- Check **Transparent Pattern Background** to make the spaces between fill pattern lines transparent, allowing any objects behind the fill pattern to be visible through it. Not available for "Solid" fill.
- **Specify** the **Color** of the lines that make up the fill pattern, or the fill color of "Solid" fill, by clicking the color bar. The layer color is used by default. See "Select Color Dialog" on page 438.
- Use the **Transparency** slider bar or text field to control how transparent the fill

pattern lines are. This setting also affects the transparency of Solid fill colors.

A preview of the selected pattern displays to the right. As changes are made to the settings on this panel, the preview will update.

- Choose a **Preview Width** from the drop-down list. This value controls how large an area the preview represents. The selected value indicates the length of each side of the preview in actual plan inches (mm).

## Arrow Panel

The ARROW panel is available for most open polylines and splines and is similar to the ARROW panel of the **Line Specification** dialog. See "Arrow Panel" on page 515.

The ARROW panel is not available for closed polylines, Sprinkler Lines, or Electrical Connections.

---

## Box Specification Dialog



Select a CAD box and click the **Open Object** edit button to open the **Box Specification** dialog. See "Draw Box" on page 512.

## Line Style Panel

For information about the LINE STYLE panel, see "Line Panel" on page 513.

## Fill Style Panel

For information about the FILL STYLE panel, see "Fill Style Panel" on page 519.

---

## Splines





A Spline is a curve that passes smoothly through a set of points. Splines are typically used in situations where

there is an irregular curve. A contour line is a typical example. Splines are useful wherever a free-flowing curve is needed.



Once created, splines can be selected and edited. See “Editing Spline Based Objects” on page 103 and “Polyline Specification Dialog” on page 518.

### To use the Spline tool

1. Select **CAD> Draw Spline** .
2. Click and drag to draw the first spline segment just as you would a line. A single spline segment looks identical to a line, in fact. You may need to turn off **Angle Snaps**  to draw freely.



3. Draw the second segment from the end of the first at a different angle. **Object Snaps**  should be on to assure that new segments attach correctly to the ends of previous segments.

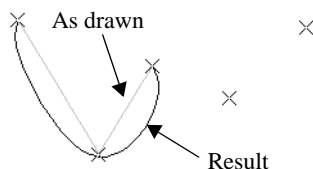

4. As soon as two straight spline segments connect end-to-end, the straight segments become a curve that passes through the endpoints defined by the original segments. Each point is called a vertex.

5. Draw a few more segments, connecting each to the free end of a previously drawn segment.

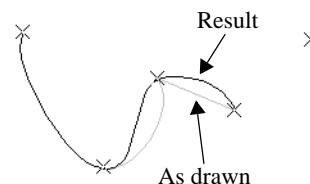

6. Notice as additional segments are drawn that the spline changes the curvature of the previous segment to create a continuous curve between the last three points.

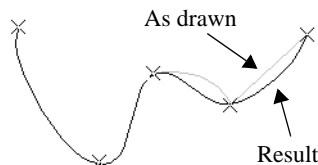

7. Form a closed spline by drawing a segment between its two free ends.

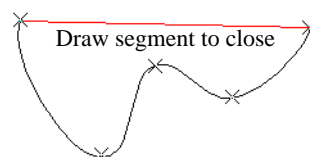

8. The result is an irregular curve that flows smoothly through each vertex.

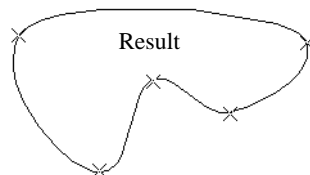

Spline-based objects will only snap together to form a single spline if they share identical

attributes such as color, line style, and arrow specifications.

---

## Displaying CAD Objects

As with architectural objects, the display of CAD objects is controlled in the **Display Options** dialog. See “Display Options Dialog” on page 77.

CAD objects can be drawn in floor plan view and elevation views. They are 2D objects only, though, so they cannot be seen in any

view other than the one they are drawn in and are never visible in camera views or overviews. See “Architectural vs CAD Objects” on page 80.

# Project Planning

The tools described in this chapter let you draw plans with ease and flexibility, run checks on plans so you can be more confident that they are free of common drawing errors, and consider loan calculations for your projects.

## Chapter Contents

- Space Planning
- Room Box Specification Dialog
- Plan Check
- Loan Calculator

---

## Space Planning

 The **Space Planning Tools** are a time-saving way to create a preliminary room-by-room design of a home without getting caught up in the details. Once the shape and layout of the rooms are finalized, the **Build House** tool converts them into a working plan that can be edited and detailed to completion.

### Space Planning Assistant

 Select **Tools > Space Planning > Space Planning**. The **Space Planning Assistant** leads you through a series of windows that gather information about the rooms you want to include in your

house. When you click **Finish**, the selected room boxes display.

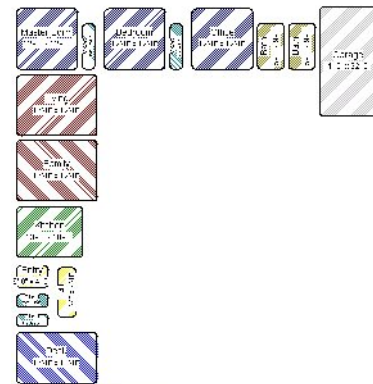

Room boxes can now be arranged into a floor plan.

## Placing Room Boxes

In addition or as an alternative to the room boxes created for you by the **Space Planning Assistant**, you can create your own room boxes. To do so, select **Tools>**

**Space Planning** , then choose the desired room type from the submenu. Click in floor plan view to place a room box of the selected type at that location.





## Displaying Room Boxes

Room boxes and their labels are located on the “Space Planning Boxes” layer. Space Planning Box labels use the Text Style assigned to that layer, as well. See “Displaying Objects” on page 76.

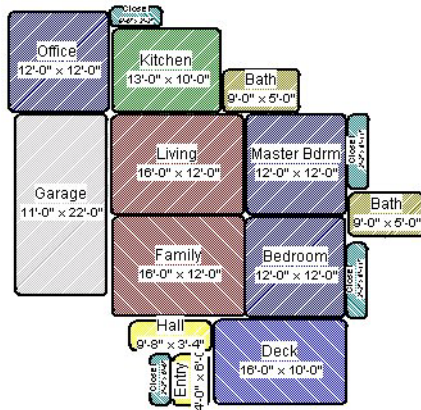
## Editing Rooms

Once created, room boxes can be edited in a variety of ways.



- Select room boxes using the **Select Objects**  tool just like other objects in Home Designer Architectural. See “Selecting Objects” on page 88.
- Room boxes can be resized, rotated, and rearranged. See “Editing Box-Based Objects” on page 101.
- Try to line up the rooms so that they are just touching. Excessive overlaps may cause your rooms to form incorrectly. Closets are the exception. You can overlap a room with a closet, or place inside another room box.
- Rooms can be copied and pasted using the **Copy/Paste**  edit button and deleted using the **Delete**  edit button.
- Select **Tools> Space Planning**  to access the room box tools and place additional room boxes in your plan. Select a tool and click in the plan to place a room box of that type.
- Select **Tools> Space Planning> Toggle Room Boxes**  to hide or show the room boxes.

## Build House

When the rooms are in place, select **Tools> Space Planning> Build House**  to convert the rooms into a building model. Walls and doors are inserted between the rooms that you arranged.

## Multiple Floors

If you specified a two-story house, follow these steps:

1. Edit and arrange the room boxes on Floor 1 as desired.
2. Select **Tools> Space Planning> Build House**  tool to create the walls on the first floor.
3. Go **Up One Floor**  and notice that the positions of the walls on Floor 1 display in red as a reference.
4. Arrange the rooms on Floor 2 as desired, using the reference display as a guide.
5. On the second floor, select **Tools> Space Planning> Build House**  to complete the second floor.

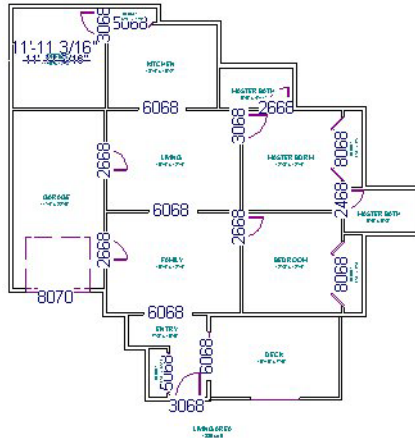

When you Build House, the “Space Planning Boxes” layer is automatically turned off. The room boxes that you created are not deleted, however.

---

## Room Box Specification Dialog



Select a room box and click the **Open Object** edit button to open the **Room Box Specification** dialog.

### General Panel

Most of the settings on the GENERAL panel are used when the selected room box is

converted to a room using the **Build House**  tool.

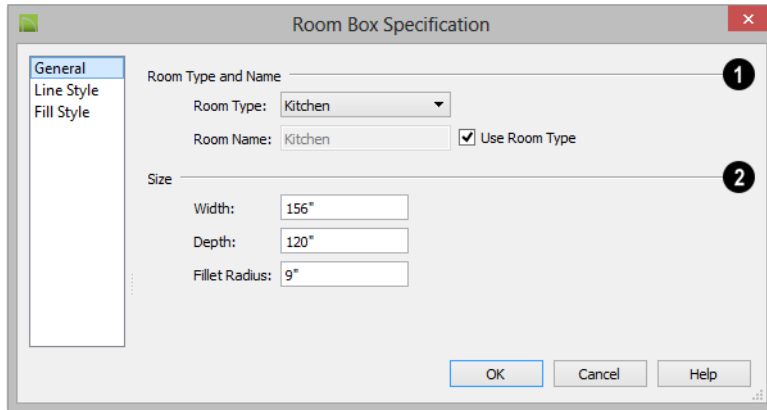

**1** Specify the selected room box’s **Room Type and Name**.

- Select a **Room Type** from the drop-down list. See “Room Types” on page 164.
- If you wish, uncheck **Use Room Type**, then specify a custom **Room Name** for the selected room box.

**2** Specify the **Size** of the selected room box.

- Specify the room box’s **Width** and **Height**.
- Specify the **Fillet Radius**, which is the radius of the curve on each of the room box’s corners. Unlike the other settings

on this panel, this value does not affect the shape of the room created using **Build House** .

### Line Style Panel

The settings on the LINE STYLE panel are available for a variety of other objects in the program. For information about these settings, see “Line Style Panel” on page 514.

### Fill Style Panel

For information about the settings on this panel, see “Fill Style Panel” on page 519.

---

## Plan Check



**Plan Check** checks the floor of your plan currently shown on screen for anything that appears to violate common building practices. Plan Check may not find all the problems in a plan, but does it point out areas that may need improvement.

As your plan evolves, a number of things that may become incorrect can be fixed using Plan Check. For example, doors that change from exterior to interior as you add new rooms are redrawn without the threshold line that marks an exterior door. A cabinet, fixture or furniture item that is against a wall because the wall was moved into it, as

opposed to the item moving, are attached to the wall.

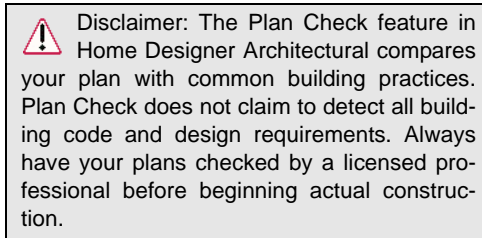

To run Plan Check, select **Tools> Plan Check** .

## Plan Check Dialog

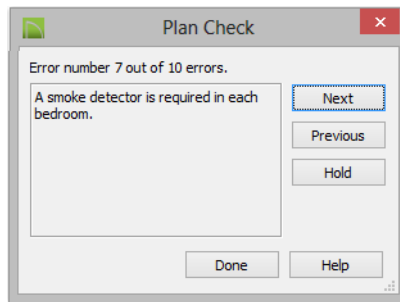

The current error number, along with the total number of errors found, is stated at the top of the dialog.

A description of the current error displays in the field on the left.

Options for navigating Plan Check are found on the right side.

- Click **Next** to ignore the current error and proceed to the next.

- Click **Previous** to return to the previous error.
- Click **Hold** to suspend Plan Check so you can fix the current error. Select **Tools> Checks> Plan Check** again and the check starts where it left off.
- Click **Done** to terminate Plan Check.



Potential plan errors found are usually highlighted in floor plan view. To ensure the highlighted item is on-screen, make sure the entire plan is shown in the window before you run **Plan Check** .

If this dialog obscures the floor plan view, drag its title bar to move it. It remembers its new position and displays there the next time

**Plan Check**  is run.

## Room Types

**Plan Check**  can do a much better job of checking for problems if it knows what the rooms in your plan are to be used for, so you should assign a Room Type to each room in your plan. See “Room Types” on page 164.

The first time **Plan Check**  runs in a plan, it automatically assigns a room type to as many undesignated rooms as it can. Some rooms are determined by their size and shape, and others by their contents. For example, a shelf in a small room indicates a closet; a stove or refrigerator indicates a kitchen; or a bed, a bedroom. If the program cannot assign a room type, **Plan Check**  highlights it and suggests that you do so manually.

## Loan Calculator



Select **Tools > Loan Calculator** to open the **Loan Calculator** dialog. This dialog lets you calculate different aspects of a loan for the current plan based on a variety of parameters.

- 1 Specify what aspect of the loan you would like to calculate from the **Calculate** drop-down list:
  - Monthly Payment
  - Loan Amount
  - Term
  - Interest Rate
- 2 The calculation **Result**, based on the information you provide, displays here.

If you make changes to any of the fields in the dialog, click the = button to refresh the **Result**.

- 3 The **Required Fields** are the same as the options in the **Calculate** drop-down list. The option selected under **Calculate** will be inactive under **Required Fields**.
  - Specify the desired **Loan Amount**.
  - Specify the desired **Term**, in years.
  - Specify the desired **Interest Rate**.
  - Specify the desired **Monthly Payment**.
- 4 The **Optional Fields** allow you to include additional information in your loan calculation.
  - Specify the expected **Property Taxes** per year.
  - Specify the expected **Homeowner's Insurance** cost per year.
  - Specify the expected **Private Mortgage Insurance (PMI)** cost per year.
  - Specify the cost of any expected **Other Fees**.

When **Monthly Payment** is calculated, each **Optional** value is divided by twelve (months) and then added to the total payment.

When a **Calculate** option other than **Monthly Payment** is selected, these values are divided by twelve (months) and then subtracted from the specified **Monthly Payment** value. The result, which does not display, is then used to determine the **Loan Amount**, **Term** or **Interest Rate**.



# Pictures, Images, and Walkthroughs

Home Designer Architectural uses picture files in a variety of ways to enhance your drawings.

The Library Browser contains images of real world objects like plants and vehicles that can display in 3D views.

Picture files can also be imported into Home Designer Architectural and shown in most views.

You can save any view using a variety of picture file formats. In addition, Home Designer Architectural allows you to create virtual tours that can be saved as **.avi** files, shared with others, and played back later.

## Chapter Contents

- Picture Files vs Pictures and Image Objects
- Images
- Displaying Images
- Editing Images
- Image Specification Dialog
- Pictures
- Picture File Box Specification Dialog
- Metafiles
- Metafile Box Specification Dialog
- PDF Files
- PDF Box Specification Dialog
- Displaying Pictures, Metafiles, and PDF Boxes
- Editing Pictures, Metafiles, and PDF Boxes
- Copy Region as Picture
- 3D Backdrops
- Walkthroughs

---

## Picture Files vs Pictures and Image Objects

In common computer language, picture files, pictures and images are more or less synonymous. In the Home Designer Architectural environment, however, there are some notable differences between these terms.

In Home Designer Architectural, a two dimensional image file such as a .bmp, .jpg, .gif, or .png is referred to as a picture file or an image file. Examples of these files are saved on most computers and can be opened in a variety of applications.

A Picture, on the other hand, is a file that has been imported into the program. Pictures can be imported into floor plan view and Elevation views. They are two-dimensional

only and do not display in camera views or overviews.

An Image object is also based on a picture file, but it does display in both 2D and 3D views. Images have 3D width and height data associated with them, as well as a 2D symbol which displays in floor plan view.

Picture files have additional uses in Home Designer Architectural, as well:



- Backdrops are picture files that display behind 3D views. See “3D Backdrops” on page 455.
- Textures are picture files that realistically represent materials in 3D views. See “About Materials” on page 416.

---

## Images

Images add realistic detail to 3D views without adding many surfaces to the model. For example, a tree image with a single surface can be used instead of a tree symbol with thousands, dramatically improving realism without compromising drawing time.

There are two types of Images in Home Designer Architectural:

- **Images**  rotate so that they always face the camera in 3D views.
- **Billboard Images**  do not rotate to face the camera. An example of when this may be useful is an image of a trellis, which might look awkward when facing a camera from a side view.

### Placing Images



A selection of Images are available in the Library Browser. Select one and click in a floor plan view, camera view or overview to place it. See “Placing Library Objects” on page 406.

### Creating Images





Custom Images can be added to the Library Browser, as well as created in plan files. Home Designer Architectural can use any image with a \*.bmp, \*.jpg, \*.png, \*.gif, \*.tif, \*.pcx, or \*.tga extension.

Generally, .png files work best as Images because this format has good compression

and allows for the Image to contain transparency information.

*To create an Image in floor plan view*

1. In floor plan view, select **Build> Image> Create Image**  or **Billboard Image**  to open the **Image Specification** dialog. See “Image Specification Dialog” on page 532.
2. On the IMAGE panel:
  - Click the **Browse** button to select a picture file on your computer or enter the path to a valid picture file in the **Image File** field.
  - Select a **2D Plan Symbol** from the drop-down list or click the **Library** button and select a symbol from the library. The selected symbol represents the image in floor plan view. See “Image Panel” on page 533.
  - Specify the **Size** and **Position** of the image.
3. Specify transparency information on the **TRANSPARENCY** panel.

4. Click OK to close the **Image Specification** dialog.
5. Click to place the new Image in floor plan view.

*To create an image in the Library Browser*

1. In the Library Browser, right-click on an unlocked folder.
2. Select **New> Image** from the contextual menu to open the **Image Specification** dialog.
3. Browse to the image file you want to add and select your other options. See “Image Specification Dialog” on page 532.
4. Once created, the image is listed in the library folder that you right-clicked on. Size and other data is saved.

**Using Paste Image**



You can also import an image by first copying it to the system clipboard, then navigating to a Home Designer Architectural window and selecting **Edit> Paste> Paste** from the menu. See “Paste Special” on page 85.

**Displaying Images**



The display of images in floor plan and 3D views is controlled in the **Display Options** dialog. See “Displaying Objects” on page 76.

Images are placed on the “Images” layer.

**In Floor Plan View**

In floor plan view, most images are typically

represented by an Image  symbol. You can specify a different symbol to represent an image if you wish. See “Image Specification Dialog” on page 532.

**In 3D Views**

The actual picture associated with an image object can be seen in 3D views, as can any

transparency data associated it. See “Image Specification Dialog” on page 532.

Images can be set to either rotate so that they always face the camera or remain stationary, like billboards. See “Images” on page 530.

---

## Editing Images

Images can be selected in 2D and 3D views and edited using the edit handles, edit tools and the **Image Specification** dialog.

When an image is resized using the edit handle, its aspect ratio is retained and 2D symbol resizes proportionally.

### Using the Mouse

In floor plan view, a selected image rotated, moved, and resized. In 3D views, a selected image only has one edit handle: the circular Resize handle.

### Using the Edit Toolbar

A selected image or images can be edited in a variety of ways using the buttons on the edit toolbar. As with most objects, images can be copied, replicated, moved, deleted, etc. See “The Edit Toolbar” on page 28.

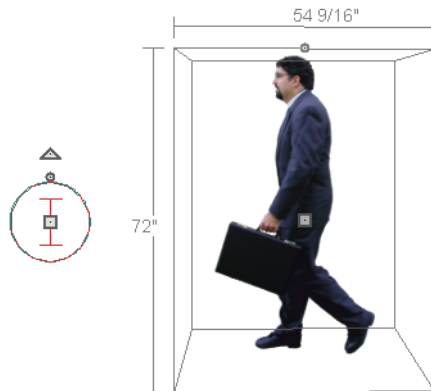

---

## Image Specification Dialog



Select an image and click the **Open Object** edit button to open the **Image Specification** dialog.

## Image Panel

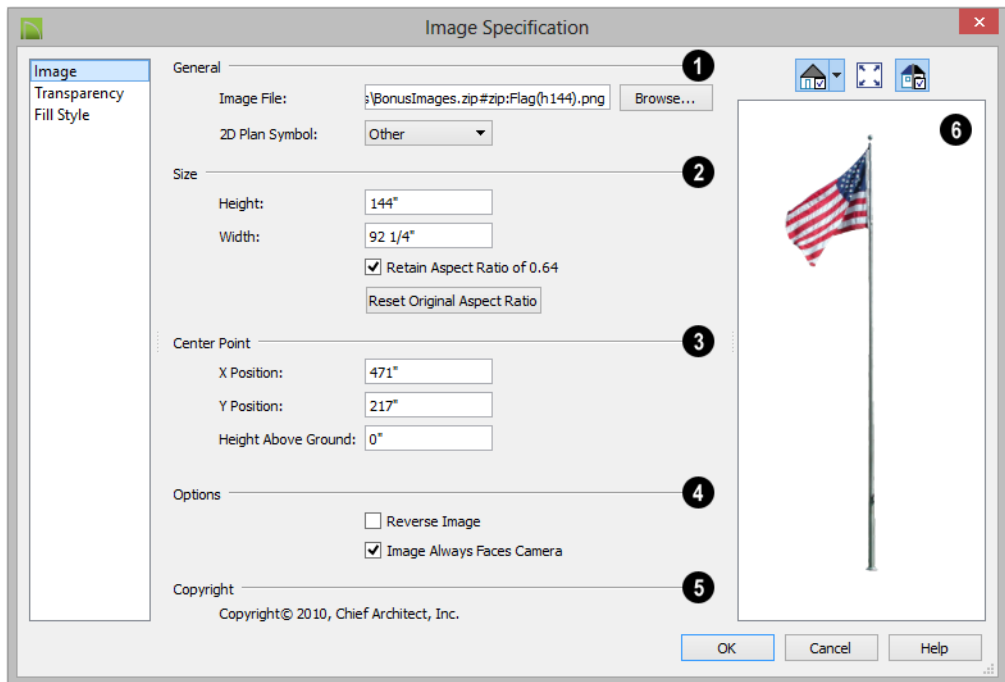

- 1 **General** information about the selected Image can be specified here.
  - The **Image File** associated with the Image can be specified. Click **Browse** to choose a file saved on your computer or type the file's full pathname in the text field.
  - Select a **2D Plan Symbol** from the drop-down list to represent the Image in floor plan view. See "Displaying Images" on page 531.
- 2 Specify the **Size** of the image as it displays in 3D views.
  - Enter a **Height** for the selected image.
  - Enter a **Width** for the selected image.
- Uncheck **Retain Aspect Ratio of X** if you would like to modify the Height or Width without affecting the other value. If you do this, the image may appear distorted. This checkbox does not affect editing performed outside of this dialog and is an action rather than a state: the next time you open this dialog, it will be checked.
- Click **Reset Original Aspect Ratio of** to reset the image's original aspect ratio and remove any distortion caused by resizing.
- 3 Specify the location of the selected image's **Center Point**.
  - Position the selected image precisely by specifying its **X and Y Coordinates**.

- Specify the image's **Height Above Ground**.
  - Select the **Elevation Reference** from the drop-down list. This determines where the next two settings are measured from and also affects their setting labels.
  - Specify the height **to Top**, measured from the selected Elevation Reference to the top of the image.
  - Specify the height **to Bottom**, measured from the selected Elevation Reference to the bottom of the image.
- 4 Options -**
- Check **Reverse Image** to reflect the appearance of the image about an imaginary vertical line through its center.
- Check **Image Always Faces Camera** to prevent the image from rotating to face the camera in 3D views. This box is unchecked for Billboard Images. See "Images" on page 530.
- 5** Any **Copyright** information associated with the selected Image will be stated here.
- 6** A preview of the selected Image displays here. The Glass House Rendering Techniques is not available for images. See "Dialog Preview Panes" on page 32.

## Transparency Panel

The settings on the TRANSPARENCY panel let you specify portions of the selected image as transparent.

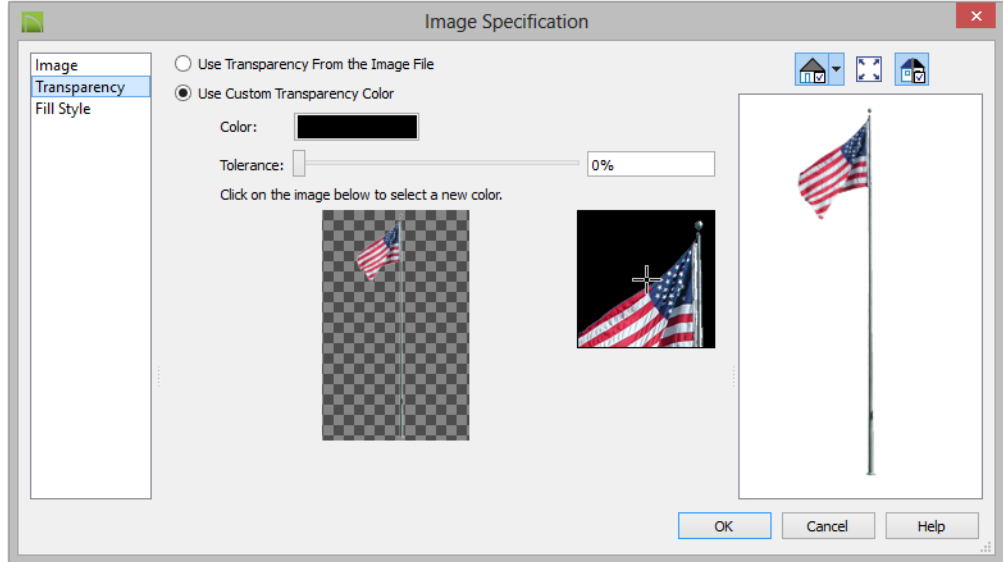

- Click the **Use Transparency From The Image File** radio button to use any transparency data included in the image file.
- Click the **Use Custom Transparency Color** radio button to specify a color in the image to represent the transparency and enable the settings below.
- Click the Color box to select a color in the **Select Color** dialog. See “Select Color Dialog” on page 438.
- Use the slide bar or enter a value to specify a level of **Tolerance** to be applied to colors that are almost the same as the specified transparency color.
- Move your pointer over the small preview image below. The pointer changes to an eyedropper and a magnified preview displays to its right. Click to select the color of the pixel your pointer is over as the Transparency color. The selected color displays in the Color box, below.
- A magnified preview of the area in the preview image above displays here, allowing for accurate pixel selection.

Note: The image preview will display its original orientation, even if Reverse Image is checked on the Image panel.

## The Transparency Color

If the portion of the image file that you wish to use contains the transparency color, that part of the image also becomes transparent. If this happens, the image may appear partially disintegrated.

You may need to experiment to find the best transparency color and tolerance for the image.

## Fill Style Panel

For information about the settings on this panel, see “Fill Style Panel” on page 519.

## Pictures

A variety of picture file types can be imported into and exported out of Home Designer Architectural.

Metafiles are also types of picture files that can be imported and exported. See “Metafiles” on page 537.

### Exporting Pictures

There are several ways to save a picture of a view in Home Designer Architectural:



Using the **Export Picture** tool is similar to creating a screen capture of everything in the current view window. Pictures can be saved in various file formats and used in other applications.

**Export Picture**  is best suited for rendered views. When exporting a line-based view, best results can be achieved by saving it as a Metafile. See “To export a metafile” on page 537.

The **Copy Region as Picture**  tool also lets you create a picture file based on the current view, but allows you to specify what portion of the view is exported. See “Copy Region as Picture” on page 541.

The current view can be saved as a PDF file or printed using the **Print Image**  tool. See “Print Image Dialog” on page 570.

#### *To export a picture*



1. Open the view that you would like to export as a picture file.
2. Zoom, pan or otherwise adjust the view so that what you see on screen suits your needs. See “Displaying 3D Views” on page 453.
3. Select **File> Export> Export Picture (BMP, JPG, PNG)**  to open the **Export Picture File** dialog and give the file to be exported a name, file type, and location. See “Exporting Files” on page 47.

### Importing Pictures



Pictures can be imported into and displayed in floor plan view and Elevation views. Pictures do not display in camera views or overviews. See “Displaying Pictures, Metafiles, and PDF Boxes” on page 540.

There are several ways to import a Picture into Home Designer Architectural:

- Select **File> Import> Import Picture (BMP, JPG, PNG)**  to open the **Import Picture File** dialog, which is a typical open file dialog. See “Importing Files” on page 51.
- Click and drag an image file from an operating system window into the Home Designer Architectural window.
- In any application, copy an image to the system clipboard, then select **Edit> Paste> Paste**  from the Home Designer Architectural menu in an eligible view window. See “Paste Special” on page 85.



Note: Importing large, or multiple, Pictures into a plan file can result in program slowness.

An imported picture is placed in the center of the current view. Once imported, pictures can be selected and edited. See “Editing Pictures, Metafiles, and PDF Boxes” on page 540.

## Picture File Box Specification Dialog



Select an imported picture file and click the **Open Object** edit button to open the **Picture File Box Specification** dialog.

The settings in this dialog are similar to those on the **LINE STYLE** panel in numerous other

dialogs, with one exception: check **Show Outline** to turn on the display of the picture’s border polyline.

See “Line Style Panel” on page 514.

## Metafiles

A metafile (**.emf**, **.wmf**) is a special picture file format made up of vectors (lines) that allow the image to be rescaled without loss of quality. High resolution pictures of line-based views can be exported as a metafile.

Note: Metafiles are not supported in Mac operating systems and cannot be imported or exported in Mac versions of the software.

### Exporting Metafiles





An enhanced metafile (**.emf**) can be exported from any line-based view: that is, from floor plan view and 3D Vector Views.

Only objects that display on screen are included in an exported metafile.

#### *To export a metafile*

1. Accurately position the view on screen.

2. Select **File > Export > Export Metafile (EMF)** .
3. Drag a marquee  from corner to corner, defining the area that will included in the metafile.
4. Release the mouse to open the **Metafile Size** dialog.

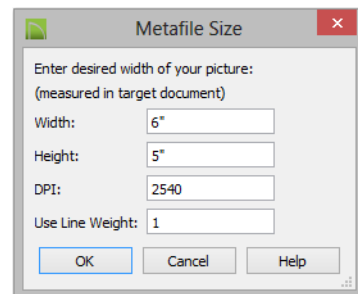

5. Specify the desired **Width** or **Height** of the metafile. When one value is edited, the other changes to maintain its aspect ratio.

Specify, too, the desired **Dots Per Inch (DPI)** for the metafile. A larger value results in a higher quality metafile, but also a larger file size.

- When a metafile is exported from a 3D Vector View, you can also specify the printed thickness of lines in the view. To increase the printing line weight, type a larger number in the **Use Line Weight** field. See “Vector View” on page 478.

Metafiles exported from floor plan view use the line weights defined in the **Display Options** dialog. See “Display Options Dialog” on page 77.

- Click OK to open the **Export Metafile** dialog, which is a typical Save As dialog. See “Saving, Exporting, and Backing Up Files” on page 45.
- Enter a name and location on your computer for the metafile, then click **Save**.

## Importing Metafiles



Metafiles can be imported into and displayed in floor plan view and Elevation views. Metafiles do not display in camera views or overviews. See “Displaying Pictures, Metafiles, and PDF Boxes” on page 540.

There are two ways to import a metafile into Home Designer Architectural:

- Select **File > Import > Import Metafile (EMF, WMF)**  to open the **Import Metafile** dialog, which is a typical open file dialog. See “Importing Files” on page 51.
- You can also click and drag a metafile file from an operating system window into the Home Designer Architectural window to import it.

An imported metafile is placed in the center of the current view. Once imported, metafiles can be selected and edited. See “Editing Pictures, Metafiles, and PDF Boxes” on page 540.

---

## Metafile Box Specification Dialog



Select an imported metafile and click the **Open Object** edit button to open the **Metafile Box Specification** dialog.

The settings in this dialog are similar to those on the **LINE STYLE** panel in numerous other

dialogs, with one exception. Check **Show Outline** to turn on the display of the picture’s border polyline.

See “Line Style Panel” on page 514.

---

## PDF Files

Portable Document Format (**.pdf**) files are a special type of file that can be viewed on

nearly any computer and can include a wide variety of visual information.

You can import **.pdf** files into Home Designer Architectural in floor plan and elevation views. Once imported, PDF boxes behave and can be edited similar to imported pictures and metafiles. See “Editing Pictures, Metafiles, and PDF Boxes” on page 540.

Some **.pdf** files can contain both 2D and 3D information; however, Home Designer Architectural can only support 2D data in an imported **.pdf** file. When a 3D **.pdf** file is

imported, it may display text, a static image of the 3D model, or it may not import at all.



You can also create a 2D **.pdf** from any view by printing. See “Printing to a PDF File” on page 567.

Note: Importing large, or multiple, **.pdf** files into a plan or layout file can result in program slowness.

## Importing PDF Files



To import a **.pdf** file, select **File> Import> Import PDF**.

You can also import a **.pdf** file by dragging it from an operating system window into the Home Designer Architectural window.

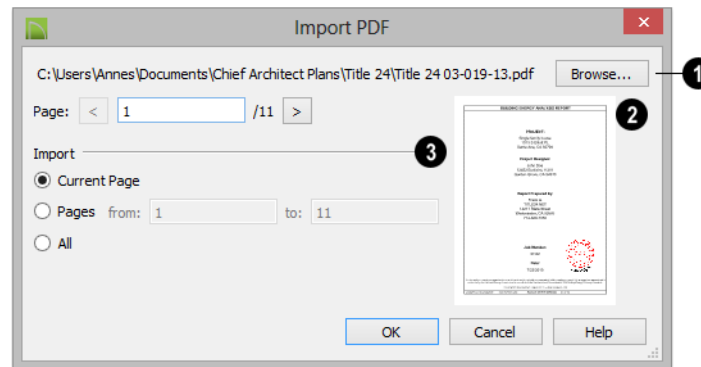

**1** The full pathname of the **.pdf** file displays here. If the pathname is not that of a valid **.pdf** file, this text will display in red.

- Click the **Browse** button to choose a new **.pdf** file or to relink to a missing file.
- Specify the **Page** of the **.pdf** file that displays in the preview on the right. Type a page number in the text field or use the arrow buttons to browse the pages sequentially.

**2** A preview of the page selected above displays here.

**3** Specify how much of the **.pdf** file you wish to **Import**. When multiple pages are imported, a separate PDF box is created for each one.

- Select **Current Page** to import only the page specified above and shown in the preview to the right.

- Select **Pages**, then specify the starting page in the **From** field and the ending page in the **To** field.
- Select **All** to import the entire **.pdf** file.

---

## PDF Box Specification Dialog



Select an imported PDF box and click the **Open Object** edit button to open the **PDF Box Specification** dialog.

The settings in this dialog are similar to those on the **LINE STYLE** panel in numerous other

dialogs, with one exception: Check the **Show Outline** box to turn on the display of the PDF box's border polyline.

See "Line Style Panel" on page 514.

---

## Displaying Pictures, Metafiles, and PDF Boxes



The display of Pictures, Metafiles, and PDF Boxes is controlled in the **Display Options** dialog. See "Displaying Objects" on page 76.

Pictures, Metafiles, and PDF Boxes are placed on the "CAD, Default" layer.

Pictures, Metafiles, and PDF Boxes can be imported into and displayed in floor plan view and Elevation views. A Picture,

Metafile, or PDF Box can only be seen in the view where it was imported and cannot be imported into a camera view or overview.

### Drawing Groups

Imported pictures and PDF Boxes are placed in the Back Drawing Group, and imported metafiles are placed in the Default Drawing Group. See "Drawing Groups" on page 107.

---

## Editing Pictures, Metafiles, and PDF Boxes

Pictures, Metafiles, and PDF Boxes can be selected and edited using the edit handles, the edit toolbar, and their specification dialogs.

### In the Specification Dialog

Pictures, Metafiles, and PDF Boxes can be customized in their specification dialog. See:

- "Picture File Box Specification Dialog" on page 537

- "Metafile Box Specification Dialog" on page 538
- "PDF Box Specification Dialog" on page 540

### Using the Mouse

Pictures, Metafiles, and PDF Boxes have edit handles similar to other box-based objects. See "Editing Box-Based Objects" on page 101.

- The corner Resize handles behave do not behave the same for Pictures, Metafiles, and PDF Boxes as they do for CAD boxes, however. If you drag a corner handle of one of these objects while the Default Edit Behavior is active, its contents will resize and height to width ratio will be retained.
- If you drag an Extend handle along a Picture, Metafile, or PDF Box's edge, the contents of the box will not be resized. If you resize it larger, an empty space will be created between that edge and the contents; if you resize it smaller, the contents will be cropped.

#### *To resize a picture or metafile*

1. Find two items on the imported picture or metafile that are separated by a known horizontal or vertical distance, such as two walls or plot lines.
2. Draw parallel CAD lines to represent these two items and use dimensions to position the lines so that they are the

known distance between the two items in the imported picture. See “The CAD Drawing Tools” on page 511.

3. Click and drag one of the imported picture's corner edit handles to resize it concentrically until the two items are aligned with the two CAD lines.

### Using Dimensions

Pictures, Metafiles, and PDF Boxes can be relocated relative to other objects with precision using dimensions.

To avoid changing the selected object's aspect ratio, make sure you choose to move the entire object rather than the selected edge. See “Moving Objects Using Dimensions” on page 494.

### Using the Edit Tools



A selected Picture, Metafile, or PDF Box can be edited in a variety of ways using the buttons on the edit toolbar. See “The Edit Toolbar” on page 28.

## Copy Region as Picture



You can copy any portion of the screen and save it as a picture file using the **Copy Region as Picture** tool. See “Exporting Pictures” on page 536.

#### *To use Copy Region as Picture*

1. Open the view that you would like to copy all or part of as a picture.
2. Select **Edit > Copy Region as Picture** . Your pointer displays a marquee  icon.

3. Click and drag a rectangular selection marquee around the desired region.
4. The selection is copied to the system clipboard.
  - If the current view is vector-based, the **Metafile Size** dialog displays because metafiles are better suited for line-based pictures. See “Metafiles” on page 537.
  - If the current view is a rendered view, the region is sent directly to the system clipboard.

5. From there, the picture can be pasted into another view or another program.

## 3D Backdrops

A backdrop is an image, typically of an exterior view, that displays in the background of 3D views to help place the model into a realistic setting and add a sense of perspective.



*The backdrop in this view includes hills and clouds*

A selection of backdrop images is available in the Library Browser. You can also create your own backdrop images and import them into the library. See “Adding New Backdrops” on page 403.

Backdrops automatically adjust to fit each view window, so they look best when they are created with a height to width ratio that is similar to the window you are working in.

### Backdrop Specification Dialog





To open the **Backdrop Specification** dialog, select **File> Import> Import Backdrop** or right-click on the User Catalog in the Library Browser and select **New> Backdrop** from the contextual menu. See “Adding New Backdrops” on page 403.



You can create digital photos of a building site for use as a backdrop.

### Specifying a Backdrop

You can select a backdrop image for a plan from the library in either of two ways:

- In any view, select **3D> 3D Backdrop**  to open the **Backdrop** dialog. See “Backdrop Dialog” on page 448.
- In a 3D view, open the Library Browser. Select a Backdrop image, then move your mouse pointer  into the view window. Click anywhere in the view to apply the selected backdrop.

Regardless of how it is selected, only one backdrop can be used in a plan at any given time. If a backdrop is not applied, Home Designer Architectural applies a background color.

You can specify which view types and Rendering Techniques use the selected backdrop in the **Backdrop** dialog.

You can also open this dialog by right-clicking on a backdrop image in the User Catalog in the Library Browser and selecting **Open**  from the contextual menu.



- 1 A preview of the selected image displays here.
- 2 **Backdrop** - Specify backdrop's Name and the image file associated with it.
  - Type a **Name** for the selected backdrop, to be used in the Library Browser and **3D View Defaults** dialog.
  - In the **Location** field, type the full path-name of the image file or click the **Browse** button and browse to the file on your computer.
- 3 If the selected image has a **Copyright**, information about it will display here.

---

## Walkthroughs



A 3D Walkthrough is a series of pictures saved as an **.avi** file that can be played like a video by other applications such as Windows Media Player.



There are two approaches to recording a walkthrough of a plan:

- Draw a path in floor plan view, then direct the program to record a walk-through along that path.
- Create a 3D view, then begin recording and use the Move Camera tools to navigate through the view.

## Create Walkthrough Path

There are several ways to record a walkthrough along a path, but the **Create Walkthrough Path** tool is the fastest and most flexible option.

### To create a Walkthrough Path

1. Begin by choosing a codec for recording walkthroughs. See “Selecting a Codec” on page 547.
2. In floor plan view, select **3D> Walkthroughs> Create Walkthrough Path** , then click and drag to draw a Walkthrough Path. See “To use the Spline tool” on page 521.
3. Edit the direction and curvature of the spline’s segments, as needed. See “Editing Spline Based Objects” on page 103.
4. Add **Key Frames**  to the path and modify their specifications.
5. Select the path and click the **Record Walkthrough Along Path**  edit button. See “Record Walkthrough Along Path” on page 545.



Walkthrough Paths can follow stairs and ramps to span multiple floors. See “Walkthrough Paths and Stairs” on page 545.

You can also create a walkthrough based on a regular CAD polyline or spline by selecting it and clicking the **Record Walkthrough Along Path** edit button. This was the only way to record a walkthrough along a path in Home Designer Architectural versions 8 through 2012 and does not provide as many options as using a Walkthrough Path.

Walkthrough Paths display in floor plan view when the “Walkthrough Paths” layer is turned on. When displayed, Walkthrough Paths display in front of other objects and will print. They are included in views exported to **.dxf**. See “Layers” on page 75.

## Key Frames

Key Frames are points along a Walkthrough Path that allow you to change:

- Camera direction, tilt angle, and height;
- Changes in walkthrough speed;
- The floor that the walkthrough is on.

These changes are applied as the camera moves along the Walkthrough Path from one Key Frame to another.

To add a Key Frame to a Walkthrough Path, select the path and click the **Add Key**

**Frame**  edit button. Then click on the path to add a Key Frame at that location.

In floor plan view, each Key Frame is represented by a camera symbol centered along the walkthrough path. It displays the frame number, is pointed in the direction of its **Camera Angle**, and its position along the path corresponds to its **Time** setting.





Key Frame **Time**, **Angle**, and other properties can be edited in the **Walkthrough Path Specification** dialog. See “General Panel” on page 548.

You can also use the **Edit Key Frames**  edit tool to enable Move and Rotate edit



handles for each Key Frame on the selected Walkthrough Path.

### *To use the Edit Key Frames edit tool*

1. Select a Walkthrough Path and click the **Edit Key Frames**  edit tool.
2. Each Key Frame on the selected Walkthrough Path will display a Move and Rotate edit handle.
  - Click and drag the square Move handle to reposition the Key Frame along the path.
  - Click and drag the rectangular Rotate handle to change the Key Frame's direction angle
3. When you are finished adjusting the Key Frames, click the **Main Edit Mode**  edit tool to restore the Walkthrough Path's normal edit handles.

## Walkthrough Paths and Stairs

If you draw a Walkthrough Path up or down a staircase or ramp, it will follow the height of the stairs or ramp and continue on the next floor.

### *To create a multiple floor walkthrough*

1. Draw a Walkthrough Path so that it extends into a staircase or ramp in the same direction as its Direction Arrow. See “Displaying Stairs, Ramps, and Landings” on page 263.
  - Do not drag the Walkthrough Path across the entire length of the stairs or

ramp. If you do, its height will remain relative to the current floor.

2. When you release the mouse button, the program will automatically display a dashed line with an arrow extending past the last Key Frame on the current floor.
  - If it follows stairs or a ramp going upward, the path will also extend to the top end of the staircase or ramp.
3. Go up or down one floor, select the Walkthrough Path, and resize and reshape it as needed. You can use the **Create Walkthrough Path**  tool to draw more segments and additional Key Frames can be added, as well.

## Record Walkthrough Along Path

Once a Walkthrough Path has been drawn, you can use it to record a walkthrough video.

### *To record a walkthrough along a path*

1. Begin by selecting a codec for recording walkthroughs. See “Selecting a Codec” on page 547.
2. In floor plan view, select a Walkthrough Path or a CAD polyline or spline.
3. Click the **Record Walkthrough Along Path**  edit button.
4. In the **Save Video As** dialog, specify a name and saved location for your **.avi** walkthrough file. See “Exporting Files” on page 47.
5. In the **Walkthrough Options** dialog:

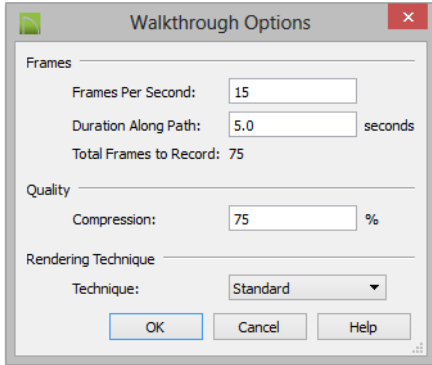

- Specify the desired number of **Frames Per Second**, between 1 and 100. A higher number results in a higher quality recording but also a larger **.avi** file.
- Specify a **Duration Along Path**, in seconds.
- The **Total Frames to Record** displays for reference and equals the Frames Per Second times the Duration along Path.
- Specify a **Compression** percentage between 0 and 100. A value of 0 gives the highest quality images and largest file sizes.
- From the drop-down list, select the **Rendering Technique** you would like the walkthrough to use. See “Rendering Techniques” on page 478.
- Click **OK**.

To cancel the recording as it is being created, press the ESC key on your keyboard.

## Frame by Frame Walkthroughs



You can also create a walkthrough by recording it frame by frame. Although time-consuming, creating a walkthrough in this manner lets you see exactly what is being recorded as you record it.

### To record a walkthrough frame by frame

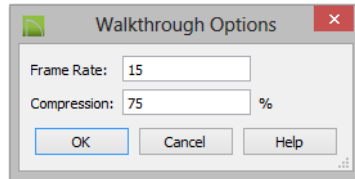
1. Begin by selecting the codec for recording walkthroughs. See “Selecting a Codec” on page 547.
2. Create a camera view. This view is the first frame of the walkthrough.
3. From the view, select **3D> Walkthroughs> Record Walkthrough** .
4. Specify a location and name for the walkthrough in the **Save Video As** dialog and click **Save**.
5. In the **Walkthrough Options** dialog:



- Select a **Frame Rate** between 1 and 100. The value entered is the number of frames per second.
  - Select a **Compression Percent** between 0 and 100. A value of 0 gives the highest quality images and the largest file size.
  - Click **OK**.
6. Use the camera movement tools to create additional views. Each time the screen redraws, that view is recorded as the next frame in sequence. See “Editing 3D Views” on page 461.
  7. To move the camera without saving a view, select **3D> Walkthroughs> Pause Recording**  to temporarily stop recording.

- You can then select **3D> Walkthroughs> Save Frame**  button to control what views are saved.
  - You can start recording again by selecting **Pause Recording**  once more.
8. When the walkthrough sequence is complete, select **3D> Walkthroughs> Stop Recording**  or close the view.

Note: Zooming in and out and using the scroll bars does not change the viewpoint and does not produce a frame for the walkthrough.

If you resize the current view window while recording a walkthrough, the program will stop recording.

### *To play a walkthrough*

1. Select **3D> Walkthroughs> Play Walkthrough**  to open the **Select Video File** dialog.

2. Browse to an **.avi** file on saved on your computer. Your default video application plays the walkthrough video.

## Selecting a Codec

A codec is a utility that compresses and decompresses media files, and is used when both recording and viewing **.avi** files such as walkthrough videos.

You can specify which codec to use when recording walkthroughs in the **Preferences** dialog. See “Render Panel” on page 66.

To choose the codec that best suits your needs, it is a good idea to create a test walkthrough using each of the codecs installed on your system to see how well their walkthrough quality and file compression meet your requirements.

For more information about codecs, visit [www.HomeDesignerSoftware.com](http://www.HomeDesignerSoftware.com).

---

## Walkthrough Path Specification Dialog



Select a Walkthrough Path and click the **Open Object** edit button to open

the **Walkthrough Path Specification** dialog. See “Walkthroughs” on page 543.

## General Panel

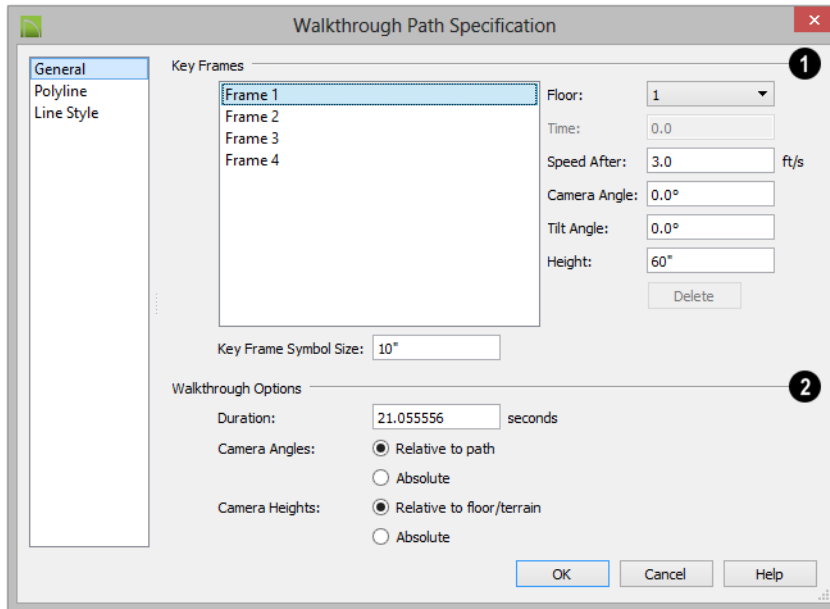

**1** A list of the selected path's **Key Frames** displays on the left. Click on a Frame in the list to select and edit it using the settings on the right. When the dialog is opened, the last key frame edited in the current program session will be selected automatically. See “Key Frames” on page 544.

- Specify the **Floor** that the selected Key Frame is located on. See “Multiple Floors” on page 219.
- Specify the **Time** in seconds at which the selected Key Frame is found in the duration of the walkthrough. Frame 1 is always at 0.0 and cannot be moved; similarly, the last frame is always at the end of the walkthrough Duration.
- Specify the **Speed After (ft/s)**, which is how fast the camera moves along the walkthrough path from the current Key

Frame to the next. Not available if the last Key Frame is selected.

- Specify the **Camera Angle** at the selected Key Frame.
- Specify the **Tilt Angle** of the camera at the selected Key Frame.
- Specify the **Height** of the camera at the selected Key Frame.
- Click the **Delete** button to remove the selected Key Frame from the path.
- Specify the **Key Frame Symbol Size**, which is the size of the symbols representing the selected walkthrough path's Key Frames in floor plan view. See “Key Frames” on page 544.

**2** **Walkthrough Options** -

- Specify the **Duration**, or total length of the walkthrough video in seconds.

Specify how **Camera Angles** are measured:

- Select **Relative to Path** to measure each camera angle relative to the direction of the walkthrough path at each Key Frame location.
- Select **Absolute** to measure each camera angle relative to the plan's X, Y, and Z axes. See "3D Drafting" on page 23.

Note: When Relative Angles are used, a Camera Angle of 0° points in the direction of the walkthrough path. When Absolute Angles are used, 0° always points in the positive direction along the X axis.

Specify how **Camera Height** is measured:

- Select **Relative to Floor/Terrain** to measure camera height relative to the floor or terrain at each Key Frame location.
- Select **Absolute** to measure camera height relative to the plan's Z axis.

## Polyline Panel

The POLYLINE panel states the length of the path's **Perimeter**. The **Area** and **Volume** of a walkthrough path will always be described as "Not closed". See "Polyline Panel" on page 518.

## Line Style Panel

This panel is similar to the LINE STYLE panel in the **Line Specification** dialog. See "Line Style Panel" on page 514.



# Importing and Exporting

Importing is the process of opening a file that was produced in a different program in Home Designer Architectural. Exporting, on the other hand, is the process of saving information in a Home Designer Architectural file to a format that can be read by another program.

Home Designer Architectural allows you to import and export a variety of information from and to other applications. This chapter focuses on importing and exporting 2D .dxf files and a variety of 3D file formats. Other importing and exporting options are described in the chapters in which those objects or settings are discussed.

## Chapter Contents

- Import Room Planner File
- DXF File Format
- Exporting 2D DXF Files
- Additional 2D Export Information
- 3D Data Import Requirements
- Importing 3D Symbols
- Symbol Specification Dialog
- 3D Symbols and Materials
- Exporting a 3D Model

## Import Room Planner File



Select **File> Import> Import Room Planner File**, then select and download a Room Planner file from the cloud. When prompted to log in, use the same credentials you used to save a plan to the cloud in Room Planner.

Files created in Room Planner versions 2 - 4.1 can be imported into Home Designer Architectural 2017.

Note that the exterior walls in an imported Room Planner drawing will inherit their thickness and other properties from the **Exterior Wall Defaults** dialog in the current

plan, while interior walls will retain the thickness that was set in Room Planner. See “Exterior and Interior Wall Defaults Dialogs” on page 120.

Unless a custom ceiling height has been specified in Room Planner, rooms in an imported file use the Default ceiling height set in the **Floor Defaults** dialog. See “Floor Defaults” on page 160.

Visit [roomplanner.chiefarchitect.com](http://roomplanner.chiefarchitect.com) for more information about the Room Planner mobile app.

---

## DXF File Format

**.dxf** (Drawing eXchange Format) is a standard file format created by Autodesk for the transfer of data between other programs.

Many design programs can read and write **.dxf** files. The **.dxf** file format interprets data as CAD objects such as lines, polylines, and circles.

---

## Exporting 2D DXF Files

Line-based 2D files can be exported from Home Designer Architectural in **.dxf** file format. You can specify the version of AutoCAD® to export to. Compatibility with other software may vary.

There are two ways to export a 2D drawing file in Home Designer Architectural: Export Current View and Export All Floors.

### Export Current View



To export a floor plan view or 3D view that is currently active, select **File> Export> Current View (DXF)**.

Bear in mind that floor plan and elevation views are drawn to scale and will produce a 2D drawing that can be accurately dimensioned. Camera views and overviews, on the other hand, are not scaled and do not produce drawings that can be dimensioned accurately.



## Export All Floors



To export the floor plan view for all floor plans simultaneously, select **File> Export> All Floors (DXF)** from any floor of the plan. The floor plans are exported to a single **.dxf** file.

If you choose to export all floors, the file will contain all floors superimposed on each other. Upon export, each layer in your Home Designer Architectural drawing is divided into separate layers: one for each floor. For example: “Electrical-2” contains objects on Floor 2 that were originally on the “Electrical” layer.

## Export Drawing File Dialog

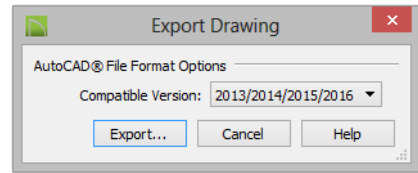

Specify which **Compatible Version** of AutoCAD® you want your **.dxf** file to be compatible with.

Click the **Export** button to save the exported file as a **.dxf** file. See “Exporting Files” on page 47.

---

## Additional 2D Export Information

The export process converts high level Home Designer Architectural objects (doors, windows, etc) into simple, CAD-based objects (lines, arcs, etc). Home Designer Architectural exports all data to AutoCAD®’s Model Space.

### Supported Entities

The following entity types are currently supported for 2D export:

**Line** - The simplest entity. In AutoCAD®, lines are 3 dimensional with the Z coordinate set to zero.

**Arc** - Arcs have a start angle, end angle and radius.

**Circle** - Fully Supported.

**Multi Line Text** - If exporting to an AutoCAD® release that supports multi-line text, Home Designer Architectural writes the

file as multi-line text. If exporting to a version that does not support multi-line text, the file is written as simple text.

**Polylines** - Polylines are a collection of points with lines or arcs connecting them. Home Designer Architectural supports both lines and arcs. Arcs are referred to as bulges in AutoCAD®.

**Block Insert** - A block insert is a reference to a block, which is a named collection of entities. A block can also contain block inserts.

### Dimensions

Each dimension has an associated block containing a representation of the dimension as it is drawn in Home Designer Architectural. It also contains all the data to recreate that information.

- When an exported dimension is modified in AutoCAD® or other CAD program, its appearance changes.
- Home Designer Architectural does not support arrowhead styles or fonts.
- Three kinds of dimensions are generated: Aligned, Rotated and 3 Point Angular.
- Please refer to AutoCAD® documentation for more information.

Note: Uncheck “Use Associative Dimensions” in the Export Drawing File dialog if the CAD program you are using does not support AutoCAD® Associative dimensions. See “Export Drawing File Dialog” on page 553.

### Layers

Layers in other systems are similar to Home Designer Architectural layers, but there are some subtle differences. Layer information is mapped as follows:

Home Designer Architectural	Other Systems
Name	Name
Color	Nearest AutoCAD® Color. Home Designer Architectural uses the default AutoCAD® color table to determine this mapping.
Display	On
Size	Line Weight. In AutoCAD®, line weights are determined by a table of mm line widths. Home Designer Architectural maps to the closest match in this table based the current view’s Line Weight Scale. See “Drawing Sheet Setup Dialog” on page 563.
Style	Line type
Lock	Lock

### Line Types

A line type, or line style, is used by layers and entities to determine how lines are drawn. Home Designer Architectural line types installed with the program are supported on export.

---

## 3D Data Import Requirements

Importing a symbol that can be used by Home Designer Architectural is a relatively simple process that begins with previously created 3D data. This 3D data often comes from a program other than Home Designer Architectural. If you use another 3D modeling program to create the 3D data, be aware of the following requirements before attempting to create symbols.

 Home Designer Architectural is not able to provide support for any third party software.

There are a number of requirements that must be met before any 3D data can be used to create a symbol in Home Designer Architectural:

- The 3D data must be stored in an, object (**.obj**), 3D Studio<sup>®</sup> Mesh (**.3ds**), stereolithography (**.stl**), COLLADA (**.dae**), or SketchUp version 2016 and prior (**.skp**) file format. If you have 3D data in another format, you must convert it into one these formats first.
- Geometry and material information stored in **.3ds** files are imported; cameras and lights are not.
- The 3D model must be composed of 3DSOLID solid entities, or face data. Faces are typically referred to as 3D faces, polygonal faces, or poly meshes. Other types of entities such as lines, curves, circles, polylines, and free form surfaces can exist in the file but are not imported when the symbol is created. This is true for all (**.obj/.3ds/.skp**) file types.
- The face data should be assigned to different layers so that you can map them to the correct materials when viewing them in 3D. It is helpful to name your layers using a convention that identifies that materials should be assigned to each sub-component.
- Pay attention to the origin and orientation of the 3D data when designing symbols. Home Designer Architectural allows some adjustment when creating the symbol, but it is easier to build the 3D data correctly before importing it into Home Designer Architectural. For more information about defining the origin, see “Symbol Origin” on page 1201.
- If a symbol with faces that have more than four vertices is imported, the faces are truncated, resulting in an object that appears to have holes. The best remedy is

to re-export the model from the original application using only triangular or quadrilateral faces.

- Home Designer Architectural does not support grouped objects in symbols imported from **.3ds** files.

## Surface Normals

If you use third party software to create a **.dxf/.obj/.3ds/.skp** files that will be imported as a symbol, you should be familiar with the concept of surface normals.

If you use third party software to create an **.obj/.3ds/.skp** file that will be imported as a symbol, you should be familiar with the concept of surface normals.



A surface normal is a vector that is perpendicular to the plane of a surface. This vector points in one direction, determined by the way the face is drawn.

If a face is drawn clockwise, the surface normals are directed outward; if a face is drawn counter-clockwise, the surface normals point inward. Home Designer Architectural assumes that the face on the positive side of the normal vector is the outside face.

Many objects can be drawn using only one side of each face. A cube is a good example: the inside of a cube is not visible, so it is not necessary to create its inside faces. When

inside faces are not calculated, 3D views in Home Designer Architectural can generate more quickly.



---

## Importing 3D Symbols



Home Designer Architectural supports the import of 3D surface and 3D solid objects saved in **.3ds**, **.obj**, **.stl**, **.dae**, and **.skp** formats.

There are three ways to import a 3D symbol into Home Designer Architectural:

- By selecting **File> Import> Import 3D Symbol**  tool.
- By selecting **New> 3D Symbol**  from the contextual menu in the Library Browser. See “Using the Contextual Menus” on page 396.
- By dragging and dropping the file from an operating system window into floor plan view.

Symbols imported by clicking and dragging are imported for use in the current plan, while those imported using the **Import 3D Symbol** dialog are also saved in the library. See “The Library” on page 393.

### *To drag and drop a 3D symbol file*

1. Open the plan in which you would like to import a 3D symbol and remain in floor plan view.
2. Open an operating system window in front of the Home Designer Architectural program window.
3. Resize and position the window so that the Home Designer Architectural program window can be seen behind it.
4. Click on the desired **.3ds**, **.obj**, **.stl**, **.dae**, or **.skp** file and drag it into the Home Designer Architectural program window.
5. When your cursor changes to a +, click in the drawing area to place as many copies of the symbol as desired. When you are finished, select a different tool.

Symbols imported by clicking and dragging cannot be edited in the **Symbol Specification** dialog. If a symbol needs to be rotated, or its unit of measurement specified, use the **Import 3D Symbol**  tool to import it.

---

## Symbol Specification Dialog



To import a symbol object, select **File> Import> Import 3D Symbol**.

Home Designer Architectural supports the import of 3D surface and 3D solid objects

saved to **.3ds**, **.obj**, and **.skp** formats and treats imported symbols as stand alone fixtures.

The **Import 3D Symbol File** dialog, which opens first, is a typical **Open File** dialog in which multiple files can be group-selected for import. See “Importing Files” on page 51.

The **Symbol Specification** dialog opens next.

## 3D Panel

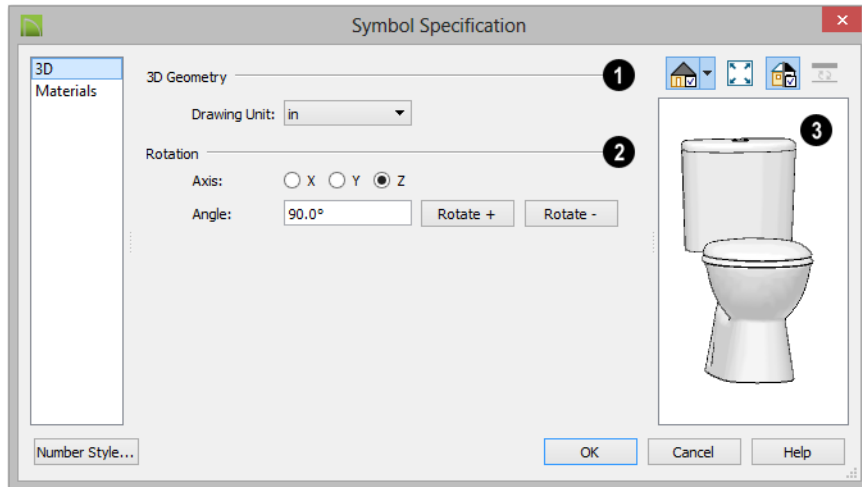

**1** **3D Geometry** - Select the **Drawing Unit** that was used to create the symbol. If any units other than inches or mm are selected, the program will convert the data into units appropriate for Home Designer Architectural.

Note: SKP files are always imported using inches, regardless of the default units used in the plan file. See “Creating a New Plan” on page 44.

**2** The **Rotation** settings allow you to rotate the selected symbol about the X, Y, and Z axes.

- Select the **X**, **Y**, or **Z Axis**.
- Specify the **Angle** to rotate the symbol in the text field. 90° is set by default.

- Click the **Rotate +** or **Rotate -** button to rotate the object around the selected axis in a clockwise or counterclockwise direction, respectively.

**3** A preview of the symbol’s appearance displays here and updates as changes are made to the settings in this dialog. When multiple symbols are selected, the most recently selected symbol displays. See “Dialog Preview Panes” on page 32.

## Materials Panel

The **MATERIALS** panel allows you to assign materials to the symbol’s components and is similar to the same panel in many specification dialogs. See “Materials Panel” on page 420.

## 3D Symbols and Materials

When a symbol is imported into Home Designer Architectural, material definitions may be included with it. How material information is included depends on the symbol's file format. See "About Materials" on page 416.

### STL Files

.**stl** files do not include information about material definitions. When imported, default materials for interior fixtures will be assigned.

### OBJ Files

Material definitions for most **.obj** files are saved in a separate file with the **.mtl** file extension. If such a file exists, the materials associated with the **.obj** file display in the list on the left side of the MATERIALS panel of its specification dialog.

If Home Designer Architectural does not receive material definition information in an accompanying **.mtl** file, default material properties are assigned.

Material definitions for **.obj** files can also include texture information in the form of image files (**.jpg**, **.png**, etc).

In order to properly import an **.obj** file, Home Designer Architectural needs the **.obj** file, the **.mtl** file, and any referenced texture files. If a texture file is not available, the material it is associated with is created without a texture.

The material definitions associated with an imported **.obj** symbol are not available for use by other objects in Home Designer Architectural until that symbol has been placed into a plan. The associated texture files are then copied to the user's Textures folder. See "Home Designer Architectural Data" on page 43.

### 3DS and DAE Files

Material definitions for **.3ds** and **.dae** files refer to texture information in separate image files.

In order to properly import a **.3ds** and **.dae** file, Home Designer Architectural needs these referenced image files. If a texture file is not available, the material it is associated with will be created without it. The associated texture files are copied to the user's Textures folder.

### SKP Files

The textures associated with a **.skp** file are saved in the file. After you import a symbol and either place it in a plan or add it to the Library, these textures are saved in the Home Designer Architectural Textures folder.

Home Designer Architectural does not support deformed textures. If a texture associated with a **.skp** file is deformed, it will be imported without the deformations.

## Texture Filename Conflict

If a texture of the same name already exists in the plan when an **.obj**, **.3ds**, or **.skp** file is

imported, the **Texture Filename Conflict** dialog displays.

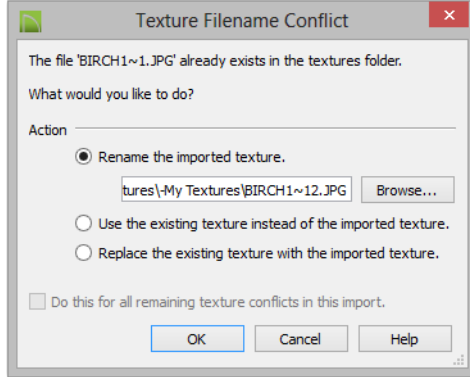

- Select **Rename the imported texture**, then click the **Browse** button to create a

copy of the texture's image file with a new name that you specify.

- Select **Use the existing texture instead of the imported texture** to keep the existing texture.
- Select **Replace the existing texture with the imported texture** to replace the texture already present in the plan with the new, imported one.
- Check **Do this for all remaining textures in this object** to use the same selection for all textures with filename conflicts associated with this symbol.

## Exporting a 3D Model





The entire 3D model, or any part of it that you choose, can be exported from Home Designer Architectural into the **.stl** file format. An **.stl** file can be opened by any program that uses Stereolithography format, and can be printed using a stereolithography machine, or 3D printer.

### *To export the 3D model*

1. A camera view or overview must be active. See “Types of 3D Views” on page 448.
2. Make sure that everything that you want to export is set to display in the current view, and everything you do not want to

export is not set to display. See “Layers” on page 75.

- Any surfaces removed using the **Delete Surfaces**  tool will not be exported. See “Displaying 3D Views” on page 453.
3. When the model is ready, select **File> Export> Export 3D Model (STL)** .
  4. Give the file a name, making sure to save it in the desired location. See “Exporting Files” on page 47.

A 3D model exported to **.stl** format does not include any material or texture information.





# Printing

Home Designer Architectural provides a variety of printing options, from printing scaled plan views and 3D perspectives, to a set of templates that can be assembled into a 3D model.

Home Designer Architectural also allows you to save your drawings in **.pdf** file format that can then be sent to a printing service.

Note: Screen captures are provided for illustrative purposes only and are not an endorsement of any products.

## Chapter Contents

- Introduction to Printing
- The Printing Tools
- Drawing Sheet Setup Dialog
- Print Preview
- Printing to Scale
- Printing Across Multiple Pages
- Printing to a PDF File
- Print View Dialog
- Print Image Dialog
- Print Model

---

## Introduction to Printing

Home Designer Architectural offers printing options to suit a variety of needs. It is helpful to be familiar with these options and choose the one that makes the most sense for the project at hand.

Note: Academic versions of the software produce a watermark on all printed documents.

### Output Options

**Printing a View** - Floor plan and elevation views can be printed to scale. See “The Printing Tools” on page 563.

**Printing an Image** - Any view of your plan can be printed as an unscaled image. See “Print Image Dialog” on page 570.

**Printing to PDF** - Plans can be printed to a .pdf file and printed remotely. See “Printing to a PDF File” on page 567.

**Print Model** - Creates a set of templates that can be used to create a 3D model of your design. See “Print Model” on page 571.

### Terminology

**Paper Size** - The dimensions of the paper to be printed on. Specifying a paper size that is smaller than the scaled drawing allows large drawings to be printed across multiple pages.

**Drawing Scale** - Drawings are often printed to scale for accuracy.  $\frac{1}{4}'' = 1'$  and  $1\text{ m} = 50\text{ m}$  are examples of common scales. You can specify this scale in the **Drawing Sheet**

**Setup** dialog. See “Drawing Sheet Setup Dialog” on page 563.

When a particular scale is not important, drawings can also be sized to fill a particular area. See “Printing to Scale” on page 565.

### Printing Problems

If you encounter difficulties when trying to print, see “Troubleshooting Common Technical Issues” on page 592.

### Printer Drivers

A printer driver is a program that allows a printer to communicate with the rest of the computer system. Drivers are usually created by the printer manufacturer, are typically updated regularly, and can usually be downloaded free of charge from the manufacturer’s web site.

In addition to interpreting between the printer and the rest of the system, printer drivers save default page size, orientation, margin size, and other information that Home Designer Architectural refers to unless you specify otherwise. See “Print View Dialog” on page 567.

If you experience printing problems, consider installing updated drivers for your printer. Visit your printer manufacturer’s web site for more information.



Options available with one driver may not be available with another. Printers supported in one operating system may not be supported by the manufacturer in another.

## Clearing Printer Information

Some information specific to individual printers, such as available paper sizes, is saved with each plan file. You can select **File> Print> Clear Printer Info** to clear the printer-specific information stored with the plan file.

## Displaying Objects



You can control the display of objects when printing directly from a view in the **Display Options** dialog. See “Display Options Dialog” on page 77.

Objects must be visible in order for them to print; however, not all items that are visible will print. See “Print Preview” on page 565.

---

## The Printing Tools



Select **File> Print** to view the Print Tools submenu. These tools fall into two categories.

### Print Setup Tools



**Drawing Sheet Setup** - Opens the **Drawing Sheet Setup** dialog. See “Drawing Sheet Setup Dialog” on page 563.



**Scale to Fit** - Automatically selects a scale that fits your plan to the printer page. See “Printing to Scale” on page 565.



**Center Sheet** - Automatically centers the drawing sheet on your drawing. See “Center Sheet” on page 565.



**Print Preview** - Shows on screen how the current view will appear printed, based on the current scale and other settings. See “Print Preview” on page 565.

### Print Tools



**Print** - Prints the current floor plan to a specified scale. See “Print View Dialog” on page 567.



**Print Image** - Prints the current view including images, textures, and backdrop. Views printed with Print Image are not scaled. See “Print Image Dialog” on page 570.



**Print Model** - Opens the **Print Model** dialog, allowing you to print templates for making a physical model of your plan. See “Print Model” on page 571.

**Clear Printer Info** - Clears the printer information associated with the current page setup.

---

## Drawing Sheet Setup Dialog



Select **File> Print> Drawing Sheet Setup** to open the **Drawing Sheet Setup** dialog.

The **Drawing Sheet Setup** dialog is only

available when floor plan view or an Elevation view is active. When a perspective

view is active, **Drawing Sheet Setup**  is not available.

The settings in this dialog are specific to the current floor plan orthogonal view and are saved with the .plan file..

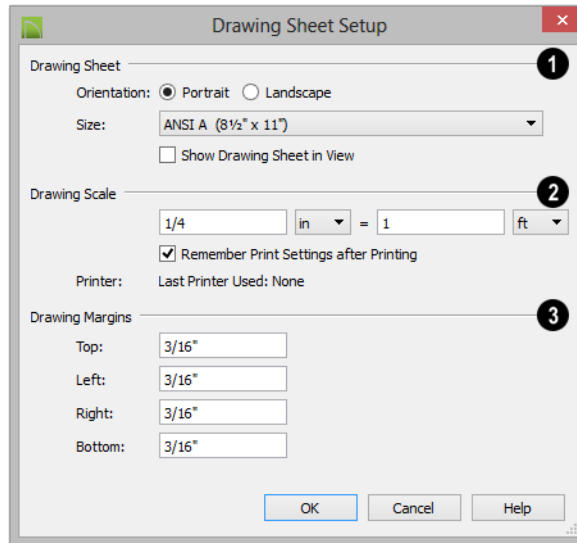

1 Specify the **Orientation** and **Size** of the **Drawing Sheet**, which is the final printed output.

2 Specify the **Drawing Scale** for the active view. This scale is applied only when the view is printed.

The scale is specified in two parts, which by default are ¼ inch = 1 ft or 1 m = 50 m. Both imperial and metric units of measurement are available and can be selected independently.

- Uncheck **Remember Print Settings after Printing** to use the default settings every time a **Print** dialog is opened. When checked, the program remembers

your settings for each type of view. This setting is global, affecting all plan files.

3 Specify the **Drawing Margins**, which define the extents of the printable area of the active view's Drawing Sheet.

- Specify the width of the desired **Top**, **Left**, **Right**, and **Bottom** margins.

### Clearing Printer Information

Select **File> Print> Clear Printer Info** to clear the printer-specific information stored in the **Drawing Sheet Setup** dialog.

---

## Print Preview

 **Print Preview** and its related display toggles allow you to get a sense of what the current view will look like when it is printed.

### Print Preview

 Select **File> Print> Print Preview** for an on-screen representation of how the current view will appear when printed. Print Preview is only available in views that can be scaled. See “Printing to Scale” on page 565.

The printer page displays as a solid white rectangle, and blue lines along the edges of the printer page indicate the edges of the printable area, as defined by the currently selected printer. See “Drawing Sheet Setup Dialog” on page 563.

Objects such as camera symbols, and the Reference Grid that do not print do not display in **Print Preview** . Text and dimension objects appear on-screen as they will on the printed page.

When **Print Preview**  is enabled, color will display depending on whether **Print in**

**Color** is selected in the **Print View** dialog. See “Print View Dialog” on page 567.

The Reference Display does print if it is visible. See “Reference Floor Display” on page 225.

### Color

The **Color** toggle turns the on-screen display of color on or off in all views.

### Reference Grid

The **Reference Grid** is an on-screen grid composed of regular squares that can be used to convey a sense of scale while drawing. It does not print, and its size can be specified in the **General Plan Defaults** dialog. See “General Plan Defaults Dialog” on page 60.

### Center Sheet

 Select **File> Print> Center Sheet** to center the printer page on the drawing. This moves the printer page relative to the drawing but does not affect the coordinates of objects in the drawing. The location of the printer page is independent for each floor of the model.

---

## Printing to Scale

Several different print scaling options are available. The type of view that you are printing determines which options you may choose from.

### Orthogonal Views

Floor plan and Elevation views are orthogonal views, which means:

- Your line of sight is at a right angle to all objects in the view.

- Objects do not appear to decrease in size as their distances from the viewer increase.

Orthogonal views can be printed to scale; however, Elevation views can only be printed to scale when the Vector View Rendering Technique is used.

The scale set in the **Page Setup** dialog is inherited by the **Print** dialog. This scale can be overridden on an individual basis in the **Print** dialog. See “Print View Dialog” on page 567.

Select **File> Print> Scale to Fit**  in an orthogonal view to select a suitable scale and re-center the printer page so that everything fits on the page.

Imperial drawing scales are typically noted in inches per foot. Larger scales, such as 1 inch = 50 feet or 1:200m, are often used for property layouts.

## Perspective Views

Camera views and overviews display the model much the way the eye would see it and cannot be scaled.

- Objects in the view may be at any angle relative to your line of sight.
- Objects seem to decrease in size as their distances from the viewer increase.

Perspective views can only be printed using the **Print Image**  tool. See “Print Image Dialog” on page 570.

---

## Printing Across Multiple Pages

When printing directly from a floor plan view or Elevation view it is possible to print at a scale that does not fit the drawing on one page.

To see on-screen what the drawing will look like when printed, select **File> Print> Print**

**Preview**  and then **Window> Fill**

**Window** . Grey lines across the drawing sheet indicate where the page breaks will occur. See “Print Preview” on page 565.

### *To print across multiple pages*

1. Select **File> Print> Print Preview**  to display the white rectangle representing the printer paper. See “Print Preview” on page 565.

2. Click the **Select Objects**  button, then click near an edge of the printer paper rectangle to select it.

When selected, the printer paper is highlighted in pale grey and a square Move edit handle displays at its center.

3. Click and drag the Move edit handle to position the printer paper so that the portion of your drawing that you would like to print on your first page is located within the printable area of the page.
4. Select **File> Print> Print** . In the **Print** dialog, make sure **To Scale** is selected, then click OK. See “Print View Dialog” on page 567.
5. Select the printer paper rectangle and move it so that the desired contents of

your second printed page are within the printable area and print **To Scale**.

6. Continue moving the printer paper and printing as needed.

When printing multiple pages, it is generally a good idea to leave some overlap on the edges of each page to make sure that information near those edges is not left off the printed pages by mistake.

## Printing to a PDF File

Portable Document Format, or **.pdf** files, are one of the most universally compatible and efficient file formats and can be viewed and printed on most computer platforms.

You can save any view as a **.pdf** file by selecting “Chief Architect Save as PDF” as the Destination printer **Name** in either the **Print View** or **Print Image** dialog. See “Print View Dialog” on page 567 and “Print Image Dialog” on page 570.

If you have a **.pdf** writer installed on your system, you can use it to create a **.pdf** file instead. To print to **.pdf**, simply select it as your printer in the **Print View** or **Print Image** dialog.

When you either save as or print to **.pdf**, you will be asked to create a file name and choose a destination automatically. For more information, see “Saving, Exporting, and Backing Up Files” on page 45.

## Print View Dialog



To print from floor plan view, 3D Vector Views and the Materials List, select **File> Print> Print**. The **Print View** or **Print Materials List** dialog opens. The

settings that are available will vary depending on which version of the dialog is open.

Note: 3D views that are not Vector Views can be printed using Print Image.

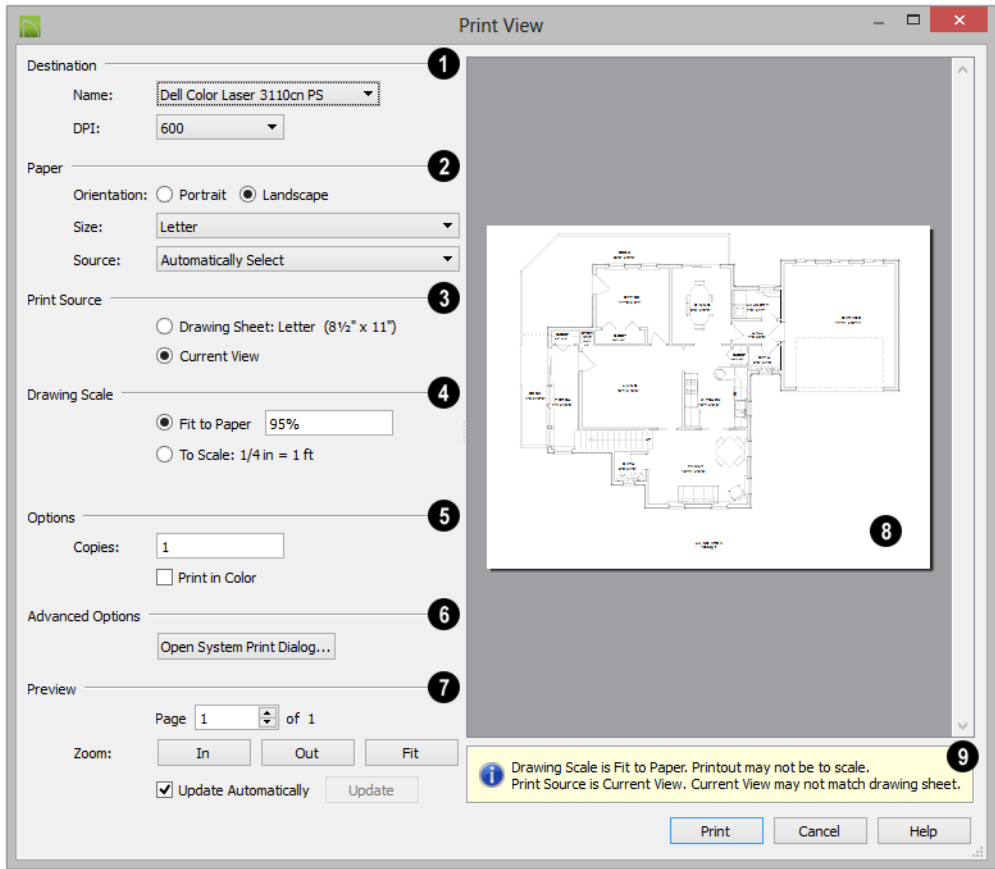

- 1 Select the **Name** of the **Printer** that you would like to use from the drop-down list. To print to **.pdf**, select “Chief Architect Save as PDF” from the list, or choose a **.pdf** writer installed on your system. See “Printing to a PDF File” on page 567.
  - Select the **DPI**, or Dots Per Inch to use when printing, from the drop-down list.

- The available options may vary depending on the selected printer.
- 2 Select the **Paper Orientation**, **Size**, and **Source**. The available Size and Source options are controlled by the selected printer’s driver.



- When possible, the program will automatically set the Size and Orientation to match those of the Drawing Sheet.
  - The Paper Size may be automatically adjusted if the Drawing Scale option is changed, below.
- 3 Specify the **Print Source**. Not available in the **Print Materials List** dialog.
    - Select **Drawing Sheet** to print the entire sheet even though you may be zoomed in on a portion of the view.
    - Select **Current View** to print only that portion of the active view that is currently visible on screen. If you are zoomed out, any blank space outside of the printable objects in the view is ignored.
  - 4 Specify the **Drawing Scale** of the printed output. Changes to these options may cause the Paper Size to change, above. Not available in the **Print Materials List** dialog or in camera views or overviews.
    - **Fit to Paper** prints the view on one page. The program uses whatever scale is necessary to fit the plan on one page.
    - When **Fit to Paper** is selected, specify the percentage of the paper to be used. The default value is 95%.

Note: The Fit to Paper percentage value is global - affecting all views in all files, and is retained between sessions.

- Select **To Scale** to print at the scale specified in the **Drawing Sheet Setup** dialog. See “Drawing Sheet Setup Dialog” on page 563.

- 5 **Options** - Specify the number of **Copies** you would like to print.
- 6 **Advanced Options** - Click the **Open System Print Dialog** button to close the **Print View** dialog and print using your operating system’s Print dialog instead. Not available when No Printer is selected.
- 7 Control the appearance of the print job **Preview** on the right side of the dialog.
  - Specify the **Page** that displays in the Preview area.
  - Click the buttons to **Zoom In**, **Zoom Out**, or **Fit** the selected Page to the extents of the Preview area.
  - Uncheck **Update Automatically** to turn off the print job Preview and prevent it from updating as changes are made to the settings in this dialog.
  - Click the **Update** button to update the print job Preview to reflect the current settings in this dialog. If Update Automatically is unchecked, clicking Update may force the Preview to be blank.
- 8 When **Update Automatically** is checked, a preview of the current print job displays here. The drawing sheet displays as a white rectangle, and if multiple sheets are required, you can scroll through them. If the print job is large, a progress dialog may display briefly as the preview draws or updates.
- 9 To help prevent unwanted printed output, information messages regarding page size, resolution, and scale may display here, depending on the settings in this dialog.

## Print Image Dialog

 Any view can be printed by selecting **File > Print Image**. This is the only way to print most 3D views. See “3D Rendering” on page 469.

The **Print Image** dialog is similar to the **Print View** dialog; however, the printing process is different. **Print Image** prints individual pixels as opposed to vectors (lines).

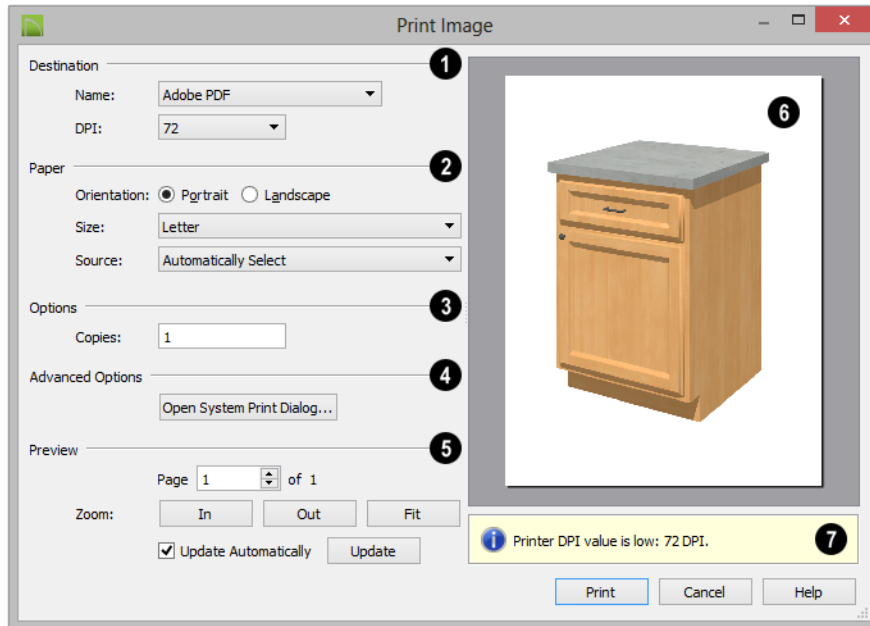

**1** Select the Name of the **Printer** you wish to use from the drop-down list. To print to **.pdf**, select “Chief Architect Save as PDF” from the list, or choose a **.pdf** writer installed on your system. See “Printing to a PDF File” on page 567.

**2** Select the **Paper Orientation, Size, and Source**. The available Size and Source options are controlled by the selected printer’s driver. See “Printer Drivers” on page 562.

**3** Specify the number of **Copies** you would like to print.

**4** **Advanced Options** - Click the **Open System Print Dialog** button to close the **Print View** dialog and print using your operating system’s Print dialog instead. Not available when No Printer is selected.

**5** Control the appearance of the print job **Preview** on the right side of the dialog.

- Specify the **Page** that displays in the Preview area.
- Click the buttons to **Zoom In, Zoom Out, or Fit** the selected Page to the extents of the Preview area.

- Uncheck **Update Automatically** to turn off the print job Preview and prevent it from updating as changes are made to the settings in this dialog.
  - Click the **Update** button to update the print job Preview to reflect the current settings in this dialog. If Update Automatically is unchecked, clicking Update may force the Preview to be blank.
- 6 When Update Automatically is checked, a preview of the current print job displays here. If the print job is large, a progress dialog may display briefly as the preview draws or updates.
  - 7 To help prevent unwanted printed output, information messages regarding page size and resolution may display here, depending on the settings in this dialog.

---

## Print Model



The **Model Maker** allows you to print scaled drawings of wall and roof surfaces in your plan that can be assembled into a 3D model. Three types of prints are created: walls, roof planes, and a floor plan wall layout template for each floor.

### Printing the Model

To print the model templates, choose **File> Print> Print Model** . The **Print Model** dialog opens.

A good way to understand which options best meet your needs is to make a very simple two story plan and try them out.

## Print Model Dialog

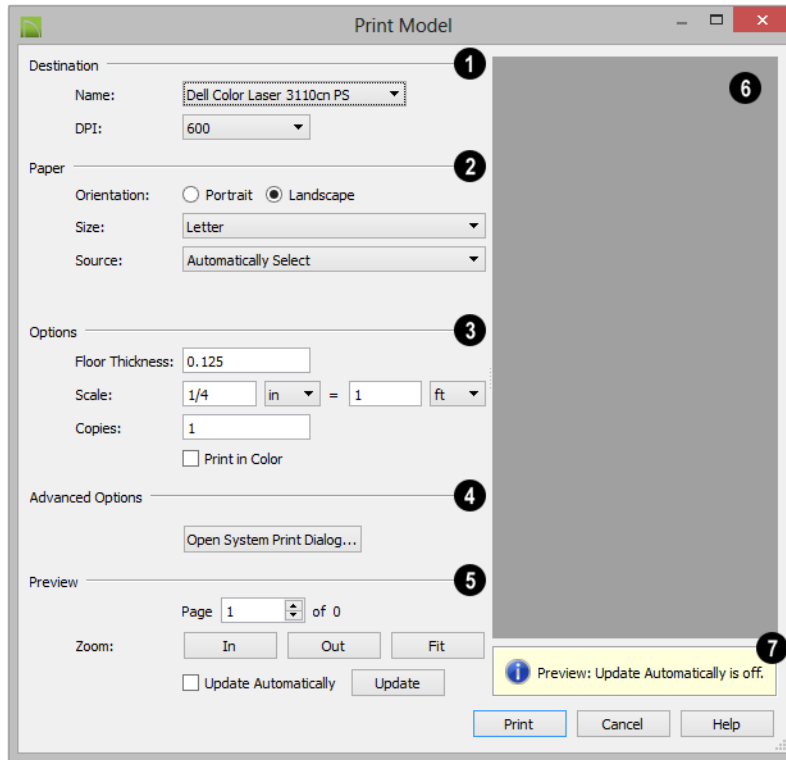

**1** Select the **Name** of the **Printer** that you would like to use from the drop-down list. To print to **.pdf**, select “Chief Architect Save as PDF” from the list, or choose a **.pdf** writer installed on your system. See “Printing to a PDF File” on page 567

**2** Select the **Paper Orientation, Size, and Source**. The available Size and Source options are controlled by the selected printer’s driver. See “Printer Drivers” on page 562.

- Larger page sizes and Landscape orientation are usually best for Print Model.
- Select **All** to print the entire drawing.

**3** **Options -**

- Specify the **Floor Thickness**, which is the thickness of the material you plan to use for the model’s floor platform.
- Specify the **Scale** to be used when printing the model.
- Specify the number of **Copies** to be printed.
- Check **Print in Color** to print in color.

**4** **Advanced Options -** Click the **Open System Print Dialog** button to close the **Print Model** dialog and print using your

operating system's Print dialog instead. Not available when No Printer is selected.

- 5 Control the appearance of the print job **Preview** on the right side of the dialog.
  - Specify the **Page** that displays in the Preview area.
  - Click the buttons to **Zoom In**, **Zoom Out**, or **Fit** the selected Page to the extents of the Preview area.
  - Check **Update Automatically** to have the print job Preview display and update as changes are made to the settings in this dialog. This is not unchecked by default because updating the Preview in the Print Model dialog can be time-consuming.
  - Click the **Update** button to update the print job Preview to reflect the current settings in this dialog. If Update Automatically is unchecked, clicking Update may force the Preview to be blank.
- 6 A preview of the current print job displays here. The drawing sheet for each page displays as a white rectangle, and you can scroll through the pages. If the print job is large, a progress dialog may display briefly as the preview draws or updates.
- 7 To help prevent unwanted printed output, information messages regarding page size and resolution may display here, depending on the settings in this dialog.

## Assembling the Model

Once the templates have been printed, they can be assembled. You need scissors, an

adhesive, and a rigid material like cardboard or foamboard that can be easily cut and glued to provide support for the 3D model.

The Model Maker produces templates of wall and roof surfaces in the model, but does not include tabs or other means of connecting them together. If you wish, you can leave extra paper beyond the template edges as you cut them out for use assembling the model.

### Wall Layout Template

Begin by laying out the Wall Layout template. If it printed on multiple sheets, they should be combined into one. Make sure that exterior and interior wall surfaces line up where the sheets join together.

Fasten the Wall Layout Template to a sturdy surface to provide support for your walls.

### Walls

Walls should be cut and fixed to a rigid backing so that they can stand on their own and support the weight of the roof or floors above them. How they are cut and assembled varies depending on the desired final appearance of the model and how they were printed.

### Roofs

Roof planes are joined together when possible before printing. For each roof surface, the fascia and soffit surfaces are attached at the eave.



# Object Labels

A variety of objects in Home Designer Architectural have labels that display information about them in floor plan views

## Chapter Contents

- Object Labels
- Label Panel

---

## Object Labels

Object labels can display in floor plan view for a variety of different object types using either of two formats:

- Automatic Labels provide basic information about the object, such as its type, size, or name.
- You can create a custom label for an object in its specification dialog using text. See “Label Panel” on page 576.

### Automatic Labels

Most objects that can display labels have an Automatic Label created by the program that states basic information about it.

When **Automatic Labels** is selected in the object’s specification dialog, this is usually the label that will be used; however:

- If a user-defined label is specified in the object’s defaults dialog, that label will be used instead of the Automatic Label.
- Fixtures and appliances inserted into cabinets do not have labels of their own.

### Displaying Labels



The display of object labels can be controlled by layer in the **Layer Display Options** dialog. Label layer names begin with the object type, followed by the word Label: for example, cabinet labels are located on the “Cabinets, Labels” layer. See “Display Options Dialog” on page 77.

You can choose to suppress the label for an individual object on the LABEL panel of its specification dialog.

## Label Panel

The LABEL panel is found in the specification and defaults dialogs for a variety of different objects.

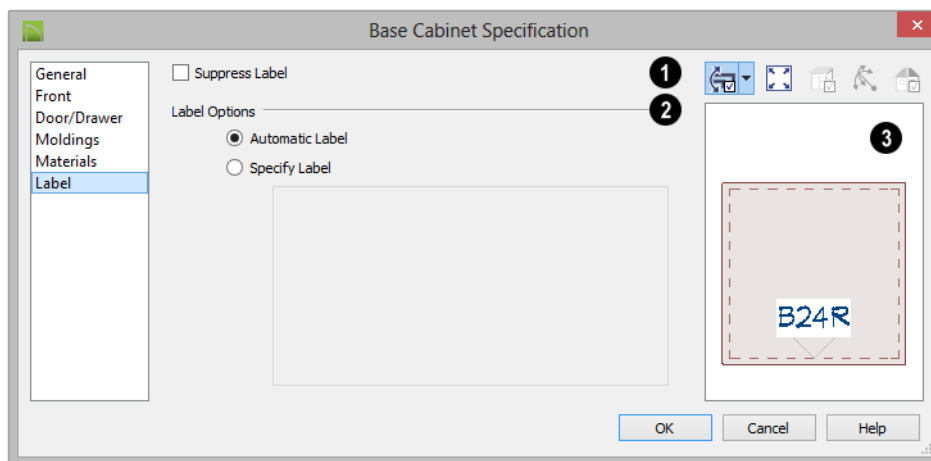

**1** Most objects have a **Suppress Label** option. Check this box to prevent the selected object's label from displaying in floor plan view.

Bay, Box and Bow Windows and Muller Window units have several settings for controlling **Multiple Component** labels. See "Window Labels" on page 203.

- Select **Suppress All Labels** to display no label in floor plan view. Individual components are counted in the Materials List.
- Select **Show Component Labels** to produce labels for each component in floor plan view. Individual components are counted in the Materials List.
- Select **Show Single Label for Entire Unit** to produce one label for the unit and suppress component labels. When this

option is selected, the settings that follow on the LABEL panel become enabled.

These settings also affect how Bay, Box and Bow Windows and Muller Window units are counted in the Materials List. See "Window Labels" on page 203 and "Displaying Muller Units" on page 202.

- 2** The **Label Options** control what information is contained in the label. See "Displaying 3D Views" on page 453.
  - Select **Automatic Labels** to use the default label for the selected object. See "Automatic Labels" on page 575.
  - Select **Specify Label** to replace the selected object's Automatic Label with whatever you type in the text field below. Press the Enter key while the cursor is in the text field to begin a new line.



When Specify Label is chosen, the selected object's Automatic Label initially populates the text field.

- 3** In most specification dialogs, a preview of the selected object displays here. In the preview pane, labels can be seen in Plan View only. See “Dialog Preview Panes” on page 32.



# Materials Lists

Home Designer Architectural can calculate a Materials List in three ways: **for All Floors, From Area, or for Room.**

Materials Lists can be created, edited, and printed directly from the program. They can also be exported as text files for use in other programs.



The Materials List is based on certain assumptions that may not match your building style. Home Designer Architectural makes no representation as to the accuracy or reliability of the Materials List generated by Home Designer Architectural. Always compare the Materials List with a manual take-off before providing a quote or ordering materials for a job.

## Chapter Contents

- The Materials List Tools
- Creating an Accurate Materials List
- Structural Member Reporting
- Organizing Materials Lists
- Materials List Display Options Dialog
- Editing Materials Lists
- Printing and Exporting the Materials List
- Conditioned Area Totals

## The Materials List Tools



Select **Tools> Materials List** to access the Materials List tools.

A Materials List is like a snapshot of the current plan at the time that the list is made. Any changes made to the model after a Materials List is generated are not included in that list. Create a new Materials List if you would like it to include these changes.

It is not necessary to wait until the plan is complete to generate a Materials List. In fact, you can create a series of Materials Lists reflecting costs at various stages of a project.



For comparison, generate Materials Lists with and without a proposed plan modification.

### Calculate from All Floors



Select **Tools> Materials List> Calculate Materials for All Floors** to generate a Materials List for the entire model.

Materials lists calculated from all floors can be lengthy, and only a portion of the list may display on your screen at one time. Use the scroll bars to scroll through the complete list. Move the pointer to cells in the list and click to make changes.

### Calculate From Area



In floor plan view only, select **Tools> Materials List> Calculate From**

**Area** to produce a Materials List for the portion of a plan on a single floor that is included within a temporary rectangular Materials List Polyline.

#### *To use Calculate from Area*

1. In floor plan view, select **Tools> Materials List> Calculate from Area** .
2. Click and drag a rectangle around the area of the current floor that you would like to produce a Materials List for.
3. When the mouse button is released, a Materials List for the area within the rectangle will display.

Calculate From Area rectangles are temporary and do not display in floor plan view after the list is created.

### Calculate for Room



To create the Materials List for a room, select the room and then select **Tools> Materials List> Calculate Materials for Room**.

**Calculate Materials for Room**  is also available on a selected room's edit toolbar. See "Editing Rooms" on page 163.

A Materials List calculated from a room is created for only the contents of that room: wall materials are not included.

---

## Creating an Accurate Materials List

In order to take full advantage of Home Designer Architectural's Materials List capabilities, there are several things to keep in mind.

- The accuracy of your Materials List is directly related to the accuracy of your model. Floor and ceiling heights, wall lengths, and structural settings all directly affect Materials List calculations.
- It takes more than just making your drawing look right to generate an accurate Materials List. If, for example, you use CAD lines to draw an item on a floor plan, that item will not be included in the Materials List. A better way would be to use a symbol or structural element. See

“Architectural vs CAD Objects” on page 80.

- Bear in mind that using generic objects like geometric shapes from the library to represent objects that aren't available in Home Designer Architectural can result in items being calculated in the Materials List in a manner that you might not expect.

### Framing in the Materials List

You can specify whether framing materials are calculated by lineal foot, as a cut list, or as a buy list in the **Structural Member Reporting** dialog.

---

## Structural Member Reporting



The **Structural Member Reporting** dialog allows you to specify the method used to calculate framing members in the Materials List. There are four options to choose from:

- **Lineal Length** calculates the framing materials of the different structural components of the plan in linear feet.
- **Cut List** calculates the framing materials of the different structural components of

the plan by counting the individual pieces present in the model.

- **Buy List** calculates the framing materials of the different structural components of the plan by counting individual pieces and matching them to common board lengths.
- **Mixed Reporting** calculates framing materials using a combination of lineal lengths and piece counts and is recommended for saved Materials Lists in legacy plans.

### Structural Member Reporting Dialog



To open the **Structural Member Reporting** dialog, select **Edit> Default Settings**, then select “Structural Member Reporting” from the tree list and

click the **Edit** button. See “Default Settings vs Preferences” on page 58.

You can also open this dialog by selecting  
Tools> Materials List> Structural Member

Reporting 

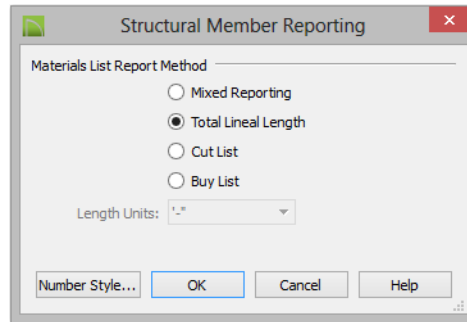

Choose a **Materials List Report Method**.  
The selected method will affect subsequently  
created Materials Lists, but not any that may  
already exist.

- Select **Mixed Reporting** to calculate framing materials using a combination of lineal lengths and piece counts.
- Select **Total Lineal Length** to calculate framing materials in linear feet.
- Select **Cut List** to calculate framing materials by counting the individual pieces present in the model.
- Select **Buy List** to calculate framing materials by counting individual pieces and matching them to common board lengths.
- Select the **Length Units** that you want to use from the drop-down list. The selected unit(s) are used in the Materials List when either **Cut List** or **Buy List** is the selected method of reporting. Not available when **Mixed Reporting** or **Total Lineal Length** is selected.

---

## Organizing Materials Lists

You can control what items are calculated in the Materials List by specifying which categories are used.

There are some parts of a model that cannot be excluded from the Materials List. Floor and ceiling platforms are prime examples. If

you need to generate a Materials List for only part of a plan, such as an addition, consider making a copy of the plan file. In the copy, delete the as-built portion of the plan and then generate a Materials List.

ID	Floor	Size	Description	Count	Extra	Unit	Price	Total Cost	Comment
<b>General</b>									
1									
2	GN1	1	thermal envelope - ceiling area	72.00	0.00	sq ft		\$0.00	
3	GN2	1	thermal envelope - floor area	66.00	0.00	sq ft		\$0.00	
4	GN3	0 37 1/2 high Wall	8" Concrete Stem Wall	36		0 ft		\$0.00	
5	GN4	1 109 1/8 high Wall	Siding-6	37		0 ft		\$0.00	
6	GN5	1	thermal envelope - wall area - North	87.00	0.00	sq ft		\$0.00	
7	GN6	1	thermal envelope - wall area - East	69.00	0.00	sq ft		\$0.00	
8	GN7	1	thermal envelope - wall area - South	87.00	0.00	sq ft		\$0.00	
9	GN8	1	thermal envelope - wall area - West	69.00	0.00	sq ft		\$0.00	
10								Subtotal:	\$0.00
<b>Foundation</b>									
12	FO1	0 8" thick	Concrete	2.74	0.00	cu yd		\$0.00	
13	FO2	0 16" thick	concrete footing - concrete	1.16	0.00	cu yd		\$0.00	
14	FO3	0	foundation bolts	12	0			\$0.00	
15								Subtotal:	\$0.00

## Categories

The line items in the Materials List are organized into a set of predefined categories, such as Electrical and Framing, which display in the **ID** column.

Unlike other categories that calculate materials or objects, the General category lists information about the building's thermal envelope. See "Conditioned Area Totals" on page 585.

## To specify a line item's category

1. Create a Materials List.
2. Click in the cell in the ID column for a line item.
3. Select the desired category from the drop-down list that becomes available.

The categories that are available cannot be altered; however, you can specify which categories are included for individual lists in the **Materials List Display Options** dialog.

## Materials List Display Options Dialog



When a Materials List is open, select **Tools > Display Options** to open the

**Materials List Display Options** dialog for the current list.

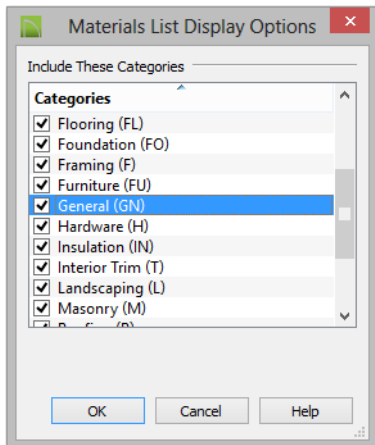

The Categories listed here appear in the ID column of the Materials List in the order they are presented here.

- Check the box beside the name of each category that you want to display in the currently active Materials List.
- Multiple rows can be selected together using Shift and Ctrl keys. See “Shift and Ctrl Select” on page 89.

Note: The information in a suppressed category is still part of the Materials List. If the Materials List is exported, suppressed categories are exported, as well.

## Editing Materials Lists

Materials lists can be edited in a variety of ways. You can adjust the width of a column by clicking and dragging the bar on the right side of the column name.

### Adding Information

You can enter information in the Price and Comment columns for each item.

Adding price or other information for any item is straightforward. Simply click in the cell and type the desired information.

### Changing Information

You can change the information in any column in an individual Materials List. As with added information, click in a cell to select the existing text, then type in the desired text.

To move an item in a Materials List to a new category, select the cell in the **ID** column and

choose a new category from the drop-down list that becomes available. See “Categories” on page 583.

### Total Cost

Total Cost is calculated using the Count, Unit, Price, %Markup, Labor and Equipment columns to calculate the cost. The formula used is:

$$(\text{Count} + \text{Extra}) * \text{Price} * (1 + (\% \text{ Markup}/100)) + ((\text{Count} + \text{Extra}) * \text{Labor}) + ((\text{Count} + \text{Extra}) * \text{Equipment})$$

If a column does not appear, 0 is used for the value of that column with the exception of Count and Price, which are always used in the calculation even if they are not shown.

### Copying Information

Portions of a Materials List can be copied and then pasted into a **Text**  object or into



a word processing program or spreadsheet program using the standard Windows Copy (Ctrl + C), Cut (Ctrl + X), and Paste

(Ctrl + V) commands. See “Copying and Pasting Text” on page 505.

## Printing and Exporting the Materials List



To print a Materials List, select **File> Print** while the Materials List window is active. See “Print View Dialog” on page 567.



A Materials List can also be exported into a tab delimited text (.txt) file that can be opened directly by most spreadsheet programs. In a Materials List window, select **File> Export Materials List**.

The **Write Materials Export File** dialog will open. This is a typical File Save dialog. See “Exporting Files” on page 47.

### Estimating Software

You can export a Materials List to a word processor or spreadsheet program to arrange

it in your estimating format. You can also export the Materials List to a number of commercial estimating programs in whose databases you can keep your current pricing and generate reports based on this data.

Before purchasing an estimating software program, be sure that the program supports the direct import of Chief Architect Materials Lists.

Any questions regarding estimating software packages and how they interact with Home Designer Architectural should be directed toward the company providing the estimating software. Home Designer Architectural is unable to provide any technical support for third party programs.

## Conditioned Area Totals

Conditioned Area is the space within a building that is heated and/or air conditioned, and a Thermal Envelope is a three dimensional boundary built around the Conditioned Space that separates it from the unconditioned space around it. Thermal Envelopes are composed of floor platforms, ceiling platforms, walls, doors, and windows.

When a Materials List is created, Home Designer Architectural calculates the total areas of the components that make up a structure’s Thermal Envelope and lists them

in the General category of the Materials List. See “Categories” on page 583.

Doors are always categorized as doors rather than as windows. This is the case even when a door is specified as a Glass Door or when it is part of a mullied unit.

Conditioned area totals can be entered into third party programs such as **REScheck™** to determine whether the plan meets the energy code in use in your area.

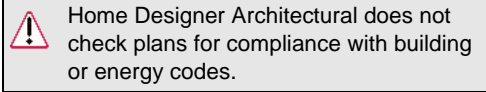

## Conditioned Area

With the exception of Unspecified rooms, rooms that are assigned an interior Room Type are included in the Conditioned Area. “Open Below” rooms are also included; however, other hybrid Room Types as well as exterior Room Types are not. See “Room Types” on page 164.

## Building Orientation

Walls, doors, and windows are categorized as north-, south-, east-, or west-facing for the purposes of conditioned area totals. The definition of North in a plan is straight up on screen in floor plan view.

- If a wall is oriented at 45° or less to north in a plan, it will be categorized as a

“North” wall. Any doors and windows in this wall will also be categorized as “North”.

- Similarly, walls, doors, and windows oriented within 45° of south, east, or west will be classified as “South”, “East” or “West”, respectively.

The orientation of a curved wall is based on the direction of its chord.

## The General Category

The General category of the Materials List lists information about the Thermal Envelope of the current plan. The total linear length of each wall type used in the plan is also calculated in the General category. Walls with different heights are each listed separately. See “Wall Type Definitions” on page 142.

# Additional Resources

Home Designer Architectural offers a variety of resources to help you become familiar with the many features it offers.

- Reference Manual
- User's Guide
- Online Help Videos
- Home Designer Web Site
- Online Home Designer Samples Gallery
- HomeTalk Online User Forum
- Technical Support

---

## Reference Manual

The Home Designer Architectural Reference Manual is a comprehensive source of information for Home Designer Architectural 2017. Chapters are organized by subject, beginning with the fundamental concepts and progressing to the more advanced features. The Reference Manual is

presented in .pdf file format and includes a Table of Contents and Index. This manual is available online by selecting **Help > View**

**Reference Manual**  from the program menu.

---

## User's Guide

Written for new Home Designer Architectural users, but a helpful reference for users of all experience levels as well, the User's Guide features a series of tutorials designed to introduce the basics of using the program.

The Home Designer Architectural User's Guide is organized by topic and walks you through the process of creating a complete model, from the first wall to the interior design and landscaping.

This guide is available online by selecting **Help> View User's Guide** from the program menu.

---

## Online Help Videos

Another resource designed to illustrate Home Designer Architectural's tools is the set of tutorial videos available on our web site.

To view the online videos, select **Help> View Online Help Videos** from the program menu or visit [video.homedesigner.chiefarchitect.com/videos](http://video.homedesigner.chiefarchitect.com/videos).

---

## Home Designer Web Site

If you have questions that the online Help feature has not answered, feel free to turn to our web site.

A database of common technical support questions and answers related to Home

Designer Architectural is available through a searchable interface.

Select **Help> Visit Home Designer Web**

**Site**  from the menu to launch your default internet browser to [www.HomeDesignerSoftware.com](http://www.HomeDesignerSoftware.com).

---

## Online Home Designer Samples Gallery



A collection of plan sets and renderings is available for viewing and download on our web site.

Select **File> Download Sample Plans**  to [launch your internet browser to www.HomeDesignerSoftware.com](http://www.HomeDesignerSoftware.com)

---

## HomeTalk Online User Forum

The HomeTalk Bulletin Board offers several ongoing discussions about a variety of topics related to the use of Home Designer Architectural. It's rich with useful tips and available free of charge to all registered Home Designer Architectural users.

- Discussions are initiated and carried out by users.
- Experienced users share knowledge with each other and beginners.
- Home Designer Architectural Staff members post announcements, advice and technical information.

To visit the HomeTalk forum, select **Help> HomeTalk** or go to: [hometalk.chiefarchitect.com](http://hometalk.chiefarchitect.com).

---

## Technical Support

Chief Architect takes pride in offering world class technical support services that can be accessed by telephone or on our web site. Select **Help> Technical Support** from the program menu to visit: [www.HomeDesignerSoftware.com](http://www.HomeDesignerSoftware.com).

Before contacting Technical Support, take a moment to see if the answer to your question is found in the Help resources, tutorial videos, or in our online Knowledge Base at: [www.HomeDesignerSoftware.com](http://www.HomeDesignerSoftware.com).

When you contact us, Technical Support will refer you to these resources if the answer can be found there.

So that our Technical Support specialists can assist you as efficiently as possible, please refer to “Technical Support Services” on page 591 for additional trouble-shooting suggestions and information that will be needed before placing your call.



# Technical Support Services

Chief Architect is committed to providing world-class technical support to complement our products.

The primary function of technical support is to make sure our software is functioning

correctly and to help you quickly resolve problems that prevent its normal use. Our technical support professionals are eager to work with you to make certain our software is functioning as designed.

---

## Reference and Training Resources

Chief Architect offers a variety of reference options in addition to the resources that come standard with the program.

### Online Knowledge Base

The Home Designer online **Knowledge Base** contains a variety of articles describing how to resolve common technical problems and achieve specific design goals.

The Knowledge Base is found in the Technical Support section of the Web site and can be referred to again and again at your

convenience at [www.HomeDesignerSoftware.com](http://www.HomeDesignerSoftware.com).

### Online Help Videos

Chief Architect has developed a collection of training videos that contain in-depth training on a wide range of topics. These videos are available on our Web site, [www.HomeDesignerSoftware.com](http://www.HomeDesignerSoftware.com).

### User Forum

Our HomeTalk User Forum is a great place to discuss and exchange ideas with other

Home Designer Architectural users. Here you can post questions, read discussions from other users, and post suggestions to improve our product. In addition to our regular users, from time to time our support

and engineering teams monitor the forum and provide input and discussion on current topics. This resource is available free of charge at [hometalk.chiefarchitect.com](http://hometalk.chiefarchitect.com).

---

## Troubleshooting Common Technical Issues

Chief Architect strives to make certain our software works correctly; however, from time to time issues arise that prevent its normal operation.

### Installation Issues

The following are common reasons for installation failure of Home Designer Architectural and other software:

- Anti-virus software is enabled and interfering with installation. Anti-virus software is the most common cause of installation failures for any type of software. Refer to your anti-virus software's documentation for details on how to disable the software and re-enable it once installation is complete.
- The recommended minimum system requirements are not met. See "System Requirements" on page 7.
- The computer has a CD drive but not a DVD drive. A standard CD drive will not read DVD discs.

- The DVD has fingerprints, scratches, or other defects. Sometimes a small fingerprint can prevent the program from installing. Clean the disk with soft cotton cloth. Be sure to use soft cotton rather than paper products on disks to avoid scratching.

 If you see visible cracking on a CD or DVD, do not insert it in your CD/DVD drive. Cracked disks can fly apart and cause damage to your drive.

- You do not have sufficient rights to install the software. Verify that you have administrative rights and the administrative password during the installation process. If you are on a corporate network, consult your network administrator for assistance.

Refer to the online **Knowledge Base** for solutions to common installation problems. If the answer to your question is not found there, contact our Technical Support department for assistance.

---

## Troubleshooting Printing Problems

Printing problems fall into two main categories: those that prevent the printer from working in any program and problems

printing from Home Designer Architectural. To determine if the problem is specific to



Home Designer Architectural, try the following:

1. Begin by clicking on the Windows **Start** button, and select **Printers**.
2. Right-click the printer that is not functioning properly in the **Printers** folder.
3. Click **Properties** from the menu that appears.
4. On the **General** tab, click the **Print Test Page** button.

If the printer does not produce a test page, the problem is not one that Chief Architect Technical Support can solve. Follow these suggestions:

- Check the connection between the computer and the printer.
- Check your printer documentation for troubleshooting printer problems.
- Contact your printer's manufacturer or check their Web site for support information.

Your printer manufacturer is the best resource for solving problems of this type. Chief Architect Technical Support is not able to help diagnose and solve problems that prevent printing from any program.

 It is a good idea to keep the Owner's Manual for your printer close at hand. Write inside the Owner's Manual the various phone numbers for technical support for that printer – for the original manufacturer and for your local dealer.

Printers vary widely in how they function. Sometimes a faulty cable can be a problem. Often, solving a printing problem is as simple as downloading and installing an

updated printer driver. See “Printer Drivers” on page 562.

If you can print from Home Designer Architectural but are not satisfied with the output, refer to “Printing” on page 561 for information on how to set up and use the printing functions in the program. Legacy users should bear in mind that each release has new features and enhancements, so techniques that were used in prior versions may not work in the current version.

Make sure that you use **Print Preview**  before printing. Print Preview displays the printed paper, or drawing sheet, as a white rectangle on screen, and shows how the sheet is scaled and positioned relative to your drawing. If the drawing is not on the drawing sheet on-screen, it will not be on the sheet when you print. See “Print Preview” on page 565.

Make sure that your scaling is correct for the paper size. If the plan is much smaller or much larger than the drawing sheet, you may need to change your Scale. See “Printing to Scale” on page 565.

## 64 Bit Versions of Windows

Some printers may not function correctly on 64 bit Windows operating systems. If you are experiencing a printing problem while using a 64 bit version of Windows, please contact the printer's manufacturer to verify that you have the correct driver installed.

Printing to a legacy parallel printer port on a Windows 64 bit machine may not work correctly when using a hardware lock. USB printers should not be affected.

## Clearing Printer Information

Some information specific to individual printers, such as available printer paper sizes, is saved with each plan file.

If you are encountering problems when printing, or unexpected options in the **Page Setup** dialog, select **File> Print> Clear Printer Info** to clear the printer-specific information stored with the plan file.

After using **Clear Printer Info**, select **File> Print> Page Setup** . Make sure the

settings in the **Page Setup** dialog are correct, and then click OK and **Save**  the file.

## Online Knowledge Base

For answers to frequently asked questions regarding printing and other topics, select **Help> Visit Home Designer Architectural**

**Web Site**  and browse the Technical Support section of our Web site, [www.HomeDesignerSoftware.com](http://www.HomeDesignerSoftware.com).

Our Technical Support specialists post new articles periodically to help resolve problems that you may encounter.

---

## Error Messages

Most common error messages have a known cause and simple resolution. When you encounter an error or warning message in Home Designer Architectural, you can click the **Check Knowledge Base** button in the message box to launch your default internet browser to the Home Designer Knowledge Base on our Web site, [www.HomeDesignerSoftware.com](http://www.HomeDesignerSoftware.com).

If an article discussing the message is available it will display, providing information about the message and how best to avoid it.

It is important that abnormal errors be reported to Chief Architect Technical Support so that we can identify and resolve any problems.

The content of an error message is useful in diagnosing its cause. If you encounter an error message, read it carefully and write

down the error number and the exact text of the error message.



Press the Print Screen key on your keyboard to capture a picture of the error message. Open a new word processing document or e-mail message and choose Edit> Paste to paste a copy of the error message into the document for later reference.

If you encounter the error more than once, make a note of your steps prior to receiving the message.

Before you report an error, check the Knowledge Base to see if the error is already documented by typing the error message or part of the error message into the search form.

Finally, check to see if there are program updates available. These updates are provided free for the current version of Home Designer Architectural and contain

enhancements and other changes that allow the program to perform at an optimum level. Select **Help> Download Program Updates** from the Home Designer Architectural menu and follow the instructions on our Web site, [www.HomeDesignerSoftware.com](http://www.HomeDesignerSoftware.com).

## Error Reporting

When an error occurs, you may have the option in the message box to send the report to Chief Architect.

No personal information is sent. When you click **Send**, your default internet browser launches and a Web page appears on screen. This message confirms that the report was sent successfully and may give you further instructions on how to proceed.

---

## Contacting Technical Support

Before contacting Technical Support, take a moment to see if the answer to your question is found in the Reference Manual, Help index, or in our online Knowledge Base. When you contact us, Technical Support will refer you to these resources if the answer can be found there.

Chief Architect's world-class technical support is available Monday through Friday from 6 AM to 5 PM Pacific Standard Time and can be reached at (208) 292-3375 or via our Web site, [www.HomeDesignerSoftware.com](http://www.HomeDesignerSoftware.com).

There are several things you can do to ensure a speedy answer to your question when you contact Technical Support.

- Before contacting Technical Support, select **Help> About Home Designer Architectural** and make a note of the first characters of your Product Key and the exact version of Home Designer Architectural you are using. Technical support is available to the owners of software licenses. When you contact Technical Support, be prepared to verify that you are the owner of the software license.
- Before contacting Technical Support, check to see if there are program updates available for download. Our engineering team periodically creates updates to the program to resolve functionality or program issues that were unknown at the time of release. These updates are provided free of charge for the current released version and can be accessed by selecting **Help> Download Program Updates** from the menu.
- When you first encounter a problem or error message, copy the exact wording of the message or a detailed description of the problem. This helps us isolate the problem and provide you with a solution as quickly as possible.
- When placing a call to Technical Support, be at the computer or work station that is experiencing the problem and have Home Designer Architectural running. If you do not have access to the problem computer at the time of the call, the technician may be unable to reproduce the issue and/or

suggest a remedy that can be implemented and verified immediately.

- Be prepared to reproduce the problem when you contact us. If the problem cannot be reproduced, there is a reduced chance that we will be able to resolve the problem on your first phone call.

## Online Information

Home Designer Architectural has a variety of support resources available on our Web site.

These include our **Technical Support Knowledge Base**, the **How do I...? Solution Finder**, downloadable program

updates, and ways to contact our Technical Support department. To access these resources, visit:

[www.HomeDesignerSoftware.com](http://www.HomeDesignerSoftware.com).

Our support team is happy to assist you in finding the best resource to answer your questions, and can resolve most issues in just a few minutes. In order to allow us to quickly answer your calls, we ask that you limit yourself to one question per support call.

## Online Support

Questions can be answered online by the Technical Support department. To submit a technical inquiry online, visit the Technical Support section of our Web site and use the [Online Support Center](#).

This route ensures that your question is delivered to the first available support professional. Requesting assistance of an individual specialist is not recommended, since that person may not be available to answer your question in a timely manner.

## Telephone Support

Our Technical Support team is committed to answering your questions as quickly as possible and in the order received. Your call is important to us; however, there are times when we get more calls than expected and you may have to wait a few minutes before speaking to a technician.

---

## Program Paths Dialog

Some technical issues can be caused by problems with support files used by Home Designer Architectural. In the event of such an issue, Chief Architect Technical Support may direct you to the **Program Paths** dialog. This dialog displays a list of files utilized by the software along with the pathname of each.

To avoid unintended problems that could prevent you from using the software, it is strongly recommended that you make no changes to any of the files in this list except with the direct assistance of Technical Support.

# Index

## Numerics

<b>3D</b>	
Data Import.....	554
Delete Surface.....	455
Mice.....	25
Symbols, Importing.....	556
<b>3D Roof Designer</b> .....	248
<b>3D Views</b>	
Display.....	453
Doll House.....	451
Editing.....	464
Framing Overview.....	452
Full Overview.....	451
Generation, Speed up.....	482
Overviews.....	450
Save.....	466
Working in.....	464
<b>3D Wall Designer</b> .....	130

## A

<b>Added Lights</b> .....	472
<b>Adding</b>	
to the Library.....	402
<b>Adjust</b>	
Material Definition.....	424
<b>Adjust Lights Dialog</b> .....	474
<b>Alcove Roofs</b> .....	250
<b>Align</b>	
Curved Stairs Between Floors.....	112
Curved Walls Between Floors.....	139
Objects.....	110
Pony Walls Between Floors.....	140
Stem Walls and Footings.....	232
Text.....	505

Walls.....	138
<b>Alpha Channel</b> .....	434
<b>Alphabets</b>	
International.....	498
Unicode.....	498
<b>Angle Snaps</b> .....	81
<b>Angle Style</b>	
Dialog.....	69
<b>Angled Front Cabinets</b> .....	321
<b>Appearance Preferences</b> .....	62
<b>Appliances</b>	
Built into cabinets.....	312
<b>Arc</b>	
Panel.....	516
Specification Dialog.....	515
<b>Architectural Block</b>	
Specification Dialog.....	390
<b>Architectural Blocks</b>	
Displaying.....	389
Edit Sub-Objects.....	390
Explode.....	390
Sub-objects.....	391
<b>Archive Files</b> .....	49
<b>Area</b>	
Living Area calculation.....	164
of a Polyline.....	518
of Rooms.....	166
<b>Arrow</b>	
Auto Positioning.....	507
Panel.....	515
Text Line With.....	507
<b>Artwork</b>	
Creating textures.....	426
<b>Attenuation</b> .....	299
<b>Attic</b>	
Floor.....	225

Rooms .....	164
Walls .....	141
<b>Auto</b>	
Archive .....	49
Dormers, Editing .....	255
Floating Dormer .....	254
Interior Dimensions .....	489
Place Corner Boards .....	302
Place Outlets .....	165, 291
Place Quoins .....	304
Roof Returns.....	257
Save Files.....	49
Stairwell.....	275
<b>Auto Rebuild</b>	
Foundation.....	231
Roofs.....	245
<b>Automatic</b>	
Exterior Dimensions .....	489

## B

<b>Backdrops</b> .....	542
Definition .....	542
<b>Background Color</b> .....	63
<b>Backsplash</b>	
Custom.....	315
<b>Backsplash Layer Definition</b> .....	331
<b>Backup</b>	
Entire Plan.....	54
Files .....	48
<b>Balusters</b> .....	155
Definition .....	260
<b>Base</b>	
Cabinets.....	311
<b>Basements</b>	
Daylight .....	234
Walkout .....	234
<b>Bay Windows</b> .....	199
<b>Bay/Box Window</b>	
Specification Dialog.....	216
<b>Beams</b>	
Roof, exposed.....	380
<b>Blend Colors with Materials</b> .....	418

<b>Blind Cabinets</b> .....	321
<b>Bonus</b>	
Library Catalogs .....	399
Rooms .....	225
<b>Bow</b>	
Window Specification.....	216
<b>Bow Windows</b> .....	199
<b>Box</b>	
Windows .....	199
<b>Break</b>	
Line .....	113
Line, complete.....	114
Line, partial .....	113
Wall .....	129
<b>Build</b>	
Foundation .....	222, 229
House .....	524
New Floor .....	221
Roof Dialog .....	245
Terrain .....	344
<b>Bumping/Pushing</b> .....	109

## C

<b>Cabinet</b>	
Defaults .....	310
Designer .....	309
Modules Library.....	312
Specification Dialog.....	321
Tools .....	310
<b>Cabinets</b>	
Angled front .....	319
Backsplash.....	323
Base .....	311
Blind .....	321
Built-in appliances .....	312
Corner .....	319
Countertop, custom .....	311, 315
Countertops .....	314
Delete face items.....	325
Door/drawer style .....	312
Doors, diagonal .....	323
Doors, glass .....	326
Editing .....	317

End cabinets.....	319	Specification Dialog.....	467
Fillers.....	313	Tilt Tools.....	460
Front Indicators.....	316	<b>Casing</b>	
Front Panel.....	324	Door.....	192
Full Height.....	311	<b>Cathedral Ceilings</b> .....	170
General Defaults.....	310	<b>Ceiling</b>	
Glass doors.....	326	Break Lines.....	171
Island.....	321	Heights.....	168
Lazy Susan.....	323	<b>Ceilings</b>	
Minimum Width.....	310	Cathedral.....	170
Module Lines.....	316	Coffered.....	172
Moving, with Wall.....	318	Lowered.....	170
Normal.....	319	Over this room.....	175
Peninsula radius.....	319	Special.....	170
Radius end.....	319	Tray.....	171
Resize Increment.....	310	<b>Center</b>	
Reverse Appliance.....	325	Doors.....	184
Shaped.....	319	Object edit tool.....	111
Special shapes.....	319, 322	Sheet.....	565
Wall.....	311	Text.....	505
<b>CAD</b>		<b>Change</b>	
Angle Snaps.....	81	Door Swings.....	185
Circles.....	512	Floor/Reference.....	225–226
Drawing Tools.....	511	Line to arc.....	265
Ellipses.....	512	Wall Types for Pony Walls.....	127
Move to Front of Group.....	108	<b>Chimneys</b> .....	241
Ovals.....	512	<b>Circle</b>	
Polyline.....	512	Specification Dialog.....	517
Polylines.....	518	<b>Circles</b> .....	512
Rectangle.....	512	Ovals.....	512
<b>CAD Box</b>		<b>Click Stairs</b> .....	260
Specification Dialog.....	520	<b>Close</b>	
<b>CAD Objects</b>		Plans and Views.....	54
Displaying.....	522	Program.....	55
<b>Calculate</b>		Views.....	446
From All Floors.....	580	<b>Color</b>	
From Room.....	580	Off/On.....	107
Loan.....	528	<b>Color Chooser</b>	
Materials on soffits.....	382	Eyedropper.....	439
<b>Camera</b>		<b>Colors</b>	
Activating.....	466	Selecting.....	438
Change Settings.....	467	<b>Compatibility</b>	
Create Views.....	450	with other programs.....	42
Field of View.....	463	<b>Connect</b>	
Move Tools.....	459		
Move Up/Down One Floor.....	462		
Orbit Tools.....	459		

Electrical.....	292
Walls.....	131
<b>Contextual Menus.....</b>	<b>62</b>
In Render views.....	462
<b>Copy</b>	
Folders and Library Objects.....	404
Region as Picture.....	541
<b>Copy/Paste</b>	
Main Edit Mode.....	85
Sticky Mode.....	85
<b>Corner</b>	
Boards.....	302
Windows.....	200
<b>Corner Board</b>	
Specification Dialog.....	303
<b>Countertops</b>	
Custom.....	311, 314
Edge Profiles.....	315
Edit Custom.....	315
Holes in.....	312
<b>Create</b>	
New Plan Dialog.....	44
Plant Image.....	369
<b>Cross Hairs.....</b>	<b>66</b>
Mouse.....	110
Turn On/Off.....	66
<b>Cross Section Slider.....</b>	<b>463</b>
<b>Cross Section/Elevations</b>	
Detailing.....	453
<b>Crown Molding</b>	
Cabinets.....	319
<b>Current</b>	
Floor.....	224
Floor, Delete.....	223
<b>Curved</b>	
Deck Edge.....	124
Deck Railing.....	124
Stairs.....	260
Walls, Draw.....	131
<b>Custom</b>	
Backsplash.....	315
Counterholes.....	312
Countertops.....	311, 314
Countertops, Editing.....	315

<b>Custom Countertop</b>	
Specification Dialog.....	329
<b>Custom Light Intensity Dialog.....</b>	<b>299</b>

## D

<b>Deck.....</b>	<b>167</b>
Designer.....	124
Edges.....	124
Framing.....	168, 176
Planking.....	176
Railing.....	124
Roof Over.....	168
<b>Decks.....</b>	<b>167</b>
<b>Default</b>	
Lights.....	472
<b>Default Sun Light</b>	
Specification Dialog.....	477
<b>Defaults</b>	
Cabinet.....	310
Defined.....	58
Dimension.....	485
Door.....	179
Dormer.....	244
Dynamic.....	59
Floor.....	160, 220
Foundation.....	228
General Plan.....	60
Material.....	416
Reset.....	59
Roofs.....	244
Room.....	160
Settings.....	58
Structural Member Reporting.....	581
Wall.....	120
Window.....	198
<b>Define Material Dialog.....</b>	<b>429</b>
<b>Delete</b>	
3D Surface.....	455
Built-in Fixtures and Appliances.....	411
Current Floor.....	223
Floors.....	223
Foundation.....	232
Gable Over Opening.....	250
Library Content.....	405



Objects.....	116	Tools .....	180
Roof Planes .....	245, 248	<b>Doors</b>	
Wall Hatching .....	129	Arched.....	192
<b>Details</b>		Bifold Doors .....	181, 186
Cross section/elevations.....	453	Casing .....	192
<b>Dimension</b>		Center .....	184
Defaults.....	485	Change Opening/Hinge Side.....	185
Tab .....	496	Change Swing Side .....	186
Tools.....	488	Doorways.....	180
<b>Dimension Defaults</b> .....	485	Frame.....	192
Dialog.....	485	Gables Over.....	248
<b>Dimension Line</b>		Garage .....	181
Specification Dialog .....	496	Garage, opening direction.....	187
<b>Dimensions</b>		Handles .....	193
Auto Interior.....	489	Hardware.....	193
Editing.....	491	Hinged Doors .....	180, 185
End to end.....	489	Hinges .....	193
Exterior .....	489	Ignore Casing when Resizing.....	61
Interior .....	489	Labels .....	183
Locating railings.....	148	Library .....	181, 189
Move Objects Using .....	494	Lites .....	192
Moving Labels .....	492	Locks.....	193
Number Height.....	496	Openings in railings.....	187
Tape Measure.....	490	Pocket Doors .....	181, 186
Temporary .....	490	Rough opening.....	189
Zeroes in .....	488	Size .....	189
<b>Display</b>		Sliding Doors .....	186
3D Views .....	453	Style.....	189
CAD Objects.....	522	Swing, change .....	185
Drawing Groups.....	107	Threshold lines.....	182
Electrical .....	293	Transoms.....	187
Foundations.....	230	Type.....	189
Images .....	531	Wrapped Openings.....	187
Objects.....	76	<b>Doorways</b>	
Pony Walls in Floor Plan View .....	126	Adding a Door .....	182
Roof Planes .....	247	with Railing .....	188
Room labels .....	166	<b>Dormer</b>	
Terrain .....	343	Defaults .....	244
Walls, Railings, and Fences.....	132	Specification Dialog.....	256
<b>Display Options Dialog</b> .....	77	<b>Dormers</b> .....	254
<b>Distributed Object Tab</b> .....	350	Gable Over Door/Window .....	248
<b>Doll House View</b> .....	451	Manually drawn.....	255
<b>Door</b>		Windows in .....	255
Defaults.....	179	<b>Draw</b>	
Specification Dialog .....	189	Curved Railing .....	131
		Curved wall.....	131

**Drawing Groups** ..... 107  
**Drawing Sheet**  
 Center ..... 565  
**Driveway Tools** ..... 361  
**Driveways** ..... 362  
**DXF**  
 File Format ..... 552  
**Dynamic**  
 Defaults ..... 35, 59  
 Print Preview ..... 565

## E

**Edit**  
 Handles ..... 26  
 Preferences ..... 66  
 Toolbar ..... 28  
**Edit Area** ..... 90  
**Electrical**  
 Auto Place Outlets ..... 291  
 Connections ..... 292  
 Deleting ..... 295  
 Displaying ..... 293  
 Editing Objects ..... 294  
 General ..... 289  
 Labels ..... 293  
 Library ..... 293  
 Lights ..... 290  
 Outlets ..... 290  
 Switches ..... 290  
 Tools ..... 290  
 Wiring ..... 292  
**Electrical Service**  
 Specification Dialog ..... 295  
**Elevation**  
 Data Tools ..... 335  
 Points ..... 335  
 Regions ..... 337  
 Tab ..... 348  
**Elevation Data**  
 Tools ..... 335  
**Elevation Line**

Specification Dialog ..... 348  
**Elevation Point**  
 Specification Dialog ..... 347  
**Elevation Region**  
 Specification Dialog ..... 348  
**Elevation Views** ..... 452  
**Ellipse** ..... 512  
 Specification Dialog ..... 517  
**End**  
 Cabinets ..... 320  
 To-End Dimensions ..... 489  
**Enhanced Metafiles** ..... 537  
**Error Messages** ..... 594  
**Estimating Software** ..... 585  
**Exit Program** ..... 55  
**Expand/Collapse All** ..... 397  
**Explode**  
 Architectural Blocks ..... 390  
**Export**  
 2D Drawings ..... 552  
 All Floors ..... 553  
 Current View ..... 552  
 Drawing File Dialog ..... 553  
 EMF ..... 537  
 From the Library ..... 406  
 Materials List ..... 585  
 Picture Files ..... 536  
 Windows Metafiles ..... 537  
 Windows Metafiles Dialog ..... 537  
 WMF ..... 537  
**Extend**  
 Slope Downward ..... 140  
**Extension Lines**  
 Adding ..... 493  
 Deleting ..... 494  
 Editing ..... 493  
**Extension Snaps** ..... 81  
**Exterior**  
 Dimensions ..... 489  
 Room types ..... 164  
 The Exterior Room ..... 161  
 Walls ..... 125

# F

<b>F6 Key</b>	
Fill Window .....	443
<b>Faster Rendering</b> .....	482
<b>Fence Designer</b> .....	125
<b>Field of View</b> .....	463
<b>File</b>	
Backing Up Your Files .....	48
Create New .....	44
Management.....	41
Open .....	50
Organization .....	43
<b>Fill</b>	
Patterns.....	519
Window .....	443
Window Building Only.....	443
<b>Fill Style Panel</b> .....	519
<b>Filter</b>	
Library Search .....	398
<b>Final View</b> .....	471
with Shadows .....	471
<b>Fire Box Panel</b> .....	240
<b>Fireplace</b>	
Direction facing .....	238
Interior wall.....	238
Library .....	240
Masonry .....	237
Prefabricated .....	240
Specification Dialog .....	239
Symbol .....	240
<b>Fireplaces</b> .....	237
Chimneys .....	241
Foundations.....	238
Freestanding.....	238
In walls.....	237
Types .....	237
<b>Fix</b>	
Wall Connections .....	131
<b>Fixtures</b>	
Lights .....	290
<b>Flare/Curve Stairs</b> .....	269
<b>Floating Auto Dormer</b> .....	254
<b>Floor</b>	
3D Overview .....	450
Build New Floor.....	221
Camera.....	450
Defaults .....	160, 220
Heights .....	168
Overview .....	450
Tools .....	220
<b>Floor Plan</b>	
Drawing .....	35
View .....	36
<b>Floors</b>	
Adding .....	221
Attic.....	225
Change Floor/Reference.....	225–226
Current Floor.....	224
Deleting .....	223
Exchange With Floor Above .....	222
Exchange With Floor Below .....	222
Floor Up/ Floor Down .....	224
Maximum number.....	221
Reference Floor .....	225
Swap Floor/Reference .....	226
<b>Folders Preferences</b> .....	65
<b>Fonts</b> .....	498
and Alphabets .....	498
Blueprint .....	498
<b>Footings</b> .....	228
Alignment .....	232
Size.....	150
Stem wall.....	232
<b>Foundation</b>	
Auto Rebuild .....	231
Defaults .....	228
Panel.....	149
Thickness .....	150
Walls .....	126
<b>Foundations</b>	
Alignment .....	232
Build.....	229
Daylight Basement .....	234
Delete.....	232
Display .....	230
Footing size .....	150
Garage .....	233
Mixed Types .....	229

Room supplies floor.....	175
Slab Tools .....	235
Stem Wall .....	228
Stepped .....	234
Walkout Basement .....	234
<b>Framing</b>	
3D Overview .....	452
Deck .....	168, 176
Layer .....	142
Structural Member Reporting .....	581
Stud Spacing .....	431
<b>Full</b>	
Height Cabinets .....	311
Overview .....	450–451

## G

<b>Gable</b>	
Gable/Roof Line Tool.....	248
Over Door/Window .....	248
<b>Garage</b>	
Door Tool.....	181
<b>Garages</b>	
Foundation.....	233
<b>Garden Bed</b>	
Kidney Shaped.....	341
Polyline.....	341
Round.....	341
Tools .....	340
<b>General</b>	
Cabinet Defaults.....	310
Preferences .....	64
<b>Getting Help</b> .....	37
<b>GFCI Outlet</b> .....	290
<b>Glass, Stained</b> .....	201
<b>GPS</b>	
Importing .....	357
<b>Grid</b>	
Snaps .....	61, 81
<b>Ground Fault Circuit Interrupt</b> .....	290

## H

<b>Half</b>	
Walls .....	155
<b>Half-Walls</b> .....	123
<b>Hardiness Zone Maps</b> .....	369
<b>Hardware</b>	
for Doors.....	193
<b>Hatch</b>	
Fill Patterns.....	519
Wall .....	129
<b>Height</b>	
Railings.....	156
<b>Help</b>	
Tool Tips.....	37
<b>Hill / Valley</b>	
Specification Dialog .....	349
<b>Hill/Valley</b> .....	339
<b>Holes</b>	
In terrain .....	340
<b>Home Designer</b>	
Product Key .....	38
Version Number.....	38
<b>Hotkeys</b> .....	28, 73
Create List .....	73
<b>House Wizard</b>	
Editing Rooms .....	524
Multiple Floors.....	525
Placing Rooms .....	524

## I

<b>Image</b>	
Specification Dialog .....	532
<b>Images</b> .....	471
Adding to Library .....	531
Creating .....	531
Displaying .....	531
Editing .....	532
Place .....	530
Printing .....	570
Transparency Color .....	535

<b>Import</b>	
3D Data .....	554
3D Symbols .....	556
GPS Data .....	357
PDF .....	539
Terrain Assistant .....	355
Terrain Data .....	355
<b>Interior</b>	
Dimension Tool .....	489
Dimensions, Auto .....	489
Fireplace, wall .....	238
Room types .....	164
<b>Invisible Walls</b> .....	127

## K

<b>Key Frames</b> .....	544
<b>Keyboard</b>	
Commands .....	28, 73, 397
<b>Kidney Shaped</b>	
Garden Bed .....	341
Pond .....	341
Terrain Features .....	340
<b>Kitchen Island</b> .....	321
<b>Knee Walls</b> .....	142, 149

## L

<b>Label Panel</b> .....	576
<b>Labels</b>	
Displaying .....	575
Door .....	183
Electrical .....	293
Plant .....	372
Roof Plane .....	247
Room .....	166
Window .....	203
<b>Landing</b> .....	266
Unlocked .....	267
<b>Landings</b>	
Custom Shapes .....	267
Height .....	267
Locked .....	268

<b>Landscape Designer</b> .....	333
<b>Layer</b>	
Layer Sets .....	76
<b>Layers</b>	
Primary and Secondary .....	76
Turn off to speed up 3D views .....	482
<b>Left Mouse Button</b>	
Definition .....	25
<b>Library</b>	
Adding Folders .....	403
Bonus Catalogs .....	399
Content .....	398
Deleting Content .....	405
Export .....	406
Manufacturer Libraries .....	399
Renaming Libraries .....	404
Search .....	397
Shortcuts .....	405
Trash .....	405
<b>Library Browser</b> .....	394
Adding Items .....	402
Docking .....	397
Panels .....	394
Preferences .....	64
<b>Library Object</b>	
Specification Dialog .....	411
<b>Library Objects</b>	
Editing .....	410
Placing .....	406
<b>Light</b>	
Specification Dialog .....	476
<b>Light Sources</b> .....	472
Added Lights .....	472
Default Lights .....	472
Default Sun Light .....	473
Fixtures .....	472
Parallel Lights .....	475
Point Lights .....	475
Spot Lights .....	476
<b>Lights</b>	
Added .....	472
Adjust .....	474
Attenuation .....	299
Casts Shadows .....	298
Color .....	298

Custom Intensity .....	299
Cut Off Angle .....	298
Direction .....	298
Drop Off Rate.....	298
Fixtures .....	290, 472
Intensity.....	297
Light Data Tab .....	297
Show Position in 3D .....	298
Turn On/Off.....	473
Types of sources.....	475
<b>Line</b>	
Color .....	514
Panel.....	513
Specification Dialog.....	513
<b>Line Style</b> .....	514
Panel.....	514
<b>Lites</b>	
Craftsman.....	208
Diamond.....	208
Doors .....	192
Normal.....	208
Prairie.....	208
<b>Living Area</b> .....	167
and Room Types .....	164
Calculation.....	167
Delete label.....	167
Label .....	167
Restore label.....	167
Show .....	61
vs. Footprint.....	167
<b>Loan Calculator</b> .....	528

## M

<b>Main</b>	
Edit Mode .....	85
Layer .....	142
<b>Make</b>	
Parallel/Perpendicular .....	111
<b>Manual</b>	
Dimensions .....	489
<b>Manufacturer Libraries</b> .....	399
<b>Marquee Select</b> .....	89
<b>Masonry</b>	

Fireplace.....	237
<b>Material</b>	
Defaults .....	416
Eyedropper .....	420
<b>Material Painter</b> .....	417
and Walls .....	419
Blending.....	418
Modes.....	418
Using .....	419
<b>Materials</b>	
Add to Library.....	402
Artwork .....	426
Blending.....	424
Calculating amounts .....	382
Creating .....	424
Define Material Dialog.....	429
Editing .....	423
Mapping.....	425
On Soffits.....	382
Panel .....	420
Patterns .....	432
Render properties.....	436
Stained glass .....	201
Textures.....	434, 471
Types.....	427
Walls .....	133
<b>Materials List</b> .....	579
Calculate from All Floors.....	580
Calculate from Room .....	580
Conditioned Areas .....	585
Display Options Dialog.....	583
Editing .....	584
Estimating software .....	585
Export.....	585
<b>Menus</b> .....	29
<b>Message Boxes</b>	
Reset.....	33
<b>message URL http</b>	
//www.homedesignersoftware.com/ useraccess/content.html.....	400
<b>Metafile Size Dialog</b> .....	537
<b>Metafiles</b> .....	537
<b>Middle Mouse Button</b> .....	25, 442
<b>Minimum</b>	
Alcove.....	246

<b>Model Maker</b>	
Printing.....	571
Wall Layout Template.....	573
<b>Molding</b>	
in Rooms .....	177
<b>Moldings Panel</b> .....	306
<b>Moldings Tab</b>	
for Rooms.....	177
<b>Monolithic Slab</b> .....	228
<b>Mouse</b>	
3D .....	25
Pointer Icons .....	26
<b>Mouse Buttons</b>	
Using.....	25
<b>Move</b>	
Along Rails .....	137
Folders and Library Objects .....	404
Nudging.....	110
Object Using Dimensions .....	494
Objects.....	109
Restrictions .....	109
to Front of Group .....	108
Walls with Cabinets Attached.....	318
<b>Mulled Unit</b>	
Specification Dialog .....	205
<b>Mulled Units</b>	
Labels .....	576
<b>Mullions</b>	
Window .....	208
<b>Multiple</b>	
Select.....	89
<b>Muntins</b>	
Window .....	208

## N

<b>Newels</b>	
Definition .....	260
<b>Newels/Balusters Tab</b> .....	156
<b>No Locate Wall</b> .....	148
<b>Nudging</b> .....	110

## O

<b>Object</b>	
Based Design.....	23
<b>Object Snaps</b> .....	80
Extension Snaps .....	81
<b>One-Click Auto Dimension</b> .....	489
<b>One-Click Stairs</b> .....	260
<b>Open</b>	
Below .....	164
Object.....	32
Plan Files.....	50
View .....	466
<b>OpenGL</b> .....	448
<b>Organizing</b>	
your Files.....	43
<b>Orthogonal Views</b> .....	565
<b>Outlets</b> .....	290
Above cabinet .....	290
Automatic .....	291
Dishwasher .....	290
GFCI .....	290
Manually placed .....	290
Place .....	291
Sink.....	290
WP .....	290
<b>Oval</b> .....	512
Specification Dialog.....	517
<b>Overview</b> .....	21
Full.....	451

## P

<b>Page Setup Dialog</b> .....	563
<b>Painting</b>	
Over Materials.....	424
<b>Pan</b>	
Pan Window Tool .....	444
the Display .....	443
Using the Keyboard .....	444
Using the Mouse .....	444
Using the Scroll Bars .....	444
<b>Paragraph Options Dialog</b> .....	502

<b>Parallel Light</b> .....	475	Chooser Dialog.....	367
<b>Partition Tool</b> .....	311	Encyclopedia.....	367
<b>Pass-Through</b> .....	199	Labels.....	372
<b>Paste</b> .....	84	Tools.....	366
Hold Position.....	85	<b>Plant Image</b>	
in Place.....	85	Create.....	369
Special.....	85	Specification Dialog.....	369
<b>Pattern Panel</b> .....	432	<b>Point</b>	
<b>Patterns</b>		Light.....	475
Mapping.....	425	<b>Pointer</b>	
<b>Patterns and Textures</b> .....	425	Cross Hairs.....	66
<b>PDF</b> .....	538	<b>Polygon</b>	
Importing.....	539	Shaped Deck.....	124
Print to.....	567	<b>Polyline</b>	
<b>Peninsula Radius Cabinets</b> .....	320	Area.....	518
<b>Picture</b>		Definition.....	518
Copy Region as.....	541	Garden Bed.....	341
<b>Picture File Box</b>		Panel.....	518
Specification Dialog.....	537	Specification Dialog.....	518
<b>Picture Files</b>		<b>Ponds</b> .....	341
Export.....	536	Round.....	341
Import.....	536	<b>Pony Walls</b> .....	126
Scale.....	540	Align upper and lower.....	121
<b>Pitch</b>		Change wall types.....	127
Above Wall.....	140	Default height.....	121
<b>Place</b>		Display.....	126
Gable Over Window(s).....	201	Display Openings in.....	122
Images.....	530	Show lower wall.....	122
Library Objects.....	406	<b>Preferences</b>	
Outlets.....	165, 291	Appearance Panel.....	62
<b>Plan</b>		Colors Panel.....	63
Create New.....	44	Definition of.....	58
Drawing.....	35	Dialog.....	61
Files, Opening.....	50	Edit Panel.....	66
General Defaults.....	60	Folders Panel.....	65
Saving.....	45	General Panel.....	64
View.....	36	Global settings.....	61
<b>Plan Check</b> .....	526	Library Browser Panel.....	64
and room labels.....	165	Render Panel.....	66
Dialog.....	527	Reset preferences.....	69
Hold.....	527	<b>Print</b> .....	561
Restart.....	527	3D Views.....	566
<b>Plant</b>		Across Multiple Pages.....	566
2D Symbols.....	370	Center Sheet.....	565
		Clear Printer Info.....	563, 594
		Dialog.....	567



Drawing Scale .....	562
Drivers .....	562
Model .....	571
Options.....	563
Paper Size.....	562
Perspective Views.....	566
Preview .....	565
Printable Area.....	565
Scale to Fit .....	566
Terminology.....	562
Tiled.....	566
to PDF File .....	567
To Scale.....	565
Troubleshooting .....	592
<b>Print Image</b> .....	467
Dialog.....	570
<b>Print Model</b>	
Wall Layout Template.....	573
<b>Printers</b>	
Select Printer.....	568, 572

## Q

<b>Quoin</b>	
Specification Dialog .....	304
<b>Quoins</b> .....	303

## R

<b>Radius</b>	
End Cabinets .....	320
<b>Rail Style Tab</b> .....	154
<b>Railings</b> .....	123
Balusters .....	155
Bottom Rail.....	155
Decks.....	124
for Stairs .....	281
Glass.....	124
Half Walls .....	123
in a Doorway.....	188
Locate with dimensions .....	148
Middle Rail .....	155
Newels .....	156

No Rail .....	155
Open .....	155
Openings .....	187
Solid.....	155
Stairs.....	274
Type .....	155

<b>Raised / Lowered Region</b>	
Specification Dialog.....	349

<b>Ramp</b>	
Specification Dialog.....	283

<b>Rebuild</b> .....	245
3D .....	465
Roofs.....	245

<b>Rectangular Polyline</b> .....	512
-----------------------------------	-----

<b>Redo</b> .....	118
-------------------	-----

<b>Reference</b>	
Display Options.....	226
Grid.....	61

<b>Remove</b>	
Backdrop .....	449

<b>Render</b>	
Added Lights.....	472
Graphics card .....	448
Light Sources.....	472
Preferences .....	66
Status.....	68
Tips.....	470

<b>Rendering Techniques</b> .....	478
Defaults .....	479
Options.....	479

<b>Replace from Library</b>	
Button.....	408
Dialog.....	408

<b>Reset</b>	
Defaults .....	59
Message Boxes.....	33
Preferences .....	69

<b>Reshape objects</b> .....	113
------------------------------	-----

<b>Resize</b>	
House using Dimensions .....	495
Objects .....	112

<b>Restrictions</b>	
Moving objects .....	109

<b>Retaining Wall</b> .....	343
-----------------------------	-----

**Reverse**  
 Plan..... 115

**Rich Text**  
 Defaults ..... 498  
 Specification Dialog..... 500  
 Text Color..... 501

**Right Button Definition**..... 25

**Road**  
 Specification Dialog..... 363

**Road Objects**  
 Different Types..... 361

**Roads**  
 Displaying..... 363

**Roof**..... 243  
 Extend Slope Downward..... 149  
 Full Gable Wall..... 149  
 Over this room ..... 175  
 Panel..... 148  
 Pitches in Degrees ..... 258  
 Second pitch ..... 149  
 Styles, Automatic ..... 245  
 Tools ..... 244

**Roof Beams**..... 380

**Roof Designer**..... 244

**Roof Hole/Skylight**  
 Specification Dialog..... 252

**Roof Plane**  
 Labels ..... 247

**Roof Planes**  
 Delete..... 248  
 Display ..... 247

**Roofs**..... 243, 245  
 Auto Rebuild ..... 245–246  
 Auto Roof Return ..... 149  
 Build Roof Dialog ..... 245  
 Defaults ..... 244  
 Dormers..... 254  
 Hole for skylights..... 251  
 Knee walls ..... 142  
 Min. Alcove ..... 246  
 Over Alcoves ..... 250  
 Overhang..... 247  
 Pitch ..... 140  
 Returns..... 257  
 Skylights..... 251

Story-and-a-half ..... 142

**Room**  
 Defaults ..... 160  
 Specification Dialog ..... 172

**Room Labels**..... 166  
 Display..... 166  
 Edit..... 166  
 Interior room area..... 166  
 Interior room dimensions..... 166  
 Room area ..... 166  
 Standard room area ..... 166

**Rooms**  
 Area..... 166  
 Attic ..... 164  
 Auto Place Outlets..... 165  
 Below Stairs ..... 276  
 Ceiling over ..... 175  
 Editing ..... 163  
 Exterior types ..... 164  
 Foundation floor definition..... 175  
 Interior ..... 164  
 Interior area ..... 166  
 Interior dimensions ..... 166  
 Living Area..... 164  
 Name for PlanCheck..... 527  
 Open Below ..... 164  
 Roof over ..... 175  
 Room Definition..... 160  
 Room Types..... 164  
 Selecting..... 161  
 Standard area ..... 166  
 The Exterior Room..... 161  
 Types..... 164

**Rotate objects**..... 114

**Round**  
 Garden bed ..... 341  
 Pond..... 341

## S

**Sample Plans**  
 Download..... 588

**Save**  
 3D Views..... 466  
 and Save As..... 45

Plan .....	45	<b>Side Windows</b> .....	27
Thumbnail Image .....	48	<b>Sidewalk</b> .....	362
<b>Scale</b>		<b>SidewalkTools</b> .....	361
Picture Files .....	540	<b>Skylights</b> .....	245, 251
Printing to .....	565	<b>Slab</b>	
Terrain Data .....	357	Specification Dialog .....	235
Text Size .....	505	<b>Slabs</b>	
to Fit .....	566	Interior Footings .....	231
<b>Schedule</b>		Slab Tool .....	235
Specification Dialog .....	375	Tools .....	235
<b>Schematics, Wiring</b> .....	292	<b>Sliding Doors</b> .....	181
<b>Scroll Bars</b> .....	444	<b>Sloped Soffits</b> .....	384
<b>Seat</b>		<b>Snap Behaviors</b> .....	80
in Bay Window .....	214	Angle Snaps .....	81
<b>Select</b>		Extension Snaps .....	81
Backdrop .....	449	Grid Snaps .....	61, 81
Components of Blocked Units .....	202	Object Snaps .....	80
Ctrl+Click .....	89	<b>Soffit</b>	
Library Object Dialog .....	408	Defaults .....	379
Marquee .....	89	Specification Dialog .....	382
Material Dialog .....	422	<b>Soffits</b> .....	311, 379
Multiple Objects .....	89	Calculating Materials .....	382
Next Object .....	89	Corner .....	380
Objects button .....	88	Place under ceiling .....	384
Objects in 3D Views .....	465	Place under Roof .....	384
Room .....	161	Sloped .....	384
Selected Edge .....	88	Special applications .....	380
Shift+Click .....	89	<b>Space Planning</b> .....	523
Similar Objects .....	88	<b>Spacing</b>	
<b>Select Color Dialog</b> .....	438	Wall Framing .....	431
<b>Selection Fill Color</b> .....	63	<b>Special</b>	
<b>Service Data Tab</b> .....	295	Shaped Cabinets .....	319
<b>Shelf</b> .....	311	<b>Specification Dialogs</b>	
<b>Shelf Tool</b> .....	311	Arc .....	515
<b>Shelf/Partition</b>		Architectural Block .....	390
Specification Dialog .....	328	Bay/Box Window .....	216
<b>Shift Key</b>		Bow Window .....	216
Marquee selection .....	89	Cabinet .....	321
Select multiple objects .....	89	CAD Box .....	520
<b>Shortcut Keys</b> .....	28, 73	CAD Circle .....	517
<b>Show</b>		CAD Ellipse .....	517
Living Area .....	61	CAD Oval .....	517
Reference Grid .....	61	Camera .....	467
<b>Shutters</b> .....	212	Corner Boards .....	303

Custom Backsplash .....	330	<b>Sprinkler</b>	
Custom Countertop .....	329	Designer .....	373
Default Sun Light.....	477	Specification Dialog .....	373
Dimension Line .....	496	Tools .....	373
Door .....	189	<b>Stacked Windows</b> .....	201
Dormer .....	256	<b>Stair</b>	
Electrical Service .....	295	Landing Specification Dialog .....	285
Elevation Line .....	348	Tools .....	260
Elevation Point.....	347	<b>Stair Designer</b> .....	260
Elevation Region .....	348	<b>Stair Landing</b>	
Fireplace.....	239	Specification Dialog .....	285
Hill / Valley .....	349	<b>Stair Landings</b>	
Image .....	532	Custom Shapes .....	267
Library Object .....	411	Height.....	267
Light.....	476	Locked.....	268
Line .....	513	<b>Stair Railing</b>	
Plant Image .....	369	Solid .....	274
Polyline.....	518	<b>Stair Treads</b>	
Quoins.....	304	Automatic.....	279
Raised/Lowered Region.....	349	Depth.....	279
Ramp.....	283	Lock Number.....	279
Rich Text .....	500	Lock Tread Depth .....	279
Road .....	363	Number .....	279
Roof Hole/Skylight.....	252	Overhang.....	281
Room.....	172	Thickness.....	281
Schedule .....	375	<b>Staircase</b>	
Shelf/Partition .....	328	Specification Dialog .....	277
Slab.....	235	<b>Stairs</b>	
Soffit.....	382	Align Curved Stairs.....	112
Sprinkler .....	373	Auto Stairwell .....	275
Stair Landing.....	285	Change Line/Arc.....	265
Staircase .....	277	Click .....	260
Terrain.....	345	Curved.....	260, 262
Terrain Feature .....	350	Curved Treads.....	272
Terrain Path .....	353	Deck to ground.....	263
Text.....	503	Direction .....	262
Wall.....	146	Down .....	263
Wall Hatch .....	157	Edit Handles.....	264
Window.....	205	Editing .....	264
<b>Speed</b>		Flare Radius.....	270
3D View Generation .....	482	Flared .....	269
<b>Splines</b> .....	520	Landings .....	266
<b>Split</b>		Landings, unlocked.....	267
Level Entries .....	224	Large Stringer Base.....	280
Level Floor Plans .....	223	Make Reach .....	278
Walls .....	129	Merge Sections .....	265
<b>Spot Light</b> .....	476		

Newels .....	282
Railings .....	274
Reach Next Floor .....	278
Rooms Below .....	276
Section Width .....	279
Stairwell .....	275
Starter Treads.....	272
Straight .....	260
Stringers.....	280
Subsections.....	278
Symmetrically Flared.....	270
Terminology.....	260
Tread Depth .....	269
Treads.....	278
Wrapped.....	273
<b>Stairwell</b>	
Automatic .....	275
<b>Startup Options</b> .....	22
<b>Status Bar</b> .....	33
Angle style.....	70
<b>Stem Walls</b> .....	228
Align.....	232
and Footings, Align .....	232
<b>Stepped Foundations</b> .....	234
<b>Stepping Stones</b> .....	342
<b>Sticky Mode</b> .....	85
<b>Story-and-a-half</b> .....	142
<b>Straight</b>	
Deck Edge.....	124
Stairs .....	260
<b>Streams</b> .....	341
<b>Structural Member Reporting</b> .....	581
<b>Stud</b>	
Spacing .....	431
<b>Sunlight Toggle</b> .....	454
<b>Swap</b>	
Views .....	444
Work-Reference .....	226
<b>Switch</b>	
Three way .....	293
<b>Symbol</b>	
Surface Normals .....	555
vs. Native Objects .....	410

## T

<b>Tab Key</b> .....	89
<b>Tape Measure</b> .....	490
<b>Technical Support</b> .....	591
Contact .....	595
Error Messages.....	594
Installation Issues .....	592
Online.....	596
Online Articles.....	596
Telephone.....	596
<b>Temporary</b>	
Dimensions .....	490
<b>Temporary Dimensions</b> .....	490
<b>Terrain</b>	
and 3D Draw Time.....	344
Build.....	344
Displaying.....	343
Editing .....	344
Elevation Data Tools .....	335
Feature Tools.....	339
Grow All Plants Dialog.....	366
Hill.....	339
Holes.....	340
Modifier Tools .....	338
Specification Dialog.....	345
Sprinkler Tools .....	373
Valley .....	339
Wall and Curb Tools .....	342
<b>Terrain Data</b>	
Import .....	355
<b>Terrain Feature</b>	
Specification Dialog.....	350
<b>Terrain Features</b>	
Clip.....	350
Height.....	350
<b>Terrain Modeler</b>	
3D Views .....	344
<b>Terrain Path</b>	
Specification Dialog.....	353
<b>Terrain Perimeter</b> .....	333
<b>Text</b>	
Aligning .....	505
Arrows .....	506

Bullets .....	502
Copy, Cut and Paste .....	505
Creating.....	499
Displaying.....	500
Editing .....	504
Layer .....	500
Line Spacing .....	502
Lists .....	502
Move .....	504
Numbering .....	502
Paragraph Options .....	502
Printed Size .....	505
Reshape .....	504
Resize .....	505
Rotate .....	504
Scaling .....	505
Specification Dialog.....	503
<b>Text Style Defaults Dialog</b> .....	508
<b>Text Styles</b> .....	507
<b>Texture</b>	
Filename Conflict Dialog.....	558
Panel.....	434
<b>Textures</b> .....	471
Mapping.....	425
View .....	434
<b>Thumbnails</b> .....	48
Creating.....	48
<b>Tiling Views</b> .....	445
<b>Toolbars</b> .....	28
Drop-Down.....	71
Edit.....	28
Hide .....	71
Parent-Child.....	71
<b>Transom Windows</b> .....	187
<b>Transparency</b>	
Color .....	535

## U

<b>Undo</b> .....	118
Files .....	50
Undo Zoom .....	443
<b>Unrestricted Movement</b> .....	109

## V

<b>Valley</b> .....	339
<b>Vents</b> .....	201
<b>Video Card</b>	
Memory.....	448
OpenGL.....	448
Status .....	68
<b>Videos</b>	
View Online Help Videos.....	588
<b>Views</b>	
Tiling.....	445
<b>Virtual Graph Paper</b> .....	60–61
<b>Visual CAD Snaps</b> .....	60
<b>Volume</b>	
Of a Polyline.....	519

## W

<b>Walkthroughs</b> .....	543
Along a Path .....	544
Codecs .....	547
Create Path.....	544
Key Frames.....	544
Pause Recording .....	546
Playing.....	547
Recording .....	546
Save Frame .....	546
Stop Recording.....	546
<b>Wall</b>	
Assemblies.....	142
Cabinets .....	311
Defaults .....	120
Layer Fill Style .....	145
Specification Dialog .....	146
Tools .....	122
Type Definitions Dialog .....	144
Types Tab.....	150
<b>Wall Hatch</b>	
Specification Dialog .....	157
<b>Wall Type Definitions Dialog</b> .....	144
<b>Walls</b>	
Align between floors .....	139

Align collinear .....	138	Wall Coverings .....	152
Align pony walls .....	121	<b>Water Features</b> .....	341
and Material Painter .....	419	<b>Water Proof Outlet</b> .....	290
Attic Walls .....	141	<b>Winders</b>	
Connecting .....	131	Definition .....	260
Curved .....	131	<b>Window</b>	
Curved, align between floors .....	139	Defaults .....	198
Delete hatching .....	129	Seat .....	214
Display surfaces only .....	132	Specification Dialog .....	205
Drawing .....	130	<b>Windows</b>	
Editing .....	135	Bay and Bow dimensions .....	213
Exterior and Interior .....	125	Bay, Box, Bow .....	213
Fill styles .....	145	Bench Seat .....	214
Fix Connections .....	131	Component .....	214
Flip layers .....	130	Corner .....	200
Footing size .....	150	Gables Over .....	248
Foundation .....	126	Labels .....	203
Foundation thickness .....	150	Library .....	200
Framing Layer .....	142	Match roof .....	209
Full Gable Wall .....	149	Mulled Units .....	201
Grid snapping .....	130	Mullions .....	208
Half .....	155	Muntins .....	208
Half Walls .....	123	Pass-Through .....	199
Hatching .....	129	Shape .....	209
Heights .....	137	Shutters .....	212
Interior, fireplace in .....	238	Special Shapes .....	200
Invisible .....	127	Stacked .....	201
Knee Wall .....	149	Stained glass material .....	201
Layer fill style .....	145	Transom .....	187
Layers .....	142	Trapezoid .....	209
Length .....	138	Treatments .....	211
Main Layer .....	142	Types .....	198
Materials .....	133	Vents .....	201
Move Along Rails .....	137	<b>Windows Metafiles</b> .....	537
No Locate .....	148	<b>Wiring Schematics, Creating</b> .....	292
No Room Def .....	147	<b>Wrapped</b>	
Opening with Railing .....	188	Openings .....	187
Openings in .....	130	Stairs .....	273
Pony Wall .....	126		
Pony wall height .....	121		
Removing Breaks .....	132		
Resizing Using Dimensions .....	495		
Retaining Wall .....	343		
Reverse Layers .....	130		
Show lower pony wall .....	122		
Solid Railings .....	155		
Split .....	126		
Thickness .....	137		

## Z

<b>Zero</b>	
in Dimensions .....	488
<b>Zoom</b> .....	442

Fill Window .....	443	Tools .....	442
Mouse Wheel .....	25, 442	Undo Zoom .....	443